

FR-301

Desoldering Tool

Instruction Manual

Thank you for purchasing the HAKKO FR-301 Desoldering Tool.

Please read this manual before operating the HAKKO FR-301.

Please keep this manual readily accessible for reference.

1. PACKING LIST AND PART NAMES

Please check to make sure that all items listed below are included in the package.

HAKKO FR-301	1	Iron holder	1
Ceramic paper filter (L)	2	Cleaning Pin (for ø1.0mm [0.04 in] nozzle).....	1
Nozzle wrench.....	1	Cleaning Pin (for Heating Element).....	1
Pre-filter	1	Instruction manual (This manual)	1

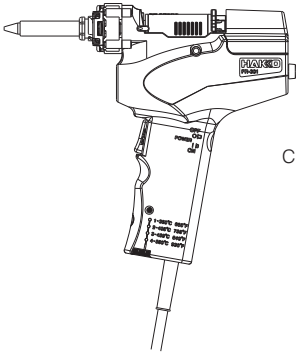

HAKKO FR-301



Ceramic paper filter (L)



Nozzle wrench



Pre-filter

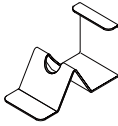

Iron holder



Cleaning Pin
(for ø1.0mm [0.04 in] nozzle)



Cleaning Pin
(for Heating Element)

2. SPECIFICATIONS

Part name	HAKKO FR-301	Nozzle to ground potential	<2 mV
Power supply	100V-98W (50/60Hz), 110V-122W (50/60Hz), 120V-140W (60Hz), 220V-100W (50/60Hz), 230V-110W (50/60Hz), 240V-120W (50/60Hz)	Vacuum generator	Diaphragm pump
		Vacuum pressure	81 kPa (610 mmHg)
		Suction flow	11 L/min
Temperature range	350 to 500 °C (660 to 930 °F)	Dimensions	215 (W) × 226 (H) mm/8.3 × 8.9 in.
Nozzle to ground resistance	<2 Ω	Weight	0.52 kg/1.1 lb. with ø1.0 mm [0.04 in] nozzle

- The temperature was measured using the HAKKO FG-101 Station Tester.
- Specifications and design are subject to change without notice.



99 Washington Street
Melrose, MA 02176
Phone 781-665-1400
Toll Free 1-800-517-8431

Visit us at www.TestEquipmentDepot.com

3. WARNINGS AND CAUTIONS

Warnings and cautions are placed at critical points in this manual to direct the operator's attention to significant items. They are defined as follows:

⚠ WARNING: Failure to comply with a WARNING may result in serious injury or death.

⚠ CAUTION : Failure to comply with a CAUTION may result in injury to the operator, or damage to the items involved.

⚠ WARNING

When power is ON, the nozzle will be hot. To avoid injury or damage to personnel and items in the work area, observe the following:

- Do not touch the nozzle or the metal parts near the nozzle.
- Do not allow the nozzle to come close to, or touch, flammable materials.
- Inform others in the area that the unit is hot and should not be touched.
- Remove the power plug when not in use, or left unattended.
- Turn the power off when connecting the HAKKO FR-301.
- This appliance can be used by children aged from 8 years and above and persons with reduced physical, sensory or mental capabilities or lack of experience and knowledge if they have been given supervision or instruction concerning use of the appliance in safe way and understand the hazards involved.
- Children should be supervised to ensure that they do not play with the appliance.
- Cleaning and user maintenance shall not be made by children without supervision.
- If the power cord is damaged it must be replaced by the manufacturer, its service agent or similarly qualified person in order to avoid personal injury or damage to the unit.

To prevent accidents or damage to the HAKKO FR-301, be sure to observe the following:

⚠ CAUTION

- Do not use the unit for applications other than desoldering.
- Do not strike the handpiece against hard objects to remove excess solder. This will damage the handpiece.
- Do not modify the HAKKO FR-301.
- Use only genuine HAKKO replacement parts.
- Do not allow the HAKKO FR-301 to become wet, or use it when hands are wet.
- Be sure to hold the plug when inserting or removing the handpiece and power cords.
- Be sure the work area is well ventilated. Soldering produces smoke.
- If the pump does not operate, immediately clean the nozzle and heater.
- While using the HAKKO FR-301, don't do anything which may cause bodily harm or physical damage.
- The unit is for counter or workbench use only.

4. PART NAMES

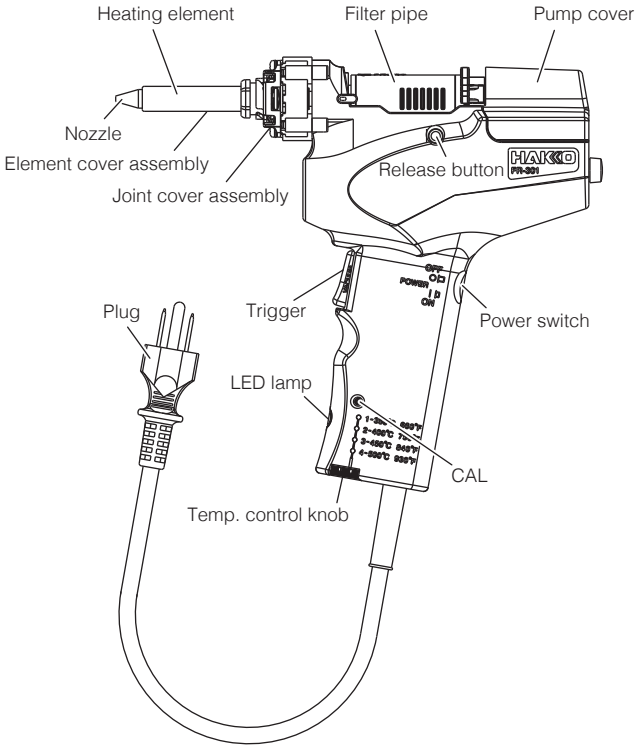

5. OPERATION

⚠ CAUTION

The temperature of the nozzle end differs depending on the type of nozzles.
Calibrate the nozzle temperature by adjusting the CAL to ensure optimal performance.

(1) Preparation

1. Insert the plug of the power cord into an outlet.
2. Turn the power switch ON.
3. Wait for about 1 minute until the nozzle will melt solder, then apply a generous coating of your solder to the end of the nozzle.
 When the iron temperature reaches the set temperature, the LED lamp will flash.

(2) Desoldering

⚠ CAUTION

- If the pump does not operate, immediately clean the nozzle & heating element and replace the filter if necessary.
- Do not remove the pump cover during use.

1. Place the nozzle over the lead wire of the part to be desoldered and begin heating.

Be careful to heat the lead wire and the solder, not the land. Placing the nozzle directly in contact with the land may cause the land to peel off. You may apply a small amount of solder to form a heat bridge to help the heating process.

2. Check to make sure all of the solder on the joint has melted.

With the nozzle still in place over the lead wire, slowly move the lead wire, being careful not to apply too much force. If the lead wire moves easily, all of the solder has melted.

3. Pull the trigger to remove the melted solder.

Make sure that a filter has been inserted in the desoldering tool. Desoldering without a filter may damage the pump.

4. If the solder was not removed, re-solder the part using new solder and then repeat the desoldering process.

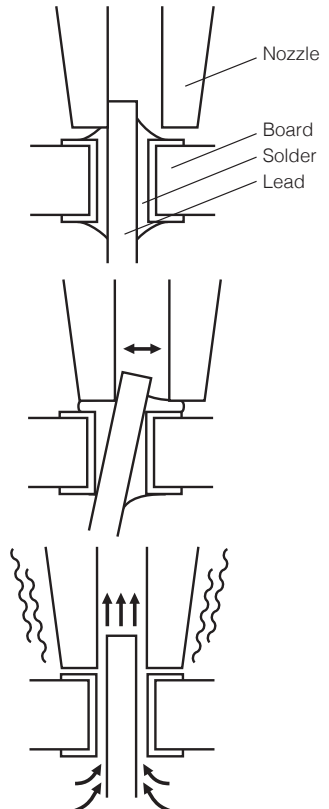

5. OPERATION (Continued)

(3) Cleaning

Cleaning is extremely important and should be done frequently during the desoldering process. Parts should be checked periodically for wear and should be replaced if necessary. See the MAINTENANCE section of these instructions.

- Clean the nozzle as you would clean a soldering tip: wipe away any excess solder with a sponge moistened with de-ionized or distilled water, or using a wire tip cleaner. Before putting the desoldering tool away, apply a new coat of solder on the tip.
- Using a cleaning pin that matches the diameter of the nozzle, clean the inside of the nozzle opening. This must be done while the nozzle and heating core are still hot, so be careful.
- Discard any solder that has collected in the filter pipe. Do this carefully, as the solder will still be extremely hot.
- Replace the filter. See the MAINTENANCE section of these instructions.

The ceramic paper filter (L) should be replaced immediately when a stain appears or vacuum decreases. Failure to do this will reduce the performance of the pump and may damage it.

• Cleaning with cleaning pin

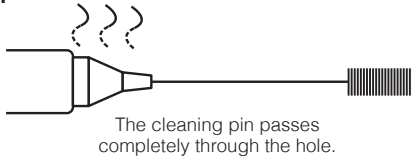

• Cleaning with cleaning drill

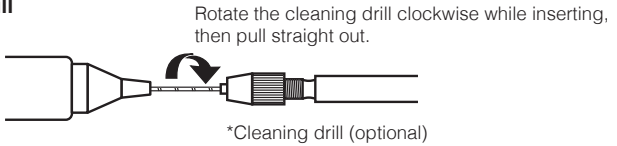

• Clean the heating core

Scrape away all oxidation from the hole in the heating element until the cleaning pin passes cleanly through the hole.

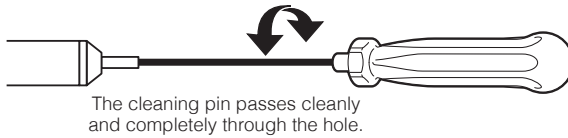

(4) Temperature setting

The temperature of the HAKKO FR-301 can be adjusted between 350 - 500 °C/660 - 930 °F. Set the temperature in accordance with the requirements of the job being done. Although the temperature needed for desoldering cannot be determined merely by the type of board to be desoldered, the values in the table below may be used as a general guide.

⚠ CAUTION	
Change the temperature only with the temp. control knob.	
Do not use the "CAL" trim pot.	
Type of board	Approximate setting (on scale)
Single-sided P.W.B.	1
Through-hole P.W.B.	2
Multilayer P.W.B.	3 to 4

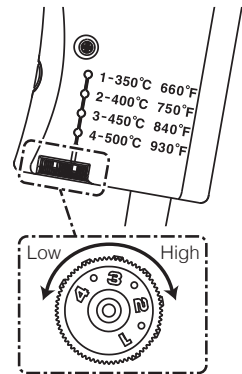

- In general, the greater the temperature, the more quickly the nozzle will oxidize and wear out.
- As nozzle oxidation and wear increases, the nozzle temperature will decrease. In such cases, increasing the set temperature will only accelerate oxidation and hasten wear. Replace worn nozzles as soon as possible.

6. MAINTENANCE

The frequency of cleaning and part replacement greatly depends on a variety of factors, including the temperature at which the desoldering tool is operated, and the types of solder and flux used. Using the table below as a general guide, clean and replace parts in accordance with use conditions.

Maintenance	
During use	Clean nozzle
	Discard solder that has collected
	Clean nozzle and heating core
When necessary	Replace parts
Periodically	Clean pump

6. MAINTENANCE (Continued)

(1) A general guide to replacement part

Use the table below as a general guide to replacement part. Use only genuine HAKKO FR-301 replacement parts as the use of other parts may impair performance, or cause damage or injury.

Part Name	Signs that replacement is needed
Pre-filter	Cannot hold solder
	Warping
Ceramic paper filter (L)	Hardened by flux staining
Front holder	Hardening has reduced air tightness
Nozzle	Repels solder
	Solder plating on tip is gone
	Clogging
	Hole has corroded and is larger
	Temperature is low
Heating core (in heater)	Clogged
	Normal heater resistance value: 35 Ω (100 - 120 V models) 160 Ω (220 - 240 V models)
Valve	Cracking
Diaphragm	Tearing
Inner hose	Hose is clogged with flux
	Hose has hardened and is no longer flexible
	Tearing

(2) Replacing parts

• Nozzle

NOTE: Be careful since the areas around the nozzle and heating element are very hot.

1. Remove the element cover and the nozzle with the included nozzle wrench.

Nozzle



The element cover assembly is held to the nozzle wrench by pressing this part from both sides. (The nozzle is not held to the nozzle wrench.)

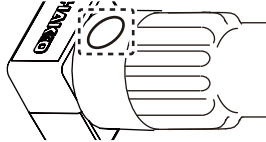

• Filter Pipe and related parts

Be careful since the area around the filter pipe is extremely hot.

1. Pull the rear holder back until it clicks (locks into place) and remove the filter pipe.

Filter Pipe and related parts

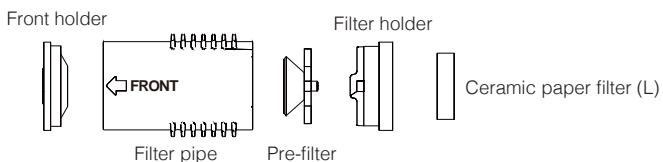
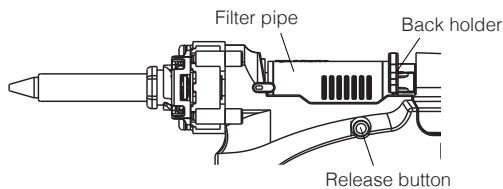

2. Inspect the filter and holders and replace as needed.
3. During assembly, be sure to insert the filter. Failure to do so may damage the unit. After the parts have been assembled, place the filter pipe assembly into position and push the release button. The back holder will spring forward and secure the filter pipe while creating a vacuum seal.

6. MAINTENANCE (Continued)

• Pump

Turn off the tool, remove the power plug from the power outlet and wait until the unit has cooled completely.

1. Loosen the screws on the back of the pump cover and remove the pump cover.
2. Remove the fixing plate.

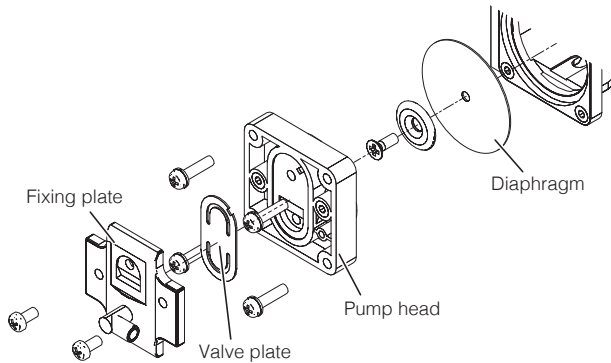

3. Clean the valve plate, fixing plate and pump head with isopropyl alcohol.
Align the notch on the pump head with the corresponding notch on the valve plate.
Match the notch on the outside of the pump head with the one on the fixing plate.
Mount the diaphragm so that it is smooth and taut.

• Replacing the heating element (heating core)

Turn off the tool, remove the power plug from the outlet and wait until the unit has cooled completely.

1. Remove the nozzle and element cover assembly with the nozzle changing tool and remove the joint cover.

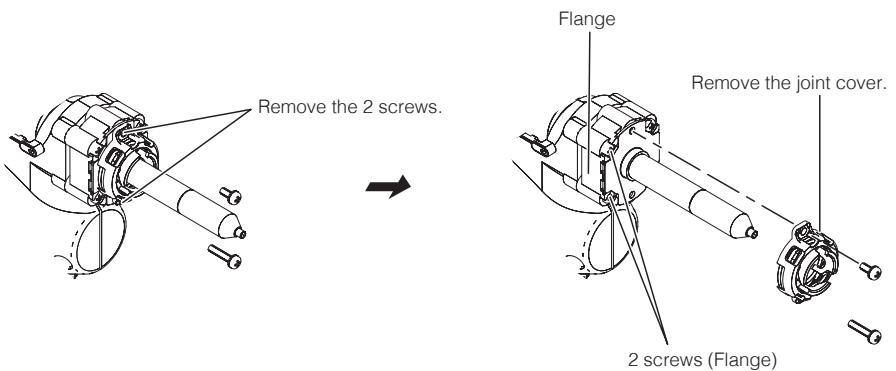

2. Loosen the screw at the back of the pump cover and remove the pump cover.
3. Remove the 6 screws from the handpiece (including 2 screws at the flange) and carefully separate the housing.
4. Disconnect the heating element terminal and replace the heating element.
5. Assemble using the same procedure in reverse.
6. Calibrate the nozzle temperature.

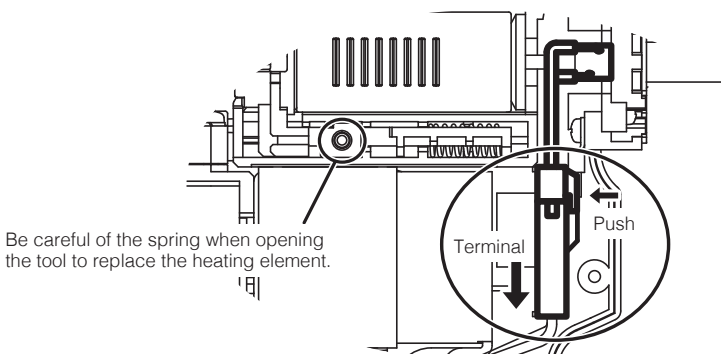

Be sure to calibrate the nozzle temperature after replacing the heating element. Failure to do this may result in a heater temperature that is much higher or lower than the previous one, and can contribute to accelerated oxidation and/or wear of the nozzle, or premature failure of the heating element.

7. TROUBLESHOOTING

Calibrating the temperature

1. Install a new nozzle. The nozzle being used may have already started to wear, so use a new nozzle.
2. Insert the power plug into the outlet.
3. Set the temperature to 400 °C/750 °F.
4. Wait for about 1 minute until the nozzle will melt solder, then apply a generous coating of your solder to the end of the nozzle. When the iron temperature reaches the set temperature, the LED lamp will flash.
5. Use a soldering iron tip thermometer (optional accessory) to measure the temperature at the tip of the nozzle. Do not apply suction, as this will cause the temperature to drop.
6. Adjust CAL until the temperature is 400 °C/750 °F. Turn CAL clockwise to increase the temperature.
 - It may take several minutes for the nozzle temperature to stabilize after CAL is adjusted.
 - During CAL adjustment, make sure the set temperature does not go above 500°C/930°F, as this may damage the desoldering tool.

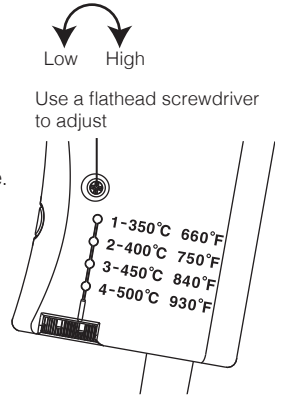

	Problem cause	Procedure
Tool does not heat up	Tool is not connected properly to power outlet	Connect properly
	Heating element burnout*	Replace heating element
	Sensor is broken*	
Temperature is low	Temperature is set too low	Reset
	Temperature has not been calibrated properly	Calibrate properly
	Nozzle is worn out	Replace nozzle
Pump does not operate	Nozzle or heating core (in heating element) is clogged	Clean
	Too much solder or flux has collected in the filter	Replace filter
Suction force is weak	Too much solder or flux has collected in the filter or inner hose	Replace filter or inner hose
	Vacuum leakage	Inspect nozzle, area around filter and pump hose
	Pump valve or diaphragm is broken	Replace valve or diaphragm

*Heater lead (Sensor lead)

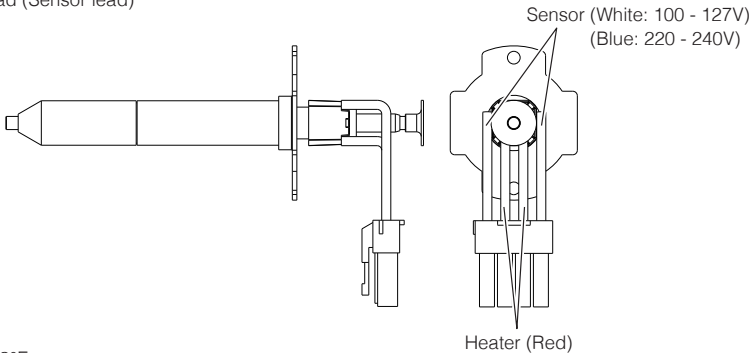

*At 23°C/73°F,

Normal heater resistance value: 35 Ω (100 - 127 V models) 160 Ω (220 - 240 V models)

Normal sensor resistance value: 50 Ω (100 - 127 V, 220 - 240 V models)

NOTE:

Use of the tool when the nozzle, heating core, or filter is clogged may cause the pump to lock up and render operation impossible. Clean or otherwise eliminate the blockage before attempting to use the tool.

Repairs

When repair becomes necessary, check the following and then bring the desoldering tool to a HAKKO sales outlet or HAKKO dealer.

1. Is the nozzle or heating core clogged?
2. Is the valve plate cracked or missing?
3. Is the front holder or filter holder warped or cracked?
4. Is the pre-filter or ceramic paper filter dirty or warped?

Detailed information can be found in manuals available at the HAKKO Document Portal.

Please download and make use of them.



<https://doc.hakko.com>

8. REPLACEMENT PARTS/OPTION

Item No.	Part No.	Part Name	Specifications
(1)	A5046	Heating element	100V-110V
	A5047		120V
	A5048		127V
	A5049		220V-240V
(2)	B5063	Movable joint	
(3)	B5064	Wave spring	
(4)	B5062	Joint cover	
(5)		Nozzle	See section "■ NOZZLE STYLES" on the next page.
(6)	B5193	Element cover	

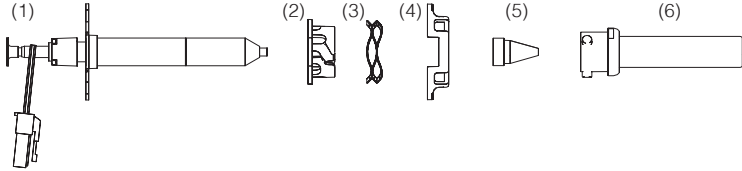

Item No.	Part No.	Part Name	Specifications
(1)	A5044	Ceramic paper filter (L)	10 pcs.
(2)	B5104	Pre-filter (ALUM)	
(3)	B5194	Filter pipe	
(4)	A5030	Front holder	
(5)	B5195	Back holder	

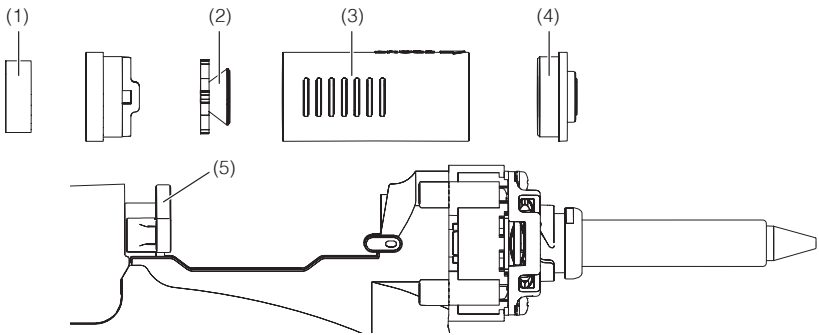

Part No.	Part Name	Specifications
B1085	Cleaning pin	For heating element
B2874		For $\varnothing 0.6$ mm (0.02 in.) nozzle
B1086		For $\varnothing 0.8$ mm (0.03 in.) nozzle
B1087		For $\varnothing 1.0$ mm (0.04 in.) nozzle
B1088		For $\varnothing 1.3$ mm (0.05 in.) nozzle
B1089		For $\varnothing 1.6$ mm (0.06 in.) nozzle
B5141	Cleaning drill	For $\varnothing 0.6$ mm (0.02 in.) nozzle
B1302		For $\varnothing 0.8$ mm (0.03 in.) nozzle
B1303		For $\varnothing 1.0$ mm (0.04 in.) nozzle
B1304		For $\varnothing 1.3$ mm (0.05 in.) nozzle
B1305		For $\varnothing 1.6$ mm (0.06 in.) nozzle
B5142	Drill holder	For $\varnothing 0.6$ mm (0.02 in.) nozzle
B1306		For $\varnothing 0.8$ mm (0.03 in.)/1.0 mm (0.04 in.) nozzle
B1307		For $\varnothing 1.3$ mm (0.05 in.)/1.6 mm (0.06 in.) nozzle
B5143	Drill bit	For $\varnothing 0.6$ mm (0.02 in.) nozzle (set of 10)
B1308		For $\varnothing 0.8$ mm (0.03 in.) nozzle (set of 10)
B1309		For $\varnothing 1.0$ mm (0.04 in.) nozzle (set of 10)
B1310		For $\varnothing 1.3$ mm (0.05 in.) nozzle (set of 10)
B1311		For $\varnothing 1.6$ mm (0.06 in.) nozzle (set of 10)
B1356	Adapter	
B5015	Nozzle changing tool	
C5000	Carrying case	
C5003	Iron holder	Simple type
C1100	Iron holder	Optional
A1042	Cleaning sponge	

8. REPLACEMENT PARTS/OPTION (Continued)

■ NOZZLE STYLES

N61-01

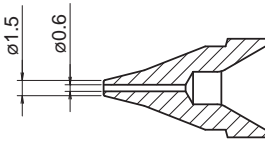

N61-02

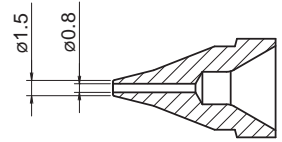

N61-03

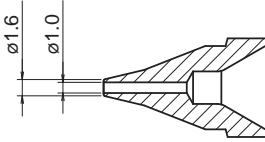

N61-04

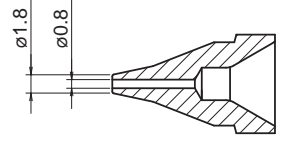

N61-05

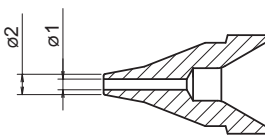

N61-06

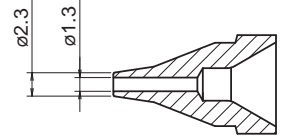

N61-07

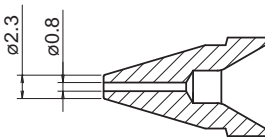

N61-08

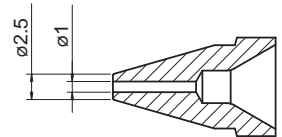

N61-09

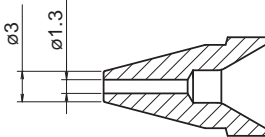

N61-10

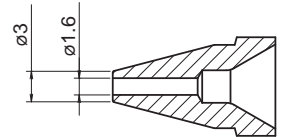

N61-11

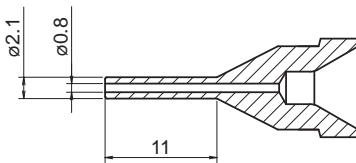

N61-12

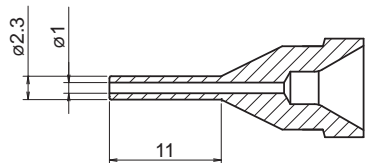

N61-13

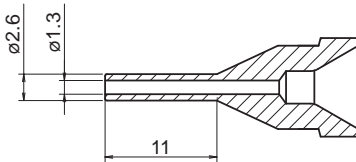

N61-14

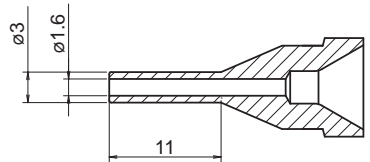

N61-15

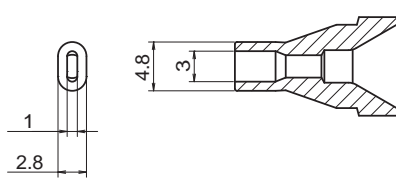

N61-16

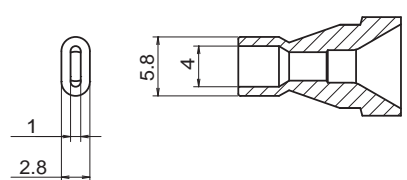

8. REPLACEMENT PARTS/OPTION (Continued)

Item No.	Part No.	Part Name	Specifications
(1)	B5197	Cover	With screw
(2)	B5018	Inner hose	
(3)	B5185	Filter pipe assembly	
(4)	B5198	Flange	With screws
(5)	B5201	Power switch	
(6)	B5021	Housing	With screws
(7)	B5025	Power cord, 3-wire cord & American plug	
	B5026	Power cord, 3-wire cord & Chinese plug	
	B5027	Power cord, 3-wire cord but no plug	
	B5028	Power cord, 3-wire cord & European plug	
	B5029	Power cord, 3-wire cord & SI plug	
	B5030	Power cord, 3-wire cord & BS plug	
	B5031	Power cord, 3-wire cord & Australian plug	
	B5033	Power cord, 3-wire cord & American plug (U)	
B5034	Power cord, 3-wire cord & BS plug CE		
(8)	B5022	Trigger	
(9)	B5200	Micro switch	
(10)	B5199	Insulation plate	
(11)	B5188	P.W.B.	100-110V
	B5189		120V
	B5190		127V
	B5191		220-230V
	B5192		240V

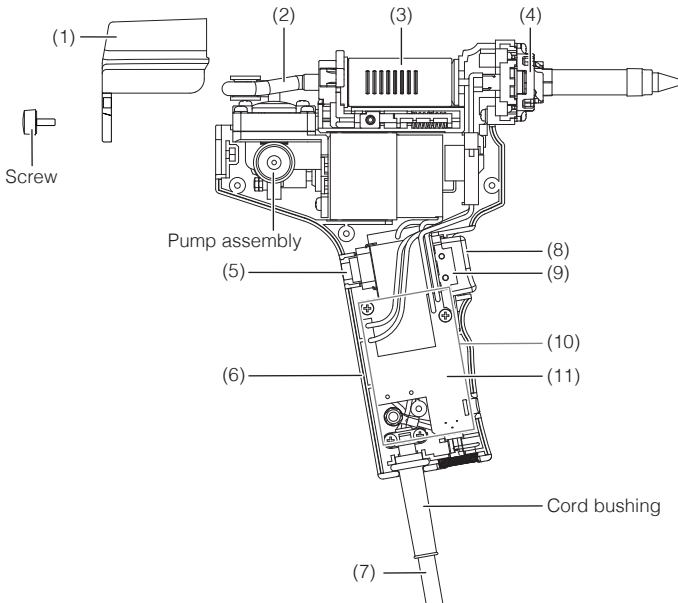

Item No.	Part No.	Part Name	Specifications
(1)	B5023	Valve plate	
(2)	B5202	Pump head	
(3)	B5024	Diaphragm	

