

HIOKI

FT3424 LUX METER

Instruction Manual



99 Washington Street
Melrose, MA 02176
Phone 781-665-1400
Toll Free 1-800-517-8431



Visit us at www.TestEquipmentDepot.com

Contents

Introduction.....	1
Verifying Package Contents	2
Options (sold separately)	3
Safety Notes.....	4
Usage Notes.....	7

1 Overview 11

1.1 Overview and Features.....	11
1.2 Parts Names and Functions.....	12
1.3 LCD Display	16

2 Measurement Methods 19

2.1 Measurement Workflow	19
2.2 Inserting/Replacing Batteries	20
2.3 Attaching the strap	22
2.4 Inspection Before Use	24
2.5 Making Measurements.....	25
2.6 Selecting the Measurement Range.....	29

3 Applied Functionality 31

3.1 Retaining the Measured Value after a Set Amount of Time (Timer Hold Function).....	31
Retaining the measured value (TIMER)	31
3.2 Disconnecting the Display Unit and Sensor Unit	33
Mounting the sensor unit on a tripod	34
3.3 Limiting Battery Consumption (Auto Power Off Function)	35

3.4	Saving Measured Values (Memory Function)	36
	Saving the measured value (MEM)	36
	Reading the measured memory data (READ)	37
	Deleting the most recently saved measured value (CLEAR).....	38
	Clearing all the saved measurement data	38
3.5	Logging Illuminance Data (Output Function)	39
3.6	Communicating with PC	41
3.7	Disabling the buzzer	42
3.8	Turning On the Backlight	43

4 Specifications 45

4.1	Basic Specifications	45
4.2	Measurement Specifications	46
	Accuracy	46
	Characteristic.....	47
4.3	Output Specifications	48
4.4	Functional Specifications	48
4.5	General Specifications	49

5 Maintenance and Service 51

5.1	Repair, Inspection, and Cleaning	51
5.2	Troubleshooting	52
5.3	Error Display	54
5.4	Display Messages	55

Appendix**Appx.1**

Appx. 1 Recommended Levels of Illumination (Reference).....	Appx.1
Appx. 2 Sensor Characteristics Graphs.....	Appx.3
Relative Spectral Response Characteristics in the Visible Spectrum.....	Appx.3
Angled Incident Light Characteristics	Appx.4
Appx. 3 Other Characteristics	Appx.5
Appx. 4 Dimensional drawing.....	Appx.6

Introduction

Thank you for purchasing the HIOKI FT3424 Lux Meter. To obtain maximum performance from the product, please read this manual first, and keep it handy for future reference.

Verifying Package Contents

When you receive the instrument, inspect it carefully to ensure that no damage occurred during shipping.

In particular, check the accessories, operation keys of the panel, and connectors. If damage is evident, or if it fails to operate according to the specifications, contact your authorized Hioki distributor or reseller.

Check the package contents as follows.

FT3424



LR6 Alkaline battery × 2



Carrying Case (soft)



Strap (for instrument) (p.22)



Sensor cap (with strap) (p.25)

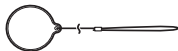

Instruction manual



CD* (USB driver, dedicated computer application software, and communications specifications)



USB Cable (Length: 0.9 m)



* The latest version can be downloaded from our web site.

Options (sold separately)

The following options are available for the instrument.
Contact your authorized Hioki distributor or reseller when ordering.

Connecting cable/Output cord

Use when positioning the sensor unit and display unit separately during use.

L9820 Connection Cable

(Length: 2 m)

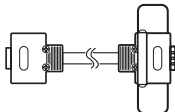

Required when using the instrument's output functionality.

9094 Output Cord

(Length: 1.5 m)

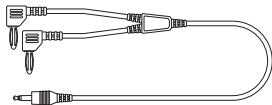

Carrying Case

Handy for storing the instrument with the L9820 Connection cable, 9094 Output cord, and USB cable.

C0201 Carrying Case

(semi-hard)



L9820 Connection Cable cannot be stored.

C0202 Carrying Case

(soft)



Safety Notes

This instrument is designed to conform to IEC 61010 Safety Standards, and has been thoroughly tested for safety prior to shipment. However, using the instrument in a way not described in this manual may negate the provided safety features.

Before using the instrument, be certain to carefully read the following safety notes.





CAUTION



- Mishandling during use could lead to damage to the instrument. Be certain that you understand the instructions and precautions in the manual before use.
- If persons unfamiliar with electricity measuring instrument, another person familiar with such instruments must supervise operations.

Notation

In this manual, the risk seriousness and the hazard levels are classified as follows.

 WARNING	Indicates a potentially hazardous situation that may result in death or serious injury to the operator.
 CAUTION	Indicates a potentially hazardous situation that may result in minor or moderate injury to the operator or damage to the instrument or malfunction.
IMPORTANT	Indicates information related to the operation of the instrument or maintenance tasks with which the operators must be fully familiar.
	Indicates the prohibited action.
	Indicates the action which must be performed.

*

Additional information is presented below.

Symbols affixed to the instrument



Indicates cautions and hazards. When the symbol is printed on the instrument, refer to a corresponding topic in the Instruction Manual.



Indicates DC (Direct Current).

Symbols for various standards



Indicates the Waste Electrical and Electronic Equipment Directive (WEEE Directive) in EU member states.



Indicates that the instrument conforms to regulations set out by the EC Directive.

Screen display

The screen of this instrument displays characters in the following manner.

A	B	C	D	E	F	G	H	I	J	K	L	M	N	O	P	Q	R	S	T	U	V	W	X	Y	Z
A	b	C	d	E	F	G	H	I	J	K	L	M	N	O	P	Q	R	S	T	U	V	W	X	Y	Z

1	2	3	4	5	6	7	8	9	0
1	2	3	4	5	6	7	8	9	0

A different display is used in the case below.

b. Lo

Displays when power is shutdown (p.18)



Displays when display unit and sensor unit is not connected.

Accuracy

We define measurement tolerances in terms of f.s. (full scale), rdg. (reading) and dgt. (digit) values, with the following meanings:

f.s.	(Maximum display value) Indicates the maximum displayable value. This is usually the name of the currently selected range.
rdg.	(Reading value) The value currently being measured and displayed on the measuring instrument.
dgt.	(Resolution) The minimum display unit, indicating a minimum digit of 1.

Usage Notes

Follow these precautions to ensure safe operation and to obtain the full benefits of the various functions.

Before Use

Verify that the instrument operates normally to ensure that no damage occurred during storage or shipping. If you find any damage, contact your authorized Hioki distributor or reseller.

Installation

For details on the operating temperature and humidity, see the specifications.(p.49)

WARNING

Installing the instrument in inappropriate locations may cause a malfunction of instrument or may give rise to an accident. Avoid the following locations.



- Exposed to high temperature
- Exposed to corrosive or combustible gases
- Exposed to water, oil, chemicals, or solvents
- Exposed to high humidity or condensation
- Exposed to high quantities of dust particles
- Susceptible to vibration

When the instrument is not in use, store the instrument in a cool, dark place because optical components are vulnerable to heat.

Handling the cables and cords

CAUTION



- Before use, verify that the insulation on cables and cords is not damaged and that no metal is exposed. If you find any damage, replace the cable or cord with those specified by our company, as the instrument will not be able to make accurate measurements or send/receive data otherwise.



- Avoid stepping on or pinching the cables and cords, which could damage the cable insulation.
- To avoid breaking the base of connectors and jacks, do not bend or pull them.
- Cables and cords become stiff and rigid at temperatures of 0°C and lower. Exercise caution in such environments as bending or pulling on cables and cords may damage their insulation or cause them to break.

Handling the instrument

CAUTION



- The instrument consists of a sensor unit and a display unit that can be positioned apart from one another during operation. To avoid damage, be sure to turn off the instrument before disconnecting or connecting the sensor and display units.



- To avoid damage to the instrument, protect it from physical shock when transporting and handling. Be especially careful to avoid physical shock from dropping.
- To avoid damage to the instrument, do not short-circuit the D/A OUTPUT terminal and do not input voltage to the D/A OUTPUT terminal.

IMPORTANT

- Use only the specified connection cables. Using a non-specified cable may result in incorrect measurements due to poor connection or other reasons.
- When measuring illuminance underneath a standard lighting fixture, the display may not stabilize. In most cases, a failure to stabilize is due to fluctuations in the lighting fixture's supply voltage or to the surrounding environment (for example, a person's shadow). Exercise care concerning these factors when performing measurement.
- The LCD display includes a backlight for use when making measurements in dim locations. The backlight will activate automatically when the measured value is retained or when the measured value data stored in the internal memory is in read mode, both in low-light environments (approx. 750 lx or less). To avoid affecting measurement results, the backlight cannot be turned on during measurement.
- The instrument's measurement reference level (**REF.LEVEL**) is the colored part in the drawing below.

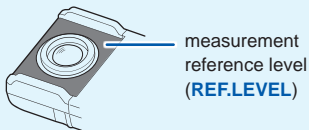

- Do not attempt to disassemble the instrument or subject it to mechanical shock.

CD disc precautions

- Exercise care to keep the recorded side of discs free of dirt and scratches. When writing text on a disc's label, use a pen or marker with a soft tip.
- Keep discs inside a protective case and do not expose to direct sunlight, high temperature, or high humidity.
- Hioki is not liable for any issues your computer system experiences in the course of using this disc.

Precautions during shipment

Observe the following during shipment. Hioki cannot be responsible for damage that occurs during shipment.

CAUTION



- Handle the instrument carefully so that it is not damaged due to a vibration or shock.
- To avoid damage to the instrument, remove the accessories and optional equipment from the instrument before shipment.

If the instrument is not to be used for an extended period of time

IMPORTANT

To avoid corrosion and/or damage to the instrument due to battery leakage, remove the battery and store the instrument in a cool, dark place if it will not be used for an extended period of time.

1

Overview

1.1 Overview and Features

The FT3424 is a multifunctional, high-precision lux meter which ensures durability.

Engineered for use in a wide range of fields and settings, including with lighting equipment, in lighting work, and in equipment management.

Wide-range illuminance measurement (0.00 lx to 200000 lx)

Use the display unit and sensor unit separately

L9820 Connection cable (option)

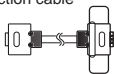

Large, easy-to-read LCD display

Backlight automatically turns on when you retain the measured value in a low-illuminance environment.

Retaining the measurement (HOLD)

Features the timer hold function.

Sensor unit

Features a luminosity filter designed to approximate the response of the human eye with the instrument's sensitivity to wavelength.

Ability to send data to a computer and to be controlled by a computer

Use the included dedicated computer application (after connecting the instrument with a USB cable) to download data and control the instrument.



Memorizes measured value

Internal memory can store up to 99 measured values, which can be sent together to a computer.

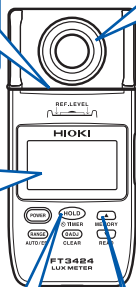

1.2 Parts Names and Functions



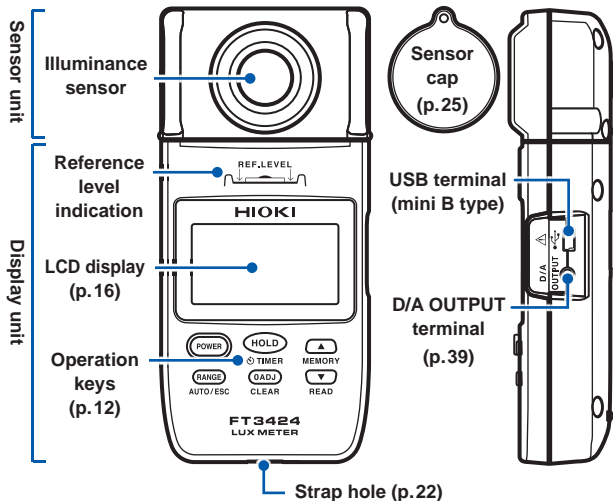

Front/Right Side



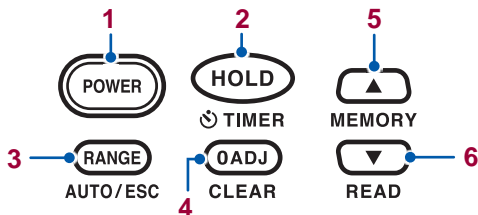

Lux meter could be separated into sensor unit and display unit. (p. 33)
 (Use the option L9820 Connection cable)



Operation keys



		Normal	Press and hold for at least 1 second	Turn on the instrument while pressing and holding
1		Power ON	Power OFF	-
2		Retains the measured value or cancels retention of the measured value.	Start timer hold function (p.31) Automatically retain after 5 to 60 seconds (designating the time is possible)	Cancels the auto power off function (APS). (p.35)
3		<ul style="list-style-type: none"> Switches the range. (p.29) Cancels read mode, which allows you to view the measured values stored in the internal memory. *1 (p.37) 	Switches to auto range.	Displays the software version of the instrument.
4		Performs zero-adjustment.	<ul style="list-style-type: none"> Allows you to delete the last saved measured value.*1 (p.38) Cancels zero adjustment when [CAP] is displayed. 	Places the instrument in the state that enables all measured values stored in the internal memory to be deleted. (p.38)

	Normal	Press and hold for at least 1 second	Turn on the instrument while pressing and holding
5  MEMORY	<ul style="list-style-type: none"> • Save measured value in internal memory. (p.36) • Increases the memory No.^{*1,*2} • Increases the time remaining on the timer.^{*3} 	Continuously increases the memory No. ^{*1} (p.37)	All LCDs light up.
6  READ	<ul style="list-style-type: none"> • Decreases the memory No.^{*1,*2} • Decreases the time remaining on the timer.^{*3} 	<ul style="list-style-type: none"> • Loads measured values stored in the internal memory for viewing. (p.37) • Continuously decreases the memory No.^{*1} (p.37) 	Sets the buzzer sound non-activated. (p.42)

*1: Read mode, which allows you to view the measured values stored in the internal memory.

*2: The  and  can only be operated when there are multiple measured values stored in the internal memory.

*3: During operation of timer hold function.

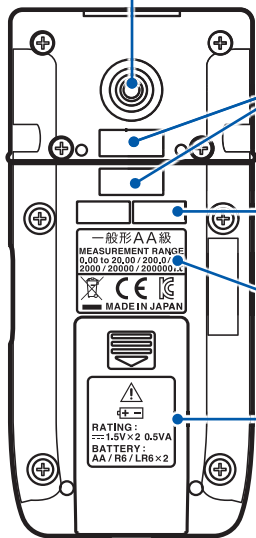
**Tripod mounting thread**

Use when mounting the sensor unit on a tripod. The hole is located exactly behind the center point of the illuminance sensor on the front of the sensor unit. (p.34)

Collation No.

Verify that the collation numbers on the sensor unit and display unit match before use.

Serial No.

It is necessary for production control such as product warranty. Do not peel off the label.

Measurement range

The measurement range of the instrument is noted.

Battery Cover

When replacing the batteries (p.20), remove the cover. Explains which battery to use.

⚠ See p.20

1.3 LCD Display

For message displays and error displays, see “5.3 Error Display” (p.54), and “5.4 Display Messages” (p.55).

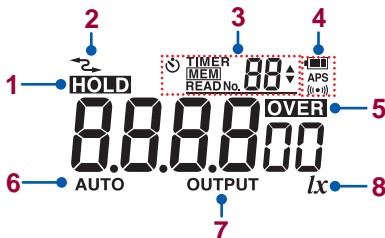

1	HOLD	Holds measured value. (p.26, p.31)
2		Communicating with the USB. (p.41)
	MEM	The memory function is activated. (p.36)
	MEM READ No. 5	Instrument is in read mode, allows viewing measured values stored in its internal memory. (p.37), Memory No.
3	TIMER 5	The timer hold function is activated. (p.31) The time shown is the time remaining (in seconds) until the measured value is retained.
		/ can be operated. (These keys are used to load measured values and set the timer remaining time.)
		Battery indicator (p.17)
4	APS	The auto power off function is activated. (p.35)
		The buzzer sound is activated. (p.42)
5	OVER	The measured value exceeded the set range's maximum illuminance range.





6	AUTO	Auto range is activated. (p.29)
7	OUTPUT	The output function has been activated. (p.39)
8	<i>lx</i>	Represents the unit used to measure illuminance (lux).

When the measured value exceeds the maximum value in each range



The maximum displayable value blinks, and **OVER** lights up on the LCD display.

Battery indicator

	Fully charged.
	As the battery charge diminishes, black charge bars disappear, one by one, from the left of the battery indicator.
	The battery is almost out of charge. Have a new battery handy.
	(Lights up) The battery is exhausted. Replace with new batteries immediately. (p.20) (Blinks) The battery is exhausted. Replace with new batteries immediately. If you keep using the instrument, the power may shutdown. (p.20)
OFF	During USB communications and while the instrument is connected to USB bus power, the battery indicator turns off.

The battery charge indicator is only a reference for the continuous operation time.

When using a manganese battery or nickel-hydride battery, the battery indicator may not operate properly.

Power shutdown



When the charge is gone, **[b. Lo]** blinks in the display for 3 seconds and the power is shut down automatically.

2

Measurement Methods

2.1 Measurement Workflow

Before using the instrument, be sure to read “Usage Notes” (p.7).

Installation and connection

Insert the batteries with the sensor cap on.
(p.20)

As necessary, have other optional items available and ready.

Perform the startup check. (p.24)

Measurement

Turn on the power and perform zero-adjustment.

Remove the sensor cap and start the measurement.

(As necessary)
Hold the (display of the) measured value.
Save the measurement data in the internal memory. (p.36)

End of the measurement

Turn the power off and put the sensor cap on.

2.2 Inserting/Replacing Batteries

Before using the instrument first time, insert two LR6 alkaline batteries. Before measurements, check that the battery level is sufficient. When the battery charge is low, replace the batteries.

Nickel-metal hydride batteries

Nickel-metal hydride batteries can be used. However, the discharge characteristic of these batteries is different from that of alkaline batteries. Be aware that the remaining battery power display does not function properly.

WARNING



- To avoid the possibility of explosion, do not short circuit, charge, disassemble, or incinerate batteries.



- To avoid electric shock, disconnect the output cord and USB cable from the object to be measured before replacing the batteries.
- After battery replacement but before using the instrument, reattach and screw down the battery cover.

CAUTION



Poor performance or damage from battery leakage could result. Observe the cautions listed below.





- Do not mix new and old batteries, or different types of batteries.
- Be careful to observe the battery polarity during installation.
- Do not use batteries after their recommended expiry date.
- Do not allow used batteries to remain in the instrument.

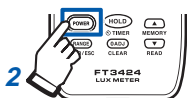

To avoid corrosion from battery leakage and/or damage to the instrument, remove the batteries from the instrument if it is to be kept in storage for an extended period.

- The  indicator appears when the battery is almost out of charge. Have a new battery handy.
- When the  indicator lights up continuously or flashes, there is no battery life remaining. Replace the battery immediately.
- During USB communications and while the instrument is connected to USB bus power, the battery indicator turns off.
- Turn off the power before replacing the batteries.
- After use, be sure to turn off the instrument.
- Handle and dispose of batteries in accordance with local regulations.



Press  for at least 1 second to turn off the instrument.

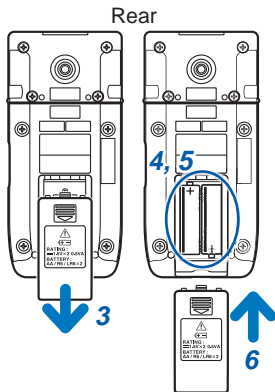

1 Have the following items available and ready.

- LR6 Alkaline battery x 2

2 Turn off the instrument.

3 Remove the battery cover.

4 Remove all of the old batteries.

5 Insert two new batteries (LR6), being careful to the battery polarity.

6 Reattach the battery cover.

Although you can use an R6 Manganese battery, doing so will give the instrument a shorter continuous operating time than an alkaline battery.

2.3 Attaching the strap

You can attach the included strap (for instrument) and the strap for the sensor cap to the strap hole on the bottom of the display unit.

CAUTION



Attach the strap securely to the instrument. If insecurely attached, the instrument may fall and be damaged when carrying.

When attaching one strap

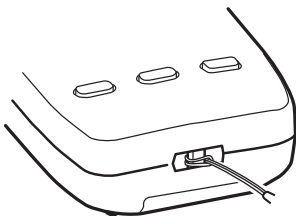

When attaching both straps

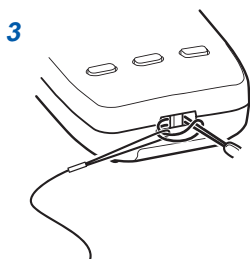
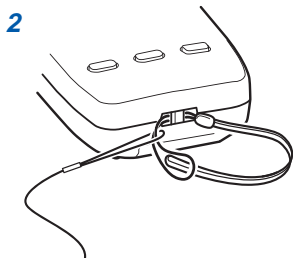
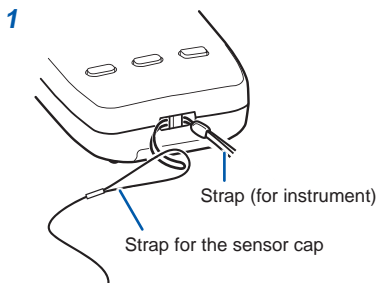

2.4 Inspection Before Use

Verify that the instrument operates normally to ensure that no damage occurred during storage or shipping. If you find any damage, contact your authorized Hioki distributor or reseller.

Appearance check of the instrument

Check item	Action
<ul style="list-style-type: none"> The instrument is neither damaged nor cracked. The internal circuits are not exposed. 	Visually check the instrument. If it is damaged, it could not be measured accurately. Do not use the instrument but send it for repair.

Check when turning on the power

Check item	Action
The battery voltage is sufficient.	When the  indicator appears in the top right corner of the LCD display, replace with new batteries immediately. If you keep using the instrument, the power may shutdown. (p.20)
No indicators are missing.	Display all indicators and ensure that no indicators are missing. (p. 14, p. 16) If any of the indicators are missing, send the instrument for repair.

2.5 Making Measurements

Put the sensor cap on.

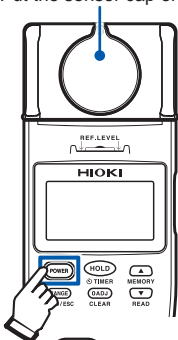

Press **POWER** to turn on the instrument.

- 1 Turn on the instrument with the included sensor cap attached to the illuminance sensor.

A value will be displayed on the LCD display.



- 2 Press **[ADJ]**.

[ADJ] is displayed, and zero-adjustment of all ranges will be performed. When zero-adjustment is completed, **[ADJ]** goes off.



- 3 Remove the sensor cap, and bring the sensor unit near the measuring location.

(To use a particular range to make a measurement)

4 Press  to select the range.

See: “2.6 Selecting the Measurement Range” (p.29)

5 Read the measured value when it stabilizes.

(When retaining the measured value)

Press  and read the measured value.

Pressing  again will cancel retention of the measured value.

You can also retain the measured value after a set amount of time elapses.

See: “3.1 Retaining the Measured Value after a Set Amount of Time (Timer Hold Function)” (p.31)

Put the sensor cap on.

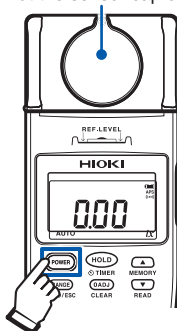

- 6 When the measurement is finished, put the sensor cap on and turn off the instrument.

Press  and hold for at least 1 second to turn off the instrument.

- **OVER** is displayed when the measuring range is exceeded.
- If zero-adjustment is performed immediately after the instrument is turned on, several count digits may remain. In that case, perform zero-adjustment again.
- While the measured value is retained, zero-adjustment can not be performed.

If **0ADJ** is pressed without the sensor cap attached



If you press **0ADJ** without the included sensor cap attached to the illuminance sensor (when the count is equivalent to 1 lx or greater), **[CAP]** will be displayed on the LCD display.

Press **0ADJ** again after attaching the sensor cap.

Zero-adjustment will be canceled when pressing **0ADJ** for at least 1 second while **[CAP]** is displayed.

2.6 Selecting the Measurement Range

Auto or Manual range can be selected.

- Auto range Sets the optimum range automatically in accordance with the actual measurement.
(Disabled when the output function (OUTPUT) is in use.)
- Manual range Sets the range and fixes it specifically.

Measuring with the auto range



The auto range measurement starts when the instrument power is turned on.

AUTO lights up. (default setting)

Measuring with the manual range



Press **RANGE**.

The instrument will switch from the auto range to manual range, which will be fixed to the range that was selected during auto-range operation. (**AUTO** goes off.)

Each time **RANGE** is pressed, the range is specified.

200000 lx	→	20.00 lx	→	200.0 lx
↑		↓		
20000 lx		←		2000 lx

To switch to auto range

Press **RANGE** and hold for at least 1 second.
(**AUTO** lights up.)

While the measured value is retained, switching of the range can not be performed.

3

Applied Functionality

3.1 Retaining the Measured Value after a Set Amount of Time (Timer Hold Function)

This section describes how to retain the measured value after a set amount of time has elapsed.

The timer hold function is convenient when measuring low illuminance values, for example from emergency lighting or along an evacuation route.

Retaining the measured value (TIMER)



Press **HOLD** and hold for at least 1 second.

The timer hold function will be activated, and the time remaining until the measured value is held will be displayed (counted down) at the top right of the LCD display. (⏱ **TIMER** lights up.)

When the remaining time is 10 seconds or more, the instrument will beep every 5 seconds. When the remaining time is 10 seconds or less, the instrument will beep every second.

You can change the time remaining on the timer by pressing **▲** or **▼** while the timer hold function is active.

(Select from 5, 10, 15, 20, 30, 45, 60 seconds)
Default setting: 5 seconds

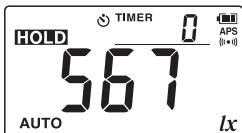



The measured value will be retained once the set amount of time has elapsed.

(**HOLD** and  **TIMER** lights up, and a continuous beep sounds for 3 sec.)

When  is pressed again, the hold state is canceled, and the timer hold function is not activated.

(**HOLD** and  **TIMER** goes off.)

- Pressing  while the timer hold function is active (while the timer is counting down) will cause the measured value to be retained. At this moment, the timer hold function is not activated. ( **TIMER** goes off.)
- While the measured value is retained, switching of the range can not be performed.

3.2 Disconnecting the Display Unit and Sensor Unit

Lux meter could be measured by disconnecting the display unit and sensor unit.

- 1 Turn off the instrument.
- 2 Hold the display unit and sensor unit, and pull them apart.

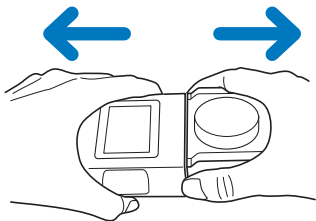

- 3 Connect the display unit and sensor unit with L9820 Connection Cable (option).

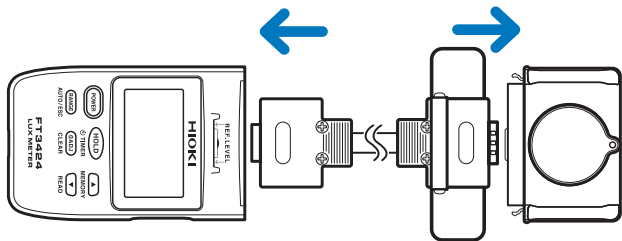

Do not separate and connect the display unit and the sensor unit while the instrument power is on.

Mounting the sensor unit on a tripod

When you need to place (fix) the sensor unit in a location while making measurements, you can mount it to a commercially available tripod. Use the mounting thread* on the back of the sensor unit.

* Thread size: 1/4" (ISO 1222)

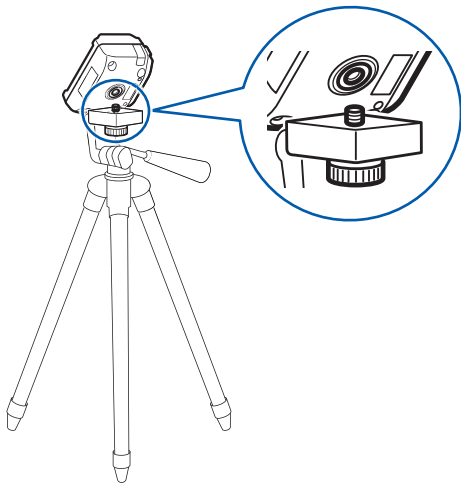

- Mount the sensor unit on the tripod after disconnecting it from the display unit.
- When mounting the sensor unit on the tripod, turn the thread (not the sensor unit).
- Do not lift the tripod by the sensor unit after it has been mounted on the tripod.

3.3 Limiting Battery Consumption (Auto Power Off Function)

This function limits the battery consumption. If the instrument has not been operated for approx. 10 minutes, the power turns off automatically. In the (default setting), the auto power off function is set to enabled. (APS lights up.)



When the auto power off function is enabled, the **APS** on the LCD display will flash 30 seconds before, along with the beeping sound 15 seconds before the instrument automatically turns off. To continuously use the instrument without turning off the power, press any key on the front panel. When the instrument has not been operated for approx. 10 minutes again since the key was pressed, the power turns off automatically.

- If the instrument will be used continuously for an extended period of time, disable the auto power off function.
- After use, be sure to turn off the instrument.
- When using the output function (OUTPUT), during USB communications, and when connected to USB bus power, the auto power off function will be disabled.

Disabling the auto power off function

If the instrument is on, turn it off.



Press  while holding down  to turn on the instrument.

Auto power off function is disabled.
Check that **APS** of the LCD display is not lit up.

The auto power off function will be disabled until the instrument is turned off. Exercise care concerning battery consumption.

3.4 Saving Measured Values (Memory Function)

The measurement result can be saved and read using the memory function. Up to 99 measured data can be saved.

You can also delete saved measured values. (p.38)

Measured values saved in the internal memory can be downloaded to a computer using the instrument's USB communications capability. (p.41)

Memory function is disabled when the output function (OUTPUT) is in use.

Saving the measured value (MEM)

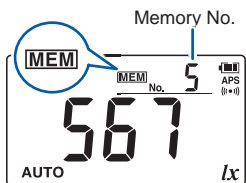

Press  (MEMORY) while measuring.

The measured value when  (MEMORY) is pressed will be saved in the internal memory, starting with the lowest memory No. At this moment, the buzzer sounds, and the memory No. and **MEM** lights up for 1 second.

When the internal memory is full

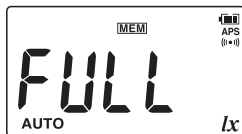

If you try to save a measured value when the internal memory is full (when 99 measured values have been saved), the LCD display will show **[FULL]**.

To save a new measured value to the internal memory, you must first delete one or more previously saved measured values. (p.38)

Reading the measured memory data (READ)

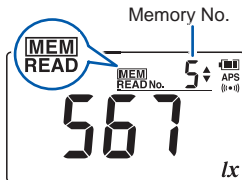

- 1 Press (READ) and hold for at least 1 second.

(MEM) and READ lights up.)

Read mode of the measurement data saved in the internal memory starts.

- 2 Select the desired memory No. using or . (upper right side of the LCD display)

Continuously increase or decrease the memory No. by holding the or for at least 1 second.

The and can only be operated when there are multiple measured values stored in the internal memory. Backlight automatically turns on when you read the measured data of the internal memory in low-light environments (approx. 750 lx or less).

Canceling the read mode

Press (ESC). (READ goes off.)

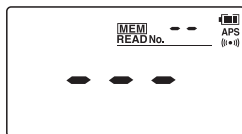

When measurement data is not saved

When no measurement data is saved in the internal memory, press (READ) and [---] appears in the LCD display for approx. 1 second, and then the measurement display reappears.

Deleting the most recently saved measured value (CLEAR)

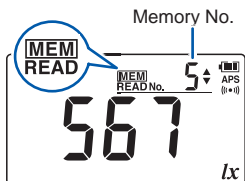

- 1 Press **▼** (READ) and hold for at least 1 second.

(MEM) and READ lights up.)

Read mode of the measurement data saved in the internal memory starts.

- 2 Press **0ADJ** (CLEAR) and hold for at least 1 second.

The most recently saved measured value (with the last memory No.) will be deleted.

You cannot delete the measured value for a specific memory No. other than the last one.

Clearing all the saved measurement data

If the instrument is on, turn it off.



- 1 Press **POWER** while holding down **0ADJ** to turn on the instrument.
- 2 Press **HOLD** and hold for at least 1 second while **CLr** is displayed.

All the saved measurement datas are cleared. After **CLr** blinks, the measurement display appears.

3.5 Logging Illuminance Data (Output Function)

You can connect the instrument to a logger or other recording instrument and have it generate voltage output based on measured values.

This functionality outputs a voltage of 1 mV DC for each effective count digit in the measured value. The voltage is updated at the same rate as the instrument's LCD display.

CAUTION



To avoid damaging the output cord, unplug it by grasping the connector, not the cord.

- When using the output function (OUTPUT), the following functions are disabled.
 - Auto power off function
 - Memory function
 - Auto range
- When using the output function for an extended period of time, connect a USB cable to the instrument so that it operates on USB bus power.
- +2.5 V signal will be output temporarily when turning the power on, while the output cord is plugged in; however this is not a malfunction.

- 1 Press **POWER** and hold for at least 1 second to turn off the instrument.
- 2 Connect the mini jack of 9094 Output Cord (option) to the D/A OUTPUT terminal of the right side of the instrument.
- 3 (Set the recording instrument in advance.)
Connect the banana terminal of the 9094 Output Cord to the logger or other recording instrument.
- 4 Press **POWER** to turn on the instrument.

Connection example

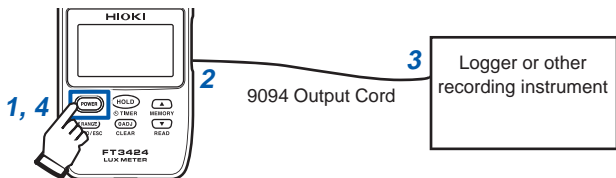

The voltage is output from the D/A OUTPUT terminal, depending on the measurement value. (**OUTPUT** lights up.)

- 5 Perform zero-adjustment as necessary, and select the output rate by pressing **RANGE**. (See table below)

Range	Output rate
20 lx	1 mV DC / 0.01 lx
200 lx	1 mV DC / 0.1 lx
2000 lx	1 mV DC / 1 lx
20000 lx	1 mV DC / 10 lx
200000 lx	1 mV DC / 100 lx

When each range's full scale exceeds, the output is 2.5 V DC. (**OVER** lights up on the LCD display.)

3.6 Communicating with PC

Using the included USB cable, it is possible to transmit data to the PC or to control the instrument.

For details, see the communications specifications which accompanies with the CD.

Install the special PC application software on the PC.

Connect to the PC.

The virtual COM ports of the PC can be used as the USB interface.

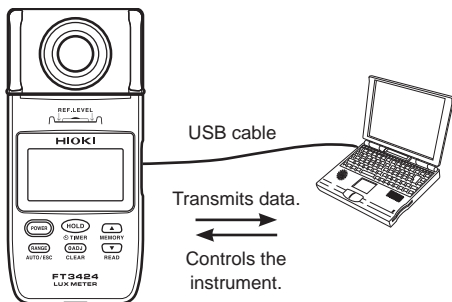



- When connecting a USB cable to the instrument, exercise care to orient the connector properly.
- During USB communication,  lights up on the LCD display.
- During USB communication, do not disconnect the USB cable. Disconnecting the cable stops the communication. In that case, a warning is displayed by the special PC application software. Connect the USB cable again.

3.7 Disabling the buzzer

The buzzer sound is enabled when factory default settings.
Turn off the power of the instrument when changing the settings.



Press  while holding down  to turn on the instrument.

[bP oFF] is displayed, and the buzzer is not activated.

When you release , the screen will return to the measured value display. ( goes off.)

The buzzer sound is disabled until the power is turned off.

3.8 Turning On the Backlight

The LCD display includes a backlight for use when making measurements in dim locations. The backlight will activate automatically when the measured value is retained or when the measured value data stored in the internal memory is in read mode, both in low-light environments (approx. 750 lx or less).

To avoid affecting measurement results, the backlight cannot be turned on during measurement.

Forcing the backlight to turn on

To forcibly turn on the backlight in an environment with illuminance that is greater than or equal to approximately 750 lx , attach the sensor cap to the illuminance sensor while retaining the measured value.

Activation and deactivation of the backlight is unrelated to the measured value that is being retained. The illuminance sensor continuously monitors illuminance, and the instrument determines whether to turn the backlight on or off based on a monitored illuminance level of approximately 750 lx .

Disabling the buzzer

4

Specifications

4.1 Basic Specifications

Classifications Grade JIS C 1609-1: 2006 General Class AA

- Display**
- Display LCD display 4 digits
 - Effective display digits 2000 counts
 - Display unit lx (lux)
 - Display update rate 500 ms \pm 20 ms

Measurement ranges

Range	Measurement range	Display steps
20 lx	0.00 lx to 20.00 lx	1 count step
200 lx	0.0 lx to 200.0 lx	
2000 lx	0 lx to 2000 lx	
20000 lx	0 ₀ lx to 2000 ₀ lx	10 count step
200000 lx	0 ₀₀ lx to 2000 ₀₀ lx	100 count step

Measurement range selection Auto / Manual

4.2 Measurement Specifications

Accuracy

Linearity	±2% rdg. (Multiply by 1.5 for display values in excess of 3,000 <i>lx</i> .) (Add ±1dgt. for display values that are less than 1/3 of the range.)
Accuracy guarantee conditions	Display unit and sensor unit must bear the same collation No.
Accuracy guarantee for temperature and humidity	21°C to 27°C (69.8°F to 80.6°F), 75% RH or less (no condensation)
Accuracy warranty period	2 years

- f.s. (maximum display value): The maximum displayable value. This is usually the name of the currently selected range.
- rdg. (reading value): The value currently being measured and displayed on the measuring instrument.
- dgt. (resolution): The minimum display unit, indicating a minimum digit of 1.

Characteristic

Angled incident light characteristics	Systematic deviation f_2 : 3% or less Deviation from cosine characteristics:								
	<table border="1"> <thead> <tr> <th data-bbox="327 314 516 390">Angle</th> <th data-bbox="516 314 864 390">Deviation from cosine characteristics</th> </tr> </thead> <tbody> <tr> <td data-bbox="327 390 516 438">30°</td> <td data-bbox="516 390 864 438">±2%</td> </tr> <tr> <td data-bbox="327 438 516 486">60°</td> <td data-bbox="516 438 864 486">±7%</td> </tr> <tr> <td data-bbox="327 486 516 525">80°</td> <td data-bbox="516 486 864 525">±25%</td> </tr> </tbody> </table>	Angle	Deviation from cosine characteristics	30°	±2%	60°	±7%	80°	±25%
Angle	Deviation from cosine characteristics								
30°	±2%								
60°	±7%								
80°	±25%								
Response time	Auto range: 5 seconds or less Manual range: 2 seconds or less								
Temperature characteristic	Deviation from value measured at 23°C (73.4°F) between -10 to 40°C (14°F to 104°F): ±3% rdg.								
Humidity characteristic	Deviation from value measured in an environment with a temperature and humidity of 23°C (73.4°F), and 45% to 70% RH when the unit is left in an 85% to 95% RH environment for 3 hours and then is returned to the original environment: ±3% rdg.								
Relative spectral response characteristics in the visible spectrum	Deviation from spectral luminous efficiency (relative luminous efficiency) f_1' : 6% or less								
Response characteristics in ultraviolet and infrared spectrums	Response to ultraviolet and infrared radiation : 1% or less								
Fatigue characteristics	The change in value of 1 minute and 10 minutes after light strikes sensor : ±1% rdg.								

Characteristics regarding intermittent light	Deviation in value when subjected to intermittent light for 1/2 cycle at a frequency of 100 Hz or 120 Hz : $\pm 2\%$ rdg.
---	---

4.3 Output Specifications

Output method	D/A output
Output level	2 V / range f.s. 2.5 V is output when the range f.s. is exceeded.
Resolution	1 mV

Range	Output rate
20 lx	1 mV DC / 0.01 lx
200 lx	1 mV DC / 0.1 lx
2000 lx	1 mV DC / 1 lx
20000 lx	1 mV DC / 10 lx
200000 lx	1 mV DC / 100 lx

Output update rate	500 ms \pm 20 ms
Output accuracy	$\pm 1\%$ rdg. ± 5 mV (at display count)
Output resistance	1.1 k Ω or less

4.4 Functional Specifications

Hold function	Retains the measured value.
Timer hold function	Retains the measured value after the set timer time has elapsed after executing. Select and set the timer time from 5, 10, 15, 20, 30, 45, 60 seconds.
Memory function	Up to 99 measured data can be saved.

Auto power off function	Turns off the instrument approx.10 minutes after the last key operation (can be canceled).
Power shutdown	When the charge is gone, [b. Lo] blinks in the display for 3 seconds and the power is shut down.
Buzzer sound	Emits a buzzer sound when keys are operated, when the timer hold function activates, and when it is auto power off function. (The buzzer sound can be canceled).
Backlight	Activates when the measured value is retained or when the measured value data stored in the internal memory is in read mode, both while the ambient illuminance is less than 750 lx.
Zero adjustment	Performs zero-adjustment. Zero-adjustment execution time: 3 seconds or less

4.5 General Specifications

Product warranty period	3 years
Light receiving element	Silicon photo diode
Interface	USB 2.0
Operating temperature and humidity	-10°C to 40°C (14°F to 104°F), 80% RH or less (no condensation)
Storage temperature and humidity	-20°C to 50°C (-4°F to 122°F), 80% RH or less (no condensation)
Operating environment	Indoors, pollution degree 2, altitude up to 2,000 m (6,562 ft.)

Power supply	<p>LR6 Alkaline battery × 2</p> <p>R6 Manganese battery × 2</p> <p>Rated power voltage 1.5 V DC × 2</p> <p>(Maximum allowable voltage 3.6 V DC)</p> <p>USB bus power 5 V DC</p>
Continuous operating time	Approx. 300 hours (when LR6 alkaline batteries are used)
Maximum rated power	500 mVa
Dimensions	Approx. 78W × 170H × 39D mm (3.07" W × 6.69" H × 1.54" D)
Mass	Approx. 310 g (10.9 oz.) (including the batteries)
Standard compliance	<ul style="list-style-type: none"> • JIS C 1609-1: 2006 General Class AA • DIN 5032-7: 1985 Class B
Applicable standards	<ul style="list-style-type: none"> • Safety: EN61010 • EMC: EN61326
Dustproof and waterproof	<p>IP40 (EN60529)</p> <div style="border: 1px solid black; padding: 5px; margin-top: 10px;"> <p>To avoid any failure, do not allow the instrument to get wet. If the instrument gets wet, have your authorized Hioki distributor or reseller inspect or repair it, if necessary.</p> </div>
Accessories	<ul style="list-style-type: none"> • Instruction Manual • LR6 Alkaline battery × 2 • Sensor cap (with strap) • Carrying Case (soft) • Strap (for instrument) • USB cable (0.9 m) • CD (USB driver, dedicated computer application software, and communications specifications)
Options	See: "Options (sold separately)" (p.3)

5.1 Repair, Inspection, and Cleaning

Calibrations

IMPORTANT

Periodic calibration is necessary in order to ensure that the instrument provides correct measurement results of the specified accuracy.

The calibration interval for this instrument is 2 years. It is recommended to calibrate it every 2 years for accurate measurement.

Cleaning

- To clean the instrument, wipe it gently with a soft cloth moistened with water or mild detergent.
- Wipe the illuminance sensor and the LCD display gently with a soft, dry cloth.

IMPORTANT

Never use solvents such as benzene, alcohol, acetone, ether, ketones, thinners or gasoline, as they can deform and discolor the case.

Disposal

Handle and dispose of the instrument in accordance with local regulations.

5.2 Troubleshooting

- When a malfunction of the instrument is suspected, check the information in “Before sending the instrument for repair” and then, if necessary, contact your authorized Hioki distributor or reseller.
- When sending the instrument for repair, remove the batteries and pack it carefully to prevent damage during transportation. Include cushioning material so the instrument cannot move within the package. Be sure to include details of the problem. Hioki cannot be responsible for damage that occurs during transportation.

Before sending the instrument for repair

Symptom	Check and/or remedy
Nothing appears in the display. Or the display disappears after a short time.	Check that the batteries are not exhausted. (p.17) Replace with new batteries. (p.20) When using a manganese battery or nickel-hydride battery, the battery indicator may not operate properly.
	When the auto power off function is enabled and the instrument has not been operated for approx. 10 minutes, the power turns off automatically. Check the setting of the auto power off function. (p.35)
The display does not stabilize and the value fluctuates; it is difficult to read the value.	When measuring illuminance underneath a standard lighting fixture, the display may not stabilize. In most cases, a failure to stabilize is due to fluctuations in the lighting fixture's supply voltage or to the surrounding environment (for example, a person's shadow). Exercise care concerning these factors when performing measurement.
The range can not be changed.	While the measured value is retained, the range can not be changed. Please cancel the hold function.

Symptom	Check and/or remedy
<p>Turning on the power brings up the error display.</p> <p>When nothing is connected, the error display appears.</p>	<p>Send the instrument for repair.</p> <p>Refer to "5.3 Error Display" (p.54)</p>

Frequently asked questions (FAQ)

Question	Solution
<p>Would like to perform zero-adjustment.</p>	<p>Perform zero-adjustment.</p> <p>Refer to "2.5 Making Measurements" (p.25)</p>
<p>Can rechargeable batteries be used?</p>	<p>Nickel-metal hydride batteries can be used. However, the discharge characteristic of these batteries is different from that of alkaline batteries. Be aware that the remaining battery power display does not function properly.</p>
<p>Would like to control multiple instruments with 1 PC.</p>	<p>It is possible to control multiple instruments by connecting the USB cable.</p>
<p>The instrument cannot communicate with the PC.</p>	<ul style="list-style-type: none"> • Check the communication setting between the instrument and the PC. For details, see the communications specifications which accompanies with the CD. • Check that the USB cable is connected correctly. (p.41) • Verify that the illuminance sensor is not dirty.
<p>Would like to know commands.</p> <p>Would like to perform communication using own software.</p>	<p>To communicate with the instrument and PC, installation of the USB driver and special PC application software is necessary.</p> <p>For details on communication commands, see the communications specifications which accompanies with the CD.</p>

5.3 Error Display

Error display	Description	Solution
Err 01	ROM error Malfunction of the program.	When the error appears in the LCD display, it is necessary to repair the instrument. Contact your authorized Hioki distributor or reseller.
Err 02	ROM error Malfunction of the adjustment data.	
Err 04	EEPROM error Malfunction of the memory data.	

5.4 Display Messages

Display	Description	Reference
Adj	Performing zero-adjustment.	p.25
b. Lo	The battery is exhausted. Replace the batteries.	p.20
off ^{bP}	Disabling the buzzer.	p.42
CAP	Zero-adjustment cannot be performed since the sensor cap is not covered. Affix the sensor cap.	p.28
Clr	All saved measured values will be deleted. Continue?	p.38
Err	An internal ROM or EEPROM error has occurred. Send the instrument for repair.	p.54
FULL	The internal memory is full. Delete the measured data in the internal memory.	p.38
n.c.	The display part and sensor unit is not connected. Connect the display unit and sensor unit, either directly or with a cable.	-
---	There is no measured data saved in the internal memory.	p.37

Appendix

Appx. 1 Recommended Levels of Illumination (Reference)

Suitable levels of illuminance (according to the JIS standard Z 9110).

Offices

Recommended illuminance [lx]	Illuminance level [lx]	Place/work activity
750	500 to 1000	Design rooms, offices, board rooms
500	300 to 750	Computer rooms, conference rooms, reception rooms
300	200 to 500	Reception area, dining rooms, elevator halls
200	150 to 300	Kettle rooms, locker rooms, restrooms

Factories

Recommended illuminance [lx]	Illuminance level [lx]	Place/work activity
1500	1000 to 2000	Extremely precision visual work such as producing precision mechanical equipments and electronic parts
750	500 to 1000	Precision visual work such as analyzing in chemical factories
500	300 to 750	Ordinary visual work in manufacturing plants
150	100 to 200	Stairways, loading and unloading
50	30 to 75	Indoor emergency stairways

Recommended Levels of Illumination (Reference)

Schools

Recommended illuminance [Δx]	Illuminance level [Δx]	Place/work activity
1000	750 to 1500	Precision handicraft, precision experimenting
750	500 to 1000	Precision drawing or drafting
500	300 to 750	Experiment demonstration rooms, library reading rooms, nurse's office, kitchen
300	200 to 500	Classrooms, gymnasium, office rooms, cafeteria
100	75 to 150	Corridors, connecting corridors, entrance

Appx. 2 Sensor Characteristics Graphs

Relative Spectral Response Characteristics in the Visible Spectrum

Human perception of brightness ranges from 380 nm to 780 nm in the wavelength and is the maximum at 555 nm. The International Commission on Illumination (CIE) has established comparative standards for luminosity, setting the maximum perception for 1 and indicating the amount of perception of each wavelength by the relative value, and calculating the average of many people. In this instrument, the relative spectral response characteristics are close to the comparative standards for luminosity.

The deviation from the comparative standards for luminosity is determined by the f_1' value of JIS standard C 1609-1:2006.

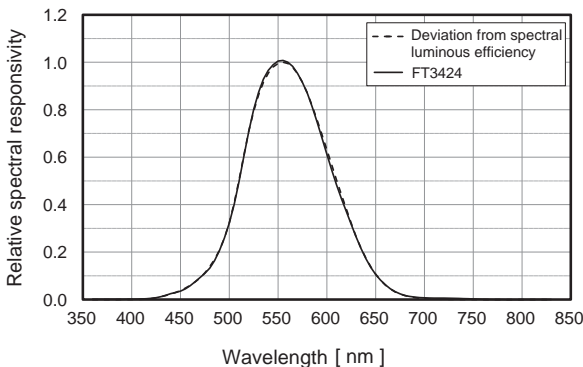

Graph illustrates typical characteristics. Characteristics exhibited by individual products may vary slightly.

Angled Incident Light Characteristics

It is known that the luminance is proportional to the cosine of the incident angle of light (the cosine law).

In this instrument, the shape of the light sensor, hook etc. is so made that it can follow the cosine law closely.

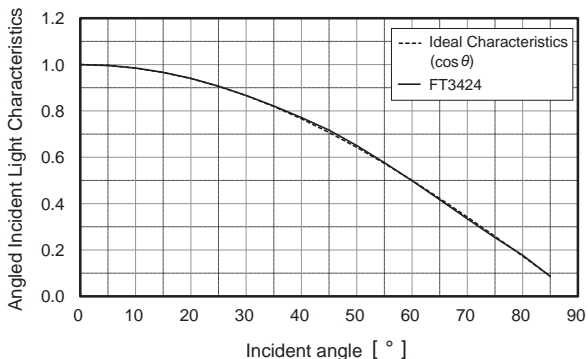

Graph illustrates typical characteristics. Characteristics exhibited by individual products may vary slightly.

Appx. 3 Other Characteristics

Color correction factor for a general light source relative to standard illuminant A

Light source	k
Fluorescent lamp F6	1.003
Fluorescent lamp F8	1.002
Fluorescent lamp F10	1.002
High-pressure sodium lamp	1.011
Metal halide lamp H1	1.002
Metal halide lamp H2	1.003
High-pressure mercury lamp	0.995

Table shows typical characteristics. Characteristics exhibited by individual products may vary slightly.

Range of distances in which the law of inverse squares relative to distance applies

50 cm from the measurement reference level

Incidence uniformity

The instrument is designed to be used under conditions in which the illuminance distribution on the sensor surface is roughly uniform. An error component will be introduced into measurements if the illuminance distribution on the sensor surface is non-uniform, for example when measuring a light source with strong directionality.

Appx. 4 Dimensional drawing

Unit : mm

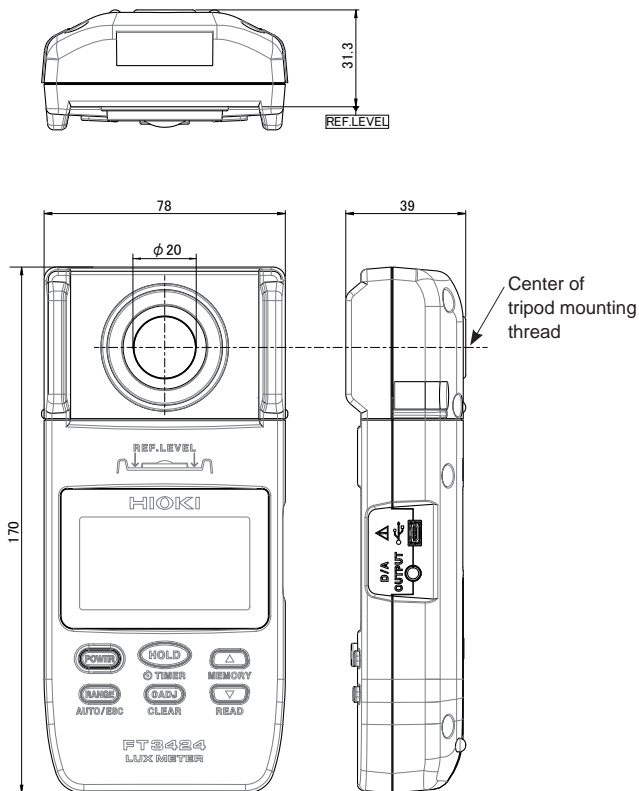

Warranty Certificate

Model	Serial No.	Warranty period Three (3) years from date of purchase (___ / ___)
<p>This product passed a rigorous inspection process at Hioki before being shipped.</p> <p>In the unlikely event that you experience an issue during use, please contact the distributor from which you purchased the product, which will be repaired free of charge subject to the provisions of this Warranty Certificate. This warranty is valid for a period of three (3) years from the date of purchase. If the date of purchase is unknown, the warranty is considered valid for a period of three (3) years from the product's date of manufacture. Please present this Warranty Certificate when contacting the distributor. Accuracy is guaranteed for the duration of the separately indicated guaranteed accuracy period.</p> <ol style="list-style-type: none">Malfunctions occurring during the warranty period under conditions of normal use in conformity with the Instruction Manual, product labeling (including stamped markings), and other precautionary information will be repaired free of charge, up to the original purchase price. Hioki reserves the right to decline to offer repair, calibration, and other services for reasons that include, but are not limited to, passage of time since the product's manufacture, discontinuation of production of parts, or unforeseen circumstances.Malfunctions that are determined by Hioki to have occurred under one or more of the following conditions are considered to be outside the scope of warranty coverage, even if the event in question occurs during the warranty period:<ol style="list-style-type: none">Damage to objects under measurement or other secondary or tertiary damage caused by use of the product or its measurement resultsMalfunctions caused by improper handling or use of the product in a manner that does not conform with the provisions of the Instruction ManualMalfunctions or damage caused by repair, adjustment, or modification of the product by a company, organization, or individual not approved by HiokiConsumption of product parts, including as described in the Instruction ManualMalfunctions or damage caused by transport, dropping, or other handling of the product after purchaseChanges in the product's appearance (scratches on its enclosure, etc.)Malfunctions or damage caused by fire, wind or flood damage, earthquakes, lightning, power supply anomalies (including voltage, frequency, etc.), war or civil disturbances, radioactive contamination, or other acts of GodDamage caused by connecting the product to a networkFailure to present this Warranty CertificateFailure to notify Hioki in advance if used in special embedded applications (space equipment, aviation equipment, nuclear power equipment, life-critical medical equipment or vehicle control equipment, etc.)Other malfunctions for which Hioki is not deemed to be responsible <p>*Requests</p> <ul style="list-style-type: none">Hioki is not able to reissue this Warranty Certificate, so please store it carefully.Please fill in the model, serial number, and date of purchase on this form. <p style="text-align: right;">13-09</p>		
HIOKI E.E. CORPORATION 81 Koizumi, Ueda, Nagano 386-1192, Japan TEL: +81-268-28-0555 FAX: +81-268-28-0559		

- Please visit our website at <http://www.hioki.com> for the following:
 - Regional contact information
 - The latest revisions of instruction manuals and manuals in other languages.
 - Declarations of Conformity for instruments that comply with CE mark requirements.
- All reasonable care has been taken in the production of this manual, but if you find any points which are unclear or in error, please contact your supplier or the International Sales and Marketing Department at Hioki headquarters.
- In the interests of product development, the contents of this manual are subject to revision without prior notice.
- The content of this manual is protected by copyright.
No reproduction, duplication or modification of the content is permitted without the authorization of Hioki E.E. Corporation.

HIOKI

HIOKI E. E. CORPORATION

**Test Equipment
Depot**

1-800-517-8431

99 Washington Street
Melrose, MA 02176
Phone 781-665-1400
Toll Free 1-800-517-8431



Visit us at www.TestEquipmentDepot.com