



Dual Measurement Multimeter

GDM-834X Series

USER MANUAL

GW INSTEK PART NO. 82DM-83420EC1



ISO-9001 CERTIFIED MANUFACTURER

GW INSTEK

This manual contains proprietary information, which is protected by copyright. All rights are reserved. No part of this manual may be photocopied, reproduced or translated to another language without prior written consent of Good Will company.

The information in this manual was correct at the time of printing. However, Good Will continues to improve products and reserves the rights to change specification, equipment, and maintenance procedures at any time without notice.

Good Will Instrument Co., Ltd.
No. 7-1, Jhongsing Rd., Tucheng Dist., New Taipei City 236, Taiwan.

Table of Contents

SAFETY INSTRUCTIONS	5
GETTING STARTED	10
Characteristics	11
Appearance	14
Set Up.....	24
OPERATION.....	29
Basic Measurement Overview	31
AC/DC Voltage Measurement.....	33
AC/DC Current Measurement	38
Resistance Measurement	43
Diode Test	45
Capacitance Measurement	46
Continuity Test.....	48
Frequency/Period Measurement	51
Temperature Measurement	53
Dual Measurement Overview	57
Advanced Measurement Overview	62
dBm/dB/W Measurement	63
Max/Min Measurement.....	66
Relative Measurement	67
Hold Measurement	69
Compare Measurement.....	70
Math Measurement.....	72
SYSTEM/DISPLAY CONFIGURATION	76
View Serial Number	77
View Version Number	77
Brightness Settings.....	78
Input Resistance Settings	79

Frequency/Period Input Jack Settings.....	80
Compatibility Settings	81
Restore Factory Default Settings	82
USB STORE.....	83
USB Store Overview	84
REMOTE CONTROL	101
Configure Remote Control Interface	102
Return to Local Control	105
COMMAND OVERVIEW	106
Command Syntax	106
Command List.....	111
FAQ	142
APPENDIX	143
System Menu Tree.....	143
Factory Default Settings	144
Replacing the AC Source Fuse	145
Replacing the Input Fuse.....	146
Status system	148
Specifications	149
Dimensions	155
Declaration of Conformity.....	156
INDEX.....	157

S SAFETY INSTRUCTIONS

This chapter contains important safety instructions that you must follow during operation and storage. Read the following before any operation to ensure your safety and to keep the instrument in the best possible condition.

Safety Symbols

These safety symbols may appear in this manual or on the instrument.



WARNING

Warning: Identifies conditions or practices that could result in injury or loss of life.



CAUTION

Caution: Identifies conditions or practices that could result in damage to the DMM or to other properties.



DANGER High Voltage



Attention Refer to the Manual



Protective Conductor Terminal



Earth (ground) Terminal



Do not dispose electronic equipment as unsorted municipal waste. Please use a separate collection facility or contact the supplier from which this instrument was purchased.

Safety Guidelines

General Guideline



CAUTION

- Make sure that the voltage input level does not exceed DC1000V/AC750V.
- Make sure the current input level does not exceed 12A.
- Do not place any heavy object on the instrument.
- Avoid severe impact or rough handling that can lead to damaging the instrument.
- Do not discharge static electricity to the instrument.
- Use only mating connectors, not bare wires, for the terminals.
- Do not block or obstruct the cooling fan vent opening.
- Do not perform measurement at the source of a low-voltage installation or at building installations (Note below).
- Do not disassemble the instrument unless you are qualified as service personnel.
- Make sure that the COM terminal to earth is limited to 500Vpk.

(Note) EN 61010-1:2010 specifies the measurement categories and their requirements as follows. The GDM-834X falls under category II 600V.

- Measurement category IV is for measurement performed at the source of low-voltage installation.
 - Measurement category III is for measurement performed in the building installation.
 - Measurement category II is for measurement performed on the circuits directly connected to the low voltage installation.
-

-
- Power Supply
- AC Input voltage: 100/120/220/240 V AC
 - 50/60Hz
 - The power supply voltage should not fluctuate more than 10%.
 - Connect the protective grounding conductor of the AC power cord to an earth ground, to avoid electrical shock.
-
-  WARNING
- Fuse
- Fuse type: 0.125AT 100/120VAC
0.063AT 220/240 VAC
 - Make sure the correct type of fuse is installed before power up.
 - To avoid risk of fire, replace the fuse only with the specified type and rating.
 - Disconnect the power cord before fuse replacement.
 - Make sure the cause of a fuse blowout is fixed before fuse replacement.
-
- Cleaning the Instrument
- Disconnect the power cord before cleaning.
 - Use a soft cloth dampened in a solution of mild detergent and water. Do not spray any liquid.
 - Do not use chemicals containing harsh material such as benzene, toluene, xylene, and acetone.
-
- Operation Environment
- Location: Indoor, no direct sunlight, dust free, almost non-conductive pollution (Note below)
 - Temperature: 0°C to 50°C
 - Humidity: 0~35°C: < 80%RH
>35°C: <70%RH
 - Altitude: <2000m

(Note) EN 61010-1:2010 specifies the pollution degrees and their requirements as follows. The GDM-8342/8341 falls under degree 2.

- Pollution refers to “addition of foreign matter, solid, liquid, or gaseous (ionized gases), that may produce a reduction of dielectric strength or surface resistivity”.
- Pollution degree 1: No pollution or only dry, non-conductive pollution occurs. The pollution has no influence.
- Pollution degree 2: Normally only non-conductive pollution occurs. Occasionally, however, a temporary conductivity caused by condensation must be expected.
- Pollution degree 3: Conductive pollution occurs, or dry, non-conductive pollution occurs which becomes conductive due to condensation which is expected. In such conditions, equipment is normally protected against exposure to direct sunlight, precipitation, and full wind pressure, but neither temperature nor humidity is controlled.

Storage environment

- Location: Indoor
- Temperature: -10°C to 70°C
- Humidity: $0\sim 35^{\circ}\text{C}$: $<90\% \text{RH}$
 $>35^{\circ}\text{C}$: $<80\% \text{RH}$

Disposal



Do not dispose this instrument as unsorted municipal waste. Please use a separate collection facility or contact the supplier from which this instrument was purchased. Please make sure discarded electrical waste is properly recycled to reduce environmental impact.

Power cord for the United Kingdom

When using the unit in the United Kingdom, make sure the power cord meets the following safety instructions.

NOTE: This lead/appliance must only be wired by competent persons



WARNING: THIS APPLIANCE MUST BE EARTHED

IMPORTANT: The wires in this lead are coloured in accordance with the following code:

Green/ Yellow:	Earth
Blue:	Neutral
Brown:	Live (Phase)



As the colours of the wires in main leads may not correspond with the coloured marking identified in your plug/appliance, proceed as follows:

The wire which is coloured Green & Yellow must be connected to the Earth terminal marked with either the letter E, the earth symbol  or coloured Green/Green & Yellow.

The wire which is coloured Blue must be connected to the terminal which is marked with the letter N or coloured Blue or Black.

The wire which is coloured Brown must be connected to the terminal marked with the letter L or P or coloured Brown or Red.

If in doubt, consult the instructions provided with the equipment or contact the supplier.

This cable/appliance should be protected by a suitably rated and approved HBC mains fuse: refer to the rating information on the equipment and/or user instructions for details. As a guide, a cable of 0.75mm² should be protected by a 3A or 5A fuse. Larger conductors would normally require 13A types, depending on the connection method used.

Any exposed wiring from a cable, plug or connection that is engaged in a live socket is extremely hazardous. If a cable or plug is deemed hazardous, turn off the mains power and remove the cable, any fuses and fuse assemblies. All hazardous wiring must be immediately destroyed and replaced in accordance to the above standard.

G E T T I N G S T A R T E D

This chapter describes the GDM-8342 and GDM-8341 multimeters in a nutshell, including accessories, and package contents, their main features and front / rear panel introduction.

Characteristics	11
Accessories.....	12
Package Contents.....	13
Appearance	14
GDM-8342/8341 Front Panel	14
Display Overview	20
Rear Panel	22

Characteristics

The GDM-8342 and GDM-8341 are portable, dual-display digital multimeters suitable for a wide range of applications, such as production testing, research, and field verification.

Performance	<ul style="list-style-type: none">• DCV accuracy: 0.02%• High current range: 10A• High Voltage range: 1000V• High ACV frequency response: 100kHz
Features	<ul style="list-style-type: none">• 50000 count display• Multi functions: ACV, DCV, ACI, DCI, R, C, Hz, Temp*, Continuity, Diode test, MAX/MIN, REL, dBm, Hold, MX+B, 1/X, REF%, dB, Compare.• Manual or Auto ranging• AC true RMS• Data Logging to USB*• Data logging to PC using an Excel Add-In
Interface	<ul style="list-style-type: none">• Voltage/Resistance/Diode/Capacitance/Temperature* input• Current input• USB device port as standard for remote control• USB host* for data logging• Optional GPIB* (factory install)• Calibration port (for service operators only)• Excel Add-In for easy-to-use remote control, data logging and for saving/recalling setups

* These features are only available on the GDM-8342

Accessories

Standard Accessories		
Standard Accessories	Part number	Description
	82DM-83420Ex1	User Manual CD
	82DM-83421Mx1	Safety Instruction Sheet
	GTL-207	Test leads: 1x red, 1x black
Optional Accessories		
Optional Accessories	Part number	Description
	1040-8342020	GPIB (Factory installed, GDM-8342 only)
	GTL-246	USB Cable
	GTL-205	Temperature Probe Adapter with Thermal Coupling (K-type)
Download		
Download	Name	Description
	gdmvcp.inf (In GDM-834X USB DRIVER.ZIP)	USB driver
	GDM-834x Excel Addins	Data logging Excel Add-In logs measurements to a PC by remote control via the USB interface only. This Excel Add-In can't be used via the GPIB interface.

Package Contents

Check the contents before using the instrument.

Opening the box

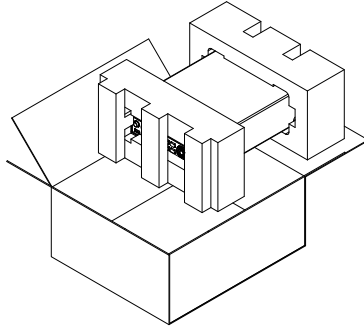

Contents (single unit)

- Main unit
- Test leads (red x1, black x1)
- Power cord x1 (region dependent)
- User manual CD
- Safety instruction sheet

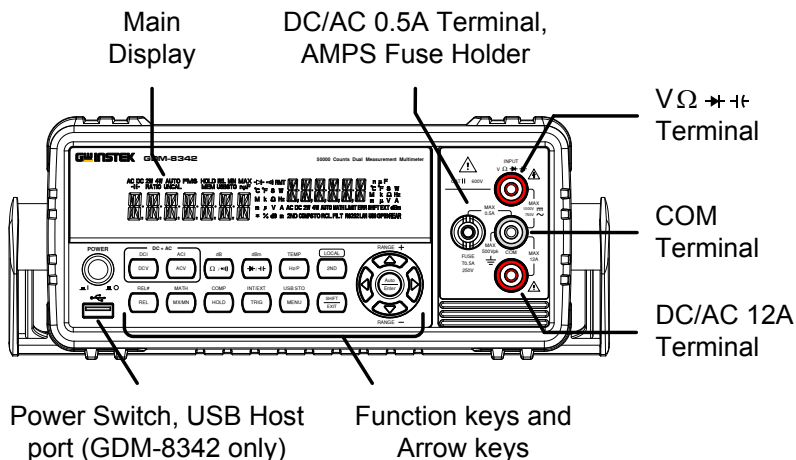

Appearance

GDM-8342/8341 Front Panel

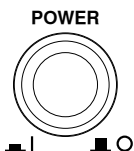

Power Switch



Turns On  or Off  the main power. For the power up sequence, see page 25.

USB Host Port

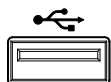

The Host port is a type A USB port for logging data. See the USB Store chapter for more details, page 83.

 Note: GDM-8342 only.

Main Display

Shows measurement results and parameters. For display configuration details, see page 78 (light setting).

For an overview of the main display, see page 20.

v Ω → ← Input Terminal

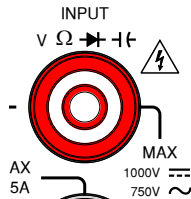

This terminal is used for all measurements except for DC/AC current measurements.

COM Terminal

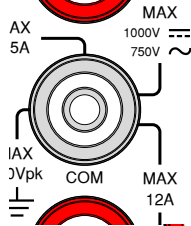

Accepts ground (COM) line in all measurements.

The maximum withstand voltage between this terminal and earth is 500Vpk.

DC/AC 0.5A Terminal

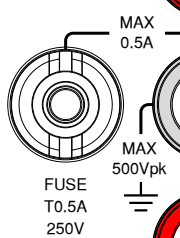

Low current measurement terminal. Accepts DC/AC Current input. For details see page 38.

DC: 500μA~0.5A
AC: 500μA~0.5A

AMPS Fuse Holder

As a fuse, protects the instrument from over-current. Rating: T0.5A, 250V. (This terminal accepts DC/AC current input)

For the fuse replacement procedure, see page 146.

DC/AC 12A Terminal

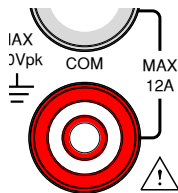



High range current measurement terminal. Accepts DC/AC Current input. For DCI or ACI details, see page 38.

Measurement Keys The top row of measurement keys are used for basic DMM measurements such as voltage, current, resistance, capacitance and frequency. The bottom row of measurement functions are used for more advanced functions.



Each key has a primary and secondary function. The secondary function is accessed in conjunction with the SHIFT key.

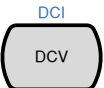

Upper Measurement keys

DCV  Measures DC Voltage (page 33).

DCI (SHIFT→DCV)  →  Measures DC Current (page 38).

ACV  Measures AC Voltage (page 33).

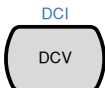
ACI (SHIFT→ACV)  →  Measures AC Current (page 38).

DCV + ACV  +  Measures DC + AC voltage (page 33).

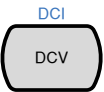
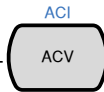
DCI+ACI  →  +  Measures DC + AC current (page 38).

Resistance/
Continuity)

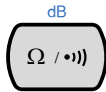

Measures resistance or continuity, depending on the selected mode. See page 43 and 48, respectively.

dB
(SHIFT → Ω / ∞)

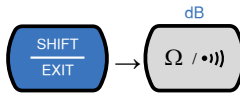

Measures dB. See page 65.

Diode/
Capacitance

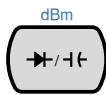

Tests diodes or measures capacitance, depending on the selected mode. See page 45 and 46, respectively.

dBm
(SHIFT → ∩ / ∟)

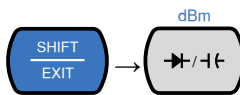

Measures dBm. See page 63

Hz/P

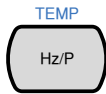

Measures the frequency or period of a signal, depending on the selected mode. See page 51.

TEMP
(SHIFT → Hz/P)

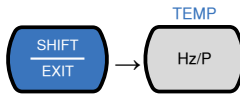

Measures temperature. See page 53.

2ND



As the 2nd key, selects the measurement item on the 2nd display (page 57). Pressing and holding for more than 1 second turns off the 2nd display.



As the Local key, releases the remote control and returns the instrument to local panel operation (page 105).

Lower Measurement keys

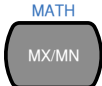

REL  Measures the Relative value (page 67).

REL#
(SHIFT→REL)  →  Manually sets the reference value for the Relative value measurement.

MX/MN  Measures the Maximum or the Minimum value (page 66).

MATH
(SHIFT→MX/MN)  →  Enters the Math measurement mode. The supported math functions include MX+B, REF% and 1/X. See page 72 for details.

HOLD  Activates the Hold function (page 69).

COMP
(SHIFT→HOLD)  →  Activates the compare measurement function. See page 70.

TRIG  Triggers sample acquisition manually when the trigger is set to external triggering. See page 32. (Note: Not supported for capacitance measurement)

INT/EXT
(SHIFT→TRIG)  →  Toggles the trigger source as either internal or external(manual trigger).

MENU



Enters the configuration menu for System Settings, Measurement Settings, Temperature measurement settings, I/O settings and USB storage settings. See page 76 for the system menu.

USB STO
(SHIFT→MENU)

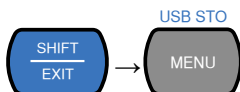

Logs measurement data to a USB drive. This function is only available for the GDM-8342. See page 83.

SHIFT/EXIT



When used as a SHIFT key, it is used to access the secondary functions associated with the measurement keys.

When used as an EXIT key, it will exit out of menu systems.

AUTO/ENTER



When used as an AUTO key, it will set the range of the selected function to autorange.

When used as an ENTER key, it will confirm the entered value or menu item.

Arrow Keys

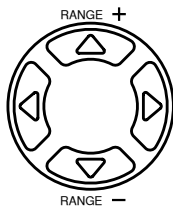

The arrow keys are used to navigate the menu system and edit values.

The Up and Down arrow keys will also manually set the range for the voltage and current measurements.

The Left and Right arrow keys will also toggle the refresh rate between the fast, medium and slow rates.

Display Overview

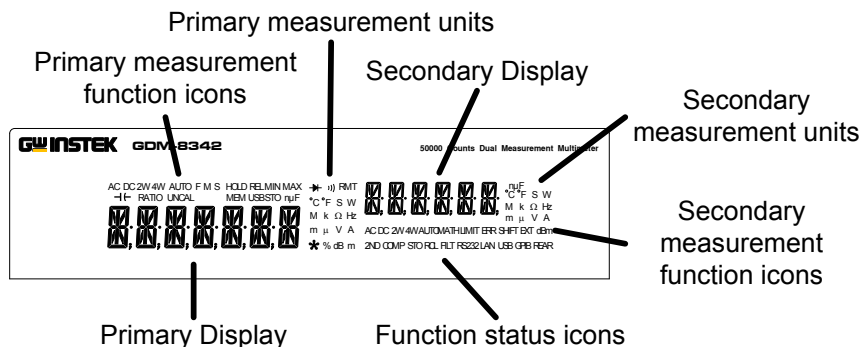

Primary
Measurement
Function Icons

Displays the primary measurement function.

Primary
Measurement
Units

Displays the units for the primary measurement function.

Secondary
Display

Displays the results of the secondary measurement.

Secondary Measurement Units	Displays the units for the secondary measurement function.
Secondary Measurement function icons	Displays the secondary measurement function.
Function Status Icons	Display status icons for operations/functions that are not linked to the primary or secondary functions.
Primary Display	Displays the results of the primary measurement.

Rear Panel

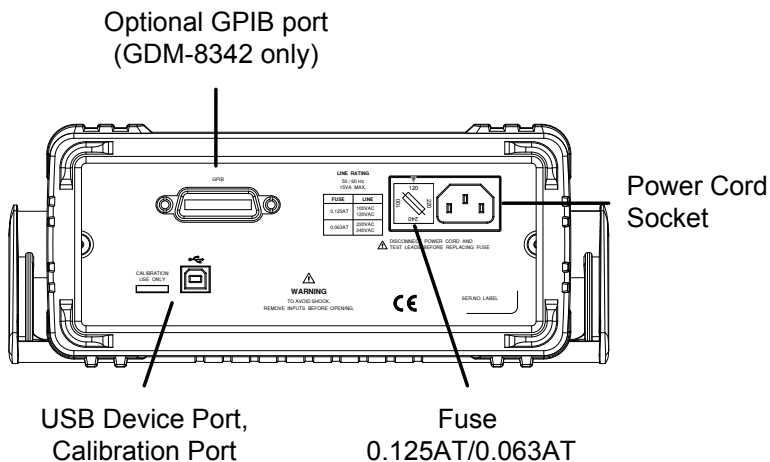

GPIB Port



The GPIB port can be used for remote control. This is a factory installed option for the GDM-8342 only.

Power Cord Socket

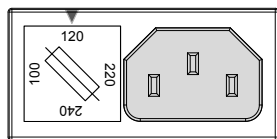

Accepts the power cord. AC 100/120/220/240V ±10%, 50/60Hz

For power on sequence, see page 25.

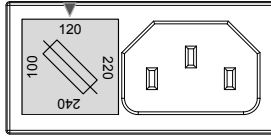
Fuse Socket

Holds the main fuse:

100/120 VAC: 0.125AT
220/240 VAC: 0.063AT

For fuse replacement
details, see page 145.

Calibration Port

CALIBRATION
USE ONLY

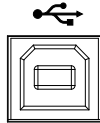

Reserved for calibration purposes.
For service technicians only.

USB Device

Type B USB port. This port is used
for remote control.

Set Up

Tilting the Stand

From the base of the handle, gently pull the handle out sideways and then rotate it to one of the following positions.

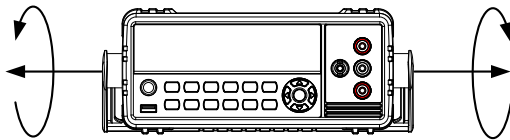

Horizontal position

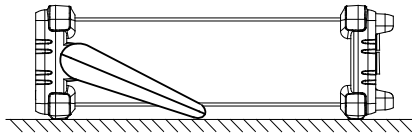

Tilt stand position

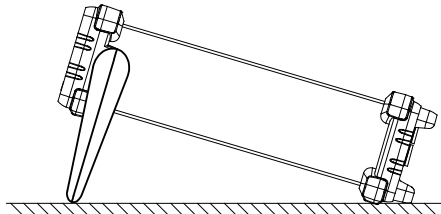

Carry position

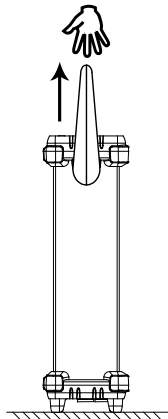

Power Up

Steps

1. Ensure the correct line voltage is lined up with the arrow on the fuse holder. If not, see page 145 to set the line voltage and fuse.

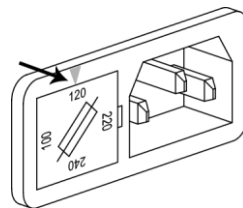

2. Connect the power cord to the AC voltage input.

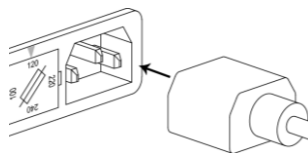

Note

Make sure the ground connector on the power cord is connected to a safety ground. This will influence the measurement accuracy.

3. Push to turn on the main power switch on the front panel.

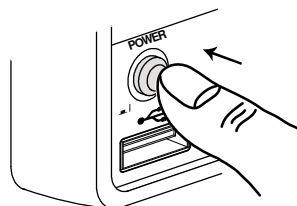

4. The display turns on and shows the last function that was used before the power was reset.

How to Use the Instrument

Background The following section will introduce to you how to access the basic functions on the DMM as well as how to navigate the menu system and edit the parameter values.

Using the Function keys Any of the primary functions can be used by simply pressing the desired function key. For example:
To activate the DCV function, press the DCV key.

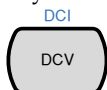

To activate a secondary function, first press the SHIFT key followed by the function key for the secondary function.

For example: To activate DCI measurement, first press the SHIFT key. SHIFT will be highlighted on the display. Next, press the DCV function key. This will activate the DCI mode.

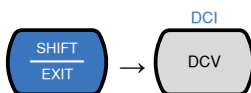

Navigating the Menu System

The menu system is navigated with the Up, Down, Left and Right arrow keys, the Auto/Enter key and the SHIFT/EXIT key.

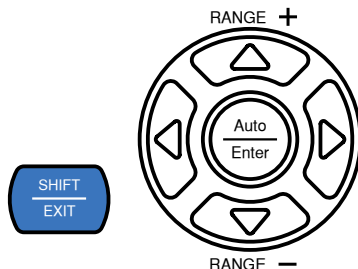

To enter the menu system, press the MENU key. See page 143 for the System Menu tree.



- Pressing the Left and Right arrow keys will navigate to each of the menu items on the current menu level.
- Pressing the Down key will go down to the next level of the menu tree.
- Conversely pressing the Up key will allow you to go back to the previous menu level.
- Pressing Down or Enter on the last item in a menu tree will allow you to edit the settings or parameters for that particular item or setting.
- Pressing the Exit key will allow you to exit from the current settings and return to the previous menu tree level.

Editing a Setting or Parameter

When you access a menu or parameter setting, the Up, Down, Left and Right keys can be used again to edit the parameter as well.

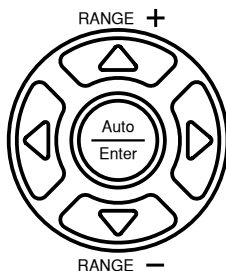

- If a setting or parameter is flashing, it indicates that that particular parameter can be edited.
- Pressing the Left or Right arrow key will allow you to select a digit or character to edit.
- Pressing the Up or Down keys will allow you to edit the selected character.

OPERATION

Basic Measurement Overview	31
Refresh Rate	31
Reading Indicator	32
Automatic/Manual Triggering	32
AC/DC Voltage Measurement	33
Select the Voltage Range	34
Voltage Conversion Table	36
Crest Factor Table	37
AC/DC Current Measurement	38
Select the Current Range	40
Resistance Measurement	43
Select the Resistance Range	44
Diode Test	45
Capacitance Measurement	46
Select the Capacitance Range	47
Continuity Test	48
Set Continuity Threshold	49
Continuity Beeper Settings	50
Frequency/Period Measurement	51
Frequency/Period Settings	52
Temperature Measurement	53
Set the Temperature Units	54
Select Thermocouple Type	55

Set the Reference Junction Temperature 56

Dual Measurement Overview 57
 Supported dual measurement modes 57
 Using Dual Measurement Mode 58

Advanced Measurement Overview 62
 Supported Advanced Measurement Functions 62

dBm/dB/W Measurement 63
 dBm/dB Calculation 63
 Measuring dBm/W 63
 Measure dB 65

Max/Min Measurement 66

Relative Measurement 67

Hold Measurement 69

Compare Measurement 70

Math Measurement 72
 Math Measurement Overview 72
 Measure MX+B 72
 Measure 1/X 73
 Measure Percentage 74

Basic Measurement Overview

Refresh Rate

Background The refresh rate defines how frequently the DMM captures and updates measurement data. A faster refresh rate yields a lower accuracy. A slower refresh rate yields a higher accuracy. Consider these tradeoffs when selecting the refresh rate.

For further details, please see the specifications.

Refresh rate (Reading/S)	Function	S	M	F
	Continuity / Diode	10	20	40
	DCV/DCI/R	5	10	40
	ACV/ACI	5	10	40
	Frequency / Period	1	10	76
	Capacitance	2	2	2

- Steps**
1. Press the left or right arrow keys to change the refresh rate.
 2. The refresh rate will be shown at the top of the display. F ↔ M ↔ S



The refresh rate cannot be set for capacitance measurement.

Reading Indicator

Overview

1. The reading indicator * next to the 1st display flashes according to the refresh rate setting.

0.0078 *^v

Automatic/Manual Triggering

Overview

By default, the GDM-8342/8341 automatically triggers according to the refresh rate. See the previous page for refresh rate setting details. The TRIG key is used to manually trigger acquisition when the trigger mode is set to EXT.

Manual Trigger

1. Press SHIFT+TRIG to toggle the trigger mode to EXT.
2. Press the TRIG key to manually trigger each measurement when in EXT trigger mode.



Note

Manual triggering is not supported for capacitance measurements.

AC/DC Voltage Measurement

The GDM-8342/8341 can measure from 0 to 750VAC or 0 to 1000VDC, however the CATII measurement is only rated up to 600V.

Set to ACV/DCV Measurement

1. Press the DCV or ACV key to measure DC or AC voltage.
For AC + DC voltage, press the ACV and DCV keys at the same time.
2. The mode will switch to AC, DC or AC+DC mode immediately, as shown below.

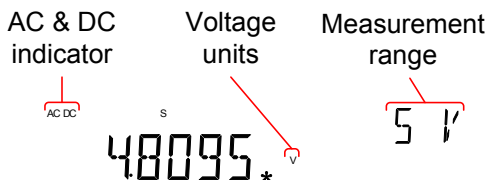

Connection

Connect the test lead between the V and the COM terminal. The display updates the reading.

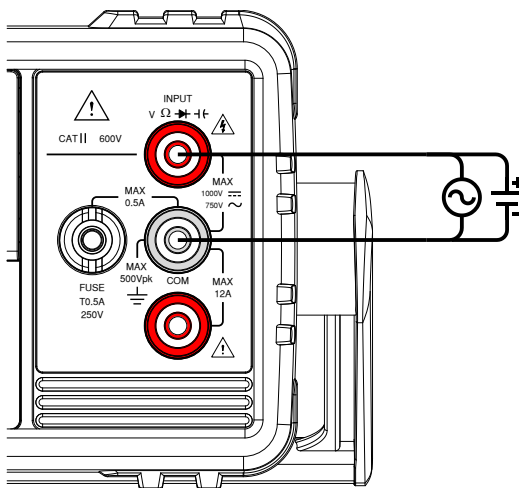

Select the Voltage Range

The voltage range can be set automatically or manually.

Auto Range To turn the automatic range selection On/Off, press the AUTO key.

Manual Range Press the Up or the Down key to select the range. The AUTO indicator turns Off automatically. If the appropriate range is unknown, select the highest range.

Selectable Voltage Ranges

Range	Resolution	Full scale
500mV	10 μ V	510.00mV
5V	0.1mV	5.1000V
50V	1mV	51.000V
500V	10mV	510.00V
750V (AC)	100mV	765.0V
1000V (DC)	100mV	1020.0V



Note

For further details, please see the specifications on page 149.



Note

DC voltages with AC components cannot be accurately measured if the DC+AC component exceeds the dynamic range for the selected DC range. Any voltage exceeding the dynamic range will be clipped at the upper/lower range limit. Under these conditions the range that is chosen with the Auto range function may be too small.

For example:

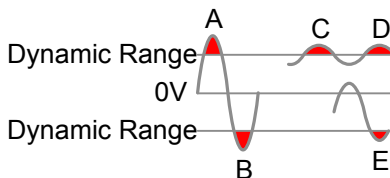

A,B: Input exceeds the dynamic range.

C,D: The DCV offset causes the input to exceed the upper dynamic range.

E: The DCV offset causes the input to exceed the lower dynamic range.







The DC voltage range should be manually selected when all of the following conditions are true:

- When DCV measurement is used.
- When the signals being measured contain both DC and AC components.
- When the amplitude of the AC component in the measured signal is higher or lower than the dynamic range of the range being currently selected by the auto-range function.

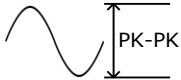
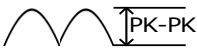
Maximum DCV Dynamic Range	Selected DCV Range	Dynamic Range
	DC 500mV	±600mVmax
	DC 5V	±6Vmax
	DC 50V	±60Vmax
	DC 500V	±600Vmax
	DC 1000V	±1000Vmax

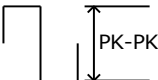
Voltage Conversion Table

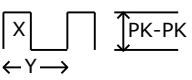
This table shows the relationship between an AC and DC reading for various waveforms.









Waveform	Peak to Peak	AC (True RMS)	DC
Sine 	2.828	1.000	0.000
Rectified Sine (full wave) 	1.414	0.435	0.900
Rectified Sine (half wave) 	2.000	0.771	0.636
Square 	2.000	1.000	0.000
Rectified Square 	1.414	0.707	0.707
Rectangular Pulse 	2.000	$2K$ $K = \sqrt{(D - D^2)}$ $D = X/Y$	$2D$ $D = X/Y$
Triangle Sawtooth 	3.464	1.000	0.000

Crest Factor Table

Background Crest factor is the ratio of the peak signal amplitude to the RMS value of the signal. It determines the accuracy of AC measurement.

If the crest factor is less than 3.0, voltage measurement will not result in error due to dynamic range limitations at full scale.

If the crest factor is more than 3.0, it usually indicates an abnormal waveform as seen from the below table.

Crest Factor Table	Waveform	Shape	Crest factor
	Square wave		1.0
	Sine wave		1.414
	Triangle sawtooth		1.732
	Mixed frequencies		1.414 ~ 2.0
	SCR output 100% ~ 10%		1.414 ~ 3.0
	White noise		3.0 ~ 4.0
	AC Coupled pulse train		>3.0
	Spike		>9.0

AC/DC Current Measurement

The GDM-834X series DMMs have two input terminals for current measurement. A 0.5A terminal for current less than 0.5A and a 10A terminal for measurements up to 12A.

The units can measure 0 ~ 10A for both AC and DC current.

Set to ACI/DCI Measurement

1. Press SHIFT → DCV or SHIFT → ACV to measure DC or AC current, respectively.

For AC+DC current, press SHIFT followed by both the DCV and ACV key at the same time.

2. The mode will switch to AC, DC or AC+DC mode immediately, as shown below.

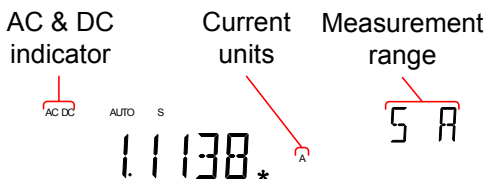

Connection

Connect the test lead between the 10A terminal and the COM terminal or DC/AC 0.5A terminal and the COM terminal, depending on the input current.

For current $\leq 0.5A$ use the 0.5A terminal; For current up to 12A use the 10A terminal. The display updates the reading.

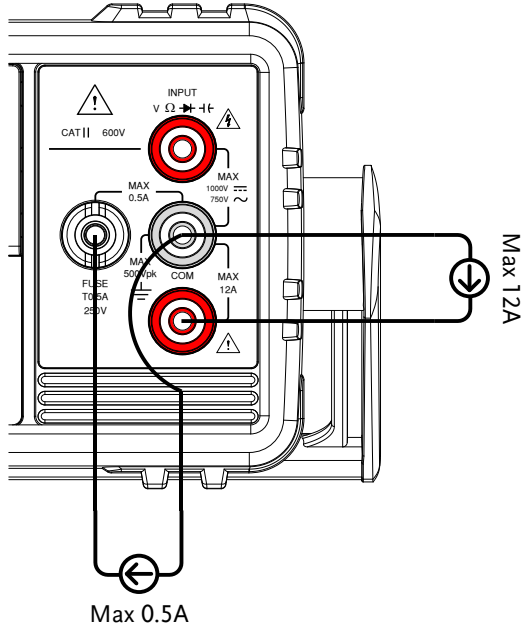

Select the Current Range

The current range can be set automatically or manually.

Auto Range To turn the automatic range selection On/Off, press the AUTO key. The most appropriate range for the currently used input jack will be automatically selected. The DMM is able to do this by remembering the last manually selected range and using that information to determine the smallest current range that the auto-range function will switch to.

When the current input is switched to another terminal, the range must be manually set.

Manual Range Press the Up or the Down key to select the range. The AUTO indicator turns Off automatically. If the appropriate range is unknown, select the highest range.

Selectable Current Ranges	Range	Resolution	Full scale	INJACK
	500 μ A	10nA	510.00 μ A	500mA
	5mA	100nA	5.1000mA	500mA
	50mA	1 μ A	51.000mA	500mA
	500mA	10 μ A	510.00mA	500mA
	5A	100 μ A	5.1000A	12A
	10A	1mA	12.000A	12A

 **Note**

For further details, please see the specifications on page 149.



Note

DC currents with AC components cannot be accurately measured if the DC+AC component exceed the dynamic range for the selected DC range. Any current exceeding the dynamic range will be clipped at the upper/lower range limit. Under these conditions the range that is chosen with the Auto range function may be too small.

For example:

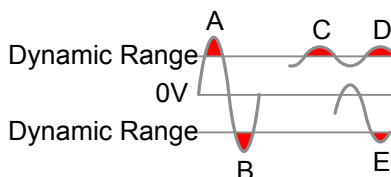

A,B: Input exceeds the dynamic range.

C,D: The DCI offset causes the input to exceed the upper dynamic range.

E: The DCI offset causes the input to exceed the lower dynamic range.

The DC current range should be manually selected when all of the following conditions are true:

- When DCI measurement is used.
- When the signals being measured contain both DC and AC components.
- When the amplitude of the AC component in the measured signal is higher or lower than the dynamic range of the range being currently selected by the auto-range function.

Maximum DCI Dynamic Range	Selected DCV Range	Dynamic Range
	DC 500 μ A	$\pm 600\mu\text{Amax}$
	DC 5mA	$\pm 6\text{mAmax}$
	DC 50mA	$\pm 60\text{mAmax}$
	DC 500mA	$\pm 600\text{mAmax}$
	DC 5A	$\pm 6\text{Amax}$
	DC 10A	$\pm 12\text{Amax}$

Resistance Measurement

Set to Ω Measurement

1. Press the Ω/\rightarrow key to activate resistance measurement.
Note: pressing the Ω/\rightarrow key twice will activate continuity measurement instead.
2. The mode will switch to resistance mode immediately, as shown below.

Display

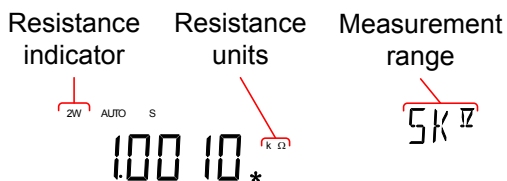

Connection

The GDM-8342/8341 uses 2-wire resistance measurement.
Connect the test leads between the $V\Omega \rightarrow \rightarrow$ terminal and the COM terminal.

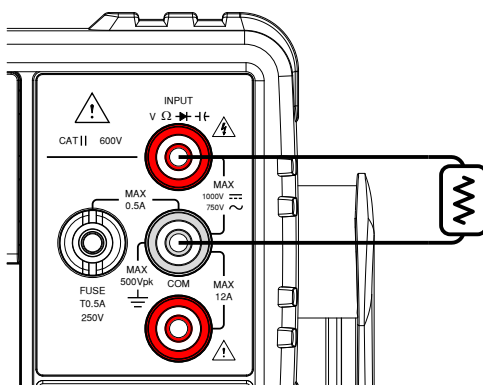

Select the Resistance Range

The resistance range can be set automatically or manually.

Auto Range	To turn the automatic range selection On/Off, press the AUTO key.
------------	---

Manual Range	Press the Up or the Down key to select the range. The AUTO indicator turns Off automatically. If the appropriate range is unknown, select the highest range.
--------------	--

Selectable Resistance Ranges	Range	Resolution	Full scale
	500Ω	10mΩ	510.00Ω
	5kΩ	100mΩ	5.1000kΩ
	50kΩ	1Ω	51.000kΩ
	500kΩ	10Ω	510.00kΩ
	5MΩ	100Ω	5.1000MΩ
	50MΩ	1kΩ	51.000MΩ



Note

For further details, please see the specifications on page 152.

Diode Test

The diode test checks the forward bias characteristics of a diode by running a constant forward bias current of approximately 0.83mA through the DUT.

Set to Diode Measurement

1. Press the \rightarrow/\leftarrow key once to activate diode measurement.
Note: pressing the \rightarrow/\leftarrow key twice will activate the capacitance measurement instead.
2. The mode will switch to Diode mode immediately, as shown below.

Display

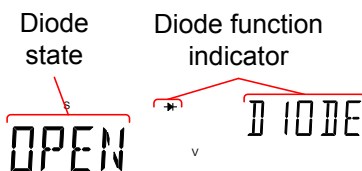

Connection

Connect the test lead between the V Ω \rightarrow/\leftarrow terminal and COM terminal; Anode-V, Cathode-COM. The display updates the reading.

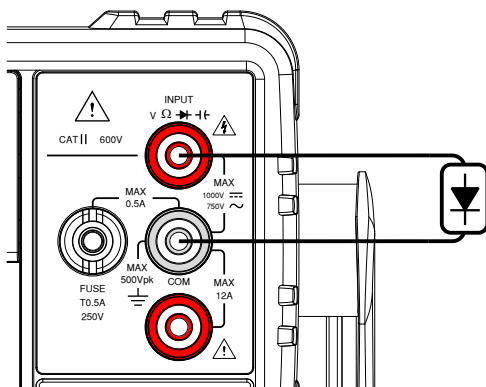

Capacitance Measurement

The capacitance measurement function checks the capacitance of a component.

Set to
Capacitance
Measurement

1. Press the \rightarrow/\leftarrow key twice to activate capacitance measurement.
Note: pressing the \rightarrow/\leftarrow key once will activate the diode measurement instead.
2. The mode will switch to capacitance mode immediately, as shown below.

Display

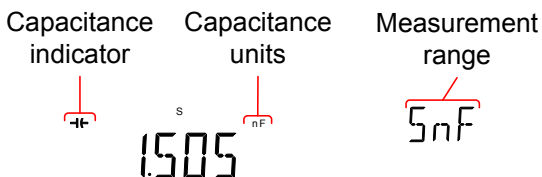

Connection

Connect the test lead between the V Ω \rightarrow/\leftarrow terminal and COM terminal; Positive-V, Negative-COM. The display updates the reading.

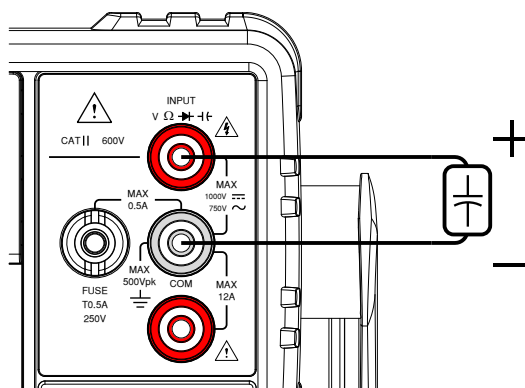

Select the Capacitance Range

The capacitance range can be set automatically or manually.

Auto Range	To turn the automatic range selection On/Off, press the AUTO key.
------------	---

Manual Range	Press the Up or the Down key to select the range. The AUTO indicator turns Off automatically. If the appropriate range is unknown, select the highest range.
--------------	--

Selectable Capacitance Ranges	Range	Resolution	Full scale
	5nF	1pF	5.100nF
	50nF	10pF	51.00nF
	500nF	100pF	510.0nF
	5 μ F	1nF	5.100 μ F
	50 μ F	10nF	51.00 μ F



Note

For further details, please see the specifications on page 152.



Note

The refresh rate settings and the EXT trigger cannot be used in the capacitance mode.

Continuity Test

The continuity test checks that the resistance in the DUT is low enough to be considered continuous (of a conductive nature).

- Procedure
1. Press the $\Omega/\cdot\cdot\cdot$ key *twice* to activate continuity testing.
 2. The mode will switch to continuity testing immediately, as shown below.

Display

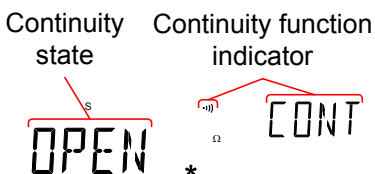

Connection

Connect the test lead between the $V\Omega \rightarrow \rightarrow$ terminal and COM terminal. The display updates the reading.

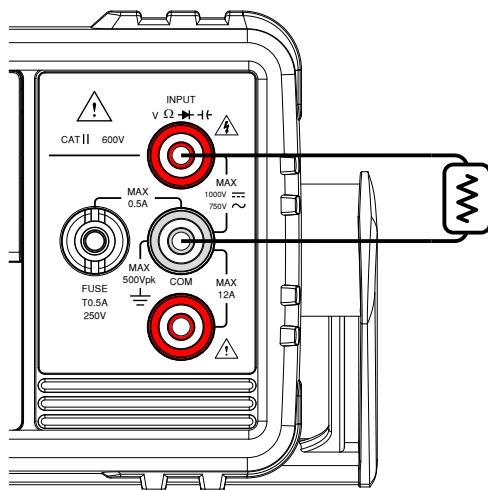

Set Continuity Threshold

The continuity threshold defines the maximum resistance allowed in the DUT when testing the continuity.

Range	Threshold	0 to 1000 Ω (Default Threshold: 10 Ω)
	Resolution	1 Ω

- Procedure
1. Press MENU.
 2. Go to the MEAS menu on level 1
 3. Go to the CONT menu on level 2
 4. Set the continuity threshold level.
 5. Press the Enter key to confirm the continuity settings.
 6. Press EXIT to exit the CONT setting menu.

Display

Continuity setting Continuity function indicator

CNT:00 10 Ω CONT

Continuity Beeper Settings

The beeper setting defines how the GDM-8342/8341 notifies the continuity test result to the user.

Note: When the Beeper setting is off it will also turn off the keypad tones as well as any error or warning tones.

Range	PASS	Beeps when the continuity passes.
	FAIL	Beeps when the continuity fails.
	OFF	Beeper is turned off.

- Procedure
1. Press MENU.
 2. Go to the SYSTEM menu on level 1
 3. Go to the BEEP menu on level 2
 4. Set the BEEP setting to PASS, FAIL or OFF.
 5. Press the AUTO/ENTER key to confirm the beeper settings.
 6. Press EXIT to exit the BEEP setting menu.

Display

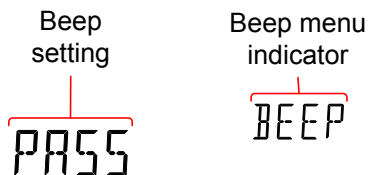

Frequency/Period Measurement

The GDM-8342/8341 can be used to measure the frequency or period of a signal.

Range	Frequency	10Hz~1MHz
	Period	1.0 μ s ~100ms

Procedure

To measure frequency, press the Hz/P key once. The frequency will be displayed on the primary screen and the range will be displayed on the secondary display.

To measure the period, press the Hz/P key twice. The period will be displayed on the primary screen and the range will be displayed on the secondary display.

Display

Frequency or Voltage/Current Measurement period units range setting

Connection

Connect the test lead between the V Ω \rightarrow \leftarrow terminal and the COM terminal. The display updates the reading.

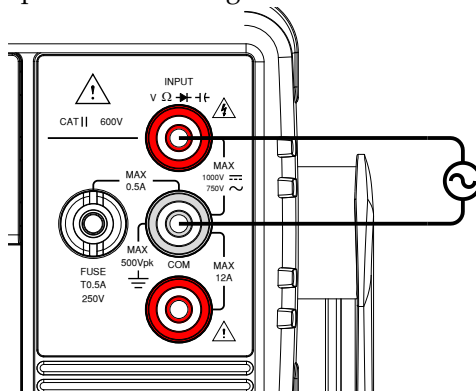

Frequency/Period Settings

The input voltage/current range for frequency/period measurements can be set to Auto range or to manual. By default, the voltage/current range is set to Auto for both the period and frequency.

Range	Voltage	500mV, 5V, 50V, 500V, 750V
	Current	500 μ A, 5mA, 50mA, 500mA, 5A, 10A



Note

The input jack setting determines whether the voltage frequency/period or current frequency/period is being measured. See page 80 for details.

Manual Range

1. Set the range with the Up and Down keys. The AUTO indicator will turn off when a new range is selected.

Autorange

1. Press the Auto/Enter key.
2. AUTO will be displayed on the screen again.

Display

Autorange indicator

Voltage/Current range setting

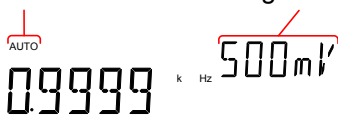

Note

The 2nd key can be used to toggle the view of the second display between the voltage/current range and the menu function (FREQ or PERIOD).

Note that the voltage/current range can actually still be set even when the secondary display has been toggled to show the menu function.

Temperature Measurement

The GDM-8342 can measure temperature using a thermocouple. To measure temperature, the DMM accepts a thermocouple input and calculates the temperature from the voltage fluctuation. The thermocouple type and reference junction temperature are also considered. Temperature measurement is only supported on the GDM-8342.

Range Thermocouple: -200°C ~ +300°C

Procedure To make temperature measurements, press SHIFT → Hz/P (TEMP). The temperature mode appears showing the temperature on the primary display and the type of sensor on the secondary display.

Display

Temp.
Measurement units Sensor type

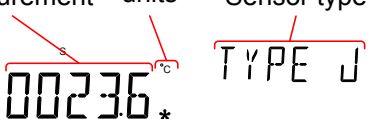

Connection Connect the sensor lead between the VΩ → terminal and the COM terminal. The display updates the reading.

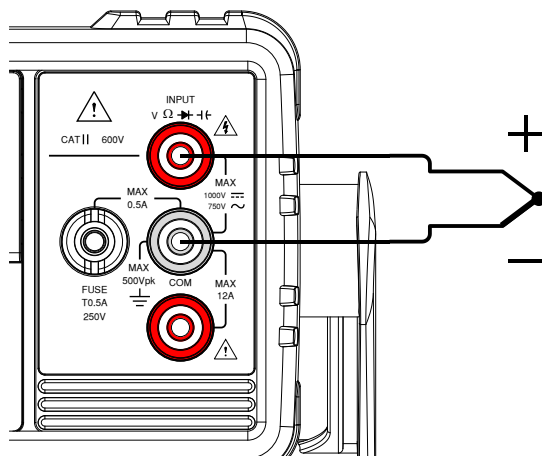

Set the Temperature Units

Range	Units	°C, °F
Procedure	<ol style="list-style-type: none"> 1. Press the MENU key. 2. Go to TEMP on level 1. 3. Go to UNIT on level 2. 4. Select either C (Celsius) or F (Fahrenheit). 5. Press the Enter key to confirm. 6. Press the EXIT key to exit from the temperature menu. 	
Display	<p>Temperature unit setting</p>	<p>Unit menu indicator</p>

Select Thermocouple Type

The GDM-8342 accepts thermocouple inputs and calculates the temperature from the voltage difference of two dissimilar metals. Thermocouple type and reference junction temperature are also considered.

Thermocouple type and range	Type	Measurement Range	Resolution
	J	-200 to +300 °C	0.1 °C
	K	-200 to +300 °C	0.1 °C
	T	-200 to +300 °C	0.1 °C

- Procedure
1. Press the MENU key.
 2. Go to TEMP on level 1.
 3. Go to SENSOR on level 2.
 4. Select the thermocouple type (J, K, T).
 5. Press the Enter key to confirm.
 6. Press the EXIT key to exit from the temperature menu.

Display

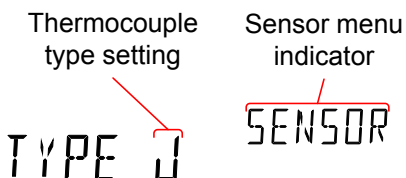

Set the Reference Junction Temperature

When a thermocouple is connected to the DMM, the temperature difference between the thermocouple lead and the DMM input terminal should be taken into account and be cancelled out; otherwise an erroneous temperature might be added. The value of the reference junction temperature should be determined by the user.

Range	SIM	0 ~ 50°C (default: 23.00°C)
	Resolution	0.01°C

- | | |
|-----------|---|
| Procedure | <ol style="list-style-type: none"> 1. Press the MENU key. 2. Go to TEMP on level 1. 3. Go to SIM on level 2. 4. Set the SIM (simulated) reference junction temperature. 5. Press the Enter key to confirm. 6. Press the EXIT key to exit from the temperature menu. |
|-----------|---|

Display

Reference junction
temperature setting

21.20

SIM menu
indicator

SIM

Dual Measurement Overview

The dual measurement mode allows you to use the 2nd display to show another item, thus viewing two different measurement results at once.

When the multimeter is used in dual measurement mode, both displays are updated from either a single measurement or from two separate measurements. If the primary and secondary measurement modes have the same range, rate and rely on the same fundamental measurement, then a single measurement is taken for both displays; such as ACV and frequency/period measurements. If the primary and secondary displays use different measurement functions, ranges or rates, then separate measurements will be taken for each display. For example, ACV and DCV measurements.

Most of the basic measurement functions, except for resistance/continuity can be used in the dual measurement mode.

Supported dual measurement modes

The following table lists all the measurement functions that are supported with the dual measurement function.

Supported Dual Measurement modes	Primary Display	Secondary Display					
		ACV	DCV	ACI	DCI	Hz/P	Ω
ACV		●	●	●	●	●	X
DCV		●	●	●	●	X	X
ACI		●	●	●	●	●	X
DCI		●	●	●	●	X	X
Hz/P		●	X	●	X	●	X
Ω		X	X	X	X	X	●

Using Dual Measurement Mode

Procedure

1. Choose one of the basic measurement functions from the table above to set the measurement mode for the primary display.

For example, press DCV to set the first display to DCV measurement.

2. To set a measurement mode for the second display, press the 2ND key and then select the second measurement mode.

For example, press 2ND, SHIFT, ACV to select ACI measurement for the second display.

Display

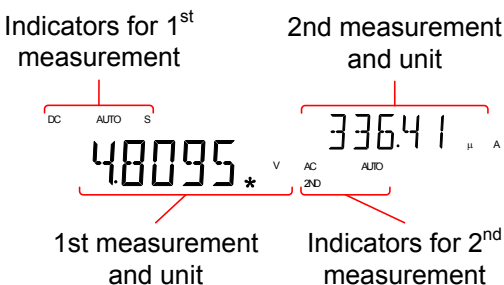

Editing the Measurement Parameters	<p>After the secondary measurement function has been activated, the rate, range and measurement item can be edited for either the primary or secondary display. Note however, it is more practical to configure the first or second measurement items before activating dual measurement mode.</p> <p>To edit measurement parameters in dual measurement mode, you must first set which display is the <i>active</i> display. The 2ND icon under the secondary display determines which display is the active display.</p>
Procedure	<ol style="list-style-type: none"><li data-bbox="386 630 993 933">1. Toggle whether the primary or secondary display is the active display by pressing the 2ND key: Primary display is the active display: 2ND <i>is not</i> visible on the display. Secondary display is the active display: 2ND <i>is</i> visible on the display.
 Note	<p>Do not hold the 2ND key. This will turn the dual measurement mode off.</p> <ol style="list-style-type: none"><li data-bbox="386 1061 993 1197">2. Edit the range, rate or measurement item for the active display in the same way as for single measurement operation. See the Basic Measurement chapter for details (page 31).
Turn Off 2nd Measurement	<p>To turn Off the 2nd measurement, press and hold the 2nd key for more than 1 second.</p>

Connection

The diagrams below describe how to connect the DMM to measure a number of common dual measurement items.

Voltage and Frequency/Period measurement

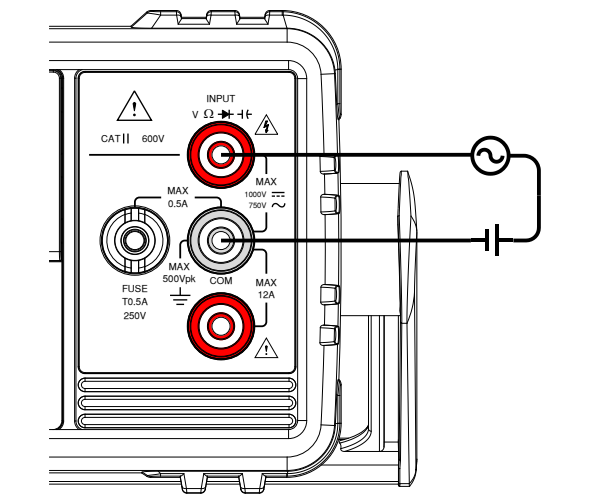

Voltage/Frequency/Period and Current Measurement

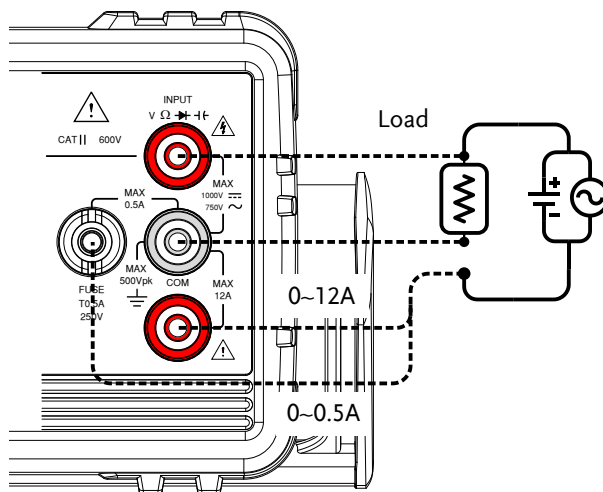

Note: DC Current measurements will be displayed as a negative value as the polarity of the current leads has been reversed.

Please take into account the resistance of the test leads and internal resistance of the current connection as it is in series with the test circuit.

The above measuring configuration is used to measure the voltage present on the resistance under test and the current through the resistance under test when using the DCI/DCV or ACI/ACV dual measurement function.

Advanced Measurement Overview

Advanced measurement mainly refers to the type of measurement which uses the result obtained by one of the basic measurements: ACV, DCV, ACI, DCI, Resistance, Diode/Continuity, Frequency/Period, and Temperature*.

Supported Advanced Measurement Functions

The following table lists all the advanced measurement functions and which of the basic measurement functions that they support.

Advanced Meas.	Basic Measurement						
	ACV/DCV	ACI/DCI	Ω	Hz/P	TEMP*	DIODE	CAP
dB	●	X	X	X	X	X	X
dBm	●	X	X	X	X	X	X
Max/Min	●	●	●	●	●	X	●
Relative	●	●	●	●	●	X	●
Hold	●	●	●	●	●	X	X
Compare	●	●	●	●	●	X	●
Math	●	●	●	●	●	X	X

*Temperature measurement is not supported by the GDM-8341.

dBm/dB/W Measurement

dBm/dB Calculation

Overview Using the ACV or DCV measurement results, the DMM calculates the dB or dBm value based on a reference resistance value in the following way:

$$\text{dBm} = 10 \times \log_{10} (1000 \times V_{\text{reading}}^2 / R_{\text{ref}})$$

$$\text{dB} = \text{dBm} - \text{dBm}_{\text{ref}}$$

$$W = V_{\text{reading}}^2 / R_{\text{ref}}$$

Where:

V_{reading} = Input Voltage, ACV or DCV;

R_{ref} = Reference resistance simulating an output load;

dBm_{ref} = Reference dBm value

Measuring dBm/W

- Procedure
1. Select ACV or DCV measurement. See page 33.
 2. To measure dBm, press SHIFT → \blackrightarrow \blackleftarrow .

The primary display will show the dBm measurement while the secondary display shows the reference resistance.

Display

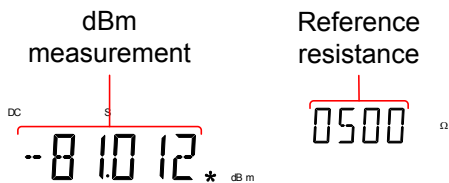

Setting the Reference Resistance

To set the reference resistance, use the Up and Down arrow keys.

The selectable reference resistances are shown below.

Selectable reference resistances

2	4	8	16	50	75	93
110	124	125	135	150	250	300
500	600	800	900	1000	1200	8000

View the result in Watts

When the reference resistance is less than 50Ω, it is possible to calculate the power (in watts). If the reference resistance is equal to or greater than 50Ω, then this step can be ignored.

Press SHIFT → → ← again to view the result in watts.

Display

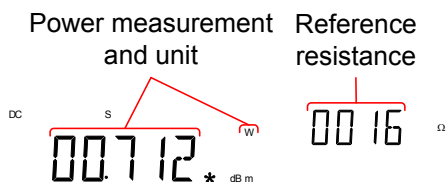

Exit dBm Measurement

Press SHIFT → → ← again to exit the dBm measurement, or simply activate another measurement function.

Measure dB

dB is defined as [dBm-dBmref]. When the dB measurement is activated, the DMM calculates the dBm using the reading at the first moment and stores it as dBmref.

- Procedure
1. Select ACV or DCV measurement. See page 33.
 2. Press SHIFT → Ω/•) key to activate the dB measurement mode.

The 1st display shows the dB reading the second display shows the voltage reading.

Display

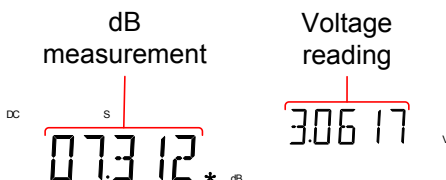

View the dBm Reference Value

To view the dBm reference value, press the 2ND key.

The Up and Down arrow keys can also be used to change the voltage range or the reading.

Exit dB Measurement

Press the SHIFT → Ω/•) key again to exit the dB measurement, or simply activate another measurement function.

Max/Min Measurement

Maximum and Minimum measurement function stores the highest (maximum) or lowest (minimum) reading and shows it on the 1st display when the 2ND key is pressed.

Applicable measurements

The Max/Min function can be used with the following basic measurement functions: ACV, DCV, ACI, DCI, Ω , Hz/P, TEMP, \pm

Procedure

For Max measurement, press the MX/MN key once.
 For Min measurement, press the MX/MN key twice.

Display



View Max/Min Value

Press the 2ND key to view the Max or Min value.

Display



Deactivate Max/Min Measurement

Hold the MX/MN key for two seconds to deactivate, or simply activate another measurement function.

Relative Measurement

Relative measurement stores a value, typically the data at that instant, as the reference. The measurement following the reference is displayed as the delta between the reference. The reference value will be cleared upon exit.

Applicable measurements

The relative function can be used with the following basic measurement functions: ACV, DCV, ACI, DCI, Ω , Hz/P, TEMP, \pm

Procedure

Press the REL key. The measurement reading at that instant becomes the reference value.

Display

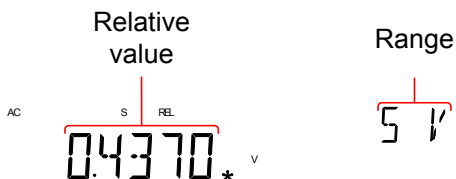

View Relative Reference Value

Press the 2ND key to view the relative reference value at full scale.

Display

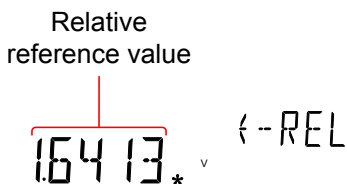

Manually Set the Relative Reference Value

1. To manually set the relative reference value, press SHIFT → REL.

The REL value is displayed on the screen at full scale.

2. Use the Left and Right arrow keys to navigate to the digit to be edited or to select the decimal point.

Use the Up and Down arrow keys to edit the selected digit or to place the position of the decimal point.



3. Press the Enter key to confirm, alternatively press Exit to cancel setting the relative reference value.

Display

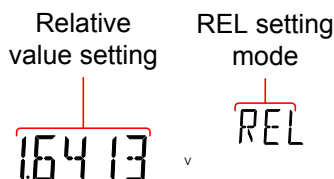

Deactivate Relative Measurement

Press the REL key again to deactivate the Relative measurement mode, or simply activate another measurement function.

Hold Measurement

The Hold Measurement function retains the current measurement data and updates it only when it exceeds the set threshold (as a percentage of the retained value).

Applicable measurements

The hold function can be used with the following basic measurement functions: ACV, DCV, ACI, DCI, Ω , Hz/P, TEMP

Procedure

1. Press the HOLD key.
2. The measurement reading appears on the primary display and the hold threshold on the secondary display.

Display

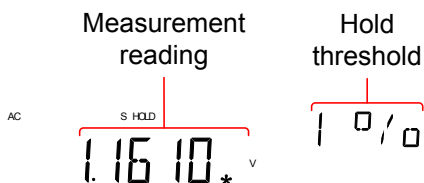

Set the Hold Threshold

Use the Up and Down arrow keys to select a hold threshold level, as a percentage.

Range 0.01%, 0.1%, 1%, 10%

Deactivate Hold Measurement

Press the HOLD key for 2 seconds to deactivate the hold measurement, or simply activate another measurement function.

Compare Measurement

Compare measurement checks to see if the measurement data stays between a specified upper (high) and lower (low) limit.

Applicable measurements The compare function can be used with the following basic measurement functions:
ACV, DCV, ACI, DCI, Ω , Hz/P, TEMP, \pm

- Procedure
1. Press SHIFT → HOLD.
 2. The high limit setting appears.

Use the Left and Right arrow keys to navigate to the digit to be edited, or to select the decimal point.

Use the Up and Down arrow keys to edit the selected digit, or to place the position of the decimal point.

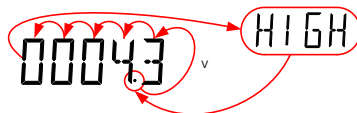

3. Press the Enter key to save the high limit setting and automatically go on to the low limit setting.
4. Enter the low limit setting in the same fashion as the high setting.
5. Press the Enter key to confirm the low limit settings.
6. The compare measurement results will appear immediately:

If the current measurement reading is between

the high and low limits, PASS will be displayed on the secondary display, If the reading is below the low limit, LOW will be displayed. If the reading is above the high limit, HIGH will be displayed.

Display

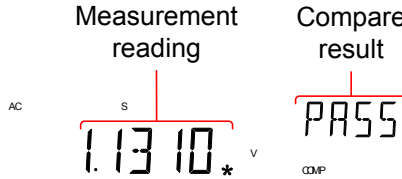

Deactivate
Compare
Measurement

Press SHIFT → HOLD to deactivate compare measurements, or simply activate another measurement function.

Math Measurement

Math Measurement Overview

Math measurement runs three types of mathematical operations, MX+B, 1/X and Percentage based on the other measurement results.

Applicable Measurements	The math function can be used with the following basic measurement functions: ACV, DCV, ACI, DCI, Ω, Hz/P, TEMP	
Overview of Math Functions	MX+B	Multiplies the reading (X) by the factor (M) and adds/subtracts offset (B).
	1/X	Inverse. Divides 1 by the reading (X).
	Percentage	Runs the following equation: $\frac{(\text{Reading}X - \text{Reference})}{\text{Reference}} \times 100\%$

Measure MX+B

- Procedure
1. Press SHIFT → MX/MN to enter the MATH menu.

The MX+B setting appears. The M factor will be flashing, indicating that the M factor is to be set.
 2. Use the Left and Right arrow keys to navigate to the digit to be edited or to select the decimal point.

Use the Up and Down arrow keys to edit the selected digit or to place the position of the

decimal point.

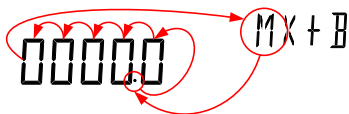

3. Press Enter to confirm the M factor settings and to automatically move onto the B offset setting.
4. Edit the B offset in the same fashion as the M factor was edited.
5. Press Enter to confirm the B offset setting and to begin the MX+B measurement.

Display

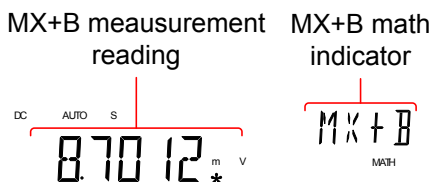

Deactivate Math Measurement

Press SHIFT → MX/MN to deactivate the MATH function, or simply activate another measurement function.

Measure 1/X

Procedure

1. Press SHIFT → MX/MN to enter the MATH menu.

The MX+B setting appears.

2. Press the Down key twice to skip past MX+B settings and go to the 1/X settings.

1/X will be flashing in the secondary display.

INVERSE 1/X

3. Press Enter to activate the 1/X math function. The results begin immediately.

Display

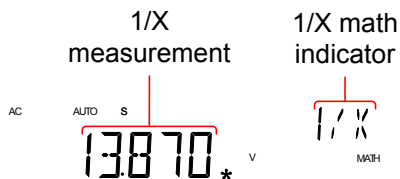

Deactivate Math Measurement

Press the SHIFT → MX/MN to deactivate the MATH function, or simply activate another measurement function.

Measure Percentage

Procedure

1. Press SHIFT → MX/MN to enter the MATH menu.
2. The MX+B setting appears. Press the Up key to skip past MX+B settings and go to the REF% settings.

REF% will be flashing in the secondary display.

3. Use the Left and Right arrow keys to navigate to the digit to be edited or to select the decimal point.

Use the Up and Down arrow keys to edit the selected digit or to place the position of the decimal point.

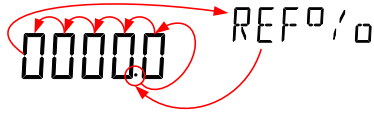

4. Press Enter to confirm the REF% setting and to begin the Percentage measurement.

Display

Calculated percentage measurement

% function indicator



Deactivate Math Measurement

Press SHIFT → MX/MN to deactivate the MATH function, or simply activate another measurement function.

SYSTEM/DISPLAY CONFIGURATION

View Serial Number.....	77
View Version Number.....	77
Brightness Settings	78
Input Resistance Settings.....	79
Frequency/Period Input Jack Settings	80
Compatibility Settings	81
Changing the Compatibility Setting	81
Restore Factory Default Settings.....	82

View Serial Number

- Procedure
1. Press the MENU key.
 2. Go to SYSTEM on level 1.
 3. Go to S/N on level 2.
 4. The serial number will be displayed across both the primary and secondary display.

Display



Exit

Press the EXIT key twice to go back to the measurement screen.

View Version Number

- Procedure
1. Press the MENU key.
 2. Go to SYSTEM on level 1.
 3. Go to VER on level 2.
 4. The firmware version number will be displayed in the secondary display.
 5. Press Exit to exit from the version menu.

Display



Firmware updates can only be performed by a GW Instek service technician. For details, please contact the GW Instek Service Center or visit the GW Instek website at www.gwinstek.com.

Brightness Settings

The display has 5 settable brightness levels.

Range	Brightness
-------	------------

1 (dim) ~ 5 (bright)

Procedure

1. Press the MENU key.
2. Go to SYSTEM on level 1.
3. Go to LIGHT on level 2.
4. Set the light setting between 1 (dim) and 5 (bright).
5. Press the Enter key to confirm.
6. Press the EXIT key to exit from the brightness settings.

Display

Brightness setting

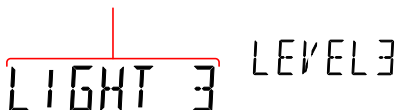

LIGHT 3 LEVEL 3

Input Resistance Settings

The 500mV and 5V DC voltage ranges can be set to an input resistance of 10M Ω or 10G Ω . This setting is only applicable for DC voltage.

Range	Input resistance	10M Ω , 10G Ω
	Default	10M Ω

- Procedure
1. Press the MENU key.
 2. Go to MEAS on level 1.
 3. Go to INPUT R on level 2.
 4. Set the input resistance to 10M Ω or 10G Ω
 5. Press the Enter key to confirm.
 6. Press the EXIT key to exit from the input resistance menu.

Display

Input resistance
setting



10G

INPUT

Frequency/Period Input Jack Settings

The INJACK settings set which input terminal is used for frequency or period measurements.

Range	Injack	VOLT, 500mA, 10A
	Default	VOLT

- Procedure
1. Press the MENU key.
 2. Go to MEAS on level 1.
 3. Go to INJACK on level 2.
 4. Set the INJACK setting to either VOLT, 500mA or 10A.
 5. Press the Enter key to confirm.
 6. Press the EXIT key to exit from the INJACK menu.

Display INJACK setting

VOLT

INJACK

Compatibility Settings

Changing the Compatibility Setting

The GDM-8341/8342 can be set to a special compatibility mode that will allow the unit to emulate the SCPI command syntax of the GDM-8246 when in remote control mode. For example, this feature can allow programs that were originally written for the GDM-8246 to run on the GDM-8342/8341 with little modification.

Range	LANG	NORM, COMP
Procedure	<ol style="list-style-type: none"> 1. Press the MENU key. 2. Go to SYSTEM on level 1. 3. Go to LANG on level 2. 4. Set the LANG setting to either NORM (normal mode) or COMP (compatibility mode). 5. Press the Enter key to confirm. 6. Press the EXIT key to exit from the LANG menu. 	
Display	LANG setting	

LANG

Restore Factory Default Settings

The factory default settings can be restored at anytime from the System menu. Please see the Appendix on page 144 for a list of the factory default settings.

Range	Factory DEF	YES, NO
Procedure	<ol style="list-style-type: none"> 1. Press the MENU key. 2. Go to SYSTEM on level 1. 3. Go to FACTORY on level 2. 4. Set the (FACTORY) DEF setting to YES or NO. Choosing YES will restore the factory default settings. 5. Press the Enter key to confirm and to restore the factory default settings immediately. 	

Display Factory default setting



U SB STORE

The GDM-8342 is able to save/log measurement results to a USB stick.

Please note that this function is not available for the GDM-8341, however similar functionality is possible on a PC via remote control using the Excel Add-In, GDM-834x Excel Addins. See the GDM-834X Series Excel Add-In manual for details.

USB Store Overview	84
Supported USB Sticks:.....	84
CSV Format	84
Filename Format.....	85
Operator Mode	86
Long Record Mode.....	88
View the Store Function Status	89
Set the Starting File Name (Available only in Advance Mode)	91
Save Count (Available only in Advance Mode)	91
Save to an Existing File (Available only in Advance Mode)	92
Time Mode (Available only in Advance Mode)	93
Timer	93
Date	95
Save to USB.....	96
Save to USB (Simple Mode).....	96
Save to USB (Advance Mode)	97
Note About Deleting Files or Directories on the USB Stick	99

USB Store Overview

The GDM-8342 is able to store measurement results to a USB stick. The USB storage function also has comprehensive save options that allow you to create a save file name, allow you to save up to a specified number of reading counts as well as the option to continue saving to a previously stored file instead of saving to a new file.

Supported USB Sticks:

USB Disk Type: Flash Disk Only

FAT Format: Fat16 or Fat32(Recommended)

Max memory size: 32GB

Max record count in a recording: 5,000,000 records



Note

Flash disks which need to use card adaptors are not recommended to be used in this application.

CSV Format

Overview	The GDM-8342 saves readings as a CSV file (comma separated values) that can be easily read using spreadsheet programs such as Microsoft Excel. Each CSV file saves the following information.	
Parameters	Time (dd)	The elapsed number of days since the start of the readings.
	Time (hh:mm:ss)	The elapsed time since the start of the readings, in hours:minutes:seconds formatting.
	1st Value	The reading on the primary display.

1st Unit	The units for the reading on the primary display.
2nd Value	The reading on the secondary display.
2nd Unit	The units for the reading on the secondary display.
Count	Counts the number of readings each time the measurement is started. The count is restarted each time measurement is restarted. When a measurement is started/restarted, the first count is marked as #START#, the last as #END#.
Note	Records the accumulative number of readings that are recorded in that file, up to the maximum of 50,000.

Example:

Time(dd)	Time (hh:mm:ss)	1st Value	1st Unit	2nd Value	2nd Unit	Count	Note
0	0:00:05	0.00E+00	V DC	--	--	#START#	00001#
0	0:00:06	0.00E+00	V DC	--	--	2	00002#
0	0:00:06	0.00E+00	V DC	--	--	#END#	00003#

Filename Format

Overview

When files are saved to USB they are saved as a number starting from GW000\GW000-XX.CSV and are automatically incremented for each new CSV file*. For example: the first file will be named, GW000\GW000-XX.CSV, the next GW001\GW001-XX.CSV and so on.

Note that the suffix, XX, represents a number from 00 to 99. Each time the system logs more than 50000 readings in total*, a new file is generated and the suffix is incremented. For

example, if 102000 counts are logged, 3 files will be created: GW000\GW000-00.CSV (counts 1~50000), GW000\GW000-01.CSV (counts 50001~100000), and GW000\GW000-02.CSV (counts 100001 ~ 102000).

**Note**

*Please note that automatic file name generation only occurs if the FILE setting is set to NEW FILE. See page 92 for details.

**Please note that the suffix will only be incremented if the total number of readings exceeds 50000. To be able to exceed 50000 readings, either the FILE setting should be set to CONTINU (continuous) or the Count setting should be set to CONTINU (continuous). See page 91 and 92 for details.

Operator Mode

Overview

In the operator mode, you can choose to operate in Simple mode or in Advance mode, where various parameters can be designated by the user.

Simple Mode



This mode is the easiest operation mode and is almost setting free. It is the default operating mode. After entering this mode, the system will set the 'Existing File' setting to 'New File,' 'Count' to 'Continu,' and 'Time Mode' to 'Restart' by default. The system will then start to seek for the first available file name (e.g. The first file name will usually start from GW000, if GW000 doesn't already exist). If GW000 and GW001 exist already, then GW002 would be the next available filename.

Advance Mode Users can make detailed settings by themselves in this mode. Advance mode is more flexible, so it is comparatively more complex and only recommended for advanced users. The following settings are available in this mode: "Existing File", "File Name", "Count", "Time Mode", "Time Setup" and "Date Setup."

Note that the settings that are available for the Advance mode are automatically available when you activate the USB Store function in the Advance mode. See page 97.

- Procedure**
1. Press the MENU key.
 2. Go to USBSTO on level 1.
 3. Go to MODE on level 2.
 4. Set MODE to SIMPLE or ADVANCE.
 5. Press the Enter key to confirm.
 6. Press the EXIT key to exit from the MODE menu.

Display

Operator mode setting	Operator mode menu indicator
	

Long Record Mode

Overview	If users need long-term data records, the Long Record Mode can be used to log test data for a long period of time. In this mode, the Rate is set by the system to the slow rate and the refresh rate is set to 1 data refresh per second (excluding dual measurement, ACI+DCI and ACV+DCV modes).
Normal	The Normal setting is the regular record mode. The longest recordable time depends on the refresh rate that is chosen; the longest recordable time (in seconds) equals $5,000,000/\text{refresh rate}$.
Long	In the long record mode, a fixed record speed of one record per second will be logged into the log file; the longest recordable time is 5,000,000 seconds.
Procedure	<ol style="list-style-type: none">1. Press the MENU key.2. Go to USBSTO on level 1.3. Go to RECORD on level 2.4. Set RECORD to NORMAL or LONG.5. Press the Enter key to confirm.6. Press the EXIT key to exit from the MODE menu.

Display

Operator mode
setting

Operator mode
menu indicator



View the Store Function Status

Overview

The USB Status menu can be used to check the status of the USB Store function. This function will allow you to see if the save operation has completed or check the elapsed time or the current reading count.

USB Store Status
Items

ELTIME

Displays the elapsed time from when the USB store function was started.
(Format: HHH:MM:SS)

COUNT

Displays the number of readings that have been logged for the current operation.

STATUS

Displays the USB Store function status. These statuses include:

1. START indicates that the function has been started
2. STOP indicates that the function has been stopped.
3. F-FULL indicates that the current log file is full.
4. D-FULL indicates that the USB disk currently being used is full.
5. ERROR indicates errors for unknown reasons.

S-FILE	Shows the filename of the first log file of the present record.
E-FILE	Shows the filename of the last log file of the present record.

- Procedure
1. Insert a USB stick and start the USB Store function as described on page 96 or 97.
 2. To check the status of a save operation press SHIFT → 2ND.
 3. The USB Status menu will appear on the display. The elapsed time will be displayed when you enter this menu.
 4. Press the Left or Right arrow keys to switch between the ELTIME, COUNT, STATUS, S-FILE and E_FILE displays.
 5. Press SHIFT → 2ND again to exit from the USB status menu.

Display

Elapsed time, Count
or USB store status

DC F USBSTO
0000.02.15 *

Status item

ELTIME
2ND

Set the Starting File Name (Available only in Advance Mode)

Overview

The GDM-8342 will allow you to set the value of the starting file name instead of the default GW000-XX.CSV.

Note that the suffix, XX, cannot be edited.

This setting will appear automatically after the USB Store function has been started in Advance mode, see page 97 for details.

Range GW000-XX.CSV to GW999-XX.CSV

Display

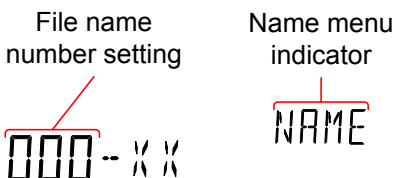

Save Count (Available only in Advance Mode)

Range	Count	CONTINU, 00002~50000
	Default	10

Overview

The COUNT function sets how many readings to perform each time the USB STO function is used. By default the COUNT setting is set to 10. When this function is used, the DMM will automatically return to the ready status when the specified number of readings have been logged. Note, however that the CONTINU (continuous) setting will continuously log data

until the USB store function is turned off.

This setting will appear automatically after the USB Store function has been started in Advance mode, see page 97 for details.



Note

When set to CONTINU, the actual number of reading counts cannot exceed 5000000 (50000 readings X100).

Display

Count setting

Count menu indicator



Save to an Existing File (Available only in Advance Mode)

Range

FILE:

CONTINU, NEWFILE

Default

NEWFILE

Overview

By default a new file is created each time the USB STO function is used. The FILE menu gives you the option to continue saving to the previous file rather than creating a new file each time the USB STO function is used.

This setting will appear automatically after the USB Store function has been started in Advance mode, see page 97 for details.

Display

File menu setting

File menu indicator



Time Mode (Available only in Advance Mode)

Range	TIME	CURRENT, RESTART
	Default	RESTART

Overview

The Time Mode setting designates how the readings are time-stamped when saved to a CSV file.

The CURRENT setting time stamps each reading from the time when the DMM was first turned on.

The RESTART setting restarts the time stamp time to 0 each time the USB STO function is used.

This setting will appear automatically after the USB Store function has been started in Advance mode, see page 97 for details.

Display

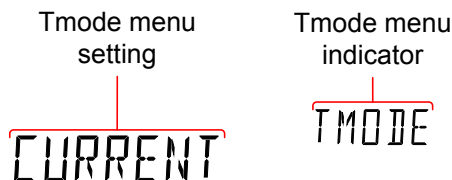

Timer

Range	TIMER	00:00:00 ~ 23:59:59 (hours:minutes:seconds)
	Default	Elapsed time from when the unit was switched on.
Accuracy	40ppm plus an annual drift of 5ppm/per year.	

Overview The timer setting sets the “current” timer time that is used to time stamp readings when saving to USB. By default the timer time is the elapsed time from when the unit was turned on.

If the timer time ticks over 23:59:59, the timer will revert back to 00:00:00 and the time stamp will include a “day” count for each time this occurs. Note, however, the “day” count cannot be set in the timer settings.

**Note**

The GDM-834X uses volatile RAM and does not have a CMOS backup battery to save the TIMER settings when the power is turned off. When the power is reset, the TIMER setting will be reset to 00:00:00.

- Procedure**
1. Press the MENU key.
 2. Go to USBSTO on level 1.
 3. Go to TIMER on level 2.
 4. Set TIMER time between 00:00:00 and 23:59:59.
 5. Press the Enter key to confirm.
 6. Press the EXIT key to exit from the TIMER menu.

Display

Timer setting



Timer menu indicator



Date

Range	Date	13.03.01 ~ 99:12:31 (Year:Month:Day)
	Default	13.03.01

Overview The date setting sets the date-stamp for any CSV files that are saved.



Note

The GDM-8342 has flash memory to store the date settings. The date that is set by the user will be restored each time the power is turned on. The GDM-8342 will not update the date setting automatically, this must be done manually by the user.

- Procedure**
1. Press the MENU key.
 2. Go to USBSTO on level 1.
 3. Go to DATE on level 2.
 4. Set the DATE. The format for the date is Year:Month:Day.
 5. Press the Enter key to confirm.
 6. Press the EXIT key to exit from the DATE menu.

Display

Date setting

130305

Date menu indicator

DATE

Save to USB

Overview The USB STO option allows the GDM-8342 to store each measurement reading to a USB stick. The USB Store function varies according to whether the operator mode is set to Simple or Advance.



Note

When the GDM-8342 starts to save records to USB, all buttons except for the SHIFT, MENU, 2ND and left and right arrow keys will be locked and disabled. Remote control will also be disabled; the GDM-8342 will stop receiving or transmitting any commands after it starts to save records to USB.

Save to USB (Simple Mode)

Overview The procedure below describes the save operation when the Mode is set to Simple.

- Procedure**
1. Insert a USB stick into the USB Host port on the front panel.
 2. If the USB stick is recognized by the DMM, the USB STO icon will be lit. This indicates that the DMM is ready to save files to the USB stick.
 3. Press SHIFT → MENU.

The USB STO icon will flash slowly, indicating the DMM is saving to USB.

4. To stop saving to USB, press SHIFT → MENU again.

When the save operation has stopped, the USB STO icon will stop flashing and will remain lit.

- The USB stick can now be removed or another save operation can be performed.

**WARNING**

Do not remove the USB stick while the DMM is saving to the USB drive.

**Note**

The USB STO icon will flash at a faster rate (~5 times/second) if there is no more space left on the USB stick or if the automatically-incremented filename suffix, XX, has reached its maximum value, 99, and cannot be increased further.

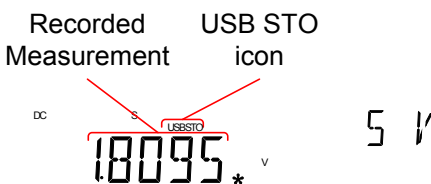
Display**Save to USB (Advance Mode)****Overview**

The procedure below describes the save operation when the Mode is set to Advance.

Procedure

- Insert a USB stick into the USB Host port on the front panel.
- If the USB stick is recognized by the DMM, the USB STO icon will be lit. This indicates that the DMM is ready to save files to the USB stick.
- Press SHIFT → MENU.
- Each Advance mode setting will now appear one after the other. Set each option and press the Enter key to continue to the next option.

The following options will appear in order:

FILE (Existing File, see page 92)
 NAME (File Name, see page 91)
 COUNT (Count, see page 91)
 TMODE (Time Mode, see page 93)
 TIMER (Time Setup, see page 93)
 DATE (Date Setup, see page 95)

- After the DATE option is set, the DMM will begin logging data.

The USB STO icon will flash slowly, indicating the DMM is saving to USB.

- To stop saving to USB, press SHIFT → MENU again.

When the save operation has stopped, the USB STO icon will stop flashing and will remain lit.

- The USB stick can now be removed or another save option can be performed.



WARNING

Do not remove the USB stick while the DMM is saving to the USB drive.



Note

The USB STO icon will flash at a faster rate (~5 times/second) if there is no more space left on the USB stick or if the automatically-incremented filename suffix, XX, has reached its maximum value, 99, and cannot be increased further.

Display

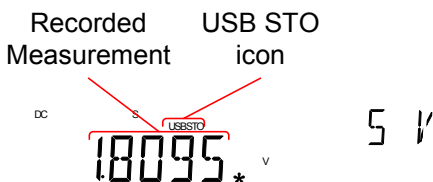

Note About Deleting Files or Directories on the USB Stick

Note If you find the need to delete files or directories that have already been saved to the USB stick, please adhere to the following suggestions to prevent unexpected results when logging data.

Overview As the system will look for the last GWXXX directory and last log file (GWXXX-XX.CSV) in that directory when saving log files, it is imperative that the file directory structure and the files within the directories remain continuous or files may be stored to the wrong directory or data may be added to the wrong log file.

**Suggestions
When Deleting
Directories or Log
Files**

1. Only delete the last directories, do not delete directories before the last remaining directory.

For example the following directories are on the USB stick: GW000, GW001, GW002, GW003, GW004, GW005

Recommended: Delete the last directories:
GW000, GW001, GW002, ~~GW003, GW004,~~
~~GW005~~

Not recommended: Deleting any directories before the last directory:
GW000, ~~GW001, GW002, GW003,~~ GW004,
GW005

2. Only delete the last log files, do not delete any log files before the last remaining log file.

For example the following log files are in a directory: GW000-00.CSV, GW000-01.CSV,

GW000-02.CSV

Recommended: Deleting only the last files or all the files from a directory:

~~GW000-00.CSV, GW000-01.CSV, GW000-02.CSV~~

OR

~~GW000-00.CSV, GW000-01.CSV, GW000-02.CSV~~

Not recommended: Deleting any file before the last file.

~~GW000-00.CSV, GW000-01.CSV, GW000-02.CSV~~

REMOTE CONTROL

This chapter describes basic configuration of IEEE488.2 based remote control. For a command list, refer to the Command Overview chapter on page 106.

Configure Remote Control Interface.....	102
USB Interface	102
GPIB Interface	103
Return to Local Control	105

Configure Remote Control Interface

USB Interface

The USB device port on the rear panel is used for remote control. The USB port on the DMM will appear as a virtual COM port to a connected PC. Any terminal program that can communicate via a serial port can be used for remote control. Before the DMM can be used for remote control the USB driver included on the User Manual CD, must first be installed.

USB configuration	PC connector	Type A, host
	DMM connector	Rear panel Type B, slave
	Speed	1.1/2.0 (full speed/high speed)
	Selectable baud rate	9600, 19200, 38400, 57600, 115200
	Parity	None
	Hardware flow control	Off
	Data Bits	8
	Stop bit	1

- | | |
|-------|--|
| Steps | <ol style="list-style-type: none"> 1. Connect the USB cable to the rear panel type B USB port. 2. Press MENU. 3. Go to I/O on level 1. 4. Go to USB on level 2. 5. Set the baud rate to an applicable rate. |
|-------|--|

6. Press Enter to confirm the baud rate settings.
7. Press EXIT to exit from the USB menu.

Display

Baud rate
setting



9600

Baud menu
indicator



BAUD

GPIB Interface

In addition to the USB port, an optional GPIB port (GDM-8342 only) on the rear panel can be used for remote control.

GPIB configuration	GPIB Address Range	0~30
--------------------	--------------------	------

Steps

1. Connect the GPIB cable to the rear panel GPIB port.
2. Press MENU.
3. Go to I/O on level 1.
4. Go to GPIB on level 2.
5. Turn GPIB ON and press Enter to Confirm.
6. The GPIB address settings will automatically appear after turning GPIB on. Set the GPIB address.
7. Press Enter to confirm the GPIB address setting.
8. Press EXIT to exit from the System menu.

Display

GPIB address setting

GPIB menu indicator



Note

GPIB Constraints

- Maximum 15 devices together, at least 2/3 of all devices turned on. Cable length should be less than 20m with a maximum of 2m between each device.
- Unique address assigned to each device
- No loop or parallel connections

Return to Local Control

Background When the unit is in remote control mode, the RMT icon above the main display can be seen. When this icon is not displayed, it indicates that the unit is in local control mode.

- Procedure**
1. Press the LOCAL/2ND key when in remote mode.
 2. The unit will go back into local mode and the RMT icon will turn off.

Display

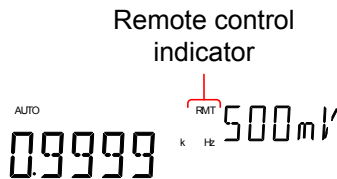

C **COMMAND OVERVIEW**

The Command overview chapter lists all programming commands in functional order as well as alphabetical order. The command syntax section shows you the basic syntax rules you have to apply when using commands.

Command Syntax

Compatible Standard	IEEE488.2	Partial compatibility
	SCPI, 1994	Partial compatibility

Command Structure

SCPI (Standard Commands for Programmable Instruments) commands follow a tree-like structure, organized into nodes. Each level of the command tree is a node. Each keyword in a SCPI command represents each node in the command tree. Each keyword (node) of a SCPI command is separated by a colon (:). For example, the diagram below shows an SCPI sub-structure and a command example.

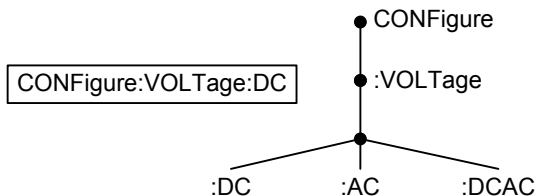

Command types There are a number of different instrument commands and queries. A command sends instructions or data to the unit and a query receives data or status information from the unit.

Command types

Simple	A single command with/without a parameter
--------	---

Example	CONFigure:VOLTage:DC
---------	----------------------

Query	A query is a simple or compound command followed by a question mark (?). A parameter (data) is returned.
-------	--

Example	CONFigure:RANGe?
---------	------------------

Command Forms Commands and queries have two different forms, long and short. The command syntax is written with the short form of the command in capitals and the remainder (long form) in lower case.

The commands can be written either in capitals or lower-case, just so long as the short or long forms are complete. An incomplete command will not be recognized.

Below are examples of correctly written commands.

Long form

CONFigure:DIODE

CONFIGURE:DIODE

Configure:diode

Short form
 CONF:DIOD
 conf:diod

Square Brackets Commands that contain square brackets indicate that the contents are optional. The function of the command is the same with or without the square bracketed items, as shown below. For example, for the query:

[SENSe:]UNIT?
 Both [SENSe:]UNIT? and UNIT? are both valid forms.

Command Format

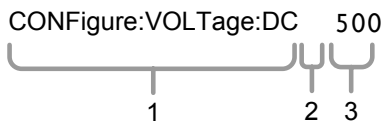

- 1. Command header
- 2. Space
- 3. Parameter 1

Common Input Parameters

Type	Description	Example
<Boolean>	boolean logic	0, 1
<NR1>	integers	0, 1, 2, 3
<NR2>	decimal numbers	0.1, 3.14, 8.5
<NR3>	floating point with exponent	4.5e-1, 8.25e+1
<NRf>	any of NR1, 2, 3	1, 1.5, 4.5e-1

[MIN] (Optional parameter)	For commands, this will set the setting to the lowest value. This parameter can be used in place of any numerical parameter where indicated.
	For queries, it will return the lowest possible value allowed for the particular setting.
[MAX] (Optional parameter)	For commands, this will set the setting to the highest value. This parameter can be used in place of any numerical parameter where indicated.
	For queries, it will return the highest possible value allowed for the particular setting.
Automatic parameter range selection	The GDM-8342/8341 automatically sets the command parameter to the next available value.
	<p>Example conf:volt:dc 1</p> <p>This will set the measurement item to DC Voltage and the range to 5V. There is no 1V range so the DMM selects the next available range, 5V.</p>
Message Terminator (EOL)	<p>Remote Command Marks the end of a command line. The following messages are in accordance with IEEE488.2 standard.</p>
	<p>LF, CR, CR+LF The most common EOL character is CR+LF</p>

	Return Message	CR+ LF
Message Separator	EOL or ; (semicolon)	Command Separator

Command List

Configure Commands (Display 1)

CONFigure:VOLTage:DC.....	116
CONFigure:VOLTage:AC.....	116
CONFigure:VOLTage:DCAC.....	116
CONFigure:CURRent:DC.....	116
CONFigure:CURRent:AC.....	117
CONFigure:CURRent:DCAC.....	117
CONFigure:RESistance.....	117
CONFigure:FREQuency.....	117
CONFigure:PERiod.....	118
CONFigure:CONTInuity.....	118
CONFigure:DIODE.....	118
CONFigure:TEMPerature:TCOuple.....	118
CONFigure:CAPacitance.....	118
CONFigure:FUNCTion?.....	118
CONFigure:RANGe?.....	119
CONFigure:AUTO.....	119
CONFigure:AUTO?.....	119

Configure Commands (Display 2)

CONFigure2:VOLTage:DC.....	119
CONFigure2:VOLTage:AC.....	120
CONFigure2:CURRent:DC.....	120
CONFigure2:CURRent:AC.....	120
CONFigure2:RESistance.....	120
CONFigure2:FREQuency.....	121
CONFigure2:PERiod.....	121
CONFigure2:OFF.....	121
CONFigure2:FUNCTion?.....	121
CONFigure2:RANGe?.....	122
CONFigure2:AUTO.....	122
CONFigure2:AUTO?.....	122

Measure Commands

MEASure:VOLTage:DC?	123
MEASure:VOLTage:AC?	123
MEASure:VOLTage:DCAC?	123
MEASure:CURRent:DC?	123
MEASure:CURRent:AC?	124
MEASure:CURRent:DCAC?	124
MEASure:RESistance?	124
MEASure:FREQuency?	124
MEASure:PERiod?	124
MEASure:CONTInuity?	125
MEASure:DIODE?	125
MEASure:TEMPerature:TCouple?	125
MEASure2:VOLTage:DC?	125
MEASure2:VOLTage:AC?	125
MEASure2:CURRent:DC?	126
MEASure2:CURRent:AC?	126
MEASure2:RESistance?	126
MEASure2:FREQuency?	126
MEASure2:PERiod?	126

Sense Commands

[SENSe:]TEMPerature:TCouple:TYPE	127
[SENSe:]TEMPerature:TCouple:TYPE?	127
[SENSe:]TEMPerature:RJUNction:SIMulated	127
[SENSe:]TEMPerature:RJUNction:SIMulated?	127
[SENSe:]DETEctor:RATE	127
[SENSe:]DETEctor:RATE?	127
[SENSe:]FREQuency:INPutjack	128
[SENSe:]FREQuency:INPutjack?	128
[SENSe:]PERiod:INPutjack	128
[SENSe:]PERiod:INPutjack?	128
[SENSe:]CONTInuity:THReshold	128
[SENSe:]CONTInuity:THReshold?	128
[SENSe:]UNIT	129
[SENSe:]UNIT?	129
[SENSe:]FUNCTion[1/2]	129
[SENSe:]FUNCTion[1/2]?	129

Calculate Commands

CALCulate:FUNCTION.....	130
CALCulate:FUNCTION?	130
CALCulate:STATe	130
CALCulate:STATe?	130
CALCulate:MINimum?	130
CALCulate:MAXimum?	130
CALCulate:HOLD:REFERence	131
CALCulate:HOLD:REFERence?	131
CALCulate:REL:REFERence	131
CALCulate:REL:REFERence?	131
CALCulate:LIMit:LOWer	131
CALCulate:LIMit:LOWer?	131
CALCulate:LIMit:UPPer	131
CALCulate:LIMit:UPPer?	132
CALCulate:DB:REFERence	132
CALCulate:DB:REFERence?	132
CALCulate:DBM:REFERence.....	132
CALCulate:DBM:REFERence?.....	132
CALCulate:MATH:MMFactor	132
CALCulate:MATH:MMFactor?.....	132
CALCulate:MATH:MBFactor	133
CALCulate:MATH:MBFactor?.....	133
CALCulate:MATH:PERCent	133
CALCulate:MATH:PERCent?.....	133
CALCulate:NULL:OFFSet.....	133
CALCulate:NULL:OFFSet?	133

Trigger Commands

READ?.....	134
VAL1?.....	134
VAL2?.....	134
TRIGger:SOURce	134
TRIGger:SOURce?.....	134
TRIGger:AUTO	135
TRIGger:AUTO?	135
SAMPle:COUNT	135
SAMPle:COUNT?.....	135
TRIGger:COUNT.....	135
TRIGger:COUNT?	135

System Commands

SYSTem:BEEPer:STATe	136
SYSTem:BEEPer:STATe?	136
SYSTem:BEEPer:ERRor	136
SYSTem:BEEPer:ERRor?	136
SYSTem:ERRor?	136
SYSTem:VERSion?	136
SYSTem:DISPlay	137
SYSTem:DISPlay?	137
SYSTem:SERial?	137
SYSTem:SCPi:MODE	137
SYSTem:SCPi:MODE?	137
INPut:IMPedance:AUTO	137
INPut:IMPedance:AUTO?	137

Status Commands

STATus:QUEStionable:ENABle	138
STATus:QUEStionable:ENABle?	138
STATus:QUEStionable:EVENT?	138
STATus:PRESet	138

Interface Commands

SYSTem:LOCal	138
SYSTem:REMote	138
SYSTem:RWLock	139

Common Commands

*CLS	139
*ESE?	139
*ESE	139
*ESR?	139
*IDN?	140
*OPC?	140
*OPC	140
*PSC?	140
*PSC	140
*RST	140
*SRE?	140
*SRE	140

*STB?	141
*TRG	141

CONFigure Commands

CONFigure:VOLTage:DC

Sets measurement to DC Voltage on the first display and specifies the range.

Parameter: [None] | [Range(<NRf> | MIN | MAX | DEF)]

Example: CONF:VOLT:DC 5

Sets the voltage range to 5 volts.

CONFigure:VOLTage:AC

Sets measurement to AC Voltage on the first display and specifies the range.

Parameter: [None] | [Range(<NRf> | MIN | MAX | DEF)]

Example: CONF:VOLT:AC

Sets the AC range to auto range.

CONFigure:VOLTage:DCAC

Sets measurement to DC+AC Voltage on the first display and specifies the range.

Parameter: [None] | [Range(<NRf> | MIN | MAX | DEF)]

Example: CONF:VOLT:DCAC

Sets the DC+AC voltage range to auto range.

CONFigure:CURRent:DC

Sets measurement to DC Current on the first display and specifies the range.

Parameter: [None] | [Range(<NRf> | MIN | MAX | DEF)]

Example: CONF:CURR:DC 50e-3

Sets the DC current range to 50mA.

CONFigure:CURRent:AC

Sets measurement to AC Current on the first display and specifies range.

Parameter: [None] | [Range(<NRf> | MIN | MAX | DEF)]

Example: CONF:CURR:AC 50e-2

Sets the measurement mode to ACI with a 500mA range.

CONFigure:CURRent:DCAC

Sets measurement to DC+AC Current on the first display and specifies range.

Parameter: [None] | [Range(<NRf> | MIN | MAX | DEF)]

Example: CONF:CURR:DCAC 50e-2

Sets the measurement mode to DC+AC Current with a 500mA range.

CONFigure:RESistance

Sets measurement to 2W Resistance on the first display and specifies range.

Parameter: [None] | [Range(<NRf> | MIN | MAX | DEF)]

Example: CONF:RES 50e3

Sets the range to 50k Ω .

CONFigure:FREQuency

Sets measurement to Frequency on the first display and specifies the range.

Parameter: [None] | [Range(<NRf> | MIN | MAX | DEF)]

Example: CONF:FREQ MAX

Sets the frequency measurement range to max.

CONFigure:PERiod

Sets measurement to Period on the first display and specifies the range.

Parameter: [None] | [Range(<NRf> | MIN | MAX | DEF)]

Example: CONF:PER

Sets the DMM to period measurement using the previous range.

CONFigure:CONTInuity

Sets measurement to Continuity on the first display.

Parameter: None

CONFigure:DIODE

Sets measurement to Diode on the first display.

Parameter: None

CONFigure:TEMPerature:TCouple

Sets measurement to Temperature thermocouple (T-CUP) on the first display.

Parameter: [None] | [Type(J | K | T)]

Example: CONF:TEMP:TCO J

Sets the measurement mode to TCO with a type J sensor.

CONFigure:CAPacitance

Sets measurement to Capacitance on the first display.

Parameter: [None] | [Range(<NRf> | MIN | MAX | DEF)]

Example: CONF:CAP 5E-5

Sets the measurement mode to Capacitance with a 50 μ F Range.

CONFigure:FUNCTION?

Returns the current function on the first display.

Return parameter: VOLT, VOLT:AC, VOLT:DCAC, CURR, CURR:AC, CURR:DCAC, RES, FREQ, PER, TEMP, DIOD, CONT, CAP

CONFigure:RANGe?

Returns the current range on the first display.

Return Parameter:

DCV: 0.5(500mV), 5(5V), 50(50V), 500(500V), 1000(1000V)

ACV: 0.5(500mV), 5(5V), 50(50V), 500(500V), 750(750V)

ACI: 0.0005(500 μ A), 0.005 (5mA), 0.05(50mA), 0.5(500mA), 5(5A), 10(10A)

DCI: 0.0005(500 μ A), 0.005 (5mA), 0.05(50mA), 0.5(500mA), 5(5A), 10(10A)

RES: 50E+1(500 Ω), 50E+2(5k Ω), 50E+3(50k Ω), 50E+4 (500k Ω), 50E+5(5M Ω), 50E+6(50M Ω)

CAP: 5E-9(5nF), 5E-8(50nF), 5E-7(500nF), 5E-6(5 μ F), 5E-5(50 μ F)

CONFigure:AUTO

Sets Auto-Range on or off on the first display.

Parameter: ON | OFF

Example: CONF:AUTO ON

CONFigure:AUTO?

Returns the Auto-Range status of the function on the 1st display.

Return Parameter: 0 | 1, 1=Auto range, 0=Manual range

Secondary Display: CONFigure2 Commands

CONFigure2:VOLTage:DC

Sets measurement to DC Voltage on the second display and specifies the range.

Parameter: [None] | [Range(<NRf> | MIN | MAX | DEF)]

Example: CONF2:VOLT:DC 5

Sets the voltage range to 5 volts.

CONFigure2:VOLTage:AC

Sets measurement to AC Voltage on the second display and specifies the range.

Parameter: [None] | [Range(<NRf> | MIN | MAX | DEF)]

Example: CONF2:VOLT:AC

Sets the measurement mode to AC voltage.

CONFigure2:CURREnt:DC

Sets measurement to DC Current on the second display and specifies the range.

Parameter: [None] | [Range(<NRf> | MIN | MAX | DEF)]

Example: CONF2:CURR:DC 50e-3

Sets the DC current range to 50mA on the second display.

CONFigure2:CURREnt:AC

Sets measurement to AC Current on the second display and specifies the range.

Parameter: [None] | [Range(<NRf> | MIN | MAX | DEF)]

Example: CONF2:CURR:AC 50e-2

Sets the measurement mode to ACI with a 500mA range on the second display.

CONFigure2:RESistance

Sets measurement to 2W Resistance on the second display and specifies the range.

Parameter: [None] | [Range(<NRf> | MIN | MAX | DEF)]

Example: CONF2:RES 50e3

Sets the range to 50k Ω on the second display.

CONFigure2:FREQuency

Sets measurement to Frequency on the second display and specifies the range.

Parameter: [None] | [Range(<NRf> | MIN | MAX | DEF)]

Example: CONF2:FREQ MAX

Sets the frequency measurement range to max on the second display.

CONFigure2:PERiod

Sets measurement to Period on the second display and specifies the range.

Parameter: [None] | [Range(<NRf> | MIN | MAX | DEF)]

Example: CONF2:PER

Sets the DMM to period measurement using the previous range.

CONFigure2:OFF

Turns the second display function off.

Parameter: None.

CONFigure2:FUNcTION?

Returns the current function on the second display.

Return parameter: VOLT, VOLT:AC, CURR, CURR:AC, RES, FREQ, PER, NON

CONFigure2:RANGe?

Returns the range of the current function on the second display.

Return parameter:

DCV: 0.5(500mV), 5(5V), 50(50V), 500(500V), 1000(1000V)

ACV: 0.5(500mV), 5(5V), 50(50V), 500(500V), 750(750V)

ACI: 0.0005(500 μ A), 0.005 (5mA), 0.05(50mA), 0.5(500mA), 5(5A),
10(10A)

DCI: 0.0005(500 μ A), 0.005 (5mA), 0.05(50mA), 0.5(500mA), 5(5A),
10(10A)

RES: 50E+1(500 Ω), 50E+2(5k Ω), 50E+3(50k Ω), 50E+4 (500k Ω),
50E+5(5M Ω), 50E+6(50M Ω)

CONFigure2:AUTO

Sets Auto-Range on or off on the 2nd display.

Parameter: ON | OFF

Example: CONF2:AUTO ON

CONFigure2:AUTO?

Returns the Auto-Range status of the function on the 2nd display.

Return Parameter: 0 | 1, 1=Auto range, 0=Manual range

Measure Commands

MEASure:VOLTage:DC?

Returns the DC voltage measurement on the first display.

Parameter: [None] | [Range(<NRf> | MIN | MAX | DEF)]

Example: MEAS:VOLT:DC?

>+0.488E-4

Returns the DC voltage measurement as 0.0488 mV.

MEASure:VOLTage:AC?

Returns the AC voltage measurement on the first display.

Parameter: [None] | [Range(<NRf> | MIN | MAX | DEF)]

Example: MEAS:VOLT:AC?

>+0.511E-3

Returns the AC voltage measurement as 0.511 mV.

MEASure:VOLTage:DCAC?

Returns the DC+AC voltage measurement on the first display.

Parameter: [None] | [Range(<NRf> | MIN | MAX | DEF)]

Example: MEAS:VOLT:DCAC?

>+0.326E-3

Returns the DC+AC voltage measurement as 0.326 mV.

MEASure:CURRent:DC?

Returns the DC current measurement on the first display.

Parameter: [None] | [Range(<NRf> | MIN | MAX | DEF)]

Example: MEAS:CURR:DC?

>+0.234E-4

Returns the DC current measurement as 0.0234 mA.

MEASure:CURRent:AC?

Returns the AC current measurement on the first display.

Parameter: [None] | [Range(<NRf> | MIN | MAX | DEF)]

Example: MEAS:CURR:AC?

> +0.387E-2

Returns the AC current measurement as 3.87mA.

MEASure:CURRent:DCAC?

Returns the DC+AC current measurement on the first display.

Parameter: [None] | [Range(<NRf> | MIN | MAX | DEF)]

Example: MEAS:CURR:DCAC?

>+0.123E-4

Returns the DC+AC current measurement as 0.0123 mA.

MEASure:RESistance?

Returns the 2W resistance measurement on the first display.

Parameter: [None] | [Range(<NRf> | MIN | MAX | DEF)]

Example: MEAS:RES?

> +1.1937E+3

Returns the 2W measurement as 1.1937k Ω .

MEASure:FREQuency?

Returns the frequency measurement on the first display.

Parameter: [None] | [Range(<NRf> | MIN | MAX | DEF)]

Example: MEAS:FREQ?

> +2.3708E+2

Returns the frequency (237.08Hz).

MEASure:PERiod?

Returns the period measurement on the first display.

Parameter: [None] | [Range(<NRf> | MIN | MAX | DEF)]

Example: MEAS:PER? MAX

Returns the period at the maximum range.

MEASure:CONTInuity?

Returns the continuity measurement on the first display.

Example: MEAS:CONT?

Returns the continuity.

MEASure:DIODe?

Returns the diode measurement on the first display.

Example: MEAS:DIOD?

Returns the diode measurement.

MEASure:TEMPerature:TCOuple?

Returns the temperature for the selected thermocouple type on the first display.

Parameter: [NONE] | J | K | T

Example: MEAS:TEMP:TCO? J

> +2.50E+1

Returns the temperature.

MEASure2:VOLTage:DC?

Returns the DC voltage measurement on the second display.

Parameter: [None] | [Range(<NRf> | MIN | MAX | DEF)]

Example: MEAS2:VOLT:DC?

> +0.488E-4

Returns the DC voltage measurement as 0.0488 mV.

MEASure2:VOLTage:AC?

Returns the AC voltage measurement on the second display.

Parameter: [None] | [Range(<NRf> | MIN | MAX | DEF)]

Example: MEAS2:VOLT:AC?

> +0.511E-3

Returns the AC voltage measurement as 0.511 mV.

MEASure2:CURRent:DC?

Returns the DC current measurement on the second display.

Parameter: [None] | [Range(<NRf> | MIN | MAX | DEF)]

Example: MEAS2:CURR:DC?

>+0.234E-4

Returns the DC current measurement as 0.0234 mA.

MEASure2:CURRent:AC?

Returns the AC current measurement on the second display.

Parameter: [None] | [Range(<NRf> | MIN | MAX | DEF)]

Example: MEAS2:CURR:AC?

> +0.387E-2

Returns the AC current measurement.

MEASure2:RESistance?

Returns the 2W resistance measurement on the second display.

Parameter: [None] | [Range(<NRf> | MIN | MAX | DEF)]

Example: MEAS2:RES?

> +1.1912E+3

Returns the 2W measurement.

MEASure2:FREQuency?

Returns the frequency measurement on the second display.

Parameter: [None] | [Range(<NRf> | MIN | MAX | DEF)]

Example: MEAS2:FREQ?

> +2.3712E+2

Returns the frequency (237.12Hz).

MEASure2:PERiod?

Returns the period measurement on the second display.

Parameter: [None] | [Range(<NRf> | MIN | MAX | DEF)]

Example: MEAS2:PER? MAX

Returns the period at the maximum range.

SENSe Commands

[SENSe:]TEMPerature:TCouple:TYPE

Sets thermocouple type.

Parameter: Type(J | K | T)

Example: SENS:TEMP:TCO:TYPE J

Sets the thermocouple to type J.

[SENSe:]TEMPerature:TCouple:TYPE?

Returns the thermocouple type.

Return parameter: J, K, T

[SENSe:]TEMPerature:RJUNction:SIMulated

Set temperature simulation value.

Parameter: <NRf>(0.00 ~ 50.00)

Example: SENS:TEMP:RJUN:SIM 25.00

Sets the thermocouple junction temperature to 25°C.

[SENSe:]TEMPerature:RJUNction:SIMulated?

Returns temperature simulation value.

Return parameter: <NR1> (+0000~+5000) ,where +0000=0.00°C,
+5000=50.00°C

[SENSe:]DETEctor:RATE

Sets the detection rate (sample rate)

Parameter: RATE(S | M | F)

Example: SENS:DET:RATE S

Sets the rate to slow (S).

[SENSe:]DETEctor:RATE?

Returns the sample rate.

Return parameter: SLOW, MID, FAST

[SENSe:]FREQuency:INPutjack

Assigns an input terminal for the frequency function.

Parameter: (0 | 1 | 2) 0=volt, 1=500mA, 2=10A

Example: SENS:FREQ:INP 0

Sets the input jack to the Volt input terminal.

[SENSe:]FREQuency:INPutjack?

Returns the assigned input terminal used for the frequency function.

Return Parameter: VOLT, 500mA, 10A

[SENSe:]PERiod:INPutjack

Assigns an input terminal for the period function.

Parameter: (0 | 1 | 2) 0=volt, 1=500mA, 2=10A

Example: SENS:PER:INP 0

Sets the input jack to the Volt input terminal.

[SENSe:]PERiod:INPutjack?

Returns the assigned input terminal used for the period function.

Return Parameter: VOLT, 500mA, 10A

[SENSe:]CONTInuity:THReshold

Sets the continuity threshold in ohms.

Parameter: <NRf> (0 ~ 1000)

Example: SENS:CONT:THR 500

Sets the continuity threshold to 500

[SENSe:]CONTInuity:THReshold?

Returns the continuity threshold.

[SENSe:]UNIT

Sets the temperature unit.

Parameter: C|F

Example: SENS:UNIT C

Sets the temperature unit to °C.

[SENSe:]UNIT?

Returns the temperature unit.

[SENSe:]FUNCTION[1/2]

Sets the function for the first or second display.

Parameter:

(display1): "VOLT[:DC]", "VOLT:AC", "VOLT:DCAC",
"CURR[:DC]", "CURR:AC", "CURR:DCAC", "RES", "FREQ",
"PER", "TEMP:TCO", "DIOD", "CONT", "CAP"

(display2): "VOLT[:DC]", "VOLT:AC", "CURR[:DC]",
"CURR:AC", "RES", "FREQ", "PER", "NON"

Example: SENS:FUNC1 "VOLT:DC"

Sets the 1st display to the DCV function.

[SENSe:]FUNCTION[1/2]?

Returns the function displayed on the first or second display.

Return parameter:

(display 1): VOLT, VOLT:AC, VOLT:DCAC, CURR,
CURR:AC, CURR:DCAC, RES, FREQ, PER, TEMP:TCO, DIOD,
CONT, CAP

(display 2): VOLT, VOLT:AC, CURR, CURR:AC, RES, FREQ,
PER, NON

CALCulate Commands

CALCulate:FUNCTION

Sets the Advanced function.

Parameter: OFF | MIN | MAX | HOLD | REL | COMP | DB |
DBM | MXB | INV | REF

Example: CALC:FUNC REL

Sets the Advanced function to REL (relative)

CALCulate:FUNCTION?

Returns the current Advanced function.

CALCulate:STATe

Turns the Advanced function on/off.

Parameter: ON | OFF

Example: CALC:STAT OFF

Turns the Advanced function off.

CALCulate:STATe?

Returns the status of the Advanced function.

Return Parameter: 0 | 1, 1=ON, 0=OFF

CALCulate:MINimum?

Returns the minimum value from the Max/Min measurement.

CALCulate:MAXimum?

Returns the maximum value from the Max/Min measurement.

CALCulate:HOLD:REFeRence

Sets the percentage threshold for the Hold function.

Parameter: <NRf> (0.01, 0.1, 1, 10)

Example: CALC:HOLD:REF 10

Sets the hold percentage to 10%.

CALCulate:HOLD:REFeRence?

Returns the percentage threshold from the Hold function.

CALCulate:REL:REFeRence

Sets the reference value for the relative function.

Parameter: <NRf> | MIN | MAX

Example: CALC:REL:REF MAX

Sets the reference value to the maximum allowed.

CALCulate:REL:REFeRence?

Returns the reference value from the relative function.

CALCulate:LIMit:LOWer

Sets the lower limit of the compare function.

Parameter: <NRf> | MIN | MAX

Example: CALC:LIM:LOW 1.0

Sets the lower limit to 1.0.

CALCulate:LIMit:LOWer?

Returns the lower limit of the compare function.

CALCulate:LIMit:UPPer

Sets the upper limit of the compare function.

Parameter: <NRf> | MIN | MAX

Example: CALC:LIM:UPP 1.0

Sets the upper limit to 1.0.

CALCulate:LIMit:UPPer?

Returns the upper limit of the compare function.

CALCulate:DB:REFeRence

Sets the reference value for the dB function.

Parameter: <NRf> | MIN | MAX

Example: CALC:DB:REF MAX

Sets the reference voltage for dB measurements to the maximum allowed.

CALCulate:DB:REFeRence?

Returns the reference voltage from the dB function.

CALCulate:DBM:REFeRence

Sets the resistance value for the dBm function.

Parameter: <NRf> | MIN | MAX

Example: CALC:DBM:REF MAX

Sets the resistance value for dBm measurements to the maximum allowed.

CALCulate:DBM:REFeRence?

Returns the resistance value from the dBm function.

CALCulate:MATH:MMFactor

Sets the scale factor M for math measurements.

Parameter: <NRf> | MIN | MAX

Example: CALC:MATH:MMF MIN

Sets the scale factor M to the minimum allowed value.

CALCulate:MATH:MMFactor?

Returns the scale factor M used in the math measurement.

CALCulate:MATH:MBFactor

Sets the offset factor B for math measurements.

Parameter: <NRf> | MIN | MAX

Example: CALC:MATH:MBF MIN

Sets the offset factor B to the minimum allowed value.

CALCulate:MATH:MBFactor?

Returns the offset factor B used in the math measurement.

CALCulate:MATH:PERCent

Sets the reference value for the Percent function.

Parameter: <NRf> | MIN | MAX

Example: CALC:MATH:PERC MAX

Sets the reference value for the Percent function to the maximum.

CALCulate:MATH:PERCent?

Returns the reference value setting for the Percent function.

CALCulate:NULL:OFFSet

Sets the reference value for the relative function. This command is analogous to the CALCulate:REL:REFErence command.

Parameter: <NRf> | MIN | MAX

Example: CALC:NULL:OFFS MAX

Sets the reference value to the maximum allowed.

CALCulate:NULL:OFFSet?

Returns the reference value from the relative function. This query is analogous to the CALCulate:REL:REFErence? query.

TRIGger Commands

READ?

Returns 1st and 2nd display value.

VAL1?

Returns the 1st display reading

Example: SAMP:COUN 100

VAL1?

>+0.333E-4,V DC

>+0.389E-4,V DC

> etc, for 100 counts.

Queries 100 counts of stored samples from the 1st display.

VAL2?

Returns the 2nd display reading.

Example: SAMP:COUN 100

VAL2?

>+0.345E-4,V DC

>+0.391E-4,V DC

> etc, for 100 counts.

Queries 100 counts of stored samples from the 2nd display.

TRIGger:SOURce

Selects the trigger source.

Parameter: INT | EXT

Example: TRIG:SOUR INT

Sets the trigger source as internal.

TRIGger:SOURce?

Returns current trigger source.

TRIGger:AUTO

Turns Trigger Auto mode on/off.

Parameters: ON | OFF

Example: TRIG:AUTO OFF

Turns the Trigger Auto mode off.

TRIGger:AUTO?

Returns the Trigger Auto mode.

Return parameter: 0|1, 0=OFF, 1=ON

SAMPle:COUNT

Sets the number of samples.

Parameter: <NR1>(1 ~ 9999) | MIN | MAX

Example: SAMP:COUN 10

Sets the number of samples to 10.

SAMPle:COUNT?

Returns the number of samples.

Parameter: None | MIN | MAX

TRIGger:COUNT

Sets the number of trigger counts.

Parameter: <NR1>(1 ~ 9999) | MIN | MAX

Example: TRIG:COUN 10

Sets the number of trigger counts to 10.

TRIGger:COUNT?

Returns the number of trigger counts.

Parameter: None | MIN | MAX

SYSTEM Related Commands

SYSTEM:BEEP:STATe

Selects the beeper mode; no beep, beep on fail and beep on pass.

Parameter: <NR1>(0 | 1 | 2) 0=no beep, 2=fail, 1=pass

Example: SYST:BEEP:STAT 0

Turns the beeper off.

SYSTEM:BEEP:STATe?

Returns the beeper mode.

Return parameter: Beep on Pass | Beep on Fail | No Beep

SYSTEM:BEEP:ERRor

Sets the beeper to sound on an SCPI error.

Parameter: ON | OFF

Example: SYST:BEEP:ERR ON

Allows the beeper to sound when an SCPI error occurs.

SYSTEM:BEEP:ERRor?

Returns the beeper error mode.

Return parameter: 0 | 1, 0=OFF, 1=ON

SYSTEM:ERRor?

Returns the current system error, if any.

SYSTEM:VERSion?

Returns system version.

Return Parameter: X.XX.

SYSTem:DISPlay

Turns the Display on/off.

Parameter: ON | OFF

Example: SYST:DISP ON

Turns the display on.

SYSTem:DISPlay?

Returns the status of the display

Return parameter: 0 | 1, 0=OFF, 1=ON

SYSTem:SERial?

Returns the serial number (eight characters/numbers)

SYSTem:SCPi:MODE

Sets the SCPI mode.

Parameter: NORM | COMP

(NORM=Normal, COMP= Compatible to GDM8246)

Example: SYST:SCP:MODE NORM

Sets the SCPI mode to normal.

SYSTem:SCPi:MODE?

Returns the SCPI mode.

Return parameter: NORMAL | COMPATIBLE

INPut:IMPedance:AUTO

Sets the input impedance for DCV mode.

Parameter: ON(10G) | OFF(10M)

Example: INP:IMP:AUTO ON

Turns the Automatic input impedance on.

INPut:IMPedance:AUTO?

Returns the input impedance mode.

Return parameter: <Boolean>(0 | 1) (0=OFF(10M), 1=ON(10G))

STATus Report Commands

STATus:QUEStionable:ENABle

Set bits in the Questionable Data Enable register.

STATus:QUEStionable:ENABle?

Returns the contents of the Questionable Data Enable register.

STATus:QUEStionable:EVENT?

Returns the contents of the Questionable Data Event register.

STATus:PRESet

Clears the Questionable Data Enable register.

Example: STAT:PRES

Interface Commands

SYSTem:LOCal

Enables local control (front panel control) and disables remote control.

SYSTem:REMote

Enables remote control and disables local control (front panel control). Local control can be recalled by pressing the 2ND or local button.

SYSTem:RWLock

Enables remote control and disables local control (front panel control). Once this command has been issued, pressing the 2ND or local buttons will not return the user to local control. The only way to return local mode is to issue the SYSTem:LOCal command.

IEEE 488.2 Common Commands

***CLS**

Clears the Event Status register (Output Queue, Operation Event Status, Questionable Event Status, Standard Event Status)

***ESE?**

Returns the ESER (Event Status Enable Register) contents.

Example: *ESE?

>130

Returns 130. ESER=10000010

***ESE**

Sets the ESER contents.

Parameter: <NR1> (0~255)

Example: *ESE 65

Sets the ESER to 01000001

***ESR?**

Returns SESR (Standard Event Status Register) contents.

Example: *ESR?

>198

Returns 198. SESR=11000110

***IDN?**

Returns the manufacturer, model No., serial number and system version number.

Example: *IDN?

>GWInstek,GDM8342,00000000,1.0

***OPC?**

"1" is placed in the output queue when all the pending operations are completed.

***OPC**

Sets operation complete bit (bit0) in SERS (Standard Event Status Register) when all pending operations are completed.

***PSC?**

Returns power On clear status.

Return parameter: <Boolean>(0 | 1) 0= don't clear, 1=clear

***PSC**

Clears power On status.

Parameter: <Boolean>(0 | 1) 0=don't clear, 1= clear

***RST**

Recalls default panel setup.

***SRE?**

Returns the SRER (Service Request Enable Register) contents.

***SRE**

Sets SRER contents.

Parameter: <NR1>(0~255)

Example: *SRE 7

Sets the SRER to 00000111.

***STB?**

Returns the SBR (Status Byte Register) contents.

Example: *STB?

>81

Returns the contents of the SBR as 01010001.

***TRG**

Manually triggers the DMM.

For the following command sets, please refer to the status system diagram on page 148.

STAT: QUES: EVEN?

STAT: QUES: ENAB

STAT: QUES: ENAB?

*ESR?

*ESE

*ESE?

*STB?

*SRE

*SRE?

FAQ

The DMM performance doesn't match the specifications.

Make sure the device is powered On for at least 30 minutes, within 18~28°C. This is necessary to stabilize the unit to match the specifications.

The measured voltage does not match the expected value.

There are a number of reasons why the measured value may not match the expected values.

1. Ensure that all connections are connected securely and have a good contact at all times. Poor contacts could result in erroneous measurements.
2. Ensure that the appropriate input resistance has been set in the System menu. For 500mv and 5V ranges, the input resistance can be set to either 10MΩ or 10GΩ.
3. When measuring AC voltage or current, the RMS of the voltage peak is measured, not the voltage peak. See page 36 for details.
4. The measurement rate settings can have an effect on the accuracy of the measurement. Slow measurements are more accurate, while the fast rate is not as accurate.
5. Ensure that an appropriate range setting is used. If a too-large range is used, the resolution or the measurement may be affected.

For more information, contact your local dealer or GWInstek at www.gwinstek.com / marketing@goodwill.com.tw.

APPENDIX

System Menu Tree

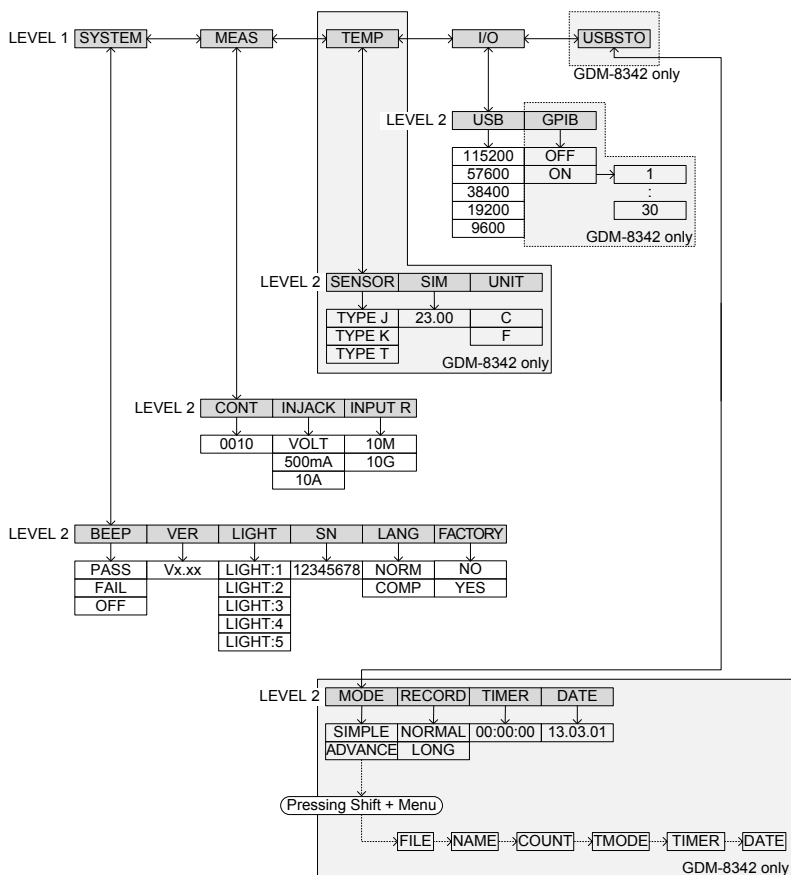

Factory Default Settings

Measurement Item

DCV

Range

AUTO

Rate

S

SYSTEM Menu

BEEP: Pass

VER: N/A

LIGHT: 3

S/N: N/A

LANG: NORM

FACTORY: NO

MEAS Menu

CONT: 0010 Ω

INJACK: VOLT

INPUT R: 10M

TEMP Menu

SENSOR: TYPE J

SIM: 23.00

UNIT: C

I/O Menu

USB: BAUD: 115200

GPIB: OFF

USBSTO Menu

MODE: SIMPLE

RECORD:NORMAL

TIMER: 00:00:00

DATE: 13.03.01

Replacing the AC Source Fuse

Fuse Ratings	Type	Rating	Size
	0.125AT	100VAC, 120VAC	5mm X 20mm
	0.063AT	220VAC, 240VAC	5mm X 20mm



Note

Only replace the fuse with a fuse of the correct type and rating.

Steps

1. Turn the DMM off and take out the power cord.
2. Remove the fuse socket using a flathead screwdriver.

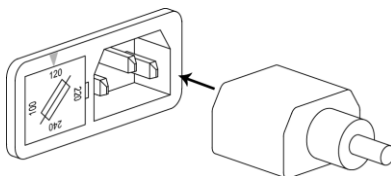

3. Remove the fuse in the holder and replace with the correct type and rating.

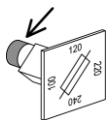

4. Ensure the correct line voltage is lined up with the arrow on the fuse holder. Insert the fuse socket.

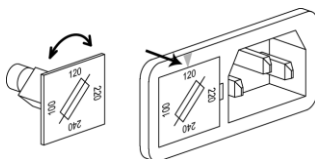

Replacing the Input Fuse

Fuse Rating	Type	Rating	Size
	T0.5A	0.5A 250V	6.3mm X 32mm



Note

Only replace the fuse with a fuse of the correct type and rating.

- Steps
1. Turn the DMM off.
 2. Press the fuse holder with your finger and turn anticlockwise. This will release the fuse holder from the panel.

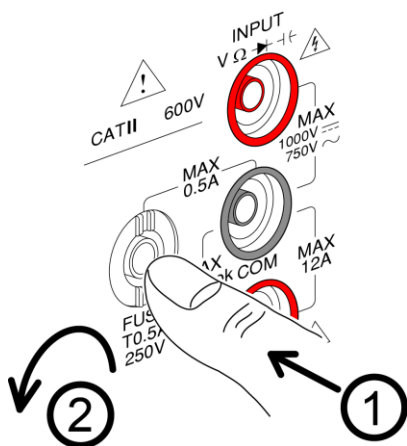

3. Replace the fuse at the end of the holder with the correct type and rating.

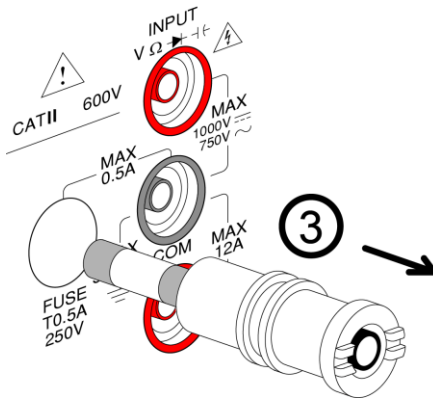

4. Push the fuse holder back into the panel and turn clockwise when the fuse holder is level with the front panel.
-

Status system

The diagram below is a description of the status system

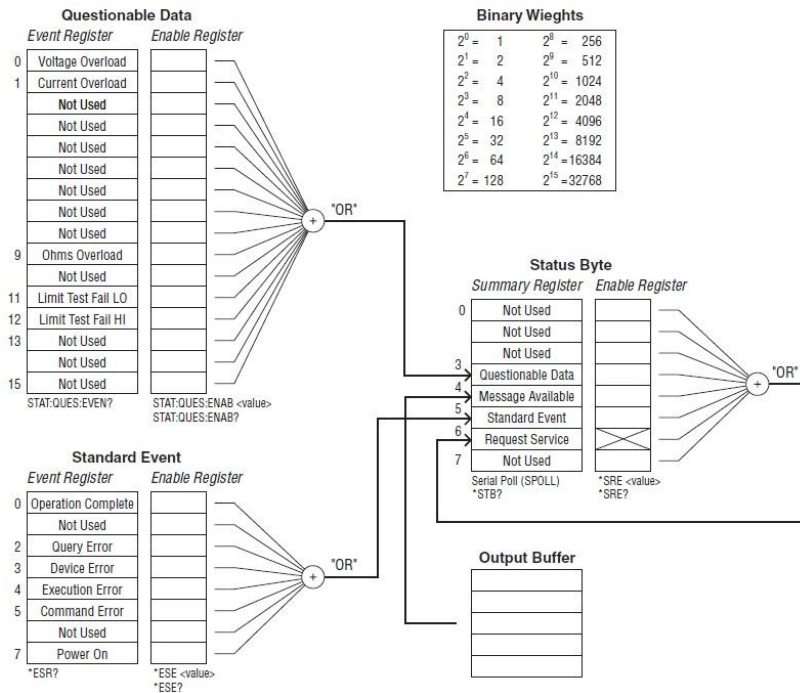

For the following command sets, please refer to the diagram above.

STAT: QUES: EVEN?

STAT: QUES: ENAB

STAT: QUES: ENAB?

*ESR?

*ESE

*ESE?

*STB?

*SRE

*SRE?

Specifications

The specifications apply when the DMM is warmed up for at least 30 minutes and operates in slow rate.

Below are the basic conditions required to operate the DMM within specifications:

- Calibration: Yearly
- Operating Temperature Specification: 18~28°C (64.4~82.4°F)
- Relative Humidity: 80% (Non condensing)
- Accuracy: \pm (% of Reading + Digits)
- AC measurements are based on a 50% duty cycle.
- The power supply cable must be grounded to ensure accuracy.
- All specifications are applicable to the main (1st) display only.

General Specifications

Specification Conditions:

Temperature: 23°C \pm 5°C

Humidity: <80%RH, 75%RH for resistance measurement readings greater than 10M Ω .

Operating Environment: (0~50°C)

Temperature Range: 0~35°C, Relative Humidity: <80%RH;
>35°C, Relative Humidity: <70%RH

Indoor use only

Altitude: 2000 meters

Pollution degree 2

Storage Conditions (-10~70°C)

Temperature Range: 0~35°C, Relative Humidity: <90%RH;
>35°C, Relative Humidity: <80%RH

General:

Power Consumption: Max 15VA

Dimensions: 265 mm (W) X 107 mm (H) X 302 mm (D)

Weight: Approximately 2.9 kg

DC Voltage

Range	Resolution	Full Scale	Accuracy (1 year 23°C ±5°C)	Input Resistance
500mV	10µV	510.00	0.02%+4	10MΩ or >10GΩ
5V	100µV	5.1000		10MΩ or >10GΩ
50V	1mV	51.000		11.1MΩ
500V	10mV	510.00		10.1MΩ
1000V	100mV	1020.0		10MΩ

* When the input value exceeds the full scale of the selected range, the display will show -OL- (over load) on the display.

* The specifications are guaranteed to an input voltage of 1000V. A beeping alarm will go off when the input voltage is higher than 1000V.

* Input protection of 1000V peak on all ranges.

* DC Common Mode Rejection Ratio

>90 dB at dc, 50 or 60Hz ± 0.1% (1kΩ unbalanced, slow rates)

DC Current

Range	Resolution	Full Scale	Accuracy (1 year 23°C ±5°C)	Shunt Resistance	Burden Voltage
500µA	10nA	510.00	0.05%+5	100Ω	0.06V max
5mA	100nA	5.1000	0.05%+4	100Ω	0.6V max
50mA	1µA	51.000	0.05%+4	1Ω	0.14V max
500mA	10µA	510.00	0.10%+4	1Ω	1.4V max
5 A	100µA	5.1000	0.25%+5	10mΩ	0.5V max
10 A	1mA	12.000	0.25%+5	10mΩ	0.8V max

* 500µA~500mA range has a 3.6V voltage limit protection and 0.5A fuse protection. And 10A range has a 12A fuse protection.

* When the input value exceeds the full scale of the selected range, the display will show -OL- (over load) on the display.

* The specifications are guaranteed to an input of 10A. A beeping alarm will go off when the input value is higher than 10A.

AC Voltage, ACV+DCV^[3] (AC Coupled)

Range	Resolution	Full Scale	Accuracy (1 year 23°C ±5°C) [1]			
			30-50Hz	50-10kHz	10K-30kHz	30K-100kHz
500mV	10µV	510.00	1.00%+40	0.50%+40	2.00%+60	3.00%+120
5V	100µV	5.1000	1.00%+20	0.35%+15	1.00%+20	3.00%+50
50V	1mV	51.000	1.00%+20	0.35%+15	1.00%+20	3.00%+50
500V	10mV	510.00	x	0.5%+15	1.00%+20[2]	3.00%+50[2]
750V	100mV	765.0	x	0.5%+15	x	x

[1] Specifications are for sine wave inputs that are greater than 5% range.

[2] Input voltage <300Vrms.

[3] The accuracy of ACV+DCV is equal to ACV's with 10 more digits added.

* The specifications are guaranteed to an input of 750V. A beeping alarm will go off when the input value is higher than 750V.

* Input protection of 1000V peak on all ranges.

* AC-coupled true RMS – measures the AC component of the input with up to 400Vdc of bias on any range.

* AC Common Mode Rejection Ratio.

>60 dB at dc, 50 or 60Hz ± 0.1% (1kΩ unbalanced, slow rates)

* Input impedance 1MΩ±2% in parallel with 100pF.

AC Current, ACI+DCI^[3] (AC Coupled)

Range	Resolu- tion	Full Scale	Accuracy (1 year 23°C ±5°C) [1]				Burden Voltage
			30-50Hz	50-2kHz	2K-5kHz	5K-20kHz	
500µA	10nA	510.00	1.50%+50	0.50%+40	1.50%+50	3.00%+75	0.06V max
5mA	100nA	5.1000	1.50%+40	0.50%+20	1.50%+40	3.00%+60	0.6V max
50mA	1µA	51.000	1.50%+40	0.50%+20	1.50%+40	3.00%+60	0.14V max
500mA	10µA	510.00	1.50%+40	0.50%+20	1.50%+40	3.00%+60[2]	1.4V max
5A	100µA	5.1000	2.0%+40	0.50%+30	x	x	0.5V max
10A	1mA	12.000	2.0%+40	0.50%+30	x	x	0.8V max

[1] The 500µA range requires an input of >35µA to meet specifications. The 5mA~10A ranges need more than 5% of full scale range to meet specifications.

[2] Input current (5k ~ 20kHz)<330mArms.

[3] The accuracy of ACI+DCI is equal to ACI's with 10 more digits added.

* The specifications are guaranteed to 10A. A beeping alarm will go off when the input current being measured is higher than 10A.

Resistance

Resistance	Resolution	Full Scale	Test Current	Accuracy (1 year 23°C ±5°C)[2]
500Ω	10mΩ	510.00	0.83mA	0.1%+5 [1]
5kΩ	100mΩ	5.1000	0.83mA	0.1%+3 [1]
50kΩ	1Ω	51.000	83μA	0.1%+3
500kΩ	10Ω	510.00	8.3μA	0.1%+3
5MΩ	100Ω	5.1000	830nA	0.1%+3
50MΩ	1KΩ	51.000	560nA/10MΩ	0.3%+3

[1] Using the REL function. If you don't use the REL function then increase the error by 0.2Ω.

[2] When measuring resistances greater than 500kΩ, please use shielded test leads to eliminate the noise interference that may be induced by standard test leads.

* Open circuit voltage approximates 6V max on 500~5MΩ range, approximates 5.5V max on 50MΩ range.

* Input protection of 500V peak on all ranges.

Diode

Range	Resolution	Full Scale	Test Current	Accuracy (1 year 23°C ±5°C)
5V	100μV	5.1000	0.83mA	0.05%+5

* Input protection of 500V peak. *Open circuit voltage approximates 6V.

Continuity

Range	Resolution	Full Scale	Test Current	Accuracy (1 year 23°C ±5°C)
5000.0Ω	100mΩ	5100.0	0.83mA	0.1%+5

* Input protection of 500V peak. *Open circuit voltage approximates 6V.

Capacitance

Range	Resolution	Full Scale	Test Current	Accuracy (1 year 23°C ±5°C) [1]
5nF: 0.5~1nF [2]	0.001nF	5.100	8.3μA	2.0%+20
5nF: 1~5nF [2]				2.0%+10
50nF: 5~10nF [2]	0.01nF	51.00	8.3μA	2.0%+30
50nF: 10~50nF [2]				2.0%+10
500nF	0.1nF	510.0	83μA	2.0%+4
5μF	1nF	5.100	0.56mA	
50μF	10nF	51.00	0.83mA	

[1] For the 5nF ~ 50μF range, make sure that the input is greater than 10% of the range.

[2] Need to use the REL function.

* Input protection of 500V peak on all ranges.

Frequency

Measurement Range	Accuracy (1 year 23°C ±5°C)
10Hz ~ 500Hz	0.01%+5
500Hz ~ 500kHz	0.01%+3
500kHz ~ 1MHz	0.01%+5

* AC + DC measurements do not allow frequency measurements.

* Input protection of 1000V peak on all ranges.

Voltage Measurement Sensitivity

Range	Minimum Sensitivity (RMS sine wave)		
	10~100kHz	100k~500kHz	500kHz ~ 1MHz
500mV	35mV	200mV	500mV
5V	0.25V	0.5V	1V
50V	2.5V	5V	5V
500V	25V	uncal	uncal
750V	50V	uncal	uncal

Current Measurement Sensitivity

Range	Minimum Sensitivity (RMS sine wave)
	30~20kHz
500μA	35μA
5mA	0.25mA
50mA	2.5mA
500mA	25mA
5 A	0.25A(<2kHz)
10 A	2.5A(<2kHz)

Temperature Specifications

Sensor	Type	Measurement Range	Resolution	Accuracy (1 year 23°C ±5°C)
Thermocouple	J K T	-200 ~ +300°C	0.1°C	2 °C

* Note: The temperature specifications do not include sensor error.

* Note: This feature is not supported on the GDM-8341.

Dimensions

GDM-8342/GDM-8341

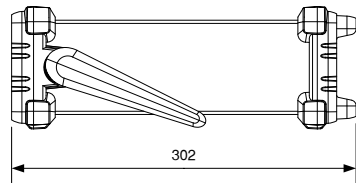
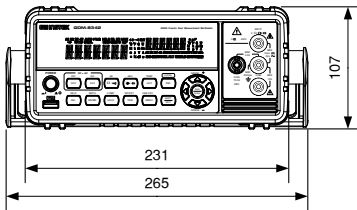
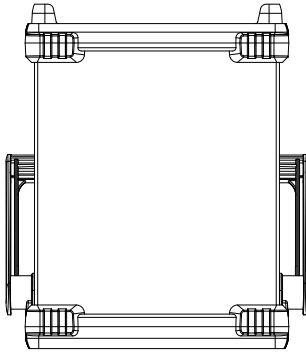

Declaration of Conformity

We

GOOD WILL INSTRUMENT CO., LTD.

No. 7-1, Jhongsing Rd, Tucheng Dist., New Taipei City 236, Taiwan

GOOD WILL INSTRUMENT (SUZHOU) CO., LTD.

No. 69 Lushan Road, Suzhou New District Jiangsu, China.

declare that the below mentioned product

Type of Product: Digital Multimeter

Model Number: GDM-8342, GDM-8341

are herewith confirmed to comply with the requirements set out in the Council Directive on the Approximation of the Law of Member States relating to Electromagnetic Compatibility (2004/108/EC) and Low Voltage Directive (2006/95/EC).

For the evaluation regarding the Electromagnetic Compatibility and Low Voltage Directive, the following standards were applied:

◎ EMC	
EN 61326-1: EN 61326-2-1:	Electrical equipment for measurement, control and laboratory use -- EMC requirements (2013)
Conducted & Radiated Emission EN 55011: 2009+A1:2010	Electrostatic Discharge EN 61000-4-2: 2009
Current Harmonics EN 61000-3-2: 2006+A1: 2009+A2: 2009	Radiated Immunity EN 61000-4-3: 2006+A1:2008+A2:2010
Voltage Fluctuations EN 61000-3-3: 2008	Electrical Fast Transients IEC 61000-4-4: 2012
-----	Surge Immunity EN 61000-4-5: 2006
-----	Conducted Susceptibility EN 61000-4-6: 2009
-----	Power Frequency Magnetic Field EN 61000-4-8: 2010
-----	Voltage Dip/ Interruption EN 61000-4-11: 2004

Low Voltage Equipment Directive 2006/95/EC	
Safety Requirements	EN 61010-1: 2010 EN 61010-2-030: 2010

INDEX

Accessories	12	Current	
Advanced measurement		range	40
compare	70	setting	38
dB	65	Declaration of conformity	156
dBm/ dB calculation	63	Diode	
dBm/W	63	setting	45
hold	69	Display overview	20
Math		Disposal instructions	8
1/X	73	Dual measurement	
MX+B	72	modes	57
overview	72	overview	57
max/ min	66	EN61010	
overview	62	measurement category	6
Percentage	74	pollution degree	8
relative	67	Environment	
supported functions	62	safety instruction	7
Brightness level	78	Factory default settings	
Cancel remote control	105	restore	82
Capacitance		Factory default settings	144
range	47	Frequency	
setting	46	setting	51
Caution symbol	5	Frequency/Period input jack	
Cleaning the instrument	7	settings	80
Command IEEE488.2		Front panel diagram	14
commands	139	Fuse	
Command set		safety instruction	7
CALCulate commands	130	Ground	
CONFigure commands	116	symbol	5
CONFigure2 commands	119	Indicator	
Measure commands	123	reading	32
Remote commands	138	Input jack settings	80
SENSe commands	127	Input resistance	79
STATus report commands	138	Main features	11
SYSTem related commands	136	Marketing	
TRIGger commands	134	contact	142
Compatibility settings	81	Menu tree	143
Continuity		Package contents	13
beeper	50	Period	
threshold	49	setting	51
Continuity		Power up	25
setting	48		
Conventions	26		

Rear panel	thermocouple type	55
overview	units	54
Refresh rate	Tilt stand	24
Remote control.....	Triggering	32
Command list.....	UK power cord.....	9
Command syntax	USB Store	
interface configuration	advance	97
GPIB.....	CSV format	84
USB.....	Date.....	95
Replacing the AC source fuse	deleting files or directories	99
Replacing the input fuse.....	file option setting.....	92
Resistance	filename.....	91
range	filename format.....	85
setting	long record mode	88
Return from remote control ...	operator mode.....	86
Safety instruction	overview	83
fuse.....	save count	91
Serial number.....	save overview	96
Service operation	simple	96
about disassembly.....	status.....	89
contact	time stamp setting	93
Specifications	timer	93
Status system.....	Version number	77
System menu tree	Voltage	
Temperature	comparison table	36
reference junction temperature..	crest factor	37
selection.....	range	34
setting	setting	33
SIM.....	Warning symbol	5