

Digital Power Meter

GPM-8310

USER MANUAL

Rev. A



ISO-9001 CERTIFIED MANUFACTURER

GW INSTEK

This manual contains proprietary information, which is protected by copyright. All rights are reserved. No part of this manual may be photocopied, reproduced or translated to another language without prior written consent of Good Will company.

The information in this manual was correct at the time of printing. However, Good Will continues to improve products and reserves the rights to change specification, equipment, and maintenance procedures at any time without notice.

Good Will Instrument Co., Ltd.
No. 7-1, Jhongsing Rd., Tucheng Dist., New Taipei City 236, Taiwan.

Table of Contents

SAFETY INSTRUCTIONS	5
GETTING STARTED.....	10
Characteristics	11
Appearance	16
Set Up.....	25
BASIC SETTING	28
Setting up measurement range	29
Setting up measurement status	33
Setting up System status	72
MEASUREMENT AND OTHER FUNCTIONS.....	81
Measurement function	82
Other functions	88
Integration measurement function.....	91
Graph measurement function	103
DIGITAL I/O / DA4	121
Digital I/O / DA4 Overview	122
External Remote Control	124
DA4 Output Function	125
User / 4094 Mode	130
REMOTE CONTROL.....	136
Configure Remote Control Interface	137
Configure EOL Character	144
Return to Local Control.....	144
COMMAND OVERVIEW	145
Command Syntax	145

Command List	149
APPENDIX.....	228
Specifications	229
Status system	239
Dimensions	243
Declaration of Conformity.....	244
Power measurement	245
Introduction to IEC-62301	247
EUP Directive Lot6 specifications	248
Connection Guide	249

S SAFETY INSTRUCTIONS

This chapter contains important safety instructions that you must follow during operation and storage. Read the following before any operation to ensure your safety and to keep the instrument in the best possible condition.

Safety Symbols

These safety symbols may appear in this manual or on the instrument.



WARNING

Warning: Identifies conditions or practices that could result in injury or loss of life.



CAUTION

Caution: Identifies conditions or practices that could result in damage to the GPM-8310 or to other properties.



DANGER High Voltage



Attention Refer to the Manual



Protective Conductor Terminal



Earth (ground) Terminal



Do not dispose electronic equipment as unsorted municipal waste. Please use a separate collection facility or contact the supplier from which this instrument was purchased.

Safety Guidelines

General Guideline • Make sure that the voltage input level does not exceed AC600V.



CAUTION

- Make sure the current input level does not exceed 20A.
- Do not place any heavy object on the instrument.
- Avoid severe impact or rough handling that can lead to damaging the instrument.
- Do not discharge static electricity to the instrument.
- Use only mating connectors, not bare wires, for the terminals.
- Do not block or obstruct the cooling fan vent opening.
- Do not perform measurement at the source of a low-voltage installation or at building installations (Note below).
- Do not disassemble the instrument unless you are qualified as service personnel.
- Make sure that the COM terminal to earth is limited to 600Vpk.
- Remove all test leads before disconnecting the mains power cord from the socket.
- If the equipment is used in a manner not specified by the manufacturer, the protection provided by the equipment may be impaired.
- The device should be placed in a place where the plug connected to it can be removed easily.

(Note) EN 61010-1:2010 specifies the measurement categories and their requirements as follows. The GPM-8310 falls under category II 600V.

- Measurement category IV is for measurement performed at the source of low-voltage installation.
- Measurement category III is for measurement performed in the building installation.
- Measurement category II is for measurement performed on the circuits directly connected to the low voltage installation.

Power Supply



WARNING

- AC Input voltage: 100-240 VAC 50/60Hz
- The power supply voltage should not fluctuate more than 10%.
- Connect the protective grounding conductor of the AC power cord to an earth ground, to avoid electrical shock.
- If grounding practice is not well implemented, a certain amounts of noises will be generated when connecting to GPM-001, the handy measurement accessory for GPM-8310.

Cleaning the Instrument

- Disconnect the power cord before cleaning.
- Use a soft cloth dampened in a solution of mild detergent and water. Do not spray any liquid.
- Do not use chemicals containing harsh material such as benzene, toluene, xylene, and acetone.

Operation Environment

- Location: Indoor, no direct sunlight, dust free, almost non-conductive pollution (Note below)
- Temperature: 0°C to 40°C
- Humidity: < 30°C: < 80%RH(non-condensing);
30°C~40°C:<70%RH(non-condensing);
>40°C: <50%RH (non-condensing)
- Altitude: <2000m
- Overvoltage category: OVC II

(Note) EN 61010-1:2010 specifies the pollution degrees and their requirements as follows. The GPM-8310 falls under degree 2.

- Pollution refers to “addition of foreign matter, solid, liquid, or gaseous (ionized gases), that may produce a reduction of dielectric strength or surface resistivity”.
- Pollution degree 1: No pollution or only dry, non-conductive pollution occurs. The pollution has no influence.
- Pollution degree 2: Normally only non-conductive pollution occurs. Occasionally, however, a temporary conductivity caused by condensation must be expected.
- Pollution degree 3: Conductive pollution occurs, or dry, non-conductive pollution occurs which becomes conductive due to condensation which is expected. In such conditions, equipment is normally protected against exposure to direct sunlight, precipitation, and full wind pressure, but neither temperature nor humidity is controlled.

Storage
environment

- Location: Indoor
- Temperature: -40°C to 70°C
- Humidity: <90%RH(non-condensing)

Disposal



Do not dispose this instrument as unsorted municipal waste. Please use a separate collection facility or contact the supplier from which this instrument was purchased. Please make sure discarded electrical waste is properly recycled to reduce environmental impact.

G ETTING STARTED

This chapter describes the GPM-8310 in a nutshell, including accessories, package contents, its main features and front / rear panel introduction.

Characteristics	11
Accessories	14
Package Contents	15
Appearance	16
Front Panel	16
Main Display Overview	19
Rear Panel	22
Set Up	25
Tilting the Stand	25
Power Up	26
Connect the wires to the GPM-8310	27

Characteristics

The GPM-8310 is a high-precision, programmable power meter for using in standby measuring the device with low power such as switching power supplies, transformers, power supplies, adapter and other devices. It equips with a color TFT-LCD screen and also multiple graph displays which are very convenient for reading the measurement results. The GPM-8310 has become a reliable power measurement instruments because of its simple operation, excellent performance, user-friendly graph displays and automatic measurement interface.



Operation

- Press the buttons on the front panel to easily turn on the GPM-8310 measurement function. All settings and measurements results are displayed on the 5-inches TFT-LCD screen panel for easy use of each function.
- Standard display mode: 2 main measurement results and 8 secondary measurement results are displayed in this screen.
- Simple display mode: 4 major measurement results are displayed in this screen.

- Performance
- 6 selectable voltage ranges available from 15V to 600V with 0.1% of reading + 0.05% of range.
 - 12 selectable current ranges available from 5mA to 20A with 0.1% of reading + 0.05% of range.
 - It can even measure the voltage of abnormal wave of CF 3. The half-range CF is up to 6 or 6A.
 - It can even measure the current of abnormal wave of CF 3. The half-range CF is up to 6 or 6A.
 - Total harmonic distortion measurement.
 - 50-orders harmonic test and analysis function.
 - Graph display for measurement results including harmonic orders distribution.
 - Plug-in USB disk data store function including log and screenshot.
 - Auto range function for integration measurement.
-

Features	<ul style="list-style-type: none">• Full five-digit measurement.• Voltage measurement range: 15V ~ 600V or automatic switching• Current measurement range: 5mA ~ 20A or automatic switching• Maximum accuracy of 0.1% of reading + 0.05% of range• 2 main measurement readings and 8 minor measurement readings are displayed in the screen of standard display mode.• 4 main measurement readings are displayed in the screen of simple display mode.• Added stand-alone display of total harmonic distortion measurement function (50 steps)• Test bandwidth of voltage and current: DC ~ 100kHz.• Selectable boot settings (Previous / Default)• Waveform display up to 10kHz along with Harmonic bar and list table <hr/>
Interface	<ul style="list-style-type: none">• Standard interface: USB / RS232 / LAN / GPIB• Optional interface: Digital IO / DA4 <hr/>
Application	<ul style="list-style-type: none">• It can be applied to production test such as power supplies, transformers, motors, electrical equipment and other equipment with low standby power.• It can be applied to power measurement conforms to IEC 62301• It can be applied to assess the power consumption of product design. <hr/>

Accessories

Standard Accessories		
	Part number	Description
	82PM-83100E01	User Manual CD
	82GW1SAFE0M01	Safety Instruction Sheet
	Region dependent	Power Cord
	GTL-209	Test leads: 1x red, 1x black
	GTL-212	Test leads: 1x yellow, 1x blue
Optional Accessories		
	Part number	Description
	GPM-001	Test Fixture
	GTL-234	RS232C cable
	GTL-246	USB cable
	GTL-248	GPIB cable
	GCP-300	Current Probe
	GRA-422	Rack Adapter Panel (19", 2U)
Option	Name	Description
	Opt.01	DA4 (Factory installed)

Package Contents

Check the contents before using the instrument.

Opening the box

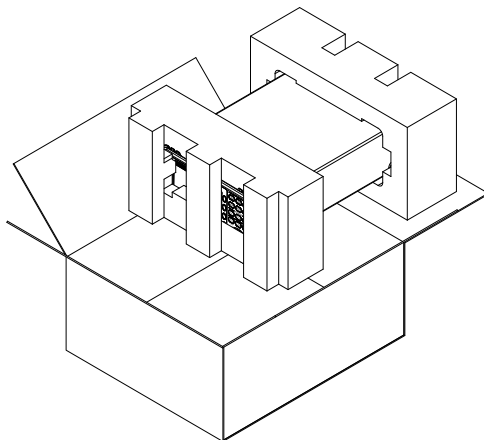

Contents
(single unit)

- Main unit
- Test leads (red x1, black x1, yellow x1, blue x1)
- Power cord x1 (region dependent)
- User manual CD
- Safety instruction sheet

Appearance

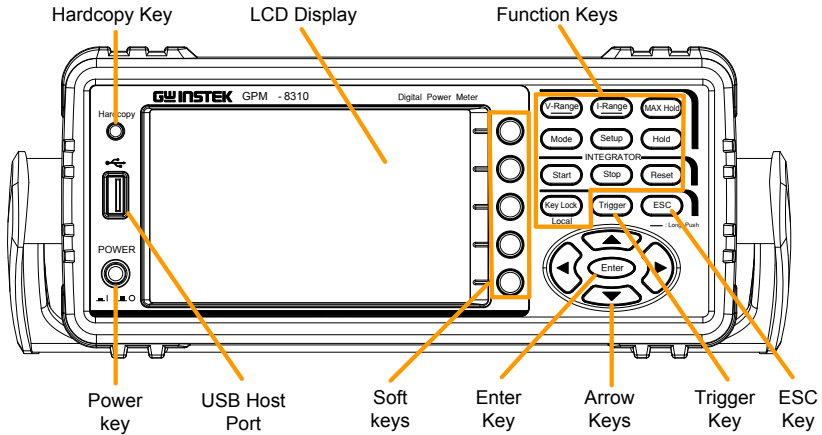

Front Panel



Power Key

POWER



Turns On  or Off  the main power. For the power up sequence, see page 26.

USB Host Port



Connects with USB flash drive for data storage or screenshot.



Hardcopy Key

Hardcopy







Captures the current screenshot or saves the data log for reading. For details, refer to page 67.

Function Keys  V-Range key, up/down arrow keys and Enter key can be used together to select a voltage range or auto range measurement mode. Also, press and hold the V-Range key to toggle between manual and auto range setting. See page 29.







 I-Range key, up/down arrow keys and Enter key can be used together to select a current range or auto range measurement mode. Also, press and hold the I-Range key to toggle between manual and auto range setting. See page 29.









 Press this button to display the maximum measurement reading. See page 89.







 Press this key to select measure mode (DC/AC/AC+DC/V-MEAN). See page 90.

 Press this key to enter the measurement settings menu. See page 33.

 Press this key to switch window and stop refreshing. See page 89.

   Use the left and right arrow keys to select Integrator mode, and press Enter button to enter the time integrator function. See page 91.

 **INTEGRATOR**
Start Stop Reset

		<p>Press this key to toggle to key lock. In Remote control mode, press this button to switch to local mode. See page 90.</p>
<p>Enter Key</p>		<p>This button is used to enter the menu, confirm the settings and switch between the standard display mode and simple display mode (no function table and display icon). See page 89.</p>
<p>Trigger key</p>		<p>Activates the Trigger function. See page 89.</p>
<p>ESC Key</p>		<p>Press this button to cancel the current setting. The cursor returns to the default position or return to the previous menu according to the situation. See page 90.</p>
<p>Arrow Keys</p>		<p>This four arrow keys are used to edit the parameters, browse the menu system and select the parameter range.</p>
<p>Soft Keys</p>		<p>The 5 soft keys have varied functions from the OSD (On-Screen Display) options, individually, per different settings. In addition, from the main display, the 5 soft keys act like shortcuts leading to the 5 secondary menus, for which refer to the page 21. The mapping sequence is from top to bottom of soft keys corresponding to from left to right of secondary menus. For instance, the top soft key enables shortcut to the far left secondary menu (Enlarge) directly.</p>

Main Display Overview

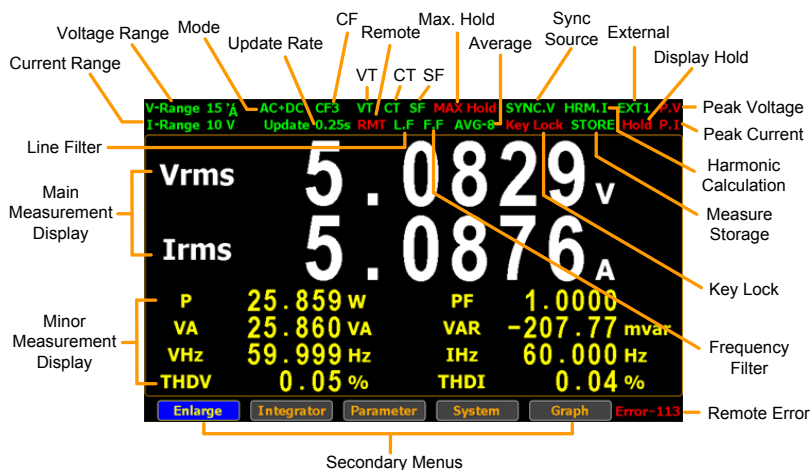

Item	Status icon	Description
Voltage Range	V-Range 15V	Voltage measurement range. Example here range is 15V. V-Auto means that Voltage Auto Range is turned on.
Current Range	I-Range 5A	Current measurement range. Example here range is 5A. I-Auto means that Current Auto Range is turned on.
Mode	AC+DC	Measurement mode (AC, DC, AC+DC, V-MEAN)
Date Update Rate	Update 0.1s	Data update rate (0.1/0.25/0.5/1/2/5/10/20/Auto)
Crest Factor	CF3	Crest Factor (3/6/6A)

VT Ratio State	VT	External voltage magnification (On/Off)
CT Ratio State	CT	External current magnification (On/Off)
Power Ratio State	SF	External power magnification (On/Off)
Remote	RMT	Remote control mode (On/Off)
Line Filter	L.F	Voltage and current filters (On/Off)
Frequency Filter	F.F	Frequency filters (On/Off)
Maximum Hold	MAX Hold	Retain and display the maximum measurement reading.
Average	AVG-8	Average number of sampling (8/16/32/64)
Sync Source	SYNC.V	Synchronization source (V/I/Off)
Keyboard Lock	Key Lock	Lock Key button
Harmonic Calculation	HRM.I	Harmonic calculation method (IEC/CSA/Off)
Measure Storage	STORE	Measured date storage (On/Off)
External Input	EXT1	External signal input function (Ext1/Ext2/Off)
Display Hold	Hold	Retain and display the current measurement reading.
Peak Voltage	P.V	The voltage exceeds the measurement range
Peak Current	P.I	The current exceeds the measurement range
Remote Error	Error-XXX	An error occurs in remote command

Standard Display Mode	Display the measurement result of 2 major and 8 minor measurement parameters
-----------------------	--

Simple Display Mode	Display the measurement result of 4 major measurement parameters
---------------------	--

Secondary menus	Display secondary function menu
-----------------	---------------------------------

- Enlarge This function key is used to switch display of measurement result from 2 major plus 8 minor to 4 major ones.
 - Integrator This function key is used to set up integrator measurement parameters and execute integrator measurement function.
 - Parameter This function key is used set up measurement parameters.
 - System This function key is used to enter the system setting and system configuration screens.
 - Graph This function key is used to set up graph measurement settings and execute measurement in the intuitive graph displays.
-

Rear Panel

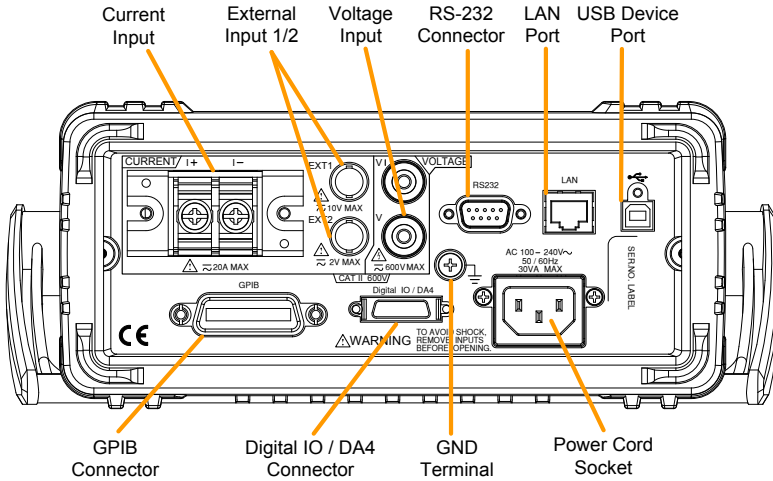

Power Cord Socket

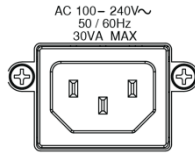

Connects the power cord.
AC 100~240V $\pm 10\%$,
50/60Hz

RS232 Connector

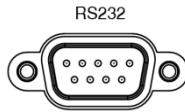

Accepts an RS-232C cable for remote control; DB-9 male connector. For remote control details, see page 138.

GPIB Connector



Accepts an optional GPIB card for remote control. For GPIB details, see page 140.

USB Device Port



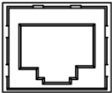

Accepts a USB device cable for remote control; Type B, female connector. For remote control details, see page 137.

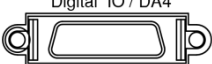
LAN Port  Accepts a LAN for remote control. For remote control details, see page 142.

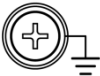
Digital IO / DA4 Connector  Accepts a digital I/O cable for signal output; SCSI 26 pin, female connector. For digital I/O details, see page 122

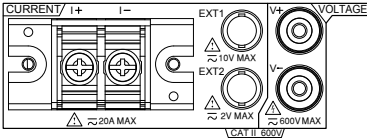
GND Terminal  Connects the GND (ground) terminal to the earth ground.

Voltage/Current input terminal  Voltage/Current input terminals is used to connect the main (measurement signals).

External Input 1/2  Connects output signal to the EXT1 terminal which receives up to 10V, or the EXT2 terminal that receives at the maximum of 2V. See page 59 for setting.



Warning

- Do not use damaged device. Before using the equipment, check its housing first to sure there is no any cracks. Do not operate this device in an environment containing explosive gases, steam or dust.
- The maximum measurable current and voltage are 600 V and 20A for voltage and current terminals of the rear panel of the GPM-8310. Do not input exceeded voltage and current, otherwise it will burn the device.
- The maximum input voltage are 10 V and 2V for EXT1 and EX2 terminals of the rear panel of the GPM-8310. Do not input exceeded voltage, otherwise it will burn the device.
- Always use the supplied cable for connection.
- Before connecting the device, observe all the safety symbols marked on the device.
- Turn off the power to the device and the application system before connecting I/O terminals.
- Do not install replacement parts on the device or perform any unauthorized modifications.
- Do not use this device if the removable cover is removed or loosened.
- Do not connect any cables and terminals before performing self-test.
- Use only the power adapter supplied by the manufacturer to avoid accidental injury.
- Do not use this device for life support systems or any other equipment that has safety requirements.

Set Up

Tilting the Stand

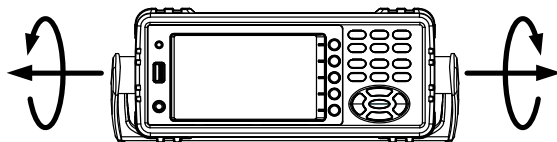

Pull out the handle sideways and rotate it clockwise for the several applications listed below.

Horizontal

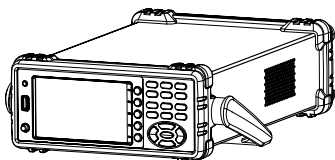

Place the unit horizontally.

Tilt

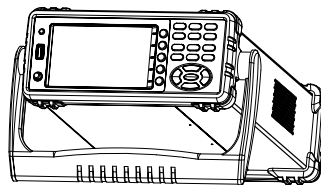

Rotate the handle for tilt stand.

Vertical

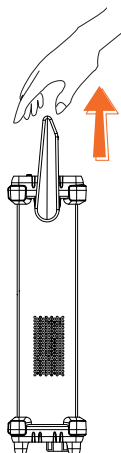

Place the handle vertically for hand carry.

Power Up

Steps

1. Ensure the AC voltage is 100~ 240V.
2. Connect the power cord to the AC voltage input.

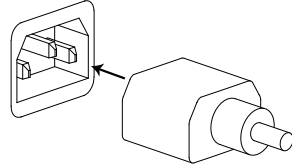

Note

Make sure the ground connector on the power cord is connected to a safety ground. This will influence the measurement accuracy.

3. Push to turn on the main power switch on the front panel.

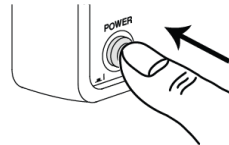

4. The display turns on and shows the last function that was used before the power was reset.

Connect the wires to the GPM-8310

Background Two separate wires is used to connect the GPM-8310, so voltage and current measurement are isolated and don't interfere with each other.

Connection diagram

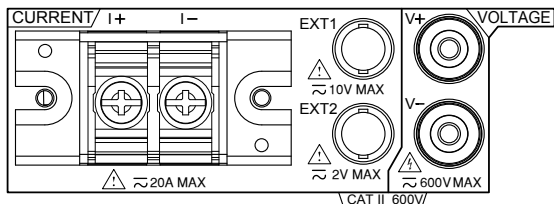

- | | |
|--------------------|--|
| Description | <p>V + The positive voltage input (+), 600V for input on the rear panel.</p> <p>V - The negative voltage input (-), 600V for input on the rear panel.</p> <p>I + The positive current input (+), 20A for input on the rear panel.</p> <p>I - The negative current input (-), 20A for input on the rear panel.</p> <p>EXT1 The external 1 voltage input, 10V for input on the rear panel.</p> <p>EXT2 The external 2 voltage input, 2V for input on the rear panel.</p> |
|--------------------|--|

BASIC SETTING

Setting up measurement range	29
Auto Range	31
Setting up measurement status	33
Setting up synchronization source	33
Setting up line filter	34
Setting up frequency filter	35
Setting up crest factor	36
Setting up auto-zero function	37
Setting up method of calculating harmonics	38
Setting up data update rate.....	40
Setting up measure storage	42
Setting up average function	44
Setting up the voltage and current skipping configuration	46
Setting up the skipping configuration for external	50
Setting up the VT ratio state	53
Setting up the CT ratio state	55
Setting up the power ratio state.....	57
Setting up the external sensor input terminal	59
Saving and loading the setup parameters	61
Setting up the D/A output configuration	63
Setting up the hardcopy and log configuration	67
Setting up the MATH configuration	69
Setting up System status	72
System information screen	72
System configuration screen.....	73
Setting up power on status	75
Setting up brightness	76
Setting up key sound.....	77
Setting up remote interface.....	78
Setting up SCPI identity	80

Setting up measurement range

To get the accurate measurement results, you should set an appropriate measurement range before you perform measurement task.

Set voltage range 1. Press **V-Range** button. The V-Range field turns to bluish.



2. Use up and down arrow keys to select the desired range.

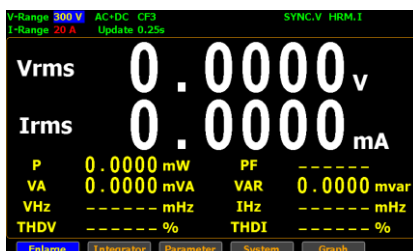

3. Press **Enter** button to confirm your selection.



Available range Crest Factor **AUTO, 15V, 30V, 60V, 150V, 300V, 600V**
is 3:

Crest Factor **AUTO, 7.5V, 15V, 30V, 75V, 150V, 300V**
is 6/6A:

Set current range 1. Press **I-Range** button. The I-Range field turns to bluish.



- Use up and down arrow keys to select the desired range.

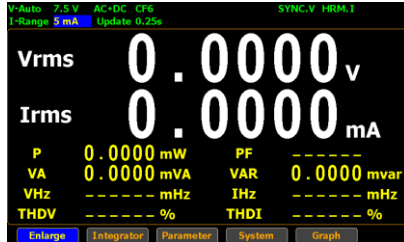

- Press **Enter** button to confirm your selection.



Available range	Crest Factor is 3:	AUTO, 5mA, 10mA, 20mA, 50mA, 100mA, 200mA, 0.5A, 1A, 2A, 5A, 10A, 20A
	Crest Factor is 6/6A:	AUTO, 2.5mA, 5mA, 10mA, 25mA, 50mA, 100mA, 250mA, 0.5A, 1A, 2.5A, 5A, 10A



Note

When it is under the manual setting ranging from 5mA to 200mA, the manual range adjusts to auto range automatically if input current exceeds 700mA.



Note

When the measurement range is set manually, if the range status icon lights in green means that the measured value meets the setting range. On the contrary, if the range status icon lights in red means that the measured value doesn't meet the best setting range. In this case, it is better to switch to other range to get more accurate measurement results.



Note

The P.I status icon lights in red when the current measurement circuit detects that the measured value exceeds setting range by 3 folds (CF is set to 3) or 6 folds (CF is set to 6/6A).



Note

The P.V status icon lights in red when the voltage measurement circuit detects that the measured value exceeds setting range by 3 folds (CF is set to 3) or 6 folds (CF is set to 6/6A).

Auto Range

The range is automatically switched according to the voltage and current of input signal.

Range is shift up

The range is shifted up when either of the following conditions is met.

- Vrms or Irms exceeds the measurement range by 130% at CF 3/6.
 - Vrms or Irms exceeds the measurement range by 260% at CF 6A.
 - The Vpk or Ipk value of the input signal exceeds the current setting range by 300% at CF 3.
 - The Vpk or Ipk value of the input signal exceeds the current setting range by 600% at CF 6/6A.
-

Range is shift down

The range is shifted down when all of the following conditions are met.

- Vrms or Irms is equal to or less than the measurement range by 30% at CF 3/6/6A.
- Vrms or Irms is equal to or less than the next lower measurement range by 125% at CF 3/6/6A.
- The Vpk or Ipk value of the input signal is equal to or less than the next lower measurement range by 300% at CF 3.
- The Vpk or Ipk value of the input signal is equal to or less than the next lower measurement range by 600% at CF 6/6A.

Example

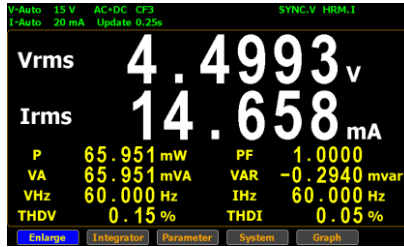

To begin with, the measured Irms value is within the current range of I-Auto 20mA.

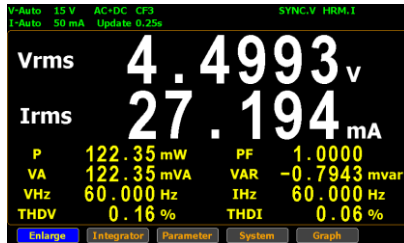



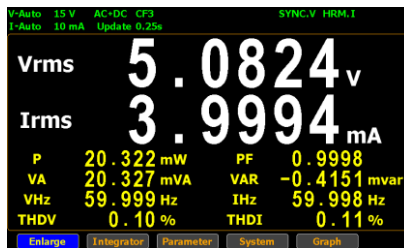

The measured Irms (27.194mA) exceeds the I-Auto 20mA by 130%, so the range is shifted up to 50mA automatically.



The measured Irms (3.9994mA) is less than 30% of the I-Auto 20mA, so the range is shifted down to 10mA automatically.

Setting up measurement status

Setting up synchronization source



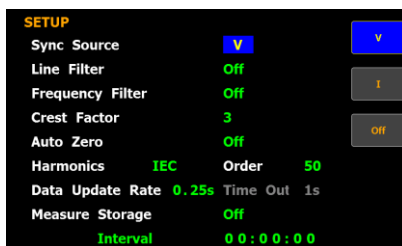

- | | | |
|-------|---|---|
| Steps | 1. Press Setup button. |  |
| | 2. Press Enter button. |  |
| | 3. Press down arrow key to move cursor to the Sync Source field. |  |
| | 4. Use soft keys to select and confirm the desired option. |  |



- | | | |
|--------|------------|--|
| Option | V | Select the voltage of signals as synchronization source. The SYNC.V status icon, for example, on the display lights up in green when V is selected for sync source. |
| | I | Select the current of signals as synchronization source. |
| | Off | Select the entire interval of data updating period as synchronization source. |

Default value **V**

Setting up line filter





- | | | |
|-------|---|---|
| Steps | 1. Press Setup button. |  |
| | 2. Press Enter button. |  |
| | 3. Press down arrow key to move cursor to the Line Filter field. |  |
| | 4. Use soft keys to select and confirm the desired option. |  |



- | | |
|--------|--|
| Option | <p>On Turn on the line filter function, which is inserted into voltage and current measurement input circuits and affects voltage, current as well as power measurements without high frequency components included within measured values. The L.F status icon on the display lights up in green.</p> <p>Off Turn off the line filter function. The cutoff frequency is 500Hz.</p> |
|--------|--|

Default value **Off**

Setting up frequency filter





- | | | |
|-------|--|---|
| Steps | 1. Press Setup button. |  |
| | 2. Press Enter button. |  |
| | 3. Press down arrow key to move cursor to the Frequency Filter field. |  |
| | 4. Use soft keys to select and confirm the desired option. |  |



- | | |
|--------|--|
| Option | <p>On Turn on the frequency filter function, which is inserted into frequency measurement input circuit and affects frequency measurements with high frequency components included within measured values. The F.F status icon on the display lights up in green.</p> <p>Off Turn off the frequency filter function. The cutoff frequency is 500Hz.</p> |
|--------|--|

Default value **Off**

Setting up crest factor





- | | | |
|-------|--|--|
| Steps | <ol style="list-style-type: none"> 1. Press Setup button. 2. Press Enter button. 3. Press down arrow key to move cursor to the Crest Factor field. 4. Use soft keys to select and confirm the desired option. | 

 |
|-------|--|--|



- | | |
|--------|---|
| Option | <ol style="list-style-type: none"> 3 Crest Factor is 3. 6 Crest Factor is 6. 6A Crest Factor is 6A where input range of measurement range will be extended and greater than 6. This is practical for restraining from frequent range changes while measuring, under auto range, a distorted waveform. |
|--------|---|

Default value	3
---------------	----------



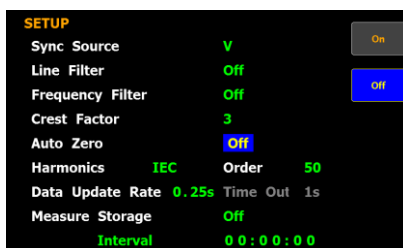

Setting up auto-zero function

- | | | |
|-------|---|---|
| Steps | 1. Press Setup button. |  |
| | 2. Press Enter button. |  |
| | 3. Press down arrow key to move cursor to the Auto Zero field. |  |
| | 4. Use soft keys to select and confirm the desired option. |  |



- | | |
|---------------|---|
| Option | On Auto-zero function is activated once per hour or when range is switched. |
| | Off Auto-zero function is only activated once when the range is switched. The auto-zero function is turned off when the integrator function is executed. |
| Default value | Off |

Setting up method of calculating harmonics

- | | | |
|-------|---|---|
| Steps | 1. Press Setup button. |  |
| | 2. Press Enter button. |  |
| | 3. Press down arrow key to move cursor to the Harmonics field. |  |
| | 4. Use soft keys to select and confirm the desired option. |  |

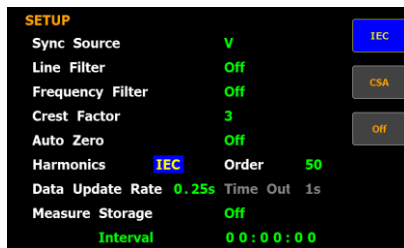

- | | |
|--------|---|
| Option | <p>IEC Calculate the ratio of harmonic quantity of the 2nd through the upper limit 50th harmonic to the 1st harmonic. The HRM.I status icon, for example, on the display lights up in green when IEC is selected for harmonics.</p> <p>CSA Calculate the ratio of harmonic quantity of the 2nd through the upper limit 50th harmonic to the 1st through the 50th harmonic.</p> <p>Off Turn off the harmonic calculation function.</p> |
|--------|---|

Default value **IEC**

- | | | |
|-------|--|---|
| Steps | 5. Press right arrow key to move cursor to Order field. |  |
|-------|--|---|



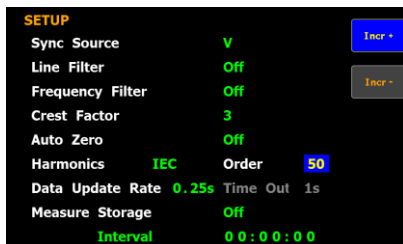

6. Use soft keys to increase or decrease the order number.



Option	1-50	Set the upper limit of measured harmonic order within the range from 1 to 50.
--------	-------------	---

Default value	50	
---------------	-----------	--

Setting up data update rate

- | | | |
|-------|---|---|
| Steps | 1. Press Setup button. |  |
| | 2. Press Enter button. |  |
| | 3. Press down arrow key to move cursor to the Data Update Rate field. |  |
| | 4. Use soft keys to select and confirm the desired option. Press the “ More ” soft keys to toggle among pages for further options. |  |



- | | |
|--------|--|
| Option | <p>0.1s/0.25s/0.5s/1s/2s/5s/10s/20s Measured value is updated in accordance with the designated time interval. The Update 5s status icon, for example, on the display lights up in green when 5s option is selected.</p> <p>Auto Data is only updated when a set period (Time Out) of the input waveform is detected.</p> |
|--------|--|

Default value **0.25s**

- | | | |
|-------|--|---|
| Steps | 5. When Auto is selected, press right arrow key to move cursor to Time Out field. |  |
|-------|--|---|

6. Use soft keys to select and confirm the desired option.







Option	1s/5s/ 10s/20s	Time Out period acts like the time limit for detecting a period of the input waveform.
Default value	1s	



Time Out function is only available when Auto is selected for Data Update Rate.

Setting up measure storage

- | | | |
|-------|---|---|
| Steps | 1. Press Setup button. |  |
| | 2. Press Enter button. |  |
| | 3. Press down arrow key to move cursor to the Measure Storage field. |  |

 **Note** Measure Storage function is Not available when Auto is selected for Data Update Rate.

4. Use soft keys to select and confirm the desired option.

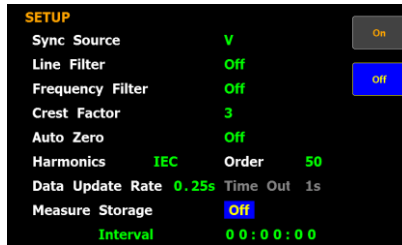

- | | |
|--------|---|
| Option | <p>On All measured date will be stored to the internal memory by designated time interval for repeating the storage operation. The STORE status icon, for example, on the display lights up in green when Measure Storage function is turn on.</p> <p>Off Turn off the measure storage function.</p> |
|--------|---|

Default value **Off**

- | | | |
|-------|--|---|
| Steps | 5. Press down arrow key to move cursor to Interval field. |  |
|-------|--|---|

6. Use soft keys to increase or decrease the interval.

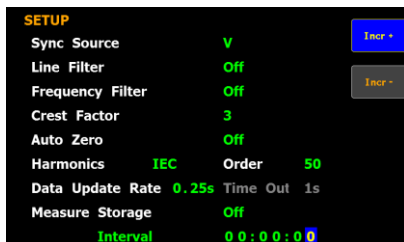

Option The setting range for Interval is from 00:00:00 to 99:59:59.

Default value **00:00:00**







Note

When it is set 00:00:00, the interval for measure storage will be synchronized with the designated Data Update Rate.

Storage stops in the following circumstances:

- When data has been stored to all blocks, Normal measure data can be stored 10000 blocks and Normal with Harmonic data can be stored 1000 blocks.
- When the storage setting is set to Off (while storage is in progress)
- If you press the HOLD key to hold the display while storage is in progress, the measurement operation and the storage interval time counter are held (paused), which causes the storage operation itself to be held. If integration is in progress, this instrument continues measurement and integration in the background.

Setting up average function

- | | | |
|-------|---|---|
| Steps | 1. Press Setup button. |  |
| | 2. Press Average soft key. |  |
| | 3. Press Enter button. |  |
| | 4. Press down arrow key to move cursor to the State field. |  |
| | 5. Use soft keys to select and confirm the desired option. |  |



- | | | |
|--------|------------|--|
| Option | On | Turn Average function On for either Linear or Exponential averages of numeric data. It is particularly practical for large changes in load or power of low input signal frequency. |
| | Off | Turn off Average function. |

Default value **Off**

- | | | |
|-------|--|---|
| Steps | 6. Press down arrow key to move cursor to Type field. |  |
|-------|--|---|

7. Use soft keys to select and confirm the desired option.



Option	Linear	With the designated linear count, it is used to compute linear averages.
	Exponent	With the specified attenuation count, numeric data will be averaged exponentially.

Default value **Linear**





- Steps
8. Press down arrow key to move cursor to **Count** field.
9. Use soft keys to select and confirm the desired option.



Option	8/16/32/64	It includes 8, 16, 32 and 64 for exponentially attenuation count and linearly average count. The AVG-8 status icon, for example, on the display lights up in green when 8 is selected for average.
--------	-------------------	---

Default value **8**

Setting up the voltage and current skipping configuration

- | | | |
|-------|--|---|
| Steps | 1. Press Setup button. |  |
| | 2. Press V / I Range soft key. |  |
| | 3. Press Enter button. |  |
| | 4. Press down arrow key to move cursor to the Mode field. |  |
| | 5. Use soft keys to select and confirm the desired option. |  |

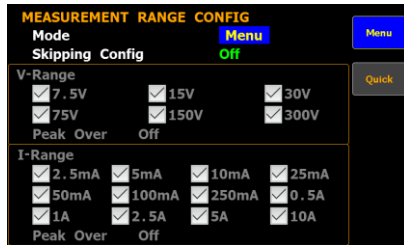

Option **Menu** When user is configuring range setting, the measured data will Not be displayed.

Quick The measured data will be displayed simultaneously while measurement range is being switched by user. This is practical for frequent switch of measurement range.

Default option **Menu**

- | | | |
|-------|---|---|
| Steps | 6. Press down arrow key to move cursor to Skipping Config field. |  |
|-------|---|---|

- Use soft keys to select and confirm the desired option.

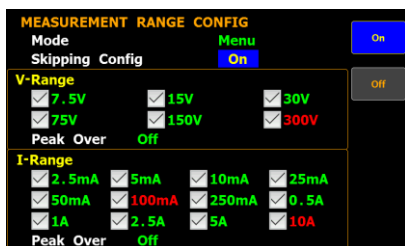

Option **On** It is able to skip certain measurement range(s) that are not used by turning on this feature. It can reduce measured data loss which happens while ranges are switched.

Off Turn off the function.

Default option **Off**

- Press down arrow key to move cursor to each field of both **V-Range** and **I-Range**.



- Use soft keys to enable or disable the skipping function for each range.

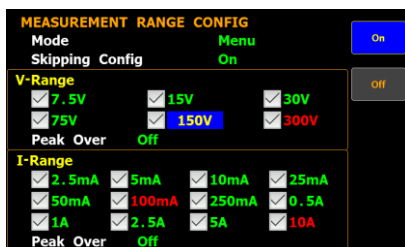

Option **On** The box of range will be checked when the range is enabled for skipping function.

Off The range is disabled for skipping function.

Default option **Off**

Steps

10. Press down arrow key to move cursor to **Peak Over** field for V-Range and I-Range, respectively.



11. Use soft keys to select and confirm the desired option. Press the **More** soft key to toggle among pages for Peak Over of V-Range and I-Range.

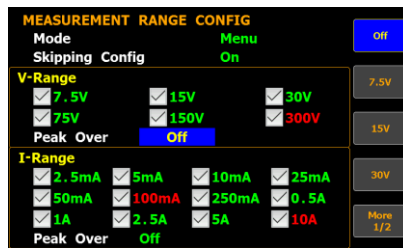

Option

When the occurrence of peak over-range happens in Auto range mode, user is able to define a measurement range to switch to. The available options for each mode are listed below.

When it is under CF3 mode for V-Range.

Off/15V/30V /60V/150V/300V/600V

When it is under CF6/6A mode for V-Range.

Off/7.5V/15V /30V/75V/150V/300V

When it is under CF3 mode for I-Range.

Off/5mA/10mA/20mA/50mA/100mA/200mA/0.5A /1A/2A/5A/10A/20A

When it is under CF6/6A mode for I-Range.

Off/2.5mA/5mA/10mA/25mA/50mA/100mA/250 mA/0.5A/1A/2A/5A/10A





Default option **Off**



Note

The available options for Peak Over field are limited within the selected options from the V-Range and I-Range sections above.

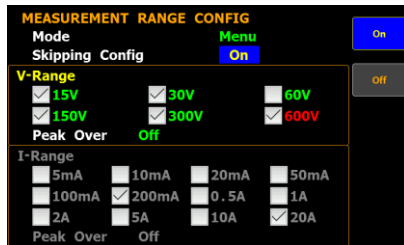

Setting up the skipping configuration for external

- | | | |
|-------|---|---|
| Steps | 1. Press Setup button. |  |
| | 2. Press V / I Range soft key. |  |
| | 3. Press Enter button. |  |
| | 4. Press down arrow key to move cursor to Skipping Config field. |  |
| | 5. Use soft keys to select and confirm the desired option. |  |



- | | | |
|--------|------------|---|
| Option | On | It is able is skip certain measurement range(s) that are not used by turning on this feature for external input. It can reduce measured data loss which occurs while ranges are switched. |
| | Off | Turn off the function. |

Default option **Off**

- | | | |
|-------|------------------------------------|---|
| Steps | 6. Press ESC button. |  |
| | 7. Press External soft key. |  |

8. Press **Enter** button.



9. Press down arrow key to move cursor to each field of either **External Sensor 1** or **External Sensor 2**.



10. Use soft keys to enable or disable the skipping function for each range.

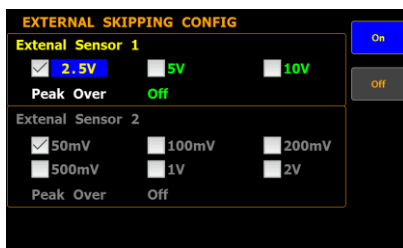

Option

On The box of range will be checked when the range is enabled for skipping function.

Off The range is disabled for skipping function.

Default option

Off

Steps

11. Press down arrow key to move cursor to **Peak Over** field for External Sensor 1 or External Sensor 2, respectively.



12. Use soft keys to select and confirm desired option. Press **More** soft key to toggle among pages for Peak Over of Ext-1 and Ext-2, respectively.

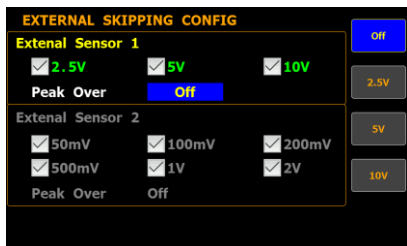

Option When the occurrence of peak over-range happens in Auto range mode for external input, user is able to define a measurement range to switch to. The available options for each mode are listed below.

When it is under CF3 mode for External Sensor 1.

Off/2.5V/5V/10V

When it is under CF6/6A mode for External Sensor 1.

Off/1.25V/2.5V/5V

When it is under CF3 mode for External Sensor 2.

Off/50mV/100mV/200mV/500mV/1V/2V

When it is under CF6/6A mode for External Sensor 2.

Off/25mV/50mV/100mV/250mV/0.5V/1V





Default option **Off**



Note

- The available external is based on which external sensor input is enabled beforehand. Be aware that it requests to enable either Ext1 or Ext2 prior to enabling the skipping config for external.
- The available options for Peak Over field are limited within the selected options from the External Sensor 1 and External Sensor 2 sections above.

Setting up the VT ratio state

- | | | |
|-------|--|---|
| Steps | 1. Press Setup button. |  |
| | 2. Press Ratio soft key. |  |
| | 3. Press Enter button. |  |
| | 4. Press down arrow key to move cursor to the VT Ratio State field. |  |
| | 5. Use soft keys to select and confirm the desired option. |  |



- | | |
|--------|--|
| Option | On Turn on the VT (Voltage Transformer) ratio calculation function and the VT status icon on the display lights up in green. |
| | Off Turn off the VT ratio calculation function. |

Default option **Off**

- | | | |
|-------|---|---|
| Steps | 6. Press down arrow key to move cursor to Ratio field. |  |
|-------|---|---|





7. Use soft keys to increase or decrease coefficient of VT ratio.



Option The setting range for VT Ratio is from 0000.001 to 9999.999.

Default value **0001.000**

Setting up the CT ratio state

- | | | |
|-------|--|---|
| Steps | 1. Press Setup button. |  |
| | 2. Press Ratio soft key. |  |
| | 3. Press Enter button. |  |
| | 4. Press down arrow key to move cursor to the CT Ratio State field. |  |
| | 5. Use soft keys to select and confirm the desired option. |  |



- | | |
|--------|--|
| Option | On Turn on the CT (Current Transformer) ratio calculation function and the CT status icon on the display lights up in green. |
| | Off Turn off the CT ratio calculation function. |

Default option **Off**

- | | | |
|-------|---|---|
| Steps | 6. Press down arrow key to move cursor to Ratio field. |  |
|-------|---|---|





7. Use soft keys to increase or decrease coefficient of CT ratio.



Option The setting range for CT Ratio is from 0000.001 to 9999.999.

Default value **0001.000**

Setting up the power ratio state

- | | | |
|-------|---|---|
| Steps | 1. Press Setup button. |  |
| | 2. Press Ratio soft key. |  |
| | 3. Press Enter button. |  |
| | 4. Press down arrow key to move cursor to the Power Ratio State field. |  |
| | 5. Use soft keys to select and confirm the desired option. |  |



- | | |
|----------------|---|
| Option | On Turn on the power ratio calculation function and the SF status icon on the display lights up in green. |
| | Off Turn off the power ratio calculation function. |
| Default option | Off |

- | | | |
|-------|---|---|
| Steps | 6. Press down arrow key to move cursor to Ratio field. |  |
|-------|---|---|



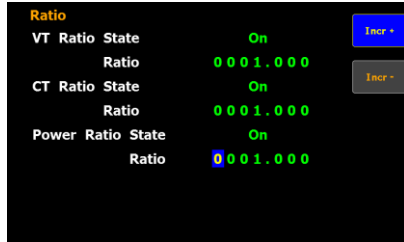

7. Use soft keys to increase or decrease coefficient of power ratio.



Option The setting range for power ratio is from 0000.001 to 9999.999.

Default value **0001.000**

Setting up the external sensor input terminal

- | | | |
|-------|---|---|
| Steps | 1. Press Setup button. |  |
| | 2. Press External soft key. |  |
| | 3. Press Enter button. |  |
| | 4. Press down arrow key to move cursor to the External Sensor State field. |  |
| | 5. Use soft keys to select and confirm the desired option. |  |



- | | |
|--------|---|
| Option | <p>Ext1 Turn on the Ext1 terminal function that receives voltage up to 10V including shunts and clamps from external output current sensor for measurement and the EXT1 status icon on the display lights up in green.</p> <p>Ext2 Almost identical with the Ext1, the Ext2 terminal receives up to 2V voltage and the EXT2 status icon on the display lights up in green when it is enabled.</p> <p>Off Turn off the external sensor input and return to current input terminal.</p> |
|--------|---|

Default option **Off**

Steps 6. Press down arrow key to move cursor to either **Ext1 Ratio (V/A)** or **Ext2 Ratio (mV/A)** field. 

7. Use soft keys to increase or decrease the conversion ratio of either Ext1 or Ext2. 









Option The setting range for both Ext1 and Ext2 is from 0000.001 to 9999.999.

Default value Ext1 **0001.000**
 Ext2 **0010.000**

 **Note** In order to enable range skipping configuration for external (page 50), it is required to enable external input function first.

Saving and loading the setup parameters

Steps	1. Press Setup button.	
	2. Press Page 1/2 soft key.	
	3. Press Save Load soft key.	
	4. Press Enter button.	
	5. Press down arrow key to move cursor to the Type field.	
	6. Use soft keys to select and confirm the desired action.	



Option	Save	Select Save to store setup parameters into the internal memory.
	Load	Select Load to recall setup parameters back from the internal memory.

Default option **Save**

Steps	7. Press down arrow key to move cursor to File field.	
-------	--	---





8. Use soft keys to select and confirm the desired memory set followed by clicking **Ok** soft key to confirm the Save or Load action.



Option	1 - 4	<p>There are 4 sets of internal memories for saving and loading setup parameters. The State field below indicates the status of selected memory set.</p> <p>Free represents the set is empty without saved parameters, whereas Saved indicates the set has been stored with setup parameters.</p>
--------	-------	--

Default option	1
----------------	---

Setting up the D/A output configuration

- | | | |
|-------|------------------------------------|---|
| Steps | 1. Press Setup button. |  |
| | 2. Press Page 1/2 soft key. |  |
| | 3. Press D/A soft key. |  |
| | 4. Press Enter button. |  |

Note Since the DA4 connector is an optional accessory, if it is not available on your unit, the D/A soft key will be disabled in grey color as the figure below shown.

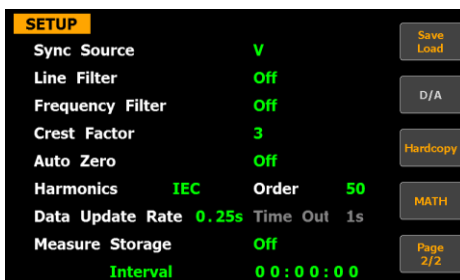

- | | |
|--|---|
| 5. Press down arrow key to move cursor to the Default Mode field. |  |
|--|---|

6. Use soft keys to select and confirm the desired option.

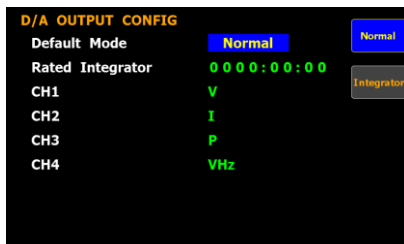

Option **Normal** The D/A output parameters for each channel will be changed to the default setting of Normal mode as follows.

Normal Mode	Default value
CH1	V
CH2	I
CH3	P
CH4	VHz

Integrator The D/A output parameters for each channel will be changed to the default setting of Integrator mode as follows.

Integrator Mode	Default value
CH1	P
CH2	WP
CH3	q
CH4	VHz

Default option **Normal**

- Steps** 7. Press down arrow key to move cursor to **Rated Integrator** field.



- Use soft keys to increase or decrease time for rated integrator.

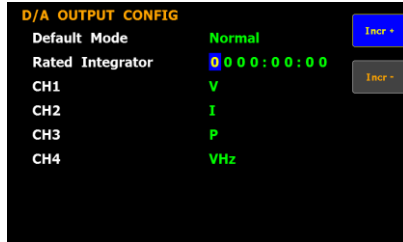

Option

In the integrated values of D/A output, GPM-8310 presumes a rated value is received continuously over the designated time to be 100%, and assigns the value to 5V. The setting range for time of rated integrator is from 0000:00:00 to 9999:59:59. When the time is set 0000:00:00, D/A output value will be 0V.

Default value

0001.00:00

Steps

- Press down arrow key to move cursor to **CH1, CH2, CH3, CH4** field, respectively.



- Use soft keys to select and confirm desired option. Press **More** soft key to toggle among pages for options.

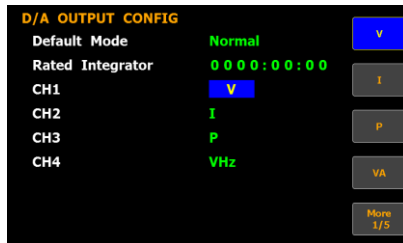







Option

It is available to designate the following output items for each output channel.

V Voltage

I	Current
P	Active power
VA	Apparent power
VAR	Reactive power
PF	Power factor
DEG	Phase angle
VHz	Voltage frequency
IHz	Current frequency
VpK	Voltage peak
IpK	Current peak
WP	Total watt hour
WP+	Positive watt hour
WP-	Negative watt hour
q	Total ampere hour
q+	Positive ampere hour
q-	Negative ampere hour
Off	0V D/A Output

Setting up the hardcopy and log configuration

Steps	1. Press Setup button.	
	2. Press Page 1/2 soft key.	
	3. Press Hardcopy soft key.	
	4. Press Enter button.	
	5. Press down arrow key to move cursor to the Type field.	
	6. Use soft keys to select and confirm the desired option.	

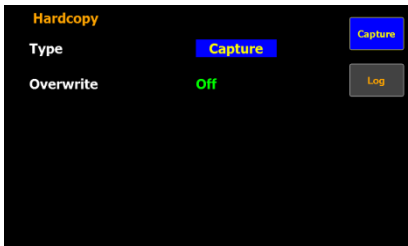

Option	Capture	Select Capture to save screenshot file into the inserted USB disk.
	Log	Select Log to save data log file into the inserted USB disk.

Default option **Capture**

Steps	7. Press down arrow key to move cursor to Overwrite field.	
-------	---	---



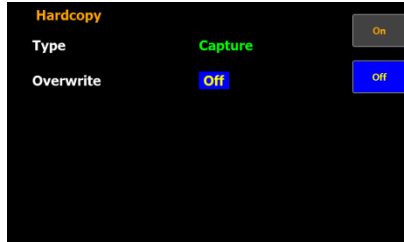



8. Use soft keys to select and confirm the desired action.



Option	On	Turn on overwrite function so that the existed file within the USB disk will be overwritten when saving action is executed.
	Off	By turning off overwrite function, a new saved file will be created and saved into the USB disk when executing saving action.

Default option **Off**

Setting up the MATH configuration

- | | | |
|-------|---|---|
| Steps | 1. Press Setup button. |  |
| | 2. Press Page 1/2 soft key. |  |
| | 3. Press MATH soft key. |  |
| | 4. Press Enter button. |  |
| | 5. Press down arrow key to move cursor to the Computation field. |  |
| | 6. Use soft keys to select and confirm the desired option. |  |

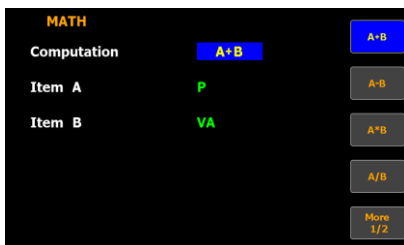

Option	<p>A+B, A-B, A*B, A/B, A/B², A²/B</p>	<p>Up to 6 computations (A+B, A-B, A×B, A÷B, A²÷B, A÷B²), which are based on the four elementary arithmetic (addition, subtraction, multiplication and division), can be executed by GPM-8310 with 2 select items out of 5 variables (V, I, P, VA, VAR). The result of computation will be a value without unit.</p>
--------	--	--

Default option **A/B**

Steps

7. Press down arrow key to move cursor to **Item A** field.



8. Use soft keys to select and confirm the desired option.

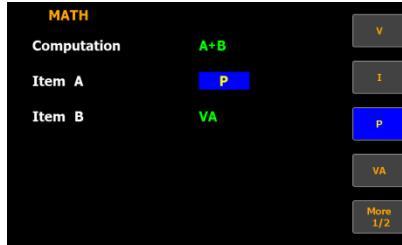

Option

- V Voltage
- I Current
- P Active power
- VA Apparent power
- VAR Reactive power

Default option

V

Steps

9. Press down arrow key to move cursor to **Item B** field.



10. Use soft keys to select and confirm the desired option.

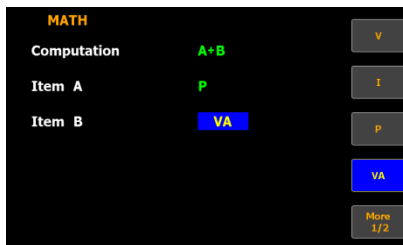

Option

- V Voltage
- I Current
- P Active power
- VA Apparent power
- VAR Reactive power

Default option

I

Setting up System status

System information screen

Steps

1. Use left and right arrow keys on the front panel to select **System** function key.

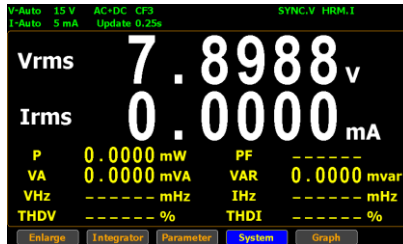

2. Press **Enter** button to Enter **SYSTEM INFORMATION** screen where detailed information including Model, Serial Number, MCU/FPGA Version and MAC Address of the unit is displayed.

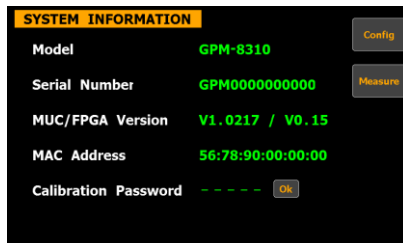

3. Press **Enter** button.



4. Press down arrow key to move cursor to **Calibration Password** field.



- Use soft keys along with left and right arrow keys to input the password followed by pressing **Enter** button twice to enter the Calibration page.

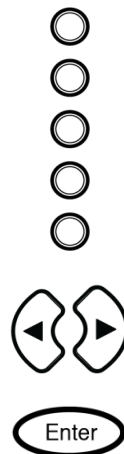

Default option **99999**



Note

Refer to qualified technician and service manual for the calibration procedure.

System configuration screen

Steps

- Use left and right arrow keys on the front panel to select **System** function key.
- Press **Enter** button to Enter SYSTEM INFORMATION screen.



3. Press **Config** soft key to Enter **SYSTEM CONFIG** setting screen.

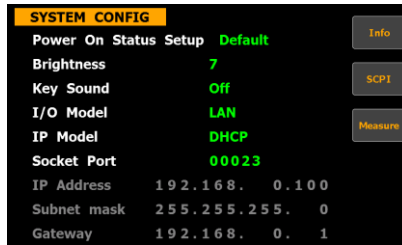

Setting up power on status

Background Continue the following setting from **SYSTEM CONFIG** setting screen

Steps

1. Press **Enter** button.
2. Press down arrow key to move cursor to **Power On Status Setup** field.
3. Use soft keys to select and confirm the desired option.

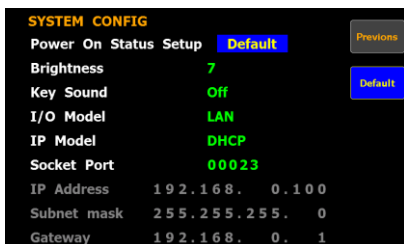



Option

- Previous** The status of unit on powering on is set to the status before the last shutdown.
- Default** The status of unit on powering on is set to the factory default status.

Default value

Default

Setting up brightness

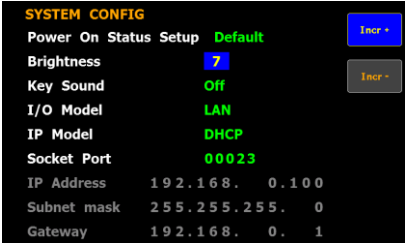
Background	Continue the following setting from SYSTEM CONFIG setting screen	
Steps	<ol style="list-style-type: none"> 1. Press Enter button. 2. Press down arrow key to move cursor to Brightness field. 3. Use soft keys to increase or decrease the brightness level 	  
		
Option	1 - 10	The display is the darkest when set to 1. On the contrary, it turns out the brightest when set to 10.
Default option	7	

Setting up key sound

Background Continue the following setting from **SYSTEM CONFIG** setting screen

Steps

1. Press **Enter** button.
2. Press down arrow key to move cursor to **Key Sound** field.
3. Use soft keys to select and confirm the desired option.

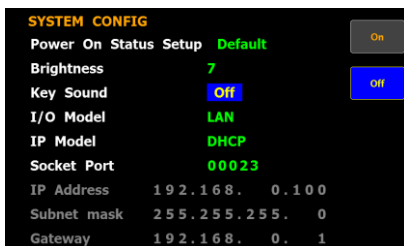

Option

- On** A short sound is heard from speaker of unit when pressing the keys on the front panel.
- Off** No sound from speaker of unit when pressing the keys on the front panel.

Default option

Off

Setting up remote interface

Background Continue the following setting from **SYSTEM CONFIG** setting screen

Steps

1. Press **Enter** button.
2. Press down arrow key to move cursor to **I/O Model** field.
3. Use soft keys to select and confirm the desired option.

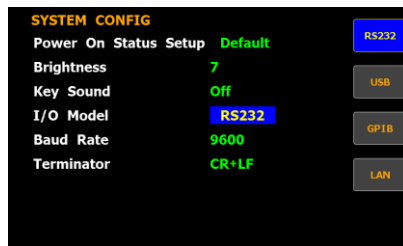

Option

RS232 If interface is set to RS232, the **Baud Rate** and the **Terminator** fields can be selected. For details about configuring RS 232 interface, please see page 138.

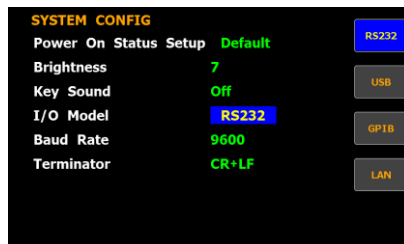

USB For details about configuring USB interface, please see page 137.

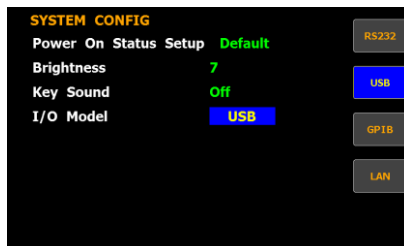

GPIB If interface is set to GPIB, the **GPIB Address** can be selected from “1” to “30”. Please see page 140 for details.

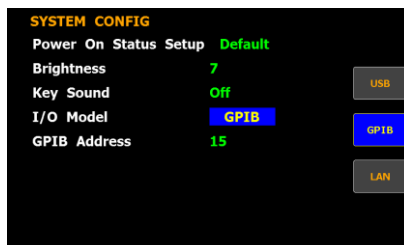



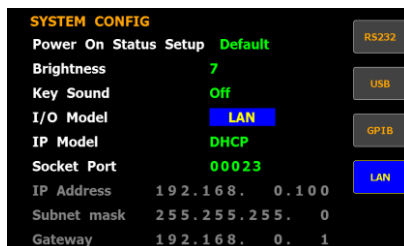

LAN If interface is set to LAN, the IP model is can be selected from “Manual” and “DHCP”. For details about configuring LAN interface, please see page 142.



Setting up SCPI identity

Background Continue the following setting from **SYSTEM CONFIG** setting screen

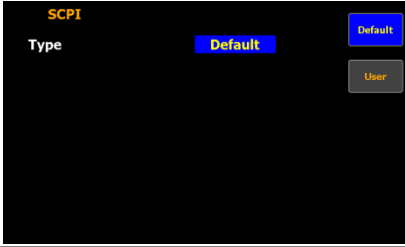
- Steps**
1. Press **SCPI** soft key to enter **SCPI** setting screen. 
 2. Press **Enter** button. 
 3. Press down arrow key to move cursor to **Type** field. 
 4. Use soft keys to select and confirm the desired option. 
- 

Option

Default The return message in remote control returns the default manufacturer, model number, serial number, among other info.

User User-defined manufacturer, model number and so forth will be returned for remote control mode.

Default value **Default**

M EASUREMENT AND OTHER FUNCTIONS

Measurement function	82
Introduction to measurement parameters	82
Setting measurement parameters	83
Changing the standard and simple display modes	86
Other functions	88
Introduction to other functions.....	88
Integration measurement function	91
Setting up Integrator measurement	91
Introduction to integrator parameters	97
Using the integrator function.....	100
Graph measurement function	103
Setting up waveform graph measurement	103
Setting up waveform graph parameter	111
Setting up Harmonics bar graph measurement.....	114
Setting up Harmonics list graph measurement	117

Measurement function

The GPM-8310 provides a wide range of basic electricity and power measurement functions. It equips with different accurate measurement parameters for accurately measuring the voltage, current, power, DC/AC/AC + DC/V-MEAN, power factor, harmonics, frequency, etc. The input impedance of the device is 2MΩ, the maximum input voltage is 600Vrms. There are 2 sets of internal resistance (Shunt), 500mΩ and 5mΩ respectively. Also, there are 2 external current input terminals (EXT1, EXT2). The maximum input current is 20Arms. The device will issue a warning sound when the input voltage and current exceed 850 Vrms or 28.5Arms.

Introduction to measurement parameters



Parameter name	Display icon
Voltage	Vac (AC)
	Vdc (DC)
	Vrms (AC+DC)
	Vmn (V-MEAN)
Current	Iac (AC)
	Idc (DC)
	Irms (AC+DC, V-MEAN)
Active Power	P

Apparent Power	VA
Reactive power	VAR
Power Factor	PF
Phase Angle	DEG
Frequency	IHz, VHz
Voltage Peak	V+pk, V-pk
Current Peak	I+pk, I-pk
Active Power Peak	P+pk, P-pk
Total Harmonic Distortion	THDI, THDV
Crest factor	CFV, CFI
Mathematical Computation	MATH
Maximum Current Ratio (Crest Factor(CFI) / Power Factor)	MCR

Setting measurement parameters

Steps

1. Use left and right arrow keys on the front panel to select **Parameter** function key.



2. Press **Enter** button. The 1st measurement parameter will be highlighted in green.



3. Press up, down, left and right arrow keys to select other desired measurement parameter.

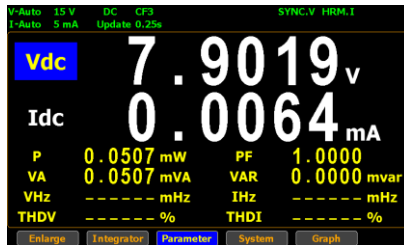

4. Press **Enter** button followed by using up and down arrow keys to switch display options for the selected measurement parameter.



5. User is able to apply the previous same process for each measurement parameter. There are up to 2 major and 8 minor measurement parameters to be switched.

Changing the standard and simple display modes

Steps

1. In the standard display mode, use left and right arrow keys on the front panel to select **Enlarge** function key.

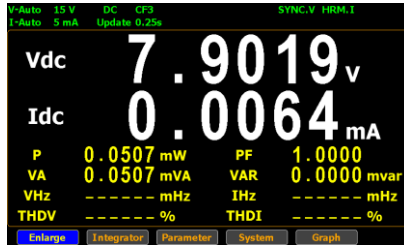

2. Press **Enter** button to switch display to simple mode.



The simple mode covers 4 major measurement parameters deriving from the top 4 parameters of standard mode as shown below.



3. Press ESC button to return back to original display mode.





ESC

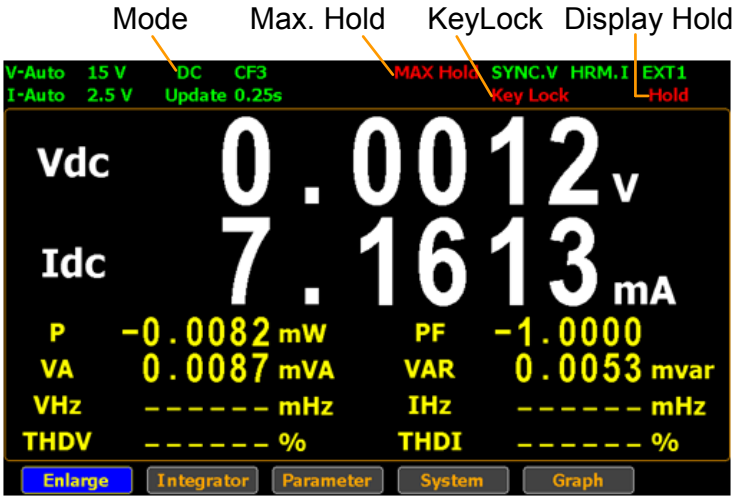

Other functions

Introduction to other functions



Function name	Button	Description
---------------	--------	-------------

MAX Hold		<p>When the MAX Hold button is pressed, the MAX Hold status icon will light in red in the LCD display to indicate that this function is activated. To deactivate this function, press this button again.</p> <p>If the MAX Hold function is activated, the display value on the display is updated only when the current measured value is greater than the previous measured value. The maximum display value is retained on the display. Only the following parameters are available for MAX Hold function: V, I, P, S, Q, V+pk, V-pk, I+pk, I-pk, P+pk, and P-pk.</p>
Enter		<p>This button is used to select function or confirm selection.</p>
Hold		<p>When the Hold button is pressed, the Hold status icon will light in red in the LCD display to indicate that this function is activated. To deactivate this function, press this button again.</p> <p>When the Hold function is activated, the displayed value on the LCD display is not updated and the range is locked. Measurement is performed in the background.</p>
Trigger		<p>Press the Trigger button when Hold function is activated to update displayed value to the latest status once in accordance with the Data Update Rate period.</p>

ESC		This button is used to exit current screen or return to the main measurement screen.
Local/ Key Lock		Dual function key. When Remote mode is activated, press this button to deactivate Remote mode and switch to Local mode. When Remote mode is not activated, this button is used as lock key of keypad.
Mode		<p>Press the Mode button to select measurement mode. There are 4 measurement modes.</p> <ul style="list-style-type: none">• AC+DC: Displays all the components of measurement signal.• DC: Displays the DC part of the measurement signal.• AC: Displays the AC part of the measurement signal.• V-MEAN: Displays the voltage rectified as a mean value that is calibrated to RMS value. The value is same with those obtained from RMS mode when sine waves are measured, but it is different when DC or distorted waves are measured.

Integration measurement function

Setting up Integrator measurement

Steps

1. Use left and right arrow keys on the front panel to select **Integrator** function key.

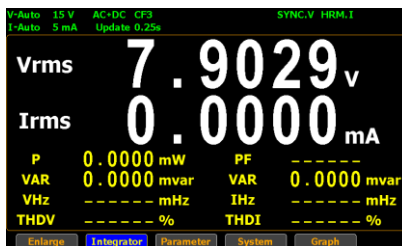

2. Press **Enter** button to enter the integrator measurement screen.

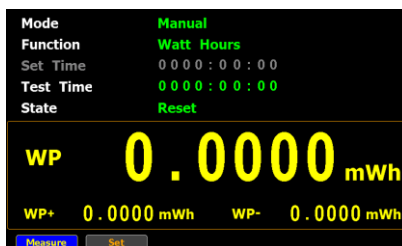

3. Press right arrow key to move cursor to **Set** key.



Select integrator measurement mode

4. Press **Enter** button to enter integrator measurement setting screen.



- Press **Enter** button to enter **Mode** field. Use up and down arrow keys to toggle between Manual, Standard and Continuous mode. Press **Enter** button again to confirm your selection.



If you select **Manual** mode, the Set time become disable and displayed in gray.

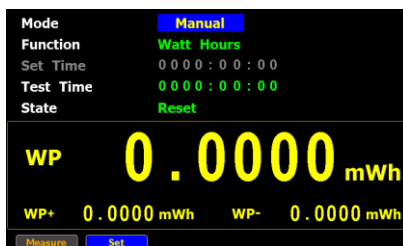

If you select **Standard** or **Continuous** mode, you need to set integrator measurement time before using integrator function. It can be set from 1 second to 9999 hours, 59 minutes and 59 seconds.



When the Set Time is zero, neither Standard mode nor Continuous mode can be executed.

Select integrator measurement function

6. Press down arrow key to move to **Function** field in the integrator measurement setting screen.

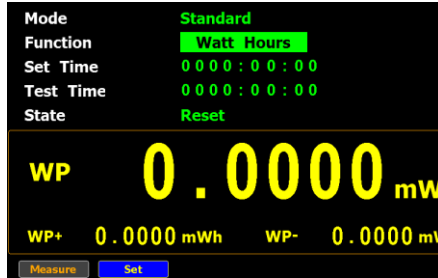

7. Press **Enter** button to enter **Function** field. Use up and down arrow keys to toggle between Ampere Hours and Watt Hours. Press **Enter** button again to confirm your selection.

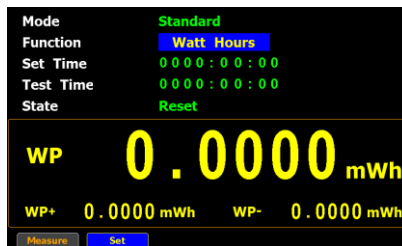

If you select **Ampere Hours**, the measured value in the bottom half section will be displayed in “q”.



If you select **Watt Hours**, the measured value in the bottom half section will be displayed in “WP”.

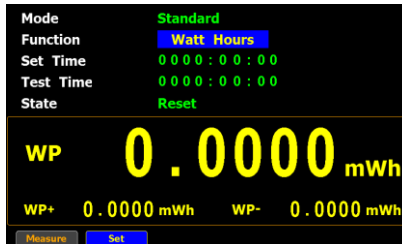

- Select integrator measurement parameter
8. Press down arrow key to move to the bottom half section where measured values are displayed.

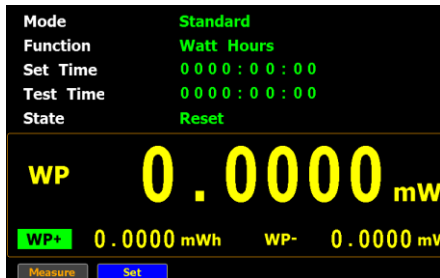

9. Press **Enter** button to enter the 1st minor parameter followed by using up and down arrow keys to switch to preferred measurement parameter. Press **Enter** button again to confirm the selection.

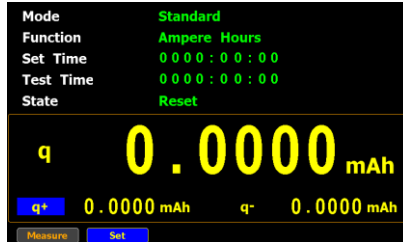

Press left or right arrow keys to move to the 2nd minor parameter followed by using the steps above to select a preferred parameter.

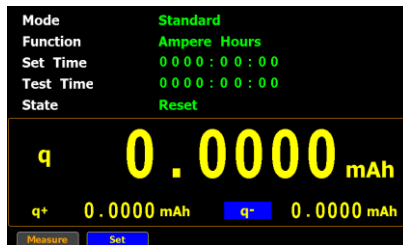

Introduction to integrator parameters

Parameter name	Description
----------------	-------------

Mode

- **Standard**

It allows user to define a period of Set Time for integrator measurement, which ranges from 1 second to 9999 hours, 59 minutes and 59 seconds.

- **Manual**

User is not able to define a Set Time. The integrator measurement will be running constantly till Stop button is pressed by user.

- **Continuous**

Partly identical with the Standard mode, the integrator measurement runs for a cycle of the Set Time and repeats the cycle indefinitely until Stop button is pressed by user.

Function

- **Watt Hours**

WP: Total power
 WP+: Positive total power
 WP-: Negative total power
 P(avg): Average power



- **Ampere Hours**

q: Total mAh
 q+: Positive total mAh
 q-: Negative total mAh
 q(avg): Average current

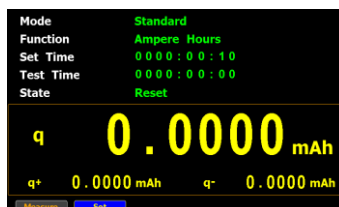

Test time

It indicates that elapsed time of integrator measurement.

Set time It indicates the time of integrator measurement to be set. It can be set from 1 second to 9999 hours, 59 minutes and 59 seconds.



State

- **Running** Integrator measurement is in progress.



- **Stop** Integrator measurement has been stopped manually.

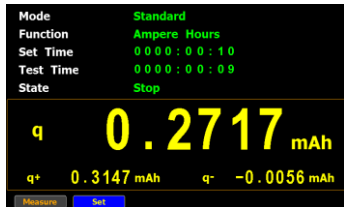

- **Timeout** The time for running integrator measurement is up.

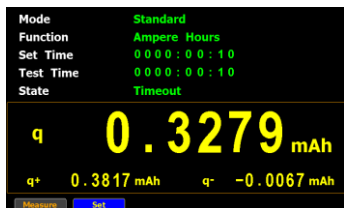

- **Reset** The integrator measurement status is cleared.

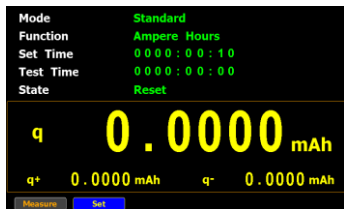

Measured value parameters

For Watt Hours

Positive total power: **WP+**

Negative total power: **WP-**

Average power: **P(avg)**

Voltage: **Vdc** (DC voltage), **Vac** (AC voltage),

Vrms (AC+DC voltage), **Vmn** (Voltage mean)

Current: **Idc** (DC current), **Iac** (AC current), **Irms** (AC+DC current)

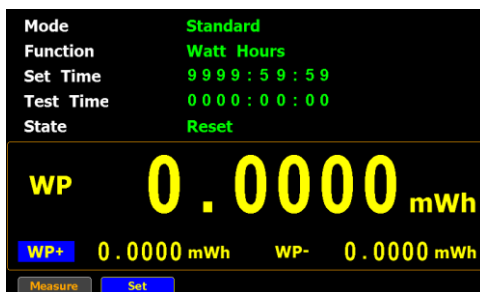

For Ampere Hours

Total mAh: **q**

Positive total mAh: **q+**

Negative total mAh: **q-**

Average Current : **q(avg)**

Voltage: **Vdc** (DC voltage), **Vac** (AC voltage),

Vrms (AC+DC voltage), **Vmn** (Voltage mean)

Current: **Idc** (DC current), **Iac** (AC current), **Irms** (AC+DC current)

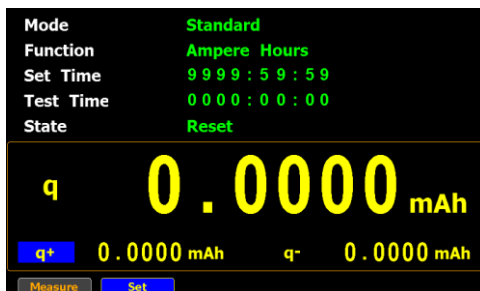

Using the integrator function

Manual mode

1. In manual mode, you can directly press the **Start** button in the front panel to start integrator function.



2. To stop integration function, press the **Stop** button in the front panel.



3. Press the **Reset** button in the front panel to clear integrator.



- Standard mode
1. Set integrator measurement time before using integrator function.
 2. Other steps are same as running in manual mode.

When integrator performing, the test time will increase until the setting integrator measurement time.

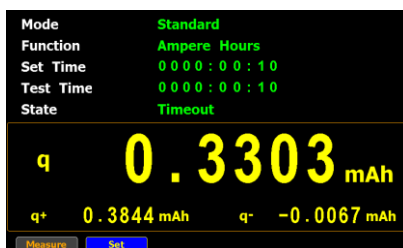

- Continuous mode
1. Set integrator measurement time before using integrator function.
 2. Other steps are same as running in manual mode.

When integrator performing, the test time will increase until the setting integrator measurement time (a cycle) and repeat the cycle indefinitely until the Stop button is pressed by user.





Note

- In the integration process, select the **Measure** key and press **Enter** button to return main measurement screen. Select **Integrator** key and press **Enter** button to switch back to integration measurement screen.
- In the integration process, you can Not change measurement range and enter system to set measurement parameters.
- In the integration process, if the voltage or current measurement value exceeds, the measured value will display in red. However, it will not turn out red color when Auto Range is activated.

Graph measurement function

The GPM-8310 provides the professional graph measurement function via which user can have a well grip over fluctuations of measured values in waveform and harmonic in bar and list graphs in a friendly user interface. It is available, under the graph mode, to adjust both voltage and current ranges in real time and change the display modes along with relevant parameters with ease.

Setting up waveform graph measurement

Steps

1. Use left and right arrow keys on the front panel to select **Graph** function key.

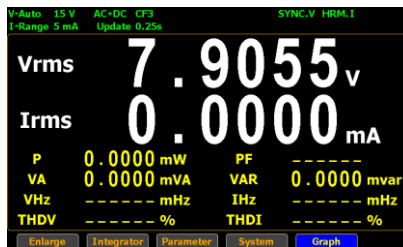

2. Press **Enter** button to enter the Waveform graph display screen in which the measured values are displayed in distinctive waveforms.

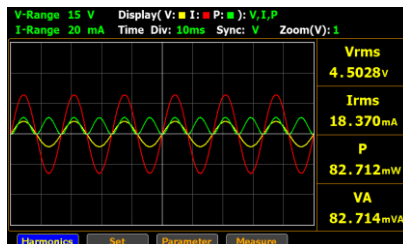

- Press right arrow key to move cursor to **Set** key.

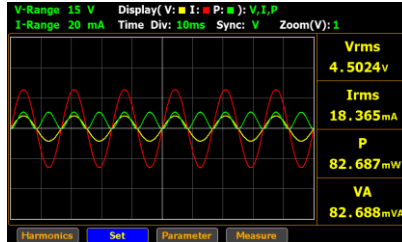

Select waveform display mode

- Press **Enter** button to enter waveform setting section.

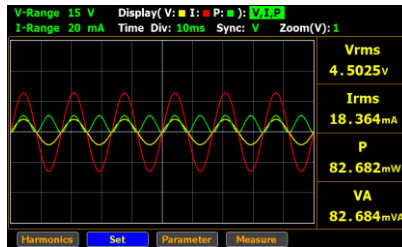

- Press **Enter** button to enter **Display** field. Use up and down arrow keys to toggle between options. Press **Enter** button again to confirm your selection.

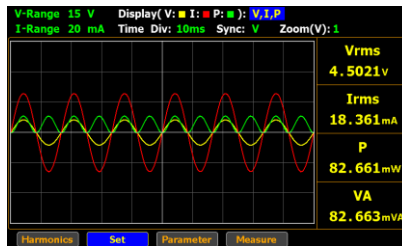

Option	<p>V, I, P Three items including the measured voltage, current and power are displayed in waveforms of different colors (V: yellow, I: red, Power: green) within the waveform chart.</p> <p>V, I Two items including the measured voltage and current are displayed in waveforms of different colors (V: yellow, I: red) within the waveform chart.</p> <p>V Only the measured voltage in the waveform of yellow color is displayed within the chart.</p> <p>I Only the measured current in the waveform of red color is displayed within the chart.</p> <p>P Only the measured power in the waveform of green color is displayed within the chart.</p>
--------	--

Default option **V, I, P**

Select waveform display time division 6. Press down arrow key to move to **Time Div** field in the waveform setting section.

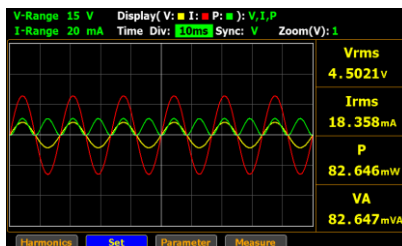

- Press **Enter** button to enter **Time Div** field. Use up and down arrow keys to toggle between options. Press **Enter** button again to confirm your selection.

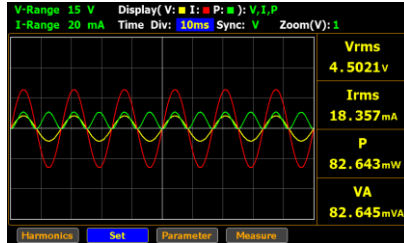

Option	25us, 50us, 100us, 250us, 500us, 1ms, 2.5ms, 5ms, 10ms, 25ms, 50ms, 100ms, 250ms, 500ms, 1s	The diversified time units allow user to customize a preferred waveform graph display. In theory, shorter the measured period, smaller the time unit is fitting. In contrast, longer the measured period, greater the time unit is suitable. Select a proper option per varied measurements.
--------	---	--

Default option **5ms**



Note

The available options for Time Div vary per set Update Time. Refer to page 109 for correlations.

- Select waveform display sync source
- Press right arrow key to move to **Sync** field in the waveform setting section.

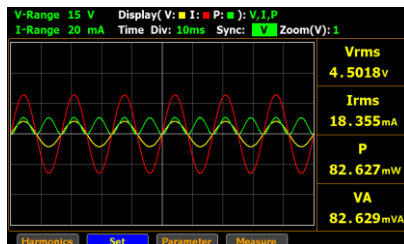

- Press **Enter** button to enter **Sync** field. Use up and down arrow keys to toggle between options. Press **Enter** button again to confirm your selection.

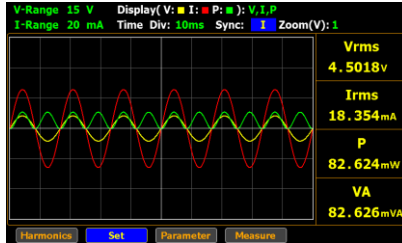

- | | | |
|--------|------------|---|
| Option | V | Select the voltage of signals as synchronization source. |
| | I | Select the current of signals as synchronization source. |
| | Off | Select the entire interval of data updating period as synchronization source. |

Default option **V**

- Press right arrow key to move to **Zoom (V)** field in the waveform setting section.

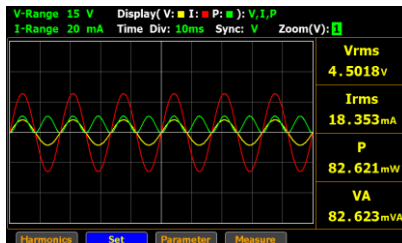

- Press **Enter** button to enter **Zoom (V)** field. Use up and down arrow keys to toggle between options. Press **Enter** button again to confirm your selection.

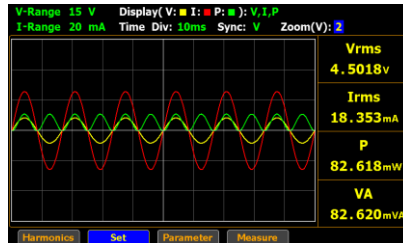

Option

- 1, 2, 3 The varied zoom magnifications allow user to customize a preferred waveform graph display. In theory, narrower the measured value, greater the zoom magnification is suitable. In contrast, wider the measured value, smaller the zoom magnification is fitting. The 1 stands for the standard magnification and the 3 represents the highest zoom magnification.

Default option

1

Zoom 1:

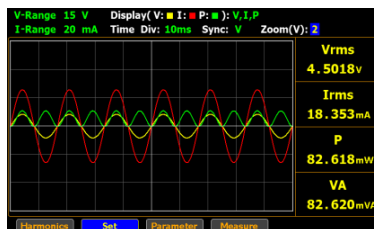

Zoom 3:

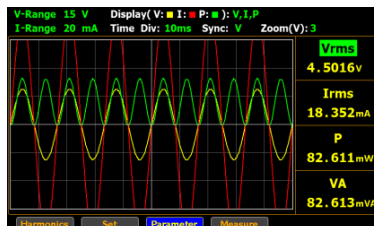

Frequency over limit

When frequency of either voltage or current is beyond the limit, which varies per set Time Div, the warning message in the upper-right corner will be shown to alarm user as the figures below.

F_V_O:
Frequency Voltage Over

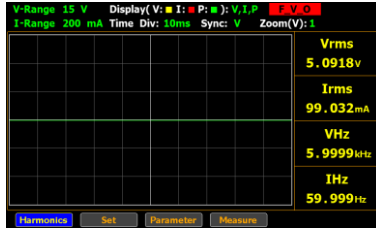

F_I_O:
Frequency Current Over

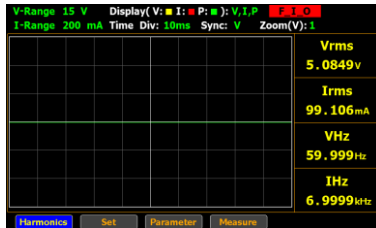

F_V_I_O:
Frequency Voltage & Current Over

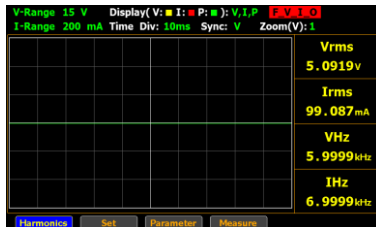

Correlation of Limit Frequency, Time Div and Update Time

Time Division	Update Time							
	0.1	0.25	0.5	1	2	5	10	20
1s								•
500ms							•	•
250ms							•	•
100ms					•	•	•	•
50ms				•	•	•	•	•
25ms			•	•	•	•	•	•
10ms		•	•	•	•	•	•	•
5ms	•	•	•	•	•	•	•	•
2.5ms	•	•	•	•	•	•	•	•
1ms	•	•	•	•	•	•	•	•
500us	•	•	•	•	•	•	•	•
250us	•	•	•	•	•	•	•	•
100us	•	•	•	•	•	•	•	•
50us	•	•	•	•	•	•	•	•
25us	•	•	•	•	•	•	•	•
Limit Frequency	10kHz	5kHz	2.5kHz	1kHz	500Hz	250Hz	100Hz	50Hz

Take few examples below that derive from the table above for further descriptions.

- When Update Time is set 20s, the range of Time Div is from 5ms to 1s and the available Frequency is up to 50Hz.
- When Update Time is set 0.1s, the range of Time Div is from 25us to 5ms and the available Frequency is up to 10kHz.
- The maximum frequency for Graph mode is up to 10kHz.
- When the measured frequency of either voltage (VHz) or current (IHz) surpasses the available frequency, which is based on the set Time Div, the warning message will be shown accordingly.



Note

Setting up waveform graph parameter

Steps

1. Use left and right arrow keys on the front panel to select **Graph** function key.

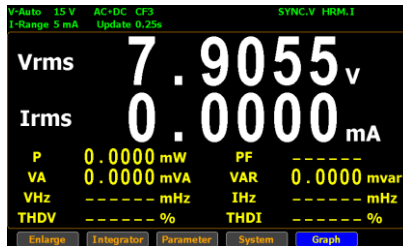

2. Press **Enter** button to enter the Waveform graph display screen.

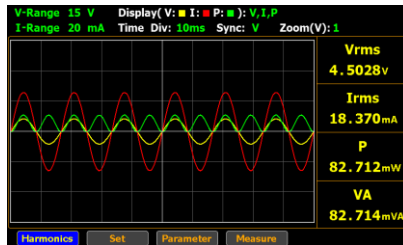

3. Press right arrow key to move cursor to **Parameter** key.

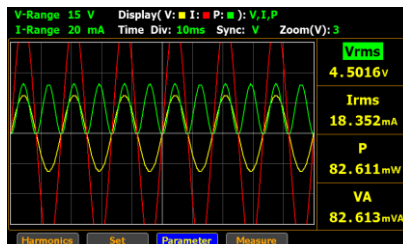

4. Press **Enter** button to enter parameters setting section.

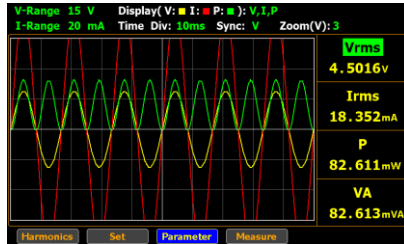

5. Press **Enter** button to enter the 1st parameter. Use up and down arrow keys to toggle between options. Press **Enter** button again to confirm your selection.

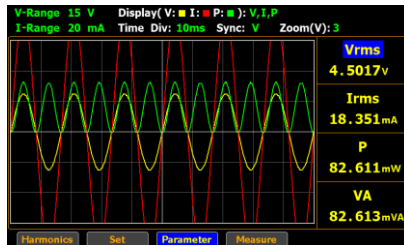

6. Press down arrow key to move cursor to the 2nd parameter and repeat the above steps to set up. Also, repeat the same steps for the 3rd and 4th parameters.

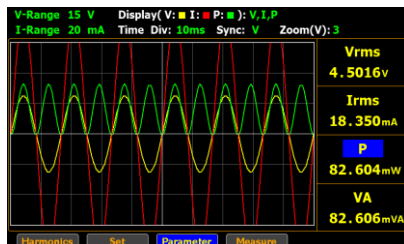

Option	Voltage	Vac (AC) Vdc (DC) Vrms (AC+DC) Vmn (V-MEAN)
	Current	Iac (AC) Idc (DC) Irms (AC+DC, V-MEAN)
	Active Power	P
	Apparent Power	VA
	Reactive power	VAR
	Power Factor	PF
	Phase Angle	DEG
	Frequency	IHz, VHz
	Voltage Peak	V+pk, V-pk
	Current Peak	I+pk, I-pk
	Active Power Peak	P+pk, P-pk
	Total Harmonic Distortion	THDI, THDV
	Crest factor	CFV, CFI
	Mathematical Computation	MATH
	Maximum Current Ratio	MCR

Default option Default options are based on the Parameter settings from the standard display mode.

Setting up Harmonics bar graph measurement

Steps

1. Use left and right arrow keys on the front panel to select **Graph** function key.

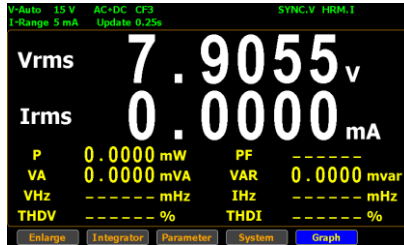

2. Press **Enter** button to enter the Waveform graph display screen.

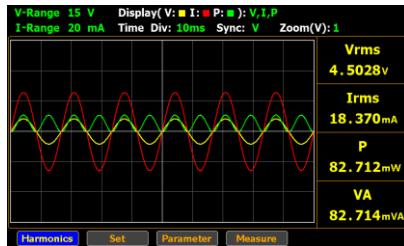

- Press **Enter** button to enter Harmonics bar graph display screen where measured values of each harmonic order are shown in the histogram-like bar display.



- Press right arrow key to move cursor to **Set** key.

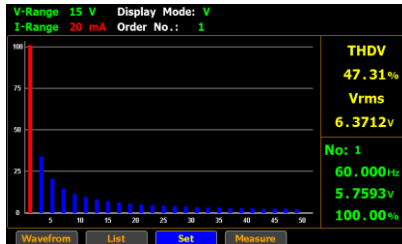

- Press **Enter** button to enter harmonics bar setting section.



Select harmonics display mode 6. Press **Enter** button to enter **Display Mode** field. Use up and down arrow keys to toggle between options. Press **Enter** button again to confirm your selection.

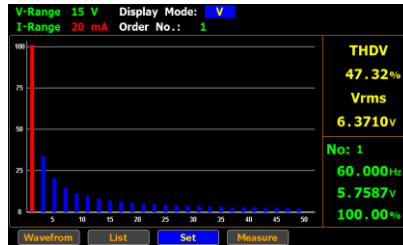

- Option **V** The THDV measured factor will be displayed in the right-side section in yellow and also shown in the left-side bar graph.
- I** The THDI measured factor will be displayed in the right-side section in yellow and also shown in the left-side bar graph.

Default option **V**

Select harmonics display order number 7. Press down arrow key to move to **Order No.** field in the harmonics setting section.

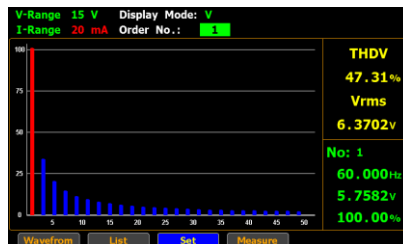

- Press **Enter** button to enter **Order No.** field. Use up and down arrow keys to toggle between options. Press Enter button again to confirm your selection.



Option **1 - 50** Select a measured harmonic order with related values to be displayed in both the right-side section in green and the left-side bar graph. Note that the upper limit of order number is relevant to the Harmonics setting (page 38).

Default option **1**

Setting up Harmonics list graph measurement

- Steps**
- Use left and right arrow keys on the front panel to select **Graph** function key.

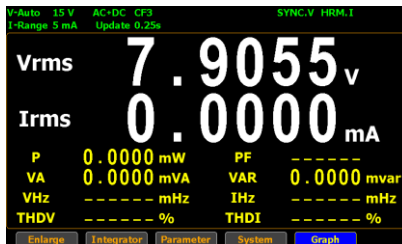

2. Press **Enter** button to enter the Waveform graph display screen.

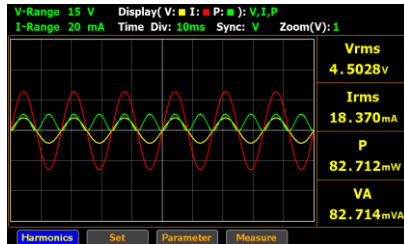

3. Press **Enter** button to enter Harmonics bar graph display screen.

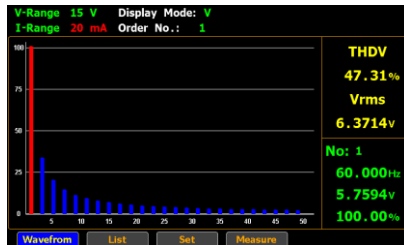

4. Press right arrow key to move cursor to **List** key.



5. Press **Enter** button to enter harmonics list display screen.



V-Range 15 V		I-Range 200 mA							
PF	0.9999	THDV	0.08%	VHz	59.999 Hz				
DEG	-0.7°	THDI	0.20%	IHz	59.999 Hz				
Order	V (V)	I (mA)	P (mW)	V Hdf(%)	I Hdf(%)	P Hdf(%)	V(°)	I(°)	
Total	5.0821	99.040	503.30	-----	-----	-----	-----	-----	
1	5.0821	99.040	503.29	100.01	100.01	100.01	-0.7	-0.7	
2	0.0016	0.0143	0.0000	0.04	0.02	0.01	-152.3	-115.5	
3	0.0009	0.0469	0.0000	0.02	0.05	0.01	4.2	3.9	
4	0.0007	0.0184	0.0000	0.02	0.02	0.01	-164.2	52.6	
5	0.0017	0.0310	0.0001	0.04	0.04	0.01	10.1	40.2	
6	0.0004	0.0288	0.0000	0.01	0.03	0.01	-165.6	-98.2	
7	0.0008	0.0234	0.0000	0.02	0.03	0.01	14.3	-91.7	

Turn pages of harmonics list

6. Press right and left arrow keys to move cursor to **Up** and **Down** keys. Press **Enter** button for Up and Down keys individually to flip over pages of the harmonics list in which relevant values of each order of harmonics are well displayed. See the section below for descriptions of each item within the list.

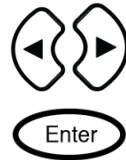

V-Range 15 V		I-Range 200 mA							
PF	0.9999	THDV	0.08%	VHz	59.999 Hz				
DEG	-0.9°	THDI	0.17%	IHz	59.999 Hz				
Order	V (V)	I (mA)	P (mW)	V Hdf(%)	I Hdf(%)	P Hdf(%)	V(°)	I(°)	
Total	5.0819	99.025	503.18	-----	-----	-----	-----	-----	
50	0.0003	0.0226	0.0000	0.01	0.03	0.01	43.4	85.9	

V-Range 15 V		I-Range 200 mA							
PF	0.9999	THDV	0.08%	VHz	59.999 Hz				
DEG	-0.8°	THDI	0.20%	IHz	59.999 Hz				
Order	V (V)	I (mA)	P (mW)	V Hdf(%)	I Hdf(%)	P Hdf(%)	V(°)	I(°)	
Total	5.0816	99.025	503.16	-----	-----	-----	-----	-----	
8	0.0004	0.0314	0.0000	0.01	0.04	0.01	-157.1	-143.3	
9	0.0002	0.0221	0.0000	0.01	0.03	0.01	1.5	-169.9	
10	0.0003	0.0309	0.0000	0.01	0.04	0.01	-174.2	-171.6	
11	0.0008	0.0245	0.0000	0.02	0.03	0.01	20.0	-117.7	
12	0.0003	0.0282	0.0000	0.01	0.03	0.01	-168.2	-115.5	
13	0.0007	0.0283	0.0000	0.02	0.03	0.01	27.7	70.4	
14	0.0003	0.0234	0.0000	0.01	0.03	0.01	-161.2	51.6	

Items of the list	Order	The harmonic order number
	V	RMS voltage value of the harmonic order
	I	RMS current value of the harmonic order
	P	Active power value of the harmonic order
	V Hdf(%)	Voltage harmonic distortion factor of the harmonic order
	I Hdf(%)	Current harmonic distortion factor of the harmonic order
	P Hdf(%)	Power harmonic distortion factor of the harmonic order
	V (°)	The phase difference between the fundamental voltage and the voltage of the harmonic order
	I (°)	The phase difference between the fundamental current and the current of the harmonic order

DIGITAL I/O / DA4

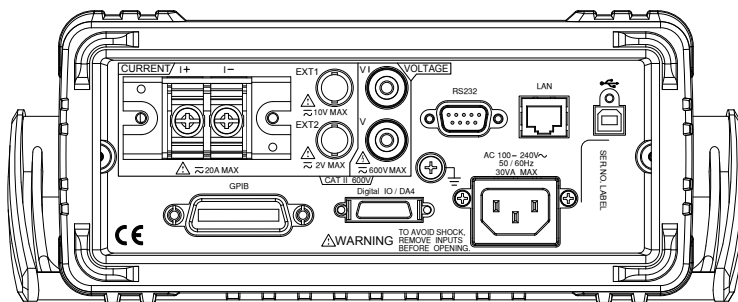

Digital I/O / DA4 Overview	122
External Remote Control.....	124
DA4 Output Function	125
User / 4094 Mode	130
User Mode IO (Output) Mode.....	131
User Mode - Switch Mode (LED)	132
User Mode - Switch Mode (Relay)	133
4094 Mode	134

Digital I/O / DA4 Overview

Background The digital I/O /DA4 port contains up to 3 modes: External Remote Control, DA4 Output Function and User-defined output function, which is divided into User Mode and 4094 Mode individually.

Use the external I/O connector on the rear panel to control the instrument remotely and produce D/A output.

By providing separate VCC power for the terminal, the outputs can also be used as a power source for TTL and CMOS circuits.

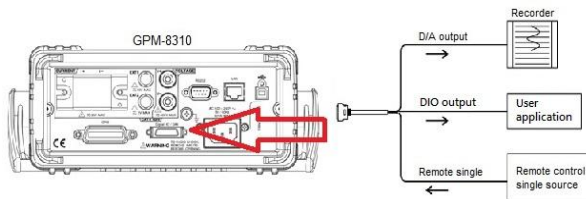

Pin Assignment

Connector type: SCSI 26 pin female

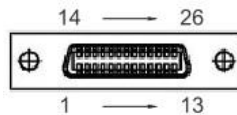

Pin No.	Signal Name	Pin No.	Signal Name
1	Digital GND	14	/Ext Trigger In
2	/Ext Hold In	15	/Ext Stop In
3	/Ext Start In	16	/Integ Busy Out
4	/Ext Reset In	17	+5Vcc Out
5	Flyback Diode	18	Out1/Clock
6	Out2/Output Enable	19	Out3/Strobe

7	Out4/Serial Input	20	Digital GND
8	No connection	21	Digital GND
9	No connection	22	D/A ch4 out
10	D/A ch3 out	23	D/A ch2 out
11	D/A ch1 out	24	D/A GND
12	D/A GND	25	No connection
13	D/A GND	26	No connection



Note

The Digital GND and D/A GND signals are connected internally.



CAUTION

1. Do not apply voltage outside the range of 0 to 5 V to the remote control input pins. Also, do not short the output pins or apply external voltage to them. If you do, the instrument may malfunction.
2. Do not short the D/A output terminal or apply external voltage to it. If you do, the instrument may malfunction.
3. When connecting the D/A output to another device, do not connect the wrong signal pin. Doing so may damage this instrument or the connected instrument.
4. Pin17: VCC output, 5V. It serves as the unregulated max power source for the external device/logic. The maximum current is 100mA.
5. Pin5: Flyback Diode. It connects to VCC or External power source.

External Remote Control

Overview Through external control, you can hold values, perform single measurements, and start, stop, and reset integration.

Remote Control IO Circuit

Input diagram

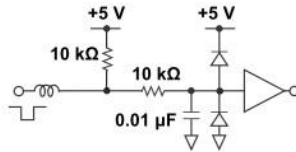

Output diagram

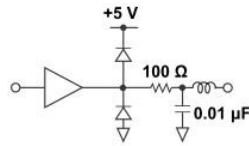

Pulse width timing

Start, Stop, Reset, hold, Trigger

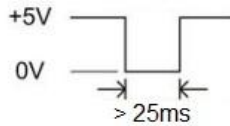

Integ Busy Out

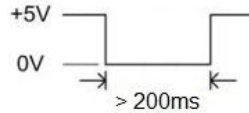

Note

The Integ Busy output signal is set to low level during integration. Use this signal when you are observing integration.

DA4 Output Function

Overview You can output voltage, current, active power, apparent power, reactive power, power factor, phase angle, frequency, voltage peak, current peak, and integrated values using a $\pm 5V$ FS DC voltage.

The output range mode and maximum/minimum value of manual range mode can only be used when using a remote control interface. Likewise this parameter can only be configured via remote control. Please see the commands on page 157 for full usage details.

Output Format You can select a preconfigured output format or configure your own original format.

Preconfigured Format	Normal		Integrator	
	Ch1	V		P
Ch2	I		WP	
Ch3	P		q	
Ch4	VHz		VHz	

Rated Integration Time In the D/A output of integrated values, 5.0 V FS represents the integrated value when the rated range value is applied for the rated integration time. The default setting is 1.00.00 (1 h, 0 min, 0 s).

If you set the rated integration time to 0.00.00, the D/A output value will be 0 V.

Output Range Mode The DA4 have two output range mode: Fixed range mode or Manual range mode. The default setting is Fixed.

Fixed (Fixed range mode) When a measurement function's rated value is received, +5V is output.

Manual (Manual range mode) You can set which measurement function values result in a D/A output of -5V, and which result in a D/A output of +5V. By doing so, you can enlarge or reduce (zoom) the D/A output of each channel.

For example, if you are measuring a current that fluctuates between 0.4A and 0.6A with a measurement range of 1A, when the D/A output range mode is Fixed, the D/A output voltage will fluctuate between 2.0V and 3.0V. When you want to observe the fluctuations more closely, you can use the D/A zoom feature. If you set the D/A output range mode to Manual and set the minimum value to 0.4 and the maximum value to 0.6, the instrument will produce -5V when the measured current value is 0.4A and +5V when the measured current value is 0.6A.

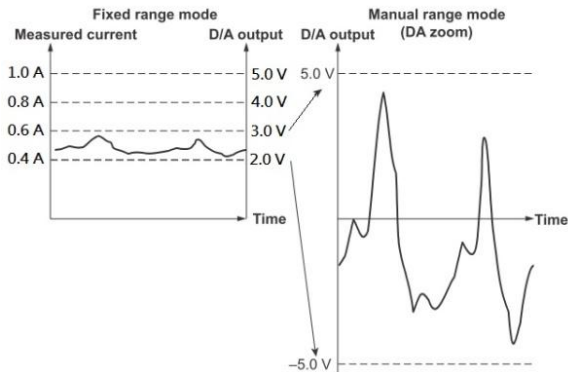

Maximum and Minimum Values in Manual Range Mode The value maximum and minimum is between -9.999E+12 and 9.999E+12.
The default value is 100.0 and -100.0.

Relationship between Output Items and D/A Output Voltage

Frequency

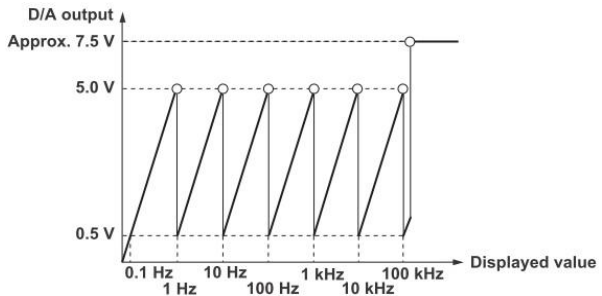

Integrator

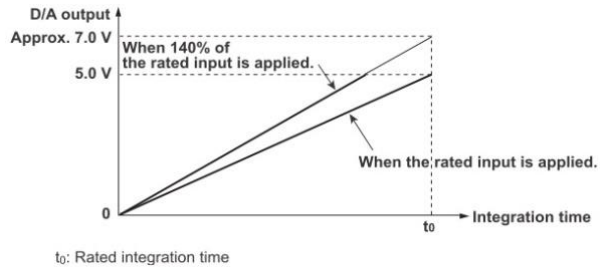

Other

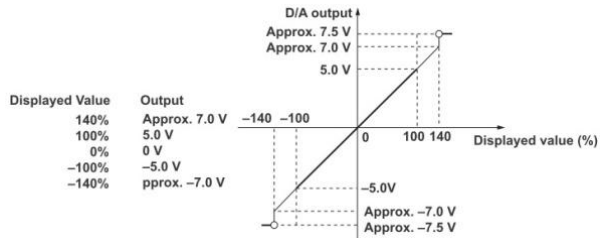

Examples of D/A Output **Voltage:**

When the voltage range is set to 150 V and measurement value is 100 V, the output is $100 \text{ V} / 150 \text{ V} \times 5 \text{ V} = 3.3 \text{ V}$.

Frequency:

When the voltage frequency measurement value is 60Hz, the D/A output is $60 \text{ Hz}/100 \text{ Hz} \times 5\text{V} = 3 \text{ V}$.

Power:

When the voltage range is set to 150 V and the current range is set to 2 A, the rated power range is $150 \text{ V} \times 2\text{A} = 300 \text{ W}$.

When the measured power value is 150 W, the output is $150 \text{ W}/300 \text{ W} \times 5\text{V} = 2.5 \text{ V}$.

Integrated Power:

When the voltage range is set to 150 V and the current range is set to 1 A, the rated power range is $150 \text{ V} \times 1\text{A} = 150 \text{ W}$. In manual integration mode, when the rated integration time is set to 1 hour, the rated electrical energy value is $150 \text{ W} \times 1 \text{ h} = 150 \text{ Wh}$.

If you perform integration for 1 hour and the measured electrical energy is 150 W, the D/A output one hour after integration start is +5 V.



Note

1. The range between +5 to +7 V and -5 to -7 V is not output for λ and Φ . When an error occurs, the output is approximately $\pm 7.5 \text{ V}$.
2. For Upk and Ipk, $\pm 5 \text{ V}$ represents the application of 3 times the rated range value (6 times the rated range value when the crest factor is 6 or 6A).
3. Refer to the table below for GPM-8310 DA parameters calculation.

Item	Calculation	Note
V	$(X / V_range) * 5V$	
I	$(X / I_range) * 5V$	
P	$(X / V_range * I_range) * 5V$	
VA	$(X / V_range * I_range) * 5V$	
VAR	$(X / V_range * I_range) * 5V$	
PF	$(X / 1.0) * 5V$	
DEG	$(X / 180) * -1 * 5V$	
VHz	$(X / Base_Hz) * 5V$	For example: Hz = 0.5Hz, Base_Hz = 1Hz Hz = 6Hz, Base_Hz = 10Hz Hz = 50Hz, Base_Hz = 100Hz Therefore, (<0.1Hz = 0V, >110kHz = 7.5V)
IHz	$(X / Base_Hz) * 5V$	
Vpk	$(X / (V_range * CF)) * 5V$	+/- peak (Take the absolute value and output on the basis of the greater value) CF: Crest Factor(3 or 6)
Ipk	$(X / (I_range * CF)) * 5V$	
WP	$(X / V_range * I_range) * 5V * (3600 / DA_Time)$	DA_Time Refer to Setup->D/A->Rated Integrator for details.
WP+	$(X / V_range * I_range) * 5V * (3600 / DA_Time)$	
WP-	$(X / V_range * I_range) * 5V * (3600 / DA_Time)$	
q	$(X / I_range) * 5V * (3600 / DA_Time)$	
q+	$(X / I_range) * 5V * (3600 / DA_Time)$	
q-	$(X / I_range) * 5V * (3600 / DA_Time)$	
OFF	0V	

*Variable Definition: X = measured value

User / 4094 Mode

Overview User (IO) and 4094 mode can only be used when using a remote control interface. Likewise this mode can only be enabled or disabled via remote control. Please see the digital I/O commands on page 160 for full usage details.

Digital IO wiring diagram Pin 6, 7, 18, 19

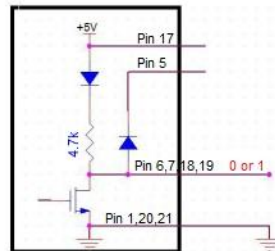

Related Commands AOUTput:DIGital:MODE?
 AOUTput:DIGital:MODE {IO|4094}
 AOUTput:DIGital:SETup (For User Mode)
 AOUTput:DIGital:OUTPut (For 4094 Mode)

User Mode IO (Output) Mode

Overview It is the mode utilizing output as general IO (Output) usage with up to 4 pins available for use simultaneously. Refer to the following introductions along with diagrams for more details. Please see the digital I/O commands on page 160 for full usage details.

Related Commands AOUT:DIG:MODE IO (switch to IO mode)
 AOUT:DIG:SET 0,1,1,0
 => OUT1 (Pin18) : +0V
 OUT2 (Pin6) : +5V
 OUT3 (Pin19) : +5V
 OUT4 (Pin7) : +0V

Pin Diagram Use the built-in power supply

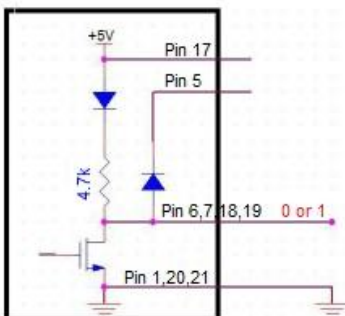

Use in conjunction with the logic gate

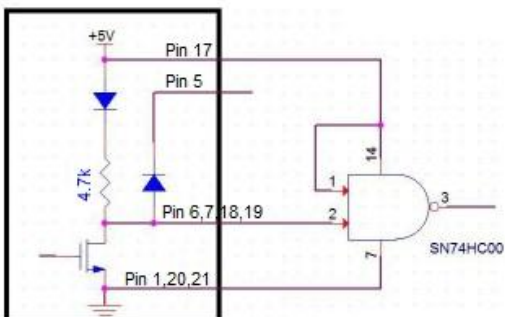

User Mode - Switch Mode (LED)

Overview It is the mode driving LED as status display for user with up to 4 pins available for use simultaneously. Refer to the following introductions along with diagrams for more details. Please see the digital I/O commands on page 160 for full usage details.

Related Commands AOUT:DIG:MODE IO (switch to IO mode)
 AOUT:DIG:SET 1,0,0,1
 => OUT1(Pin18) : LED OFF
 OUT2(Pin6) : LED ON
 OUT3(Pin19) : LED ON
 OUT4(Pin7) : LED OFF

Pin Diagram Use the built-in power supply

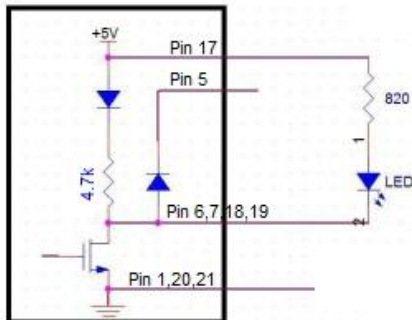

Use the external power

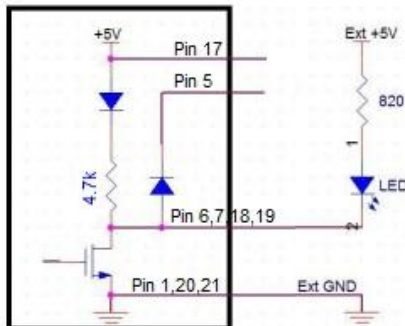

User Mode - Switch Mode (Relay)

Overview It is the mode driving Relay to control external circuit with up to 4 pins available for use simultaneously. Refer to the following introductions along with diagrams for more details. Please see the digital I/O commands on page 160 for full usage details.

Related Commands AOUT:DIG:MODE IO (switch to IO mode)
 AOUT:DIG:SET 1,0,1,0
 => OUT1 (Pin18) : RELAY ON
 OUT2 (Pin6) : RELAY OFF
 OUT3 (Pin19) : RELAY ON
 OUT4 (Pin7) : RELAY OFF

Pin Diagram Use the built-in power supply which provides the power of maximum 100mA

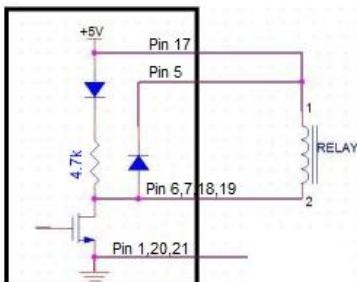

Use the external power (+5~24V) (Maximum I_{ds} of each channel: 100mA)

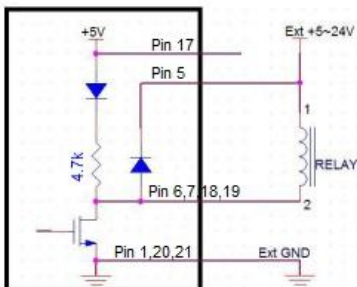

4094 Mode

Overview It is the mode for IO expansion via converting serial data into parallel data. Up to 8 pins are available simultaneously when single 4094 is in operation, whereas it rises to the maximum of 16 pins available simultaneously if putting two 4094 in series. Refer to the following introductions along with diagrams for more details. Please see the digital I/O commands on page 160 for full usage details.

Related Commands AOUI:DIG:MODE 4094 (switch to 4094 mode)

`4094 x 1 (8 Pin)`

AOUI:DIG:OUTP 10 , 1

=> 4094 Output(Out1~Out8) : 01010000

`4094 x 2 (16 Pin)`

AOUI:DIG:OUTP 22,0

AOUI:DIG:OUTP 88,1

=> 4094 Output(Out1~Out8) : 01101000

(Out9~Out16): 00011010

Note: 0=> output is Low (+0V)

1=> output is High (+5V)

Pin Diagram

Use the built-in power supply

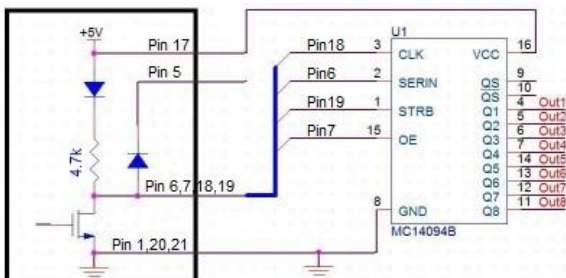

Use the external power

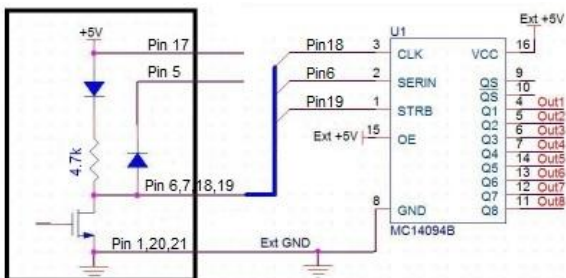

Method of series

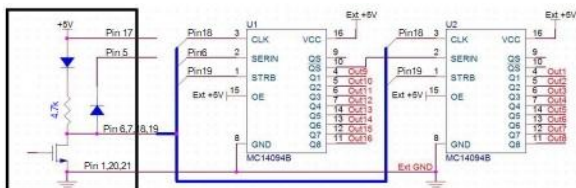

REMOTE CONTROL

This chapter describes basic configuration of IEEE488.2 based remote control. For a command list, refer to the Command Overview chapter on page 145.

Configure Remote Control Interface	137
Configure USB Interface.....	137
Configure RS232 Interface	138
Configure GPIB Interface	140
Configure LAN Interface.....	142
Configure EOL Character	144
Return to Local Control	144

Configure Remote Control Interface

Configure USB Interface

USB CDC Class Due to the USB port configured to CDC (Communications Device Class) by default, the GPM-8310 will appear as a virtual COM port to a connected PC. Before, hence, using remote control via CDC USB class, install the appropriate CDC USB driver included on the User Manual CD.

Background Continue the following setting from **SYSTEM CONFIG** setting screen

Steps 1. Press **Enter** button. 

2. Press down arrow key to move cursor to **I/O Model** field. 

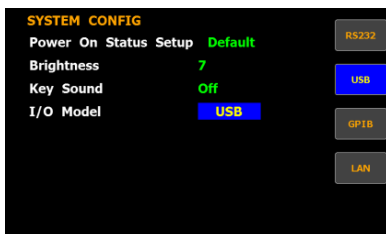

3. Use soft keys to select and confirm the **USB** option. 





USB Configuration	PC connector	Type A, host
	GPM-8310 connector	Rear panel Type B, slave
	Speed	1.1/2.0 (full speed/high speed)
	USB Class	CDC (Communications device class)
	Hardware flow control	Off
	Data Bits	8
	Stop bit	1

Configure RS232 Interface

Background Continue the following setting from **SYSTEM CONFIG** setting screen

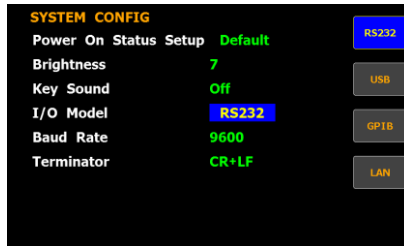
- Steps
1. Press **Enter** button. 
 2. Press down arrow key to move cursor to **I/O Model** field. 
 3. Use soft keys to select and confirm the **RS232** option. 



4. Press down arrow key to move cursor to **Baud Rate** field. 
5. Use soft keys to select and confirm the **Baud Rate** option.

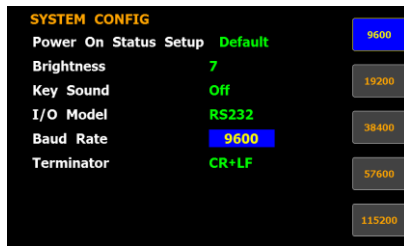

Option **9600, 19200, 38400, 57600,115200**

Default value **9600**

- Press down arrow key to move cursor to **Terminator** field.



- Use soft keys to select and confirm the **Terminator** option.

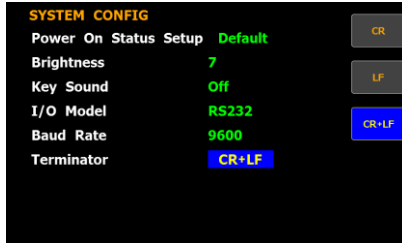

Option	CR, LF, CR+LF	Terminator indicates the end of line for return message.
--------	---------------	--

Default value	CR+LF
---------------	-------

RS232 Configuration	Selectable Baud rate	9600, 19200, 38400, 57600, 115200
	Parity	None
	Hardware flow control	Off
	Data Bits	8
	Stop bit	1



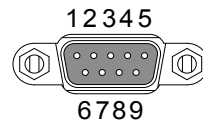

RS232 Pin Assignments	Pin 2: Rx D
	Pin 3: Tx D
	Pin 5: GND
	Pin 1, 4, 6 ~ 9: No Connection

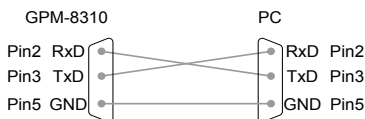

PC Connection Use a Null Modem connection as shown in the diagram below.

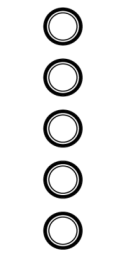
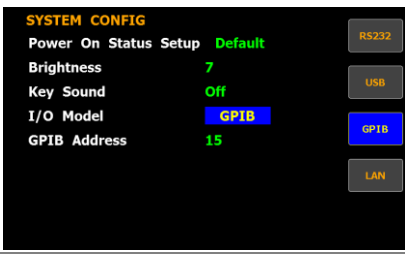

Configure GPIB Interface

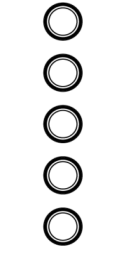
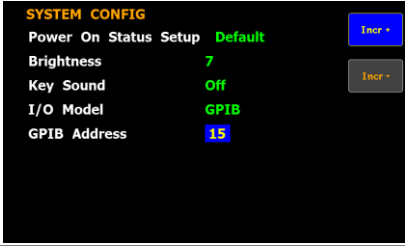

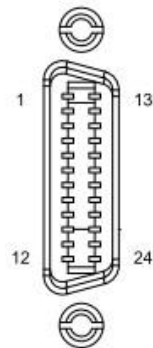

Background	Continue the following setting from SYSTEM CONFIG setting screen	
Steps	1. Press Enter button.	
	2. Press down arrow key to move cursor to I/O Model field.	
	3. Use soft keys to select and confirm the GPIB option.	
		
	4. Press down arrow key to move cursor to GPIB Address field.	
	5. Use soft keys to increase or decrease to a target GPIB Address.	
		
Option	The range of GPIB Address is from 1 to 30 .	

Default option **15**

	Pin	Signal	Pin	Signal
GPIB Pin Assignments	1	Data I/O 1	13	Data I/O 5
	2	Data I/O 2	14	Data I/O 6
	3	Data I/O 3	15	Data I/O 7
	4	Data I/O 4	16	Data I/O 8
	5	EOI	17	REN
	6	DAV	18	Ground (DAV)
	7	NRFD	19	Ground (NRFD)
	8	NDAC	20	Ground (NDAC)
	9	IFC	21	Ground (IFC)
	10	SRQ	22	Ground (SRQ)
	11	ATN	23	Ground (ATN)
	12	SHIELD Ground	24	Single GND

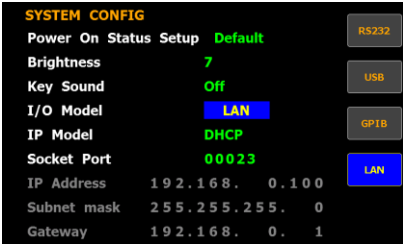

Configure LAN Interface

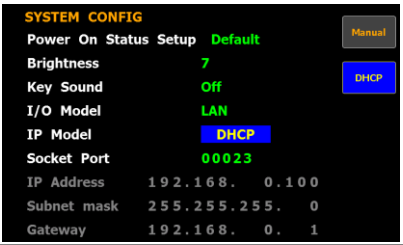
Background	Continue the following setting from SYSTEM CONFIG setting screen	
Steps	<ol style="list-style-type: none"> 1. Press Enter button. 2. Press down arrow key to move cursor to I/O Model field. 3. Use soft keys to select and confirm the LAN option. 	  
		
	<ol style="list-style-type: none"> 4. Press down arrow key to move cursor to IP Model field. 5. Use soft keys to select and confirm the desired option. 	 
		
Option	Manual	Set up IP Address, Subnet mask and Gateway manually.

DHCP DHCP server automatically assigns IP Address, Subnet mask and Gateway.

Default option **DHCP**

Steps 6. Press down arrow key to move cursor to **Socket Port** field. 

7. Use soft keys to increase or decrease the parameter of Socket Port. 

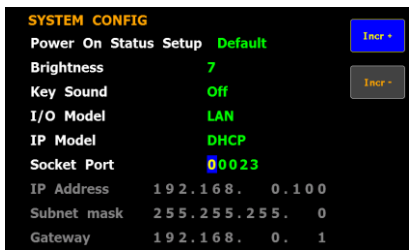

Option The range of Socket Port is from **00000** to **65535**.

Default option **00023**

Steps 8. When selecting Manual for IP Model, press down arrow key to move cursor to **IP Address, Subnet Mask** and **Gateway** fields, individually. 

9. Use soft keys to increase or decrease the parameters of **IP Address, Subnet Mask** and **Gateway** fields, individually. 

Default option
 IP Address: **192.168.0.100**
 Subnet Mask: **255.255.255.0**
 Gateway: **192.168.0.1**

Configure EOL Character

Description	<p>The system config menu can set the EOL(end-of-line) character for return message. (The USB, GPIB and LAN's EOL character is fixed with CR+LF)</p> <p>The EOL characters that can be received from the PC include CR+LF, LF+CR, CR or LF. The most common EOL character is CR+LF.</p>
-------------	--

Return to Local Control

Background	<p>When the unit is in remote control mode, the RMT icon above the main display can be seen. When this icon is not displayed, it indicates that the unit is in local control mode.</p>
Procedure	<ol style="list-style-type: none">1. Press the Local key when in remote mode.2. The unit will go back into local mode and the RMT icon will turn off.

C COMMAND OVERVIEW

The Command overview chapter lists all programming commands in functional order as well as alphabetical order. The command syntax section shows you the basic syntax rules you have to apply when using commands.

Command Syntax

Compatible Standard	IEEE488.2 SCPI, 1994	Partial compatibility Partial compatibility
Command Structure	<p>SCPI (Standard Commands for Programmable Instruments) commands follow a tree-like structure, organized into nodes. Each level of the command tree is a node. Each keyword in a SCPI command represents each node in the command tree. Each keyword (node) of a SCPI command is separated by a colon (:).</p> <p>For example, the diagram below shows an SCPI sub-structure and a command example.</p> <div style="text-align: center;"> <pre> graph TD A[":INPut"] --- B[":MODE"] B --- C["DC"] B --- D["AC"] B --- E["ACDC"] </pre> </div>	
Command Types	<p>There are a number of different instrument commands and queries. A command sends instructions or data to the unit and a query receives data or status information from the unit.</p>	

	Command types
	<p>A single command with/without a parameter</p> <p>Simple</p> <p>Example :INPut:MODE DC</p>
	<p>A query is a simple or compound command followed by a question mark (?). A parameter (data) is returned.</p> <p>Query</p> <p>Example :INPut:CFACTOR?</p>
Command Forms	<p>Commands and queries have two different forms, long and short. The command syntax is written with the short form of the command in capitals and the remainder (long form) in lower case.</p> <p>The commands can be written either in capitals or lower-case, just so long as the short or long forms are complete. An incomplete command will not be recognized.</p> <p>Below are examples of correctly written commands.</p>
	<p>Long form :INPut:SYNChronize VOLTage</p> <p>:COMMunicate:HEADer ON</p>
	<p>Short form :INP:SYNC VOLT</p> <p>:COMM:HEAD ON</p>
Square Brackets	<p>Commands that contain square brackets indicate that the contents are optional. The function of the command is the same with or without the square bracketed items, as shown below. For example, for the query:</p> <p>[:INPut]:FILTer?</p> <p>Both :INPut:FILTer? and :FILTer? are valid forms.</p>



1. Command header
2. Space
3. Parameter 1

Common Input Parameters	Type	Description	Example
	<Boolean>	boolean logic	0, 1
	<NR1>	integers	0, 1, 2, 3
	<NR2>	decimal numbers	0.1, 3.14, 8.5
	<NR3>	floating point with exponent	4.5e-1, 8.25e+1
	<NRf>	any of NR1, 2, 3	1, 1.5, 4.5e-1
	[MIN] (Optional parameter)	For commands, this will set the setting to the lowest value. This parameter can be used in place of any numerical parameter where indicated. For queries, it will return the lowest possible value allowed for the particular setting.	
	[MAX] (Optional parameter)	For commands, this will set the setting to the highest value. This parameter can be used in place of any numerical parameter where indicated. For queries, it will return the highest possible value allowed for the particular setting.	

Message Terminator (EOL)	Remote Command	Marks the end of a command line. The following messages are in accordance with IEEE488.2 standard.
--------------------------	----------------	--

CR+LF

The most
common EOL
character is
CR+LF

Message
Separator

EOL or ;
(semicolon)

Command Separator

Command List

	*CLS.....	153
SCPI Commands	*ESE.....	153
	*ESR	154
	*IDN	154
	*OPC	154
	*OPT.....	155
	*RST	155
	*SRE	155
	*STB	156
	*TRG.....	156
	:AOUTput	157
AOUTput Commands	:AOUTput[:NORMal]:CHANnel<x>	157
	:AOUTput[:NORMal]:IRTime.....	158
	:AOUTput[:NORMal]:MODE<x>	158
	:AOUTput[:NORMal]:PRESet.....	159
	:AOUTput[:NORMal]:RATE<x>.....	159
	:AOUTput:DIGital:MODE	160
	:AOUTput:DIGital:OUTPut.....	160
	:AOUTput:DIGital:SETup.....	161
	:COMMunicate.....	162
COMMunicate Commands	:COMMunicate:HEADer	162
	:COMMunicate:LOCKout	163
	:COMMunicate:REMote	163
	:COMMunicate:STATus.....	164
	:COMMunicate:VERBose.....	164
	:DISPlay	166
DISPlay Commands	:DISPlay:NORMal.....	166
	:DISPlay[:NORMal]:ITEM<x>.....	166
	:DISPlay:INTegrate:ITEM<x>.....	168
	:DISPlay:PAGE.....	169
	:HARMonics	170
HARMonics Command	:HARMonics:DISPlay	170
	:HARMonics:DISPlay[:STATe].....	170
	:HARMonics:DISPlay:ORDer.....	171

	:HARMonics:PLLSource	171
	:HARMonics:ORDer.....	172
	:HARMonics:THD	172
HOLD Command	:HOLD	173
	:INPut	175
INPut Commands	[:INPut]:WIRing	175
	[:INPut]:MODE	176
	[:INPut]:VOLTage	176
	[:INPut]:VOLTage:RANGe.....	176
	[:INPut]:VOLTage:AUTO.....	177
	[:INPut]:VOLTage:CONFig	177
	[:INPut]:VOLTage:POJump	178
	[:INPut]:CURRent	178
	[:INPut]:CURRent:RANGe.....	178
	[:INPut]:CURRent:AUTO	179
	[:INPut]:CURRent:CONFig.....	180
	[:INPut]:CURRent:POJump	180
	[:INPut]:CURRent:EXTSensor:CONFig<x>	181
	[:INPut]:CURRent:EXTSensor:POJump<x>	181
	[:INPut]:CURRent:SRATio:ELEMent1<x>	182
	[:INPut]:RCONfig	183
	[:INPut]:SCALing	183
	[:INPut]:SCALing[:STATe].....	183
	[:INPut]:SCALing:{VT CT SFACtor}:ELEMent<x>	184
	[:INPut]:SYNChronize	184
	[:INPut]:FILTer.....	185
	[:INPut]:FILTer:LINE	185
	[:INPut]:FILTer:FREQuency.....	185
	[:INPut]:POVer	186
	[:INPut]:CRANge	186
	[:INPut]:ZERO	187
	:INTEGrate	188
INTEGrate commands	:INTEGrate:MODE	188
	:INTEGrate:FUNCTion.....	189
	:INTEGrate:TIMer	189
	:INTEGrate:STARt	189
	:INTEGrate:STOP	190
	:INTEGrate:RESet.....	190

	:INTEGrate:STATe	190
	:MATH	191
Math commands	:MEASure.....	192
MEASure	:MEASure:AVERaging	192
commands	:MEASure:AVERaging[:STATe].....	192
	:MEASure:AVERaging:TYPE.....	193
	:MEASure:AVERaging:COUNt.....	193
	:MEASure:MHOLd	193
	:NUMeric.....	195
NUMeric	:NUMeric:FORMat.....	195
commands	:NUMeric:NORMal	196
	:NUMeric[:NORMal]:VALue.....	196
	:NUMeric[:NORMal]:NUMber.....	198
	:NUMeric[:NORMal]:ITEM<x>	198
	:NUMeric[:NORMal]:PRESet	202
	:NUMeric[:NORMal]:CLEar	204
	:NUMeric[:NORMal]:DELete	204
	:NUMeric[:NORMal]:HEADer.....	205
	:NUMeric:LIST	205
	:NUMeric:LIST:VALue.....	206
	:NUMeric:LIST:NUMber.....	206
	:NUMeric:LIST:ORDer	207
	:NUMeric:LIST:SELEct	207
	:NUMeric:LIST:ITEM<x>.....	208
	:NUMeric:LIST:PRESet.....	209
	:NUMeric:LIST:CLEar.....	210
	:NUMeric:LIST:DELete.....	210
	:NUMeric:HOLd	211
	:RATE	213
RATE commands	:RATE:AUTO.....	213
	:RATE:AUTO:TIMeout.....	213
	:RATE:AUTO:SYNChronize.....	214
	:RECall:NUMber.....	215
RECall commands	:RECall[:NORMal]:VALue	215
	:RECall:LIST:VALue	216
	:RECall:PANel	216

	:STATus	217
STATus	:STATus:CONDition.....	217
commands	:STATus:EESE.....	217
	:STATus:EESR.....	218
	:STATus:ERRor	218
	:STATus:FILTer<x>	219
	:STATus:QENable	220
	:STATus:QMESsage	220
	:STORe	222
STORe	:STORe[:STATe].....	222
commands	:STORe:INTerval	222
	:STORe:PANel	223
	:SYSTem	224
SYSTem	:SYSTem:BRIGhtness.....	224
commands	:SYSTem:COMMunicate:COMMand	224
	:SYSTem:COMMunicate:ETHernet:MACaddress	225
	:SYSTem:FIRMWare:DATE	225
	:SYSTem:KLOCK.....	226
	:SYSTem:MODEl	226
	:SYSTem:RESolution	227
	:SYSTem:SERial	227
	:SYSTem:VERsion[:FIRMWare].....	227

SCPI Commands

*CLS	153
*ESE	153
*ESR	154
*IDN	154
*OPC	154
*OPT	155
*RST	155
*SRE	155
*STB	156
*TRG	156

*CLS

Set →

Description Clears the standard event status register, extended event status register, and error queue.

Syntax *CLS

*ESE

Set →

→ Query

Description Sets or returns the ESER (Event Status Enable Register) contents.

Syntax *ESE <NR1>

Query Syntax *ESE?

Parameter/ <NR1> 0~255
Return parameter

Example *ESE 65
 Set the ESER to 01000001
 *ESE?
 ->130
 ESER=10000010

***ESR** → **Query**

Description	Returns and clears the SESR (Standard Event Status Register).
Query Syntax	*ESR?
Return parameter	<NR1> 0~255
Example	*ESR? ->198 SESR=11000110

***IDN** → **Query**

Description	Returns the manufacturer, model number, serial number, and system version of the instrument.
Query Syntax	*IDN?
Return parameter	<String>
Example	*IDN? ->GWInstek,GPM-8310, GXXXXXXXXX,V1.00

***OPC**
Set →
 → Query

Description	Sets or returns the operation complete bit (bit0) in SERS (Standard Event Status Register) when all pending operations are completed.
Syntax	*OPC
Query Syntax	*OPC?
Return parameter	<NR1>0 Operation isn't completed. <NR1>1 Operation is completed.
Example	*OPC? Returns 1.

***OPT**

→ Query

Description	Returns the installed option.
Query Syntax	*OPT?
Return parameter	<String> C1:GBIP C2:RS232 C3:USB Device C7:Ethernet EX1:External Sensor 1(2.5V/5V/10V) EX2:External Sensor 2 (50mV/100mV/200mV/500mV/1V/2V) G5:Harmonic measurement DA4:4 channel D/A output
Example	*OPT? ->C1,C2,C3,C7,EX1,EX2,G5,DA4

***RST**

Set →

Description	Initializes the settings
Syntax	*RST

***SRE**Set →
→ Query

Description	Sets or returns SRER (Service Request Enable Register)
Syntax	*SRE <NR1>
Query Syntax	*SRE?
Parameter/ Return parameter	<NR1> 0~255

Example *SER 7
 Set the the SRER to 00000111
 *SRE?
 ->3
 SRER=00000011

***STB**

→ Query

Description Returns the SBR (Status Byte Register) contents.

Query Syntax *STB?

Return parameter <NR1> 0~255

Example *STB ?
 ->34
 SBR=00100010

***TRG**

Set →

Description Executes single measurement (the same
 operation as when Trigger is pressed).

Syntax *TRG

AOUTput Commands

:AOUTput.....	157
:AOUTput[:NORMal]:CHANnel<x>	157
:AOUTput[:NORMal]:IRTime	158
:AOUTput[:NORMal]:MODE<x>.....	158
:AOUTput[:NORMal]:PRESet	159
:AOUTput[:NORMal]:RATE<x>	159
:AOUTput:DIGital:MODE	160
:AOUTput:DIGital:OUTPut	160
:AOUTput:DIGital:SETup	161

:AOUTput → Query

Description	Returns all D/A output settings.
Query Syntax	:AOUTput?
Return parameter	<String>

:AOUTput[:NORMal]:CHANnel<x> Set → → Query

Description	Sets or returns a D/A output item.
Syntax	:AOUTput[:NORMal]:CHANnel<X> {<Function>[,<Element>]}
Query Syntax	:AOUTput[:NORMal]:CHANnel<X>?

Parameter/	<x>	1 to 4 (channel)
Return parameter	<Function>	U I P S Q LAMBda PHI UPeak IPeak FU FI WH WHP WHM AH WHP AHM NONE
	<Element>	1 (If <Element> is omitted, the element is set to 1) (For the GPM-8310, only set to 1 or omitted)

Example :AOUTPUT:NORMAL:CHANNEL1 NONE
 Turns D/A channel1 output off (0V)
 :AOUTPUT:NORMAL:CHANNEL1?
 ->:AOUTPUT:NORMAL:CHANNEL1 I,1

Set →
 ← Query

:AOUTput[:NORMAl]:IRTime

Description	Sets or returns the rated integration time that is used in the D/A output of the integrated value.	
Syntax	:AOUTput[:NORMAl]:IRTime {<NRf>,<NRf>,<NRf>}	
Query Syntax	:AOUTput[:NORMAl]:IRTime?	
Parameter/	1st <NRf>	0~9999(hour)
Return parameter	2nd <NRf>	0~59(minute)
	3rd <NRf>	0~59(second)
Example	:AOUTPUT:NORMAL:IRTIME 1,1,10 :AOUTPUT:NORMAL:IRTIME? ->:AOUTPUT:NORMAL:IRTIME 1,1,10	

Set →
 ← Query

:AOUTput[:NORMAl]:MODE<x>

Description	Sets or returns a D/A range mode. (Remote Control Only)	
Syntax	:AOUTput[:NORMAl]:MODE<x> {FIXEd MANual}	
Query Syntax	:AOUTput[:NORMAl]:MODE<x>?	

Parameter/ Return parameter	<x> FIXed MANual	1 to 4 (channel) Fixed range mode. Manual range mode.
Example	:AOUTPUT:NORMAL:MODE1 FIXED :AOUTPUT:NORMAL:MODE1? ->:AOUTPUT:NORMAL:MODE1 FIXED	
Note	<ul style="list-style-type: none"> • FIXed = Fixed range mode (default value) Outputs +5 V when the rated value of each measurement function is received. • MANual = Manual range mode The displayed values of the measurement function when +5 V and -5 V are output as D/A output can be set to any values of your choice. This enables the D/A output to be expanded or reduced for each channel (D/A zoom). 	

:AOUTput[:NORMAl]:PRESet (Set) →

Description	Sets the D/A output items to their default values.	
Syntax	:AOUTput[:NORMAl]:PRESet {NORMAl INTEGrate}	
Parameter	NORMAl	Sets CH1:U, CH2:I, CH3:P, CH4:FU
	INTEGrate	Sets CH1:P, CH2:WH, CH3:AH, CH4:FU
Example	:AOUTPUT:NORAML:PRESET NORMAL	

:AOUTput[:NORMAl]:RATE<x> (Set) →
→ (Query)

Description	Sets or returns the maximum and minimum values for when the D/A output is in manual range mode. (Remote Control Only)	
Syntax	:AOUTput[:NORMAl]:RATE<x> {<NRf>,<NRf>}	
Query Syntax	:AOUTput[:NORMAl]:RATE<x>?	

Parameter/	<x>	1 to 4 (channel)
Return parameter	<NRF>	-9.999E+12~9.999E+12
Example	:AOUTPUT:RATE1 100,-100 :AOUTPUT:RATE1? ->:AOUTPUT:NORMAL:RATE1 100.0E+00,-100.0E+00	
Note	<ul style="list-style-type: none"> When the D/A output is in manual range mode Set the rated value for +5 V output and then that for -5 V output. When the D/A output is in fixed range mode There is no need to set these values. (The values do not affect the output operation.) 	

Set →
 → Query

:AOUTput:DIGital:MODE

Description	Sets the application mode of digital I/O (Remote Control Only). For details, refer to page 130.	
Syntax	:AOUTput:DIGital:MODE {IO 4094}	
Query Syntax	:AOUTput:DIGital:MODE?	
Parameter/	IO	Sets the digital I/O to IO mode.
Return parameter	4094	Sets the digital I/O to 4094 (serial to parallel) mode.
Example	:AOUTPUT:DIGITAL:MODE IO :AOUTPUT:DIGITAL:MODE? ->:AOUTPUT:DIGITAL:MODE IO	

Set →

:AOUTput:DIGital:OUTPut

Description	When the 4094 mode (serial to parallel) is selected for digital I/O, make use of this command to set output status.
Syntax	:AOUTput:DIGital:OUTPut {<NR1>,<Boolean>}

Parameter	<NR1>	0~255 (serial input data)
	<Boolean>	0,1 (strobe pulse)
Example	:AOUTPUT:DIGITAL:MODE 4094	
	:AOUTPUT:DIGITAL:OUTPUT 10,1	

:AOUTput:DIGital:SETup Set →

Description	When the IO mode is selected for digital I/O, make use of this command to set output status.	
Syntax	:AOUTput:DIGital:SETup {<Boolean>}	
Parameter	<Boolean>	0,1 (OUT1,OUT2,OUT3,OUT4)
Example	:AOUTPUT:DIGITAL:MODE IO	
	:AOUTPUT:DIGITAL:SETUP 0,1,0,1	
	Sets OUT1 to low, OUT2 to high, OUT3 to low, OUT4 to high	

COMMunciate Commands

:COMMunicate	162
:COMMunicate:HEADer	162
:COMMunicate:LOCKout	163
:COMMunicate:REMOte	163
:COMMunicate:STATus	164
:COMMunicate:VERBose	164

:COMMunicate → Query

Description Returns all communication settings.

Query Syntax :COMMunicate?

Return parameter <String>

Set →

:COMMunicate:HEADer → Query

Description Sets or returns whether headers are attached to query responses.

Syntax :COMMunicate:HEADer {<Boolean>|OFF | ON}

Query Syntax :COMMunicate:HEADer?

Parameter <Boolean>0 OFF
<Boolean>1 ON

Return parameter 0 Returns without a header.

1 Returns with a header.

Example :COMMUNICATE:HEADER ON
:COMMUNICATE:HEADER?
->:COMMUNICATE:HEADER 1

Note	Example of a response with a header :INPUT:VOLTAGE:RANGE 150.0E+00
	Example of a response without a header 150.0E+00

:COMMunicate:LOCKout

Description	Sets or returns local lockout.	
Syntax	:COMMunicate:LOCKout {<Boolean> OFF ON}	
Query Syntax	:COMMunicate:LOCKout?	
Parameter	<Boolean>0	OFF
	<Boolean>1	ON
Return parameter	0	Disable the local key.
	1	Enable the local key.
Example	:COMMUNICATE:LOCKOUT ON :COMMUNICATE:LOCKOUT? -> :COMMUNICATE:LOCKOUT 1	

:COMMunicate:REMOte

Description	Sets or returns the GPM-8310 series to remote or local mode. ON is remote mode.	
Syntax	:COMMunicate:REMOte {<Boolean> OFF ON}	
Query Syntax	:COMMunicate:REMOte?	

Parameter	<Boolean>0	OFF
	<Boolean>1	ON
Return parameter	0	Turn the remote function off.
	1	Turn the remote function on.
Example	:COMMUNICATE:REMOTE ON :COMMUNICATE:REMOTE? ->:COMMUNICATE:REMOTE 1	

:COMMunicate:STATus → Query

Description	Returns and clears the line-specific status.(Only for RS-232)	
Query Syntax	:COMMunicate:STATUS?	
Return parameter	Bit 0	Parity error.
(each status bit)	Bit 1	Framing error.
	Bit 2	Noise error Break character detection.
	Bit 3 and higher	Always zero.
Example	:COMMUNICATE:STATUS? ->0	
Note	<ul style="list-style-type: none"> • When an event occurs, the corresponding bit is set in the status. • When the bit is read, it is cleared. • Zero is returned for interfaces other than RS-232. 	

Set →

:COMMunicate:VERBose → Query

Description	Sets or returns whether the response to a query is returned fully spelled out or in its abbreviated form.	
Syntax	:COMMunicate:VERBose {<Boolean> OFF ON}	

Query Syntax	:COMMunicate:VERBose?
Parameter	<Boolean>0 OFF <Boolean>1 ON
Return parameter	0 Turn the verbose function off. 1 Turn the verbose function on.
Example	:COMMUNICATE:VERBOSE ON :COMMUNICATE:VERBOSE? ->:COMMUNICATE:VERBOSE 1
Note	Example of a response fully spelled out :INPUT:VOLTAGE:RANGE 150.0E+00 Example of a response in abbreviated form :VOLT:RANG 150.0E+00

DISPlay Commands

:DISPlay.....	166
:DISPlay:NORMAl	166
:DISPlay[:NORMAl]:ITEM<x>	166
:DISPlay:INTegrate:ITEM<x>	168
:DISPlay:PAGE	169

:DISPlay → Query

Description Returns all display settings.

Query Syntax :DISPlay?

Return parameter <String>

:DISPlay:NORMAl → Query

Description Returns all normal measurement data display settings.

Query Syntax :DISPlay:NORMAl?

Return parameter <String>

:DISPlay[:NORMAl]:ITEM<x> Set →
→ Query

Description Sets or returns a normal measurement data display item. Refer to page 82 for details.

Syntax :DISPlay[:NORMAl]:ITEM<x> <Function>[,<Element>]}

Query Syntax :DISPlay[:NORMAl]:ITEM<x>?

Parameter/	<x>	1 to 10 (display).
Return parameter	<Function>	U UPPeak UMPeak IPPeak IMPeak P PPPeak PMPeak S Q LAMBda CFU CFI PHI FU FI UTHD ITHD MATH MCR
	<Element>	1 (If <Element> is omitted, the element is set to 1) (For the GPM-8310, only set to 1 or omitted)

Example :DISPLAY:NORMAL:ITEM1 U,1
:DISPLAY:NORMAL:ITEM1?
->:DISPLAY:NORMAL:ITEM1 U,1

<Function>	Function	GPM-8310 Indicator
U	Voltage U	[V]
UPPeak	Maximum voltage: U+pk	[V+pk]
UMPeak	Minimum voltage: U-pk	[V-pk]
I	Current I	[I]
IPPeak	Maximum current: I+pk	[I+pk]
IMPeak	Minimum current: I-pk	[I-pk]
P	Active power P	[P]
PPPeak	Maximum power: P+pk	[P+pk]
PMPeak	Minimum power: P-pk	[P-pk]
S	Apparent power S	[VA]
Q	Reactive power Q	[VAR]
LAMBda	Power factor λ	[PF]
CFU	Voltage factor λ	[CFV]
CFI	Current factor λ	[CFI]
PHI	Phase difference Φ	[DEG]
FU	Voltage frequency fu	[VHz]
FI	Current frequency fl	[AHz]
UTHD	Total harmonic distortion of voltage Uthd	[THDV]

ITHD	Total harmonic distortion of current Ithd	[THDI]
MATH	Mathematical Computation	[MATH]
MCR	Maximum Current Ratio	[MCR]

Set →

→ Query

:DISPlay:INTEgrate:ITEM<x>

Description	Sets or returns a Integrate measurement data display item. Refer to page 99 for details.	
Syntax	:DISPlay:INTEgrate:ITEM<x> <Function>[,<Element>]}	
Query Syntax	:DISPlay:INTEgrate:ITEM<x>?	
Parameter/	<x>	1 to 2(display).
Return parameter	<Function>	{WHP WHM WHAVG AHP AHM AHAVG U I}
	<Element>	1 (If <Element> is omitted, the element is set to 1) (For the GPM-8310, only set to 1 or omitted).

Example :DISPLAY:INTEGRATE:ITEM1 WHP,1
:DISPLAY:INTEGRATE:ITEM1?
->:DISPLAY:INTEGRATE:ITEM1 WHP,1

<Function>	Function	GPM-8310 Indicator
WHP	Positive watt hour WP+	[WP+]
WHM	Positive watt hour WP-	[WP-]
WHAVG	Average power	[P(avg)]
AHP	Positive ampere hour q+	[q+]
AHM	Positive ampere hour q	[q-]
AHAVG	Average current	[q(avg)]
U	Voltage U	[V]
I	Current I	[I]

Set →

→ Query

:DISPlay:PAGE

Description	Sets or returns the display page item.	
Syntax	:DISPlay:PAGE {<Function>}	
Query Syntax	:DISPlay:PAGE?	
Parameter/ Return parameter	<Function>	{MEASurement ENLArge INTEgrator SYSTem_INFO SYSTem_CONFig SETUp AVERage VA_RANGe_CONFig EXT_RANGe_CONFig RATIo EXTernal SAVE_LOAD OPTIon_DA GRAPh HARMonic_GRAPh HARMonic_LIST_GRAPh HARDCOPY SCPI MATH}
Example	:DISPlay:PAGE MEASUREMENT :DISPlay:PAGE? ->:DISPlay:PAGE MEASUREMENT	

HARMonics Command

:HARMonics	170
:HARMonics:DISPlay.....	170
:HARMonics:DISPlay[:STATe]	170
:HARMonics:DISPlay:ORDer	171
:HARMonics:PLLSource	171
:HARMonics:ORDer	172
:HARMonics:THD	172

:HARMonics → Query

Description Returns all harmonic measurement settings.

Query Syntax :HARMonics?

Return parameter <String>

:HARMonics:DISPlay → Query

Description Returns all harmonic measurement display settings.

Query Syntax :HARMonics:DISPlay?

Return parameter <String>

:HARMonics:DISPlay[:STATe] Set → → Query

Description Sets or returns the on/off state of harmonic measurement data display.

Syntax :HARMonics:DISPlay[:STATe] {<Boolean>|OFF|ON}

Query Syntax :HARMonics:DISPlay[:STATe]?

Parameter	<Boolean>0	OFF
	<Boolean>1	ON
Return parameter	0	Turn the harmonic display off.
	1	Turn the harmonic display on.
Example	: HARMONICS:DISPLAY:STATE OFF : HARMONICS:DISPLAY:STATE? ->:HARMONICS:DISPLAY:STATE 0	

Set →
 → Query

:HARMonics:DISPlay:ORDer

Description	Sets or returns the harmonic order of the harmonic component that is shown in graph->hormoics->bar page for the harmonic measurement data display.	
Syntax	:HARMonics:DISPlay:ORDer {<NR1>}	
Query Syntax	:HARMonics:DISPlay:ORDer?	
Parameter/	<NR1>	1 to 50 (harmonic order).
Return parameter		
Example	:HARMONICS:DISPLAY:ORDER 1 :HARMONICS:DISPLAY:ORDER? ->:HARMONICS:DISPLAY:ORDER 1	

Set →
 → Query

:HARMonics:PLLSource

Description	Sets or returns the PLL source.	
Syntax	:HARMonics:PLLSource {U1 I1}	
Query Syntax	:HARMonics:PLLSource?	
Parameter/	U1	Select pll source at voltage.
Return parameter	I1	Select pll source at current.
Example	:HARMONICS:PLLSOURCE U1 :HARMONICS:PLLSOURCE? ->:HARMONICS:PLLSOURCE U1	

Set →

→ Query

:HARMonics:ORDer

Description	Sets or returns the maximum and minimum harmonic orders that are analyzed.	
Syntax	:HARMonics:ORDer {<NRf>,<NRf>}	
Query Syntax	:HARMonics:ORDer?	
Parameter/ Return parameter	1st <NRf>	1 (minimum harmonic order, fixed at 1)
	2nd <NRf>	50 (maximum harmonic order)
Example	:HARMONICS:ORDER 1,20 :HARMONICS:ORDER? ->:HARMONICS:ORDER 1,20	

Set →

→ Query

:HARMonics:THD

Description	Sets or returns the equation used to compute the THD (total harmonic distortion).	
Syntax	:HARMonics:THD {TOTal FUNDamental}	
Query Syntax	:HARMonics:THD?	
Parameter/ Return parameter	TOTal	(CSA)
	FUNDamental	(IEC)
Example	:HARMONICS:THD FUNDAMENTAL :HARMONICS:THD? ->:HARMONICS:THD FUNDAMENTAL	

HOLD Command

:HOLD

Description Sets or returns the on/off state of the output hold feature for display, communication, and other types of data.

Syntax :HOLD {<Boolean>|OFF|ON}

Query Syntax :HOLD?

Parameter	<Boolean>0	OFF
	<Boolean>1	ON

Return parameter	0	Turn the hold function off.
	1	Turn the hold function on.

Example

```
:HOLD OFF
:HOLD?
->:HOLD 0
```

INPut Commands

:INPut.....	175
[:INPut]:WIRing.....	175
[:INPut]:MODE	176
[:INPut]:VOLTage	176
[:INPut]:VOLTage:RANGe	176
[:INPut]:VOLTage:AUTO	177
[:INPut]:VOLTage:CONFig	177
[:INPut]:VOLTage:POJump	178
[:INPut]:CURRent.....	178
[:INPut]:CURRent:RANGe	178
[:INPut]:CURRent:AUTO	179
[:INPut]:CURRent:CONFig	180
[:INPut]:CURRent:POJump.....	180
[:INPut]:CURRent:EXTSensor:CONFig<x>	181
[:INPut]:CURRent:EXTSensor:POJump<x>	181
[:INPut]:CURRent:SRATio:ELEMent1<x>	182
[:INPut]:RCONfig.....	183
[:INPut]:SCALing.....	183
[:INPut]:SCALing[:STATe]	183
[:INPut]:SCALing:{VT CT SFACtor}:ELEMent<x>	184
[:INPut]:SYNChronize.....	184
[:INPut]:FILTer	185
[:INPut]:FILTer:LINE	185
[:INPut]:FILTer:FREQuency	185
[:INPut]:POVer	186
[:INPut]:CRANge.....	186
[:INPut]:ZERO	187

:INPut

→ Query

 Description Returns all input settings.

 Query Syntax :INPut?

 Return parameter <String>

[[:INPut]:]CFACtor

Set →

→ Query

 Description Sets or returns the crest factor.

 Syntax [[:INPut]:]CFACtor {3|6|A6}

 Query Syntax [[:INPut]:]CFACtor?

Parameter/ Return parameter	3 6 A6	crest factor 3. crest factor 6. Display range expand mode (6A) for crest factor 6.
--------------------------------	--------------	--

 Example :INPUT:CFACtor 3
 :INPUT:CFACtor?
 ->:INPUT:CFACtor 3

Set →

→ Query

[[:INPut]:]WIRing

 Description Sets or returns the wiring system.

 Syntax [[:INPut]:]WIRing {P1W2 }

 Query Syntax [[:INPut]:]WIRing?

Parameter/ Return parameter	P1W2	Single-phase, two-wire system. (For the GPM-8310, the wiring system is fixed to P1W2)
--------------------------------	------	---

 Example :INPUT:WIRING P1W2
 :INPUT:WIRING?
 ->:INPUT:WIRING P1W2

Set →
 → Query

[:INPut]:MODE

Description	Sets or returns the voltage and current measurement mode.	
Syntax	[:INPut]:MODE {DC AC/RMS ACDC VMEan}	
Query Syntax	[:INPut]:MODE?	
Parameter/ Return parameter	DC	Select the dc measurement mode.
	AC/RMS	Select the ac measurement mode.
	ACDC	Select the acdc measurement mode.
	VMEan	Select the vmean measurement mode.
Example	:INPUT:MODE DC :INPUT:MODE? ->:INPUT:MODE DC	

[:INPut]:VOLTage

→ Query

Description	Returns all voltage measurement settings.	
Query Syntax	[:INPut]:VOLTage?	
Return parameter	<String>	

[:INPut]:VOLTage:RANGe

Set →
 → Query

Description	Sets or returns the voltage range.	
Syntax	[:INPut]:VOLTage:RANGe {<Voltage>}	
Query Syntax	[:INPut]:VOLTage:RANGe?	
Parameter/ Return parameter	<Voltage>	15, 30, 60, 150, 300, 600(V) when the crest factor is set to 3. 7.5, 15, 30, 75, 150, 300(V) when the crest factor is set to 6 or 6A.

Example :INPUT:VOLTAGE:RANGE 600V
 :INPUT:VOLTAGE:RANGE?
 ->:INPUT:VOLTAGE:RANGE 600.0E+00

[:INPut]:VOLTage:AUTO

Set →

→ Query

Description Sets or returns the voltage auto range on/off state.

Syntax [:INPut]:VOLTage:AUTO {<Boolean>|OFF|ON}

Query Syntax [:INPut]:VOLTage:AUTO?

Parameter <Boolean>0 OFF
 <Boolean>1 ON

Return parameter 0 Turn the voltage auto range function off.
 1 Turn the voltage auto range function on.

Example :INPUT:VOLTAGE:AUTO ON
 :INPUT:VOLTAGE:AUTO?
 ->:INPUT:VOLTAGE:AUTO 1

[:INPut]:VOLTage:CONFig

Set →

→ Query

Description Sets or returns the valid voltage range.

Syntax [:INPut]:VOLTage:CONFig {ALL|<Voltage>[,Voltage]...}

Query Syntax [:INPut]:VOLTage:CONFig?

Parameter/
 Return parameter ALL All ranges are valid.
 <Voltage> See(:INPut:VOLTage:RANGe).

Example :INPUT:VOLTAGE:CONFIG 300,150,30
 :INPUT:VOLTAGE:CONFIG?
 ->:INPUT:VOLTAGE:CONFIG 300.0E+00,150.0E+00,
 30.0E+00

Set →
 → Query

[:INPut]:VOLTage:POJump

Description	Sets or returns the jump destination range that is used when a voltage peak over-range occurs.	
Syntax	[:INPut]:VOLTage:POJump {OFF <Voltage>}	
Query Syntax	[:INPut]:VOLTage:POJump?	
Parameter/ Return parameter	OFF <Voltage>	No jump destination voltage range. See(:INPut:VOLTage:RANGe).
Example	:INPUT:VOLTAGE:POJUMP 600V :INPUT:VOLTAGE:POJUMP? ->:INPUT:VOLTAGE:POJUMP 600.0E+00	

→ Query

[:INPut]:CURRent

Description	Returns all current measurement settings.	
Query Syntax	[:INPut]:CURRent?	
Return parameter	<String>	

Set →
 → Query

[:INPut]:CURRent:RANGe

Description	Sets or returns the current range.	
Query	[:INPut]:CURRent:RANGe {<Current> (EXTernal<x>,<Voltage>)}	
Query Syntax	[:INPut]:CURRent:RANGe?	

Parameter/ Return parameter	<x>	1,2(EXT1,EXT2)
	<Current>	5, 10, 20, 50, 100, 200, 500(mA) 1, 2, 5, 10, 20(A) when the crest factor is set to 3.
		2.5, 5, 10, 25, 50, 100, 250(mA) 0.5, 1, 2.5, 5, 10(A) when the crest factor is set to 6 or 6A.
	EXternal1 <Voltage>	2.5, 5, 10(V) when the crest factor is set to 3. 1.25, 2.5, 5(V) when the crest factor is set to 6 or 6A.
	EXternal2 <Voltage>	50, 100, 200, 500,(mV), 1, 2(V) when the crest factor is set to 3. 25, 50, 100, 250,(mV), 0.5, 1(V) when the crest factor is set to 6 or 6A.

Example

```
:INPUT:CURRENT:RANGE 20A
:INPUT:CURRENT:RANGE?
->:INPUT:CURRENT:RANGE 20.0E+00
:INPUT:CURRENT:RANGE EXTERNAL1,10V
:INPUT:CURRENT:RANGE?
-> :INPUT:CURRENT:RANGE EXTERNAL1,10.0E+00
```

Set →
 → Query

[:INPut]:CURRent:AUTO

Description	Sets or returns the current auto range on/off state.	
Syntax	[:INPut]:CURRent:AUTO {<Boolean> OFF ON}	
Query Syntax	[:INPut]:CURRent:AUTO?	
Parameter	<Boolean>0	OFF
	<Boolean>1	ON
Return parameter	0	Turn the current auto range function off.
	1	Turn the current auto range function on.

Example :INPUT:CURRENT:AUTO ON
 :INPUT:CURRENT:AUTO?
 ->:INPUT:CURRENT:AUTO 1

[:INPut]:CURRent:CONFig Set →
← Query

Description	Sets or returns the valid current range.	
Syntax	[:INPut]:CURRent:CONFig {ALL <Current>[,Current]...}	
Query Syntax	[:INPut]:CURRent:CONFig?	
Parameter/ Return parameter	ALL <Current>	All ranges are valid. See(:INPut:CURRent:RANGe).
Example	:INPUT:CURRENT:CONFIG 20,10,1 :INPUT:CURRENT:CONFIG? ->:INPUT:CURRENT:CONFIG 20.0E+00,10.0E+00, 1.0E+00	

[:INPut]:CURRent:POJump Set →
← Query

Description	Sets or returns the jump destination range that is used when a current peak over-range occurs.	
Syntax	[:INPut]:CURRent:POJump {OFF <Current>}	
Query Syntax	[:INPut]:CURRent:POJump?	
Parameter/ Return parameter	OFF <Current >	No jump destination current range. See(:INPut:CURRent:RANGe).
Example	:INPUT:CURRENT:POJUMP 20A :INPUT:CURRENT:POJUMP? ->:INPUT:CURRENT:POJUMP 20.0E+00	

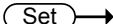
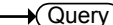
`[[:INPut]:CURRent:EXTSensor:CONFIg<x>`  



Description Sets or returns the valid external current sensor range.

Syntax `[[:INPut]:CURRent:EXTSensor:CONFIg<x>`
`{ALL|<Voltage>[,Voltage]...}`

Query Syntax `[[:INPut]:CURRent:EXTSensor:CONFIg<x>?`

Parameter/ Return parameter	<code><x></code>	1,2(EXT1,EXT2), If <code><x></code> is omitted, by default sets or returns EXT2 config.
	ALL	All ranges are valid.
	<code><Voltage></code>	See(:INPut:CURRent:RANGe).

Example `:INPUT:CURRENT:EXTSENSOR:CONFIG1 2,0.5,0.1`
`:INPUT:CURRENT:EXTSENSOR:CONFIG1?`
`->:INPUT:CURRENT:EXTSENSOR:CONFIG1`
`2.00E+00,500.0E-03,100.0E-03`

`[[:INPut]:CURRent:EXTSensor:POJumP<x>`  

Description Sets or returns the jump destination range that is used when a current peak over-range occurs.

Syntax `[[:INPut]:CURRent:EXTSensor:POJumP<x>`
`{OFF|<Voltage>}`

Query Syntax `[[:INPut]:CURRent:EXTSensor:POJumP<x>?`

Parameter/ Return parameter	<code><x></code>	1,2(EXT1,EXT2), If <code><x></code> is omitted, by default sets or returns EXT2 config.
	OFF	No jump destination current range.
	<code><Voltage></code>	See(:INPut:CURRent:RANGe).

Example `:INPUT:CURRENT:EXTSENSOR:POJUMP1 2V`
`:INPUT:CURRENT:EXTSENSOR:POJUMP1?`
`->:INPUT:CURRENT:EXTSENSOR:POJUMP1 2.00E+00`

Set →
 → Query

[:INPut]:CURRent:SRATio:ELEMEnt1<x>					
Description	Sets or returns the external current sensor conversion ratio of the specified element.				
Syntax	[:INPut]:CURRent:SRATio:ELEMEnt1<x> {<NRf>}				
Query Syntax	[:INPut]:CURRent:SRATio:ELEMEnt1<x>?				
Parameter/ Return parameter	<table style="width: 100%; border-collapse: collapse;"> <tr> <td style="width: 15%; padding: 5px;"><x></td> <td style="padding: 5px;">1,2(EXT1,EXT2), If <x> is omitted, by default sets or returns EXT2 config.</td> </tr> <tr> <td style="padding: 5px;"><NRf></td> <td style="padding: 5px;">0.001 to 9999</td> </tr> </table>	<x>	1,2(EXT1,EXT2), If <x> is omitted, by default sets or returns EXT2 config.	<NRf>	0.001 to 9999
<x>	1,2(EXT1,EXT2), If <x> is omitted, by default sets or returns EXT2 config.				
<NRf>	0.001 to 9999				
Example	<pre> :INPUT:CURRENT:SRATIO:ELEMENT11 10 :INPUT:CURRENT:SRATIO:ELEMENT11? ->:INPUT:CURRENT:SRATIO:ELEMENT1 EXT1,10.000 </pre>				

Set → → Query	
[[:INPut]:RCONfig	
Description	Sets or returns the on/off state of the range configuration (valid range selection) feature.
Syntax	[[:INPut]:RCONfig {<Boolean> OFF ON}
Query Syntax	[[:INPut]:RCONfig?
Parameter	<Boolean>0 OFF <Boolean>1 ON
Return parameter	0 Turn the range configuration feature off. 1 Turn the range configuration feature on.
Example	:INPUT:RCONFIG ON :INPUT:RCONFIG? ->:INPUT:RCONFIG 1

→ Query	
[[:INPut]:SCALing	
Description	Returns all scaling settings.
Query Syntax	[[:INPut]:SCALing?
Return parameter	<String>

Set → → Query	
[[:INPut]:SCALing[:STATe]	
Description	Sets or returns the scaling on/off state.
Syntax	[[:INPut]:SCALing[:STATe] {<Boolean> OFF ON}
Query Syntax	[[:INPut]:SCALing[:STATe]?
Parameter	<Boolean>0 OFF <Boolean>1 ON
Return parameter	0 Turn the scaling function off. 1 Turn the scaling function on.

Example :INPUT:SCALING:STATE ON
 :INPUT:SCALING:STATE?
 ->:INPUT:SCALING:STATE 1

[[:INPut]:SCALing:{VT|CT|SFACtor}:ELEMent<x> Set →
 → Query

Description	Sets or returns the VT ratio, CT ratio, or power coefficient of the specified element.	
Syntax	[:INPut]:SCALing:{VT CT SFACtor}:ELEMent<x> {<NRF>}	
Query Syntax	[:INPut]:SCALing:{VT CT SFACtor}:ELEMent<x>?	
Parameter/ Return parameter	<x>	1 (If <Element> is omitted, the element is set to 1) (For the GPM-8310, only set to 1 or omitted)
	<NRF>	0.001 to 9999
Example	:INPUT:SCALIG:VT:SRATIO:ELEMENT1 10 :INPUT:SCALIG:VT:SRATIO:ELEMENT1? ->:INPUT:SCALIG:VT:SRATIO:ELEMENT1 10	

[[:INPut]:SYNChronize Set →
 → Query

Description	Sets or returns the synchronization source.	
Syntax	[:INPut]:SYNChronize {VOLTage CURRent OFF}	
Query Syntax	[:INPut]:SYNChronize?	
Parameter/ Return parameter	VOLTage	Select the voltage synchronization source.
	CURRent	Select the current synchronization source.
	OFF	Select the off synchronization source.

Example	:INPUT:SYNCHRONIZE VOLTAGE :INPUT:SYNCHRONIZE? ->:INPUT:SYNCHRONIZE VOLTAGE
---------	---

[[:INPut]:FILTer → Query

Description	Returns all input filter settings.
-------------	------------------------------------

Query Syntax	[[:INPut]:FILTer?
--------------	-------------------

Return parameter	<String>
------------------	----------

[[:INPut]:FILTer:LINE Set →
→ Query

Description	Sets or returns the line filter.
-------------	----------------------------------

Syntax	[[:INPut]:FILTer:LINE {<Boolean> OFF ON}
--------	--

Query Syntax	[[:INPut]:FILTer:LINE?
--------------	------------------------

Parameter	<Boolean>0	OFF
	<Boolean>1	ON

Return parameter	0	Turn the line filter function off.
	1	Turn the line filter function on.

Example	:INPUT:FILTER:LINE OFF
	:INPUT:FILTER:LINE?
	->:INPUT:FILTER:LINE 0

[[:INPut]:FILTer:FREQuency Set →
→ Query

Description	Sets or returns the frequency filter.
-------------	---------------------------------------

Syntax	[[:INPut]:FILTer:FREQuency {<Boolean> OFF ON}
--------	---

Query Syntax	[[:INPut]:FILTer:FREQuency?
--------------	-----------------------------

Parameter	<Boolean>0	OFF
	<Boolean>1	ON
Return parameter	0	Turn the frequency filter function off.
	1	Turn the frequency filter function on.
Example	:INPUT:FILTER:FREQUEECNY OFF :INPUT:FILTER:FREQUEECNY? ->:INPUT:FILTER:FREQUEECNY 0	

[:INPut]:POVer → Query

Description	Returns the peak over-range information.	
Query Syntax	[:INPut]:POVer?	
Return parameter	Bit0	Voltage peak over-range is occurring.
	Bit1	Current peak over-range is occurring.
Example	:INPUT:POVER? ->:INPUT:POVER 1	

[:INPut]:CRANge → Query

Description	Sets or returns the check range status.	
Query Syntax	[:INPut]:CRANge?	

Return parameter	Bit0	The voltage is at the condition for reducing the auto range or less.
	Bit1	The voltage exceeds the condition for raising the auto range.
	Bit2	The voltage is over-range.
	Bit3	The voltage is peak over-range.
	Bit4	The current is at the condition for reducing the auto range or less.
	Bit5	The current exceeds the condition for raising the auto range.
	Bit6	The current is over-range.
	Bit7	The current is peak over-range.

Example :INPUT:CRANGE?
 ->:INPUT:CRANGE 8
 (Indicate the voltage is peak over-range)

Set →
 → Query

[:INPut]:ZERO

Description	Sets or returns the zero state.	
Syntax	[:INPut]:ZERO {<Boolean> OFF ON}	
Query Syntax	[:INPut]:ZERO?	
Parameter	<Boolean>0	OFF
	<Boolean>1	ON
Return parameter	0	Turn the zero function off.
	1	Turn the zero function on.

Example :INPUT:ZERO OFF
 :INPUT:ZERO?
 ->:INPUT:ZERO 0

INTEGrate Commands

:INTEGrate.....	188
:INTEGrate:MODE	188
:INTEGrate:FUNCTion	189
:INTEGrate:TIMer.....	189
:INTEGrate:START.....	189
:INTEGrate:STOP	190
:INTEGrate:RESet	190
:INTEGrate:STATe	190

:INTEGrate → Query

Description Returns all integration settings.

Query Syntax :INTEGrate?

Return parameter <String>

Set →

:INTEGrate:MODE → Query

Description Sets or returns the integration mode.

Syntax :INTEGrate:MODE {MANUal|NORMal|CONTInuous}

Query Syntax :INTEGrate:MODE?

Parameter/ Return parameter	MANUal	Manual integration mode.
	NORMal	Standard integration mode.
	CONTInuous	Continuous integration mode.

Example :INTEGRATE:MODE MANUAL
 :INTEGRATE:MODE?
 ->:INTEGRATE:MODE MANUAL

:INTEGrate:FUNcTion (Set) →
→ (Query)

Description	Sets or returns the integration function.	
Syntax	:INTEGrate:FUNcTion {WATT AMPere}	
Query Syntax	:INTEGrate:FUNcTion?	
Parameter/ Return parameter	WATT	Select the integration function watt.
	AMPere	Select the integration function ampere.
Example	:INTEGRATE:FUNCTION WATT	
	:INTEGRATE:FUNCTION?	
	->:INTEGRATE:FUNCTION WATT	

:INTEGrate:TIMer (Set) →
→ (Query)

Description	Sets or returns the integration timer value.	
Syntax	:INTEGrate:TIMer {<NRf>,<NRf>,<NRf>}	
Query Syntax	:INTEGrate:TIMer?	
Parameter/ Return parameter	1st <NRf>	0 to 9999 (hours)
	2nd <NRf>	0 to 59 (minutes)
	3rd <NRf>	0 to 59 (seconds)
Example	:INTEGRATE:TIMER 1,0,0	
	:INTEGRATE:TIMER?	
	->:INTEGRATE:TIMER 1,0,0	

:INTEGrate:STARt (Set) →

Description	Starts integration.
Syntax	:INTEGrate:STARt
Example	:INTEGRATE:STARt

:INTEGrate:STOP

Set →

Description Stops integration.

Syntax :INTEGrate:STOP

Example :INTEGRATE:STOP

:INTEGrate:RESet

Set →

Description Resets the integrated value.

Syntax :INTEGrate:RESet

Example :INTEGRATE:RESET

:INTEGrate:STATe

→ Query

Description Returns the integration status.

Query Syntax :INTEGrate:STATe?

Return parameter	ERRor	Integration overflows.
	RESet	Integration resets.
	STARt	Integration is in progress.
	STOP	Integration stops.
	TIMeup	Integration stops due to integration timeout.

Example :INTEGRATE:STATE?
->RESET

Math Commands

:MATH

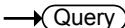
Description	Sets or returns the MATH equation.	
Syntax	:MATH {<Equation>[,<Parameter1>][,<Parameter2>]}	
Query Syntax	:MATH?	
Parameter/	Equation	{ADD SUB MUL DIV DIVA DIVB}
Return parameter	Parameter1	{U I P S Q}
	Parameter2	{U I P S Q}
Example	:MATH ADD Set math equation to A+B :MATH? ->:MATH ADD	

<Equation>	Definition
ADD	A+B
SUB	A-B
MUL	AxB
DIV	A/B
DIVA	A/B ²
DIVB	A ² /B
<Parameter1,2>	Definition
U	Voltage U
I	Current I
P	Active power P
S	Apparent power S
Q	Reactive power Q

MEASure Commands

:MEASure	192
:MEASure:AVERaging	192
:MEASure:AVERaging[:STATe]	192
:MEASure:AVERaging:TYPE	193
:MEASure:AVERaging:COUNt	193
:MEASure:MHOLd	193

:MEASure → Query

Description Returns all measured and computed data output settings.

Query Syntax :MEASure?

Return parameter <String>

:MEASure:AVERaging → Query

Description Returns all averaging settings.

Query Syntax :MEASure:AVERaging?

Return parameter <String>

:MEASure:AVERaging[:STATe] Set → → Query

Description Sets or returns the on/off state of averaging.

Syntax :MEASure:AVERaging[:STATe] {<Boolean>|OFF|ON}

Query Syntax :MEASure:AVERaging[:STATe]?

Parameter <Boolean>0 OFF

<Boolean>1 ON

Return parameter 0 Turn the averaging function off.

1 Turn the averaging function on.

Example :MEASURE:AVERAGING:STATE ON
 :MEASURE:AVERAGING:STATE?
 ->:MEASURE:AVERAGING:STATE 1

:MEASure:AVERaging:TYPE

Set →

→ Query

Description Sets or returns the averaging type.

Syntax :MEASure:AVERaging:TYPE {LINear|EXPonent}

Query Syntax :MEASure:AVERaging:TYPE?

Parameter/ Return parameter	LINear	Select averaging type to linear.
	EXPonent	Select averaging type to exponent.

Example :MEASURE:AVERAGING:TYPE LINEAR
 :MEASURE:AVERAGING:TYPE?
 ->:MEASURE:AVERAGING:TYPE LINEAR

Set →

→ Query

:MEASure:AVERaging:COUNT

Description Sets or returns the averaging coefficient.

Syntax :MEASure:AVERaging:COUNT {<NRf>}

Query Syntax :MEASure:AVERaging:COUNT?

Parameter/ Return parameter	<NRf>	8,16,32,64
--------------------------------	-------	------------

Example :MEASURE:AVERAGING:COUNT 8
 :MEASURE:AVERAGING:COUNT?
 ->:MEASURE:AVERAGING:COUNT 8

Set →

→ Query

:MEASure:MHOLD

Description Sets the MAX hold on/off state.

Syntax :MEASure:MHOLD {<Boolean>|OFF|ON}

Query Syntax :MEASureMHOLD?

Parameter	<Boolean>0	OFF
	<Boolean>1	ON
Return parameter	0	Turn the MAX hold function off.
	1	Turn the MAX hold function on.
Example	:MEASURE:MHOLD ON :MEASURE:MHOLD? ->:MEASURE:MHOLD 1	

NUMeric Commands

:NUMeric	195
:NUMeric:FORMat	195
:NUMeric:NORMal.....	196
:NUMeric[:NORMal]:VALue	196
:NUMeric[:NORMal]:NUMber	198
:NUMeric[:NORMal]:ITEM<x>	198
:NUMeric[:NORMal]:PRESet	202
:NUMeric[:NORMal]:CLEar	204
:NUMeric[:NORMal]:DELeTe	204
:NUMeric[:NORMal]:HEADer	205
:NUMeric:LIST	205
:NUMeric:LIST:VALue	206
:NUMeric:LIST:NUMber	206
:NUMeric:LIST:ORDer.....	207
:NUMeric:LIST:SELeCt.....	207
:NUMeric:LIST:ITEM<x>	208
:NUMeric:LIST:PRESet	209
:NUMeric:LIST:CLEar	210
:NUMeric:LIST:DELeTe	210
:NUMeric:HOLD	211

:NUMeric → Query

Description	Returns all numeric data output settings.
Query Syntax	:NUMeric?
Return parameter	<String>

:NUMeric:FORMat Set → → Query

Description	Sets or returns the numeric data format.
Syntax	:NUMeric:FORMat {ASCii FLOat}
Query Syntax	:NUMeric:FORMat?

Parameter/	AScii	Select numeric data format to ascii.
Return parameter	FLOat	Select numeric data format to float.
Example	:NUMERIC:FORMAT ASCII :NUMERIC:FORMAT? ->:NUMERIC:FORMAT ASCII	
Note	<ul style="list-style-type: none"> AScii Physical values are output in the <NR3> format. (Only the elapsed integration time—TIME—is output in <NR1> format). The data items are separated by commas. FLOat A header (for example, “#240” or “#3208”) is added in front of each numeric data block. A physical value in IEEE single-precision floating point (4-byte) format follows the header. #N (N-digit byte number) (data byte sequence). The byte order of the data of each item is MSB First. 	

:NUMeric:NORMal



Description	Returns all normal numeric data output settings.
Query Syntax	:NUMeric:NORMal?
Return parameter	<String>
Note	The number of numeric data items output by :NUMeric[:NORMal]:ITEM<x> is determined by :NUMeric[:NORMal]:NUMBER.

:NUMeric[:NORMal]:VALue



Description	Returns the numeric data.
Query Syntax	:NUMeric[:NORMal]:VALue? {<NRF>}

Parameter	<NRf> 1 to 50 (item number)
Example	<ul style="list-style-type: none"> If <NRf> is specified, only the numeric data for the specified item is output. :NUMERIC:NORMAL:VALUE? 1 -> 103.79E+00 If <NRf> is omitted, the numeric data items from 1 to the number specified by the : NUMERIC[:NORMAL]:NUMBER command are output in order. :NUMERIC:NORMAL:VALUE? -> 103.79E+00,1.0143E+00,105.27E+00,..(omitted)..,50.001E+00
Numeric Data Format	<ul style="list-style-type: none"> Measurement values U, I, P, PPPeak, PMPeak, S, Q, LAMBda, CFU, CFI, FU, FI, UTHD and ITHD Integrated values WH, WHP, WHM, AH, AHP and AHM. ASCII: <NR3> format. Example: [-]12.345E+00 Measurement values UPPeak, UMPeak, IPPeak and IMPeak. ASCII: <NR3> format. Example: [-]12.34E+00 Measurement values (PHI) ASCII: <NR3> = 0~9.9 format. Example: [-]9.9E+00 ASCII: <NR3> = 10~99.9 format. Example: [-]99.9E+00 ASCII: <NR3> = 100~999.9 format. Example: [-]999.9E+000 Elapsed integration time (TIME) ASCII: <NR1> format in units of seconds. Example: 3600 for 1 hour (1:00:00). <hr/> <ul style="list-style-type: none"> FLOAT: IEEE single-precision floating point (4-byte) format <hr/> <ul style="list-style-type: none"> No items (NONE) ASCII: NAN (Not A Number) FLOAT: 0x7E951BEE (9.91E+37)

Error Data	<ul style="list-style-type: none"> • Data does not exist (the display shows “-----”) <ul style="list-style-type: none"> ASCII: NAN (Not A Number) FLOAT: 0x7E951BEE (9.91E+37) • Data over (the display shows “-----“) <ul style="list-style-type: none"> ASCII: INF (INFinity) FLOAT: 0x7E94F56A (9.9E+37)
------------	---

Set →
 → Query

:NUMeric[:NORMal]:NUMBER

Description Sets or returns the number of numeric data items that are transmitted by the :NUMeric[:NORMal]:VALue? command.

Syntax :NUMeric[:NORMal]:NUMBER {<NRF>|ALL}

Query Syntax :NUMeric[:NORMal]:NUMBER?

**Parameter/
Return parameter** <NRF> 1 to 50(ALL)

Example :NUMERIC:NORMAL:NUMBER 10
 :NUMERIC:NORMAL:NUMBER
 ->:NUMERIC:NORMAL:NUMBER 10

Note

- If the parameter is omitted from the :NUMeric[:NORMal]:VALue? command, the numeric data items from 1 to the specified value are output in order.
- By default, the number of numeric data items is set to 3.

Set →
 → Query

:NUMeric[:NORMal]:ITEM<x>

Description Sets or returns the specified numeric data output item function.

Syntax :NUMeric[:NORMal]:ITEM<x>
 {NONE|<Function>[,<Element>][,Order]}

Query Syntax :NUMeric[:NORMal]:ITEM<x>?

Parameter/ Return parameter	<x>	1 to 50 (item number)
	NONE	No output item.
	<Function>	{U UPPeak UMPeak I IPPeak IMPeak P PPPeak PMPeak S Q LAMBda CFU CFI PHI FU FI UTHD ITHD WH WHP WHM AH AHP AHM TIME URANge IRANge MATH MCR} {UK IK PK LAMBDaK PHIK PHIUK PHIUK UHDfK IHDFK PHDFK}
	<Element>	1 (If <Element> is omitted, the element is set to 1) (For the GPM-8310, only set to 1 or omitted)
	<Order>	{TOTal DC <NRf>} (<NRf> = 1 to 50)

Example

```
:NUMERIC:NORMAL:ITEM1 U,1
:NUMERIC:NORMAL:ITEM1?
->:NUMERIC:NORMAL:ITEM1 U,1
:NUMERIC:NORMAL:ITEM1 UK,1,1
:NUMERIC:NORMAL:ITEM1?
->:NUMERIC:NORMAL:ITEM1 UK,1,1
```

- If <Order> is omitted, the order is set to TOTal.
- This instrument does not measure data for <Order> = DC.

<Function>	Function	GPM-8310 Indicator
U	Voltage U	[V]
UPPeak	Maximum voltage: U+pk	[V+pk]
UMPeak	Minimum voltage: U-pk	[V-pk]
I	Current I	[I]
IPPeak	Maximum current: I+pk	[I+pk]
IMPeak	Minimum current: I-pk	[I-pk]
P	Active power P	[P]

PPPeak	Maximum power: P+pk	[P+pk]
PMPeak	Minimum power: P-pk	[P-pk]
S	Apparent power S	[VA]
Q	Reactive power Q	[VAR]
LAMBda	Power factor λ	[PF]
CFU	Voltage factor λ	[CFV]
CFV	Current factor λ	[CFI]
PHI	Phase difference Φ	[DEG]
FU	Voltage frequency fu	[VHz]
FI	Current frequency fl	[AHz]
UTHD	Total harmonic distortion of voltage Uthd	[THDV]
ITHD	Total harmonic distortion of current lthd	[THDI]
WH	Watt hour WP	[WP]
WHP	Positive watt hour WP+	[WP+]
WHM	Positive watt hour WP-	[WP-]
AH	Ampere hour q	[q]
AHP	Positive ampere hour q+	[q+]
AHM	Positive ampere hour q	[q-]
TIME	Integration time	
URANge	Voltage range	
IRANge	Current range	
MATH	Mathematical Computation	[MATH]
MCR	Maximum Current Ratio	[MCR]
URMS	True rms voltage Urms	
UMN	Rectified mean voltage calibrated to the rms value Umn	[Vmn]
UDC	Simple voltage average Udc	[Vdc]

URMN	Rectified mean voltage U_{rmn}	
UAC	AC voltage component U_{ac}	[Vac]
IRMS	True rms current I_{rms}	
IMN	Rectified mean current calibrated to the rms value I_{mn}	
IDC	Simple current average I_{dc}	[Idc]
IRMN	Rectified mean current I_{rmn}	
IAC	AC current component I_{ac}	[Iac]
UK	Rms voltage of harmonic order k $U(k)$	[V]
IK	Rms current of harmonic order k $I(k)$	[A]
PK	Active power of harmonic order k $P(k)$	[P]
LAMBDAK	Power factor of harmonic order k $\lambda(k)$	
PHIK	Phase difference between the voltage and current of harmonic order k $\varphi(k)$	
PHIUk	Phase difference between harmonic voltage $U(k)$ and the fundamental wave $U(1)$ $\varphi_U(k)$	
PHIIk	Phase difference between harmonic current $I(k)$ and the fundamental wave $I(1)$ $\varphi_I(k)$	
UHDFk	Harmonic distortion factor of voltage $U_{hdf}(k)$	
IHDFk	Harmonic distortion factor of current $I_{hdf}(k)$	

PHDFk Harmonic distortion factor of
power Phdf(k)

:NUMeric[:NORMal]:PRESet



Description Presets the numeric data output item pattern.

Syntax :NUMeric[:NORMal]:PRESet {<Nrf>}

Parameter/
Return parameter <Nrf> 1 to 4

Example :NUMERIC:NORMAL:PRESET 1

Patterns 1	ITEM<x>	<Function>
	1	U
	2	I
	3	P

Patterns 2	ITEM<x>	<Function>
	1	U
	2	I
	3	P
	4	S
	5	Q
	6	LAMBda
	7	PHI
	8	FU
	9	FI

Patterns 3	ITEM<x>	<Function>
	1	U
	2	I
	3	P
	4	S
	5	Q

	6	LAMBda
	7	PHI
	8	FU
	9	FI
	10	UPPeak
	11	UMPeak
	12	IPPeak
	13	IMPeak
	14	PPPeak
	15	PMPeak
Patterns 4	ITEM<x>	<Function>
	1	U
	2	I
	3	P
	4	S
	5	Q
	6	LAMBda
	7	PHI
	8	FU
	9	FI
	10	UPPeak
	11	UMPeak
	12	IPPeak
	13	IMPeak
	14	TIME
	15	WH
	16	WHP
	17	WHM

18	AH
19	AHP
20	AHM

:NUMeric[:NORMal]:CLEar



Description	Clears numeric data output items (sets the items to NONE).	
Syntax	:NUMeric[:NORMal]:CLEar {ALL <NRf>[,<NRf>]}	
Parameter	ALL	Clear all items.
	1st <NRf>	1 to 50 (the number of the first item to clear)
	2nd <NRf>	1 to 50 (the number of the last item to clear)
Example	:NUMERIC:NORMAL:CLEAR ALL	
Note	If the 2nd <NRf> is omitted, the output item specified by the first and all following output items (up to number 50) are cleared.	

:NUMeric[:NORMal]:DELeTe



Description	Deletes numeric data output items.	
Syntax	:NUMeric[:NORMal]:DELeTe {<NRf>[,<NRf>]}	
Parameter	1st <NRf>	1 to 50 (the number of the first item to delete)
	2nd <NRf>	1 to 50 (the number of the last item to delete)
Example	:NUMERIC:NORMAL:DELETE 1 (Deletes ITEM1 and shifts ITEM2 and subsequent items forward).	
	:NUMERIC:NORMAL:DELETE 1,3 (Deletes ITEM1 to ITEM3 and shifts ITEM4 and subsequent items forward).	

Note	<ul style="list-style-type: none"> When output items are deleted, subsequent items shift forward to fill the empty positions. Empty positions at the end are set to NONE. If the second <NRf> is omitted, only the output item specified by the first number is deleted.
------	--

:NUMeric[:NORMal]:HEADer → Query

Description	Returns the numeric data header.
Syntax	:NUMeric[:NORMal]:HEADer? {<NRf>}
Parameter	<NRf> 1 to 50 (item number)
Example	<ul style="list-style-type: none"> If <NRf> is specified, only the data name for the specified item number is output. :NUMERIC:NORMAL:HEADER? 1 -> U-E1 If <NRf> is omitted, the data names of the items from 1 to the number specified by the : NUMeric[:NORMal]:NUMber command are output in order. :NUMERIC:NORMAL:NUMBER 3 :NUMERIC:NORMAL:HEADER? -> U-E1,I-E1,P-E1

:NUMeric:LIST → Query

Description	Returns all harmonic measurement numeric list data output settings.
Query Syntax	:NUMeric:LIST?
Return parameter	<String>
Note	The number of numeric list data items output by : NUMeric:LIST:ITEM<x> is determined by : NUMeric:LIST:NUMBER.

:NUMeric:LIST:VALue

→ Query

Description	Returns the harmonic measurement numeric list data.
Query Syntax	:NUMeric:LIST:VALue? {<NRf>}
Parameter	<NRf> 1 to 8 (item number)
Example	<ul style="list-style-type: none"> if <NRf> is specified :NUMERIC:LIST:VALUE? 1 -> 103.58E+00,NAN,103.53E+00,0.09E+00,2.07E+00,0.04E+00,.. (omitted)..,0.01E+00,0.01E+00 (up to 52 data values) if <NRf> is omitted (when :NUMeric:LIST:NUMBER is set to 5) :NUMERIC:LIST:VALUE? -> 103.58E+00,NAN,103.53E+00,0.09E+00,2.07E+00,0.04E+00,.. (omitted)..,0.00E+00,0.00E+00 (up to 52*5 = 260 data values) When :NUMeric:FORMat is set to {FLOat} :NUMERIC:LIST:VALUE? -> #N (N-digit byte number) (data byte sequence)

NOTE	<ul style="list-style-type: none"> A single numeric list data item consists of up to 52 items of numeric data in the following order: TOTal, DC, 1st harmonic, ..., :NUMeric:LIST:ORDER. If <NRf> is specified, only the numeric list data of the specified item number is output (up to 52 items of data) If <NRf> is omitted, the numeric list data of item numbers from 1 to :NUMeric:LIST:NUMBER is output in order (up to 52 times the number specified by :NUMeric:LIST:ORDER)
------	---

:NUMeric:LIST:NUMBER

Set →

→ Query

Description	Sets or returns the number of numeric list data items that are transmitted by :NUMeric:LIST:VALue? command.
Syntax	:NUMeric:LIST:NUMber {<NRf> ALL}
Query Syntax	:NUMeric:LIST:NUMber?
Parameter/ Return parameter	<NRf> 1 to 8(ALL)
Example	:NUMERIC:LIST:NUMBER 3 :NUMERIC:LIST:NUMBER? ->:NUMERIC:LIST:NUMBER 3
Note	<ul style="list-style-type: none"> • If the parameter is omitted from the :NUMeric:LIST:VALue? command, the numeric list data items from 1 to the specified value are output in order. • By default, the number of numeric data items is set to 3.

:NUMeric:LIST:ORDER (Set) →
→ (Query)

Description	Sets or returns the maximum output harmonic order of the harmonic measurement numeric list data.
Syntax	:NUMeric:LIST:ORDER {<NRf> ALL}
Query Syntax	:NUMeric:LIST:ORDER?
Parameter/ Return parameter	<NRf> 1 to 50(ALL)
Example	:NUMERIC:LIST:ORDER 10 :NUMERIC:LIST:ORDER? ->:NUMERIC:LIST:ORDER 10

:NUMeric:LIST:SElect (Set) →
→ (Query)

Description	Sets or returns the output components of the harmonic measurement numeric list data.	
Syntax	:NUMeric:LIST:SElect {EVEN ODD ALL}	
Query Syntax	:NUMeric:LIST:SElect?	
Parameter/ Return parameter	EVEN	Outputs the components of TOTal, DC, and even-order harmonics.
	ODD	Outputs the components of TOTal, DC, and odd-order harmonics .
	ALL	Outputs all components.
Example	:NUMERIC:LIST:SELECT ALL :NUMERIC:LIST:SELECT? ->:NUMERIC:LIST:SELECT ALL	

Set →

→ Query

:NUMeric:LIST:ITEM<x>

Description	Sets or returns the output item (function and element) of the specified harmonic measurement numeric list data item.	
Syntax	:NUMeric:LIST:ITEM<x> {NONE <Function>,<Element>}	
Query Syntax	:NUMeric:LIST:ITEM<x>?	
Parameter/ Return parameter	<x>	1 to 8 (item number)
	NONE	No output item.
	<Function>	{U P PHIU PHII UHDF UHDF PHDF}
	<Element>	1 (If <Element> is omitted, the element is set to 1) (For the GPM-8310, only set to 1 or omitted)
Example	:NUMERIC:LIST:ITEM1 U,1 :NUMERIC:LIST:ITEM1? ->:NUMERIC:LIST:ITEM1 U,1	

:NUMeric:LIST:PRESet



Description	Presets the harmonic measurement numeric list data output item pattern.	
Syntax	:NUMeric:LIST:PRESet {<NRf>}	
Parameter/ Return parameter	<NRf>	1 to 4
Example	:NUMERIC:LIST:PRESET 1	
Patterns 1	ITEM<x>	<Function>
	1	U
	2	I
	3	P
Patterns 2	ITEM<x>	<Function>
	1	U
	2	I
	3	P
	4	PHIU
	5	PHII
Patterns 3	ITEM<x>	<Function>
	1	U
	2	I
	3	P
	4	UHDF
	5	IHDF
	6	PHDF
Patterns 4	ITEM<x>	<Function>
	1	U
	2	I

3	P
4	PHIU
5	PHII
6	UHDF
7	IHDF
8	PHDF

:NUMeric:LIST:CLEar



Description	Clears numeric data output items (sets the items to NONE).	
Syntax	:NUMeric:LIST:CLEar {ALL <NRf>[,<NRf>]}	
Parameter	ALL	Clear all items.
	1st <NRf>	1 to 8 (the number of the first item to clear)
	2nd <NRf>	1 to 8 (the number of the last item to clear)
Example	:NUMERIC:LIST:CLEAR ALL	
Note	If the 2nd <NRf> is omitted, the output item specified by the first and all following output items (up to number 8) are cleared.	

:NUMeric:LIST:DElete



Description	Deletes numeric data output items.	
Syntax	:NUMeric:LIST:DElete {<NRf>[,<NRf>]}	
Parameter	1st <NRf>	1 to 50 (the number of the first item to delete)
	2nd <NRf>	1 to 50 (the number of the last item to delete)

Example :NUMERIC:LIST:DELETE 1 (Deletes ITEM1 and shifts ITEM2 and subsequent items forward).
 :NUMERIC:LIST:DELETE 1,3 (Deletes ITEM1 to ITEM3 and shifts ITEM4 and subsequent items forward).

- Note
- When output items are deleted, subsequent items shift forward to fill the empty positions. Empty positions at the end are set to NONE.
 - If the second <Nrf> is omitted, only the output item specified by the first number is deleted.

:NUMERIC:HOLD

Set →

→ Query

Description Sets or returns the on/off (hold/release) status of the numeric data hold feature.

Syntax :NUMERIC:HOLD {<Boolean>|OFF|ON}

Query Syntax :NUMERIC:HOLD?

Parameter <Boolean>0 OFF
 <Boolean>1 ON

Return parameter 0 Turn the numeric hold function off.
 1 Turn the numeric hold function on.

Example :NUMERIC:HOLD ON
 :NUMERIC:HOLD?
 ->:NUMERIC:HOLD 1

Note

- If :NUMeric:HOLD is set to ON before :NUMeric[:NORMal]:VALue? or :NUMeric:LIST:VALue? is executed, all the numeric data at that point in time can be held internally.
 - As long as :NUMeric:HOLD is set to ON, numeric data is held even when the numeric data on the screen is updated.
 - If :NUMeric:HOLD is set to ON after having already been set to ON before, the numeric data is cleared, and the most recent numeric data is held internally. When retrieving numeric data continuously, this method can be used to circumvent the need to repeatedly set :NUMeric:HOLD to OFF.
-

RATE Commands

:RATE.....	213
:RATE:AUTO	213
:RATE:AUTO:TIMEout	213
:RATE:AUTO:SYNChronize	214

:RATE



Description	Sets or returns the data update interval.	
Syntax	:RATE {<TIME> AUTO}	
Query Syntax	:RATE?	
Parameter/ Return parameter	<TIME>	100, 250, 500(ms), 1, 2, 5, 10, 20(s)
	AUTO	Select update rate at auto.
Example	:RATE 500MS :RATE? ->:RATE 500.0E-03	

:RATE:AUTO 

Description	Returns all applicable settings for when the data update interval is set to Auto.	
Query Syntax	:RATE:AUTO?	
Return parameter	<String>	

:RATE:AUTO:TIMEout



Description	Sets or returns the timeout for when the data update interval is set to Auto.	
Syntax	:RATE:AUTO:TIMEout {<TIME>}	

Query Syntax	:RATE:AUTO:TIMEout?	
Parameter/ Return parameter	<TIME>	1, 5, 10, 20(s)
Example	RATE:AUTO:TIMEOUT 1 :RATE:AUTO:TIMEOUT? -> :RATE:AUTO:TIMEOUT 1	

Set →
 → Query

:RATE:AUTO:SYNChronize

Description	Sets or returns the synchronization source for when the data update interval is set to Auto.	
Syntax	:RATE:AUTO:SYNChronize {U1 I1}	
Query Syntax	:RATE:AUTO:SYNChronize?	
Parameter/ Return parameter	U1	Select synchronize source at voltage.
	I1	Select synchronize source at current.
Example	:RATE:AUTO:SYNCHRONIZE U1 :RATE:AUTO:SYNCHRONIZE? -> :RATE:AUTO:SYNCHRONIZE U1	

RECall Commands

:RECall:NUMber	215
:RECall[:NORMal]:VALue.....	215
:RECall:LIST:VALue.....	216
:RECall:PANel.....	216

:RECall:NUMber → Query

Description Returns the number of blocks of measured data that is stored.

Query Syntax :RECall:NUMber?

Example :RECall:NUMber?
->100

:RECall[:NORMal]:VALue → Query

Description Returns the numeric data at the specified block number.

Query Syntax :RECall[:NORMal]:VALue? {<NRf>}

Parameter <NRf> 1 to 10000 (block number)

Example

- if <NRf> is specified, the numeric data at the specified block number will be returned.
- If you omit <NRf> or specify a number greater than the number of blocks that contain stored measured data (the number returned by :RECall:NUMber?), the entire returned numeric data will be “NAN” (no data).
- The output items and format are the same as those of “:NUMeric[:NORMal]:VALue? (when the item number is not specified).” To set the output items and format, use the NUMeric group commands.

:RECall:LIST:VALue

→ **Query**

Description	Returns the numeric list data of harmonic measurement at the specified block number.
Query Syntax	:RECall:LIST:VALue? {<NRf>}
Parameter	<NRf> 1 to 1000 (block number)
Example	<ul style="list-style-type: none"> • if <NRf> is specified, the numeric list data at the specified block number will be returned. • If you omit <NRf> or specify a number greater than the number of blocks that contain stored measured data (the number returned by :RECall:NUMber?), the entire returned numeric data will be "NAN" (no data). • The output items and format are the same as those of ":NUMeric:LIST:VALue?" (when the item number is not specified)." To set the output items and format, use the NUMeric group commands.

:RECall:PANel

Set →

Description	Loads a setup parameter file.
Syntax	:RECall:PANel {<NRf>}
Parameter	<NRf> 1 to 4 (file number)
Example	:RECall:PANel 2

STATus Commands

:STATus	217
:STATus:CONDition	217
:STATus:EESE	217
:STATus:EESR	218
:STATus:ERRor.....	218
:STATus:FILTer<x>	219
:STATus:QENable.....	220
:STATus:QMESsage.....	220

:STATus

→ Query

Description Returns all the settings for the communication status feature.

Query Syntax :STATus?

Return parameter <String>

:STATus:CONDition

→ Query

Description Returns the contents of the condition register.

Query Syntax :STATus:CONDition?

Return parameter <NR1> 0 to 65535

Example :STATUS:CONDITION?
-> 8

Note For information about the condition register, see Appendix, "Status system" at page 239.

:STATus:EESE

Set →

→ Query

Description Sets or returns the extended event enable register.

Syntax :STATus:EESE {<NRF>}

Query Syntax	:STATus:EESE?
Parameter/ Return parameter	<NRf> 0 to 65535
Example	:STATUS:EESE 16 :STATUS:EESE? -> :STATUS:EESE 16
Note	For information about the condition register, see Appendix, "Status system" at page 239.

:STATus:EESR → Query

Description	Returns the contents of the extended event register and clears the register.
Query Syntax	:STATus:EESR?
Return parameter	<NR1> 0 to 65535
Example	:STATUS:EESR? -> 16
Note	For information about the condition register, see Appendix, "Status system" at page 239.

:STATus:ERRor → Query

Description	Returns the error code and message of the last error that has occurred (top of the error queue).
Query Syntax	:STATus:ERRor?
Return parameter	<String>
Example	:STATUS:ERRor? -> 113, "Underfined Header"

- Note
- If no errors have occurred, 0, "No error" is returned.
 - User can use the :STATUS:QMESsage command to specify whether the message is included.
 - Error message description:
 Error_103: Invalid separator
 Error_104: Data type error.
 Error_108: Parameter not allowed.
 Error_109: Missing parameter.
 Error_113: Undefined header.
 Error_131: Invalid suffix.
 Error_141: Invalid character data.
 Error_221: Setting conflict.
 Error_222: Data out of range.
 Error_813: Invalid operation.

Set →
 → Query

:STATUS:FILTer<x>

Description	Sets or returns the transition filter.	
Syntax	:STATUS:FILTer<x> {RISE FALL BOTH NEVer}	
Query Syntax	:STATUS:FILTer<x>?	
Parameter/ Return parameter	<x>	1~16
	RISE	An event is set when the bit changes from 0 to 1.
	FALL	An event is set when the bit changes from 1 to 0.
	BOTH	An event is set when the bit changes either from 1 to 0 or form 0 to 1.
	NEVer	An event is never trigger.
Example	:STATUS:FILTer2 RISE :STATUS:FILTer2? -> :STATUS:FILTer2 RISE	

Note

- Set how each bit in the condition register must change to trigger the setting of an event.
- For information about the condition register, see Appendix, "Status system" at page 239.

:STATus:QENable

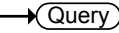

Description Sets or returns whether messages other than errors will be stored to the error queue (ON) or not (OFF).

Syntax :STATus:QENable {<Boolean>|OFF|ON}

Query Syntax :STATus:QENable?

Parameter <Boolean>0 OFF
<Boolean>1 ON

Return parameter 0 Function is off.
1 Function is on.

Example :STATUS:QENABLE ON
:STATUS:QENABLE?
-> :STATUS:QENABLE 1

:STATus:QMESsage



Description Sets or returns whether message information will be attached to the response to the STATus:ERRor? query (ON/OFF).

Syntax :STATus:QMESsage {<Boolean>|OFF|ON}

Query Syntax :STATus:QMESsage?

Parameter <Boolean>0 OFF
<Boolean>1 ON

Return parameter 0 Function is off.
1 Function is on.

Example :STATUS:QMESSAGE ON
 :STATUS:QMESSAGE?
 -> :STATUS:QMESSAGE 1

STORe Commands

:STORe	222
:STORe[:STATe]	222
:STORe:INTerval.....	222
:STORe:PANel.....	223

:STORe → **Query**

Description Returns all storage settings.

Syntax :STORe?

Return parameter <String>

:STORe[:STATe]
Set →
 → Query

Description Sets or returns the storage on/off state.

Syntax :STORe[:STATe] {<Boolean>|OFF|ON}

Query Syntax :STORe[:STATe]?

Parameter <Boolean>0 OFF
 <Boolean>1 ON

Return parameter 0 Storage function is off.
 1 Storage function is on.

Example :STORe:STATE ON
 :STORe:STATE?
 ->:STORe:STATE 1

:STORe:INTerval
Set →
 → Query

Description Sets or returns the storage interval.

Syntax :STORe:INTerval {<NRF>,<NRF>,<NRF>}

Query Syntax :STORe:INTerval?

Parameter/	1st <NRf>	0 to 99 (hours)
Return parameter	2nd <NRf>	0 to 59 (minutes)
	3rd <NRf>	0 to 59 (seconds)
Example	:STORE:INTERVAL 0,0,1 :STORE:INTERVAL? ->:STORE:INTERVAL 0,0,1	
Note	• When time interval is set 00:00:00, the storage interval is identical with the designated data update interval.	

:STORE:PANel



Description	Saves setup parameters to a file.	
Syntax	:STORE:PANel {<NRf>}	
Parameter	<NRf>	1 to 4 (file number)
Example	:STORE:PANel 1	

SYSTEM Commands

:SYSTEM.....	224
:SYSTEM:BRIGhtness	224
:SYSTEM:COMMUnicate:COMMAnd.....	224
:SYSTEM:COMMUnicate:ETHernet:MACAddress	225
:SYSTEM:FIRMware:DATE	225
:SYSTEM:KLOCK	226
:SYSTEM:MODEl.....	226
:SYSTEM:RESolution	227
:SYSTEM:SERial	227
:SYSTEM:VERsion[:FIRMware]	227

:SYSTEM

→ Query

Description Returns all system settings.

Query Syntax :SYSTEM?

Return parameter <String>

Set →

:SYSTEM:BRIGhtness

→ Query

Description Sets or returns the brightness level.

Syntax :SYSTEM:BRIGhtness {<NRf>}

Query Syntax :SYSTEM:BRIGhtness?

Parameter/ Return parameter <NRf> 1~10

Example :SYSTEM:BRIGhtNESS 7
:SYSTEM:BRIGhtNESS?
->:SYSTEM:BRIGhtNESS 7

Set →

:SYSTEM:COMMUnicate:COMMAnd

→ Query

Description	Sets or returns the command type.	
Syntax	:SYSTem:COMMunicate:COMMMand {DEFAULT USER}	
Query Syntax	:SYSTem:COMMunicate:COMMMand?	
Parameter/	DEFAULT	GPM8310.
Return parameter	USER	User-define.
Example	:SYSTEM:COMMUNICATE:COMMAND DEFAULT :SYSTEM:COMMUNICATE:COMMAND? ->:SYSTEM:COMMUNICATE:COMMAND DEFAULT	
Note	<ul style="list-style-type: none"> The SCPI mode is used to determine whether the *IDN? query returns the “Default” or “User” identification string. 	

:SYSTem:COMMunicate:ETHernet:MACAddress → **Query**

Description	Returns the Ethernet MAC address.	
Query Syntax	:SYSTem:COMMunicate:ETHernet:MACAddress?	
Example	:SYSTEM:COMMUNICATE:ETHERNET:MACADDRESS? - >:SYSTEM:COMMUNICATE:ETHERNET:MACADDRESS 00:22:24:00:00:00	

:SYSTem:FIRMware:DATE → **Query**

Description	Returns the firmware date.	
Query Syntax	:SYSTem:FIRMware:DATE?	
Return parameter	<Date>	yyyymmdd
Example	:SYSEm:FIRMWARE:DATE? ->:SYSEm:FIRMWARE:DATE 20200101	

:SYSTem:KEY:BEEPer → **Query**

Description	Sets or returns the keyclick beeper state.	
-------------	--	--

Syntax	:SYSTem:KEY:BEEPer {<Boolean> OFF ON}	
Query Syntax	:SYSTem:KEY:BEEPer?	
Parameter	<Boolean> 0	OFF
	<Boolean> 1	ON
Return parameter	0	Turn the keyclick beeper function off.
	1	Turn the keyclick beeper function on.
Example	:SYSTEM:KEY:BEEPER OFF	
	:SYSTEM:KEY:BEEPER?	
	->:SYSTEM:KEY:BEEPER 0	

Set →
→ Query

:SYSTem:KLOCK		
Description	Sets or returns the on/off state of the key protection.	
Syntax	:SYSTem:KLOCK {<Boolean> OFF ON}	
Query Syntax	:SYSTem:KLOCK?	
Parameter	<Boolean> 0	OFF
	<Boolean> 1	ON
Return parameter	0	Turn the key protection function off.
	1	Turn the key protection function on.
Example	:SYSTEM:KLOCK OFF	
	:SYSTEM:KLOCK?	
	->:SYSTEM:KLOCK 0	

→ Query

:SYSTem:MODEL		
Description	Returns the model code.	
Syntax	:SYSTem:MODEL?	
Example	:SYSTEM:MODEL?	
	->:SYSTEM:MODEL "GPM-8310"	

:SYSTem:RESolution → Query

Description Returns the numeric data display resolution.

Query Syntax :SYSTem:RESolution?

Example :SYSTEM:RESOLUTION?
->:SYSTEM:RESOLUTION 5

:SYSTem:SERial → Query

Description Returns the serial number.

Syntax :SYSTem:SERial?

Example :SYSTEM:SERIAL?
->:SYSTER:SERIAL 123456789A

:SYSTem:VERsion[:FIRMware] → Query

Description Returns the firmware version.

Query Syntax :SYSTem:VERsion[:FIRMware]?

Example :SYSTEM:VERSION:FIRMWARE?
->"V1.00"

Note Returns the Ver. item string of the system Information menu.

A PPENDIX

Specifications	229
General Specifications.....	229
Input	230
Voltage and Current Accuracy.....	231
Active Power Accuracy.....	232
Voltage, Current and Active Power Measurements	233
Frequency Measurement.....	235
Integration	236
Harmonic Measurement.....	236
D/A Output (Options)	237
Remote Control Input/Output Signal (Options)	237
Digital IO Signal (Options)	238
Status system	239
Dimensions	243
Declaration of Conformity	244
Power measurement.....	245
Measurement for small current	245
Measurement for large current	246
Introduction to IEC-62301	247
Recommended parameters for power measurement	247
EUP Directive Lot6 specifications	248
Connection Guide	249
Rear panel	249
Direct connection: $I < 1A$	249
Direct connection: $1A < I < 20A$	250
Connection with CT/VT	250
Connection with EXT1/2.....	251

Specifications

Below are the basic conditions required to operate the GPM-8310 within specification:

- Calibration: Yearly
- Operating Environment: 18~28 °C (64.4~82.4°F)
- Humidity: <80%RH,
- Accuracy: ± (% of reading + % of range)
- The specifications apply when it warmed up for at least 30 minutes and operates in the slow rate.
- The power supply cable must be grounded to ensure accuracy.
- Input voltage and current must be standard sine wave.
- The power factor must be 1.
- The crest factor must be 3.
- The common-mode voltage must be zero.

General Specifications

Specification Conditions:

Temperature: 23°C±5°C

Humidity: <80%RH(non-condensing)

Operating Environment: (0~40°C)

Temperature Range: 30~40°C, Relative Humidity: <70%RH(non-condensing);
>40°C, Relative Humidity: <50%RH(non-condensing)

Indoor use only

Altitude: <2000 meters

Pollution degree 2

Storage Conditions (-40~70°C)

Humidity: <90%RH(non-condensing)

General:

Power Source: 100-240 VAC 50/60Hz

Power Consumption: Max 30VA

Bench Dimensions: 268 mm (W) X 107 mm (H) X 379 mm (D) (w/t bumpers)

Weight: Approximately 2.9 kg

Input

Item	Specifications
Input type	Voltage Floating input through resistive voltage divider
	Current Floating input through shunt
Measure range	Voltage 15 V, 30 V, 60 V, 150 V, 300 V, 600 V
	Current
	Direct input 5 mA, 10 mA, 20 mA, 50 mA, 100 mA, 200 mA, 0.5 A, 1 A, 2 A, 5 A, 10 A, 20 A
	Sensor input EX1: 2.5 V, 5 V, 10 V EX2: 50 mV, 100 mV, 200 mV, 500 mV, 1 V, 2 V
Input impedance	Voltage Input resistance: approach 2 MΩ
	Current
	Direct input range 5 mA ~ 200 mA Input resistance: approach 505 mΩ
	Direct input range 0.5A ~ 20 A Input resistance: approach 5 mΩ
	Sensor input
	Input range 2.5 V ~ 10 V (EX1) Input resistance: approach 100 kΩ Input range 50 mV ~ 2 V (EX2) Input resistance: approach 20 kΩ
Continuous maximum allowable input	Voltage peak value of 1.5 kV or RMS value of 1 kV, whichever is less
	Current
	Direct input range 5 mA ~ 200 mA peak value of 30 A or RMS value of 20 A, whichever is less
	Direct input range 0.5A ~ 20 A peak value of 100 A or RMS value of 30 A, whichever is less
Sensor input peak value less than or equal to 5 times of the rated range	
Input bandwidth	DC, 0.1 Hz ~ 100KHz
Continuous maximum Common-mode voltage	600 Vrms, CAT II
Line filter	select OFF or ON (cut off frequency of 500 Hz)
Frequency filter	select OFF or ON (cut off frequency of 500 Hz)
A/D converter	Simultaneous conversion voltage and current inputs
	Resolution 16bits
	Maximum conversion rate Approx. 300KHz

Voltage and Current Accuracy

Item	Specifications
Requirements	Temperature 23 ± 5°C
	Humidity 30~75% RH
	Input waveform Sine wave crest factor = 3
	common-mode voltage 0 V
	Number of displayed digits 5 digits
	Frequency filter Turn on to measure voltage or current of 200 Hz or less
	After 30 minutes after warm-up time has passed After measurement range is changed (zero-level compensation) Update interval is 250 ms
Accuracy	DC ± (0.1% of reading + 0.2% of range)
	0.1 Hz ≤ f < 45 Hz ± (0.1 % of reading + 0.2 % of range)
	45 Hz ≤ f ≤ 66 Hz ± (0.1 % of reading + 0.05 % of range)
	66 Hz < f ≤ 1kHz ± (0.1 % of reading + 0.2 % of range)
	1 kHz < f ≤ 10 kHz ± (0.07 *f) % of reading + 0.3% of range)
	10 kHz < f ≤ 100 kHz ± (0.5 % of reading + 0.5 % of range) ± [{0.04x(f-10)}] % of reading]
Temperature coefficient	Add ±0.03% of reading/°C within the range 5 to 18°C or 28 to 40°C.
When the line filter is turned ON	45 ~ 66 Hz Add 0.2 % of reading < 45 Hz Add 0.5 % of reading
Accuracy when the crest factor is set to 6 or 6A	accuracy obtained by doubling the measurement range error for the accuracy when the crest factor is set to 3
Accuracy changes caused by data update interval	When the data update interval is 100 ms, and Auto, add 0.05% of reading to the 0.1 Hz to 1 kHz accuracy.
Influence of temperature changes after zero-level compensation or range change	Add 0.02% of range/°C to the DC voltage accuracy. Add the following value to the DC current accuracies.
	5 mA/10 mA/20 mA/50 mA/100 mA/200 mA ranges 5 µA/°C 0.5 A/1 A/2 A/5 A/10 A/20 A 500 µA/°C ranges

	External current sensor input (/EX1) 1 mV/°C
	External current sensor input (/EX2) 50 μV/°C
Accuracy when the crest factor is set to 6 or 6A	accuracy obtained by doubling the measurement range error for the accuracy when the crest factor is set to 3
Accuracy changes caused by data update interval	When the data update interval is 100 ms, and Auto, add 0.05% of reading to the 0.1 Hz to 1 kHz accuracy.

Active Power Accuracy

Item	Specifications
Requirements	same as the conditions for voltage and current. Power factor 1
Accuracy	DC (0.1 % of reading + 0.2 % of range)
	0.1 Hz ≤ f < 45 Hz ± (0.3 % of reading + 0.2 % of range)
	45 Hz ≤ f ≤ 66 Hz ± (0.1 % of reading + 0.05 % of range)
	66 Hz < f ≤ 1kHz ± (0.2 % of reading + 0.2 % of range)
	1 kHz < f ≤ 10 kHz ± (0.1 % of reading + 0.3 % of range) ± [{0.067x(f-1)}] % of reading]
	10 kHz < f ≤ 100 kHz ± (0.5 % of reading + 0.5 % of range) ± [{0.09x(f-10)}] % of reading]
	when power factor (λ) = 0 (S: apparent power) ± 0.1 % of S for 45 Hz ≤ f ≤ 66 Hz ± {(0.1 + 0.15 × f) % of S } for up to 100 kHz as reference data
Influence of power factor	•f is frequency of input signal in kHz when 0 < λ < 1 (Φ: phase angle of the Voltage and current) (power reading) × [(power reading error%) + (power range %) × (power range / indicated apparent power value) + {tanΦ × (influence when λ=0)}]
When the line filter is turned ON	45 ~ 66 Hz Add 0.3 % of reading < 45 Hz Add 1 % of reading
Temperature coefficient	same as the temperature coefficient for voltage and current
Accuracy when the crest factor is set to 6 or 6A	accuracy obtained by doubling the measurement range error for the accuracy when the crest factor is set to 3

Accuracy of apparent power S	voltage accuracy + current accuracy
Accuracy of reactive power Q	accuracy of apparent power + $(\sqrt{1.0004 - \lambda^2}) - (\sqrt{1 - \lambda^2}) \times 100\%$ $\pm [(\lambda - \lambda/1.0002) + \cos\theta - \cos\{\theta + \sin^{-1}(\lambda/1.0002)\}] \pm 1$ digit (influence from the power factor when $\lambda = 0\%/100$)
Accuracy of power factor λ	$\pm [\cos\theta - \cos\{\theta + \sin^{-1}(\lambda/1.0002)\} + \sin^{-1}(\lambda/1.0002)] \pm 1$ digit (influence from the power factor when $\lambda = 0\%/100$)
Accuracy of phase difference Φ	± 1 digit when voltage and current are at the measurement range rated input
Accuracy when the crest factor is set to 6 or 6A	accuracy obtained by doubling the measurement range error for the accuracy when the crest factor is set to 3
Accuracy changes caused by data update interval	When the data update interval is 100 ms, and Auto, add 0.05% of reading to the 0.1 Hz to 1 kHz accuracy.

* f is the frequency of input signal in kHz

Voltage, Current and Active Power Measurements

Item	Specifications						
Measurement method	Digital sampling method						
Crest factor	3 or 6 (6A)						
Wiring system	Single-phase , two-wire(1 P2 W)						
Range select	Select manual or auto ranging						
	Auto-range increase						
	The range is upped when any of the following conditions is met.						
	<table border="0"> <tr> <td>Crest factor 3</td> <td>Urms or Irms exceeds 130% of the currently set measurement range. Upk, Ipk value of the input signal exceeds 300% of the currently set measurement range.</td> </tr> <tr> <td>Crest factor 6</td> <td>Urms or Irms exceeds 130% of the currently set measurement range. Upk, Ipk value of the input signal exceeds 600% of the currently set measurement range.</td> </tr> <tr> <td>Crest factor 6A</td> <td>Urms or Irms exceeds 260% of the currently set measurement range. Upk, Ipk value of the input signal exceeds 600% of the currently set measurement range.</td> </tr> </table>	Crest factor 3	Urms or Irms exceeds 130% of the currently set measurement range. Upk, Ipk value of the input signal exceeds 300% of the currently set measurement range.	Crest factor 6	Urms or Irms exceeds 130% of the currently set measurement range. Upk, Ipk value of the input signal exceeds 600% of the currently set measurement range.	Crest factor 6A	Urms or Irms exceeds 260% of the currently set measurement range. Upk, Ipk value of the input signal exceeds 600% of the currently set measurement range.
Crest factor 3	Urms or Irms exceeds 130% of the currently set measurement range. Upk, Ipk value of the input signal exceeds 300% of the currently set measurement range.						
Crest factor 6	Urms or Irms exceeds 130% of the currently set measurement range. Upk, Ipk value of the input signal exceeds 600% of the currently set measurement range.						
Crest factor 6A	Urms or Irms exceeds 260% of the currently set measurement range. Upk, Ipk value of the input signal exceeds 600% of the currently set measurement range.						
Auto range							

Auto-range decline

The range is downed when all of the following conditions are met.

- Crest factor 3
 - Urms or Irms is less than or equal to 30% of the measurement range.
 - Urms or Irms is less than or equal to 125% of the next lower measurement range.
 - Upk, Ipk value of the input signal exceeds 300% of the currently set measurement range.
- Crest factor 6 or 6A
 - Urms or Irms is less than or equal to 30% of the measurement range.
 - Urms or Irms is less than or equal to 125% of the next lower measurement range.
 - Upk, Ipk value of the input signal exceeds 600% of the currently set measurement range.

Display mode	Vrms (the true RMS value of voltage and current)
Switching	VOLTAGE MEAN (the rectified mean value calibrated to the RMS value of the voltage)
	AC
	DC
Measurement synchronization source	Select voltage, current, or off
	In the case of Auto Update Rate, select the voltage or current from the equipped element.
Line filter	Select OFF or ON (cutoff frequency at 500 Hz).
Peak measurement	Measures the peak (max, min) value of voltage, current or power from the instantaneous voltage, instantaneous current or instantaneous power that is sampled.
Zero-level compensation	Removes the internal offset of the measure unit (After measurement range is changed)
	Voltage Vrms , Vmn, Vdc , Vac
	Current Irms , Idc , Iac
	Active Power P
Measurement parameters	Apparent Power VA
	Reactive power VAR
	Power Factor PF
	Crest Factor CFI,CFV
	Phase Angle DEG

Frequency	IHz and VHz
Voltage Peak	V+pk and V-pk
Current Peak	I+pk and I-pk
Active Power Peak	P+pk and P-pk
Total Harmonic Distortion	THDI and THDV
Mathematical Computation	MATH
Maximum Current Ratio	MCR

Frequency Measurement

Item	Specifications	
Measurement item	Voltage and current	
Measurement frequency range	Data update interval	Measurement Frequency Range
	0.1 s	$20 \text{ Hz} \leq f \leq 100 \text{ kHz}$
	0.25 s	$10 \text{ Hz} \leq f \leq 100 \text{ kHz}$
	0.5 s	$5 \text{ Hz} \leq f \leq 100 \text{ kHz}$
	1 s	$2.0 \text{ Hz} \leq f \leq 100 \text{ kHz}$
	2 s	$1.0 \text{ Hz} \leq f \leq 100 \text{ kHz}$
	5 s	$0.5 \text{ Hz} \leq f \leq 100 \text{ kHz}$
	10 s	$0.2 \text{ Hz} \leq f \leq 100 \text{ kHz}$
	20 s	$0.1 \text{ Hz} \leq f \leq 100 \text{ kHz}$
	Auto (*)	$0.1 \text{ Hz} \leq f \leq 100 \text{ kHz}$
	(*) Limit of the measurement lower limit frequency by the Timeout setting	
	Timeout	lower limit frequency
	1 s	2.0 Hz
	5 s	0.5 Hz
10 s	0.2 Hz	
20 s	0.1 Hz	
Measurement range	Auto switching among six types: 100mHz, 1 Hz, 10 Hz, 100 Hz, 1 kHz, 10 kHz, and 100 kHz.	
Frequency filter	Select OFF or ON (cut off frequency of 500 Hz)	
Accuracy	Requirements	When the input signal level is 30% or more of the measurement range If the crest factor is set to 3. (60% or more if the crest factor is set to 6 or 6A)
		• Frequency filter is ON when measuring voltage or current of 200 Hz or less.
± (0.06% of reading)		

Integration

Item	Specifications
Mode	Select manual integration mode, standard integration mode, or repetitive integration mode.
Timer	Automatically stop integration by setting a timer. Selectable range: 0 hours 00 minutes 00 seconds to 9999 hours 59 minutes 59 seconds
Accuracy	$\pm(\text{Power accuracy (or current accuracy)} + 0.1\% \text{ of reading})$ (fixed range)
Range setting	Auto range or fixed range is available for Integration
Timer accuracy	$\pm 0.02\%$
Remote control	Start, stop and reset operations are available using an external remote signal. (option)

Harmonic Measurement

Item	Specifications			
Measured item	Voltage, Current, Power			
Measured method	Zero-cross simultaneous calculation method			
Frequency range	10 Hz to 1.2 kHz.			
FFT data length	4096 (Frequency must be 50Hz/60Hz and Update Rate must be greater than or equal to 0.25S)			
Sample rate, window width, and upper limit of Analysis orders*	Fundamental Frequency	Sample rate	Window Width	upper limit of Analysis orders
	45 Hz to 55 Hz	$f \times 512$	10	50
	54 Hz to 66 Hz	$f \times 512$	12	50
Sample rate, window width, and upper limit of Analysis orders*	1024			
	Fundamental Frequency	Sample rate	Window Width	upper limit of Analysis orders
	10 Hz to 67 Hz	$f \times 1024$	1	50
	67 Hz to 150 Hz	$f \times 512$	2	32
	150 Hz to 300 Hz	$f \times 256$	4	16
	300 Hz to 600 Hz	$f \times 128$	8	8
Accuracy	600 Hz to 1200 Hz	$f \times 64$	16	4
	Frequency	Voltage	Current	Power
	$10 \text{ Hz} \leq f < 45 \text{ Hz}$	0.15% of reading	0.15% of reading	0.35% of reading
		+ 0.35% of range	+ 0.35% of range	+ 0.50% of range
	$45 \text{ Hz} \leq f < 440 \text{ Hz}$	0.15% of reading	0.15% of reading	0.25% of reading

	+ 0.35% of range	+ 0.35% of range	+ 0.50% of range
440 Hz ≤ f < 1.2kHz	0.20% of reading	0.20% of reading	0.40% of reading
	+ 0.35% of range	+ 0.35% of range	+ 0.50% of range

- * 50Hz/60Hz Compliant IEC61000-4-7 (Update Rate must be ≥ 0.25S).
- * Harmonic calculation: FFT method in which FFT data length is divided into 2 types: 1024 and 4096.
- * FFT data length automatically switches in accord with the Frequency and Update Rate of measured signal.

D/A Output (Options)

Item	Specifications
Output voltage	±5 V FS (approach ±7.5 V maximum) against each rated value.
Number of output channels	4
Output items	Set for each channel : V, I, P, VA, VAR, PF, DEG, VHZ, IHZ, Vpk, Ipk, WP, WP±, q, q±, Off
Accuracy	±(accuracy of each measurement item + 0.2% of FS)(FS = 5 V)
D/A conversion resolution	16 bits
Minimum load	100 kΩ
Update Interval	Same as the data update interval. In the case of Auto Update Rate, update interval is equal to signal interval. More than 100ms.
Temperature coefficient	±0.05%/°C of FS

Remote Control Input/Output Signal (Options)

Item	Specifications
Remote control input signal	EXT HOLD, EXT TRIG, EXT START, EXT STOP, EXT RESET
Remote control output signal	INTEG BUSY
I/O level	TTL
I/O logic format	Negative logic, Falling edge

Digital IO Signal (Options)

Item	Specifications
I/O control output signal	OUT1, OUT2, OUT3, OUT4
I/O level	TTL
I/O sink current	Max 100mA (per/ch)

* Q (VAR), S (VA), λ (PF) and Φ (DEG) are originated from the measured values including voltage, current and active power which go through computation process. In respect to distorted signal input, accordingly, the value acquired from other instruments, which employ different methods, may differ from that acquired from GPM-8310 unit.

* "Zero" will be shown for S or Q and "--" will be displayed for λ and Φ when either current or voltage is less than 0.5% of the rated range (less than or equivalent to 1% when crest factor is set 6 or 6A).

Status system

The diagram below is a description of the status system

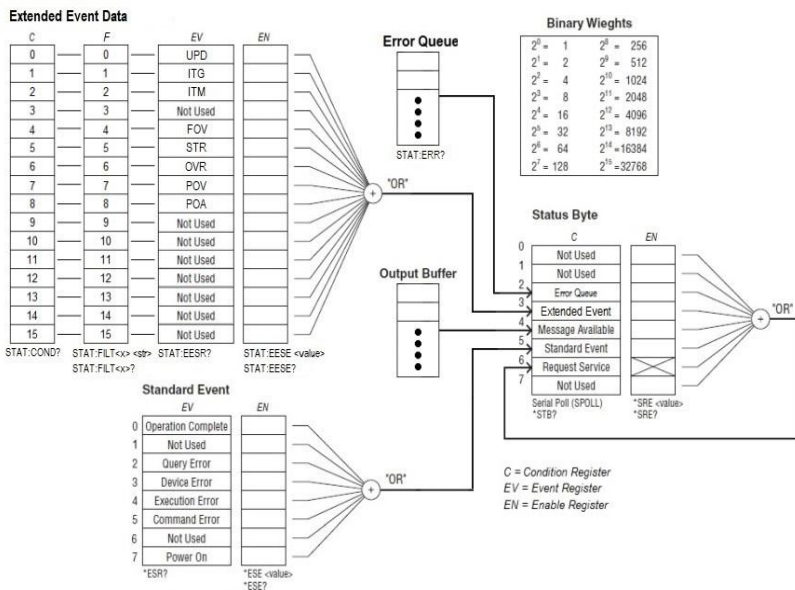

The extended event register receives information about changes in the condition register, which indicates the instrument's internal condition. The information is the result of edge detection performed by the transition filter.

The following table lists the bit definitions for the condition register:

Bit	Name	Decimal	Definition
0	Updating	1	The measured data is being updated. UPD changing from 1 to 0 indicates that updating has been completed.
1	Integrate Busy	2	During integration.
2	Integrate Time Busy	4	The integration timer is operating.
3	Not Used	8	(Reserved for future use)
4	Frequency Over	16	The frequency is outside the measurement range.
5	Store Busy	32	During storage.
6	Measured Data Over	64	The voltage or current exceeds its range.
7	Voltage Peak Over	128	A peak over-range is detected in the voltage.
8	Current Peak Over	256	A peak over-range is detected in the current.
9	Not Used	512	(Reserved for future use)
10	Not Used	1024	(Reserved for future use)
11	Not Used	2048	(Reserved for future use)
12	Not Used	4096	(Reserved for future use)
13	Not Used	8192	(Reserved for future use)
14	Not Used	16384	(Reserved for future use)
15	Not Used	32768	(Reserved for future use)

The transition filter parameters detect changes in the specified condition register bits (numeric suffixes 1 to 16) and overwrite the extended event register in the following ways.

Condition	Definition
RISE	The specified extended event register bit is set to 1 when the corresponding condition register bit changes from 0 to 1.
FALL	The specified extended event register bit is set to 1 when the corresponding condition register bit changes from 1 to 0.
BOTH	The specified extended event register bit is set to 1 when the corresponding condition register bit changes from 0 to 1 or from 1 to 0.
NEVer	Always zero.

The following table describes the Standard Event Register

Bit	Name	Decimal	Definition
0	Operation Complete	1	All commands prior to and including *OPC have been executed.
1	Not Used	2	(Reserved for future use)
2	Query Error	4	The instrument tried to read the output buffer but it was empty. Or, a new command line was received before a previous query has been read. Or, both the input and output buffers are full.
3	Device Error	8	A device error, including a self-test error or calibration error, occurred (an error in the -300 range or any positive error has been generated).
4	Execution Error	16	An execution error occurred (an error in the -200 range has been generated).
5	Command Error	32	A command syntax error occurred (an error in the -100 range has been generated).
6	Not Used	64	(Reserved for future use)
7	Power On	128	Power has been cycled since the last time the event register was read or cleared.

The following table describes the Status Byte Register.

Bit	Name	Decimal	Definition
0	Not Used	1	(Reserved for future use)
1	Not Used	2	(Reserved for future use)
2	Error Queue	4	One or more errors have been stored in the Error Queue. Use STAT:ERR? to read and delete errors.
3	Extended Event	8	One or more bits are set in the Extended Event Register (bits must be enabled, see STAT:EESE).
4	Message Available	16	Data is available in the instrument's output buffer.
5	Standard Event	32	One or more bits are set in the Standard Event Register (bits must be enabled, see *ESE).
6	Request Service	64	One or more bits are set in the Status Byte Register and may generate a Request for Service (RQS). Bits must be enabled using *SRE.
7	Not Used	128	(Reserved for future use)

Dimensions

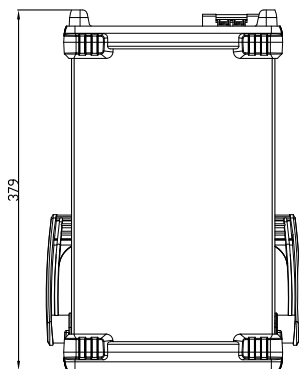

Units = mm

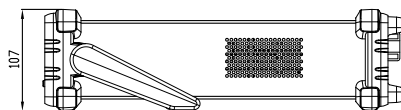
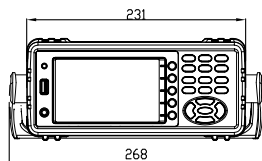

Declaration of Conformity

We

GOOD WILL INSTRUMENT CO., LTD.

declare that the below mentioned product

Type of Product: Digital Power Meter

Model Number: GPM-8310

are herewith confirmed to comply with the requirements set out in the Council Directive on the Approximation of the Law of Member States relating to EMC (2014/30/EU), LVD (2014/35/EU), WEEE (2012/19/EU) and RoHS (2011/65/EU).

For the evaluation regarding the Electromagnetic Compatibility and Low Voltage Directive, the following standards were applied:

© EMC	
EN 61326-1 : EN 61326-2-1:	Electrical equipment for measurement, control and laboratory use — EMC requirements (2013)
EN 55032:2015	Electromagnetic compatibility of multimedia equipment – Emission Requirements
Conducted and Radiated Emissions EN 55011:2016+A1:2017 Class A	Electrical Fast Transients EN 61000-4-4: 2012
Current Harmonic EN 61000-3-2:2019	Surge Immunity EN 61000-4-5: 2014+A1:2017
Voltage Fluctuation EN 61000-3-3:2013+A1:2019	Conducted Susceptibility EN 61000-4-6: 2014
Electrostatic Discharge EN 61000-4-2: 2009	Power Frequency Magnetic Field EN 61000-4-8:2010
Radiated Immunity EN 61000-4-3:2006+A1:2008+A2:2010	Voltage Dips/ Interrupts EN 61000-4-11: 2004+A1:2017
Low Voltage Equipment Directive 2014/35/EU	
Safety Requirements	EN 61010-1:2010+A1:2019 (Third Edition) EN 61010-2-030:2010 (First Edition)

GOODWILL INSTRUMENT CO., LTD.

No. 7-1, Jhongsing Road, Tucheng District, New Taipei City 236, Taiwan

Tel: [+886-2-2268-0389](tel:+886-2-2268-0389)

Fax: [+886-2-2268-0639](tel:+886-2-2268-0639)

Web: <http://www.gwinstek.com>

Email: marketing@goodwill.com.tw

GOODWILL INSTRUMENT (SUZHOU) CO., LTD.

No. 521, Zhujiang Road, Snd, Suzhou Jiangsu 215011, China

Tel: [+86-512-6661-7177](tel:+86-512-6661-7177)

Fax: [+86-512-6661-7277](tel:+86-512-6661-7277)

Web: <http://www.instek.com.cn>

Email: marketing@instek.com.cn

GOODWILL INSTRUMENT EURO B.V.

De Run 5427A, 5504DG Veldhoven, The Netherlands

Tel: [+31-\(0\)40-2557790](tel:+31-(0)40-2557790)

Fax: [+31-\(0\)40-2541194](tel:+31-(0)40-2541194)

Email: sales@gw-instek.eu

Power measurement

- Method
- Direct read method: Directly read the measurement value measured from power measuring instrument.
 - The average power method: Record the actual power value within a settable period of time and then take the average. A settable period of time isn't less than 10min. The maximum measurement interval is one second.
 - Energy accumulation method: Measure the energy within a settable period of time and then divide it by the time to get the power. A settable period of time isn't less than 10min. The cumulative energy must be greater than the resolution by 200 times.
-

Measurement for small current

Voltage measurement mode measured from power supply side (Connect to ammeter internally). The current measurement is accurate. The voltage measurement on load could be larger than the actual one due to partial pressure of multi-measurement ammeter.

Connection

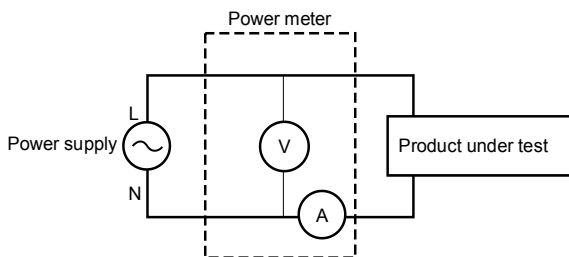

$$\text{Power loss} = (\text{Input current}[\text{A}])^2 \times 505\text{m}\Omega$$

Measurement for large current

Voltage measurement mode measured from load side (Connect to ammeter externally).

The voltage measurement is accurate. The current measurement on load could be larger than the actual one due to leakage current of multi-measurement voltage.

Connection

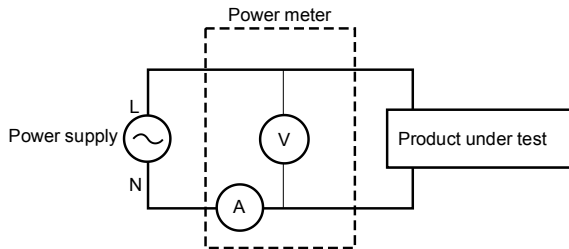

$$\text{Power loss} = (\text{Input voltage}[\text{V}])^2 / 2\text{M}\Omega$$

Introduction to IEC-62301

IEC 62301-2011 standard is an international basic standard for measuring standby power consumption of household appliances which is issued by IEEC. It is a standby power consumption measurement method for the various household appliances, power supply, audio and video appliances to comply with. The latest version for this standard is second edition of German standard IEC62301: 2011 (British regulations EN50564: 2011) which is issued on January, 2011. Only the products comply to the standard can have CE marking affixed on it.

Recommended parameters for power measurement

- Power resolution is less than or equal to 1mW.
- Time integrator function is available.
- Electric energy resolution is less than or equal to 1mWh and cumulative time resolution is less than or equal to 1 second.
- The crest factor is greater than or equal to 3.
- The minimum current range is less than or equal to 10mA.
- The active power includes AC and DC components.
- Over-range automatic alarm function is available.
- Turning off the auto range function is available.
- Harmonic bandwidth is greater than or equal to 2.5kHz.

The GPM-8310 meets all of the features listed above.

EUP Directive Lot6 specifications

Ecodesign directive for energy-using products:

The power loss requirement for the products with external power supply such as information devices, consumer electronics product, household appliances, toys, entertainment and sports products and so on in standby and off mode is as below.

Mode/Limit		2010.01	2013.01
Standby mode	Products with time display function.	≤ 2W	≤ 1W
	Products without time display function.	≤ 1W	≤ 0.5W
Shutdown mode		≤ 1W	≤ 0.5W

Connection Guide

Rear panel

Direct connection: $I < 1A$

Method 1

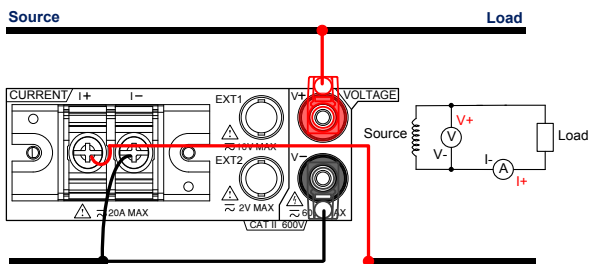

Method 2

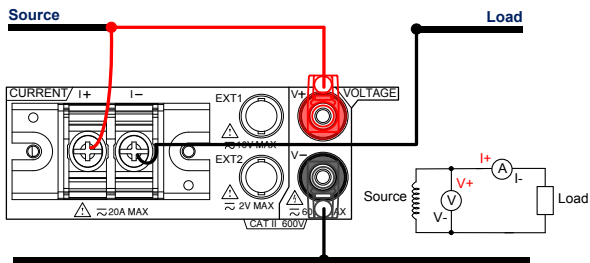

Direct connection: $1A < I < 20A$

Method 1

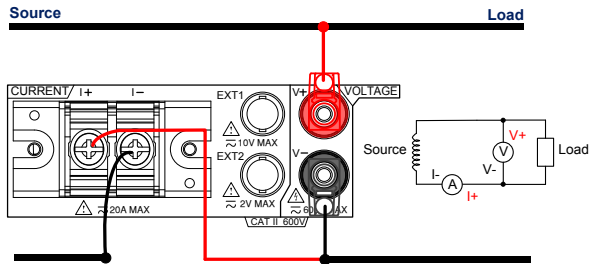

Method 2

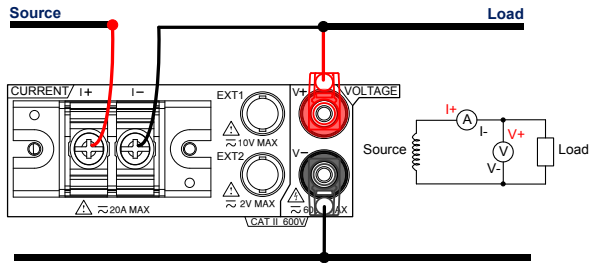

Connection with CT/VT

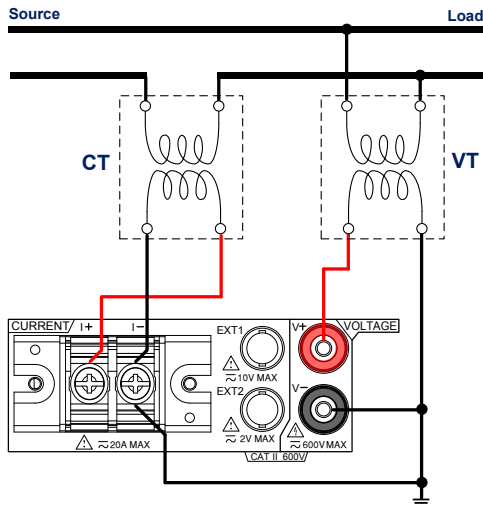

Connection with EXT1/2

EXT1

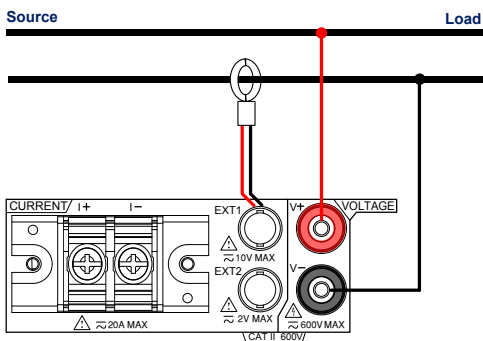

EXT2

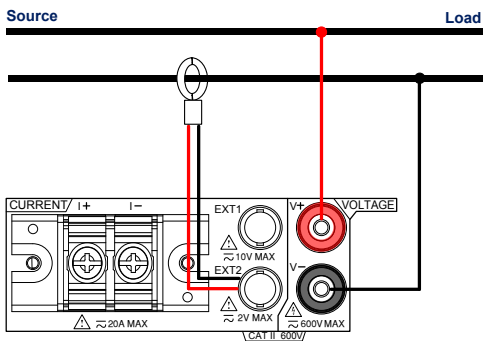

 Note

The optional GCP-300 accessory is required for EXT1 and EXT2 connection. Refer to your local dealer for more details.