

# midi LOGGER HV GL2000

## Quick Start Guide

604929220 GL2000-UM-851



**GRAPHTEC**

Thank you for choose the midi LOGGER HV GL2000.  
This Quick Start Guide describes the basic operations.  
Please refer to the manual (PDF) in the CD-ROM for more information.  
The explanation on how to use the ferrite core, tilt stand, and M3.5 screw  
can be found in the manual above. Please refer to them.

### Checking the Outer Casing

After unpacking, check the GL2000's Exterior to make sure that there are crack or other damage before use.

### Checking the Accessories

- Quick Start Guide : 1    • Ferrite core: 3    • CD-ROM : 1
- AC cable/AC adapter : 1    • Tilt stand: 1 set
- M3.5 screws: 1 set    • Notes for Safe Operation: 1

## Contents

Nomenclature .....	2
Connection Procedures .....	3
Precautions to Observe When Taking Measurementt .....	5
Descriptions of the Control Panel Keys .....	6
Descriptions of the Menu Screens .....	10
Measurement Procedure .....	14
1. Preparation for measurement .....	14
2. AMP setting .....	15
3. DATA setting .....	17
4. Recording and stopping .....	18
5. Playback method .....	19
Specifications .....	20
Standard Specifications .....	20
Specification of input section .....	21
Specification of Input/Output section .....	22
Installation Guide .....	22

# Nomenclature

## Top Panel

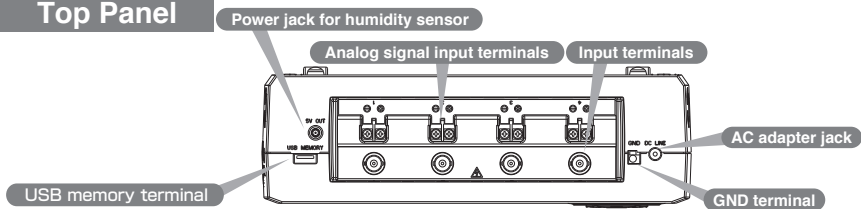

## Front Panel

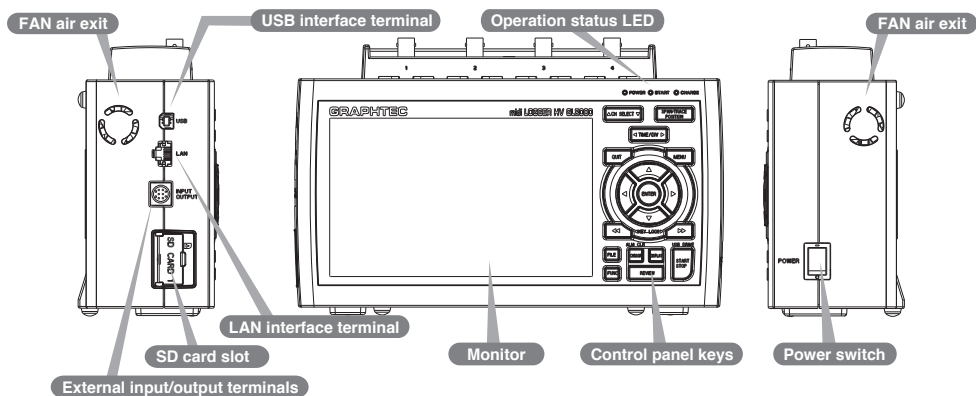

## Rear Panel

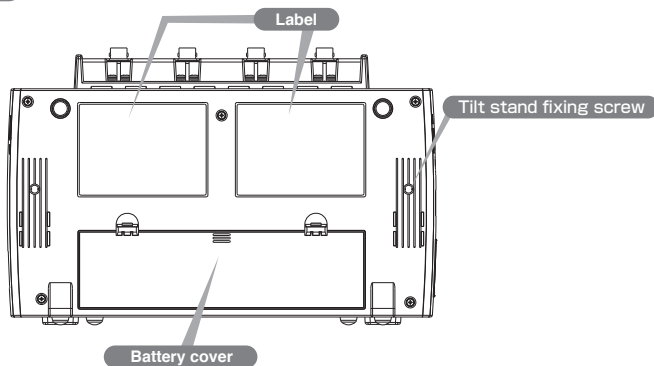

## Bottom Panel

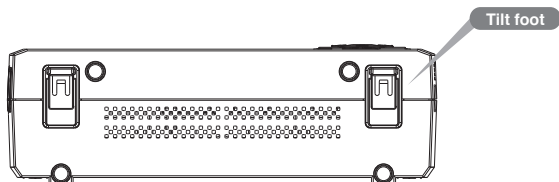

The illustration without cover is used for explanation purpose.

# Connection Procedures

## Connecting the AC Adapter

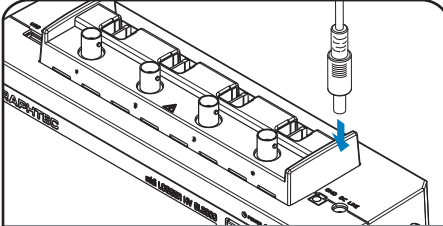

Connect the DC output of the AC adapter to the connector indicated as "DC LINE" on the GL2000.

## Connecting the Grounding Cable

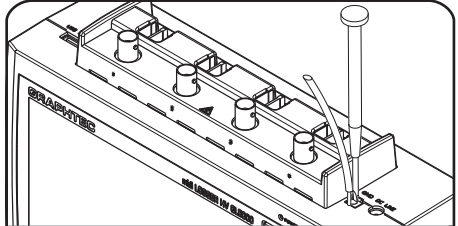

Use a flathead screwdriver to push the button above the GND terminal while connecting the grounding cable to the GL2000. Connect the other end of the cable to ground.

## Making Connections to the Analog Input Terminals

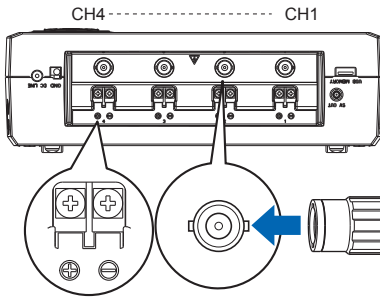

### DC voltage input

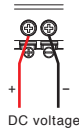

### Thermocouple input

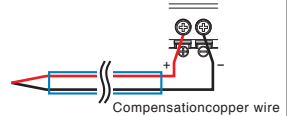

### Current input

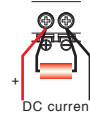

Ex: The current is converted to the voltage in the shunt register.  
For 4 to 20mA current input, installing 250 ohms (0.1%) resistor for converting 1 to 5V.

CAUTION: Connect wires to the specified channel, the channel number is shown on current of the terminal block

## Making Connections to the External Input/Output Terminals

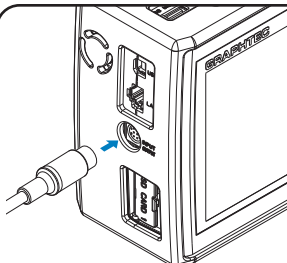

### < Signal assignment >

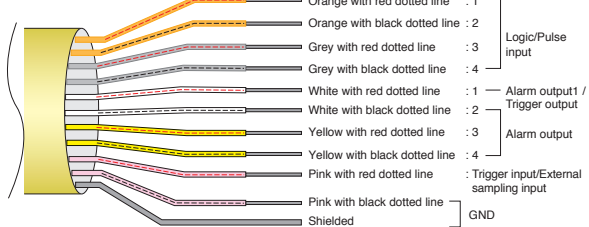

\* The B-513 input/output cable for GL2000 (sold separately) is required for connecting input/output signals. (For logic/pulse input, alarm output, trigger input, external sampling pulse input)

## Internal / External memory

This device is equipped with internal RAM and internal memory. The internal memory is not removable.

An SD card and USB memory are available.

\* Make sure that the SD card is not locked.

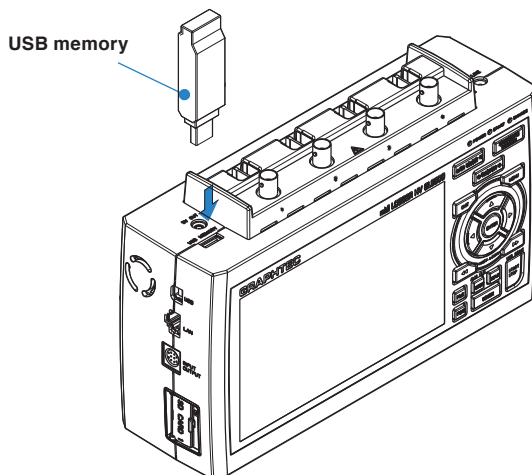
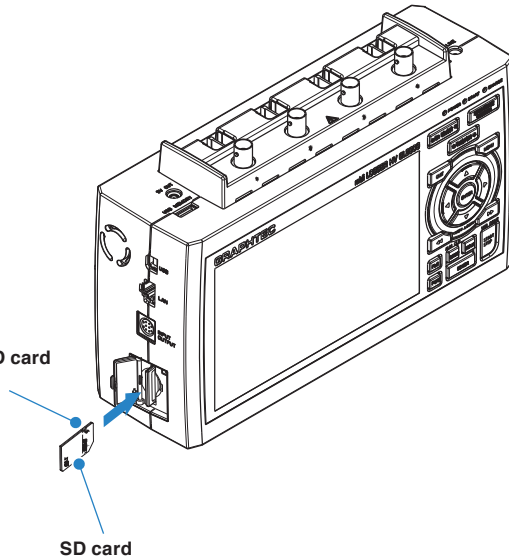

# Precautions to Observe When Taking Measurement

To avoid break-downs or short-circuiting accidents, please make sure to follow warnings written below.

## WARNING

- Use only the AC adapter provided as a standard accessory. The rated power supply range for the adapter is 100 to 240 VAC, and the rated frequency is 50/60 Hz. Do not use any other voltages.
- Do not input the voltage that exceeds the specification of this device.
  - If a voltage exceeding the specified value is input, the semiconductor relay in the input section will be damaged. Never input a voltage exceeding the specified value even for a moment. It will cause fire.
  - Have enough margin from the specification of withstanding voltage when using this device, it has to consider a noise and change of the measurement voltage.
  - Confirm this device is not broken before the input cable is connected to the input terminal.
  - Please take care of the static electricity when connecting the input cables or the thermocouples.
  - Do not touch the tip of thermocouples with bare hand after the thermocouples are connected to the terminal of this device when the tip is not insulated.
  - The static electricity from a human body will cause damage to the device.
  - Do not put the tip of thermocouples to an object which contains static electricity when the tip is not insulated. The static electricity from object will cause damage to the device.
  - Do not put the tip of thermocouples to the object which contains leaked high voltage from chassis or metal etc. when the tip is not insulated. The leaked high voltage from object will cause damage to this device.
  - We recommend that an insulation tape is placed on the tip of thermocouples before connecting it to the input terminals. This will protect the device from the static electricity and the leaked high voltage.
- To prevent electric shock and short circuit accident, do not connect to BNC terminal and screw terminal at the same time.

## When using

Please be sure to read the following carefully in order to prevent electric shocks or short circuit.

### ● Maximum input voltage

If a voltage exceeding the specified value is input, the parts in the input area will be damaged. Never input a voltage exceeding the specified value even for a moment.

< Between +/- terminals (A) >

- Maximum input voltage: Range of 20mV to 2V : AC/DC 30V  
Range of 5V to 1000V : AC/DC 600V

<Between input terminal and input terminal (B) >

Maximum input voltage: AC/DC 600V (CATIII) / AC/DC 300V (CAT IV)  
Withstand voltage: AC/DC5400V at 1 minute

<Between input terminal and GND (C) >

Maximum input voltage : AC/DC 600V (CATIII) / AC/DC 300V (CAT IV)  
Expected transient overvoltage : AC/DC5400V at 1 minute

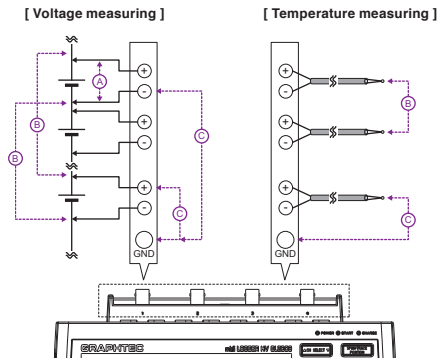

# Descriptions of the Control Panel Keys

This section describes key operation.

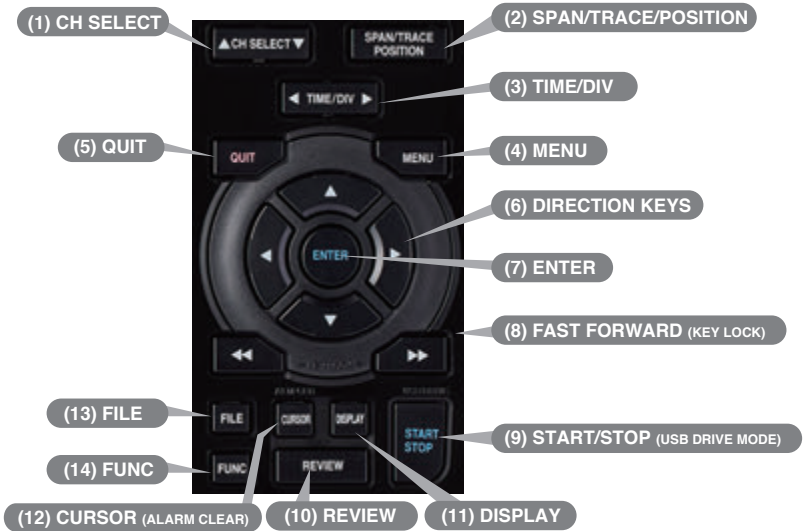

## 1. CH SELECT

Moves CH and item in monitor display.

Use ▲▼ keys of CH SELECT to move up and down.

## 2. SPAN/TRACE/POSITION

Switches the information in the monitor display.

This is used to change the settings related to waveform.

## 3. TIME/DIV

Press this key to change the time axis display width.

## 4. MENU

Press this key to open the setting window. Each time you press the key, the setting window changes as follows.

AMP→DATA→DISP→TRIG→I/F→OTHER

## 5. QUIT

This key is primarily used for the following operations.

To cancel a setting when setting MENU.

To return to the MONITOR screen while the SPAN/TRACE/POSITION key is operated.

To cancel the interface restriction (When the keys are disabled).

To exit the replay display.

## 6. Direction Keys

These keys are primarily used for selecting the item while setting menu and span setting during digital display.

## 7. ENTER

To fix setting items during menu configuration or finalize.

## 8. FAST FORWARD key (KEY LOCK)

This key is primarily used for the following operations.

To move the cursor at high speed during replay.

To change the display order of the files in the file selection tool.

To set key lock (Hold down the left/right FAST FORWARD key for at least two seconds.

Press again to unlock.)

To set a password for cancelling the key lock.

(For the instructions on how to cancel the key lock, refer to the article related to the Key lock in the User's Manual.)

## 9. START/STOP(USB Drive Mode)

In the "USB Drive Mode", check the internal memory and SD card as external storage devices on the PC.

To enter the USB Drive Mode, press down this key from when the power is turned on until the display below appears.

When the display below is displayed, the device is recognized as removable disk and files can be transferred and deleted from the PC.

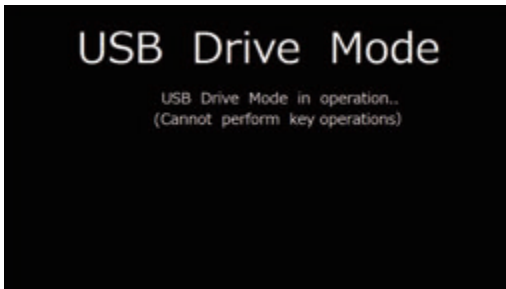



## 10. REVIEW

This key is used to replay captured data.

During Free Running, captured data is replayed.

During capturing, captured data is replayed.

(Data replay Source is displayed on the status display. Press again to return to the capturing data screen.)

To exit the replay display, press the [Quit] key.

## 11. DISPLAY

This key is used to switch the screen mode. Press this key to show the following screen.

When running Free Running

Displays the Y-T waveform + Digital display> All waveform screen> Logging display+Real time statistical calculation screen > XY screen

## 12. CURSOR(ALARM CLEAR)

Press this key during replay to switch between cursors A and B.

When the alarm setting is set to "Hold generated Alarm", the alarm is cleared.

## 13. FILE

This key is used to perform the file-related operations.

## 14. FUNC

Take a shortcut with the key by selecting the frequently used function in advance.

For details of function operation, refer to "3.5 Setting Menus" - "(6) OTHER settings" - "FUNC key settings".

# 15. Key lock release with password

A password can be set to device to cancel the key lock.

(No password is set at factory default.)

<Operation Flow>

## 1. Set the password.

Press the ◀, ▶, and ENTER keys at the same time to display the password setting screen shown below. Specify a four-digit password.



Use the ◀, ▶, △, ▽ keys to select numbers and press the [ENTER] key to fix the password.

In case you forgot your password, please contact us to acquire the master password.

## 2. Set the key lock operation.

Hold down the ◀◀ and ▶▶ keys together for at least two seconds.

## 3. Cancel the key lock.

Hold down the ◀◀ and ▶▶ keys together for at least two seconds.

The password setting screen shown below will be displayed. Set a password.







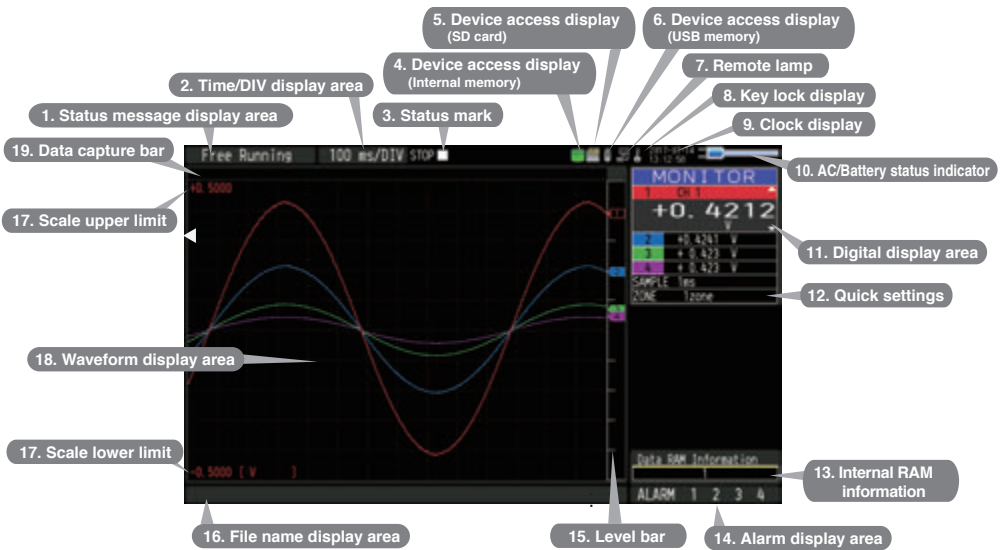

Entering an incorrect password will not unlock the key lock.

Key lock status will be retained when power is turned off.

# Descriptions of the Menu Screens





- 1. **Status message display area** : Displays the operating status.
- 2. **Time/DIV display area** : Displays the current time scale.
- 3. **Status mark** : Displays the status mark.

- STOP**  : Appears when neither capture nor replay is in progress.
- REC**  : Displayed when the captured data is being recorded.
- REC**  : Appears when waiting for a trigger during capturing and for the stop key after capturing.
- PLAY**  : Displayed when replaying the captured data.
- REC**  **PLAY**  : Displayed when replaying during capturing the data (Refer to in "3.2 Key Operation" - "(10) REVIEW").

## CAUTION

Please do not turn Off the power and do not remove the SD card or USB memory when the status mark indicates other than "STOP". The data is damaged, and it will not be accessible.  
Please start the operation after making sure that the status mark is switched to "STOP".

## 4. Device access display (Internal memory)

-  : Internal memory is recognized but is not being accessed.
-  : Internal memory is being accessed. While the internal memory is being accessed, the POWER LED also flashes.

## 5. Device access display (SD card)



: SD card is not attached.



: SD card is attached but not being accessed.



: SD card is accessed. Do not remove SD card. The POWER LED light also flashes while the SD card is being accessed.

### CAUTION

Please do not remove the SD card and do not turn Off this device's power when accessing the SD card. The data is damaged, and it will not be accessible.

## 6. Device access display (USB memory)



: USB memory is not attached.



: USB memory is attached but not being accessed.



: USB memory is accessed. Do not remove USB memory. The POWER LED light also flashes while the USB memory is being accessed.

### CAUTION

Please do not remove the USB memory and do not turn Off the power when accessing the USB memory. The data is damaged, and it will not be accessible.

## 7. Remote lamp



: Indicates local mode. Operations can be conducted on this device.



: Indicates remote mode. With some exceptions, operations must be conducted on a PC.

When you cancel the connection on the application (GL980\_2000-APS), this device automatically returns to local mode. If local mode is not entered, press the [QUIT] key.

## 8. Key lock display



: Not in key lock status. Normal operations are permitted



: Key lock status. All the keys are locked.

For details of the key lock, refer to "3.4 Setting Menus" - "(14)Key lock release with password".

## 9. Clock display

Displays the current date and time.

For details on date and time settings, refer to "3.5 Setting Menus" - "(6) OTHER settings".

## 10. AC/Battery status indicator

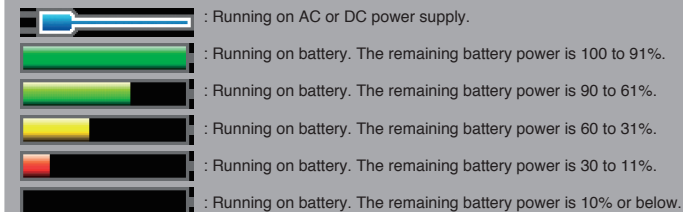

### ! CAUTION

- Data capture automatically stops when the remaining battery power drops to 10% or below during Auto Save will be performed even when Auto Save is not set while data is being captured to the internal RAM.
- The power is automatically turned off when the remaining battery power is 0%.
- Use the remaining battery display only as a reference.  
This indicator does not guarantee the exact operating time of a battery.

## 11. Digital display area

Displays the input value of each channel and span. Use the [SPAN/TRACE/POSITION] keys to switch the display. Use the ▲ ▼ keys to select the channel you want to activate (enlarged display).

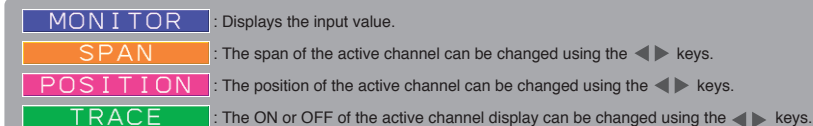

For details, refer to "3.2 Key Operation" - "(2) SPAN/TRACE/POSITION".

As described below, the CH indicating the calculation mark is the channel which calculation between the CHs is enabled (On).

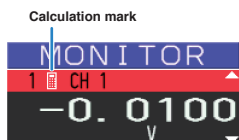

## 12. Quick settings

The settings of the sampling interval and the division of waveform display can be changed. Use the ◀ ▶ keys to activate the Quick setting and the left/right keys to change values.

\* The "SAMPLE" item cannot be changed during data capture.

## 13. Internal RAM information

Displays the status of the internal RAM. The status of the block can be judged by the color of each block. For the number of blocks, set the division number by "memory block division".



#### 14. Alarm display area

Displays the alarm output status.

The number with which an alarm went off is displayed in red. The channel with the alarm threshold has a red input value in the digital display area.

#### 15. Level bar

Displays the each channel signal position, trigger position and alarm range.

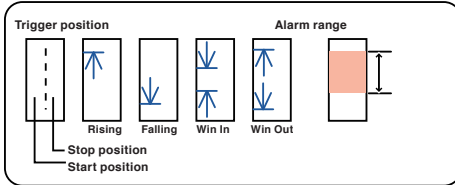

#### 16. File name display area

##### (1) During data capture

A file name is displayed during the recording.

```
<MEM>170711\PREFIX_170711-130955.GBD
```

\* If the ring capturing setting is ON, a file name displayed during capture ends with "\_RINGx" (x represents a number) but the actual file name does not include "\_RINGx".

In the above figure, if the ring capturing is set to ON, the file name during capture will be displayed, for example, as "<MEM>170711\PREFIX\_170711-130955\_RING4.GBD" but the actually created file will be "<MEM>170711\PREFIX\_170711-130955.GBD".

\* For details, refer to "3.5 Setting Menus" - "(2) DATA settings".

##### (2) During data replay

Information on the time axis of the cursor is displayed during Y-T replay.

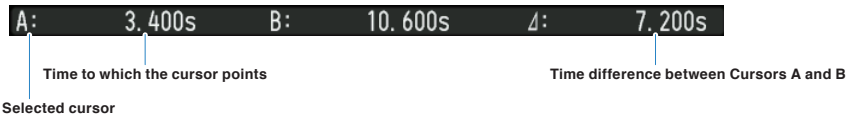

#### 17. Scale upper/lower limit

Displays the scale upper/lower limit of the currently active CH.

#### 18. Waveform display area

Displays the Y-T waveform of the input signal.

(The vertical axis is measured value and the horizontal axis is time.)

#### 19. Data capture bar

##### (1) During data capture

A capture file name is displayed during capture.

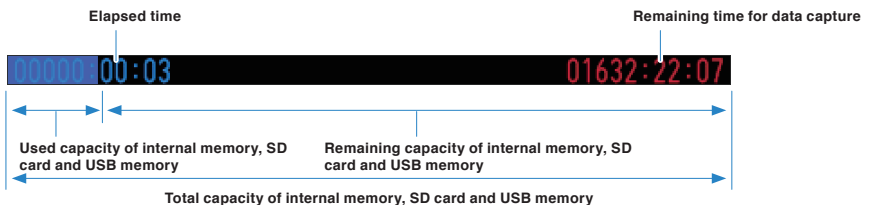

For example, when you are using a 4GB SD card with 100MB already used, the total capacity of the SD card is 4GB with 100MB used space, and the available space of the SD card would be approximately 3.9GB. As the captured time elapses, the usage of the SD card increases and the remaining capacity of the SD card decreases.

The remaining recording time indicates the remaining capacity of the SD card.

However, when the relay capturing function is set to Off, and when the remaining capacity of the SD card exceeds 4GB, the remaining time that can be captured to 1 file will indicate 4GB.

\* Remaining time which is more than 99999 hours is displayed as "++++:++:++".

## (2) During data replay

Displays the display position, cursor position, and trigger position graphically.

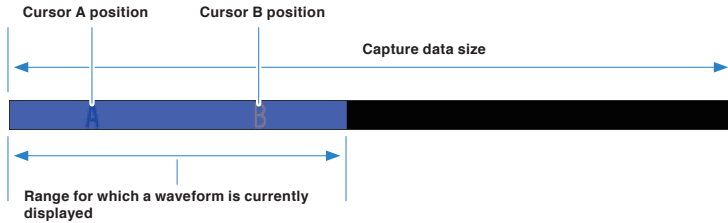

# Measurement Procedure

**This section describes how to make capturing settings and replay captured data.**

The following captured data is explained.

1CH: Sets the temperature environment using the measurement temperature and the type T thermocouple.

2CH: Measures the voltage and fading voltage.

Sampling interval: 1 second

Data storage destination: SD card

## 1. Preparation for measurement

1. Connect the type T thermocouple to the screw terminal of 1CH.
2. Connect the fading voltage to the BNC terminal of 2CH.
3. Turn on the power of the main unit.

## 2. AMP setting



1. Press the [MENU] key

The AMP setting screen will appear.

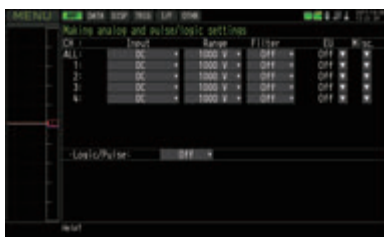

2. Press the direction keys to match the CH1 input setting.

Set to TEMP.

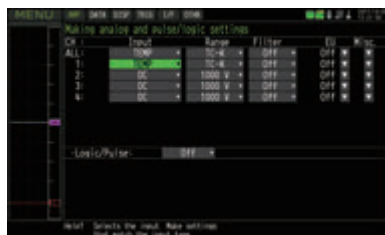

3. Press the direction keys to match the CH1 range setting.

Set to TC-T.

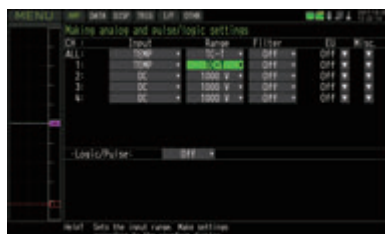

4. Press the direction keys to match the CH1 filter setting.

Set to Line.

(Please set the filter when measuring the temperature.)

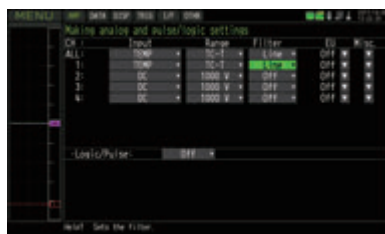



5. For 2CH, set Input to DC, Range to 10V, and Filter to Off.

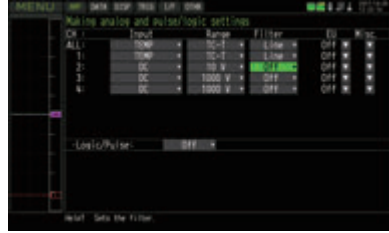

6. Set Input to Off for 3CH to 4CH.

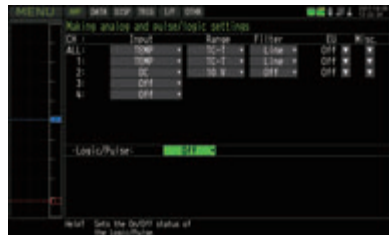

7. When the setting is complete, press the [QUIT] key to finish the AMP setting.



### 3. DATA setting

#### 1. Or press the [MENU] key twice.

Press the MENU key and the direction key to display the DATA setting screen.



#### 2. Set the sampling interval to 1 s.

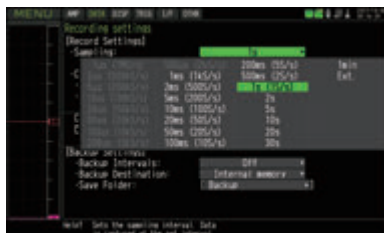

#### 3. Set the capture destination to the SD CARD, and the file name to CSV.

For the file name setting (arbitrary, serial number) refer to the operation manual of the main unit.

If Name Type is set to Auto, the file is created with the name containing the last two digits of the year, the month, and the day. To confirm the setting, press [OK]

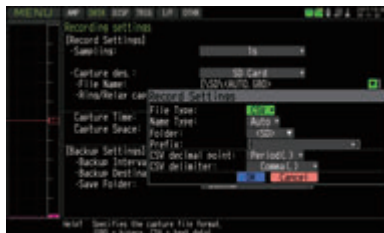

#### 4. When you are done, press the [QUIT] key to finish the DATA setting.



## 4. Recording and stopping



### 1. When the setting is completed, press the [START] key to start recording.

When "Do you want to start recording?" is displayed, recording is started by pressing the [ENTER] key. During recording, the status at the top left of the screen will be displayed.



### 2. Press the [STOP] key again to stop recording.

When "Do you want to stop recording?" is displayed, press the [ENTER] key to stop recording.



## 5. Playback method



1. When recording stops, it automatically switches to recorded data playback.

To check the recorded data value press the direction keys to change the CH and the cursor. Pressing the fast forward key will move the cursor at high speed.

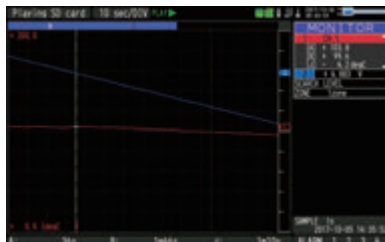

2. If you press the [MENU] key during playback, you can search for playback data and calculate between cursors.



3. To end auto play press the [QUIT] key and follow the onscreen guidance.



4. To recall a file again, press the [REVIEW] key to select the most recently recorded data.



# Specifications

## Standard Specifications

Item	Description	
Number of analog CHs	4CH fixed	
External output terminal	Trigger input (1ch) or external sampling (1ch) Logic input (4ch) or pulse input (4ch) Alarm output (4ch) or trigger output (1ch) + alarm output (3ch)	
PC I/F	Ethernet (10BASE-T/100BASE-TX) USB (compatible with high-speed) standard-included	
Internal memory device	Internal RAM : 4MW/CH Internal memory : Approx. 4GB Flash	
Data backup functions	Setting conditions: EEPROM/Clock: Lithium secondary battery	
Clock accuracy (23°C environment)	Network time setting Off: $\pm 0.002\%$ (monthly difference of approx. 50 seconds) Network time setting On: $\pm 0.01\%$ (day difference about 8.6 seconds) (Maximum error after synchronization)	
Operating environment	0 to 40°C, 5 to 85% RH (15 to 35°C when battery is used)	
Power supply	<ul style="list-style-type: none"> <li>AC adapter : 100 to 240 VAC, 50 to 60 Hz</li> <li>DC input : 8.5 to 24 VDC</li> <li>Battery pack (option) : 7.2 VDC (2900 mAh), two packs can be mounted</li> </ul>	
Power consumption		
• AC power consumption (when using the AC adapter provided as a standard accessory)		
AC100V	Normal	During recharging battery
When the LCD is on	28VA	42VA
When the screen saver is operating	24VA	39VA
AC240V	Normal	During recharging battery
When the LCD is on	39VA	59VA
When the screen saver is operating	34VA	55VA
• DC power consumption		
+24V	Normal	During recharging battery
When the LCD is on	0.50A	0.81A
When the screen saver is operating	0.43A	0.76A
+12V	Normal	During recharging battery
When the LCD is on	1.00A	Recharging not possible
When the screen saver is operating	0.85A	Recharging not possible
+8.5V	Normal	During recharging battery
When the LCD is on	1.46A	Recharging not possible
When the screen saver is operating	1.22A	Recharging not possible
External dimensions (approximate)	260(W)×161(H)×83(D) mm	
Weight (approximate) *1	1.7 kg *1: (AC adapter and battery are not included.)	

# Specification of input section

Item	Description																																																			
Number of input channels	4CH fixed																																																			
Input terminal type	Voltage	Insulated BNC connector or M3.5 screw terminal unit (However, it cannot input to the BNC connector of same CH and the screw terminal at the same time.)																																																		
	Temperature	M3.5 screw type terminals (Rectangular flat washer)																																																		
Input method	All CH insulation, unbalanced input, all CH simultaneous sampling																																																			
Fastest Sampling interval	1 $\mu$ s																																																			
Measurement ranges	Voltage	20 · 50 · 100 · 200 · 500mV · 1 · 2 · 5 · 10 · 20 · 50 · 100V 200 · 500 · 1000V(Max .rated safety voltage:±600VDC), 1-5VF.S.																																																		
	Temperature	Thermocouples : K, J, E, T, R, S, B, N, W (WRε5-26)																																																		
	Humidity	0 to 100% (Voltage 0 to 1V scaling conversion) * B-530 (option) used																																																		
	RMS	10 · 25 · 50 · 100 · 250 · 500mV · 1 · 2.5 · 5 · 10 · 25 · 50VrmsF.S., 100 · 250 · 500 · 1000Vrms(Max .rated safety voltage:±600Vrms) F.S * Crest Factor: in 1000Vrms range, up to 1.4 ,in other range, up to 2 * Measurable frequency: 20 to 10 kHz * The true effective value (RMS) of AC + DC is measured * The function to automatically obtain the effective value (RMS) and the operation cross value from the currently measured value is provided																																																		
Measurement accuracy (23°C ±5°C)	<ul style="list-style-type: none"> <li>• When 30 minutes or more have</li> <li>• GND connected</li> <li>• Vertical placement</li> <li>• Filter Line (Voltage, Temperature)</li> </ul>	<p>● <b>Voltage</b> ±0.25% of F.S.</p> <p>● <b>Thermocouple</b> * Thermocouple diameters T - K: 0.32 <math>\phi</math>, others: 0.65 <math>\phi</math></p> <table border="1"> <thead> <tr> <th>Thermocouple</th> <th>Measurement Temperature Range (°C)</th> <th>Measurement Accuracy</th> </tr> </thead> <tbody> <tr> <td rowspan="4">R/S</td> <td>0 ≤ TS ≤ 100°C</td> <td>±7.0°C</td> </tr> <tr> <td>100 &lt; TS ≤ 300°C</td> <td>±5.0°C</td> </tr> <tr> <td>R : 300 &lt; TS ≤ 1600°C</td> <td>± (0.05% of rdg +3.0°C)</td> </tr> <tr> <td>S : 300 &lt; TS ≤ 1760°C</td> <td>± (0.05% of rdg +3.0°C)</td> </tr> <tr> <td rowspan="2">B</td> <td>400 ≤ TS ≤ 600°C</td> <td>±5.5°C</td> </tr> <tr> <td>600 &lt; TS ≤ 1820°C</td> <td>± (0.05% of rdg +3.0°C)</td> </tr> <tr> <td rowspan="2">K</td> <td>-200 ≤ TS ≤ -100°C</td> <td>± (0.05% of rdg +3.0°C)</td> </tr> <tr> <td>-100 &lt; TS ≤ 1370°C</td> <td>± (0.05% of rdg +2.0°C)</td> </tr> <tr> <td rowspan="2">E</td> <td>-200 ≤ TS ≤ -100°C</td> <td>± (0.05% of rdg +3.0°C)</td> </tr> <tr> <td>-100 &lt; TS ≤ 800°C</td> <td>± (0.05% of rdg +2.0°C)</td> </tr> <tr> <td rowspan="2">T</td> <td>-200 ≤ TS ≤ -100°C</td> <td>± (0.1% of rdg +2.5°C)</td> </tr> <tr> <td>-100 &lt; TS ≤ 400°C</td> <td>± (0.1% of rdg +1.5°C)</td> </tr> <tr> <td rowspan="3">J</td> <td>-200 ≤ TS ≤ -100°C</td> <td>±3.7°C</td> </tr> <tr> <td>-100 &lt; TS ≤ 100°C</td> <td>±2.7°C</td> </tr> <tr> <td>100 &lt; TS ≤ 1100°C</td> <td>± (0.05% of rdg +2.0°C)</td> </tr> <tr> <td rowspan="2">N</td> <td>-200 ≤ TS ≤ 0°C</td> <td>± (0.1% of rdg +3.0°C)</td> </tr> <tr> <td>0 ≤ TS ≤ 1300°C</td> <td>± (0.1% of rdg +2.0°C)</td> </tr> <tr> <td>W</td> <td>0 ≤ TS ≤ 2315°C</td> <td>± (0.1% of rdg +2.5°C)</td> </tr> <tr> <td colspan="2">Reference contact compensation accuracy</td> <td>±1.0°C</td> </tr> </tbody> </table> <p>● <b>RMS(Average)</b> ±1.5% of F.S. (Sine wave, 20 to 10 kHz)</p>	Thermocouple	Measurement Temperature Range (°C)	Measurement Accuracy	R/S	0 ≤ TS ≤ 100°C	±7.0°C	100 < TS ≤ 300°C	±5.0°C	R : 300 < TS ≤ 1600°C	± (0.05% of rdg +3.0°C)	S : 300 < TS ≤ 1760°C	± (0.05% of rdg +3.0°C)	B	400 ≤ TS ≤ 600°C	±5.5°C	600 < TS ≤ 1820°C	± (0.05% of rdg +3.0°C)	K	-200 ≤ TS ≤ -100°C	± (0.05% of rdg +3.0°C)	-100 < TS ≤ 1370°C	± (0.05% of rdg +2.0°C)	E	-200 ≤ TS ≤ -100°C	± (0.05% of rdg +3.0°C)	-100 < TS ≤ 800°C	± (0.05% of rdg +2.0°C)	T	-200 ≤ TS ≤ -100°C	± (0.1% of rdg +2.5°C)	-100 < TS ≤ 400°C	± (0.1% of rdg +1.5°C)	J	-200 ≤ TS ≤ -100°C	±3.7°C	-100 < TS ≤ 100°C	±2.7°C	100 < TS ≤ 1100°C	± (0.05% of rdg +2.0°C)	N	-200 ≤ TS ≤ 0°C	± (0.1% of rdg +3.0°C)	0 ≤ TS ≤ 1300°C	± (0.1% of rdg +2.0°C)	W	0 ≤ TS ≤ 2315°C	± (0.1% of rdg +2.5°C)	Reference contact compensation accuracy		±1.0°C
	Thermocouple	Measurement Temperature Range (°C)	Measurement Accuracy																																																	
R/S	0 ≤ TS ≤ 100°C	±7.0°C																																																		
	100 < TS ≤ 300°C	±5.0°C																																																		
	R : 300 < TS ≤ 1600°C	± (0.05% of rdg +3.0°C)																																																		
	S : 300 < TS ≤ 1760°C	± (0.05% of rdg +3.0°C)																																																		
B	400 ≤ TS ≤ 600°C	±5.5°C																																																		
	600 < TS ≤ 1820°C	± (0.05% of rdg +3.0°C)																																																		
K	-200 ≤ TS ≤ -100°C	± (0.05% of rdg +3.0°C)																																																		
	-100 < TS ≤ 1370°C	± (0.05% of rdg +2.0°C)																																																		
E	-200 ≤ TS ≤ -100°C	± (0.05% of rdg +3.0°C)																																																		
	-100 < TS ≤ 800°C	± (0.05% of rdg +2.0°C)																																																		
T	-200 ≤ TS ≤ -100°C	± (0.1% of rdg +2.5°C)																																																		
	-100 < TS ≤ 400°C	± (0.1% of rdg +1.5°C)																																																		
J	-200 ≤ TS ≤ -100°C	±3.7°C																																																		
	-100 < TS ≤ 100°C	±2.7°C																																																		
	100 < TS ≤ 1100°C	± (0.05% of rdg +2.0°C)																																																		
N	-200 ≤ TS ≤ 0°C	± (0.1% of rdg +3.0°C)																																																		
	0 ≤ TS ≤ 1300°C	± (0.1% of rdg +2.0°C)																																																		
W	0 ≤ TS ≤ 2315°C	± (0.1% of rdg +2.5°C)																																																		
Reference contact compensation accuracy		±1.0°C																																																		
Reference contact compensation accuracy	Internal/External switching																																																			
Burnout detection	Detectable in dedicated mode (Not detectable during capturing)																																																			
A/D converter	16-bit (Effective resolution: Approx. 1/40000 of the +/- range)																																																			
Temperature coefficient	Gain : 0.01% of F.S./°C																																																			
	Zero : 0.02% of F.S./°C																																																			
Input resistance	1M $\Omega$ ±5%																																																			
Allowable signal source rWithin 1 k $\Omega$	Within 1 k $\Omega$																																																			
Maximum permissible input voltage	Between each input (+) terminal and each input (-) terminal: 20 mV to 2 V AC/DC 30V, 5V to 1000V AC/DC 600V																																																			
	Between each input terminal and each input terminal: AC/DC 600V (CATIII) / AC/DC 300V (CAT IV) Between each input terminal and GND terminal: AC/DC 600V (CATIII) / AC/DC 300V (CAT IV) *Expected transient overvoltages 6000V																																																			
Withstand voltage	Between each input terminal and each input terminal:AC/DC 5400V 1 minute Between each input terminal and GND terminal: AC/DC 5400V 1 minute																																																			
Insulation resistance	Between Input Ch and GND terminal: 50M $\Omega$ or more (At 500 VDC)																																																			
Common mode rejection ratio	90 dB or more (50/60 Hz; signal source 300 $\Omega$ or less)																																																			
S/N (Noise)	20 mV range: -40 dB or more (at +/- short)																																																			
	Other range: -50 dB or more (at +/- short)																																																			
Frequency response	DC to 200 kHz (+1/-4 dB)																																																			
Filter	OFF, Line, 5 Hz, 50 Hz, 500 Hz, 5 kHz, 50 kHz Attenuation -3 dB/Cutoff frequency Slope 6 dB/oct																																																			

## Specification of input/Output section

Item	Description
Input/output types	<p>Trigger input (1 ch) or External sampling input (1 ch)            Logic input (4 ch) or Pulse input (4 ch)            Alarm output (4ch), or Trigger output (1ch) + Alarm output (3ch)            * Trigger input and external sampling input can be switched.            * Alarm output and trigger output can be switched.</p>
Input specifications	<p>Maximum input voltage : 0 to +30V (single-ended ground input)            Input threshold voltage : Approx. +2.5V (logic input, pulse input)            Approx. +1.9V (external trigger, external sampling)            Hysteresis : Approx. 0.5V (+2.5V to +3.0V) (Logic input, pulse input)            Approx. 0.2V (+1.9V to +2.1V) (external trigger, external sampling)</p>
Alarm output specifications	<p>Output format: Open collector output (5 V, pull-up resistance 10 k<math>\Omega</math>)            Contact capacity 5V to 24V, 100mA or less (0.2W or less)            Output conditions: Level judgment, window judgment, logic pattern judgment, pulse judgment</p>
Trigger output	<p>When a trigger is detected after trigger output is set, a pulse of approx. 500 <math>\mu</math>s width is output from the Output 1 terminal. (Low active)</p>
Pulse input	<p>Pulse sampling interval: 10 <math>\mu</math>s to 1h            * Set it separately from sampling interval.            Setting faster than sampling interval is not possible (constant multiple)</p> <p>Revolutions mode (engines, etc.)            Function: Mode to convert to the number of revolutions per minute by applying magnification after counting the number of pulses for each pulse sampling interval.            Span: 10 to 500M</p> <p>Counts mode (electric meters, etc.)            Function: Mode to accumulate the number of pulses for each pulse sampling interval from the start of measurement            Span: Automatic (Maximum 20M)</p> <p>Inst. mode            Function: Mode to display the number of pulses for each pulse sampling interval.            The accumulated value for each pulse sampling interval is reset.            Span: 10 to 20M</p> <p>Maximum number of pulse inputs            Maximum input frequency : 100 kHz            Maximum number of count : 15 MC (24-bit counter)</p>
External sampling input	<p>Maximum input frequency: 100 kHz            Temporal error: 1 <math>\mu</math>s or less.</p>

## Installation Guide

For the install procedure of the GL2000 application software refer to the "Application Software Manual" included in the attached CD-ROM.

# GRAPHTEC

Specifications are subject to change without notice.

GL2000 Quick Start Guide  
(GL2000-UM-851)

November 1, 2017  
1st edition-01

**Publisher GRAPHTEC CORPORATION**