

# Spectrum Analyzer

GSP-9300B

---

## QUICK START GUIDE



ISO-9001 CERTIFIED MANUFACTURER

**GW INSTEK**

This manual contains proprietary information, which is protected by copyright. All rights are reserved. No part of this manual may be photocopied, reproduced or translated to another language without prior written consent of Good Will company.

The information in this manual was correct at the time of printing. However, Good Will continues to improve products and reserves the rights to change specification, equipment, and maintenance procedures at any time without notice.

**Good Will Instrument Co., Ltd.**  
**No. 7-1, Jhongsing Rd., Tucheng Dist., New Taipei City 236, Taiwan.**

# Table of Contents

<b>SAFETY INSTRUCTIONS .....</b>	<b>2</b>
<b>GETTING STARTED.....</b>	<b>7</b>
GSP-9300B Introduction .....	9
Accessories.....	12
Appearance.....	14
First Use Instructions .....	26
<b>BASIC OPERATION .....</b>	<b>38</b>
Viewing a Signal .....	38
Using the Marker Function .....	40
Interface Configuration.....	42
<b>APPENDIX.....</b>	<b>48</b>
Replace the Clock Battery.....	48
GSP-9300B Specifications .....	49
GSP-9300B Dimensions .....	57
Declaration of Conformity.....	58

# S SAFETY INSTRUCTIONS

This chapter contains important safety instructions that you must follow during operation and storage. Read the following before any operation to ensure your safety and to keep the instrument in the best possible condition.

## Safety Symbols

These safety symbols may appear in this manual or on the instrument.

---



Warning: Identifies conditions or practices that could result in injury or loss of life.



Caution: Identifies conditions or practices that could result in damage to the instrument or to other properties.



**DANGER High Voltage**



Attention Refer to the Manual



Earth (ground) Terminal



Frame or Chassis Terminal



Do not dispose electronic equipment as unsorted municipal waste. Please use a separate collection facility or contact the supplier from which this instrument was purchased.

---

## Safety Guidelines

---

### General Guideline



#### CAUTION

- \* Do not place any heavy object on the instrument.
- \* Avoid severe impact or rough handling that leads to damaging the instrument.
- \* Do not discharge static electricity to the instrument.
- \* Use only mating connectors, not bare wires, for the terminals.
- \* Ensure signals to the RF input do not exceed +30dBm.
- \* Ensure reverse power to the TG output terminal does not exceed +30dBm.
- \* Do not supply any input signals to the TG output.
- \* Do not block the cooling fan opening.
- \* Do not disassemble the instrument unless you are qualified.

(Measurement categories) EN 61010-1:2010 specifies the measurement categories and their requirements as follows. The instrument falls under category II.

- \* Measurement category IV is for measurement performed at the source of low-voltage installation.
- \* Measurement category III is for measurement performed in the building installation.
- \* Measurement category II is for measurement performed on the circuits directly connected to the low voltage installation.
- \* Measurement category I is for measurements performed on circuits not directly connected to Mains.

---

### Power Supply



#### WARNING

- \* AC Input voltage range: 100V~240V
  - \* Frequency: 50/60Hz
  - \* To avoid electrical shock connect the protective grounding conductor of the AC power cord to an earth ground.
-

- Battery
- \* Rating: 11.1V, 6 cell Li-ion battery
-  **CAUTION**
- \* Turn off the power and remove the power cord before installing or removing the battery.

- Cleaning
- \* Disconnect the power cord before cleaning.
  - \* Use a soft cloth dampened in a solution of mild detergent and water. Do not spray any liquid.
  - \* Do not use chemicals containing harsh material such as benzene, toluene, xylene, and acetone.

- Operation Environment
- \* Location: Indoor, no direct sunlight, dust free, almost non-conductive pollution (Note below)
  - \* Temperature: 5°C to 45°C
  - \* Humidity: <90%
- (Pollution Degree) EN 61010-1:2010 specifies the pollution degrees and their requirements as follows. The instrument falls under degree 2.
- Pollution refers to “addition of foreign matter, solid, liquid, or gaseous (ionized gases), that may produce a reduction of dielectric strength or surface resistivity”.
- \* Pollution degree 1: No pollution or only dry, non-conductive pollution occurs. The pollution has no influence.
  - \* Pollution degree 2: Normally only non-conductive pollution occurs. Occasionally, however, a temporary conductivity caused by condensation must be expected.
  - \* Pollution degree 3: Conductive pollution occurs, or dry, non-conductive pollution occurs which becomes conductive due to condensation which is expected. In such conditions, equipment is normally protected against exposure to direct sunlight, precipitation, and full wind pressure, but neither temperature nor humidity is controlled.

- Storage environment
- \* Location: Indoor
  - \* Temperature: -20°C to 70°C
  - \* Humidity: <90%

**Disposal**

Do not dispose this instrument as unsorted municipal waste. Please use a separate collection facility or contact the supplier from which this instrument was purchased. Please make sure discarded electrical waste is properly recycled to reduce environmental impact.

## Power cord for the United Kingdom

When using the instrument in the United Kingdom, make sure the power cord meets the following safety instructions.

NOTE: This lead/appliance must only be wired by competent persons



**WARNING: THIS APPLIANCE MUST BE EARTHED**

IMPORTANT: The wires in this lead are coloured in accordance with the following code:

Green/ Yellow:	Earth
Blue:	Neutral
Brown:	Live (Phase)



As the colours of the wires in main leads may not correspond with the coloured marking identified in your plug/appliance, proceed as follows:

The wire which is coloured Green & Yellow must be connected to the Earth terminal marked with either the letter E, the earth symbol  $\oplus$  or coloured Green/Green & Yellow.

The wire which is coloured Blue must be connected to the terminal which is marked with the letter N or coloured Blue or Black.

The wire which is coloured Brown must be connected to the terminal marked with the letter L or P or coloured Brown or Red.

If in doubt, consult the instructions provided with the equipment or contact the supplier.

This cable/appliance should be protected by a suitably rated and approved HBC mains fuse: refer to the rating information on the equipment and/or user instructions for details. As a guide, a cable of 0.75mm<sup>2</sup> should be protected by a 3A or 5A fuse. Larger conductors would normally require 13A types, depending on the connection method used.

Any exposed wiring from a cable, plug or connection that is engaged in a live socket is extremely hazardous. If a cable or plug is deemed hazardous, turn off the mains power and remove the cable, any fuses and fuse assemblies. All hazardous wiring must be immediately destroyed and replaced in accordance to the above standard.



# G E T T I N G   S T A R T E D

This chapter provides a brief overview of the GSP-9300B, the package contents, instructions for first time use and an introduction to the front panel, rear panel and GUI.



<b>GSP-9300B Introduction</b> .....	<b>9</b>
Main Features.....	9
<b>Accessories</b> .....	<b>12</b>
<b>Appearance</b> .....	<b>14</b>
GSP-9300B Front Panel .....	14
Rear Panel.....	19
Display .....	21
Status Icon Overview .....	24
<b>First Use Instructions</b> .....	<b>26</b>

Tilting the Stand .....	26
Inserting the Battery Pack.....	27
Power UP.....	28
Power Down .....	29
Setting the Date, Time and Wake-Up Clock .....	30
Firmware Update.....	32
Restoring Default Settings .....	33
Conventions .....	34

## GSP-9300B Introduction

The GSP-9300B builds on the strong feature set of the GSP-9330 and significantly increases performance in almost every aspect; making this the most comprehensive and feature-rich spectrum analyzer GW Instek has released.

Like the GSP-9330, the GSP-9300B features a split window display to view data in spectrum, topographic or spectrographic views. There are also a number of additional test functions such as P1DB. Lastly, the GSP-9300B significantly reduces the sweep time and RBW filter step resolution and complexity.

### Main Features

---

Performance	<ul style="list-style-type: none"><li>* 9kHz~3GHz bandwidth</li><li>* 1Hz resolution</li><li>* Nominal RBW accuracy of <math>\pm 5\%</math> &lt;1MHz, <math>\pm 8\%</math> =1MHz</li><li>* Video bandwidth 1Hz~1MHz (1-3-10 steps)</li><li>* Amplitude measurement range: DANL~30dBm (frequency dependent)</li><li>* Input attenuation: 0 ~ 50dB, 1dB steps</li><li>* Phase noise: &lt; -88dBc/Hz@1GHz, 10kHz, typical</li></ul>
-------------	--

---

Features	<ul style="list-style-type: none"><li>* 1-3-10 step increments for RBW bandwidth</li><li>* Three display modes: Spectrum, Topographic and Spectrographic</li><li>* Split window display</li><li>* Built-in EMI filter</li><li>* Auto Wake-up</li><li>* Built-in preamplifier</li><li>* Gate sweep</li></ul>
----------	---

---

- \* Marker Frequency counter
  - \* Two operating modes: Spectrum and Power Meter mode
  - \* SEM measurement
  - \* ACPR measurement
  - \* OCBW measurement
  - \* Phase jitter measurement
  - \* Harmonics measurement
  - \* P1dB measurement
  - \* Channel power measurement
  - \* Demodulation analyzer
  - \* Diverse marker functions and features with Peak Table
  - \* Sequence function to automatically perform pre-programmed sequential operations
  - \* Optional battery operation
-

- Interface
- \* 8.4 color LCD (800×600)
  - \* On-screen menu icons
  - \* DVI-I video output
  - \* RS-232 with RTS/CTS hardware flow control
  - \* USB 2.0 with support for USB TMC
  - \* LAN TCP/IP with LXI support
  - \* Optional GPIB/IEEE488 interface
  - \* Optional 3G USB adapter for WLAN
  - \* Optional power meter adapter
  - \* IF output @ 886MHz
  - \* Headphone output
  - \* REF (reference clock) input/output BNC ports
  - \* Alarm/Open collector output BNC port
  - \* Trigger/Gate input BNC ports
  - \* RF N-type input port
  - \* Tracking generator output
  - \* DC +7V/500mA output SMB port

## Accessories

Standard Accessories	Part number	Description
	Region dependant	Power cord
	N/A	User manual CD: Includes: User manual, Programming manual, SpectrumShot quick start guide, SpectrumShot software, IVI driver
	N/A	Quick start guide
	N/A	Certificate of calibration
	Region dependant	Power cord
Options	Option number	Description
	Opt1.	Tracking generator
	Opt2.	Battery (11.1V/5200mAH Li-ion battery)
	Opt3.	GPIB interface (IEEE 488 bus)
Optional Accessories	Part number	Description
	ADB-002	DC block BNC 50R 10MHz-2.2GHz
	ADB-006	DC BLOCK N TYPE 50R 10MHz-6GHz
	ADB-008	DC BLOCK SMA 50R 0.1MHz-8GHz
	GSC-009	Soft Carrying Case
	GRA-415	6U Rack mount kit

**Software Downloads**

PC Software for Windows System (SpectrumShot quick start guide, SpectrumShot software)



IVI Driver Supports LabView & LabWindows/CVI Programming

# Appearance

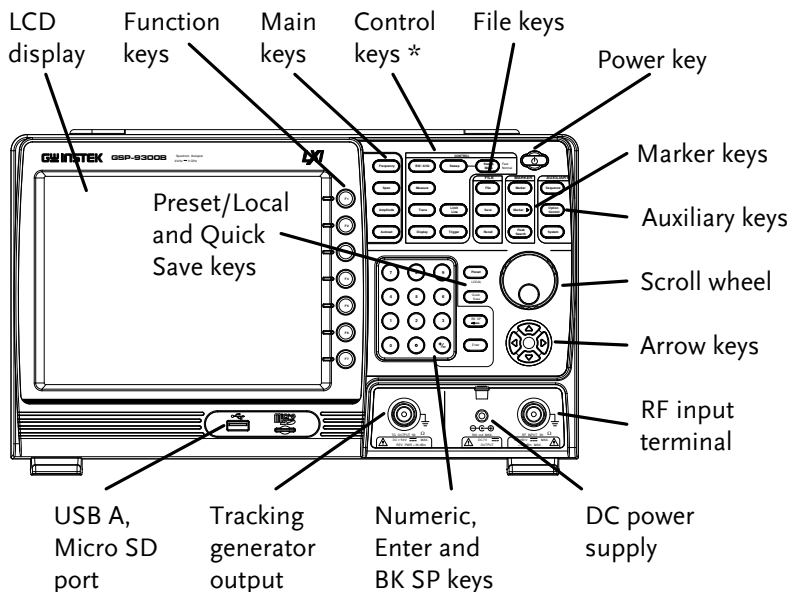
## GSP-9300B Front Panel



**LCD display**      800×600 color LCD display. The display shows the soft keys for the current function, frequency, amplitude and marker information.



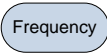



**Function keys**       ~  The F1 to F7 function keys directly correspond to the soft keys on the right-hand side of display.

**Main keys**       Sets the center frequency, start frequency, stop frequency, center frequency step and frequency offset values.

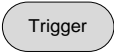
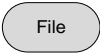

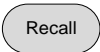
	Span	Sets the span, with options for full span, zero span and last span.
	Amplitude	Sets the amplitude reference level, attenuation, pre-amplifier controls, scale and other options for attenuation and scale.
	Autoset	Automatically searches the peak signal with maximum amplitude and displays it with appropriate horizontal and vertical scales.
<hr/>		
Control keys	BW/Avg	Sets the resolution bandwidth, video bandwidth, average type and turns the EMI filter on/off.
	Sweep	Sets the sweep time and gate time.
	Sweep Mode	Toggles the Sweep Control between <i>Fast</i> and <i>Normal</i> mode.
	Measure	Accesses measurement options such as ACPR, OCBW, demodulation measurements, SEM, TOI, phase jitter and other advanced measurements.
	Trace	Sets traces and trace related functions.
	Limit Line	Sets and tests Pass/Fail limit lines.
	Display	The Display key configures the windowing mode and basic display properties.

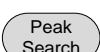
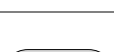
---

		Sets the triggering modes.
File		File utilities options
		Save the trace, state etc., and save options.
		Recall the trace, state etc., and recall options.
Marker		Turns the Markers on/off and configures the markers.
		The <i>Marker</i> ► key positions the markers on the trace.
		Finds each maximum and minimum peak. Used with the Marker function.
Auxiliary		Access, set and edit program sequences.
		The <i>Option Control</i> key allows you to setup optional accessories such as the Tracking Generator, Power Meter or Demo Kit.
		The System key shows system information, settings and other system related functions.

---

Preset / Local key



The *Preset* key will restore the spectrum analyzer to the Factory or User Preset settings.

The Preset key will also return the instrument back to local control after it has been in remote control mode.



The Quick Save utility allows you to save either the state, trace, display screen, limit line, correction or sequence with only a single press.

Power key

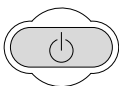

Turns the instrument on/off. On = yellow, off = blue.

Scroll wheel

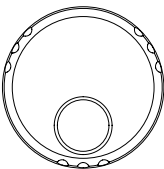

Edit values, select listed items.

Arrow keys

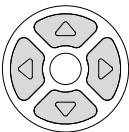

Increment/decrement values (in steps), select listed items.

RF input terminal

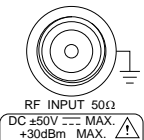

RF input port. Accepts RF inputs.

- \* Maximum input: +30dBm
- \* Input impedance: 50Ω
- \* Maximum DC voltage: ±50V
- \* N-type: female

DC power supply

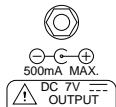

SMB port supplies power for optional accessories.

- \* DC +7V
- \* 500mA Max.

Numeric keypad

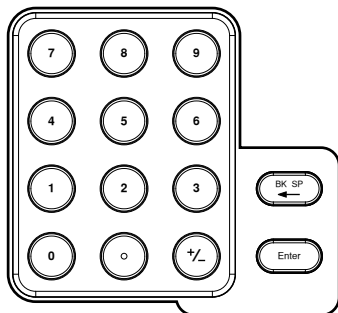

The numeric keypad is used to enter values and parameters. It is often used in conjunction with the arrow keys and scroll wheel.

TG output port

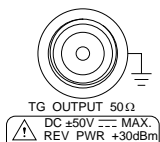

The Tracking Generator (TG) output source.

- \* N-type: female
- \* Input impedance: 50Ω
- \* Output power: -50dBm to 0dBm
- \* Maximum reversed power: +30dBm

USB A, Micro SD



USB A port, Micro SD port for saving/recalling settings/files.

Rear Panel

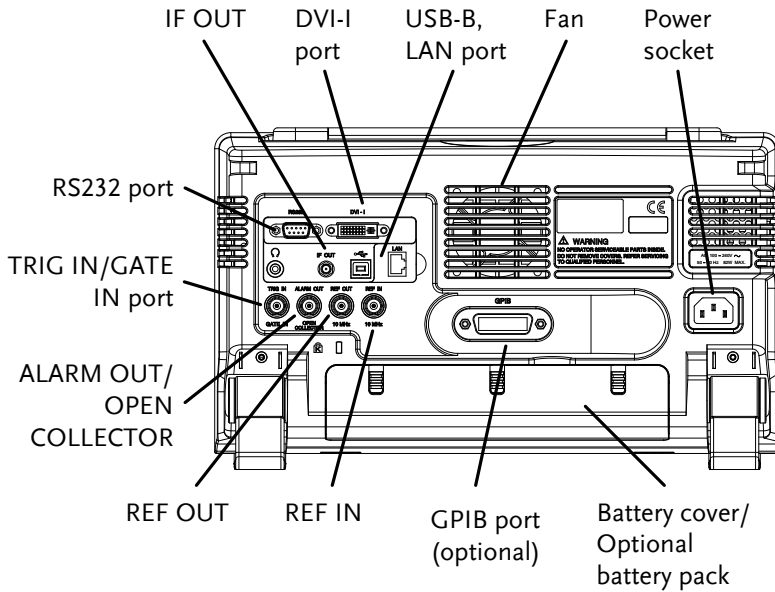

RS232

RS232

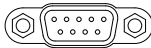

RS232 9 pin DSUB port.

IF OUT

IF OUT



SMA IF Out port.

DVI-I

DVI - I

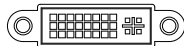

DVI video out port. Supports SVGA (800X600) @ 60Hz.

Fan

Power Socket

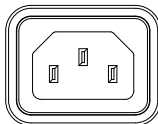

Power Socket:  
100~240V, 50/60Hz.

Battery pack

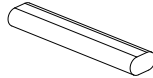

Voltage: 11.1V  
Capacity: 5200mAH

REF IN

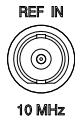

BNC female reference input.

REF OUT

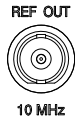

BNC female reference output:  
10MHz, 50Ω impedance

Security Lock



ALARM OUT



BNC female open collector Alarm output.

TRIG IN/GATE IN

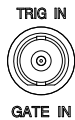

BNC female 3.3V CMOS trigger input/gated sweep input.

Phone



3.5mm stereo headphone jack  
(wired for mono operation)

USB B



USB B Device port. USB 1.1/2.0

LAN







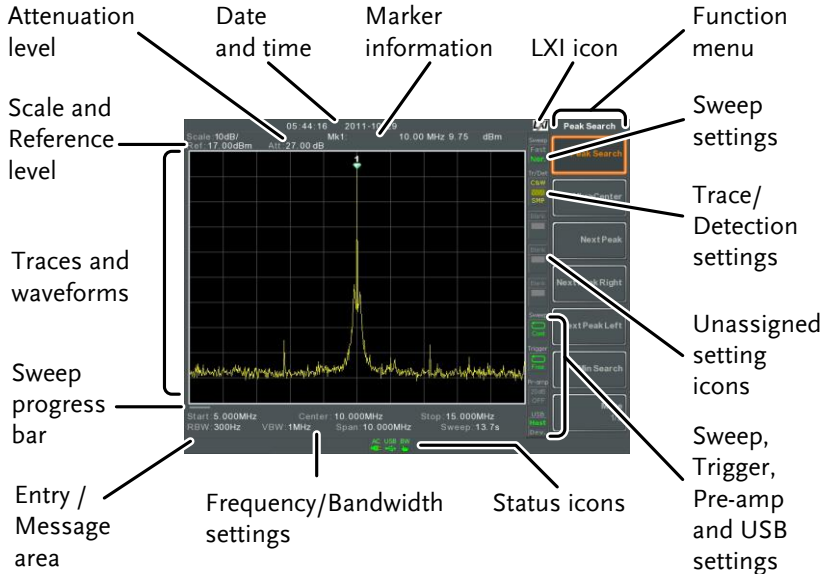

RJ-45 10Base-T/100Base-Tx

Display













- Scale                      Displays the vertical scale of the vertical grid.
- Reference level        Displays the reference level.
- Attenuation             Displays the vertical scale (attenuation) of the input signal.
- Date/Time              Displays the date and time.
- Marker information     Displays marker information.
- LXI icon                 This icon indicates the status of the LXI connection.
- Function menu         Soft menu keys associated with the F1 to F7 function keys to the right of the display.











Sweep Mode		This icon displays the sweep mode, as set by the Sweep Mode key.
Sweep settings		Sweep icon that shows the sweep status.
Trace and detection settings		Trace icon that shows the trace type and the detection mode used for each trace.
Blank		Unassigned setting icons.
Trigger settings		Trigger icon that shows the trigger status.
Pre-amp settings		Pre-amplifier icon that shows the Pre-amplifier status.
USB settings		Displays the status of the USB A port.
Status Icons	Displays the interface status, power source status and alarm status, etc. See the Status Icon Overview on page 24 for a list of the status icons.	
Frequency/ Bandwidth settings	Displays the Start, Center and Stop frequencies, RBW, VBW, Span and Sweep settings.	
Entry/Message area	This area is used to show system messages, errors and input values/parameters.	
Trace and waveforms	Main display showing the input signals, traces, limit lines and marker positions.	



Sweep progress bar    The sweep progress bar shows the progress of slow sweeps (greater than 2 seconds).

## Status Icon Overview

3G Adapter		Indicates that the 3G adapter is installed and turned on.
Demo Kit		Indicates that the demo kit is installed and turned on.
PreAmp		Indicates that the pre amplifier is on.
AC		Shown when running on AC power.
AC Charge		Shown when the AC power is charging the battery.
Alarm Off		Alarm buzzer output is currently off.
Alarm On		Alarm buzzer output is currently on.
Amplitude Offset		Indicates that the amplitude-shift is active. This icon appears when amplitude-related functions are used: Reference level offset Amplitude Correction Input Z = 75Ω and Input Z cal >0
Battery indicator		Indicates the battery charge.
Bandwidth Indicator		Indicates that the RBW or VBW settings are in manual mode.

Average		Indicates that the Average function is active.
External Lock		Indicates that the system is now locked and refers to the external reference input signal
External Trigger		External trigger signal is being used.
Math		Trace math is being used.
Sequence Indicator		Shown when a sequence is running.
Sweep Indicator		Indicates that the sweep time is manually set.
Tracking generator		Indicates that the tracking generator is turned on.
TG Normalization		Indicates that the tracking generator has been normalized.
Wake-up clock		Indicates that the wake-up clock is turned on.
USB		Indicates that a USB flash drive is inserted into the front panel and is recognized.
Micro SD		Indicates that a micro SD card is inserted into the front panel and is recognized.

## First Use Instructions

Use the procedures below when first using the GSP-9300B to tilt the stand, insert the battery pack, power up the instrument, set the internal clock, set the wake-up clock, update the firmware and to restore the default settings. Lastly, the Conventions sections will introduce you to the basic operating conventions used throughout the user manual.

### Tilting the Stand

**Description** The GSP-9300B has two adjustable rubber feet that can be used to position the instrument into two preset orientations.

**Upright Position** Tuck the feet under the bottom of the instrument to stand the instrument upright.

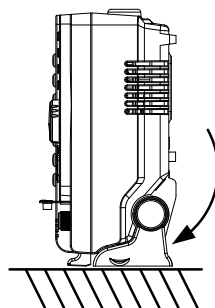

**Leaning Position** Pull the feet back to have the instrument leaning back.

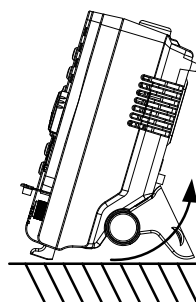

## Inserting the Battery Pack

---

**Description** The GSP-9300B has an optional battery pack. The battery should be inserted before power is connected to the AC power socket and before the unit is turned on.

- Steps**
1. Ensure the power is off and the AC power is disconnected.
  2. Remove the battery cover.
  3. Insert the battery as shown in the diagram below.
  4. Replace the battery cover.

**Display Icon**



The battery icon is displayed when GSP-9300B is running on battery power.

**Insertion Diagram**

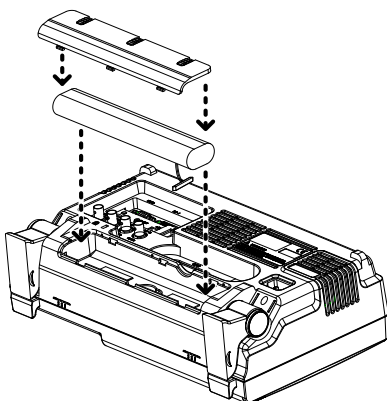

## Power UP

---

### Steps

1. Insert the AC power cord into the power socket.
2. The power button exterior will be lit blue to indicate that the GSP-9300B is in standby mode.

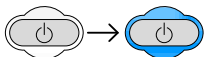

3. Press the power button for a few seconds to turn the GSP-9300B on.
4. The power button will turn orange and the GSP-9300B will start to boot up.

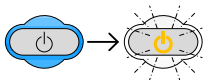

Note

It takes a little less than 1 minute for the GSP-9300B to fully startup.

## Power Down

---

Description	<p>The GSP-9300B has two methods to power down: Normal and Forced Power Down.</p> <p>The normal power down method will save the system state and end any running processes. The state is saved for the next time the instrument is turned back on.</p> <p>The forced power down method only does a minimum state save.</p>
-------------	--

---

Normal Power Down	<p>Press the power button. The system will automatically handle the power down procedure in the following order:</p> <ul style="list-style-type: none"><li>* The system state is saved.</li><li>* Outstanding processes are closed in sequence.</li><li>* The LCD backlight is turned off.</li><li>* The system enters standby mode (the power key changes from orange to blue).</li></ul>
-------------------	--



Note

The process takes ~10 seconds.

---

Forced Power Down	<p>Press and hold the power button for ~4 seconds until the system turns off and the power button turns blue.</p>
-------------------	---



Note

The forced power down mode might cause the GSP-9300B to perform a longer system check the next time it is powered up.

## Setting the Date, Time and Wake-Up Clock

---

**Description** The GSP-9300B can be setup to power-up automatically using the Wakeup Clock function. This feature is useful to wake-up the instrument early and eliminate settling time.

---

**System Date** Example: Set the System Date to July 1, 2016

1. Press  > *Date/Time*[F4] > *Set Date*[F1] > *Year*[F1].
  2. Press *2016* > *Enter*[F1].
  3. Press *Month*[F2] > *7* > *Enter*[F1].
  4. Press *Day*[F3] > *1* > *Enter*[F1].
  5. Press *Return*[F7].
- 



**Note**

The System Date will be shown at the top of the display.

---

**System Time** Example: Set the System Time to 9.00 AM

1. Press  > *Date/Time*[F4] > *Set Time*[F2] > *Hour*[F1].
2. Press *9* > *Enter*[F1].
3. Press *Minute*[F2] > *0* > *Enter*[F1].
4. Press *Second*[F3] > *0* > *Enter*[F1].
5. Press *Return*[F7].





Note

The System Time will be shown at the top of the display.

---

System Wake-Up  
Clock

Example: Set the GSP-9300B to wake up at 9.00 AM

1. Press  > *Date/Time*[F4] > *Wake-Up Clock*[F3] > *Select Clock*[F1].
  2. Press *Clock 1*[F1] ~ *Clock 7*[F7] to choose a clock (1 ~ 7).
  3. Press *State*[F2] to turn the wake up clock on/off.
  4. Press *Hour*[F3] > 9 > *Enter*[F1].
  5. Press *Minute*[F4] > 0 > *Enter*[F1].
  6. Press [F5] and choose *Rept.* (Repeat) or *Single*.
  7. Press *Select Date*[F6] and select a day.
  8. Press *Return*[F7] to save the Wake-Up Clock settings.
- 



Note

The system time is kept with the CR2032 clock battery. If the system time/ wake up clock can no longer be set, please replace the clock battery. See page 48.

## Firmware Update

**Description** The GSP-9300B allows the firmware to be updated by end-users. Before using the GSP-9300B, please check the GW Instek website or ask your local distributor for the latest firmware.

**System version** Before updating the firmware, please check the firmware version.

1. Press **(System)** > *System Information* [F1].
2. The firmware will be listed on the display.



3. Press any other main/control/file/marker /auxiliary key to exit out of the System Information screen.
4. To upgrade the firmware, insert the new firmware onto a USB flash drive or Micro SD card and put the drive/card into the appropriate front panel port. The firmware files should be located in a directory named "gsp932".

5. Press  > More 1/2[F7] > Upgrade[F2].
6. The spectrum analyzer will automatically find the firmware on the USB flash drive and start to update the firmware. When finished, the message “Upgrade is finished” will be shown at the bottom of the screen followed by “Rebooting”.



7. The system will automatically restart after the rebooting message.



The upgrade process may take a few minutes.

## Restoring Default Settings

**Description** The factory default settings or user presets can be easily restored using the Preset key on the front panel. By default, the factory default settings are restored with the Preset key.

- Steps**
1. Press .
  2. The spectrum analyzer will load the preset settings.

## Conventions

The following conventions are used throughout the user manual. Read the conventions below for a basic grasp of how to operate the GSP-9300B menu system and front panel keys.

**Soft Menu keys** The F1 to F7 function keys on the right side of the display correspond directly to the soft-menu keys on their left.

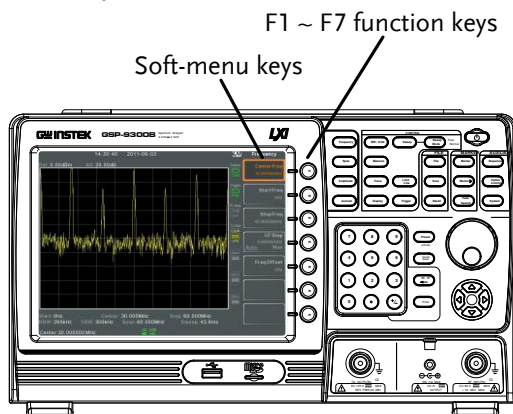

**Input Parameter Values**



Selecting this type of menu key will allow you to enter a new value with the numeric keypad or increment/decrement the value using the scroll wheel.

**Toggle State**

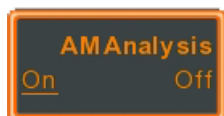

Pressing this menu key will toggle the state.

Toggle State &  
Input Parameter



Pressing this menu key will allow you to toggle the state of the function between Auto and Man(ual) state. When in the Man state, the parameter value can be manually edited. Use the numeric keypad to enter the new value or use the scroll wheel to increment/decrement the current value.

Sub Menu

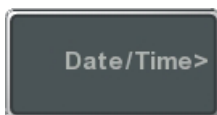

Pressing this menu key will enter a submenu.

Sub Menu to  
select parameter



Pressing this menu key will enter a submenu to select a parameter.

Active Function

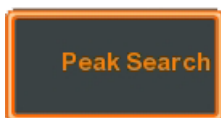

Pressing this type of menu key will activate that function. The menu key will be highlighted to show it is the active function.

Parameter input

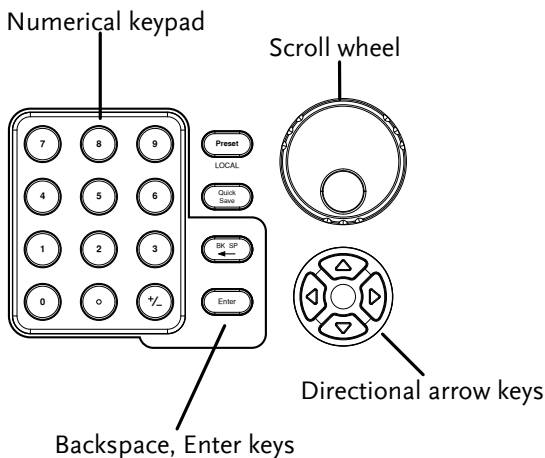

Parameter values can be entered using the numeric keypad, the scroll wheel and occasionally with the arrow keys.

Using the numeric keypad

When prompted to enter a parameter, use the number keys (0~9), the decimal key (.) and the sign key (+/-) to enter a value. After a value has been entered, the soft-menu keys can be used to select the units.

The value of the parameter is shown at the bottom of the screen as it is edited. Values can include decimal points for non-integer values or for entering dot-decimal notation for IP addresses.

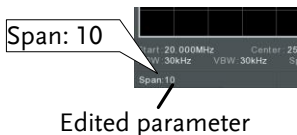

Back Space

Use the backspace key to delete the last character or number entered.

Using the scroll wheel

Use the scroll wheel to alter the current value. Clockwise increases the value, anti-clockwise decreases the value.

Directional arrows

Use the directional arrows to select discrete parameters or to alter values by a coarser resolution than the scroll wheel. Left decreases the value, right increases the value.

# BASIC OPERATION

The Basic Operation chapter in this Quick Start Guide only covers a few basic operations: how to view a signal, how to use a marker to make a measurement and how to setup the LXI interface. For comprehensive operating instructions, please see the user manual on the accompanying User Manual CD.

## Viewing a Signal

---

Description	This section will give a brief overview on how to view signals from the rear panel REF out terminal. Only the basic settings will be shown.
Operation	<ol style="list-style-type: none"> <li>1. Press . This will restore the factory default settings. See the user manual for details.</li> <li>2. Connect the REF out signal from the rear panel to the RF Input on the front panel.</li> </ol>

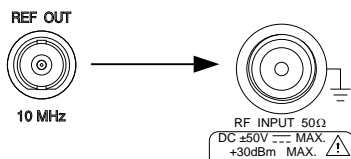



3. Press **Frequency** > *Center[F1]* and enter 10MHz. This is the output frequency of the REF out signal.
4. Press **Amplitude** > *Ref Level[F1]* and set the reference level to 17dBm.
5. Press **Span** and enter a span of 10MHz. This will set the start frequency to 5MHz and the stop frequency to 15MHz.

Display

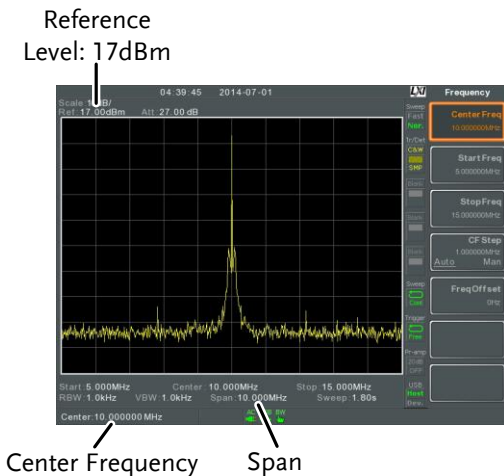

## Using the Marker Function

---

**Description** This section will describe how to activate and move a normal marker. The noise marker function will also be used to show how to make a basic marker measurement.

---

- Operation**
1. Use the procedure described in the previous section to display a signal from the REF out terminal.
  2. Press  > *Select Marker*[F1] and select marker number 1.
  3. Press [F2] and turn the marker 1 on.
  4. Press *Normal*[F3] and set the marker position to 12 MHz using either the keypad, scroll wheel or arrow keys.
  5. Press *Function*[F5]>*Marker Noise*[F2] and turn the marker noise function on. The noise marker function calculates the average noise level over a bandwidth of 1Hz, referenced from the marker position.

Display

Marker frequency      Measurement



Marker position

## Interface Configuration

The GSP-9300B supports USB, RS-232, GPIB (optional), WLAN and LAN based LXI interfaces for remote control. This Quick Start Guide only details how to connect to a LAN to access the LXI browser interface for remote control and configuration. Please see the programming manual or user manual on the accompanying User Manual CD for further details.

### Configure the LAN and LXI Interface

The GSP-9300B is a class C LXI compliant instrument. The LXI specification allows instrumentation to be configured for basic remote control or monitoring over a LAN or WLAN. The GSP-9300B also supports HiSlip. HiSlip (High-Speed LAN Instrument Protocol) is an advanced LAN based standard for 488.2 communications.

For details on the LXI specification, compliance classes and HiSLIP, please see the LXI website @ <http://www.lxistandard.org>.

Background	The LAN interface is used for remote control over a network. The spectrum analyzer supports DHCP connections so the instrument can be automatically connected to an existing network. Alternatively, network settings can also be manually configured.
------------	--

LAN configuration Settings	IP Address	Default Gateway
	Subnet Mask	DNS Server
	DHCP on/off	

Connection	Connect an Ethernet cable from the network to the rear panel LAN port.
------------	--



1. Press  >More[F7]>RmtInterface[F1]>LAN[F2]>LAN Config[F1] to set the LAN settings:

*IP Address[F1]* Sets the IP address.  
*Subnet Mask[F2]* Sets the subnet mask.  
*Default Gateway[F3]* Sets the default gateway.  
*DNS Server[F4]* Sets the DNS server address  
*LAN Config[F5]* Toggles the LAN configuration between DHCP and manual IP settings.

2. Press *Apply[F6]* to confirm the LAN configuration settings.

Display Icon



The LXI icon turns green when connected to a LAN and will flash if the “Identification” setting is on, see page 45.

Set Password

The password on the LXI webpage can be set from the spectrum analyzer. The password is shown in the system information.

3. Press  >More[F7]>RmtInterface Config[F1]>LAN[F2]>LXIPassword[F3] to set the password.

4. Enter the password using the F1~F7 keys, as shown below, or use the numeric keypad to enter numbers:

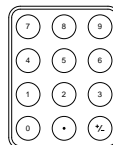

Limitations:

- \* No spaces
- \* Only 1~9, A~Z, a~z characters allowed

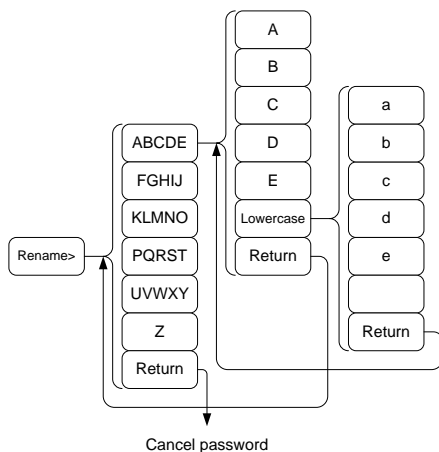

Menu tree to enter the password

- The password appears on the bottom of the screen as it is created.

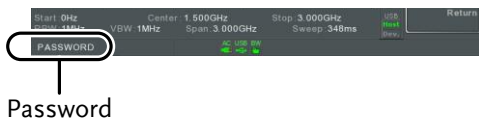

- Press **Enter** to confirm setting the password.

**Hi SLIP Port**

- Press **System** > More[F7] > RmtInterface Config[F1] > LAN[F2] > HiSLIPPort to see the Hi Slip Port number.  
HiSlip port 4880

**Reset LAN**

It may be necessary to reset the LAN configuration settings before the LAN can be used.

- Press **System** > More[F7] > RmtInterface Config[F1] > LAN Reset[F3] to reset the LAN.

## LXI Browser Interface and Function Check

Functionality check

Enter the IP address of the spectrum analyzer in a web browser after the instrument has been configured and connected to the LAN (page 42).

http:// XXX.XXX.XXX.XXX

The web browser interface appears:

Welcome Page

The Welcome Page lists all the LXI and LAN configuration settings as well as the instrument identification. The instrument identification can be turned on/off from this page.



Note



The LXI icon in the GSP-9300B display will flash when the Identification setting is turned on.

**View & Modify Configuration**

The View & Modify Configuration allows you to modify the LAN settings from the browser.

Press the *Modify Configuration* button to modify any of the configuration files.

A password must be entered to alter the settings.

Default password: lxiWNpwd  
 [Note: password is case sensitive.]

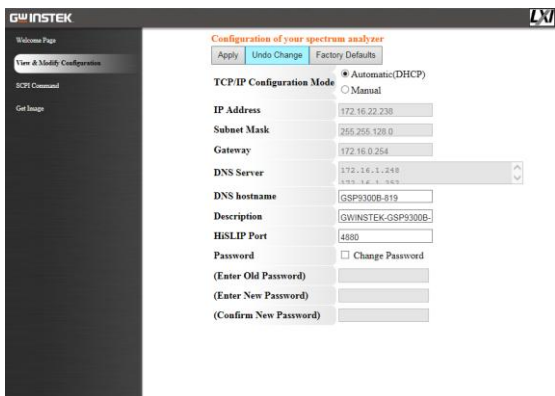



**SCPI Command**

The SCPI Command page allows you to enter SCPI commands directly from the browser for full remote control. Please see the programming manual for details. A password must be entered before remote commands can be used.

Default password: lxiWNpwd

[Note: password is case sensitive.]

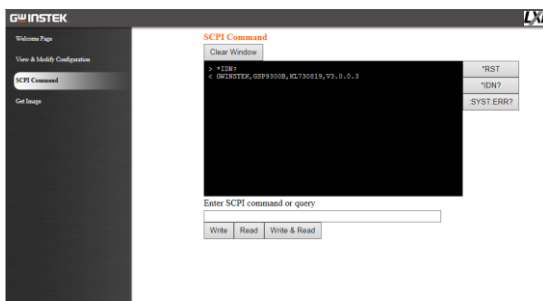

**Get Image**

The Get Image page allows the browser to remotely capture a screenshot of the GSP-9300B display.

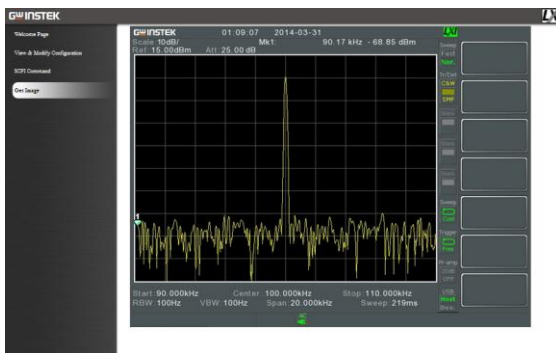

 **Note**

For further details, please see the programming manual, available on the GW Instek web site @ [www.gwinstek.com](http://www.gwinstek.com).

# A PPENDIX

## Replace the Clock Battery

---

**Background**                      The system clock and wake-up clock keep time using a button battery.

**Battery type:**                      CR2032, 3V, 210mAh

**Connection**                      1. Turn off the GSP-9300B and remove the battery cover and battery (if connected).

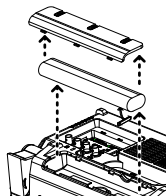

2. Replace the battery with the same type and specification.

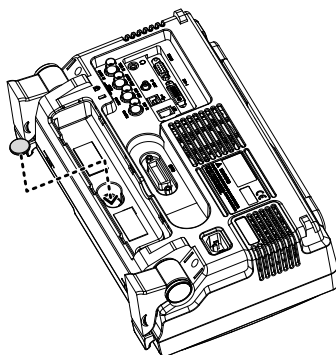

## GSP-9300B Specifications

The specifications apply when the GSP is powered on for 45 minutes\* to warm-up to a temperature of 20°C to 30°C, unless specified otherwise.

\* 45 minutes typical, 90 minutes maximum

### Frequency

Frequency		
Range	9 kHz to 3 GHz	
Resolution	1 Hz	
Frequency Reference		
Accuracy	±(period since last adjustment X aging rate) + stability over temperature + supply voltage stability	
Aging Rate	±1 ppm max.	1 year after last adjustment
Frequency Stability over Temperature	±0.025 ppm	0 to 50 °C
Supply Voltage Stability	±0.02 ppm	
Frequency Readout Accuracy		
Start, Stop, Center, Marker	±(marker frequency indication X frequency reference accuracy + 10% x RBW + frequency resolution <sup>1</sup> )	
Trace points	Max 601 points, min 6 points	
Marker Frequency Counter		
Resolution	1 Hz, 10 Hz, 100 Hz, 1 kHz	
Accuracy	±(marker frequency indication X frequency reference accuracy + counter resolution)	RBW/Span >=0.02 ; Mkr level to DNL>30 dB
Frequency Span		
Range	0 Hz (zero span), 100 Hz to 3 GHz	
Resolution	1 Hz	
Accuracy	± frequency resolution <sup>1</sup>	RBW: Auto;

Phase Noise		
Offset from Carrier		Fc =1 GHz; RBW = 1 kHz, VBW = 10 Hz; Average $\geq 40$
10 kHz	<-88 dBc/Hz	<i>Typical<sup>2</sup></i>
100 kHz	<-95 dBc/Hz	<i>Typical</i>
1 MHz	<-113 dBc/Hz	<i>Typical</i>

Resolution Bandwidth (RBW) Filter		
Filter Bandwidth	1 Hz to 1 MHz in 1-3-10 sequence	-3dB bandwidth
	200 Hz, 9 kHz, 120 kHz, 1MHz	-6dB bandwidth
Accuracy	$\pm 8\%$ , RBW = 1MHz	Nominal <sup>3</sup>
	$\pm 5\%$ , RBW < 1MHz	Nominal
Shape Factor	< 4.5:1	Nominal ; Normal Bandwidth ratio: -60dB:-3dB

Video Bandwidth (VBW) Filter		
Filter Bandwidth	1 Hz to 1 MHz in 1-3-10 sequence	-3dB bandwidth

[1] Frequency Resolution = Span/(Trace points - 1)

[2] Typical specifications in this datasheet mean that the performance can be exhibited in 80% of the units with a 95% confidence level over the temperature range 20 to 30 °C. They are not covered by the product warranty.

[3] Nominal values indicate expected performance. They are not covered by the product warranty.

## Amplitude

Amplitude Range		
Measurement Range	100 kHz to 1 MHz	Displayed Average Noise Level (DANL) to 18 dBm
	1 MHz to 10 MHz	DANL to 21 dBm
	10 MHz to 3 GHz	DANL to 30 dBm

Attenuator		
Input Attenuator Range	0 to 50 dB, in 1 dB step	Auto or manual setup

Maximum Safe Input Level		
Average Total Power	$\leq +33$ dBm	Input attenuator $\geq 10$ dB
DC Voltage	$\pm 50$ V	

**1 dB Gain Compression**

Total Power at 1st Mixer	> 0 dBm	<i>Typical</i> ; Fc ≥ 50 MHz; preamp. off
Total Power at the Preamp	> -22 dBm	<i>Typical</i> ; Fc ≥ 50 MHz; preamp. on
mixer power level (dBm) = input power (dBm) - attenuation (dB)		

**Displayed Average Noise Level (DANL)<sup>4</sup>**

Preamp off	0 dB attenuation; RF Input is terminated with a 50Ω load. RBW 10 Hz; VBW 10 Hz; span 500 Hz; reference level = -60dBm; trace average ≥ 40	
9 kHz to 100 kHz	< -93 dBm	
100 kHz to 1 MHz	< -90 dBm - 3 x (f/100 kHz) dB	Nominal
1 MHz to 2.7 GHz	< -122 dBm	
2.7 GHz to 3 GHz	< -116 dBm	
Preamp on	0 dB attenuation; RF Input is terminated with a 50Ω load ; RBW 10 Hz; VBW 10Hz; span 500 Hz; reference level = -60dBm; trace average ≥ 40	
100 kHz to 1 MHz	< -108 dBm - 3 x (f/100 kHz) dB	Nominal
1 MHz to 10 MHz	< -142 dBm	
10 MHz to 3 GHz	< -142 dBm + 3 x (f/1 GHz) dB	

[4] DANL spec excludes spurious response.

**Level Display Range**

Scales	Log, Linear	
Units	dBm, dBmV, dBuV, V, W	
Marker Level	0.01 dB	Log scale
Readout	0.01 % of reference level	Linear scale
Level Display Modes	Trace, Topographic, Spectrogram	Single / split Windows
Number of Traces	4	
Detector	Positive-peak, negative-peak, sample, normal, RMS (not Video)	Can be setup for each trace separately
Trace Functions	Clear & Write, Max/Min Hold, View, Blank, Average	

**Absolute Amplitude Accuracy**

Absolute Point	Center=160 MHz ; RBW 10 kHz; VBW 1 kHz; span 100 kHz; log scale; 1 dB/div; peak detector; 23°C ±1°C; Signal at Reference Level	
Preamp off	± 0.3 dB	Ref level 0 dBm; 10 dB RF attenuation
Preamp on	± 0.4 dB	Ref level -30 dBm; 0 dB RF attenuation

**Frequency Response**

Preamp off	Attenuation: 10 dB; Reference: 160 MHz; 20 to 30°C	
100 kHz to 2.0 GHz	± 0.5 dB	
2GHz to 3GHz	± 0.7 dB	
Preamp on	Attenuation: 0 dB; Reference: 160 MHz; 20 to 30°C	
1 MHz to 2 GHz	± 0.6 dB	
2 GHz to 3 GHz	± 0.8 dB	

**Attenuation Switching Uncertainty**

Attenuator setting 0 to 50 dB in 1 dB step		
Uncertainty	± 0.25 dB	reference: 160 MHz, 10dB attenuation

**RBW Filter Switching Uncertainty**

1 Hz to 1 MHz	± 0.25 dB	reference : 10 kHz RBW
---------------	-----------	------------------------

**Level Measurement Uncertainty**

Overall Amplitude Accuracy	± 1.5 dB	20 to 30°C; frequency > 1 MHz; Signal input 0 to -50 dBm; Reference level 0 to -50 dBm; Input attenuation 10 dB; RBW 1 kHz; VBW 1 kHz; after cal; Preamp Off
	± 0.5 dB	<i>Typical</i>

**Spurious Response**

Second Harmonic Intercept		Preamp off; signal input -30dBm; 0 dB attenuation
	+35 dBm	<i>Typical</i> ; 10 MHz < fc < 775 MHz
	+60 dBm	<i>Typical</i> ; 775 MHz ≤ fc < 1.625 GHz
Third-order Intercept		Preamp off; signal input -30dBm; 0 dB attenuation
	> 1dBm	300 MHz to 3 GHz
Input Related Spurious	< -60 dBc	Input signal level -30 dBm, Att. Mode, Att=0dB; 20-30°C
Residual Response (inherent)	<-90 dBm	Input terminated; 0 dB attenuation; Preamp off

**Sweep**

**Sweep Time**

Range	204 us to 1000 s	Span > 0 Hz
	50 us to 1000 s	Span = 0 Hz; Min Resolution = 10 us
Sweep Mode	Continuous; Single	
Trigger Source	Free run; Video; External	
Trigger Slope	Positive or negative edge	

**RF Preamplifier**

Frequency Range	1 MHz to 3 GHz	
Gain	18 dB	Nominal (installed as standard)

**Front Panel Input/Output**

**RF Input**

Connector Type	N-type female	
Impedance	50 ohm	Nominal
VSWR	<1.6 :1	300 kHz to 3 GHz; Input attenuator ≥ 10 dB

Power for Option			
Connector Type	SMB male		
Voltage/Current	DC +7V / 500 mA max	With short-circuit protection	
USB Host			
Connector Type	A plug		
Protocol	Version 2.0	Supports Full/High/Low speed	
MicroSD Socket			
Protocol	SD 1.1		
Supported Cards	microSD, microSDHC	Up to 32GB capacity	

## Rear Panel Input/Output

Reference Output			
Connector Type	BNC female		
Output Frequency	10 MHz	Nominal	
Output Amplitude	3.3V CMOS		
Output Impedance	50 ohm		
Reference Input			
Connector Type	BNC female		
Input Reference Frequency	10 MHz		
Input Amplitude	-5 dBm to +10 dBm		
Frequency Lock Range	Within $\pm 5$ ppm of the input reference frequency		
Alarm Output			
Connector Type	BNC female	Open-collector	
Trigger Input/ Gated Sweep Input			
Connector Type	BNC female		
Input Amplitude	3.3V CMOS		
Switch	Auto selection by function		
LAN TCP/IP Interface			
Connector Type	RJ-45		
Base	10Base-T; 100Base-Tx; Auto-MDIX		
USB Device			
Connector Type	B plug	For remote control only; supports USB TMC	
Protocol	Version 2.0	Supports Full/High/Low speed	



IF Output			
Connector Type	SMA female		
Impedance	50 ohm	Nominal	
IF Frequency	886 MHz	Nominal	
Output level	-25 dBm	10 dB attenuation; RF input: 0 dBm @ 1 GHz	
Earphone Output			
Connector Type	3.5mm stereo jack, wired for mono operation		
Video Output			
Connector Type	DVI-I ( integrated analog and digital) , Single Link. Compatible with VGA or HDMI standard through adapter		
RS232 Interface			
Connector Type	D-sub 9-pin female	Tx,Rx,RTS,CTS	
GPIB Interface (Optional)			
Connector Type	IEEE-488 bus connector		
AC Power Input			
Power Source	AC 100 V to 240 V, 50 / 60 Hz Auto range selection		
Battery Pack (Optional)			
Battery pack	6 cells, Li-Ion rechargeable, 3S2P	With UN38.3 Certification	
Voltage	DC 11.1 V		
Capacity	5200 mAh / 56Wh		

## General

Internal Data storage	16 MB nominal		
Power Consumption	<65 W		
Warm-up Time	< 30 minutes		
Temperature Range	+5 °C to +45 °C	Operating	
	-20 °C to + 70 °C	Storage	
Weight	4.5 kg (9.9 lb)	Inc. all options (Basic+TG+GPIB+Battery)	
Dimensions	210 x 350 x 100 (mm)	Approximately	
	8.3 x 13.8 x 3.9 (in)		

### Tracking Generator<sup>5</sup> (Optional)

Frequency Range	100 kHz to 3 GHz	
Output Power	-50 dBm to 0 dBm in 0.5 dB steps	
Absolute Accuracy	± 0.5 dB	@160 MHz, -10 dBm, Source attenuation 10 dB, 20 to 30°C
Output Flatness	Referenced to 160 MHz, -10 dBm	
	100 kHz to 2 GHz	± 1.5 dB
	2 GHz to 3 GHz	± 2 dB
Output Level	± 0.8 dB	Referenced to -10 dBm
Switching Uncertainty		
Harmonics	< -30 dBc	Typical, output level = -10 dBm
Reverse Power	+30 dBm max.	
Connector type	N-type female	
Impedance	50 ohm	Nominal
Output VSWR	< 1.6:1	300 kHz to 3 GHz, source attenuation ≥ 12 dB

[5] The minimum RBW filter is 10kHz when the TG output is ON.

## GSP-9300B Dimensions

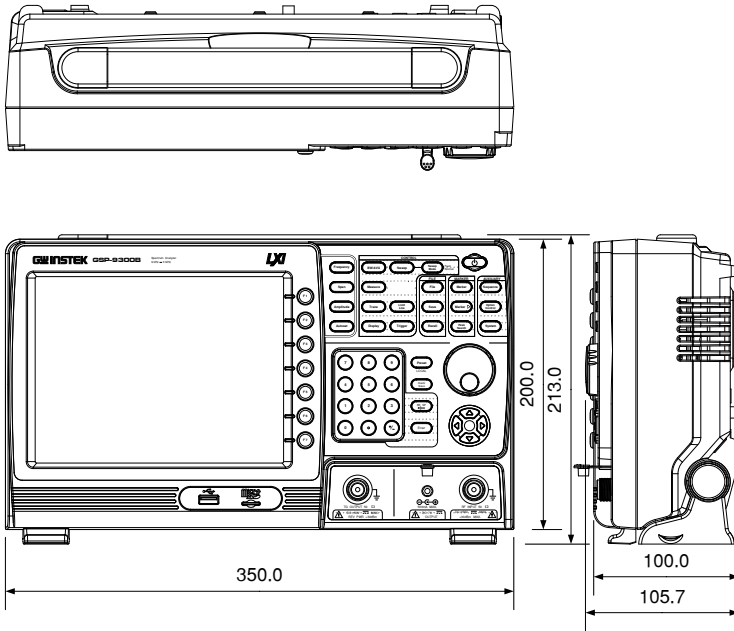

# Declaration of Conformity

We

**GOOD WILL INSTRUMENT CO., LTD.**

declare that the below mentioned product

**Type of Product: Spectrum Analyzer**

**Model Number: GSP-9300B**

is herewith confirmed to comply with the requirements set out in the Council Directive on the Approximation of the Laws of the Member States relating to the EMC: 2014/30/EU, LVD: 2014/35/EU, WEEE: 2012/19/EU and RoHS: 2011/65/EU.

For the evaluation regarding the Electromagnetic Compatibility and Low Voltage Directive, the following standards were applied:

<b>© EMC</b>	
EN 61326-1: EN 61326-2-1: EN 61326-2-2:	Electrical equipment for measurement, control and laboratory use -- EMC requirements (2013)
Conducted & Radiated Emission EN 55011: 2009+A1: 2010	Electrical Fast Transients EN 61000-4-4: 2012
Current Harmonics EN 61000-3-2: 2014	Surge Immunity EN 61000-4-5: 2014
Voltage Fluctuations EN 61000-3-3: 2013	Conducted Susceptibility EN 61000-4-6: 2014
Electrostatic Discharge EN 61000-4-2: 2009	Power Frequency Magnetic Field EN 61000-4-8: 2010
Radiated Immunity EN 61000-4-3: 2006+A1: 2008+A2: 2010	Voltage Dip/ Interruption EN 61000-4-11: 2004
Low Voltage Equipment Directive 2014/35/EU	
<b>Safety Requirements</b>	<b>EN 61010-1: 2010 (Third Edition)</b> <b>EN 61010-2-030: 2010 (First Edition)</b>