



Inspection and Retrieval Tools – 2015



RT2015

**Test Equipment
Depot**
1-800-517-8431

99 Washington Street
Melrose, MA 02176
Phone 781-665-1400 Toll
Free 1-800-517-8431

Visit us at www.TestEquipmentDepot.com

Go For The Gold!

Professional Inspection and Retrieval System



91582
Telescoping
Lighted Magnetic
Pick-Up

91555
Telescoping
Lighted Magnetic
Pick-Up with Small
Round Mirror

91557
Telescoping
Lighted Magnetic
Pick-Up with Large
Round Mirror

90557
Telescoping
Round
Inspection
Mirror

92557
Telescoping
Lighted
Round
Inspection
Mirror

The line consists of 13 different products that help professionals and DIYers alike to inspect hard-to-see areas and retrieve hard-to-reach objects. The tools range from inspection mirrors to mechanical and magnetic pick-ups with goose-neck heads in lighted or non-lighted telescoping styles.

NEW!

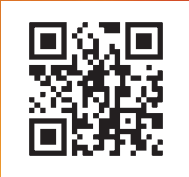

92560
Telescoping
Lighted
Rectangular
Inspection
Mirror



90560
Telescoping
Rectangular
Inspection
Mirror



91560
Telescoping
Lighted
Rectangular
Inspection
Mirror



91581
Mini-
Telescoping
Lighted
Magnetic
Pick-Up



91383
Telescoping
Magnetic
Pick-Up

ALL TOOLS FEATURE:

- Heavy-duty anodized aluminum bodies for rugged worksite use (in a gold color)
- Grooved telescoping stainless steel shaft; design prevents rotational slipping to ensure secure positioning and pick-up
- Flexible-obedient gooseneck for access into hard-to-reach areas

Inspection Mirrors



80560



LIGHTED RECTANGULAR INSPECTION MIRROR – 80560

- 2 Extra bright LED lights facilitate the inspection of hard-to-see and hard-to-reach areas
- Ideal for toolmakers, machinists, inspectors and mechanics
- Fully polished glass mirror is shatter-resistant
- 2 “CF2032” batteries included
- 360° Swivel double ball joint

UPC	NO.	SIZE	OVERALL LENGTH
02146 5	80560	2" x 3"	12-1/4", extends to 33"

LIGHTED ROUND INSPECTION MIRROR – 80557

- Round head LED inspection mirror gets into tight places and its diffused LED bulbs spread light evenly over the viewing area.
- Ideal for toolmakers, machinists, inspectors and mechanics
- Fully polished glass mirror is shatter-resistant
- 2 “CF2032” batteries included
- 360° Swivel double ball joint

80557



UPC	NO.	SIZE	OVERALL LENGTH
80557 7	80557	1.85" dia"	11-1/2", extends to 34"

UTILITY TELESCOPING INSPECTION MIRRORS – 70555, 70557

- These mirrors facilitate inspection of inaccessible work pieces and machines by toolmakers, assemblers, inspectors and mechanics
- Fully polished mirrors are enclosed in plated holders which are attached to handles with a double ball and socket joint
- Double ball and socket joints adjust to any angle
- Nos. 70557 have telescoping arms and vinyl cushion grip handles



70557



70555



UPC	NO.	SIZE	OVERALL LENGTH
22344 9	70555	1-3/8" dia.	5" extends to 27-1/2"
22347 0	70557	2-1/4" dia.	9-3/4" extends to 14-3/4"

759570

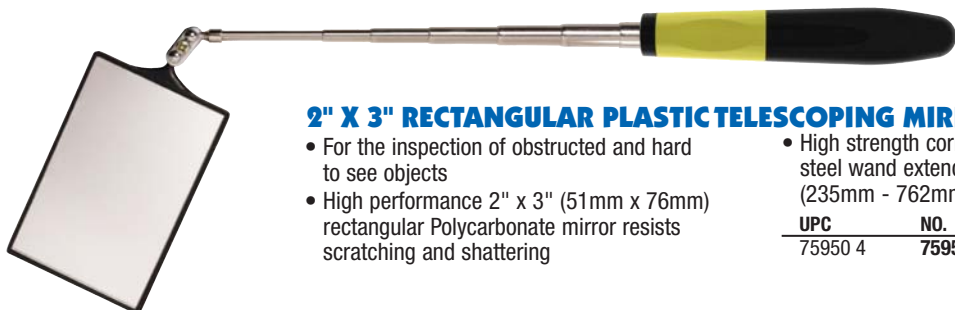

2" X 3" RECTANGULAR PLASTIC TELESCOPING MIRROR – 759570

- For the inspection of obstructed and hard to see objects
- High performance 2" x 3" (51mm x 76mm) rectangular Polycarbonate mirror resists scratching and shattering
- High strength corrosion resistant stainless steel wand extends from 9-1/4" to 30" (235mm - 762mm)

UPC	NO.	PKG.
75950 4	759570	Carded

2-1/2" ROUND TELESCOPING 3X POWER MAGNIFYING MIRROR – 759563

- For the inspection of obstructed and hard to see objects
- High quality 2-1/2" (64mm) diameter magnifying glass mirror improves visibility
- High strength corrosion resistant stainless steel wand extends from 8-1/2" to 29" (216mm – 737mm)



759563

UPC	NO.	PKG.
75959 7	759563	Carded

GLASS INSPECTION MIRRORS – 555, 557, 558, 560

- These mirrors facilitate inspection of inaccessible workpieces and machines by toolmakers, assemblers, inspectors and mechanics
- Fully polished glass mirrors are enclosed in plated holders which are attached to knurled handles with ball and socket joints
- Nos. 557, 577, 560, and 570 have telescoping arms and vinyl cushion grip handles

UPC	NO.	SIZE	OVERALL LENGTH
42465 5	555	1-1/4" dia.	8"
42468 6	557	2-1/4" dia.	10-1/2", extends to 15"
42471 6	558	1" x 2" oval	9"
42473 0	560	3-1/2" x 2" oblong	11-1/2", extends to 16"



560
570

558

ACRYLIC PLASTIC INSPECTION MIRRORS – 577, 570

UPC	NO.	SIZE	OVERALL LENGTH
42480 8	577	2-1/4" dia.	10-1/2" – 15"
42477 8	570	3-1/2" x 2"	11-1/2" – 16"



557
577

REPLACEMENT GLASS MIRRORS WITH FRAMES – 557RMF, 560RMF

UPC	NO.
42478 5	557RMF for No. 557
42484 6	560RMF for No. 560 and No. MB560



555

MAGNETIC BASE INSPECTION MIRROR – MB560

- Adjustable 3-1/2" x 2" oblong glass inspection mirror mounted to a permanent magnet
- Attaches to any steel or iron machine, tool, appliance or other equipment
- Has wing nut ball joint adjustment

UPC	NO.
42475 4	MB560



MB560

Inspection Mirrors & Magnifiers



METAL INSPECTION "FLAME" MIRRORS – 5561, 5562, 5563

- Includes plastic protective sheath
- Heavy-duty construction

UPC	NO.	SIZE	OVERALL LENGTH
05531 3	5561	1-1/4" x 2"	9-3/4", extends to 26"
05562 0	5562	2" x 3-3/4"	10-3/4", extends to 26"
05563 7	5563	3-3/4" dia.	9-3/4", extends to 26"



EXTRA-LONG TELESCOPING GLASS INSPECTION MIRROR – 559

- 36" telescoping
- Handle has black cushion grip
- Non-slip grip
- Mirror size: 2" diameter

UPC	NO.
05590 3	559



• Hands-Free Use



• 3x Magnification, 6x Inset Lens



• Extra-Bright LED



LumiLENS™ LIGHTED MAGNIFIER – 800543

- Push On / Push Off Powerful LED light
 - Contoured Handle for Handheld Use
 - Integrated Stand for Hands-Free Use
 - Shatter-Resistant Lens
 - 3-1/2" Lens Diameter (89mm)
 - 3X Magnification (6X Inset lens)
 - Power Source: 2 "AA" batteries (included)
- Includes • Protective pouch

UPC	NO.
26001 7	800543

4" POWER POCKET ILLUMINATED MAGNIFIER – 553

- Handy 4 power magnifier has plastic body and lens
- Power Source: "AAA" batteries and No. 222 bulb (included)

UPC	NO.	POWER
42456 3	553	4



553

4" ILLUMINATED MAGNIFIER – 554

- 4" diameter with three power lens covers large areas of print
- Five power bifocal lens insert gives even greater magnification
- Bulb gives wide circle of illumination
- Plastic body and optical plastic lens
- Power Source: 2 "C" batteries (not included)

UPC	NO.	POWER	FOCAL LENGTH
42462 4	554	3.0	3-1/3"
	Bifocal	5.0	2"



554

RECTANGULAR ILLUMINATED MAGNIFIER – 565

- Lens measures 2" x 4" for distortion-free magnification of large areas
- Reversible light reflector adapts for right- or left-hand use
- 2.5 power shatterproof lens, with 5 power bifocal insert
- Replaceable bulb
- 2 "AA" batteries (included)

UPC	NO.	POWER	FOCAL LENGTH
42509 6	565	2.5	4"
	Bifocal	5.0	2"



565

GLASS MAGNIFIERS – 700540, 750542, 750544

- Polished optical glass lens with a metal frame
- Versa-Grip™ Handle with non-slip cushion grip
- Full range of sizes from 2" (50mm) to 4-1/2" (115mm)
- Round lens is distortion free
- A powerful magnifier for working in confined or obstructed spaces
- Designed for demanding jobs in laboratory quality control, inspection and assembly functions
- Used by engineers, mechanics, inspectors, lab technicians, toolmakers, instrument assemblers, jewelers, do-it-yourselfers, hobby and crafts people

UPC	NO.	DIAMETER	POWER	FOCAL LENGTH
00540 3	700540	2" (50mm)	1.6	6"
50542 2	750542	3" (75mm)	1.6	6"
50544 6	750544	4" (100mm)	1.25	8"



750542



700540

Magnifiers



538

2" MAGNIFIER – 538

- Economical and versatile magnifier for laboratory and industrial uses, for do-it-yourselfers, mechanics and inspectors
- 2" diameter with four power lens
- Lightweight, durable 1-piece molded plastic frame

UPC	NO.	POWER	FOCAL LENGTH
42414 3	538	4	2"



532



2.5 POWER POCKET MAGNIFIER – 532

- Has 2.5 power ground and polished optical glass
- Folds into case for storage

UPC	NO.	POWER	FOCAL LENGTH
42400 6	532	2.5 Simulated	4"
		Black Leather case	



527



EYE LOUPE – 527

- For toolmakers, jewelers, instrument assemblers and others who need sharp, clear magnification without eyestrain
- Clear optical glass lens is ground and polished
- 1" diameter lens

UPC	NO.	POWER	FOCAL LENGTH
42339 9	527	5.0	2"



533



536

FOLDING POCKET MAGNIFIERS – 533, 536, 537

- Fine quality magnifiers for laboratory technicians, engineers, mechanics and inspectors
- Case and lens rims are made of black molded plastic
- Available in single lens and double lens models

UPC	NO.	IND. MOD.	TOT. POW.	LENS POW.	FOCAL DIA.	LENGTH
42403 7	533	Sing.	4.0	4.0	1"	2.5"
42409 9	536	Dble.	4.0	8.0	1"	1.25"
42412 9	537	Dble.	3.0	6.0	1-1/4"	1.6"



950-5



BINOCULAR MAGNIFIER – 950-5

- For assemblers and inspectors of electronic and other small or subminiature parts, toolmakers, jewelers and engravers
- Leaves hands free to work
- Ground and polished optical lenses eliminate eyestrain
- Tilt-up lens frame
- Fits over prescription glasses

UPC	NO.	POWER	FOCAL LENGTH
43734 1	950-5	2.25	8"

LIGHTED MECHANICAL & MECHANICAL/MAGNETIC PICK-UPS – 70390, 70391, 70396, 70399

Lighted mechanical pick-ups are ideal for retrieving items from dark or hard-to-reach areas.

FEATURES: 70390/70391

- No. 70390, Lighted Magnetic/Mechanical Pick-Up, 24" (610mm) with Flexi-Shaft™
- No. 70391, Lighted Magnetic/Mechanical Pick-Up, 36" (914mm) with Flexi-Shaft™
- Push on powerful LED light
- Continued pushing opens strong spring steel retrieval claw
- Comfortable ergonomically designed hand control
- Flexible shaft
- Corrosion resistant black finish
- Sliding magnetic sleeve
- Includes 3 "LR41" batteries

UPC	NO.
00000 0	70390 24" (610mm) Patented
00000 0	70391 36" (914mm) Patented
	LR41 replacement battery

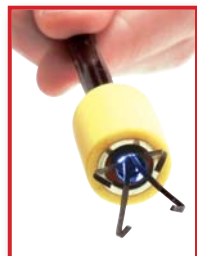

No. 70390
24" (610 mm)

No. 70391
36" (914 mm)

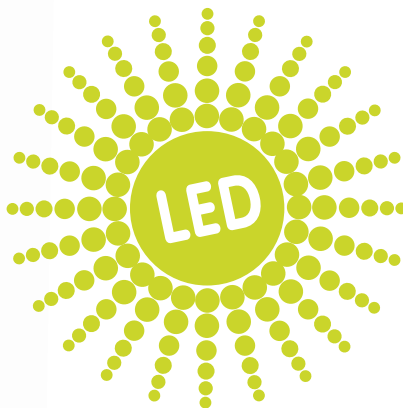

FEATURES: 70396/70399

- No. 70396, Lighted Mechanical Pick-Up 24" (610mm) with Flexi-Shaft™
- No. 70399, Lighted Mechanical Pick-Up 36" (914mm) with Flexi-Shaft™
- Push on powerful LED light
- Continued pushing opens strong spring steel retrieval claw
- Comfortable ergonomically designed hand control
- Flexible shaft
- Corrosion resistant black finish
- Includes 3 "LR41" batteries

UPC	NO.
26003 1	70396 24" (610mm) Patented
70393 4	70399 36" (914mm) Patented
	LR41 replacement battery

No. 70396
24" (610 mm)

No. 70399
36" (914 mm)

Magnetic Pick-ups



759582

TELESCOPING MINI-LIGHT – 759581 TELESCOPING MINI-LIGHT WITH MAGNETIC PICK-UP – 759582

- Telescoping Mini-light and Telescoping Mini-light with 2 lb. Neodymium magnetic pick-up are both fastened to a stainless steel telescoping wand molded into a rugged high-impact ABS plastic handle
- Both telescopes from 7-3/4" – 28-3/4" (197mm – 720mm)
- 4 Alkaline, "LR41", batteries with a battery life of 48 continuous hours
- LED bulb has a life of 100,000 hours of continuous use

- Mini-light is fastened to a chrome plated brass wand with a double ball joint
- Ball and socket feature for simple, positive adjustments

UPC	NO.	PKG.
75966 5	759581	Carded (light only)
75967 2	759582	Carded (light & magnetic pick-up)



582



TELESCOPING MINI-LITE WITH MAGNETIC PICK-UP – 582

- A powerful permanent magnetic pick-up tool
- Ideal for retrieving steel and iron parts from hard-to-reach and see work areas
- Telescopes from 7-3/4" – 29" (140mm – 737mm)
- 2 lb. pull Neodymium magnet is fitted in a 5-1/2" (140mm) long ergonomically designed handle
- 4 Alkaline, "LR41", batteries with a battery life of 48 continuous hours

- Light Bulb has a life of 100,000 hours of continuous use
- Mini-Light is fastened to a chrome plated brass wand with a double ball joint
- Ball and socket feature for simple, positive adjustments

UPC	NO.	PKG.
05820 1	582	Carded



759383
759398

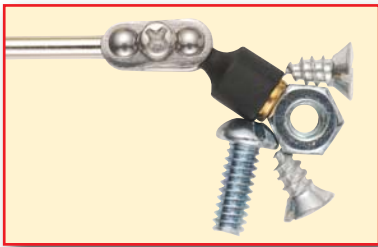

TELESCOPING MAGNETIC PICK-UPS – 759383, 759398

- High powered 2 lb. and 10 lb. Neodymium magnets are 6 times stronger than standard Cobalt magnets
- Double ball joint connection permits infinite angle adjustments
- High strength corrosion resistant stainless steel wand extends from 6-1/2" - 27" (165mm – 686mm)

- Magnet holder is constructed of high-strength reinforced nylon

UPC	NO.	PULL	PKG.
75933 7	759383	2 lb.	Carded
75939 9	759398	10 lb.	Carded



394

EXTRA-LONG, MAGNETIC PICK-UP WITH PIVOT JOINT – 394

- An excellent tool for retrieving steel parts from hard-to-reach places
- High-power neodymium magnet lifts up to five pounds and will never lose its magnetism
- Steel body measures 13" (330mm) and can be extended to 27" (686mm)

- Locking pivot joint allows user to pick up objects around corners
- Body is chrome plated, with a vinyl cushion grip handle

UPC	NO.	PULL
42228 6	394	5 lb. pull

MAGNETIC PICK-UP WITH PIVOT JOINT – 392

- An excellent tool for retrieving small steel parts from hard-to-reach places
- High-power neodymium magnet lifts up to two pounds and will never lose its magnetism
- 8-3/4" (222mm) overall length
- Locking pivot joint allows user to pick up objects around corners
- Nickel plated steel body with cushion grip handle
- Pocket clip for convenient storage

UPC	NO.	PULL
42224 8	392	2 lb. pull



392

POCKET MAGNETIC PICK-UP – 386

- Powerful permanent magnet in a knurled aluminum holder with handy pocket clip
- High-powered neodymium magnet is six times more powerful than standard magnet
- Ideal for retrieving small steel and iron parts from hard-to-reach areas
- Measures 5-1/2" (140mm) overall
- Pocket clip for convenient storage

UPC	NO.	MAGNET	PULL
42219 4	386	NEO	2 lb. pull



386

FLEX-O-STIFF MAGNETIC PICK-UP – 384N

- An ideal tool for retrieving steel parts from hard-to-reach places
- High-powered neodymium magnet is six times more powerful than standard magnet
- Permanent magnetic power
- Magnet is fitted into an 18" (457mm) nickel plated holder, which can be extended to a 32" (813mm) flexible retriever

UPC	NO.	MAGNET	PULL
42210 1	384N	NEO	2 lb. pull

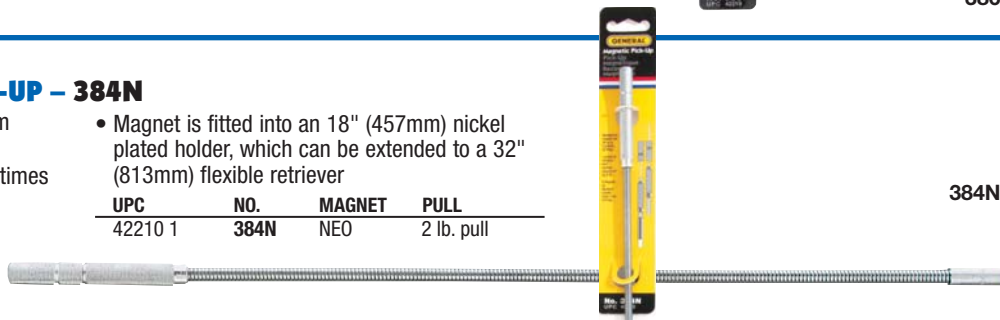

384N

BENDABLE MAGNETIC PICK-UP – 395

- An excellent tool for retrieving steel parts from hard-to-reach places
- High-power neodymium magnet
- Knurled aluminum body with bendable 15" (381mm) wire
- Overall length is 20" (508mm)
- Lifts up to 2 pounds

UPC	NO.	PULL
42229 3	395	2 lb. pull



395

TELESCOPING MAGNETIC PICK-UP – 383NX

- A powerful permanent magnetic pickup tool
- Ideal for retrieving steel and iron parts from hard-to-reach work areas
- Magnet is fitted in a 5-1/2" (140mm) long nickel plated steel handle that can extend up to 23-1/2" (597mm)
- Holder is fitted with a pocket-clip

UPC	NO.	PULL
42208 8	383NX	2 lb. pull



383NX

PRECISION MAGNETIZER/DEMAGNETIZER – 3601

- Magnetize and demagnetize screwdrivers, tweezers, tool bits and other steel objects
- Magnetize by sliding the tool through the (+) opening
- Demagnetize by sliding the tool through the (-) opening
- Demagnetize tools for use in electronics
- Step design permits greater control of magnetism

UPC	NO.	DIMENSIONS
36010 6	3601	2" x 2" x 1-1/8" (58 x 58 x 29mm)



3601

360



MAGNETIZER/DEMAGNETIZER – 360

- Specially designed for magnetizing and demagnetizing screwdrivers, nut drivers, wrenches, taps and small tools
- Converts any tool blade into a magnetic retriever for screws, nuts and metallic particles

UPC	NO.	DIMENSIONS
42021 3	360	1" x 1" x 1-3/4" (25 x 25 x 44mm)

396

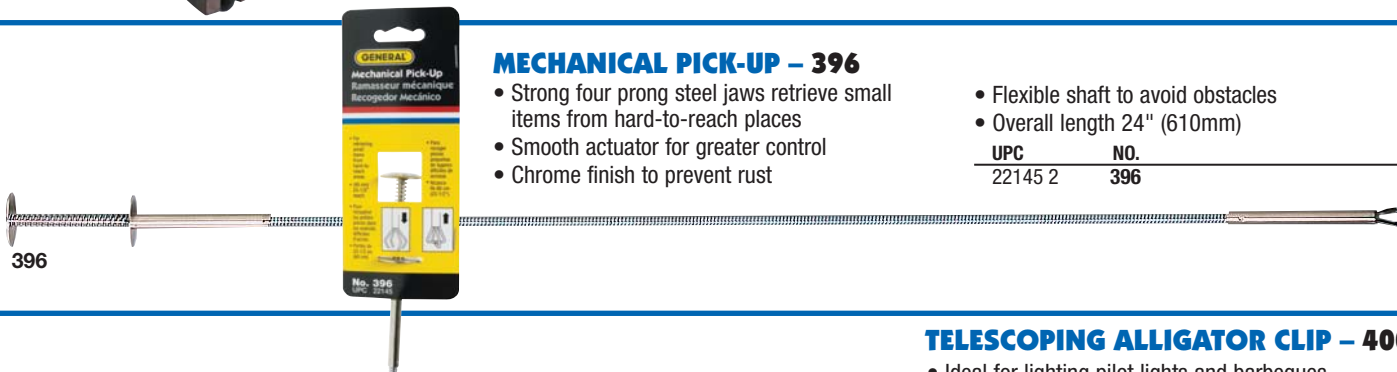

MECHANICAL PICK-UP – 396

- Strong four prong steel jaws retrieve small items from hard-to-reach places
- Smooth actuator for greater control
- Chrome finish to prevent rust

- Flexible shaft to avoid obstacles
- Overall length 24" (610mm)

UPC	NO.
22145 2	396

400



TELESCOPING ALLIGATOR CLIP – 400

- Ideal for lighting pilot lights and barbecues
- Jaw capacity: .170" (4.30mm)
- Chrome finish to prevent rust
- Telescopes from 6-1/4" to 24-1/2" (159 – 616mm)
- Convenient pocket-clip

UPC	NO.
42217 0	400



70401



LIGHTED TWEEZERS – 70401

Allows you to retrieve items from dark, hard-to-reach places. Puts the light exactly where you need it. Pointed Smooth Tip.

FEATURES:

- Powerful LED Light
- Push ON / Push OFF Switch
- Non-slip Comfort Grips
- Corrosion Resistant Black Finish

- Overall Length - 4.2 (106mm)
- Includes 3 "LR41" batteries
- Patented

UPC	NO.
26004 8	70401

70403



LIGHTED TWEEZERS – 70403

Allows you to retrieve items from dark, hard-to-reach places. Puts the light exactly where you need it. Blunt Serrated Tip.

FEATURES:

- Powerful LED Light
- Push ON / Push OFF Switch
- Non-slip Comfort Grips
- Corrosion Resistant Black Finish

- Overall Length - 4.2 (106mm)
- Includes 3 "LR41" batteries
- Patented

UPC	NO.
26005 5	70403

70408



LIGHTED TWEEZERS – 70408

Allows you to retrieve items from dark, hard-to-reach places. Puts the light exactly where you need it. Bent Serrated Tip.

FEATURES:

- Powerful LED Light
- Push ON / Push OFF Switch
- Non-slip Comfort Grips
- Corrosion Resistant Black Finish

- Overall Length - 4.2 (106mm)
- Includes 3 "LR41" batteries
- Patented

UPC	NO.
26006 2	70408