

DC Electronic Load

PEL-3000(H) Series

QUICK START GUIDE

GW INSTEK PART NO. 82EL-3111oMD1



ISO-9001 CERTIFIED MANUFACTURER

GW INSTEK

This manual contains proprietary information, which is protected by copyright. All rights are reserved. No part of this manual may be photocopied, reproduced or translated to another language without prior written consent of Good Will Corporation.

The information in this manual was correct at the time of printing. However, Good Will continues to improve its products and therefore reserves the right to change the specifications, equipment, and maintenance procedures at any time without notice.

Good Will Instrument Co., Ltd. No. 7-1, Jhongsing Rd., Tucheng Dist., New Taipei City 236, Taiwan.

SAFETY INSTRUCTIONS

This section contains the basic safety symbols that may appear on the accompanying User Manual CD or on the instrument. For detailed safety instructions and precautions, please see the Safety Instructions chapter in the user manual CD.

Safety Symbols

These safety symbols may appear in the user manual or on the instrument.



Warning: Identifies conditions or practices that could result in injury or loss of life.

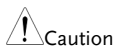

Caution: Identifies conditions or practices that could result in damage to the instrument or to other properties.



DANGER High Voltage



Attention Refer to the Manual



Protective Conductor Terminal



Earth (ground) Terminal



Do not dispose electronic equipment as unsorted municipal waste. Please use a separate collection facility or contact the supplier from which this instrument was purchased.

Power Cord for the United Kingdom

When using the instrument in the United Kingdom, make sure the power cord meets the following safety instructions.

NOTE: This lead/appliance must only be wired by competent persons.



WARNING: THIS APPLIANCE MUST BE EARTHED
IMPORTANT: The wires in this lead are coloured in accordance with the following code:

Green/ Yellow: Earth

Blue: Neutral

Brown: Live (Phase)



As the colours of the wires in main leads may not correspond with the coloured marking identified in your plug/appliance, proceed as follows:

The wire which is coloured Green & Yellow must be connected to the Earth terminal marked with either the letter E, the earth symbol  or coloured Green/Green & Yellow.

The wire which is coloured Blue must be connected to the terminal which is marked with the letter N or coloured Blue or Black.

The wire which is coloured Brown must be connected to the terminal marked with the letter L or P or coloured Brown or Red.

If in doubt, consult the instructions provided with the equipment or contact the supplier.

This cable/appliance should be protected by a suitably rated and approved HBC mains fuse: refer to the rating information on the equipment and/or user instructions for details. As a guide, a cable of 0.75mm² should be protected by a 3A or 5A fuse. Larger conductors would normally require 13A types, depending on the connection method used.

Any exposed wiring from a cable, plug or connection that is engaged in a live socket is extremely hazardous. If a cable or plug is deemed hazardous, turn off the mains power and remove the cable, any fuses and fuse assemblies. All hazardous wiring must be immediately destroyed and replaced in accordance to the above standard.

GETTING STARTED

The Getting Started chapter introduces the instrument's main features, appearance, and set up procedure.

Overview

The PEL-3000(H) Series is a family of high performance DC electronic loads positioned to test a wide range of different power sources. The DC electronic loads are fully programmable to simulate anything from basic static loads to complex dynamic loads. With the ability to operate independently or in parallel, the PEL-3000(H) Series is extremely robust and capable of molding to any test environment.

Model Line Up

Model	Voltage (DC)	Current	Power
PEL-3021(H)	0V~150V/0V-800V	35A/8.75A	175W
PEL-3041(H)	0V~150V/0V-800V	70A/17.5A	350W
PEL-3111(H)	0V~150V/0V-800V	210A/52.5A	1050W
PEL-3211(H) (Booster)	0V~150V/0V-800V	420A/105A	2100W

Main Features

- | | |
|-------------|--|
| Performance | <ul style="list-style-type: none">High slew rates of up to 16A/μS(PEL-3111),0.8A/μS(PEL-3111H) for a fast response speed |
|-------------|--|

-
- High capacity when used in parallel:
5250W, 1050A(262.5A),
PEL-3111(H) x 5)
9450W, 1890A(472.5A),
PEL-3111(H) + PEL-3211(H) x 4)
 - High resolution – 16 bit
-

Features

- 7 operating modes: CC, CV, CR, CP, CC+CV, CR+CV, CP+CV
 - Independent and parallel operation
 - Fully programmable with normal and fast sequences
 - Soft start
 - Dynamic mode
 - OCP, OVP and other protection features
 - Remote sense
 - Integrated meter
 - Rack-mountable
 - Load booster
-

Interface

- USB, RS232 and GPIB
 - External voltage or resistance control
 - Front panel trigger out BNC
 - Front panel current (voltage) monitoring BNC
 - Analog external control
-

Package Contents and Accessories

Standard Accessories

Item	Part Number
User / Programming Manual CD	
Quick Start Guide (this document)	
Load input terminal Cover, M3 screw x1	PEL-011
Terminal fittings: 2 sets of bolts/nuts/springs/washers (type: M8), terminal cover x1 (for PEL-3000H series only), monitor out cover x 1(for PEL-3021H, PEL-3041H, PEL-3111H only)	PEL-012
Flexible terminal cover: 2x rubber sheeting, 4x Velcro fasteners.(for PEL-3211(H)only)	PEL-013
J1/J2 Protection plug x2 (It is installed on the device)	PEL-014
Front terminal washers (M6) x2	61SF-062104N1
Power Cord x1	Region Dependent
300mm Frame Link Cable (for linking units that are stacked). Note that this accessories is optional for the PEL-3021(H)/3041(H)	GTL-255

Optional Accessories

Item	Part Number
Rack mount bracket for booster PEL-3211(H) (EIA + JIS)	GRA-413
Rack mount frame for PEL-3021(H), PEL-3041(H), PEL-3111(H)/EIA	GRA-414-E

Rack mount frame for PEL-3021(H), PEL-3041(H), PEL-3111(H)/JIS	GRA-414-J
GPIB cable, 2.0m	GTL-248
USB cable. Type A - Type B	GTL-246
Dust filter	PEL-010
CR123A 3V lithium battery for clock.	3813-030D0501
Connect Cu Plate	PEL-005
Connect Cu Plate	PEL-006
Connect Cu Plate	PEL-005
Connect Cu Plate	PEL-005
Connect Cu Plate	PEL-005

Front Panel

PEL-3021 and PEL-3041

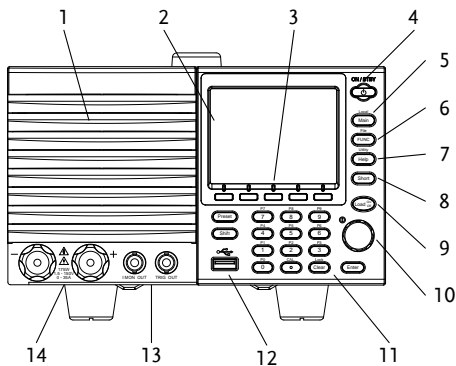

PEL-3021H and PEL-3041H

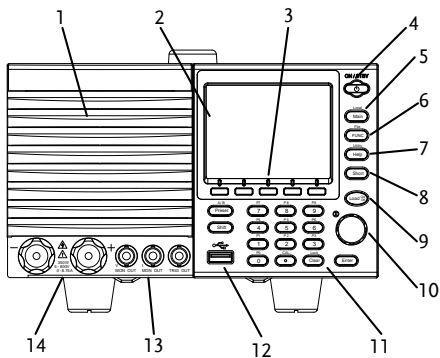

PEL-3111

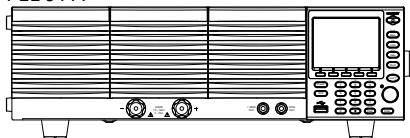

PEL-3111H

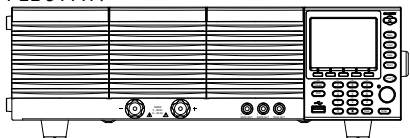

PEL-3211(H) Booster Pack

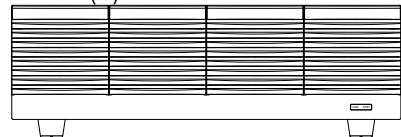

Description

- | | |
|---|--|
| 1. Air inlet | 2. LCD Display |
| 3. Function keys | 4. Power key |
| 5. Main/Local key | 6. FUNC/File key |
| 7. Help/Utility key | 8. Short key |
| 9. Load On/Off | 10. Scroll wheel |
| 11. Number pad, Clear/
Lock and Enter keys | 12. USB port, Preset and
Shift keys |
| 13. I MON OUT and TRIG
OUT(for PEL-3000
series)
I MON OUT, V MON
OUT, TRIG OUT(for
PEL-3000H series) | 14. Input terminals |

Rear Panel

PEL-3021 and PEL-3041

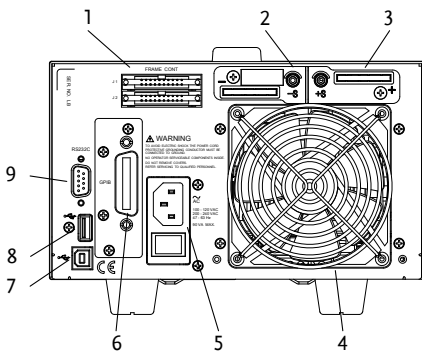

PEL-3021H and PEL-3041H

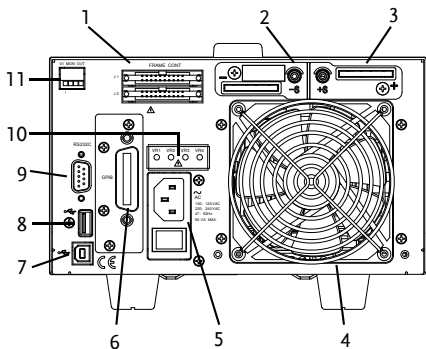

PEL-3111

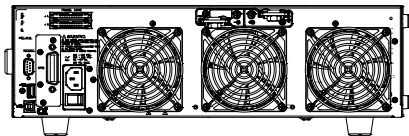

PEL-3111H

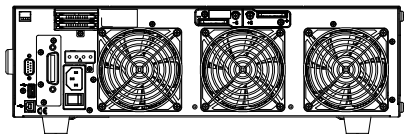

PEL-3211 Booster Pack

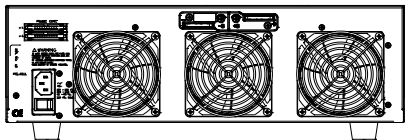

PEL-3211H Booster Pack

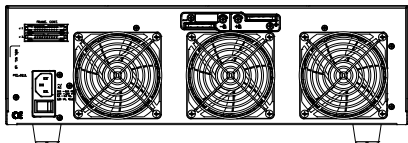

Description

1. Frame control ports, J1, J2
2. Remote sense inputs
3. Rear panel inputs
4. Exhaust fan
5. Power socket and switch
6. GPIB (optional)
7. USB device port
8. USB port
9. RS232C port
10. Variable Resistor
11. Monitor Out ports J3

Display Overview

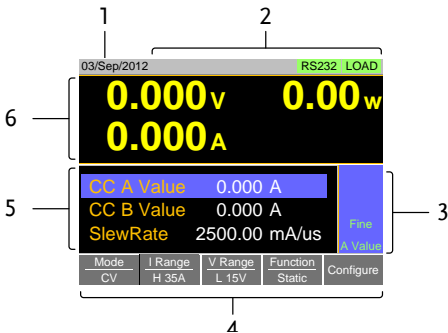

Description

1. Date and time
2. Main frame status panel
3. Operation status panel
4. Soft keys
5. Setting area
6. Measurement area

First Time Use Instructions

Use the following procedures when first using the PEL-3000(H) to power up the instrument, set the internal clock, restore the factory default settings and check the firmware version. Lastly, the Conventions section will introduce you to the basic operating conventions used throughout the user manual.

Power Up

1. Insert the AC power cord into the power socket.
2. Turn the power switch on from the rear panel.
(O → —)

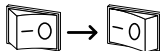

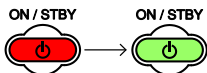

3. If the unit doesn't turn on, press the ON/STBY key on the front panel.
 - The ON/STBY key will go from standby (red) to ON (green).



4. The unit will show the splash screen and then load the settings from when the unit was last powered down.



Load Default Settings

When first using the PEL-3000(H), recall the factory default settings to ensure the unit is in a known state. See the user manual for a list of the default settings.

1. Press  +  .
2. Select *Media/Default* [F1].
3. Select *Factory Default* [F2].
4. Press *Factory Default* [F2] again to confirm.

Setting the Date and Time

The date and time settings are used to time-stamp files when saving files.



1. Press  +  > *Time Set*[F4] to set the date and time.

Settings: Month, Day, Year, Hour, Minute



Updating the Firmware

The PEL-3000(H) allows the firmware to be updated by end-users. Before using the PEL-3000(H), please check the GW Instek website or ask your local distributor for the latest firmware. Before updating the firmware, please check the firmware version.

View Firmware Version

1. Press  + .
2. Select *System/Info*[F1].
3. The system information is listed in the display.
 - Model: PEL-3000(H) model number.
 - Serial Number: XXXXXXXX
 - Firmware Ver.: Firmware version number.
 - Website address.

Firmware update

1. Insert a USB drive into the USB port. Ensure the USB drive has the firmware file located in the root directory.
2. Press  + .
3. Select *USB* with the *Media* [F1] soft-key.
4. Press the *File Utility* [F5] soft-key.
5. Select the *.UPG upgrade file and press *Select*[F1] twice. Once to select the file and once to confirm.
6. Wait for the update to complete and reset the power.



Warning

Do not turn the load generator off or remove the USB memory when the firmware is being read or upgraded.

Conventions

The following conventions are used throughout the user manual. Read the conventions below for a basic grasp of how to operate the PEL-3000(H) menu system using the front panel keys.

Soft-menu keys

The F1 to F5 function keys at the bottom of the display correspond directly to the soft-menu keys on top.

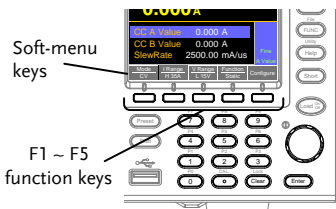

Select Sub Menu

Configure

Pressing this type of soft-menu key will enter a submenu.

Toggle Parameter or State

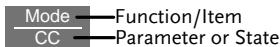

This type of soft-menu icon has the function/item on the top of the label and the selected setting or mode on the bottom of the label.

Repeatedly press the associated function key (F1~F5) to cycle through each setting.

For some parameters, a popup window will also appear. Selection of the setting is the same.

Repeatedly pressing the relevant function key (F1~F5) will cycle through each setting.

Parameter Input

The scroll wheel, Enter key and number pad can be used to edit parameter values.

1. Use the scroll wheel to move the cursor to the desired parameter.
 - A scroll bar is shown when there are additional parameters off-screen.

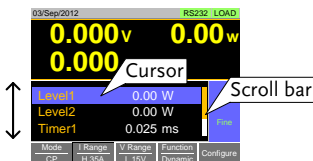

2. Press the  key to select the parameter.
 3. Then use umber pad* or scroll wheel** to edit the parameter value.
-

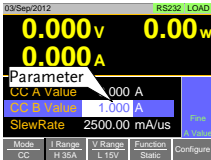

4. Press the Enter key again to finish editing the parameter value.

Clearing a Value

*When editing a parameter with the number pad, pressing the **Clear** key will restore the parameter to the previous value.

Coarse/Fine Adjustment

**When a parameter is highlighted (step 3 above) pressing the scroll wheel will toggle the scroll wheel resolution between fine and coarse.

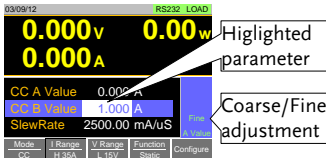

Note: There is a second method of fine adjustment that allows you to edit parameters one digit value at a time using the scroll wheel. This is called Cursor mode. Please see the user manual for more information.

Entering Alphanumeric Characters

When renaming files, creating memos or notes, you will be required to enter alphanumeric characters when the character entry screen appears.

- Only alphanumeric characters as well as space [], underscore [_] and minus [-] characters are allowed.
1. Use the scroll wheel to move the cursor to the desired character.

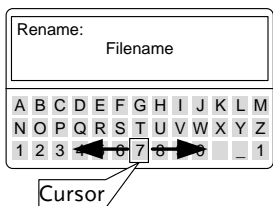

2. Press the **Enter** key or *Enter Character*[F1] to select a character.
3. To delete a character, press *Back Space*[F2].
4. To save the file name or memo, press *Save*[F3].

SPECIFICATIONS

The following are the basic specifications for the PEL-3000(H) series. For detailed specifications, please see the user manual

Rating

Model	PEL-3021 (H)	PEL-3041 (H)	PEL-3111 (H)
Voltage	0V-150V(0V/800V)		
Current	35A(8.75A)	70A(17.5A)	210A(52.5A)
Min. Operating Voltage	1.5V at 35A (5V at 8.75A)	1.5V at 70A (5V at 17.5A)	1.5V at 210A (5V at 52.5A)
Power	175W	350W	1050W

CC Mode Operating Range

Model	PEL-3021 (H)	PEL-3041 (H)	PEL-3111 (H)
H Range	0A-35A (0-8.75A)	0A-70A (0-17.5A)	0A-210A (0-52.5A)
M Range	0A-3.5A (0-875mA)	0A-7A (0-1.75A)	0A-21A (0-5.25A)
L Range	0A-0.35A (0-87.5mA)	0A-0.7A (0-175mA)	0A-2.1A (0-525mA)

CR Mode Operating Range

Model	PEL-3021 (H)	PEL-3041 (H)	PEL-3111 (H)
H Range	23.3336S-400 μ S (42.857m Ω - 2.5k Ω)/(H) 1.75S-30 μ S (571m Ω -33.3k Ω)	46.6672S-800 μ S (21.428m Ω -1.25k Ω)/(H) 3.5S-60 μ S (285m Ω -16.6k Ω)	140.0016S~2.4mS (7.1427m Ω - 416.6667 Ω)/(H) 10.5S-200 μ S (95.2m Ω -5k Ω)
M Range	2.33336S-40 μ S (428.566m Ω -25k Ω)/(H) 175mS-3 μ S (5.71m Ω -333M Ω)	4.6667S-80 μ S (214.28m Ω -12.5k Ω)/(H) 35mS-6 μ S (2.85m Ω -166k Ω)	14.0001S-242.4 μ S (71.427m Ω -4.16667k Ω)/(H) 1.05S-20 μ S (952m Ω -50k Ω)

L Range	0.233336S-4 μ S (4.28566 Ω -250k Ω) / (H)	0.46667S-8 μ S (2.1428 Ω -125k Ω) / (H)	1.40001S-24.24 μ S (714.27m Ω -41.6667k Ω) / (H)
	17.5mS-0.3 μ S (57.1 Ω -3.33M Ω)	35mS-0.6 μ S (28.5 Ω -1.66k Ω)	105mS-2 μ S (9.52 Ω -500k Ω)

CV Mode Operating Range

Model	PEL-3021 (H)	PEL-3041 (H)	PEL-3111 (H)
H Range	1.5V-150V (5V-800V)	1.5V-150V (5V-800V)	1.5V-150V (5V-800V)
M Range	1.5V-15V (5V-80V)	1.5V-15V (5V-80V)	1.5V-15V (5V-80V)

CP Mode Operating Range

Model	PEL-3021 (H)	PEL-3041 (H)	PEL-3111 (H)
H Range	17.5W ~175W	35W~350W	105W ~1050W
M Range	1.75W ~17.5W	3.5W~35W	10.5W ~105W
L Range	0.175W~1.75W	0.35W~3.5W	1.05W ~10.5W

Slew Rate CC Mode Setting Range

Model	PEL-3021 (H)	PEL-3041 (H)	PEL-3111 (H)
H Range	2.5mA/ μ s -2.5A/ μ s(H) 0.1400mA/ μ s- 140.0mA/ μ s	5mA/ μ s -5A/ μ s(H) 0.280mA/ μ s- 280.0mA/ μ s	16.02mA/ μ s -16.002A/ μ s (H)0.840mA/ μ s- 840.0mA/ μ s
M Range	250uA/ μ s- 250mA/ μ s(H) 0.01400mA/ μ s- 14.000mA/ μ s	500uA/ μ s- 500mA/ μ s(H) 0.0280mA/ μ s- 28.00mA/ μ s	1.602mA/ μ s -1.6002A/ μ s(H) 0.0840mA/ μ s- 84.00mA/ μ s
L Range	25uA/ μ s -25mA/ μ s(H) 1.400 μ A/ μ s- 1400.0 μ A/ μ s	50uA/ μ s -50mA/ μ s(H) 2.80 μ A/ μ s- 2800 μ A/ μ s	160.2uA/ μ s -160.02mA/ μ s (H)0.00840mA/ μ s- 8.400mA/ μ s

Slew Rate CR Mode Setting Range

Model	PEL-3021 (H)	PEL-3041 (H)	PEL-3111 (H)
H Range	250 μ A/ μ s	500 μ A/ μ s	1.602mA/ μ s
	-250mA/ μ s(H)	-500mA/ μ s(H)	-1.6002A/ μ s(H)
	0.01400mA/ μ s	0.0280mA/ μ s-	0.0840mA/ μ s-
	-14.000mA/ μ s	28.00mA/ μ s	84.00mA/ μ s
M Range	25 μ A/ μ s	50 μ A/ μ s	160.2 μ A/ μ s
	-25mA/ μ s(H)	-50mA/ μ s(H)	~160.02mA/ μ s
	0.001400mA/ μ s	0.00280mA/ μ s-	(H)0.0840mA/ μ s-
	s-1.4000mA/ μ s	2.800mA/ μ s	s-8.400mA/ μ s
L Range	2.5 μ A/ μ s	5 μ A/ μ s	16.02 μ A/ μ s
	-2.5mA/ μ s(H)	-5mA/ μ s(H)	-16.002mA/ μ s
	0.1400 μ A/ μ s-	0.280 μ A/ μ s-	(H)0.00840mA/ μ s-
	140.00 μ A/ μ s	280.0 μ A/ μ s	μ s-0.8400mA/ μ s

EC Declaration of Conformity (PEL-3000 series)

We

GOOD WILL INSTRUMENT CO., LTD.

No.7-1, Jhongsing Rd., Tucheng Dist., New Taipei City 236, Taiwan

PEL-3021, PEL-3041, PEL-3111

satisfies all the technical relations application to the product within the scope of council:

Directive: 2014/30/EU; 2014/35/EU; 2011/65/EU; 2012/19/EU

The above product is in conformity with the following standards or other normative documents:

◎ EMC

EN 61326-1 : EN 61326-2-1: EN 61326-2-2:	Electrical equipment for measurement, control and laboratory use — EMC requirements (2006)
Conducted and Radiated Emissions EN 55011: 2009+A1: 2010	Electrical Fast Transients EN 61000-4-4: 2012
Current Harmonic EN 61000-3-2: 2014	Surge Immunity EN 61000-4-5: 2006
Voltage Fluctuation EN 61000-3-3: 2013	Conducted Susceptibility EN 61000-4-6: 2014
Electrostatic Discharge EN 61000-4-2: 2009	Power Frequency Magnetic Field EN 61000-4-8: 2010
Radiated Immunity EN 61000-4-3: 2006 +A1: 2008+A2: 2010	Voltage Dips/ Interrupts EN 61000-4-11: 2004

◎ Safety

Low Voltage Equipment Directive 2006/95/EC
Safety Requirements: EN 61010-1: 2010; EN 61010-2-030: 2010

GOOD WILL INSTRUMENT CO., LTD.

No. 7-1, Jhongsing Road, Tucheng Dist., New Taipei City 236,
Taiwan

EC Declaration of Conformity (PEL-3000H series)

We

GOOD WILL INSTRUMENT CO., LTD.

No.7-1, Jhongsing Rd., Tucheng Dist., New Taipei City 236, Taiwan

PEL-3021H, PEL-3041H, PEL-3111H

satisfies all the technical relations application to the product within the scope of council:

Directive: 2014/30/EU; 2014/35/EU; 2011/65/EU; 2012/19/EU

The above product is in conformity with the following standards or other normative documents:

◎ EMC

EN 61326-1 : EN 61326-2-1: EN 61326-2-2:	Electrical equipment for measurement, control and laboratory use — EMC requirements (2006)
Conducted and Radiated Emissions EN 55011: 2009+A1: 2017 ClassA	Electrical Fast Transients EN 61000-4-4: 2012
Current Harmonic EN 61000-3-2: 2014	Surge Immunity EN 61000-4-5: 2006
Voltage Fluctuation EN 61000-3-3: 2013	Conducted Susceptibility EN 61000-4-6: 2014
Electrostatic Discharge EN 61000-4-2: 2008	Power Frequency Magnetic Field EN 61000-4-8: 2010
Radiated Immunity EN 61000-4-3: 2006 +AMD2: 2010	Voltage Dips/ Interrupts EN 61000-4-11: 2004

◎ Safety

Low Voltage Equipment Directive 2006/95/EC
Safety Requirements: EN 61010-1: 2010; EN 61010-2-030: 2010

GOOD WILL INSTRUMENT CO., LTD.

No. 7-1, Jhongsing Road, Tucheng Dist., New Taipei City 236,
Taiwan