

RA3100

Omniace

Communication command

Instruction Manual



CAUTION

- (1) Turn off the power when an error occurs with the product.
If it is not possible to trace the cause of a problem, please contact our sales representative.
- (2) The contents of this manual are subject to change without notice.
- (3) This manual is copyrighted with all rights reserved. This manual may not be reproduced, modified, or translated without the written permission of A&D Company, Limited. No parts of this manual may be transcribed without permission.
- (4) Please let us know if any points are unclear or missing in this manual.
- (5) A&D Company, Limited. will not be held responsible for any damages or loss of income caused by the operation of this device or any direct, indirect, special, or inevitable damages caused by defects in the product, even if there is notice that the corresponding damages may occur. We will also not be held responsible for any third-party claims of rights. At the same time, we will not be held responsible for any loss of data. We will not be held responsible for any issues that arise that are caused by problems with the manual.

© 2022 A&D Company, Limited.

- Omnice is a registered trademark of A&D Company, Limited.
- Microsoft, Windows and Windows 10 IoT are trademarks or registered trademarks of Microsoft Corporation in the United States and other countries.
- Software owned by Adobe Corporation in the United States is used based on the SIL Open Font License.
- Product names and company names in this manual are trademarks or registered trademarks of their respective owners in Japan and other countries.

Introduction

We thank you for your purchase of our data acquisition product OMNIACE RA3100 (hereinafter "the RA3100" or "this product").

This instruction manual explains how to use the communication interface and the communication commands when controlling communication using the LAN interface or the RS-232C interface.

Please read this manual carefully to use this product correctly before using this product.

Please read this instruction manual, which is provided on the included CD, as it gives details of the functions and operations of the input module and the RA3100. Concerning the operation of the host computer connected to the interface, please read the corresponding manual that should be provided with the host computer.

If you have questions or are unsure of the instructions given in this manual, please contact us.











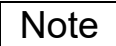

<Instruction manual>

Name	Descriptions
RA3100 instruction manual	Operations and settings of parameters for RA3100 are described.

Symbols in This Manual

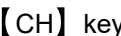
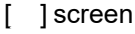
Terms and symbols used in this manual denote as follows.

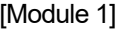
 WARNING	This indicates a condition or practice that could result in personal injury or loss of life, or may result in light injury or physical damage if this equipment is misused due to neglect of a Warning.
 CAUTION	This indicates a condition or practice that could result in light injury or damage to the equipment or other property if this equipment is misused due to neglect of a Caution.
 Note	This indicates a condition or practice that could result in incorrect operation or damage to data if this equipment is misused due to neglect of a Note, as well as measurement limitations and additional explanations.
	Reference page
	A tap is the act of lightly touching an item such as a key displayed on the screen with a finger. Example: Used for selecting or setting screen keys.
 key	Enclosed characters represent a key name on the operation panel. Example:  key
 key	Text enclosed in  indicates touch panel keys displayed on the screen. Example:  key
 screen	Text enclosed in  indicates the text of items on the screen. Example: 
k (lower case) K (upper case)	Example: 1 kg = 1000 g 1 KB = 1024 bytes

Contents

Introduction	3
<Instruction manual>	3
Symbols in This Manual.....	3
1. Communication settings.....	6
1.1. Preparing the product.....	6
1.1.1. Connections of communication ports	6
1.1.2. Network setup for LAN port.....	7
1.1.3. Communication parameters of RS-232C (COM port)	9
2. Overview of communication commands	10
2.1. Communication format.....	10
2.1.1. Command format.....	10
2.1.2. ACK and NAK.....	10
2.1.3. Communication protocol.....	12
2.2. Command List	13
2.2.1. Command groups	13
2.2.2. Command List	13
3. Details of command	15
3.1. Settings of main unit (S commands)	15
3.1.1. S01: Setting common recording format	15
3.1.2. S02: Setting recording format using memory	17
3.1.3. S03: Setting recording format using SSD	19
3.1.4. S04: Setting recording format using printer	20
3.1.5. S21: Setting start-trigger format (using analog input signal)	21
3.1.6. S22: Setting start-trigger format (using digital input signal)	22
3.1.7. S24: Setting memory-trigger format (using analog input signal)	23
3.1.8. S25: Setting memory-trigger format (using logical input signal)	24
3.1.9. S26: Setting format of memory-trigger mode.....	25
3.1.10. S30: Setting format of channel display	26
3.1.11. S31: Setting display format of logical input signal	28
3.1.12. S32: Setting format of physical quantity conversion	30
3.1.13. S33: Setting format of unit list.....	31
3.1.14. S34: Setting recoding name	32
3.1.15. S35: Setting thumbnail monitor.....	33
3.1.16. S36: Setting parameters to print out.....	34
3.1.17. S37: Setting header, footer and annotation	35
3.1.18. S38: Setting speed to feed recording paper	36
3.1.19. S39: Setting Y-T waveform monitor	37
3.1.20. S40: Setting X-Y waveform.....	38
3.1.21. S41: Setting X-Y waveform channel	39
3.1.22. S42: Setting FFT analysis.....	40
3.1.23. S43: Partition settings of waveform monitor	43
3.1.24. S44: Setting field length	44
3.1.25. S45: Setting recording information XML file output	44
3.1.26. S46: Setting number of partitions	45

3.2.	Module setting (M commands).....	46
3.2.1.	M01: Module setting two channel voltage (RA30-101).....	46
3.2.2.	M02: Module setting four channel voltage (RA30-102).....	47
3.2.3.	M03: Module setting two channel high-speed voltage (RA30-103).....	48
3.2.4.	M05: Module setting 16 channel logic (RA30-105).....	49
3.2.5.	M06: Module setting two channel temperature (RA30-106).....	50
3.2.6.	M12: Module setting remote control (RA30-112).....	52
3.3.	Reading information (I commands).....	54
3.3.1.	I00: Reading information of main unit, type, serial No.	54
3.3.2.	I04: Reading board information of input module.....	54
3.3.3.	I05: Reading the status of main unit.....	55
3.4.	Execution process (E commands).....	56
3.4.1.	E01: Execute canceling the input offset (zero-cancel).....	56
3.4.2.	E07: Execute start and end recording.....	56
3.4.3.	E15: Execute adjust paper feed.....	57
3.4.4.	E16: Execute print header, footer and annotation.....	57
4.	Specifications of hardware.....	58
4.1.	LAN port.....	58
4.2.	COM port.....	58

1. Communication settings

The RA3100 is equipped with an interface with a LAN port and a COM port (RS-232C), which are used to connect to peripherals.

LAN port is 1000BASE-T, 100BASE-TX and 10BASE-T in accordance with IEEE802.3.

Cables conforming to the relevant standards of the connections should be used.

Use crossover cables when directly connecting to a computer using RS-232C.

1.1. Preparing the product

1.1.1. Connections of communication ports

The interface is mounted on the rear panel of the RA3100. Connect a cable to the LAN port when using ethernet. Connect a cable to the RS-232C when using COM port.

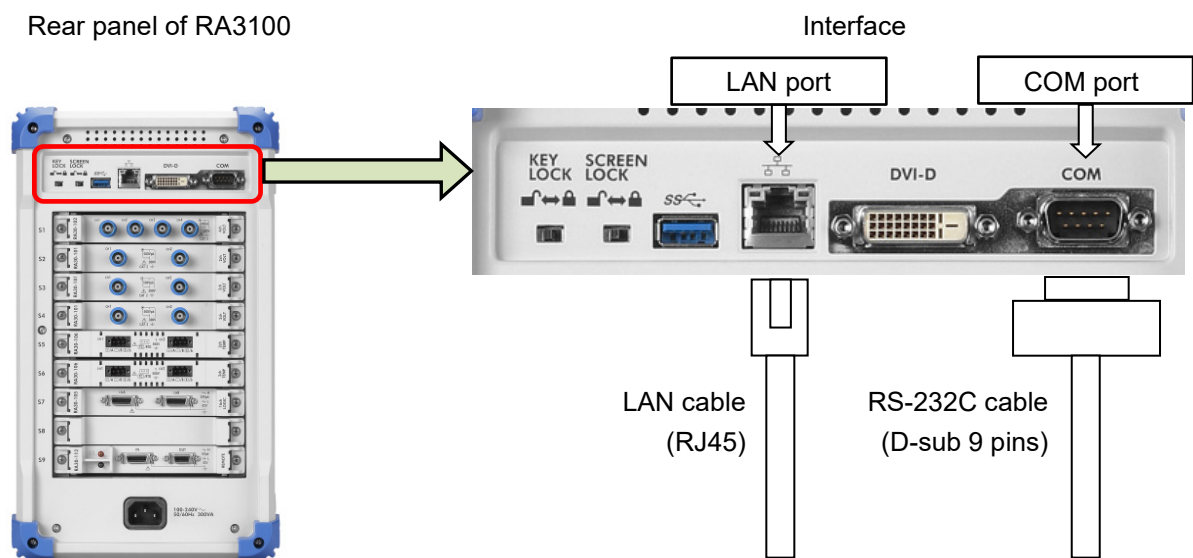

Connection using LAN cable

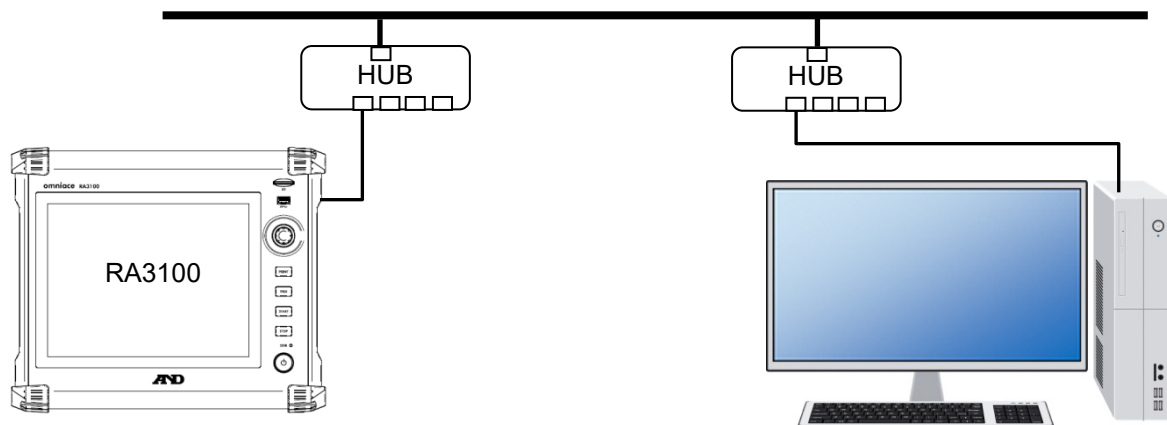

Connection using RS-232C cable

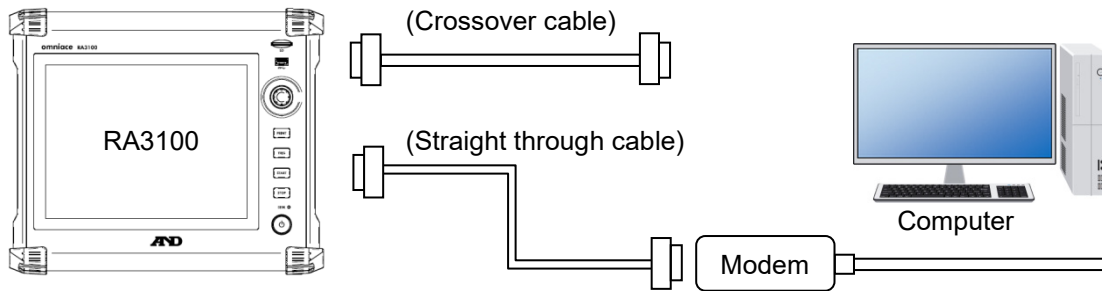

Use crossover cable when connecting to computer, DTE device and others using RS-232C.
Use straight through cable when connecting to DCE device.

1.1.2. Network setup for LAN port

This section describes for setup of LAN port.

The current settings are displayed by the following procedure.

Step 1 Tap **【 Setup 】** key of the **"side menu"** on the display block.

Step 2 Tap **【 Environment 】** key of **"Main unit setup"** item of the [Setup] screen.

Step 3 Tap the network **【 Edit 】** key on the [Comm.] setup screen.

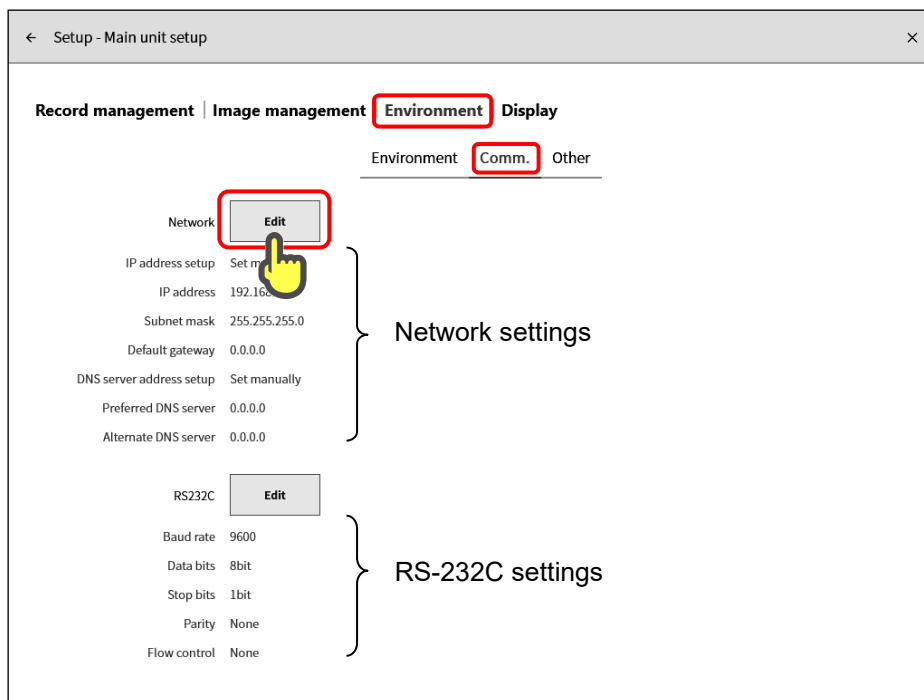

When tapping the network **【 Edit 】** key, the network setup dialog box is displayed.
Consult a network manager for the settings when connecting to an ethernet network.

(1) IP address setup:

Select whether to "obtain automatically" or "set manually".

When "obtain automatically" is selected, IP address is set automatically by the DHCP server on the network. Then, the address of the DNS server is set automatically because automatic setup of the DNS server is enabled.

When "set manually" is selected, IP address, subnet mask, gateway and DNS server address needs to be set manually.

(2) IP address:

Specify an IP address that is a unique number on the network and consists of a network address + device address if "obtain automatically" is selected.

Example:

IP address of the RA3100 is set to "192.168.0.1". IP address of computer is set to "192.168.0.10".

(3) Subnet mask:

The value that defines the IP address range (subnet).

In the case of "192.168.0.1", the subnet mask should be set to "255.255.255.0".

(4) Default gateway:

Sets the IP address of the gateway device for connecting the network that the product is connected to with external networks.

(5) Preferred DNS server:

Sets the IP address of the preferred DNS server on the network. The DNS server converts automatically domain name to IP address.

(6) Alternate DNS server:

Sets the IP address of the alternate DNS server on the network.

Network setup dialog box

The screenshot shows a 'Network' dialog box with the following fields and values:

- (1) IP address setup: Set manually (dropdown)
- (2) IP address: 192, 168, 0, 1
- (3) Subnet mask: 255, 255, 255, 0
- (4) Default gateway: 0, 0, 0, 0
- (5) DNS server address setup: Set manually
- (6) Preferred DNS server: 0, 0, 0, 0
- Alternate DNS server: 0, 0, 0, 0

Buttons: OK, Cancel

Note

Specify port number "3000" when using the LAN port to communicate with an external device.

1.1.3. Communication parameters of RS-232C (COM port)

The current settings are displayed by the following procedure.

Step 1 Tap **【 Setup】** key of the "**side menu**" on the display block.

Step 2 Tap **【 Environment】** key of "**Main unit setup**" item of the [Setup] screen.

Step 3 Tap the [RS-232C] **【 Edit】** key on the [Comm.] setup screen.

When using the RS-232C port of this product to communicate with an external device, match the RS-232C settings with those of the host device.

(1) Baud rate:

Sets the RS-232C data transmission speed.

300 / 600 / 1200 / 2400 / 4800 / 9600 / 14400 / 19200 /
38400 / 57600 / 115200 / 230400 / 460800 bps

(2) Data bits:

The number of bits in one byte of data. Fixed to 8 bits.

(3) Stop bits:

The stop bits in one byte of data. Select 1 or 2 bits.

(4) Parity:

The parity bit for one byte of data.

None, odd, even, mark, or space

(5) Flow control:

The flow control of communication using CTS/RTS.

None, Xon/Xoff, or Hardware

RS-232C setup dialog box

The screenshot shows a dialog box titled "RS232C" with the following settings:

- (1) Baud rate: 9600
- (2) Data bits: 8bit
- (3) Stop bits: 1bit
- (4) Parity: None
- (5) Flow control: None

At the bottom of the dialog box are two buttons: "OK" and "Cancel".

2. Overview of communication commands

When this product is connected to a host machine via LAN or RS-232C and receives a command from the host machine, it executes the process according to the command. LAN is TCP/IP socket communication, and RA3100 communicates as a server.

⚠ CAUTION
<ul style="list-style-type: none"> ❑ When communicating, there is no particular distinction between LAN or RS-232C communication ports, and processing is performed when a command is received. However, if commands are received from both ports at the same time, it may cause malfunctions to occur, so only one of the communication ports should be used. ❑ Use ASCII and UTF-8 codes for communication of the RA3100. Characters of JIS, SJIS, EUC codes and others become a garbled text.

2.1. Communication format

2.1.1. Command format

The string of the command consists of 3-character command, parameter strings and delimiter.

Command and parameter strings are separated with a space [0x20].

Multiple parameters are separated with comma "," [0x2C].

Place CR [0x0D] and LF [0x0A] delimiters at the end of a command.

Enclose the string parameter of a signal name etc. with STX [0x02] and ETX [0x03].

Use ASCII and UTF-8 codes for the string parameter of a signal name etc.

Place a comma "," [0x2C] when omitting a parameter.

Place CR [0x0D] and LF [0x0A] delimiters when omitting a parameter and the strings after that parameter.

Exponential, decimal and integer notation can use when exponential notation is used in a parameter description.

Format:

Command (3-characters)	(SP)	Parameters P1, P2, ...	Delimiter (CR)(LF)
------------------------	------	------------------------	--------------------

Example: S01(SP)0,1,0,60000(CR)(LF)
 S30(SP)1,1,(STX)SIG-NAME(ETX),1,50,50,-100,100,1(CR)(LF)

2.1.2. ACK and NAK

When command is received and is performed correctly, ACK [0x06] (Acknowledgement) is responded.

When an error occurs in receiving or performing command, NAK [0x15] (Negative Acknowledgement) is responded.

ACK (Normal response)

Format1: Standard ACK

ACK (3-characters)	(SP)	Command (3-characters)	Delimiter (CR)(LF)
--------------------	------	------------------------	--------------------

Command name is responded if correct process.

Format2: ACK with data

ACK	(SP)	Command	(,)	Reponse1, response2, ...	(CR)(LF)
-----	------	---------	-----	--------------------------	----------

Processing with output information returns that information as response output.

Multiple outputs are separated using a comma ",".

Format3: ACK with binary data

ACK	(SP)	Command	(,)	Size	(,)	Binary data	(CR)(LF)
-----	------	---------	-----	------	-----	-------------	----------

When output data is binary, data size (byte length of data) is added to output response data.

Serial communication of RS-232C does not output binary data.

NAC (Error response)

When a command can be received correctly but cannot be performed, NAK is responded.

Format:

NAK(3-characters)	(SP)	Command	(,)	Error number	(,)	Parameter number	(CR)(LF)
-------------------	------	---------	-----	--------------	-----	------------------	----------

The first three characters are the NAK of the error response, then the separator (SP) is placed, and then the three characters of the command name, error number, and parameter number where the error occurred are output. Each item is separated by a comma (,).

When a command cannot be identified, an alternative header is output instead of a command name.

Alternative header:

Header	Descriptions
HAD	3-character command could not be recognized.
DEL	Delimiter could not be recognized within default length of receiving data.
FMT	Syntax error.
BSY	Command busy status.

Error number:

Error number and descriptions are as follows:

When an error occurs, the following error numbers are replied as a parameter of NAK.

() means system error inside of the RA3100.

Error number	Descriptions
1	Command busy.
2	Settings cannot be changed because recording is continued.
3	Unknown command.
4	Parameter is out of range.
5	Number of parameters is incorrect.
6	Time out.
7	(Unknown device)
8	(Common memory error)
9	Deficiency of required parameter.
10	Storage device has been filled.
11	Full memory.
12	(Internal bus error)
13	Execution failure.

Parameter number:

Parameter number shows which parameter in receiving command has failed.
 "-1" is replied to parameter number if it cannot be identified.

2.1.3. Communication protocol

When the host computer sends a command and the RA3100 has received, ACK or NAK is replied to the computer. Send next command from the host computer after receiving and confirming them.

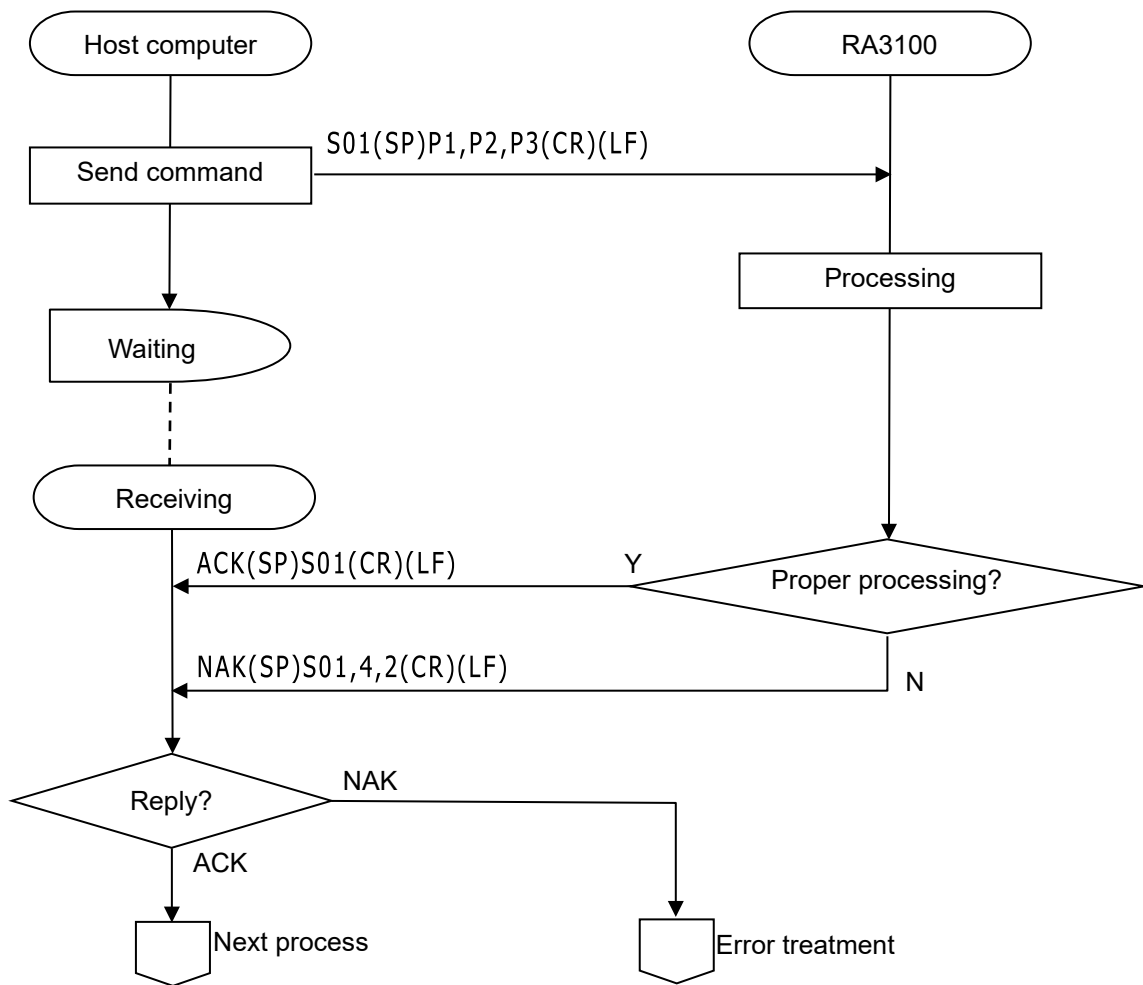

2.2. Command List

First character of 3-character command shows type of command. Other characters show content of command.

Example : S04

S : S command

04 : Settings of recording printer

2.2.1. Command groups

Types of command are as follows:

First character	Descriptions	Details
S	S command : Settings of main unit	3.1. Settings of main unit
M	M command : Settings of modules	3.2 Settings of modules
I	I command : Reading information	3.3 Reading informations
E	E command : Execution process	3.4 Execution peocess

2.2.2. Command List

Settings of main unit (S commands)

Command	Descriptions	Details
S01	Setting common recording format	S01
S02	Setting recording format using memory	S02
S03	Setting recording format using SSD	S03
S04	Setting recording format using printer	S04
S21	Setting start-trigger format (using analog input signal)	S21
S22	Setting start-trigger format (using digital input signal)	S22
S24	Setting memory-trigger format (using analog input signal)	S24
S25	Setting memory-trigger format (using logical input signal)	S25
S26	Setting format of memory-trigger mode	S26
S30	Setting format of channel display	S30
S31	Setting display format of logical input signal	S31
S32	Setting format of physical quantity conversion	S32
S33	Setting format of unit list	S33
S34	Setting recoding name	S34
S35	Setting thumbnail monitor	S35
S36	Setting parameters to print out	S36
S37	Setting header, footer and annotation	S37
S38	Setting speed to feed recording paper	S38
S39	Setting Y-T waveform monitor	S39
S40	Setting X-Y waveform	S40
S41	Setting X-Y waveform channel	S41
S42	Setting FFT analysis	S42
S43	Setting for partition of waveform monitor	S43
S44	Setting field length	S44
S45	Setting recording information XML file output	S45
S46	Setting number of partitions	S46

Module setting (M commands)

Command	Descriptions	Details
M01	Module setting two channel voltage (RA30-101)	M01
M02	Module setting four channel voltage (RA30-102)	M02
M03	Module setting two channel high-speed voltage (RA30-103)	M03
M05	Module setting 16 channel logic (RA30-105)	M05
M06	Module setting two channel temperature (RA30-106)	M06
M12	Module setting remote control (RA30-112)	M12

Reading informations (I commands)

Command	Descriptions	Details
I00	Reading information of main unit, type, serial No. etc.	I00
I04	Reading board information of input module	I04
I05	Reading the status of main unit	I05

Executions process (E commands)

Command	Descriptions	Details
E01	Execute cancel input offset (zero-cancel)	E01
E07	Execute start and end recording	E07
E15	Execute adjust paper feed	E15
E16	Execute print header, footer and annotation	E16

3. Details of command

3.1. Settings of main unit (S commands)

3.1.1. S01: Setting common recording format

Command	S01	
Syntax	S01 P1,P2, • • • ,P13(CR)(LF)	P7 is omitted always
ACK	Standard ACK	
NAK	Standard NAK	
Remarks	The common settings for recording of main unit. Refer to " 8.1 Recording Setup " in the instruction manual of the RA3100.	

Parameters

P1	Recording mode	
Data range	0 to 8 0 : Basic 1 : Start time 2 : START trigger 3 : Interval time 4 : Start time + START trigger 5 : START trigger + Interval time 6 : Start time + Interval time 7 : Start time + START trigger + Interval time 8 : Window record	
Remarks		

P2	Record number of interval time mode	
Data range	1 to 10000	
Remarks	Available number of settings is different due to recording time, type of recording media and remaining capacity of SSD.	

P3	Maximum recording time	
Data range	0 or 1 0 : Invalid 1 : Effective	
Remarks	If effective, recording time is maximum time that can be used remaining capacity of SSD at starting time. In this case, maximum time is calculated with remaining capacity, "sampling rate" and "number of recordings". If invalid, value of recording time is used.	

P4	Recording time	
Data range	1 to 8640000000 Specify each recording time in unit of millisecond.	
Remarks	Range of recording time varies by remaining capacity, "sampling rate" and "number of recordings". Maximum recording time is 100 days. If recording time beyond the maximum time is specified, it becomes error.	

P5	Point number of recording using external sampling				
Data range	0 to 16 0 : 2 k 4 : 50 k 8 : 1 M 12 : 20 M 16 : 500 M 1 : 5 k 5 : 100 k 9 : 2 M 13 : 50 M 2 : 10 k 6 : 200 k 10 : 5 M 14 : 100 M 3 : 20 k 7 : 500 k 11 : 10 M 15 : 200 M Unit is number of points				
Remarks	When EXT (external sampling) is used to SSD recording, recording time is used this number of points.				

3.Details of commands – 3.1.Settings of main unit (S commands)

P6	Interval time
Data range	1 to 86400 Specify interval time in unit of seconds.
Remarks	1 day = 86400 sec 1 hour = 3600 sec 1 minute = 60 sec

P7	(Internal reservation)
Data range	Omit always

P8	Start time: Year
Data range	0 to 99
Remarks	Year from 2000 to 2099

P9	Start time: Month
Data range	Month from 1 to 12

P10	Start time: day
Data range	Days from 1 to 31

P11	Start time: Hour
Data range	Hours from 0 to 23

P12	Start time: Minute
Data range	Minutes from 0 to 59

P13	Start time: Second
Data range	Seconds from 0 to 59

3.1.2. S02: Setting recording format using memory

Command	S02
Syntax	S02 P1,P2, • • • ,P8(CR)(LF) P3 and P7 are omitted always
ACK	Standard ACK
NAK	Standard NAK
Remarks	The settings for memory recording. Refer to " 8.1 Recording Setup " in the instruction manual of the RA3100.

Parameters

P1	Management of memory recording
Data range	0 to 2 0 : Memory recording OFF 1 : Memory recording ON Overwrite mode OFF 2 : Memory recording ON Overwrite mode ON

P2	Sampling speed of memory recording
Data range	0 to 25
Remarks	Refer to " Table of sampling speed " concerning of relationship between parameter number and sampling speed.

P3	(Internal reservation)
Data range	Omit always

P4	Number of memory block
Data range	1 to 200
Remarks	Specify number to divide memory

P5	Block size of memory recording (number of points)
Data range	0 to 18 0 : 2 k 4 : 50 k 8 : 1 M 12 : 20 M 16 : 500 M 1 : 5 k 5 : 100 k 9 : 2 M 13 : 50 M 17 : 1 G 2 : 10 k 6 : 200 k 10 : 5 M 14 : 100 M 18 : 2 G 3 : 20 k 7 : 500 k 11 : 10 M 15 : 200 M Unit is number of points
Remarks	Block size is number of recording data for each channel.

P6	Pre-trigger
Data range	0 to 99
Remarks	Specify position of pre-trigger in unit of %.

P7	(Internal reservation)
Data range	Omit always

P8	Synchronization control trigger for monitor
Data range	0 or 1 0 : Disabled 1 : Enabled
Remarks	Specify synchronization trigger (TRIG SYNC) to monitor waveform stored in memory.

Table of sampling speed for memory recording

P2	Sampling
0	6 s
1	3 s
2	1.2 s
3	1 s
4	500 ms
5	200 ms
6	100 ms

P2	Sampling
7	50 ms
8	20 ms
9	10 ms
10	5 ms
11	2 ms
12	1 ms
13	500 μ s

P2	Sampling
14	200 μ s
15	100 μ s
16	50 μ s
17	20 μ s
18	10 μ s
19	5 μ s
20	2 μ s

P2	Sampling
21	1 μ s
22	500 ns
23	200 ns
24	100 ns
25	50 ns

3.1.4. S04: Setting recording format using printer

Command	S04	
Syntax	S04 P1,P2, • • • ,P5(CR)(LF)	P3 is always omitted.
ACK	Standard ACK	
NAK	Standard NAK	
Remarks	The settings for printer recording. Refer to " 8.1 Recording Setup " in the instruction manual of the RA3100.	

Parameters

P1	Management of printer recording	
Data range	0 or 1	0 : OFF 1 : ON

P2	Paper feed speed	
Data range	0 to 12, 63	
Remarks	Refer to " Table of paper feed speed " concerning relationship between parameter number and paper feed speed. When paper feed speed is set to EXT (external synchronization), SSD recording memory and recording become OFF.	

P3	(Internal reservation)	
Data range	Omit always	

P4	Real time printing of waveform	
Data range	0 or 1	0 : OFF 1 : ON
Remarks	When real time printing is used, waveform is printed at the same time as printer recording (SSD recording).	

P5	Sheet number of printing	
Data range	1 to 3	Sheet number of real time waveform printing

Table of paper feed speed

P2	Paper feed speed
0	1 mm/min
1	2 mm/min
2	5 mm/min
3	6 mm/min
4	12 mm/min
5	30 mm/min

P2	Paper feed speed
6	1 mm/s
7	2 mm/s
8	5 mm/s
9	10 mm/s
10	20 mm/s
11	50 mm/s
12	100 mm/s

P2	Paper feed speed
63	EXT

3.1.6. S22: Setting start-trigger format (using digital input signal)

Command	S22
Syntax	S22 P1,P2, • • • ,P7(CR)(LF)
ACK	Standard ACK
NAK	Standard NAK
Remarks	The settings of start trigger in case that trigger source is logical input. Refer to "5.4 Start Trigger" in the instruction manual of the RA3100.

Parameters

P1	Management of start trigger (Logical input channel)
Data range	0 or 1 0 : Invalid 1 : Effective
Remarks	Logical input is specified to start trigger of recording mode. If analog input is selected, set analog input to invalid previously.

P2	Slot number
Data range	1 to 9
Remarks	Specify an input slot number of logical channel to use as start trigger source.

P3	Channel number
Data range	1 to 2 1 : CHA 2 : CHB
Remarks	Specify channel number of trigger source.

P4	Logic channel for trigger detection
Data range	0 to 255
Remarks	Specify logical input channel to detect trigger input. A parameter value is summed up values of CHn to be used trigger input. CH1 : 1 CH2 : 2 CH3 : 4 CH4 : 8 CH5 : 16 CH6 : 32 CH7 : 64 CH8 : 128

P5	Bit pattern
Data range	0 to 255
Remarks	Specify H/L level to detect trigger for each logical channel. A parameter value is summed up values of CHn that detects trigger at H level. CH1 : 1 CH2 : 2 CH3 : 4 CH4 : 8 CH5 : 16 CH6 : 32 CH7 : 64 CH8 : 128

P6	Trigger detection
Data range	0 to 1 0 : OR 1 : AND

P7	Filter time
Data range	1 to 10000000 (10 s) Specify it in unit of μ s
Remarks	Filter time is the same as filter time of analog start trigger.

3.1.8. S25: Setting memory–trigger format (using logical input signal)

Command	S25
Syntax	S25 P1,P2, ••• ,P8(CR)(LF)
ACK	Standard ACK
NAK	Standard NAK
Remarks	The settings of start trigger in case that trigger source is analog input channel. Refer to " 5.2 Memory trigger " in the instruction manual of the RA3100.

Parameters

P1	Trigger source
Data range	1 to 18 1 : T1 2 : T2 ••• 18 : T18 Selection of source

P2	Management of trigger source
Data range	0 or 1 0 : Invalid 1 : Effective
Remarks	Specify either invalid or effective of trigger source (T1 to T18) selected at P1.

P3	Slot number
Data range	1 to 9
Remarks	Specify an input slot number used as trigger source.

P4	Channel number
Data range	1 to 2 1 : CHA 2 : CHB
Remarks	Specify a channel number used as trigger source.

P5	Logic channel
Data range	0 to 255
Remarks	Specify channel used to trigger detection. A parameter value is summed up values of CHn to be used trigger input. CH1 : 1 CH2 : 2 CH3 : 4 CH4 : 8 CH5 : 16 CH6 : 32 CH7 : 64 CH8 : 128

P6	Bit pattern
Data range	0 to 255
Remarks	Specify H/L level to detect trigger for each logical channel. A parameter value is summed up values of CHn that detects trigger at H level. CH1 : 1 CH2 : 2 CH3 : 4 CH4 : 8 CH5 : 16 CH6 : 32 CH7 : 64 CH8 : 128

P7	Trigger detection
Data range	0 to 1 0 : OR 1 : AND
Remarks	Specify trigger detection either OR or AND for each channel of CH1 to CH8.

P8	Filter time
Data range	1 to 10000000 (10 s) Specify it in unit of μ s
Remarks	Filter time is the same as filter time of analog start trigger.

3.1.10. S30: Setting format of channel display

Command	S30
Syntax	S30 P1,P2, • • • ,P9(CR)(LF)
ACK	Standard ACK
NAK	Standard NAK
Remarks	Don't eliminate parameters using delimiter. Refer to "9.1. Two Channel Voltage Module (RA30-101)" in the instruction manual of the RA3100.

Parameters

P1	Slot selection
Data range	1 to 9, F
Remarks	Specify slot number that the target module is installed. If F is specified, all modules are target.

P2	Channel selection
Data range	1 to 9, F 16 Channel Logic Module (RA30-105) 1 : CHA 2 : CHB, F
Remarks	Specify target channel. If F is specified, all channels of modules specified with P1 are target.

P3	Signal name
Data range	Maximum length : 40 characters of UTF-8 code.
Remarks	Insert strings between (STX) [0x02] and (ETX) [0x03].

P4	Color
Data range	1 to 18 1 : Light blue 2 : Pink 3 : Yellow 4 : White 5 : Light green 6 : Purple 7 : Blue 8 : Light yellow-green 9 : Red 10 : Dark gray 11 : Reddish purple 12 : Bright blue 13 : Olive green 14 : Pale yellow-green 15 : Orange 16 : Pale purple 17 : Pale pink 18 : Green
Remarks	Specify waveform color of target channel. When logic module is used, 8 CH of CHA and CAB become the same color.

P5	Display position
Data range	0 to 100
Remarks	Specify the display position of target waveform in unit of percentage.

P6	Display range
Data range	0 to 100
Remarks	Specify the display range of target waveform in unit of percentage.

3.Details of commands - 3.1.Settings of main unit (S commands)

P7 ~ P20	Graph number and display signal from CH2 to CH8.
Data range & Remarks	Refer to data range and remarks of graph number and display signal for CH 1. Graph number for each channel and parameters of display signal are as follows:

	CH1	CH2	CH3	CH4	CH5	CH6	CH7	CH8
Graph number	P5	P7	P9	P11	P13	P15	P17	P19
Display signal	P6	P8	P10	P12	P14	P16	P18	P20

3.1.12. S32: Setting format of physical quantity conversion

Command	S32
Syntax	S32 P1,P2, ••• ,P10(CR)(LF)
ACK	Standard ACK
NAK	Standard NAK
Remarks	P1 and P2 required always. Refer to "8.1.2. Channel List" – "Conversion (Physical Quantity Conversion)" in the instruction manual of the RA3100.

Parameters

P1	Slot selection
Data range	1 to 9, F
Remarks	Specify slot number that the target module is installed. If F is specified, all modules are target.

P2	Channel selection
Data range	1 to 4, F
Remarks	Specify channel of module specified with P1. If F is specified, all channels of modules specified with P1 are target.

P3	Conversion method
Data range	0 to 2 0 : Not used 1 : compensation 2 : 2 points
Remarks	Specify conversion method. Refer to the instruction manual of the RA3100.

P4	Compensation : Gain
Data range	-7.922816E+20 ~ 7.922816E+20
Remarks	Specify offset when conversion method of P3 is selected "1 : Gain".

P5	Compensation : Offset
Data range	-7.922816E+20 to 7.922816E+20
Remarks	Specify offset when conversion method of P3 is selected "1 : Compensation".

P6	2 points : Pre-conversion 1
Data range	-7.922816E+20 to 7.922816E+20
Remarks	Specify value of pre-conversion 1 when conversion method of P3 is selected "2 points".

P7	2 points : Post-conversion 1
Data range	-7.922816E+20 to 7.922816E+20
Remarks	Specify value of post-conversion 1 when conversion method of P3 is selected "2 points".

P8	2 points : Pre-conversion 2
Data range	-7.922816E+20 to 7.922816E+20
Remarks	Specify value of pre-conversion 2 when conversion method of P3 is selected "2 points".

P9	2 points : Post-conversion 2
Data range	-7.922816E+20 to 7.922816E+20
Remarks	Specify value of post-conversion 2 when conversion method of P3 is selected "2 points".

P10	Unit
Data range	0 to 11
Remarks	Specify unit from unit list. 0 is default unit of module.

3.1.13. S33: Setting format of unit list

Command	S33
Syntax	S33 P1,P2, • • • ,P11(CR)(LF)
ACK	Standard ACK
NAK	Standard NAK
Remarks	Insert strings between (STX) [0x02] and (ETX) [0x03]. Use characters of UTF-8 code. Don't eliminate parameters using delimiter. Refer to "8.1.2. Channel List" – "Conversion (Physical Quantity Conversion)" in the instruction manual of the RA3100.

Parameters

P1	Unit 1
Data range	10 characters in maximum.
Remarks	Define unit 1 of unit table.

P2	Unit 2
Data range	10 characters in maximum.
Remarks	Define unit 2 of unit table.

– Abbreviation –

P11	Unit 11
Data range	10 characters in maximum.
Remarks	Define unit 11 of unit table.

3.1.15. S35: Setting thumbnail monitor

Command	S35
Syntax	S35 P1,P2,P3(CR)(LF)
ACK	Standard ACK
NAK	Standard NAK
Remarks	Specify the settings off thumbnail waveform. Refer to " 8.2.1. Record management " in the instruction manual of the RA3100.

Parameters

P1	Slot selection
Data range	1 to 9
Remarks	Specify slot number of the target module that thumbnail waveform is displayed.

P2	Channel selection
Data range	1 to 4
Remarks	Specify channel of the module specified at P1.

P3	Ratio of display scale
Data range	0 to 3 0 : 1/10 1 : 1/20 2 : 1/50 3 : 1/100
Remarks	Specify display magnification of thumbnail waveform.

3.1.16. S36: Setting parameters to print out

Command	S36
Syntax	S36 P1,P2, • • • ,P8(CR)(LF)
ACK	Standard ACK
NAK	Standard NAK
Remarks	Specify parameters of printer. Refer to " 8.1.4. Printer " in the instruction manual of the RA3100.

Parameters

P1	Header
Data range	0 to 3 0 : OFF 1 : Text 2 : Signal name 3 : Text & signal name
Remarks	Specify header contents that is printed upper waveform.

P2	Annotation
Data range	0 to 1 0 : OFF 1 : Text
Remarks	Specify annotation that is printed together with waveform.

P3	Footer
Data range	0 to 3 0 : OFF 1 : Text 2 : Scale value 3 : Text & scale value
Remarks	Specify footer contents that is printed under waveform.

P4	Grid
Data range	0 to 4 0 : OFF 1 : 10 mm STD 2 : 10 mm 3 : 5 mm STD 4 : 5 mm
Remarks	Specify grid pattern of waveform printing.

P5	Date / data name
Data range	0 to 3 0 : OFF 1 : Date 2 : Recording name 3 : Date & recording name
Remarks	Select whether to print date and recording name.

P6	Line number of date / data name
Data range	1 to 86
Remarks	Specify line number that date and recording name are printed.

P7	Trigger / mark
Data range	0 to 1 0 : OFF 1 : ON
Remarks	Specify whether to print trigger/mark or not.

P8	Line number of trigger / mark
Data range	1 to 86
Remarks	Specify line number that trigger/mark is printed.

P9	Time axis
Data range	0 to 1 0 : OFF 1 : ON
Remarks	Select whether to print time axis or not.

P10	Line number of time axis
Data range	1 to 86
Remarks	Specify line number that time axis is printed.

P11	Recording speed
Data range	0 to 2 0 : OFF 1 : Sampling speed 2 : Chart speed
Remarks	Specify printing contents of recording speed.

P12	Line number of recording speed
Data range	1 to 86
Remarks	Specify line number that recording speed is printed.

3.1.17. S37: Setting header, footer and annotation

Command	S37
Syntax	S37 P1,P2,P3(CR)(LF)
ACK	Standard ACK
NAK	Standard NAK
Remarks	Input printing text. Insert strings between (STX) [0x02] and (ETX) [0x03]. Use characters of UTF-8 code. Don't omit parameters. Refer to " 8.1.4. Printer " in the instruction manual of the RA3100. Header, footer and annotation can print using command of " 3.4.4. E16: Printing Header, footer and annotation ".

Parameters

P1	Type of this text
Data range	0 to 2 0 : Header 1 : Annotation 2 : Footer
Remarks	Select P1 before text. It cannot omit.

P2	Line number
Data range	1 to 86
Remarks	Specify line number of this text. It cannot omit.

P3	Text
Data range	60 characters in maximum.
Remarks	Text is printed at line number specified with P2.

Example of command input : Annotation text is printed at 10th line.

S37 1,10,(STX)Title:(ETX)

3.1.18. S38: Setting speed to feed recording paper

Command	S38
Syntax	S38 P1,P2, • • • ,P6(CR)(LF)
ACK	Standard ACK
NAK	Standard NAK
Remarks	Sets the speed table for the user-set paper feed rate used in Pen Recording Mode. Speed index used with parameter and feeding speed are as follows of " Table of speed to feed paper " : Refer to " 8.1.4. Printer " in the instruction manual of the RA3100.

Parameters

P1	User 1
Data range	0 to 12, 26
Remarks	Sets the user settings configuring the paper feed rate for User 1.

P2	User 2
Data range	0 to 12, 26
Remarks	Sets the user settings configuring the paper feed rate for User 2.

– Parameters P3 to P5 use the same data ranges but for Users 3 to 5. –

P6	User 6
Data range	0 to 12, 26
Remarks	Sets the user settings configuring the paper feed rate for User 6.

Table of speed to feed paper

Pn	Speed of feeding paper
0	1 mm/min
1	2 mm/min
2	5 mm/min
3	6 mm/min
4	12 mm/min
5	30 mm/min
6	1 mm/s

Pn	Speed of feeding paper
7	2 mm/s
8	5 mm/s
9	10 mm/s
10	20 mm/s
11	50 mm/s
12	100 mm/s
26	EXT. (0.1 mm/pulse)

3.1.19. S39: Setting Y-T waveform monitor

Command	S39
Syntax	S39 P1,P2,P3, ••• ,P7(CR)(LF)
ACK	Standard ACK
NAK	Standard NAK
Remarks	Specify the display settings concerning of Y-T waveform. Refer to " 8.2.6. Display Setup " in the instruction manual of the RA3100.

Parameters

P1	Grid
Data range	0 to 2 0 : OFF 1 : Dark 2 : Bright
Remarks	Specify grid display of monitor.

P2	Trigger
Data range	0 to 1 0 : OFF 1 : ON
Remarks	Specify trigger detection line display of monitor.

P3	Mark
Data range	0 to 1 0 : OFF 1 : ON
Remarks	Specify mark line display of monitor.

P4	Interlocked waveform to cursor position
Data range	0 to 1 0 : OFF 1 : ON
Remarks	Specify whether to interlock the display position of waveform at cursor position or not.

P5	Search result line
Data range	0 to 1 0 : OFF 1 : ON
Remarks	Specify whether to display search result or not.

P6	Notation of X axis
Data range	0 to 2 0 : OFF 1 : date 2 : Point
Remarks	Specify tick notation of X axis.

P7	TSP/BSP
Data range	0 to 1 0 : OFF 1 : ON
Remarks	When upper part (TSP) and lower part (BSP) of recording paper are extended in Y-T waveform area, select OFF. Refer to " 8.2.6. Display Setup " in the instruction manual of the RA3100.

3.1.20. S40: Setting X-Y waveform

Command	S40
Syntax	S40 P1,P2,P3(CR)(LF)
ACK	Standard ACK
NAK	Standard NAK
Remarks	Specify the display settings concerning of Y-Y waveform. Refer to " 7.3. X-Y Waveform " in the instruction manual of the RA3100.

Parameters

P1	Dot/Line switching
Data range	0 to 1 0 : Dot 1 : Line
Remarks	Switches between rendering the X-Y waveform with dots and rendering it with lines.

P2	Grid display
Data range	0 to 1 0 : OFF 1 : ON
Remarks	Specify grid display of the X-Y waveform.

P3	Display scale
Data range	1 to 4
Remarks	Select scale of the X-Y waveform from X-Y1 to X-Y4.

3.1.21. S41: Setting X-Y waveform channel

Syntax	S41
ACK	S33 P1,P2, • • • ,P5(CR)(LF)
NAK	Standard ACK
NAK	Standard NAK
Remarks	Specify input channel of X axis and Y axis of X-Y waveform. Refer to "7.3. X-Y Waveform" in the instruction manual of the RA3100.

Parameters

P1	X-Y channel
Data range	1 to 4
Remarks	Specify target X-Y channel. Cannot be omitted.

P2	Slot number of Z axis channel
Data range	1 to 9
Remarks	Specify slot number installed module of input channel that is used to X axis.

P3	Input channel of X axis
Data range	1 to 4
Remarks	Specify channel used to X axis. Same channel as Y axis cannot be selected.

P4	Slot number of channel of Y axis
Data range	1 to 4
Remarks	Specify slot number installed module of input channel that is used to Y axis.

P5	Input channel of Y axis
Data range	1 to 4
Remarks	Specify channel used to Y axis. Same channel as X axis cannot be selected.

3.Details of commands – 3.1.Settings of main unit (S commands)

P8	Analysis 1 : Y axis		
Data range	0 to 5	0 : Linear 1 : Lin-Rel 2 : Lin-Img	3 : Lin-Amp 4 : Log-Amp 5 : Phase
Remarks	Specify Y axis of analysis 1.		

P9	Analysis 1 : Manual scale		
Data range	0 to 1	0 : OFF	1 : ON
Remarks	Specify scale of Y axis for analysis 1 manually.		

P10	Analysis 1 : Maximum value of manual scale		
Data range	-7.922816E+28 ~ 7.922816E+28		
Remarks	Specify maximum value of manual scale of analysis 1.		

P11	Analysis 1 : Minimum value of manual scale		
Data range	-7.922816E+28 ~ 7.922816E+28		
Remarks	Specify minimum value of manual scale of analysis 1.		

P12	Analysis 1 : Slot number of signal analysis CH1		
Data range	0 to 9		
Remarks	Specify slot number of module of input signal 1 used to analysis 1.		

P13	Analysis 1 : Channel of signal analysis CH1		
Data range	0 to 4		
Remarks	Specify channel number of input signal used to analysis 1		

P14	Analysis 1 : Slot number of signal analysis CH2		
Data range	0 to 9		
Remarks	Specify slot number of module of input signal 2 used to analysis 1.		

P15	Analysis 1 : Channel of signal analysis CH2		
Data range	0 to 4		
Remarks	Specify channel number of input signal 2 used to CH2 analysis in analysis 1		

P16	Analysis 1 : Peak value		
Data range	0 to 1	0 : Maximum value	1 : Local maximum value
Remarks	Specify as peak value either maximum value or local maximum value of analysis result of analysis 1.		

P17	Analysis 2 : Analysis function		
Data range	0 to 9	0 : Time scale waveform 1 : Linear spectrum 2 : RMS spectrum 3 : Power spectrum 4 : Power spectrum density	5 : 1/1 octave analysis 6 : 1/3 octave analysis 7 : Cross power spectrum 8 : Transfer function 9 : Coherence function
Remarks	Specify function of analysis 2.		

3.1.26. S46: Setting number of partitions

Command	S46
Syntax	S46 P1(CR)(LF)
ACK	Standard ACK
NAK	Standard NAK
Remarks	Refer to " 8.1.3. Sheet Setup " in the instruction manual of the RA3100.

Parameters

P1	Number of graph division
Data range	1 to 18
Remarks	Division of waveform display is number of graph division of P1. The definition of graph division is specified at " 3.1.23. S43: Partition settings of waveform monitor ".

3.2. Module setting (M commands)

3.2.1. M01: Module setting two channel voltage (RA30–101)

Command	M01
Syntax	M01 P1,P2, • • • ,P7(CR)(LF)
ACK	Standard ACK
NAK	Standard NAK
Remarks	The settings of RA30–101. Refer to "9.1 Two Channel Voltage Module (RA30–101)" in the instruction manual of the RA3100.

Parameters

P1	Slot number
Data range	1 to 9, F
Remarks	Specify slot number that the target module is installed. When F is selected, all modules of the same type are target.

P2	Channel
Data range	1 to 2, F
Remarks	Specify channel of target module. When F is selected, all channels are target.

P3	Measurement
Data range	0 to 1 0 : OFF 1 : ON
Remarks	Select whether to measure with specified channel or not.

P4	Range
Data range	0 to 11 0 : 500 V 4 : 20 V 8 : 1 V 1 : 200 V 5 : 10 V 9 : 500 mV 2 : 100 V 6 : 5 V 10 : 200 mV 3 : 50 V 7 : 2 V 11 : 100 mV
Remarks	Specify input range.

P5	Input coupling
Data range	0 to 2 0 : GND 1 : DC 2 : AC
Remarks	Switch the input signal coupling.

P6	Low pass filter
Data range	0 to 4 0 : OFF 1 : 3 Hz 2 : 30 Hz 3 : 300 Hz 4 : 3 kHz
Remarks	Select low pass filter of the input channel.

P7	Anti-aliasing filter
Data range	0 to 1 0 : OFF 1 : ON
Remarks	Select whether to use the anti-aliasing filter of the input channel or not. When ON is selected, it synchronizes with sampling speed of SSD.

3.3.3. I05: Reading the status of main unit

Command	I05
Syntax	I05(CR)(LF)
ACK	ACK with data (Command example) ACK I05,A1(CR)(LF)
NAK	Standard NAK
Remarks	The status of recorder is read.

ACK response

A1	Status
Content of response	0 to 9 0 : In processing to turn the recorder on 1 : In processing to prepare display 2 : In displaying (input or output) 3 : In processing to finish display 4 : Waiting (stand-by of starting time or stand-by of interval) 5 : Waiting of start trigger 6 : In preparation of recording 7 : In recording 8 : In processing to finish recording 9 : In processing to turn the recorder off
Remarks	

4. Specifications of hardware

4.1. LAN port

Items	Specifications
Adaptable standards	IEEE802.3 complied with standards (100BASE-T, 100BASE-TX, 10BASE-T)
Connector	RJ-45
Port	1

4.2. COM port

Items	Specifications
Adaptable standards	EIA-574 complied with standards
Communication speed	300 to 460800 bps
Data length	8 bit fixed
Stop bit	1 bit, 2 bit selection
Parity bit	None, odd, even, mark, space selection
Flow control	None, Xon/Xoff, Hardware (CTS/RTS) selection
Connector	D-sub 9 pin
Port	1

Pin assignment :

Pin No.	Name	IN/OUT	Functions
1	N.C.	-	
2	RxDATA	IN	Receive data
3	TxDATA	OUT	Transmit data
4	N.C.	-	
5	GND		GND
6	N.C.	-	
7	RTS	OUT	Request to send
8	CTS	IN	Clear to send
9	N.C.	-	

Omniace
RA3100

Communication command

1WMPD4004790

1st Edition

AND