

CONTENTS	PAGE
1. INTRODUCTION.....	1
2. PRECAUTIONS BEFORE OPERATION.....	2
2-1.Unpacking the instrument.....	2
2-2.Checking the Line Voltage.....	2
2-3.Environment.....	3
2-4.Equipment Installation and Operation.....	3
3. PANEL DESCRIPTION.....	4
4. OPERATION.....	8
4-1.Connects to DUT.....	8
4-2.Start Up.....	8
4-3.Zeroing.....	8
4-4.Menu Functions.....	11
4-5.Measurement Conditions.....	18
5. SPECIFICATIONS.....	35
6. MESSAGE CODE.....	42
7. MAINTENANCE.....	43
7-1.Cleaning.....	43
7-2.Battery Replacement.....	43
7-3.Recall Calibration.....	44
8. OPTION 1 (BIN Function for LCR-826/827/829 only).....	46
8-1. BIN Functions for Components Sorting.....	46
8-2. BIN Setting Conditions.....	48
8-3. BIN Range Setting: Component Sorting Range.....	54
9. OPTION 2 (RS-232, for LCR-816/817/819 only).....	63
9-1.On-line procedure.....	63
9-2.RS232 VIEWER Software Operation.....	67
9-3.The Configuration of Cable.....	72

SAFETY TERMS AND SYMBOLS

These terms may appear in this manual or on the product:



WARNING: Warning statements identify condition or practices that could result in injury or loss of life



CAUTION: Caution statements identify conditions or practices that could result in damage to this product or other property.

The following symbols may appear in this manual or on the product:



DANGER
High Voltage



ATTENTION
refer to Manual



Protective
Conductor
Terminal



Earth (ground)
Terminal

FOR UNITED KINGDOM ONLY

NOTE: This lead / appliance must only be wired by competent persons



WARNING: THIS APPLIANCE MUST BE EARTHED

IMPORTANT: The wires in this lead are coloured in accordance with the following code:

Green/ Yellow:	Earth
Blue:	Neutral
Brown:	Live (Phase)

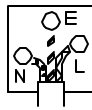

As the colours of the wires in main leads may not correspond with the colours marking identified in your plug/appliance, proceed as follows:

The wire which is coloured Green & Yellow must be connected to the Earth terminal marked with the letter E or by the earth symbol  or coloured Green or Green & Yellow.

The wire which is coloured Blue must be connected to the terminal which is marked with the letter N or coloured Blue or Black.

The wire which is coloured Brown must be connected to the terminal marked with the letter L or P or coloured Brown or Red.

If in doubt, consult the instructions provided with the equipment or contact the supplier.

This cable/appliance should be protected by a suitably rated and approved HBC mains fuse: refer to the rating information on the equipment and/or user instructions for details. As a guide, cable of 0.75mm² should be protected by a 3A or 5A fuse. Larger conductors would normally require 13A types, depending on the connection method used.

Any moulded mains connector that requires removal /replacement must be destroyed by removal of any fuse & fuse carrier and disposed of immediately, as a plug with bared wires is hazardous if engaged in live socket. Any re-wiring must be carried out in accordance with the information detailed on this label.

EC Declaration of Conformity

We
GOOD WILL INSTRUMENT CO., LTD.
 No. 95-11, Pao-Chung Rd., Hsin-Tien City, Taipei Hsien, Taiwan
 declares that the below mentioned product
LCR-817/819/827/829/816/826
 are herewith confirmed to comply with the requirements set out in the Council Directive on the Approximation of the Law of Member States relating to Electromagnetic Compatibility (89/366/EEC, 92/31/EEC, 93/68/EEC) and Low Voltage Equipment Directive (73/23/EEC).
 For the evaluation regarding the Electromagnetic Compatibility and Low Voltage Equipment Directive, the following standards were applied:

EN 61326 -1: Electrical equipment for measurement, control and laboratory use — EMC requirements (1997+A1: 1998)	
Conducted and Radiated Emissions EN 55011 Group I class A: 1998	Electrostatic Discharge EN 61000-4-2: 1995
Current Harmonic EN 61000-3-2: 2000	Radiated Immunity EN 61000-4-3: 1996
Voltage Fluctuation EN 61000-3-3: 1995	Electrical Fast Transients EN 61000-4-4: 1995
_____	Surge Immunity EN 61000-4-5: 1995
_____	Conducted Susceptibility EN 61000-4-6: 1996
_____	Power Frequency Magnetic field EN 61000-4-8: 1993
_____	Voltage Dips/ Interrupts EN 61000-4-11: 1994

Low Voltage Equipment Directive 73/23/EEC & amended by 93/68/EEC
Safety Requirements EN 61010-1: 1993+A2: 1995; IEC 61010-1: 1990+A1: 1992+A2: 1995

1. INTRODUCTION

The precise LCR meter series are automatic, user programmable instruments that provide high reliability and great precision for measuring a wide variety of impedance parameters. The frequency range of LCR-819/829 covers from 12Hz to 100kHz, LCR-817/827 from 12Hz to 10kHz, LCR-816/826 from 100Hz to 2kHz, and LCR-821 from 12Hz to 200kHz. The basic accuracy is 0.1% for LCR-827/829, 0.05% for LCR-817/819, and 0.1% for LCR-816/826/821. The measured results can be displayed on the high quality LCD monitor with decimal points and units. The measured result resolution is five full digits for Inductance (L), Capacitance (C), Resistance (R) and absolute value of impedance (Z) (four full digits for Dissipation factor (D), Quality factor (Q), R with C, R with L, 2 digits after decimal dot for phase angle (?)). In the meantime, the LCD monitor is also shown the control status and parameters of settings. The keypads are easy for menu programming. The LCR Meters' test fixture (option) is a method of convenient, reliable, guarded 4-terminal/2 wires connection of radial and axial leaded components to the LCR Meters. Test conditions can be stored and recalled from internal memory that will reduce the setup time for measurement preparing.

2. PRECAUTIONS BEFORE OPERATION

2-1. Unpacking the instrument

The product has been fully inspected and tested before shipping from the factory. Upon receiving the instrument, please unpack and inspect it to check if there are any damages caused during transportation. If any damage is found, notify the bearer and/or the dealer immediately.

2-2. Checking the Line Voltage

The LCR Meters can be operated with AC power source between 100V rated voltage and 240V rated voltage at a frequency of 50 to 60Hz, no AC voltage selector is necessary. Power connection to rear panel is through an AC inlet module comprised of an AC connector and fuse holder. To change the fuse proceed as follows:

- Remove the fuse holder by inserting a small flat head screwdriver behind the small tab to force the holder outward.
- Install the correct fuse (slow-blow, 3A, 250Vac).
- Re-install the fuse holder back into the LCR Meters AC inlet module, push in and lock.



WARNING. To avoid electrical shock the power cord protective grounding conductor must be connected to ground.



WARNING. To avoid personal injury, disconnect the power cord before removing the fuse holder.

2-3. Environment

The normal ambient temperature range of the LCR Meters is from 10° to 50°C. To operate the instrument over this specific temperature range may cause damage to the circuits.

Do not use the LCR Meters in a place where strong magnetic or electric field exists as it may disturb the measurement.

2-4. Equipment Installation and Operation

Ensure there is proper ventilation for the vents in the LCR meters case. If this equipment is used not according to the specification, the protection provided by the equipment may be impaired.



WARNING: This is a Class A product. In a domestic environment this product may cause radio interference in which case the user may be required to take adequate measures.

3. PANEL DESCRIPTION

(1). Power Switch

Turns AC Power on or off.

(2). Function key — **F1**

Soft key functions as indicated on the adjacent LCD monitor.

(3). Function key — **F2**

Soft key functions as indicated on the adjacent LCD monitor.

(4). Function key — **F3**

Soft key functions as indicated on the adjacent LCD monitor.

(5). Function key — **F4**

Soft key functions as indicated on the adjacent LCD monitor.

(6). MENU key

Enters menu display mode or exits sub menu back to main menu.

(7). Compound key

- For making numerical entries as labeled.
- Turns the “RANGE HOLD” mode on or off.

(8). Compound key

- For making numerical entries as labeled.
- Turns the “CONSTANT VOLTAGE” mode on or off.

(9). Compound key

- For making numerical entries as labeled.
- Measures the unit of Dissipation and Quality Factor in PPM.
(Note: The models of LCR-816 and 826 do not have this function.)

(10). Compound key

- For making numerical entries as labeled.
- Selects the “INTERNAL BIAS” mode or “EXTERNAL BIAS” mode. (If this key function is switched to “INTERNAL BIAS” mode, the bottom of LCD monitor will display the “INT.B” message. If the external DC bias is selected, the bottom of LCD monitor will display the “EXT.B” message.)

(11). Compound key

- For making numerical entries as labeled.
- Turns the INTERNAL BIAS mode or EXTERNAL BIAS mode “ON” or “OFF”.

(12). Compound key

- For making numerical entries as “ - ” (the negative sign).
- Inputs the “TEST FREQUENCY”.

(13). START (Compound key)

- Starts measurement sequence. Normally used in the “MANU” (Triggered) mode.
- Selects “AUTO” or “MANU” mode by pressing this key for 3 seconds at least.
- The LCR Meters will process the measurement automatically, if the “AUTO” mode is selected.

(14). key (ENTER)

This key enables programming of all special functions, test frequency, test voltage, averaging, delay, and nominal value etc.

(15). Symbol key

Inputs the decimal point

(16). Numeral key—“2”

- (17). Numeral key—"3"
- (18). Numeral key—"5"
- (19). Numeral key—"6"
- (20). Numeral key—"9"
- (21). Primary Display
This line can display the measured Inductance, Capacitance, or Resistance.
- (22). Secondary Display
This line can display the measured Quality Factor or Dissipation or ESR or EPR.
- (23). Instrument status or indicates measurement results based on entered test limits.
- (24). Test conditions
- (25). Input terminals
BNC connectors, connects to device under test (DUT).

Connectors of the LCR Meters BIAS

Lforce (current, low)	+
Lsense (potential low)	+
Hsense (potential high)	-
Hforce (current, high)	-

FRONT PANEL

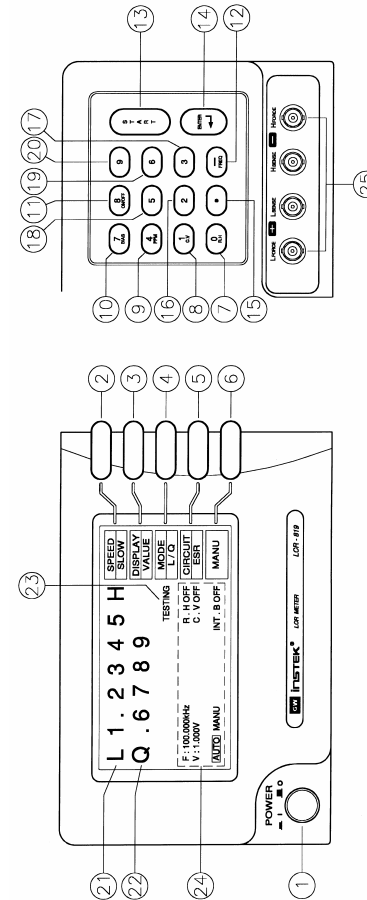

4. OPERATION

4-1. Connects to DUT

The LCR Meters utilize the structure of four wires measurement which allows accurate, easy, and stable measurements and avoids mutual inductance and interference from measurement signals, noise and other factors inherent with other types of connections. For the accuracy of measurement, GOODWILL produces the cable set and test fixture (option) for connection directly to the front panel BNC connectors.

4-2. Start-Up

Connects the power cord of the LCR Meters to the mains socket -outlet. Presses the **POWER** button of front panel to apply the AC power to the LCR Meters.

4-3. Zeroing

In order to eliminate strayed capacitance and impedance of test cable during the measurement, the LCR Meters should be zeroed to correct for test cable and/or test fixture errors before taking measurements. The corrections are calculated and stored in memory of the LCR Meters during the zeroing process. Open and short circuit zeroing should be done for test cable and/or test fixture. For the best accuracy, the test cable and/or test fixture should be zeroed once per day at least and each time test cable or test fixture is changed in general.

The zeroing process of open and short circuits are following:

Open Circuit

- The test cable or test fixture should be open with no component connected.
- Press **MENU** key.
- Press **F1** key to select “OFFSET” menu.
- Press **F1** key to select open circuit zeroing (the “CAP OFFSET” is indicated on the adjacent LCD monitor.).

- After the BAR at the bottom of LCD monitor is filled to the full, the zeroing process is done.
- If the zeroing process is successful, a message of “OK” will appear on the LCD monitor. If failed, a message of “FAIL” will appear on the LCD monitor.

Short Circuit

- The test cable should be connected or test fixture shorted (using a clean copper wire, as short as possible).
- Press **MENU** key.
- Press **F1** key to select “OFFSET” menu.
- Press **F2** key to select short circuit zeroing (the “R/L OFFSET” is indicated on the adjacent LCD monitor.).
- After the BAR at the bottom of LCD monitor is filled fully, the zeroing process is done.
- If the zeroing process is successful, a message of “OK” will appear on the LCD monitor. If failed, a message of “FAIL” will appear on the LCD monitor.

Test Condition:

Test voltage=1V
 Test speed = SLOW
 R.H = OFF
 C.V = OFF

For the summary, the zeroing menu can be chosen through menu selection as shown in Figure 4-1 above.

NOTE: The “Open Circuit” and “Short Circuit” have to pass the test, otherwise, the accuracy of the LCR Meters will become worse.

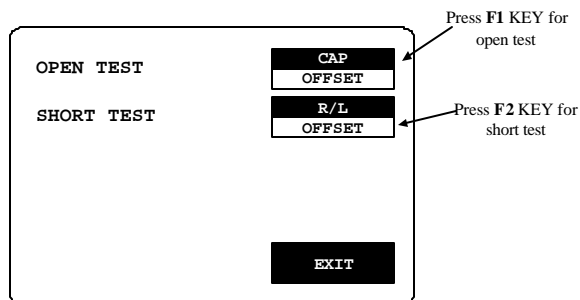
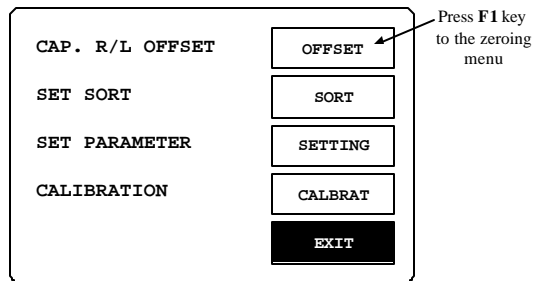
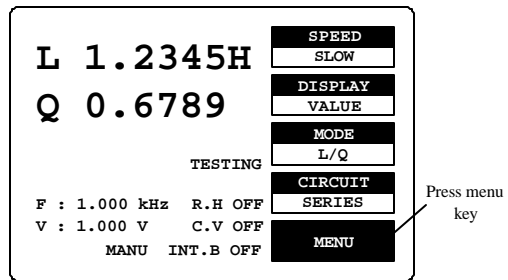

Figure 4-1: Summary of zeroing menu

4-4. Menu Functions

All the LCR Meters' programmable functions are controlled by the easy to use menu displays. User can enter the menu mode by selecting the **MENU** key that calls up four top level menus, **OFFSET**, **SORT**, **SETTING** and **CALBRAT**. Each one of these is comprised of a sub menu list whose functions are described in detail below. User can enter one of four functions by pressing the corresponding function key (just adjacent LCD monitor, see figure 4-2).

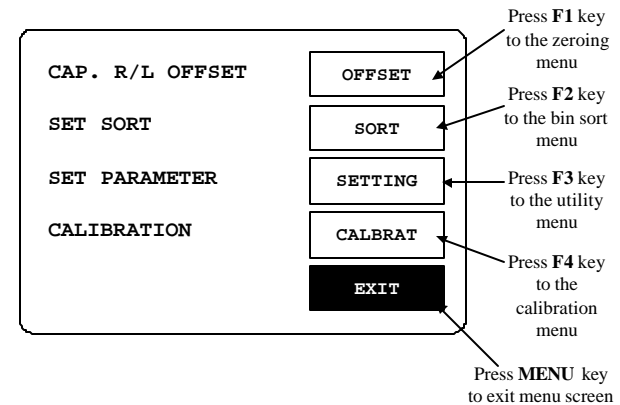

Figure 4-2: four main menu screen

4-4-1. Primary & Secondary Display

For the LCR Meters, four combinations of two parameters can be measured and displayed simultaneously. One referred to the "**Primary Display**" (displayed first) and the other to the "**Secondary Display**". Depending on the component type the primary and secondary display could be **L & Q**, **C & D**, **C & R** or **R and Q**, and add L&R and Z &? to **LCR-821**. The parameter can be chosen by pressing **F3** key as shown in Figure 4-3.

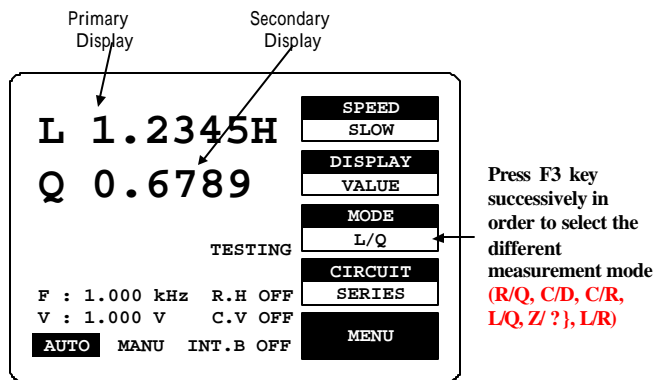

Figure 4-3. Primary & Secondary display

User can select **R/Q** for resistor measurement; select **L/Q** or **L/R** for inductor measurement; select **Z/?** for impedance measurement, select either **C/D** or **C/R** for capacitor measurement.

Note: Only LCR-821 can select Z/?, L/R measurement modes.

4-4-2. Series & Parallel Equivalent Circuit

Impedance that is neither a pure resistance nor a pure reactance can be represented at any specific frequency by either a series or a parallel combination of resistance and reactance. Such representation is called “equivalent circuit”. The component value of the “Primary Display” depends on which equivalent circuit (series or parallel) is chosen. In normal, the component manufacturer shall specify how a component is to be measured (usually series) and at what frequency.

● Measurement Function

Measurement Mode	Series Equivalent Circuit	Parallel Equivalent Circuit
R / Q	✓	✓
C / D	✓	✓

C / R	✓	✓
Z / ? (degree)	✓	
L / R	✓	✓

Suggested Test Conditions:

- Inductors less than 10μH: Series, 100kHz.
- Inductors from 10 μH to 1mH: Series, 10kHz.
- Inductors from 1mH to 1H: Series, 1kHz.
- Inductors greater than 1H: Series, 0.1kHz.
- Capacitors less than 10pF: Parallel, 100kHz.
- Capacitors from 10 to 400pF: Series or Parallel, 10kHz.
- Capacitors from 400 to 1μF: Series, 1kHz.
- Capacitors greater than 1μF: Series, 0.1 or 0.12kHz.
- Resistor less than 1kΩ: Series, 1kHz.
- Resistor from 1kΩ to 10MΩ: Parallel, 0.25kHz.
- Resistor greater than 10 MΩ: Parallel, 0.03kHz

Unless for special reason, always select “Series” for capacitors and inductors. This has traditionally been standard practice. For very small capacitance or inductance, select a higher test frequency for better accuracy. For very large capacitance or inductance, select a lower test frequency for better accuracy. For dc resistance, select a lower test frequency to minimize ac effects.

Because the reactive component most likely to be represented in a low resistance resistor is series inductance, the “Series” is selected for a resistor below about 1kΩ. If a resistor large than 10MΩ, select “Parallel” that because the reactive component most likely to be represent in a high resistance resistor is shunt capacitance. If the Q is less than 0.1, the measured Rp is probably very close to the dc resistance.

The total loss of a capacitor can be expressed in several ways, including D and “ESR” (Equivalent Series Resistance). “ESR” is typically much larger than

actual “ohmic” series resistance of the wire leads and foils that are in series with the heart of a capacitor physically, because ESR includes also the effect of dielectric loss. ESR is related to D by the formula: $ESR = R_s = D / \omega C_s$. Where ω represents “omega” = 2π time frequency.

Although it is traditional to measure series inductance of inductors, there are situations in which the parallel equivalent circuit better represents the physical component. For small “air-core” inductors, the significant loss mechanism is usually “ohmic” or “copper loss” in the wire, therefore the series circuit is appropriate. Nevertheless, for an “iron core”, the significant loss mechanism can be “core loss”, therefore, the parallel equivalent circuit is appropriate which being a better model of the inductor.

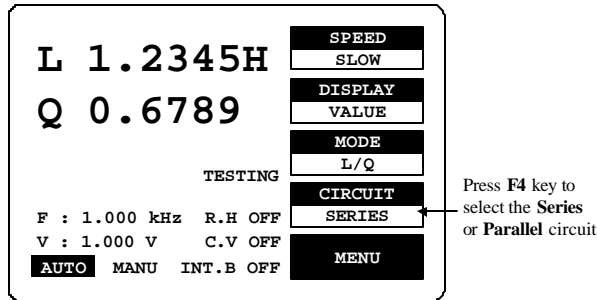

Figure 4-4. Selections of Series & Parallel Circuit

4-4-3. Measurement Displays

The measured results of the LCR Meters can be shown on the LCD monitor in three ways: **VALUE**, **DELTA%**, or **DELTA**. User can press **F2** key to select the appropriate item for measurement.

VALUE

The LCD monitor will display the measured value of both the primary and secondary parameter, shown with decimal and units. The resolution of primary display (L, C, R or Z) is five digits. The resolution of secondary display (D, Q or R with C) is four digits. **The resolution of secondary display (?) is at 2 digits after decimal point.** The message “TESTING” is displayed when a test is in process.

DELTA%

The “DELTA%” shows the percent deviation of the measured L, C, R or Z value from a stored NOMINAL VALUE. The sign of deviation is indicated.

DELTA

The LCR difference is similar to the DELTA% except that the deviation is shown in suitable units (ohms, henries, etc).

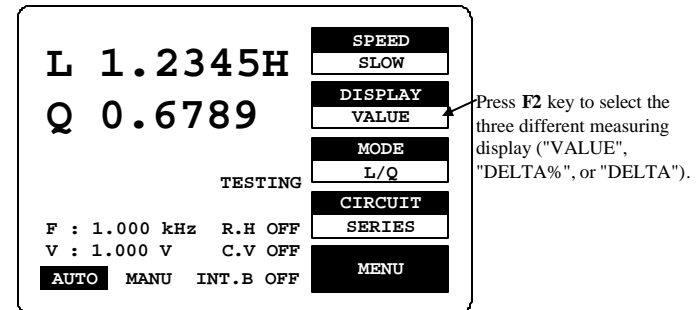

Figure 4-5. Types of measurement display

4-4-4. Nominal Value

Allows entry of a "Nominal Value" for the primary parameter which is the basis for the measurement result in "DELTA" or "DELTA %". Accepts numerical entry up to five digits with decimal. Units are depended on which measurement displays selected.

Steps of "Nominal Value" input (Figure 4-6):

- Press **MENU** key.
- Press **F2** key to select "SORT" menu.
- Press **F1** key to select "Nominal Value" (the "NOM.VAL" is indicated on the adjacent LCD monitor).
- Input the nominal value via the numeral keys (5 digits with decimal maximum).
- Press **↵** key
- After the BAR at the bottom of LCD monitor is filled fully, the "Nominal Value" input is done

4-4-5. Selection of Measurement Speed

One of three measurement speeds **SLOW**, **MEDIUM**, or **FAST** could be selected (Figure 4-7). The continuous mode speeds are about 1, 5, and 12 measurement per second respectively. The trade-off is accuracy vs. speed. LCR-817/819 will take a more accurate measurement at a slower rate. The trade-off is as follows

SLOW speed :More than 1 measurement per second, at 0.05% accuracy (or better)

MEDIUM speed :More than 3 measurements per second, at 0.1% accuracy (or better)

FAST speed :More than 7 measurements per second, at 0.24% accuracy (or better)

* For the details of accuracy, please refer to the specifications.

* Regarding the models LCR -827 & 829, please refer to 4-6-2 Handler Interface Timing.

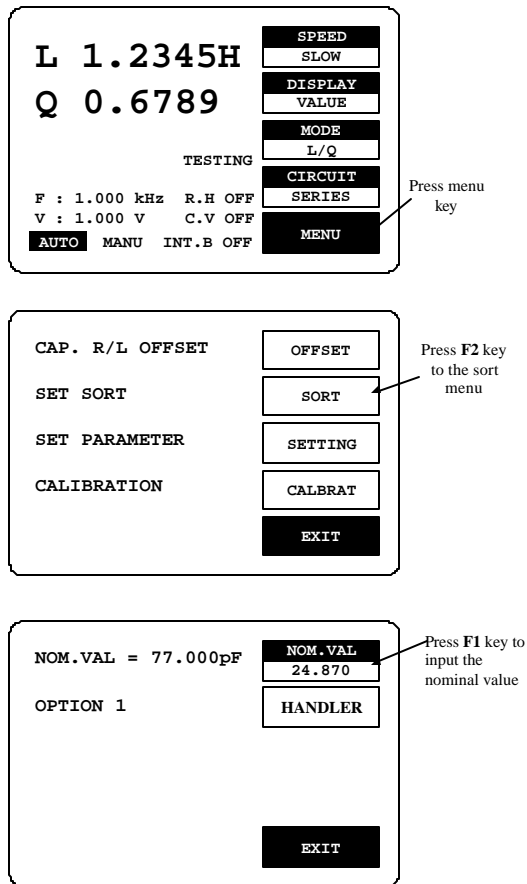

Figure 4-6. Steps of "Nominal Value" input.

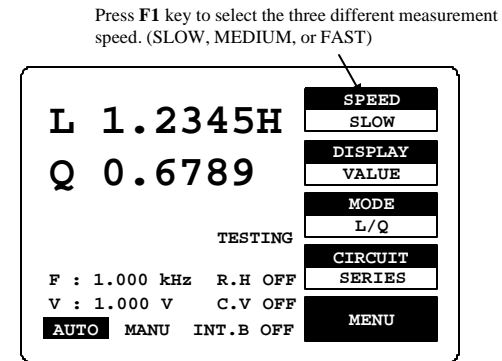

Figure 4-7. Selection of measurement speed

4-5. Measurement Conditions

4-5-1. Bias Voltage

There are two available bias voltage modes: "Internal" and "External".

Internal:

An internal DC 2 volts bias voltage will apply to the device under test.

External:

An external DC bias voltage between 0 and 30 volts can be applied to the device under test. The external bias connection is located on the rear panel. The maximum current is 200mA. The supply of bias voltage has to be floating, don't connect either side to ground. It's better to wait approximately 1 second for taking a reading after initiating a testing process, therefore, the device under test will stabilize after bias voltage applied. The DC bias voltage should be applied only to capacitors in general. If the DC bias voltage is applied to device of low impedance, the unreliable testing results will occur.

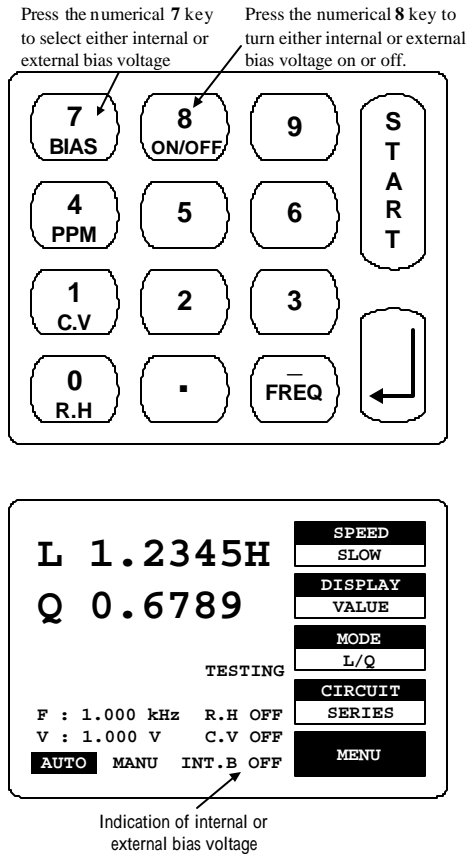

Figure 48. Selection of "BIAS" voltage

Steps of "BIAS" voltage selection (Figure 48, please note that the models of LCR-816 and 826 do not have this function):

- Press compound key **7** to select the "INTERNAL BIAS" or "EXTERNAL BIAS" on the main menu. (If this key function is switched to "INTERNAL BIAS", the bottom of LCD monitor will display the "INT.B" message. If the external DC bias is selected, the bottom of LCD monitor will display the "EXT.B" message.
- Press compound key **8** to turn either "INTERNAL BIAS" or "EXTERNAL BIAS" mode "ON" or "OFF" on the main menu.

4-5-2. Test Frequency

The numerical input of test frequency accepts up to 5 digits with decimal. User can input any desired frequencies, however, the actual frequency executed for the LCR Meters is always the closest one of the 504 available frequencies. The 504 frequencies can be calculated by the following formulas:

$$\begin{aligned}
 &3\text{kHz}/n, && \text{where } n \text{ range is from } 13 \text{ to } 250 \text{ (freq. } 0.012 \text{ to } 0.23077\text{kHz)} \\
 &60\text{kHz}/n, && \text{where } n \text{ range is from } 4 \text{ to } 256 \text{ (freq. } 0.23438 \text{ to } 15\text{kHz)} \\
 &200\text{kHz}/n, && \text{where } n \text{ range is from } 1 \text{ to } 13 \text{ (freq. } 15.385 \text{ to } 200\text{kHz)}
 \end{aligned}$$

The "nominal value" of an available frequency can be calculated from the proper one of the three formulas.

The range of test frequency between 12Hz and 10kHz is for LCR-817/827, between 12Hz and 100kHz for LCR-819/829, between 100Hz and 2kHz for LCR-816/826, and between 12Hz and 200kHz for LCR-821. To select the test frequency, just key in the desired frequency via these numerical keys, the LCR Meters will take the nearest available test frequency from the 504 available test frequencies automatically.

Steps of "Test Frequency" selection (Figure 4-9):

- Press compound key **FREQ.**
- Input the desired frequency in kilohertz.
- Press **↵** key.

Note: After test frequency has been changed, the zeroing of "Open/Short

circuit” must be done again for the best accuracy.

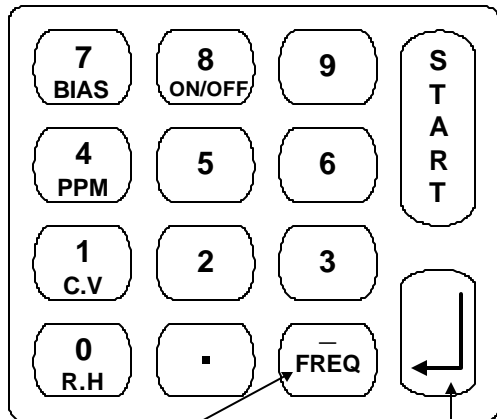

Press - key to input test frequency

Press enter key to confirm the inputs.

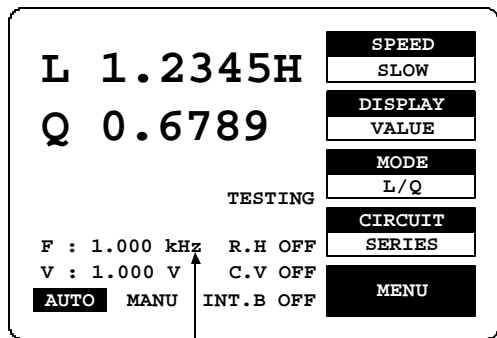

test frequency

Figure 49. Inputs of test frequency

4-5-3. D/Q in PPM (parts per million)

If the value of D or Q is less than 0.0100, user can select DQ in PPM to improve the resolution by a factor of 100. The units of D and Q in PPM are dimensionless and expressed as a decimal ratio with the multiplier of 1000000. User can just press compound key **4** to select the unit of D or Q in PPM. To disable the DQ in PPM feature, press the same key again.

4-5-4. Test Voltage

The range of test voltage is from 5mV to 1.275V in increments of 5mV. The actual voltage through the DUT is never more than the source voltage. The DUT impedance and the source resistance of the LCR Meters decide the actual test voltage. The smallest voltage through the DUT will be 20% smaller of the source voltage in general. The programming of test voltage is as follows (Figure 4-10):

- Press **MENU** key.
- Press **F3** key to select “SETTING” menu.
- Press **F2** key to select “VOLT” menu.
- Input the desired value via the numeral keys.
- Press **↵** key
- After the BAR at the bottom of LCD monitor is filled fully, the “Test Voltage” input is done.

4-5-5. Constant Voltage Source

If the DUT have to be measured at a particular test voltage, the LCR Meters provides the constant voltage feature. After “Constant Voltage” is selected, The LCR Meters will keep a source resistance of 25Ω. Therefore, the test voltage is constant for any DUT impedance which large than 25Ω. If “Constant Voltage” is selected, the measurement accuracy will cause a reduction by a factor of three. User can just press compound key **1** to select the feature of “Constant Voltage”. To disable this feature, press the same key again.

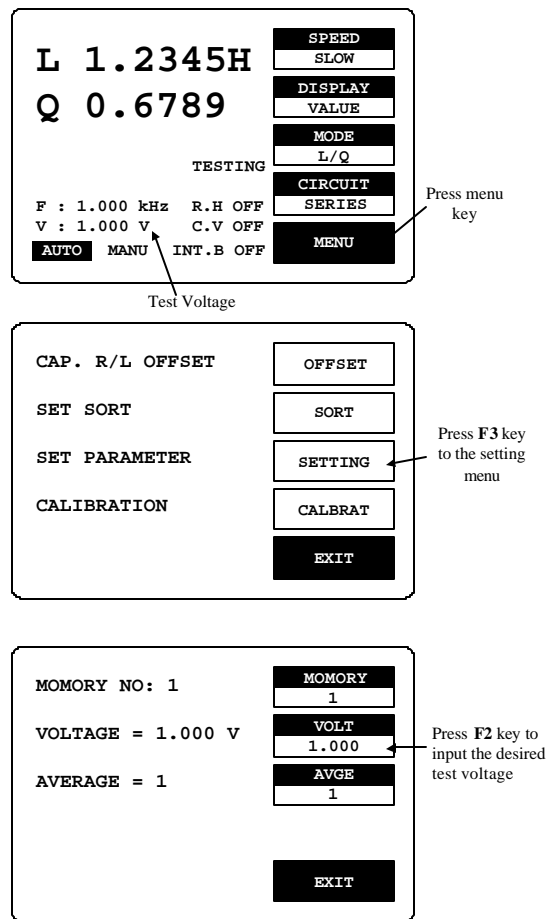

Figure 4-10. Programming of test voltage.

4-5-6. Range Hold

If a DUT is removed from the test cable or fixture during the “Continuous” mode, the feature of “Range Hold” can avoid range switching. Due to the test time can be reduced, “Range Hold” is a useful utility for repetitive devices measurement. User can just press compound key **0** to select the feature of “Range Hold”. To disable this feature, press the same key again.

4-5-7. Averaging

If this function is enable, the testing time will multiple by the number of tests (from 1 to 255). Hence, the accuracy can be enhanced. The measurement time will be increased to the contrary. The programming of “Averaging” is as follows (Figure 4-11):

- Press **MENU** key.
- Press **F3** key to select “SETTING” menu.
- Press **F3** key to select “AVGE” menu.
- Input the desired value via the numeral keys.
- Press **↵** key
- After the BAR at the bottom of LCD monitor is filled to the full, the “Averaging” input is done.

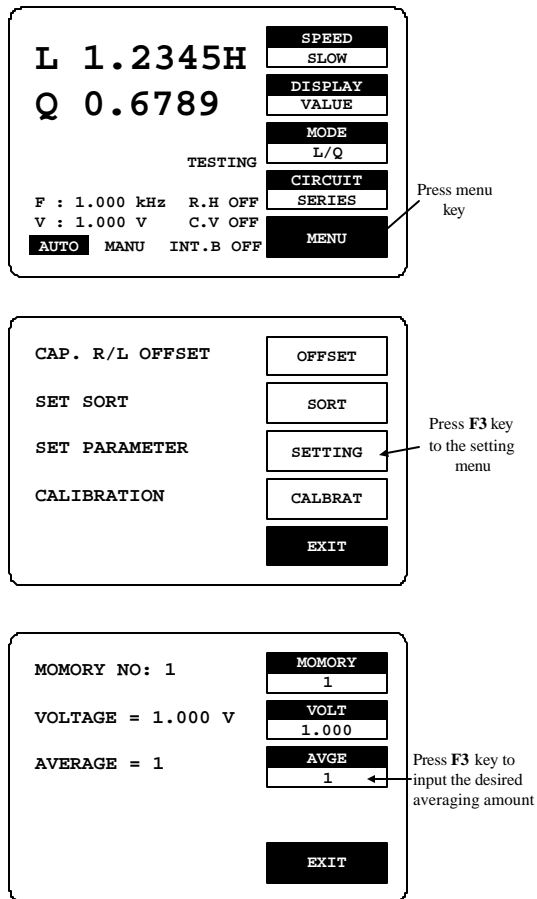

Figure 4-11. Programming of averaging.

4-5-8. Memory

The LCR Meters have two memory functions: Recall and Store. The current measurement conditions can be saved into the memory unit or recalled a previously saved measurement conditions set from the LCR Meters memory. There are 100 memory blocks totally. The programming of “Memory Store / Recall” can be used as described below (Figure 4-12):

- Press **MENU** key.
- Press **F3** key to select “SETTING” menu.
- Press **F1** key to select “MEMORY” menu
- Press compound key **1** to recall a previously saved memory block. or
- Press compound key **2** to store the current measurement conditions into memory.
- Input the number of desired memory block. (1~100)
- Press **↵** key
- After the BAR at the bottom of LCD monitor is filled to the full, the process of “Memory Store/Recall” is done.

Remark: For LCR-827/829, the function of Recall and Store is not only used in the normal memory status, also it can be extended to sorting and BIN-SUM setting.

L 1.2345H	SPEED
Q 0.6789	SLOW
	DISPLAY
	VALUE
	MODE
	L/Q
TESTING	CIRCUIT
	SERIES
F : 1.000 kHz R.H OFF	MENU
V : 1.000 V C.V OFF	
AUTO MANU INT.B OFF	

Press menu key

CAP. R/L OFFSET	OFFSET
SET SORT	SORT
SET PARAMETER	SETTING
CALIBRATION	CALBRAT
	EXIT

Press F3 key to the setting menu

MOMORY NO: 1	MOMORY
	1
VOLTAGE = 1.000 V	VOLT
	1.000
AVERAGE = 1	AVGE
	1
	EXIT

Press F1 key to select the memory store/recall function

Figure 4-12. Programming of memory store/recall.

Press compound key 1 to select the memory recall function

Press compound key 2 to select the memory store function

(1)RECALL:(2)STORE	MOMORY
	1
VOLTAGE = 1.000 V	VOLT
	1.000
AVERAGE = 1	AVGE
	1
	EXIT

Input number of desired memory block for memory recall function

RECALL NO:	MOMORY
	1
VOLTAGE = 1.000 V	VOLT
	1.000
AVERAGE = 1	AVGE
	1
	EXIT

Input number of desired memory block for memory store function

STORE NO:	MOMORY
	1
VOLTAGE = 1.000 V	VOLT
	1.000
AVERAGE = 1	AVGE
	1
	EXIT

Figure 4-12. Programming of memory store/recall. (Cont.)

4-5-9. Handler Interface(Only for LCR -826/827/829)

FUNCTION	HANDLER INTERFACE	
	Signal Name	Pin NO.
Start Measurement (I)	/I_E_TRIG	24
End of test (O)	/O_EOM	23
Data acquisition over , DUT removal OK.(O)	/O_INDEX	22
RLC FAIL(O)	/O_P_HI	19
	/O_P_LO	20
	/O_P_OVER	15
No-Go , D or Q Fail	/O_S_REJ	21
	/O_S_OVER	14
Go , BIN 1 Judgement	/O_BIN_1	1
Go , BIN 2 Judgement	/O_BIN_2	2
Go , BIN 3 Judgement	/O_BIN_3	3
Go , BIN 4 Judgement	/O_BIN_4	4
Go , BIN 5 Judgement	/O_BIN_5	5
Go , BIN 6 Judgement	/O_BIN_6	6
Go , BIN 7 Judgement	/O_BIN_7	7
Go , BIN 8 Judgement	/O_BIN_8	8
Go , BIN 9 Judgement	/O_BIN_9	9
Go , BIN 10 Judgement	/O_BIN_10	10
Go , BIN 11 Judgement	/O_BIN_11	11
Go , BIN 12 Judgement	/O_BIN_12	12
Go , BIN 13 Judgement	/O_BIN_13	13
Panel Lock	/I_K_LOCK	25
GND	GND	16,18
VCC	VCC	17

Handler Interface Typical Electrical Characteristics				
Comparison Signals	Voltage Output Rating		Maximum Current	Note
	Low	High		
/BIN1-/BIN9	0.5V	+5V +24V	*	5mA
/AUX_BIN				
/OUT_OF_BIN				
/PHI				
/PLO				
Control Signals				
/INDEX				
/EOM				

* R408 R427 Pull-high Resistor need to be changed.

Handler Interface Typical Electrical Characteristics						
Comparison Signals	Input			Input Current (Low) Pull-high Voltage		Note
	Low	High		+5V	+12V	
/EXT_TRIG	1V	5V	15V	5mA	12mA	
/KEY_LOCK	1V	5V	15V	5mA	12mA	

- Input Signals**

/I_E_TRIG: This signal is a measurement start signal. To start measurement by setting low pulse to minimum 5us for /I_E_TRIG signal. This is a low edge active.

/I_K_LOCK: This signal is to lock all front panel controls. The front panel is disable when /I_K_LOCK is at low level, and enable when /I_K_LOCK is at high level.

- **Measurement Complete signal:**

/O_INDEX: This signal will go the low level when analog measurement is completed and will go the high level when next trigger is active. The handler can then remove the DUT from the fixture and replace it with another DUT during the time when /O_INDEX is at low level.

- **Compare Output Signals:**

/O_BIN_1 - /O_BIN_13 : The GO judgment is active according to the measured value judgment results (low level), for example, if the comparator assigns a component to BIN1, the /O_BIN_1 line will go the low level till **T4** (see Handler Interface Timing). /O_BIN_2 - /O_BIN_13 are all inactive (high level).

/O_P_HI: Main parameter failure: When the main parameter is greater than **Max**, it will go the low level till **T4** (see Handler Interface Timing).

/O_P_LO: Main parameter failure: When the main parameter is lower than **Min**, it will go the low level till **T4**(see Handler Interface Timing).

/O_P_OVER: It will go the low level when main parameter is greater than **Max** or is lower than **Min**.

/O_S_REJ/O_S_OVER: It will go the low level when secondary is greater than **D_Max** (if MODE=C/D) or is lower than **D_Min**.

- **Judgment Complete Signal**

/O_EOM: This signal becomes active (low level) when the measurement and comparator judgment are completed, and all handler interface output are stable. It will go the high level when next trigger Signal (**I_E_TRIG**) becomes active (low edge).

4-5-10. Handler Interface Timing(only for LCR-826/827/829)

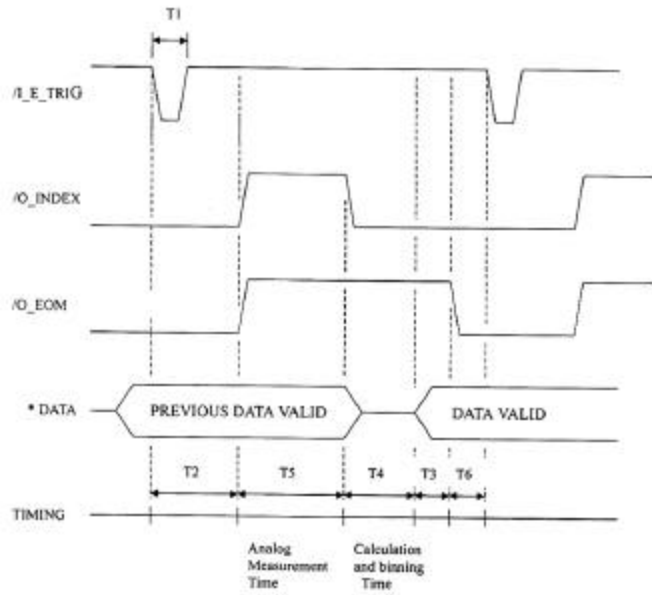

* DATA:/O_BIN_1 - BIN_13,/O_P_OVER,/O_S_OVER,/O_S_REJ,/O_P_HI,/O_P_LO

	Time	Minimum Value	Maximum Value
T1	Trigger Pulse Width	5 us	
T2	Measurement Start Delay Time	140 us	
T3	/EOM Delay Time After Data Output	5 us	
T4	Calculation and binning Time	6 ms	

SPEED	Analog Measurement Time(T5)						Trigger Wait Time After /EOM Output (T6)		
	0.012kHz	0.1kHz	0.12kHz	1kHz	10kHz	100kHz	OFF	BIN	VALUE
SLOW	817ms	901ms	901ms	903ms	873ms	873ms	2ms	4ms	16ms
MEDIUM	817ms	125ms	105ms	59ms	53ms	53ms	2ms	4ms	16ms
FAST	817ms	125ms	103ms	27ms	17ms	17ms	2ms	4ms	16ms

ACCURACY	FAST	MEDIUM	SLOW
MODEL			
LCR-827			
LCR-829	0.5%	0.2%	0.1%
LCR-826			

5. SPECIFICATIONS

Measurement Parameters:

Inductance (L_s/L_p)⁺, Capacitance (C_s/C_p), Resistance (R_s/R_p), Dissipation (D), Quality Factors (Q), Equivalent Series Resistance (ESR) and Equivalent Parallel Resistance (EPR), **Impedance (|Z|)**, **Phase angle of Impedance [degree] (?)**.

Measurement Models:

Four kinds of measurement model can be selected. Two measurement parameters measured and displayed simultaneously.

R/Q, C/D, C/R, L/Q, **Z/?**, **L/R**.

Display Ranges:

Primary Display

Inductance (L)	: 0.00001mH	99999H
Capacitance (C)	: 0.00001pF	99999 μ F
Resistance (R)	: 0.00001	99999k
Absolute of Impedance (Z)	: 0.00001	99999k

Secondary Display

Dissipation factor (D) ⁺	: 0.0001	9999
Quality factor (Q) ^{***}	: 0.0001	9999
Phase angle of Impedance (degree)	:-180.00 °	180.00 °
Equivalent Series Resistance (ESR) ⁺	: 0.0001	9999 k
Equivalent Parallel Resistance (EPR) ⁺	: 0.0001	9999 k
Dissipation factor (D) ⁺ in ppm	: 1 ppm	9999 ppm

*s=series, p=parallel, ESR=Rs ** with R *** with L or R + with C

Note: Only **LCR-821** has **Z/?** and **L/R** measurement parameter.

Quality factor (Q) ^{**} in ppm	: 1 ppm	9999 ppm
DELTA %	: 0.00001%	99999%

If any of these quantities is negative, the “-“ negative indicator is displayed

Accuracy:

R, L, C, Z: 0.05%(Basic)

D, Q, ? : .0005(Basic)

*LCR-816/826/827/829/821 is one fold less accuracy than LCR-817/819.

(LCR-816/826: 0.1%, LCR-827/829/821: 0.1%, LCR-817/819: 0.05%)

Test Frequency:

There are 504 test frequencies between 12Hz and 200kHz that can be selected by using keypad for LCR-821. The frequency range of LCR-819/829 covers from 12Hz to 100kHz (total test frequencies: 504 points), LCR-817/827 covers from 12Hz to 10kHz (total test frequencies: 489 points), LCR-816/826 covers from 100Hz to 2kHz (total test frequencies: 16 points).

Measurement Displays:

The measured results can be shown on the LCD monitor in three ways:

- VALUE** : The measured quantities of R/Q, C/D, C/R, L/Q, **Z/?**, **L/R**.
*The resolution of primary display (L, C, R, **R** or **Z**) is to be five digits.
*The resolution of secondary display (D, Q, R with C, or **R** with **L**) is to be four digits.
*The resolution of secondary display (?) is to be 2 digits after decimal dot.
- DELTA%** : The DELTA% shows the percent deviation of the measured L, C, R or **Z** value from a saved NOMINAL VALUE. The sign of deviation is indicated.
- DELTA** : The LCR difference is similar to the DELTA% except that the deviation is shown in suitable units (ohms, henries, etc.)

Measurement Speed (LCR-816/817/819/821):

SLOW	: 896ms
MEDI	: 286ms
FAST	: 135ms

*For LCR-826/827/829, please refer to 4-5-10. Handler Interface Timing.

Equivalent Circuit:

The L, C, R, or Z equivalent SERIES or PARALLEL circuit can be selected by keypad.

* When select Z/? mode, the PARALLEL circuit is invalid. Please refer to 4-4-2. Series & Parallel Equivalent Circuit from page for details.

Measurement Modes:

Two modes are available: AUTO and MANUAL.

“AUTO” mode is measuring continuously, updating the display after each measurement.

“MANUAL” mode is activated by the START keypad, the measured result is holding on the LCD monitor until next measurement started.

Average:

The AVERAGE of any number of measurements from 1 to 255 can be made as desired in either of the two measurement modes.

In “AUTO” mode, only the final value is shown.

In “MANUAL” mode, the running average is shown and the final value held until the START keypad is depressed again.

Test Voltage:

The test voltage range for LCR-817/819/827/829 is from 5mV to 1.275V, each step is 5mV, for LCR-816/826 is from 0.1V to 1.275V, each step is 5mV.

Memory:

100 memory blocks totally.

DC Bias:

A 2V internal bias can apply to capacitors during measurement.

Up to 30VDC external bias can apply to capacitors during measurement via the two terminals (located on the rear panel). The applied current should not over 200mA.

* The external bias specified on the rear panel is at 30VDC, actually, it can be tolerated to 35VDC.

LCD monitor:

240×128 dot matrix C.C.F.L. back light LCD with adjustable contrast.

Battery:

DC source for system memory and calibration data backup, a replaceable 3V lithium battery (BR-2/3A type) which probably needs to be replaced after using for 3 years.

After the battery is replaced, the LCR Meters have to be re-calibrated!

Operation Environment:

Indoor use,

Altitude up to 2000M

Installation Category II

Pollution Degree 2

Operating temperature: 10 50 , < 85% relative humidity

Storage temperature: - 20 60

AC Power Source:

AC 100 240V, 50Hz 60Hz

Power Consumption:

45 Watts maximum

Fuse Replacement:

Slow -Blow, 3A, 250V

Dimensions:

330mm (W) × 149mm (H) × 437mm (D)

Weight:

5.5 kg

The Error value of LCR-817/819 (Double the error value for LCR-827/829/816/826)

- The formula for primary readout accuracy of C, R, L, **L and Z**.

C: $0.03\% + 0.02\% [(1+Ka)^{\#} \text{ or } (X/Ymax)^{\#} \text{ or } (Ymin/X)^{\#}] (1+ D) (1+Kb+Kc)$

R: $0.03\% + 0.02\% [(1+Ka)^{\#} \text{ or } (X/Ymax)^{\#} \text{ or } (Ymin/X)^{\#}] (1+ Q) (1+Kb+Kc)$

L: $0.03\% + 0.02\% [(1+Ka)^{\#} \text{ or } (X/Ymax)^{\#} \text{ or } (Ymin/X)^{\#}] (1+ 1/ Q) (1+Kb+Kc)$

[Z]: Ze = Treat R, L or C as the object under test conforming above formula:

example:

When the object under test is C, select:

Ze = $0.03\% + 0.02\% [(1+Ka)^{\#} \text{ or } (X/Ymax)^{\#} \text{ or } (Ymin/X)^{\#}] (1+ D) (1+Kb+Kc)$

When the object under test is R, select:

Ze = $0.03\% + 0.02\% [(1+Ka)^{\#} \text{ or } (X/Ymax)^{\#} \text{ or } (Ymin/X)^{\#}] (1+ Q) (1+Kb+Kc)$

When the object under test is L, select:

Ze = $0.03\% + 0.02\% [(1+Ka)^{\#} \text{ or } (X/Ymax)^{\#} \text{ or } (Ymin/X)^{\#}] (1+ 1/ Q) (1+Kb+Kc)$

- The formulas of secondary readout accuracy for D, Q, **and ? ..**

Error	
D with C	$2count \pm 0.0003 + 0.0002[(1+Ka)^{\#} \text{ or } (X/Ymax)^{\#} \text{ or } (Ymin/X)^{\#}] (1+ D + D)(1+Kb+Kc)$
Q with R	$2count \pm 0.0003 + 0.0002[(1+Ka)^{\#} \text{ or } (X/Ymax)^{\#} \text{ or } (Ymin/X)^{\#}] (1+ Q + Q)(1+Kb+Kc)$
Q with L	$2count \pm 0.0003 + 0.0002[(1+Ka)^{\#} \text{ or } (X/Ymax)^{\#} \text{ or } (Ymin/X)^{\#}] (1+ Q + Q)(1+Kb+Kc)$
? with Z	$?e = (180/p) \times (Ze/100)$

1. if $X < Ymax$, please select $(X/Ymax)$
2. if $X < Ymin$, please select $(Ymin/X)$
3. if $Ymin < X < Ymax$, please select $(1+Ka)$
4. **Ze is impedance error**
5. **?e is ? error**

- The formulas for secondary readout accuracy of R with **C& R with L**.

Error	
D 1	$2count + 0.02\% [(1+Ka)^{\#} \text{ or } (R/Rmax)^{\#} \text{ or } (Rmin/R)^{\#}] (1+ 1/ D) (1+Kb+Kc) + 0.03\%$
D 1	$2count + 0.02\% [(1+Ka)^{\#} \text{ or } (C/Cmax)^{\#} \text{ or } (Gmin/C)^{\#}] (1+ 1/ D) (1+Kb+Kc) + 0.03\%$

- *: 1. If $Rx < Rmax$, please select $(R/Rmax)$
 2. if $Rx < Rmin$, please select $(Rmin/Rx)$
 3. if $Rmin < Rx < Rmax$, please select $(1+Ka)$

- ** : 1. If $Cx < Cmax$, please select $(C/Cmax)$
 2. if $Cx < Cmin$, please select $(Cmin/Cx)$
 3. if $Cmin < Cx < Cmax$, please select $(1+Ka)$

Where

Ka: Constant Voltage factor

Constant Voltage On, $Ka = 2$

Constant Voltage Off, $Ka = 0$

Kb: Test Speed factor

Speed = SLOW, $Kb = 0$

Speed = MEDIUM, $Kb = 3$

Speed = FAST, $Kb = 10$

Kc: Frequency & RMS Voltage factor (refer to Table A)

X: X is value of the component being tested.

Y: Y is range constant (refer to Table B)

Rx and Cx are value of the component being tested.

Rmax, Rmin, Cmax and Cmin are ranges constant (refer to Table B).

Table A: (for range 1,2,3) –Kc

Voltage Frequency	0.03 V < 0.1		0.1 V < 0.25		0.25 V < 1		1 V 1.265	
	0.03	V < 0.1	0.1	V < 0.25	0.25	V < 1	1	V 1.265
0.012 F < 0.03	35		12		9		7	
0.030 F < 0.1	30		8		5		3	
0.1 F < 0.25	25		6		3		2	
0.25 F < 1	20		5		2		1	
1	14		4		1		0	
1 < F 3	15		5		2		1	
3 < F 6	15		6		3		2	
6 < F 10	15		8		5		3	
10 < F 20	20		10		6		5	
20 < F 50	30		22		18		15	
50 < F 100	50		40		35		30	
200	50		40		35		30	

F: test frequency in kHz

Table A: (for range 4)-Kc

Voltage Frequency	0.03 V < 0.1		0.1 V < 0.25		0.25 V < 1		1 V 1.265	
	0.03	V < 0.1	0.1	V < 0.25	0.25	V < 1	1	V 1.265
0.012 F < 0.03	70		20		10		7	
0.030 F < 0.1	50		13		6		3	
0.1 F < 0.25	35		9		4		2	
0.25 F < 1	25		6		2		1	
1	15		4		1		0	
1 < F 3	17		6		3		2	
3 < F 6	25		15		10		6	
6 < F 10	60		30		20		15	
10 < F 20	Not specified		100		65		50	
20 < F 50 50 < F 200	This range is not used above 20kHz							

F: test frequency in kHz

Table B-1: Range Hold

Component Range	Inductor		Capacitor		Resistor/Impedance	
	Max	Min	Max	Min	Max	Min
Range1	16mH /f	1mH /f	25uF /f	1.6uF /f	100	6.25
Range2	256mH /f	16mH /f	1600nF /f	100nF /f	1.6k	0.1k
Range3	4100mH /f	256mH /f	100nF /f	6.4nF /f	25.6k	1.6k
Range4*	65H/f	4.1H /f	6400pF /f	400pF /f	410k	25.6k

f = test frequency in kHz

*: This range is not used above 20kHz

Table B-2: Auto Range

Component Range	Inductor		Capacitor		Resistor/Impedance	
	Max	Min	Max	Min	Max	Min
Auto range	65H /f**	1mH /f	25uF /f	400pF /f**	410k **	6.25 **

** : Above 20kHz, Cmi n = 6.4 nF/f ,and Lmax = 4100mH/f

6. MESSAGE CODE

This section describes the message code for the LCR Meters.

OVER-01

Cause:

1. If the impedance of “Device-under-test” is small than the existing measurement range of the LCR Meters, the “OVER-01” message will be displayed on the LCD monitor.

Calculation formula

Capacitance: $XC=1/2 \ fC$

Inductance: $XL=2 \ fL$

where f=test frequency in Hz

2. If the inductor of “Device-under-test” is very large at a very high “test frequency”, the “Resonance effect” will occur and the impedance will decrease. Hence, the measured value is useless. Meanwhile, an “OVER-01” message will be displayed on the LCD monitor.

Solution:

1. Turn on the “Constant Voltage” mode (please refer to 4-5-5. Constant Voltage Source, page 22, for details).
2. Select the less measurement range. Please refer to table B-1: Range Hold, page 42, in order to reach the exact measurement range. Turn on the “Range Hold” mode after the measurement range fixed.

Note: Both two solutions will reduce the accuracy of the LCR Meters.

7. MAINTENANCE

This section includes the basic maintenance information for the LCR Meters.

7-1. Cleaning

Remove the AC input power (disconnect and remove the power cord) from the LCR Meters before attempting to clean the instrument.

To clear the LCR Meters, use soft cloth dampened in a solution of mild detergent and water. Do not spray cleaner directly onto the instrument, since it may leak into the cabinet and cause damage.

Do not use chemicals containing benzene, benzene, xylene, acetone, toluene, or similar solvents.

Do not use abrasive cleaners on any portion of this equipment.

7-2. Battery Replacement

A replaceable 3V lithium battery (BR-2/3A type) supplies the backup power of non-volatile memory for the LCR Meters. This battery probably needs to be replaced after using for 3 years.



CAUTION: Danger of explosion if battery is incorrectly replaced. Replace only with the same or equivalent type recommended by the manufacturer. Discard used batteries according to the manufacturer's instructions.

7-3. Recall Calibration

When the measured value is inaccurate, you can use the Recall Calibration function to rework by proceeding the steps as follows:

- Press **MENU** key. (Figure 7-1)
- Press **F3** key to select "SET PARAMETER" function. (Figure 7-2)
- Press **F4** key to select "RECALL CALIBRATION" function. (Figure 7-3)
- Press compound Key 1 to select the "Yes" to start recall calibration. (Figure 7-4)
- Press compound Key 2 to select the "No" to stop recall calibration. (Figure 7-4)

If the function key s are not active, try again for 2 minutes without turning off the Power.

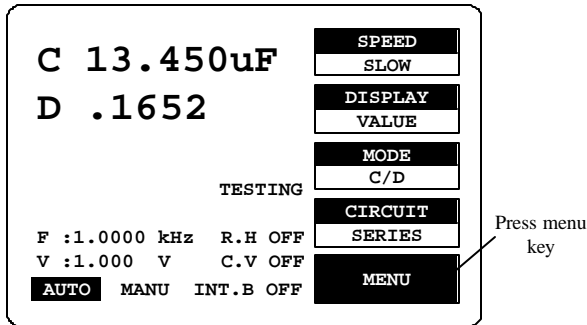

Figure 7-1

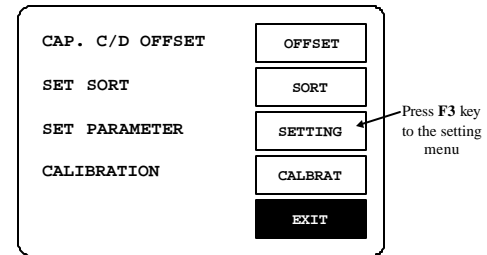

Figure 7-2

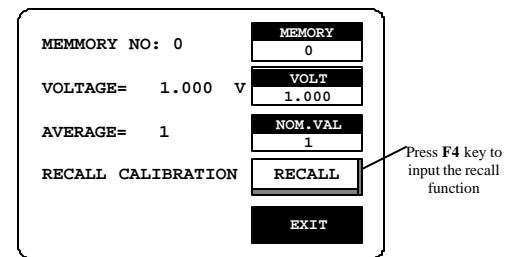

Figure 7-3

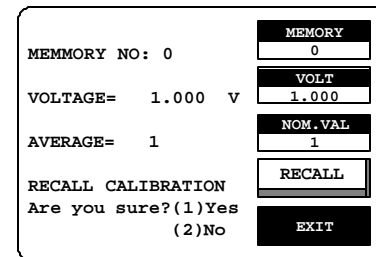

Figure 7-4

8. OPTION 1 (BIN Functions, only for LCR-826/827/829)

8-1. BIN FUNCTIONS for Components Sorting:

Proceed BIN FUNCTIONS steps (Figure 8-1) :

- Press **MENU** key.
- Press **F2** key to select “SORT” function.
- Press **F2** key to select “OPTION1 ” function.

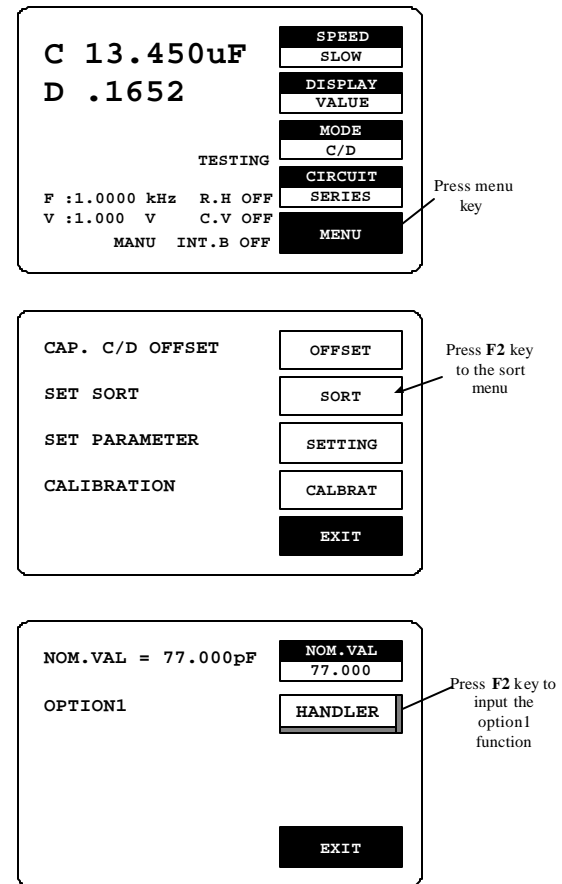

Figure 8-1.: OPTION 1 (BIN FUNCTIONS) setting

8-2. BIN setting conditions:

MODE setting :

- Press F1.F2 key to select the white inverted characters “MODE”.
 - Press F3 key to select C/D or C/R or L/Q or R/Q shown as Figure 8-2 below.
- For further detailed description, please refer to 4-4-1.

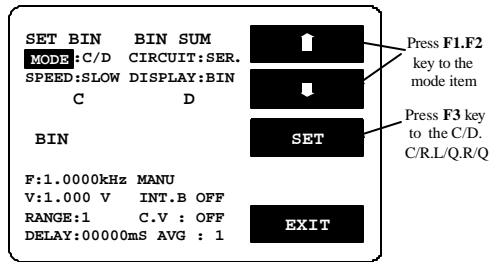

Figure 8-2

CIRCUIT setting:

- Press F1/F2 key to select the white inverted characters “CIRCUIT”.
- Press F3 key to select SER or PAR shown as Figure 8-3 below. For further details, please refer to 4-4-2

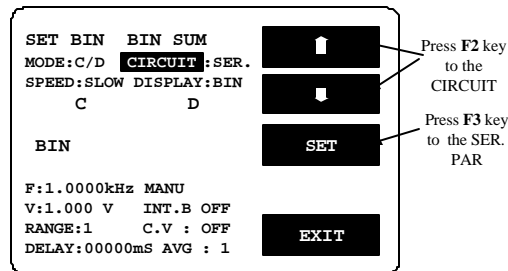

Figure 8-3

SPEED setting:

- Press F1/F2 key to select the white inverted characters “SPEED”.
 - Press F3 key to select FAST, SLOW or MEDI shown as Figure 8-4 below.
- For further details, please refer to 4-4-5.

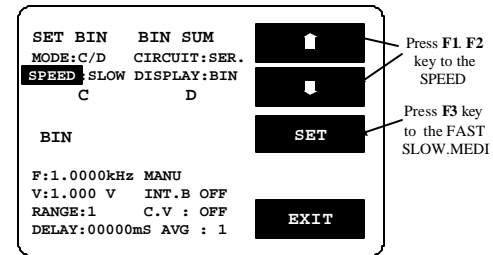

Figure 8-4

DISPLAY setting:

- Press F1/F2 key to select the white inverted characters “DISPLAY”.
- Press F3 key to select BIN, VAL or OFF shown as Figure 8-5 (When the BIN is selected, BIN1~BIN13 represents PASS, while PHI, PLO, and SREJ represents FAIL result. The VAL is to display test value while the OFF represents as non-display.)

The display speed for above three selections is different from one another.

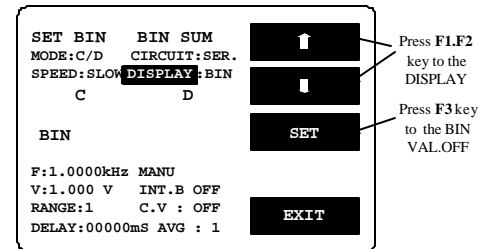



Figure 8-5

F setting (FREQUENCY):

- Press F1/F2 key to select the white inverted characters “F”.
- Key-in testing frequency through panel keyboard.
- Press  key shown as Figure 8-6 below. For further details, please refer to 4-5-2

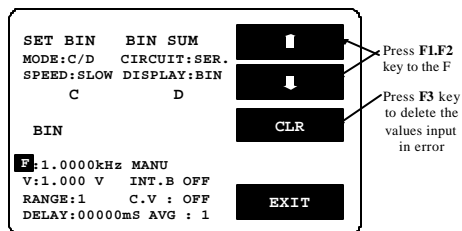



Figure 8-6

V setting (VOLTAGE):

- Press F1/F2 key to select the white inverted characters “V”.
- Key-in testing voltage through panel keyboard.
- Press  key shown as Figure 8-7 below. For further details, please refer to 4-5-4.

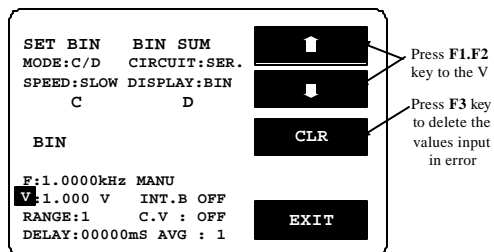

Figure 8-7

INT.B setting:

- Press F1/F2 key to select the white inverted characters “V”.
- Press F3 or F4 key to select INT or ENT shown as Figure 8-8 below. For further details, please refer to 4-5-1.

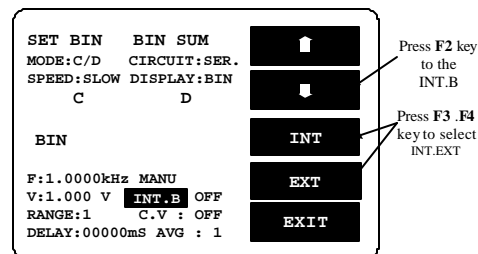

Figure 8-8

INT.B ON OFF setting:

- Press F1/F2 key to select the white inverted characters “ON/OFF” of INT.B.
- Press F3 or F4 key to select ON or OFF shown as Figure 8-9 below.

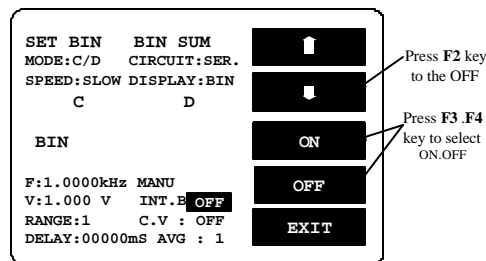

Figure 8-9

RANGE setting:

- Press F1/F2 key to select the white inverted characters “RANGE”.
- Press F3 or F4 key to select up or down value within 1~4 range shown as Figure 8-10 below.

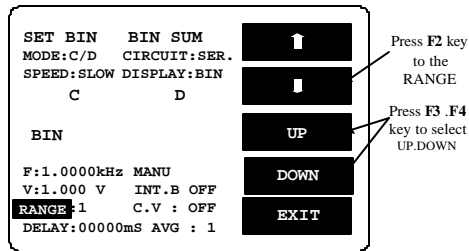

Figure 8-10

C.V setting:

- Press F1/F2 key to select the white inverted characters “C.V”.
- Press F3 or F4 key to select ON or OFF shown as Figure 8-11 below. For further details, please refer to 4-5-5.

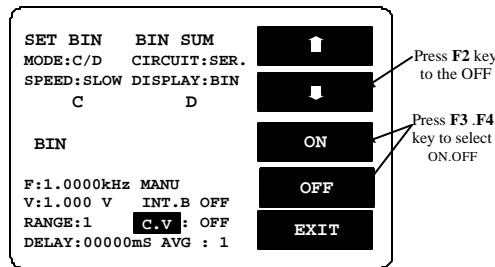

Figure 8-11

DELAY setting:

- Press F1/F2 key to select the white inverted characters “DELAY”.
- Key-in Delay value(0~99999ms) through panel keyboard.
- Press $\bar{\Delta}$ key. Please refer to Figure 8-12 below.

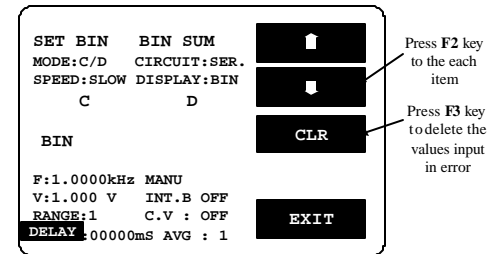

Figure 8-12

AVG setting:

- Press F1/F2 key to select the white inverted characters “AVG”.
- Key-in average value through panel keyboard.
- Press $\bar{\Delta}$ key shown as Figure 8-13 below. For further details, please refer to 4-5-7.

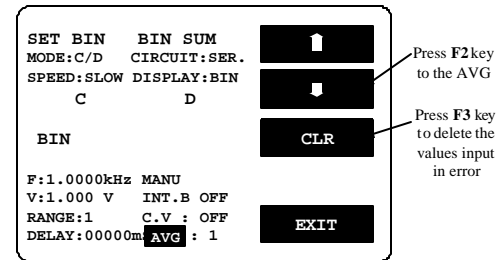

Figure 8-13

8-3. BIN Range Setting: Component Sorting Range

The step for BIN setting: (Please refer to Figure 8-14)

- When the **SET BIN** inverts to white character, press **F3** key.
- Press **F3** key to select C or D sorting (The selected is a primary parameter, the other one is an assistant parameter.)
- BIN clear setting by pressing **F1** key.
- Press **F1** key to maintain setting, Press **F2** key to delete the setting.

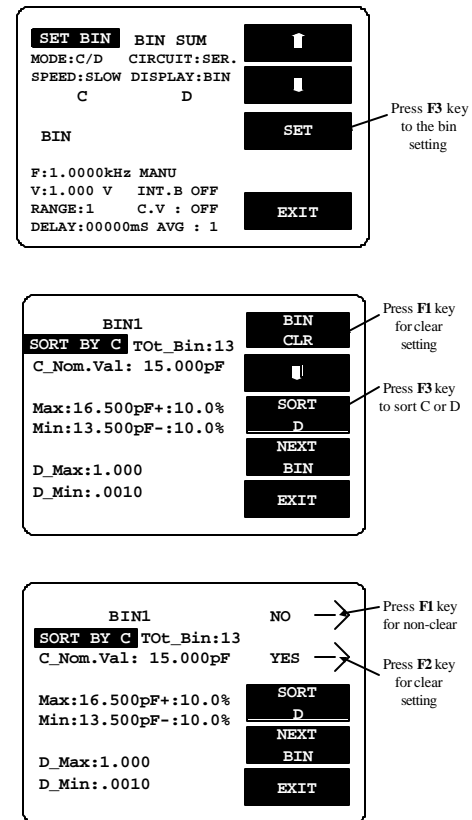

Figure 8-14

Tot_BIN setting:

- Press F1/F2 key to select the white inverted characters “Tot_Bin”.
- Key-in needed BIN value through panel keyboard.
- Press \downarrow key. Please refer to Figure 8-15 below.

Note: Tot_Bin setting: It can select ascending from 1 to 13 BIN the most.

For example: If BIN1 sorting range is at $\pm 5\%$, then BIN2 sorting range must be larger than $\pm 5\%$, the rest can be done accordingly.

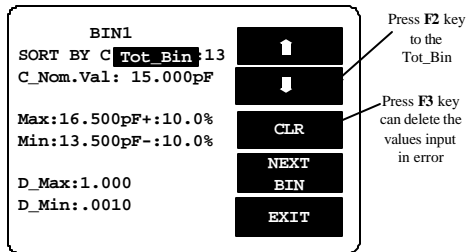

Figure 8-15

C_Nom.Val setting:

- Press F1/F2 key to select the white inverted characters “C_Nom.Val”.
- Key-in Nominal Value through panel keyboard.
- Press \downarrow key. Please refer to Figure 8-16 below.

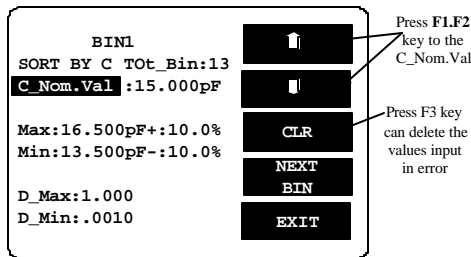

Figure 8-16

Max setting:

- Press F1/F2 key to select the white inverted characters “Max”.
- Key-in SORT Max value through panel keyboard.
- Press \downarrow key. Please refer to Figure 8-17 below.

After the value is input, it will proceed conversion of +% automatically.

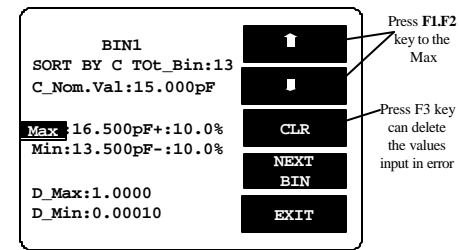

Figure 8-17

“+” setting:

- Press F1/F2 key to select the white inverted characters “+”.
- Key-in the largest percentage of SORT Nominal Value through the panel keyboard.
- Press \downarrow key. Please refer to Figure 8-18 below.

After the value is input, it will proceed conversion of Max automatically.

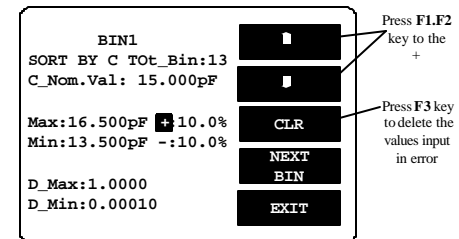

Figure 8-18

Min setting:

- Press F1/F2 key to select the white inverted characters “Min”.
- Key-in SORT Min value through panel keyboard.
- Press \square key. Please refer to Figure 8-19 below.
After the value is input, it will proceed conversion of -% automatically.

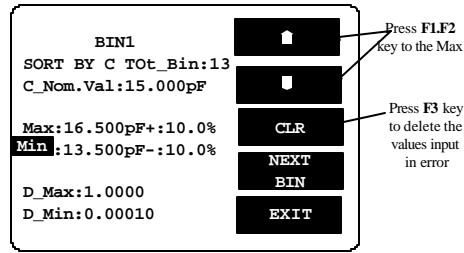

Figure 8-19

“-” setting:

- Press F1/F2 key to select the white inverted characters “-”.
- Key-in the smallest minus percentage of SORT Nominal Value through the panel keyboard.
- Press \square key. Please refer to Figure 8-20 below.
After the value is input, it will proceed conversion of Min automatically.

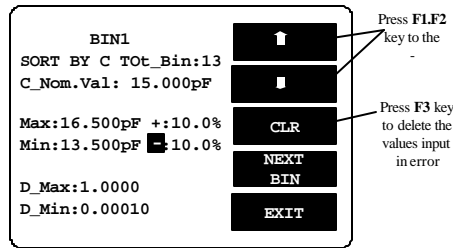

Figure 8-20

D_Max setting :

- Press F1/F2 key to select the white inverted characters “D_Max”.
- Set the largest D value of secondary parameter. Please refer to Figure 8-21 below.

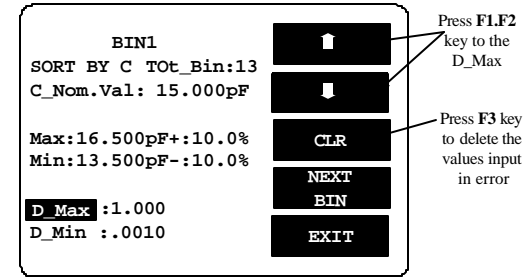

Figure 8-21

D_Min setting:

- Press F1/F2 key to select the white inverted characters “D_Min”.
- Set the smallest D value of secondary parameter. Please refer to Figure 8-22.

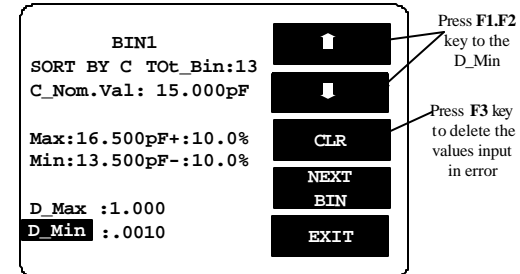

Figure 8-22

The other BIN setting:

- When the BIN 1 setting is finished, press F4 key to continue the BIN 2 setting until all the Tot BIN setting is completed (BIN1~BIN13 the most), please refer to Figure 8-23.

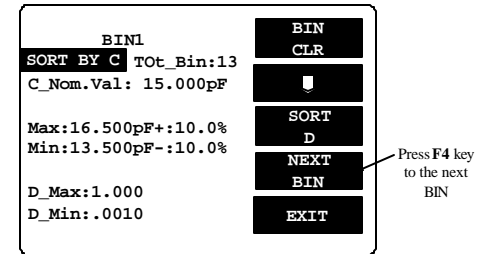

Figure 8-23

TEST RESULT Display Summing-up:

- Press F1/F2 key to select the white inverted characters “BIN.SUM” (Figure 8-24)
- Press **F3** key to see the test result.
Sorting judging rule: To check whether the secondary parameter is within the test range, if not, just display SREJ instead of judging the primary parameter, if yes, continue to proceed primary parameter sorting.
- Press **F4** key to delete test result (Figure 8-25).
- Press **F3** or **F4** key to select delete or non-delete test result (Figure8-26).
- Press **F2** key to see ne xt page of test result (Figure 8-27, 8-28).

```

SET BIN  BIN SUM  [UP]
MODE:C/D  CIRCUIT:SER
SPEED:SLOW  DISPLAY:BIN
C          D
BIN
F :1.0000kHz  MANU
V :1.000 V  INT.B OFF
RANGE:1     C.V : OFF
DELAY:0000ms  AVG : 1
EXIT
    
```

Press F1/F2 key to the BIN SUM

Press F3 key to the test result

Figure 8-24

```

SORT BY C  NOM_VAL:15.000pF
D_MIN: .0010  D_MAX: 1.000
TEST RESULT
FAIL_ITEM  TOTAL
PHI ( C >MAX )
PLO ( C <MIN )
SREJ( D NG ) 2
TOTAL        2
PASS_ITEM
BIN 1 - BIN 13
CLR.
EXIT
    
```

Press F4 to CLR

Figure 8-25

```

SORT BY C  NOM_VAL:15.000pF
D_MIN: .0010  D_MAX: 1.000
TEST RESULT
FAIL_ITEM  TOTAL
PHI ( C >MAX )
PLO ( C <MIN )
SREJ( D NG ) 2
TOTAL        2
PASS_ITEM
BIN 1 - BIN 13
NEXT PAGE
YES
NO
EXIT
    
```

Press F3 to delete the testing data

Press F4 to maintain the testing data

Figure 8-26

```

SORT BY C  NOM_VAL:15.000pF
D_MIN: .0010  D_MAX: 1.000
TEST RESULT
FAIL_ITEM  TOTAL
PHI ( C >MAX )
PLO ( C <MIN )
SREJ( D NG ) 2
TOTAL        2
PASS_ITEM
BIN 1 - BIN 13
NEXT PAGE
CLR.
EXIT
    
```

Press F2 to next page

Figure 8-27

BIN	MIN pF	MAX pF	TOTAL
1	13.500	16.500	999999
2	12.750	17.250	999999
3	12.000	18.000	999999
4	11.250	18.750	999999
5	10.500	19.500	999999
6	9.750	20.250	999999
7	9.000	21.000	999999
8	8.250	21.750	999999
9	7.500	22.500	999999
10	6.750	23.250	999999
11	6.000	24.000	999999
12	5.250	24.750	999999
13	4.500	25.500	999999

LAST PAGE

EXIT

Figure 8-28

9. OPTION 2 (for LCR-816/817/819/821, RS-232 is a standard accessory)

9-1. On-line Procedure

- 1) Power on the LCR METER.
- 2) Power on the RS232 function of LCR METER. With the steps as follows (Figure 1):
 - Press **MENU** key.
 - Press **F2** key to select "SORT" function.
 - Press **F3** key to select "OPTION 2" function.
 - Press **F1** key to select "RS232" ON.
- 3) Run PC LCR-VIEW Program.
- 4) Check the contents of the Message area under the LCR-VIEW to make sure the Online Procedure has been well done. If not, select the setting items above the LCR-VIEW to change the Com port and make connection again until it is online. Please refer to Figure 9-2, 9-3, 94.

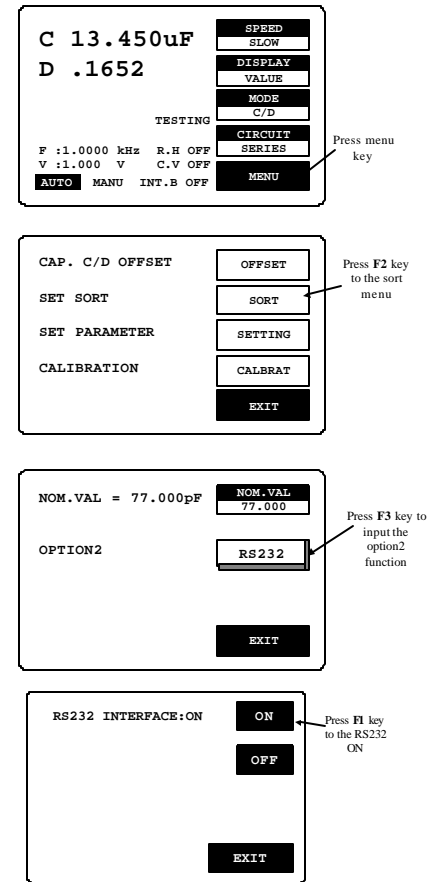

Figure 9-1

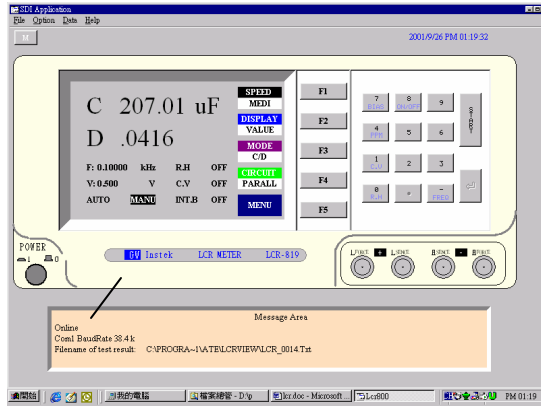

Figure 9-2

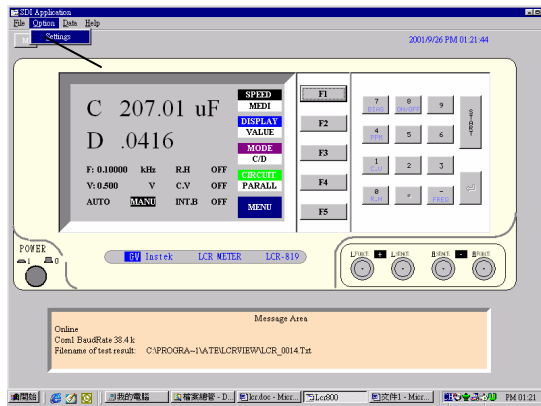

Figure 9-3

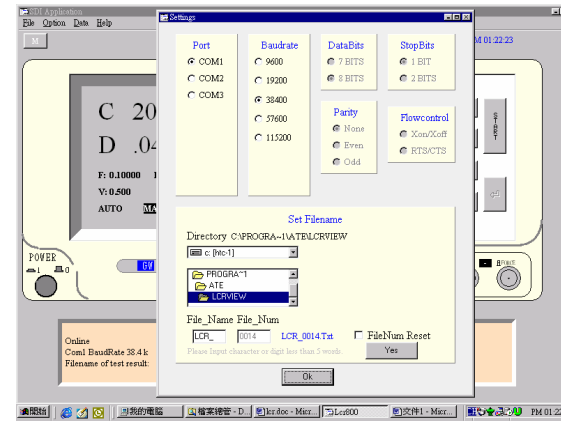

Figure 9-4

- 5) After online, the picture of LCR Meter will be switched to “RS232 ONLINE”, please refer to Figure 9-5.

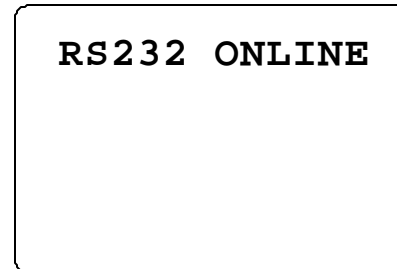

Figure 9-5

9-2. RS232 VIEWER Software Operation

1) File

Press Exit (Figure 9-6) , or press Power to leave the program.

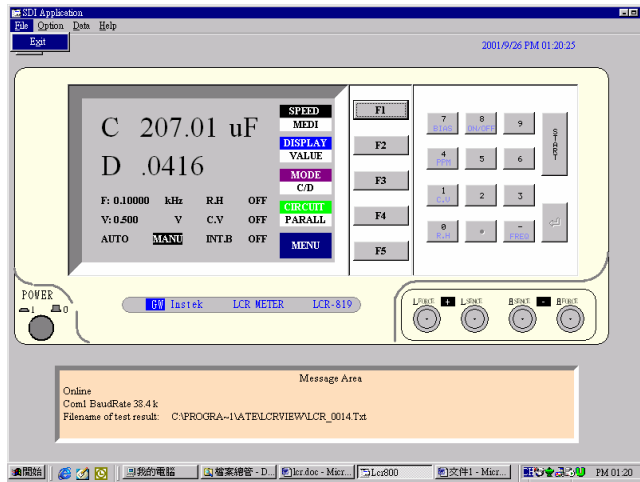

Figure 9-6

2) Option

Settings

Port: There are three Ports available for selection including Com1, Com2 and Com3. The default value is Com1.

Baudrate: After online, there are five Baudrates available for selection including 9600, 19200, 38400, 57600 and 115200. The default value is 38400.

DataBits: There are 8 bits of Data bits and User can not change it.

Parity: None. User can not change it.

StopBits: There is only 1 Bit of StopBits, and User can not change it (Figure 9-7).

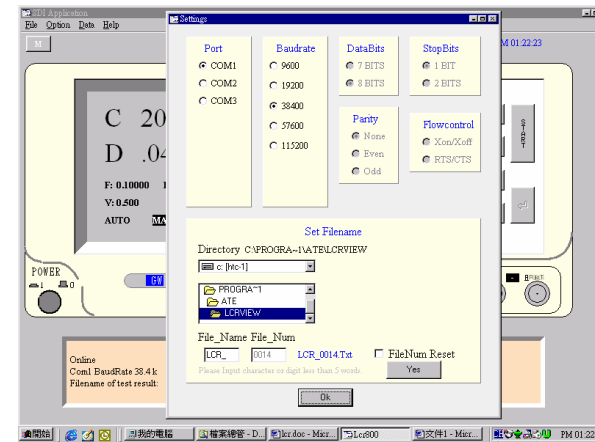

Figure 9-7

3) Set Filename

This filename setting is the route for saving test result.

Driver: Set driver,

Directory: Set directory,

File_Name: Set file name with 4 alphabets or 4 numbers input.

File_Num: Set 4 codes of file numbers from 0001 to 9999. When the test results data reaches to the number of 10000 can be stored with a file number.

Test Result	File_Name	File_Num	Filename
1-10000	LCR_	0001	LCR_0001.Txt
10001-20000	LCR_	0002	LCR_0002.Txt
20001-30000	LCR_	0003	LCR_0003.Txt
30001-40000	LCR_	0004	LCR_0004.Txt
40001-50000	LCR_	0005	LCR_0005.Txt
50001-60000	LCR_	0006	LCR_0006.Txt

99980001-99990000 | LCR_ | 9999 | LCR_9999.Txt

FileNum Reset (refer to the following figure): File_Num is 0001.

Ps. File_Num will be continued from last file number of test result. If last file number is end at 0006, next file number is started from 0007 when re-power on the unit.

If want to start from 0001, reset the FileNum (refer to Figure 9-8).

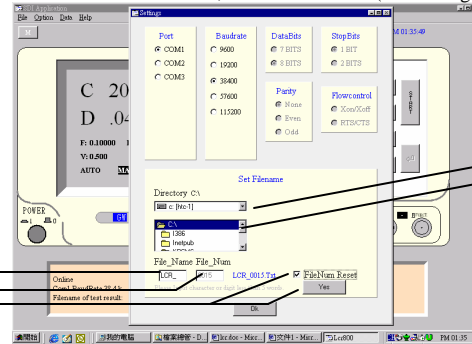

Figure 9-8

4) Data

Result : Display test results. When the test results data reaches to the number of 10000 will be stored in a file automatically. If want to store the data less than the number of 10000, must exit the LCR-VIEW first (the data can be stored automatically), then execute again the LCR -VIEW to start another counting of test result data. Please refer to Figure 99 and 9-10.

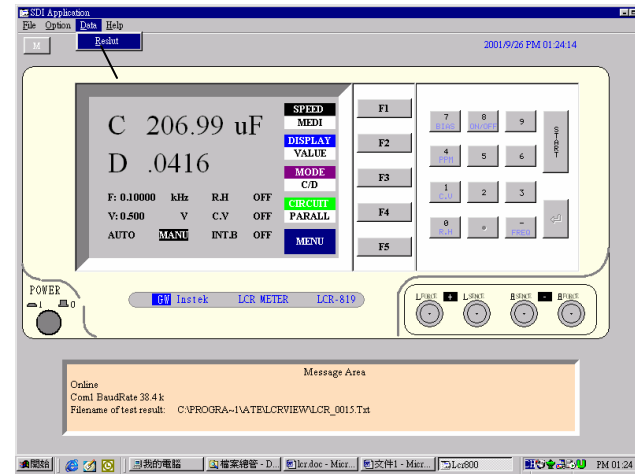

Figure 9-9

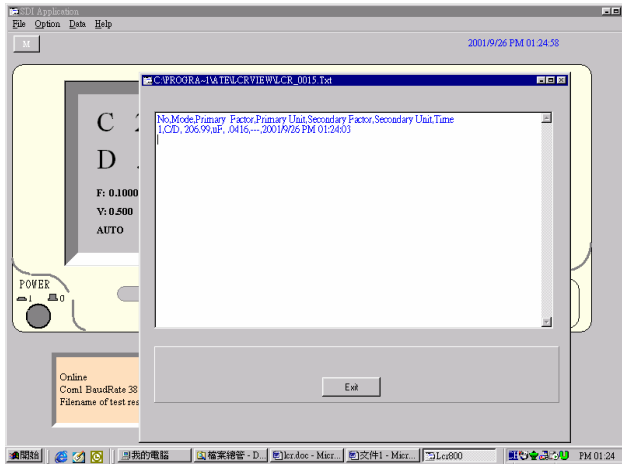
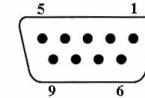

Figure 9-10

9-3. The Configuration of Cable

Use the cable between DCE and DTE.



9 PIN DSUB FEMALE to Computer (DSUB1)

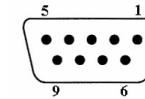

9 PIN DSUB FEMALE to LCR Meter (D-SUB2)

	D-SUB 1	D-SUB 2	
Receive Data	2	3	Transmit Data
Transmit Data	3	2	Receive Data
Data Terminal Ready	4	6+1	Data Set Ready + Carrier Detect
System Ground	5	5	System Ground
Data Set Ready + Carrier Detect	6+1	4	Data Terminal Ready
Request to Send	7	8	Clear to Send
Clear to Send	8	7	Request to Send