

Leader

LT4670

SYNC GENERATOR

LT4670-SER01	GNSS
LT4670-SER02	SDI
LT4670-SER03	PTP
LT4670-SER04	25G-IP/12G-SDI TSG
LT4670-SER11	POWER UNIT
LT4670-SER21	4K 3G-Quad Link

Instruction Manual

Thank you for your purchase.

Please read this instruction manual and the included "GENERAL SAFETY SUMMARY" thoroughly, and use the product safely.

TABLE OF CONTENTS

GENERAL SAFETY SUMMARY	I
1 INTRODUCTION.....	1
1.1 User Registration.....	1
1.2 Scope of Warranty.....	1
1.3 Trademark Acknowledgments	1
1.4 Operating Precautions.....	2
1.4.1 Power Supply Voltage	2
1.4.2 Maximum Allowable Input Voltage.....	2
1.4.3 Mechanical Shock	2
1.4.4 Electrostatic Damage	2
1.4.5 Warming Up.....	2
2 PRODUCT CONFIGURATION.....	3
2.1 Main Unit	3
2.2 Hardware Options	3
2.3 Software Options	4
3 SPECIFICATIONS.....	5
3.1 General.....	5
3.2 Features.....	5
3.2.1 LT4670.....	5
3.2.2 LT4670-SER01 (GNSS).....	7
3.2.3 LT4670-SER02 (SDI).....	7
3.2.4 LT4670-SER03 (PTP)	8
3.2.5 LT4670-SER04 (25G-IP).....	9
3.2.6 LT4670-SER04 (12G-SDI).....	9
3.2.7 LT4670-SER11 (POWER UNIT).....	11
3.2.8 LT4670-SER21 (4K 3G-Quad Link).....	11
3.3 Standards.....	13
3.3.1 LT4670.....	13
3.3.2 LT4670-SER01 (GNSS).....	21
3.3.3 LT4670-SER02/SER04/SER21 (SDI).....	22
3.3.4 LT4670-SER03 (PTP)	29
3.3.5 LT4670-SER04 (25G-IP).....	31
3.3.6 LT4670-SER11 (POWER UNIT).....	33
3.3.7 SFP Transceiver (Sold Separately).....	33
4 PANEL DESCRIPTION.....	34
4.1 Front Panel.....	34
4.2 Rear Panel.....	37

5	PREPARATIONS.....	41
5.1	Installation	41
5.1.1	Rack Mounting	41
5.1.2	Installation Without Using a Rack	42
5.2	Turning the Power On	43
5.2.1	Turning the Instrument On and Off.....	43
5.2.2	Mounting the AC Cord Clamp	44
5.2.3	Adding the Power Supply Unit (SER11)	45
6	BASIC OPERATION	47
6.1	Operation Basics	47
6.1.1	Connecting a USB Memory Device	47
6.1.2	Enabling the Key Lock	47
6.1.3	Menu Operations	48
6.2	Signal Input (Genlock Operation)	51
6.2.1	Internal Mode	52
6.2.2	Genlock Mode	53
6.2.3	CW Mode.....	55
6.2.4	GNSS mode (SER01).....	57
6.2.5	PTP mode (SER03)	59
6.3	Signal Output.....	62
6.3.1	Analog Black Signal Output.....	62
6.3.2	Audio Signal Output.....	62
6.3.3	CW/1PPS Signal Output.....	62
6.3.4	SDI Signal Output (SER02)	62
6.3.5	SDI Signal Output (SER04)	63
6.3.6	PTP Signal Output (SER03).....	63
6.3.7	IP Signal Output (SER04)	65
6.4	LTC Signal I/O and Remote Control	66
6.5	Alarm Display	68
6.6	L-SYNC	69
7	REFERENCE CONFIG MENU	71
7.1	Selecting the Reference Signal	71
7.2	Selecting the Genlock Format	72
7.3	Setting the Genlock Timing.....	73
7.4	Selecting the Satellite (SER01).....	73
7.5	Setting the Recovery Operation.....	74
7.5.1	Selecting the Recovery Mode	74
7.5.2	Selecting the Relock Speed (Auto)	74
7.5.3	Selecting the Relock Speed (Manual).....	75
7.5.4	Power-on Settings	75
7.6	Setting the Relock	75
7.7	Selecting the Time Source	76
7.8	Loading the Date and Time	77

8	BLACK CONFIG MENU	78
8.1	Selecting the Black Format	78
8.2	Configuring Timing Data	79
8.2.1	Adjusting the Timing (Frame)	79
8.2.2	Adjusting the Timing (Line)	79
8.2.3	Adjusting the Timing (Dot)	80
8.3	Setting the Time Code	80
8.3.1	Turning Time Code Insertion On and Off.....	80
8.3.2	Setting Dropped Frames.....	81
8.3.3	Setting the Time Code Superimposition Line	81
8.4	Setting the Black Output	82
8.4.1	Turning the Black Output On and Off.....	82
8.4.2	Turning BMCA Linkage On and Off (SER03)	82
8.5	Settings Shared by Black Outputs.....	83
9	AUDIO CONFIG MENU.....	84
9.1	Setting the AES/EBU Output	84
9.1.1	Selecting the Frequency	84
9.1.2	Setting the Level	84
9.1.3	Setting Clicks	85
9.1.4	Settings Shared by Channels.....	85
9.1.5	Selecting the Resolution	85
9.1.6	Selecting the Pre-emphasis Mode	86
9.1.7	Turning Time Code Insertion On and Off.....	86
9.1.8	Adjusting the Timing.....	86
9.1.9	Turning Lip Sync Interlock On and Off (SER02/SER04).....	87
9.2	Setting the Silence Output.....	87
9.2.1	Settings Shared with the AES/EBU Output.....	87
9.2.2	Selecting the Resolution	88
9.2.3	Adjusting the Timing.....	88
9.3	Setting the Word-clock Output.....	89
9.3.1	Adjusting the Timing.....	89
10	LTC CONFIG MENU	90
10.1	Turning the LTC Output On and Off.....	90
10.2	Selecting the LTC Format	90
10.3	Adjusting the Timing (Frame)	91
10.4	Adjusting the Timing (Bit)	91
10.5	Adjusting the Offset.....	91
10.6	Setting Dropped Frames.....	92
10.7	Settings Shared by LTC Outputs	92
11	CW/1PPS CONFIG MENU	93
11.1	Switching the Output Signal.....	93

12	SDI CONFIG MENU (SER02/SER04)	94
12.1	Selecting the Frequency Group	95
12.2	Setting the SDI Format	96
12.2.1	Selecting the System	96
12.2.2	Selecting the Color System	97
12.2.3	Selecting the Frame Frequency	97
12.3	Configuring Timing Data	98
12.3.1	Selecting the Timing Reference	98
12.3.2	Adjusting the Timing (Line)	98
12.3.3	Adjusting the Timing (Dot)	99
12.4	Configuring Fixed Patterns	99
12.5	Configuring User Patterns	102
12.5.1	Displaying a User Pattern	102
12.5.2	Selecting and Transferring a User Pattern	106
12.5.3	Clearing a User Pattern	107
12.5.4	Copying a User Pattern from a USB Memory Device to the Instrument	108
12.5.5	Copying a User Pattern from the Instrument to a USB Memory Device	110
12.6	Turning YCbCr/GBR On and Off	112
12.7	Turning Safety Area Markers On and Off	112
12.8	Configuring the Pattern Scroll Feature	113
12.8.1	Turning Scrolling On and Off	113
12.8.2	Setting the Scroll Speed (Vertical)	113
12.8.3	Setting the Scroll Speed (Horizontal)	114
12.9	Setting the Pattern Change	114
12.9.1	Turning Pattern Change On and Off	114
12.9.2	Setting the Change Interval	115
12.10	Setting ID Characters	115
12.10.1	Turning ID Characters On and Off	116
12.10.2	Recalling ID Characters	116
12.10.3	Creating ID Characters	116
12.10.4	Setting the Position of ID Characters (Vertical)	117
12.10.5	Setting the Position of ID Characters (Horizontal)	117
12.10.6	Selecting the Size of ID Characters	118
12.10.7	Selecting the Level of ID Characters	118
12.10.8	Turning ID Character Blinking On and Off	118
12.10.9	Setting the ID Character On-Time	119
12.10.10	Setting the ID Character Off-Time	119
12.10.11	Turning ID Character Scrolling On and Off	119
12.10.12	Setting ID Character Scroll Speed	120
12.10.13	Turning ID Character Background Transparency On and Off	120
12.10.14	Saving ID Characters	121
12.10.15	Copying ID Characters from a USB Memory Device to the Instrument	122
12.10.16	Copying ID Characters from the Instrument to a USB Memory Device	123
12.10.17	Clearing ID Characters	123
12.11	Setting Logos	124
12.11.1	Displaying a Logo	124
12.11.2	Turning the Logo On and Off	126

12.11.3	Selecting a Logo	126
12.11.4	Setting the Logo Position (Vertical)	126
12.11.5	Setting the Logo Position (Horizontal)	127
12.11.6	Turning the Logo Transparency On and Off	127
12.11.7	Setting the Logo Transparency Level	127
12.11.8	Copying Logos from a USB Memory Device to the Instrument	128
12.11.9	Copying a Logo from the Instrument to a USB Memory Device	129
12.11.10	Clearing a Logo	130
12.12	Setting the Moving Box	131
12.12.1	Turning the Moving Box On and Off	131
12.12.2	Selecting the Moving Box Color	132
12.12.3	Selecting the Moving Box Speed (Vertical)	132
12.12.4	Selecting the Moving Box Speed (Horizontal)	132
12.12.5	Selecting the Moving Box Height	133
12.12.6	Selecting the Moving Box Width	133
12.13	Setting a Circle	134
12.13.1	Turning the Circle On and Off	134
12.13.2	Selecting the Circle Level	135
12.13.3	Selecting the Circle Size	135
12.13.4	Turning Circle Blinking On and Off	135
12.13.5	Setting the Circle Blinking On-Time	136
12.13.6	Setting the Circle Blinking Off-Time	136
12.14	Setting the Time Code	137
12.14.1	Turning the Time Code On and Off	137
12.14.2	Setting the Time Code Position (Vertical)	138
12.14.3	Setting the Time Code Position (Horizontal)	138
12.14.4	Selecting the Time Code Size	138
12.14.5	Selecting the Time Code Level	139
12.14.6	Turning Time Code Background Transparency On and Off	139
12.15	Turning Lip Sync On and Off	140
12.16	Configuring Embedded Audio	142
12.16.1	Turning the Audio On and Off	143
12.16.2	Selecting the Resolution	143
12.16.3	Selecting the Pre-emphasis Mode	143
12.16.4	Selecting the Frequency	144
12.16.5	Setting the Level	144
12.16.6	Setting Clicks	144
12.16.7	Settings Shared by Channels	145
12.16.8	Settings Shared by Groups	145
12.17	Setting Ancillary Data	146
12.17.1	Turning the LTC Signals On and Off	146
12.17.2	Turning the VITC Signals On and Off	146
12.17.3	Setting Dropped Frames	147
12.18	Setting the SDI Output	147
12.18.1	Turning the SDI Output On and Off	147
12.18.2	Turning BMCA Linkage On and Off (SER03)	148
12.19	Settings Shared by SDI Outputs	148

13	PTP CONFIG MENU (SER03)	149
13.1	PTP Leader and PTP Follower	149
13.2	Setting the PTP Leader	149
13.2.1	Selecting the Mode	149
13.2.2	Configuring BMCA	150
13.2.3	Recovering Priority 1	150
13.2.4	Selecting the Profile	150
13.2.5	Profile Default Settings	151
13.2.6	Setting the Domain	151
13.2.7	Selecting the Communication Mode	151
13.2.8	Setting the Announce Message Transmission Interval	152
13.2.9	Setting the Sync Message Transmission Interval	152
13.2.10	Setting the Announce Timeout	153
13.2.11	Setting Priority 1	153
13.2.12	Setting Priority 2	153
13.2.13	Selecting the Step	154
13.2.14	Selecting the Default Frame	154
13.2.15	Setting the Dropped Frame Flag	154
13.2.16	Setting the Color Frame ID	155
13.2.17	Selecting the Propagation Time Measurement Method	155
13.3	Setting the PTP Follower	156
13.3.1	Selecting the Mode	156
13.3.2	Selecting the Profile	156
13.3.3	Profile Default Settings	156
13.3.4	Setting the Domain	157
13.3.5	Setting the Communication Mode	157
13.3.6	Selecting the Desired Announce Message Transmission Interval	158
13.3.7	Selecting the Announce Message Reception Interval	158
13.3.8	Selecting the Desired Sync Message Transmission Interval	159
13.3.9	Selecting the Sync Message Reception Interval	159
13.3.10	Selecting the Delay Message Transmission Interval	160
13.3.11	Selecting the Desired Delay Message Transmission Interval	160
13.3.12	Selecting the Delay Message Reception Interval	161
13.3.13	Setting the Announce Timeout	161
13.3.14	Selecting the Propagation Time Measurement Method	162
13.3.15	Setting the IP Address	162
13.3.16	Setting the Asymmetric Delay	162
14	IP CONFIG MENU (SER04)	163
14.1	Selecting the Standard	163
14.2	Turning the IP Output On and Off	163
14.3	Turning Video, Audio, and ANC On and Off	164
14.4	Setting the Payload Types	164
14.5	Configuring VLAN	165
14.5.1	Turning the VLAN Signals On and Off	165
14.5.2	Setting the VLAN Tags	165

14.6	Configuring DSCP	166
14.6.1	Turning the DSCP On and Off	166
14.6.2	Setting the DSCP Tags.....	166
14.7	Setting the Destination IP Addresses	167
14.8	Setting the Destination Port Numbers	168
14.9	Selecting the Audio Standard	168
14.10	Selecting the Audio Packet Time.....	169
15	SYSTEM CONFIG MENU.....	170
15.1	Setting the Backlight.....	170
15.2	Configuring Presets	170
15.2.1	Recalling Presets	171
15.2.2	Storing Presets.....	171
15.2.3	Adding a Comment.....	172
15.2.4	Power-on Settings	172
15.2.5	Copying Presets from a USB Memory Device to the Instrument.....	173
15.2.6	Copying Presets from the Instrument to a USB Memory Device.....	174
15.2.7	Clearing Presets	175
15.3	Setting the Network.....	175
15.3.1	Setting the Network.....	175
15.3.2	Setting the IP Address.....	176
15.3.3	Setting the Subnet Mask.....	176
15.3.4	Setting the Default Gateway	176
15.3.5	Configuring SNMP	177
15.3.6	Displaying the SNMP Engine ID	177
15.3.7	Setting the SNMP Trap Transmission Destinations	177
15.3.8	Setting the IP Addresses of the SNMP Trap Transmission Destinations.....	178
15.3.9	Copying MIB Files from the Instrument to a USB Memory Device	178
15.3.10	Setting the SNMP Community Names.....	179
15.3.11	Restarting SNMP.....	179
15.3.12	Configuring HTTP	180
15.3.13	Configuring the Web Browser.....	180
15.3.14	Configuring NTP	180
15.3.15	Setting the NTP Server.....	181
15.4	Setting the Time	182
15.4.1	Setting the Date and Time.....	182
15.4.2	Selecting the Time Zone	182
15.4.3	Turning Jam Sync On and Off.....	183
15.4.4	Setting the Jam Sync Time	183
15.4.5	Turning the Daylight Saving Time On and Off (SER01)	183
15.4.6	Setting the Daylight Saving Time Start Date (SER01).....	184
15.4.7	Setting the Daylight Saving Time Offset (SER01).....	184
15.4.8	Setting the Daylight Saving Time End Date (SER01)	184
15.4.9	Setting the Leap Second (SER01)	185
15.4.10	Setting L-SYNC.....	185
15.5	Setting the GNSS (SER01).....	186
15.5.1	Setting the Power Supply	186

15.5.2	Setting the Cable Delay	186
15.6	Configuring the PTP Settings (SER03).....	187
15.6.1	Setting the IP Address.....	187
15.6.2	Setting the Subnet Mask.....	187
15.6.3	Setting the Gateway	188
15.6.4	Configuring SFP.....	188
15.6.5	Setting Port Mirroring.....	188
15.7	Setting the IP (SER04).....	189
15.7.1	Setting the IP Address.....	189
15.7.2	Setting the Subnet Mask.....	189
15.7.3	Setting the Gateway	190
15.7.4	Configuring SFP.....	190
15.7.5	Turning RS-FEC On and Off.....	190
15.7.6	Selecting the IGMP Version	191
15.8	Setting the Alarm	191
15.8.1	Selecting the Polarity	191
15.8.2	Turning the Alarm Output On and Off.....	192
15.9	Configuring the Log	193
15.9.1	Viewing the Log	193
15.9.2	Copying the Log from the Instrument to a USB Memory Device	193
15.9.3	Clearing the Log	194
15.10	Initialization.....	194
15.10.1	Initializing the Settings.....	195
15.10.2	Factory Default Initialization.....	195
15.10.3	Selecting the Initial Value for the Format.....	195
15.11	Viewing and Adding Software Options.....	196
15.11.1	Viewing Software Options.....	196
15.11.2	Adding Software Options	196
15.12	Configuring USB.....	197
15.13	Turning the Fans On and Off.....	197
15.14	Copying the System Settings	198
15.14.1	Copying System Settings from a USB Memory Device to the Instrument	198
15.14.2	Copying System Settings from the Instrument to a USB Memory Device	199
16	STATUS MENU	200
16.1	ALARM Menu	200
16.2	INFORMATION Menu.....	201
16.3	CONFIG Menu	203
16.3.1	REFERENCE Menu.....	203
16.3.2	BLACK Menu	204
16.3.3	GNSS Menu (SER01).....	204
16.3.4	SDI Menu (SER02).....	204
16.3.5	PTP Menu (SER03)	205
16.3.6	IP/SDI menu (SER04)	206
16.3.7	SYSTEM Menu	208
16.4	LOG Menu	209
16.4.1	Viewing the Log	209

16.4.2	Clearing the Log	209
17	SNMP.....	210
17.1	SNMP Versions	210
17.2	SMI Definitions.....	210
17.3	How to Use.....	210
17.4	Enterprise MIB	212
17.4.1	l44notificationTBL Group	213
17.4.2	l44systemTBL Group.....	214
17.4.3	l44statusTBL Group	216
17.4.4	l44referenceTBL Group.....	220
17.4.5	l44blackTBL Group.....	222
17.4.6	l44audioTBL Group	235
17.4.7	l44ltcTBL Group.....	237
17.4.8	l44cw1ppsTBL Group	239
17.4.9	l44trapTBL Group	239
17.4.10	lt4670ser02 Group.....	240
17.4.11	lt4670ser03 Group.....	292
17.4.12	lt4670ser04 Group.....	300
17.5	Extended Trap.....	315
18	WEB BROWSER.....	317
18.1	Operating Environment	317
18.2	How to Use.....	317
18.3	Procedure.....	319
18.4	Screen Description	322
18.4.1	STATUS Screen	322
18.4.2	REFERENCE Screen.....	327
18.4.3	BLACK Screen	328
18.4.4	AUDIO Screen	329
18.4.5	LTC & CW/1PPS Screen	330
18.4.6	SDI Screen (SER02/SER04)	331
18.4.7	PTP Screen (SER03)	337
18.4.8	IP Screen (SER04).....	340
18.4.9	SYSTEM Screen	343
19	MAINTENANCE	347
19.1	Calibration and Repair.....	347
19.2	Replacement of Parts	347
19.2.1	Power Supply Unit Replacement	348
19.2.2	Front Fan Unit Replacement.....	351
19.2.3	Rear Fan Unit Replacement.....	354
20	APPENDIX	356
20.1	List of Settings	356

20.1.1	REFERENCE CONFIG Menu	356
20.1.2	BLACK CONFIG Menu	356
20.1.3	AUDIO CONFIG Menu	357
20.1.4	LTC CONFIG Menu	357
20.1.5	CW/1PPS CONFIG Menu	358
20.1.6	SDI CONFIG Menu (SER02/SER04)	358
20.1.7	PTP CONFIG Menu (SER03)	360
20.1.8	IP CONFIG Menu (SER04)	361
20.1.9	SYSTEM CONFIG Menu	363
20.2	Release Notes	365

GENERAL SAFETY SUMMARY

Read This before Using the Instrument

This instrument should only be used by persons with sufficient knowledge of electronics who thoroughly understand the contents of this manual.

This instrument is not designed or manufactured for households or ordinary consumers.



If unqualified personnel are to use the instrument, be sure the instrument is handled under the supervision of qualified personnel (those who have electrical knowledge). This is to prevent the possibility of personal injury or damage to the instrument.

Note about Reading This Manual

The contents of this manual contain specialized terminology and may be difficult to understand. If you have any questions about the contents of this manual, please contact your local LEADER agent.

Symbols and Terms

The following symbols and terms are used in this instruction manual and on the instrument to indicate important warnings and notes.

<p><Symbol></p> 	<p>This symbol appears in this instruction manual and on the instrument to indicate an area where improper handling could result in personal injury, damage to the instrument, or malfunction of the instrument or devices connected to it.</p> <p>When you encounter this symbol on the instrument, be sure to refer to the information in this instruction manual that corresponds to the area that the symbol marks.</p>
<p><Term></p> 	<p>Ignoring the precautions that this term indicates could lead to death or serious injury.</p>
<p><Term></p> 	<p>Ignoring the precautions that this term indicates could lead to personal injury or damage to the instrument.</p>

GENERAL SAFETY SUMMARY

Read the warnings and information below thoroughly to avoid death, personal injury, fire, electric shock, and damage and deterioration of the instrument.



Warnings Concerning the Case and Panels

- Do not remove the instrument's case or panels for any reason.
- Do not insert foreign materials, such as metal and flammable objects, or allow liquid to enter the instrument.
- Do not operate this instrument with wet hands.
- Do not install the instrument in a way that makes it difficult to operate the panel.

Installation Environment

- Use this instrument within a temperature range of 0 to 40°C at a relative humidity of 85% or less; ensure that there is no risk of condensation forming.
- Do not use the instrument with its vents blocked or in a high temperature environment.
- If there is a possibility that the instrument has condensation within it, wait for approximately 30 minutes before turning on the power.
- Do not use this instrument in an environment where flammable gases, explosive gases, or steam is emitted or stored.

If You Notice Something Wrong during Operation

- If you notice smoke, fire, strange odor, or any other anomaly while you are operating it, stop operation immediately, and remove the power cord plug from the outlet.

Warnings Concerning the Power Source

- Do not use a power source with a voltage other than the rated line voltage for the instrument.
- Be sure to use a power frequency of 50 or 60 Hz.
- Use a power cord that meets the safety standards of the country that you are using it in.
- If the power cord is damaged, stop using it.
- Do not install the instrument in a way that makes it difficult to operate the power cord plug.
- When removing the power cord from the power outlet, be sure to hold the plug; do not pull on the cord.
- When using the instrument, make sure that it is grounded using a grounded power cord.

Warnings Concerning the SFP Transceiver

- For safety reasons, use the Leader-designated SFP transceiver.
- The SFP transceiver is a Class 1 laser product. Ensure that laser light does not directly strike the eyes.
- Use of controls or adjustments or performance of procedures other than those specified in the instruction manual may result in hazardous radiation.

GENERAL SAFETY SUMMARY



Cautions Concerning the Input and Output Connectors

- Do not apply signals exceeding the specifications in this instruction manual to the input connectors.
- Do not short circuit or apply an external voltage to the output connectors.

If You Will Not Use the Instrument for an Extended Period of Time

- If you will not use the instrument for an extended period of time, remove the power plug from the outlet.

Cautions Concerning the Ethernet Port

- When you are connecting the instrument to the communication provider's equipment, connect to the Ethernet port through a hub that is authorized for use in the country that you are using the instrument in.

Cautions Concerning the Installation of the Instrument

- Place it horizontally on a securely installed stand or shelf.
- Do not place heavy measuring instruments, etc. directly on top of this instrument.
- If you are mounting this instrument on a rack, be sure to provide additional support for the body of the instrument. If you use only the front panel to mount the instrument, the instrument case may deform or fall.

Routine Maintenance

- When you clean the instrument, remove the power plug from the outlet.
- Do not use thinner or benzene when you clean the instrument's case, panels, or knobs. Doing so could lead to paint chipping or the corrosion of plastic components. To clean the case, panels, and knobs, use a soft cloth with mild detergent, and wipe gently.
- While cleaning, make sure that foreign materials, such as water and detergent, do not enter the instrument. If liquid or a metal object enters into the instrument, fire or electric shock may result.

GENERAL SAFETY SUMMARY

About the European WEEE Directive

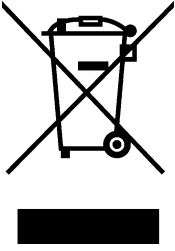

This instrument and its accessories are subject to the European WEEE Directive. Follow the applicable regulations of your country or region when discarding this instrument or its accessories. Follow the EU Battery Directive when discarding the batteries that you removed from this instrument.

(WEEE stands for Waste Electrical and Electronic Equipment.)

About the CE Marking



This product complies with the CE standards for Europe.

About the UKCA Marking



This product complies with the UKCA standards for U.K.

About the KC Mark



This product complies with the KC standards for Korea.

R-R-1k3-032

GENERAL SAFETY SUMMARY

About the China RoHS

Following information is for Chinese RoHS only

所含有毒有害物质信息

部件号码: LT4670



此标志适用于在中国销售的电子信息产品, 依据2006年2月28日公布的《电子信息产品污染控制管理办法》以及SJ/T11364-2006《电子信息产品污染控制标识要求》, 表示该产品在使用完结后可再利用。数字表示的是环境保护使用期限, 只要遵守与本产品有关的安全和使用上的注意事项, 从制造日算起在数字所表示的年限内, 产品不会产生环境污染和对人体、财产的影响。产品适当使用后报废的方法请遵从电子信息产品的回收、再利用相关法令。详细请咨询各级政府主管部门。

产品中有毒有害物质或元素的名称及含量

部件名称 Parts	有毒有害物质或元素 Hazardous Substances in each Part					
	铅 (Pb)	汞 (Hg)	镉 (Cd)	六价铬 (Cr(VI))	多溴联苯 (PBB)	多溴二苯醚 (PBDE)
实装基板	×	○	○	○	○	○
主体部	×	○	○	○	○	○
液晶显示模组	○	○	○	○	○	○
开关电源	×	○	○	○	○	○
风扇	×	○	○	○	○	○
外筐	×	○	○	○	○	○
线材料一套	×	○	○	○	○	○
附件	×	○	○	○	○	○
包装材	○	○	○	○	○	○
电池	○	○	○	○	○	○
选件						
LT4670-SER01	×	○	○	○	○	○
LT4670-SER02	×	○	○	○	○	○
LT4670-SER03	×	○	○	○	○	○
LT4670-SER04	×	○	○	○	○	○
LT4670-SER11	×	○	○	○	○	○

备注)

- : 表示该有毒有害物质在该部件所有均质材料中的含量均在SJ/T11363-2006 规定的限量要求以下。
- ×: 表示该有毒有害物质或元素至少在该部件的某一均质材料中的含量超出SJ/T11363-2006 标准规定的限量要求。

Ver. 2

Follow the warnings and precautions that have been listed in this section to use the instrument correctly and safely. Precautions are also contained in various other sections of this instruction manual. To use the instrument correctly, be sure to follow those precautions as well.

If you have any questions or comments about this instruction manual, please contact your local LEADER agent.

1 INTRODUCTION

Thank you for using the LEADER instrument. To use this instrument safely, read this instruction manual thoroughly, and make sure that you know how to use the instrument properly.

If some point about the operation of this instrument is still unclear after you have read this instruction manual, refer to the contact information on the back cover of the manual to contact LEADER, or contact your local LEADER agent.

1.1 User Registration

Register as a user to access the latest product information.
To register, go to the user registration page of the Leader website.

1.2 Scope of Warranty

This LEADER instrument has been manufactured under the strictest quality control guidelines. If a failure occurs when the instrument is used in normal conditions, we will repair the instrument free of charge for a period of one year from the date of purchase. The proof of purchase (delivery slip, receipt bill, etc.) may be used as a warranty. Keep it in a safe place.

LEADER shall not be obligated to furnish the following free services during the warranty period.

1. Repair of malfunction or damages resulting from fire, natural calamity, or improper voltage applied by the user.
2. Repair of a product that has been improperly repaired, adjusted, or modified by personnel other than a factory-trained LEADER representative.
3. Repair of malfunctions or damages resulting from improper use.
4. Repair of malfunctions caused by devices other than this instrument.
5. Repair of malfunctions or damages without the presentation of a proof of purchase or receipt bill for the instrument.

This Warranty is valid only in Japan.

1.3 Trademark Acknowledgments

The company and product names in this document are trademarks or registered trademarks of their respective holders.

1.4 Operating Precautions

1.4.1 Power Supply Voltage



Confirm the voltage of the power source before you connect the power cord to it. The power requirements of this instrument are indicated on its rear panel. Only use a power source that supplies a voltage within the operating voltage range and has a frequency of 50/60 Hz. The symbol "~" on the back indicates alternating current (AC).

1.4.2 Maximum Allowable Input Voltage



The maximum signal voltage that can be applied to the input connectors is indicated below. Do not apply excessive voltage to the connectors. Doing so may damage the device or lead to injury.

Table 1-1 | Maximum allowable input voltage

Input Connector		Maximum Allowable Voltage
GENLOCK/CW IN	GENLOCK	±5 V (DC + peak AC)
	CW	1 Vrms (50 Ω termination)
LTC/REMOTE	LTC	4Vp-p
	REMOTE	5V
L-SYNC		3.3V
GNSS IN (SER01)		3.3Vp-p

1.4.3 Mechanical Shock

This instrument contains sensitive components, so it may be damaged if it is dropped or otherwise exposed to a strong shock.

1.4.4 Electrostatic Damage

Electronic components can be damaged by static discharge. Static electricity can build up in the core wire of a coaxial cable. Before connecting a coaxial cable to an I/O connector of the instrument, short the core wire of the cable with the external conductor.

1.4.5 Warming Up

To ensure more accurate measurements, turn ON the instrument approximately 30 minutes before you intend to use it to allow its internal temperature to stabilize.

2 PRODUCT CONFIGURATION

2.1 Main Unit

The configuration of the LT4670 instrument is as shown below.

Table 2-1 | Instrument

Model Number	Model Name	Functions	Port	Number of Ports
LT4670	SYNC GENERATOR	Genlock/CW Input	BNC	2
		Analog Black Output	BNC	6
		CW/1PPS Output	BNC	1
		Word-Clock Output	DIN 1.0/2.3	1
		Silence Output	DIN 1.0/2.3	1
		AES/EBU Output	DIN 1.0/2.3	1
		Ethernet	RJ-45	1
		LTC/Remote	D-Sub 26pin	1
		Inter-instrument Synchronization (L-SYNC)	D-Sub 15pin	1
		Power Requirements	Power Supply	1

2.2 Hardware Options

The following hardware options can be added to the LT4670.

Hardware options will be added by LEADER or the designated service personnel. Contact your local LEADER agent.

Table 2-2 | Hardware options

Model Number	Model Name	Functions	Port Added	Number of Ports
LT4670-SER01	GNSS	GPS / GLONASS / GALILEO / BDS / QZSS Synchronization	BNC	1
LT4670-SER02 (*1)	SDI	3G-SDI / HD-SDI / SD-SDI Output	BNC	2
LT4670-SER03	PTP	PTP	SFP/SFP+	2
LT4670-SER04 (*1)	25G-IP/12G-SDI TSG	25G-IP Output	SFP+/SFP28	2
		12G-SDI / 3G-SDI / HD-SDI / SD-SDI Output	Micro-BNC	4
LT4670-SER11	POWER UNIT	Redundant Power Supply	Power Supply	1

*1 The LT4670-SER02 and LT4670-SER04 cannot be installed in the instrument at the same time.

2.3 Software Options

The following software options can be added to the LT4670.

To add a software option, provide your local LEADER agent with the instrument’s MAC address and serial number. We will issue a license key.

When you receive the license key, add it using "SYSTEM CONFIG > LICENSE INFO. > LICENSE KEY INPUT". Each instrument requires a unique license key. You cannot use the same key for multiple instruments.

Table 2-3 | Software options

Model Number	Model Name	Functions
LT4670-SER21	4K 3G-Quad Link	4K 3G-Quad Link Output (This requires two LT4670-SER02 units.)

MAC Address

You can check the MAC address in "STATUS > CONFIG > SYSTEM > MAC ADDRESS".

```
[ M A C   A D D R E S S ]
0 0 : 0 0 : 0 0 : 0 0 : 0 0 : 0 0
```

Serial Number

You can check the serial number on the rear panel or in "STATUS > CONFIG > SYSTEM > MAIN". The upper 7-digit number represents the serial number.

```
[ M A I N : 0 0 / 0 0 0 0 0 0 0 ]
C 5 : 0 0 0 0 0 0 0 0   C 1 0 : 0 0 0 0 0 0 0 0
```

3 SPECIFICATIONS

3.1 General

The LT4670 is a 1U full-rack size sync signal generator that outputs analog video sync signals and audio word-clock signals. The genlock function allows operation synchronized with input signals.

The genlock function has a stay-in-sync function that maintains the phase when an error occurs in the input analog video sync signal. Adding the power option provides redundant operation. The power supply unit and fan can be replaced without turning off the power of the LT4670 main unit. These features make it possible to configure a highly reliable system.

The LT4670 has six independent standard outputs of the analog sync signal output, digital audio output, word-clock output, and LTC I/O. Also, options are available for GNSS and PTP synchronization, arbitrary pattern output using 12G-SDI, 3G-SDI (4K Quad), HD-SDI, SD-SDI, and 25G-IP etc. These options are designed to enable the management of the optimal synchronization system for your application.

3.2 Features

3.2.1 LT4670

Genlock Function

Various output signals can be synchronized by applying NTSC/PAL black burst signals, which are analog video sync signals, and HDTV tri-level sync signals.

NTSC/PAL black burst signal with field reference pulse and NTSC black burst signal with 10 field IDs are also supported.

The 10 MHz CW lock is also supported as a standard feature.

Stay-in-Sync and Slow Lock Functions

A stay-in-sync function is available in case errors occur at the genlock input. In addition, a slow lock function is available to reduce the shock that occurs when genlock is performed again based on stay-in-sync. This makes it possible to construct an extremely reliable synchronization system.

Analog Video Sync Signal Output

Six analog video sync signals can be output. The phase of each output can be adjusted independently.

NTSC/PAL black burst signal with field reference pulse and NTSC black burst signal with 10 field IDs are also supported.

Word-Clock Signal Output

The LT4670 can output a 48 kHz word-clock signal synchronized with video signals.

AES/EBU Signal Output

This option can output a 48 kHz AES/EBU signal synchronized with video signals. (AES/EBU connector)

It is also equipped with a AES/EBU signal output compatible with DARS. (SILENCE connector)

CW/1PPS Output

The CW/1PPS output can output 10 MHz CW or 1PPS, whichever is selected.

Time Code I/O

The time code generator can run in free run mode based on internal time information. Based on the NTP server, LTC, VITC, GNSS (SER01), or PTP (SER03) time information, it can embed the LTC3 system output and analog video sync signal output in VITC, as well as the SDI (SER02/SER04) output in ATC (LTC/VITC).

LTC I/O

The LTC has three independent outputs for an input. An offset time can be set for each output with respect to the frame rate and reference time.

Remote Connector

The remote connector can be used to load presets and transmit two alarm outputs.

Inter-instrument Synchronization Control (L-SYNC)

In a redundant system, the time can be synchronized by connecting the main and backup devices that are synchronized with the same analog video sync signal via L-SYNC.

Real Time Clock

The real time clock is backed up by a battery. There is no need to reset the clock even when the power is turned off and then back on.

Ethernet

Control is exerted based on the SNMP. When an error is detected, a TRAP is issued. Also, this instrument can be controlled using the HTTPS (future support), HTTP, and REST-API (future support).

When connected to an NTP server as an NTP client, the instrument can be used for internal clock synchronization or as an NTP server.

Preset Memory Function

Up to 10 presets can be saved. Convenient registered presets can be recalled during operation. The LT4670 can be started with the same settings every time.

External Memory Support

The log can be saved and preset data can be written and saved from the panel using USB memory devices.

Logging Function

The operation status can be logged to internal memory or external memory.

Last Memory Function

When the power is turned on, it starts up with the settings when the power was turned off last time.

3.2.2 LT4670-SER01 (GNSS)

GNSS Sync

A GNSS antenna can be connected to generate and output signals by locking to the frequency and clock obtained from the GPS, GLONASS, GALILEO, BDS, and QZSS.

It also features a stay in sync function, which retains the phase and frequency of the output signal when GNSS signals are lost.

3.2.3 LT4670-SER02 (SDI)

Triple-rate SDI Ready

The SDI signal output supports 3G-SDI (level A and level B), HD-SDI, and SD-SDI. There are two independent SDI signal output connectors, and different patterns and phases can be set for each.

Also, two SER02 units can be mounted, and up to four independent SDI signals can be output. Moreover, adding a 4K option (SER21) supports the 4K 3G-Quad Link.

User Pattern Generation

In addition to internal patterns such as the color bar, SD and HD (2K) user patterns can be output.

ID Character Overlay

ID characters can be overlaid at any position on the display. In addition, ID characters can be scrolled horizontally or displayed in a blinking state for checking whether the display has frozen.

Logo Mark Overlay

24-bit full-color bitmap data can be overlaid as a logo mark at any position on the display at a 640 (dots) × 480 (lines) VGA size.

Safety Area Markers

90% and 80% safety area markers can be overlaid on the display. For 3G-SDI and HD-SDI, a 4:3 aspect marker can be overlaid.

Pattern Scrolling

This option is equipped with a function for scrolling patterns in eight directions. The moving speed can be varied.

Moving Box

A moving box can be overlaid on the display. Its color, size, and moving speed can be varied.

Circle

90%, 80%, and 70% circles can be overlaid on the display. Their brightness can be changed, and they can be displayed in a blinking state.

Time Code

A time code can be overlaid at any position on the display. Its character size and brightness can be changed.

Audio Embedding

Embedded audio of 16 channels (four channel × four groups) can be embedded. The frequency, level, and the like can be set for each channel.

Lip Sync Pattern

Lip sync patterns in which the video and audio are synchronized can be output. By using a waveform monitor that features a lip sync measurement function, such as the Leader's LV5600, it is possible to measure the offset between the video and audio in SDI signal transmissions.

3.2.4 LT4670-SER03 (PTP)

PTP Leader Function

This option supports the Precision Time Protocol defined in IEEE1588-2008 and operates as a PTP grand master. SMPTE2059, AES67, and General profiles are supported. The PTP time source is obtained from the internal clock, NTP server, GNSS, VITC, or LTC.

PTP Follower Function

When a host PTP grand master is present in the system, this option operates as a PTP follower and can operate as a PTP leader for lower devices.

Two Independent PTP Ports

Since two PTP engines are mounted, a PTP system can be constructed for each of them as an independent grand master.

The two engines can be used as followers. (The leader can be selected automatically or arbitrarily by the user.)

It is also possible to use one engine as a follower and the other as the leader.

10GbE Support

A 10GbE SFP+ module, sold separately, can be used.

Local PTP Function

When genlocked to the analog video sync signal or HDTV tri-level sync signal, this function obtains time information from an external time source, such as a GNSS or NTP server. It can adjust the time according to the phase information of the genlocked sync signal and redistribute the PTP time.

3.2.5 LT4670-SER04 (25G-IP)

This section describes the IP functions of the LT4670-SER04 (25G-IP/12G-SDI TSG).

IP Signal Generation

IP test pattern signals can be generated.

The IP transmission standard is SMPTE ST 2110-20/30/31/40. This function can generate 2K and 4K video signal test patterns. ST-2022-6 is also supported.

For IP signals, up to four streams can be output per port within the band.

(IP test patterns specified with SDI outputs are output.)

Network Synchronization

Video and audio test signals can be generated in sync with the PTP (Precision Time Protocol) of SMPTE ST 2059.

Packet Errors (future support)

Packet loss and packet error test signals can be generated.

Packet Jitter (future support)

Packet jitter can be added to test signals.

3.2.6 LT4670-SER04 (12G-SDI)

This section describes the SDI functions of the LT4670-SER04 (25G-IP/12G-SDI TSG).

12G-SDI Ready

The SDI signal output supports 12G-SDI, 3G-SDI (level A and level B), HD-SDI, and SD-SDI.

There are four independent SDI signal output connectors, and different patterns and phases can be set for each.

4K Internal Pattern Generation (future support)

In addition to the internal patterns of LT4670-SER04, the following patterns can be output.

- UHD Color Bar ARIB STD-B66
- HLG CB ITU-R BT.2111 HLG narrow range
- S-LOG3(Live HDR) Ver1.11 narrow range scale

User Pattern Generation

In addition to internal patterns such as the color bar, SD, HD (2K), and 4K user patterns can be output.

ID Character Overlay

ID characters can be overlaid at any position on the display. In addition, ID characters can be scrolled horizontally or displayed in a blinking state for checking whether the display has frozen.

Logo Mark Overlay

24-bit full-color bitmap data can be overlaid as a logo mark at any position on the display at a 640 (dots) × 480 (lines) VGA size.

Safety Area Markers

90% and 80% safety area markers can be overlaid on the display. For 12G-SDI, 3G-SDI, and HD-SDI, a 4:3 aspect marker can be overlaid.

Pattern Scrolling

This option is equipped with a function for scrolling patterns in eight directions. The moving speed can be varied.

Moving Box

A moving box can be overlaid on the display. Its color, size, and moving speed can be varied.

Circle

90%, 80%, and 70% circles can be overlaid on the display. Their brightness can be changed, and they can be displayed in a blinking state.

Time Code

A time code can be overlaid at any position on the display. Its character size and brightness can be changed.

Audio Embedding

Embedded audio of 16 channels (four channel × four groups) can be embedded. The frequency, level, and the like can be set for each channel.

Lip Sync Pattern

Lip sync patterns in which the video and audio are synchronized can be output. By using a waveform monitor that features a lip sync measurement function, such as the Leader's LV5600, it is possible to measure the offset between the video and audio in SDI signal transmissions.

3.2.7 LT4670-SER11 (POWER UNIT)

Redundant Power Supply

You can make the power supply redundant.

When errors occur in power supply units, alarms are indicated on the instrument panel. Errors can also be output as alarms using SNMP.

3.2.8 LT4670-SER21 (4K 3G-Quad Link)

4K 3G-Quad Link Output

Two LT4670-SER02 (SDI) options are featured. When this option is enabled, the 4K 3G-Quad Link can be output.

4K Internal Pattern Generation (future support)

In addition to the internal patterns of LT4670-SER02, the following patterns can be output.

- UHD Color Bar ARIB STD-B66
- HLG CB ITU-R BT.2111 HLG narrow range
- S-LOG3(Live HDR) Ver1.11 narrow range scale

User Pattern Generation

In addition to internal patterns such as the color bar, 4K user patterns can be output.

ID Character Overlay

ID characters can be overlaid at any position on the display. In addition, ID characters can be scrolled horizontally or displayed in a blinking state for checking whether the display has frozen.

Logo Mark Overlay

24-bit full-color bitmap data can be overlaid as a logo mark at any position on the display at a 640 (dots) × 480 (lines) VGA size.

Safety Area Markers

90% and 80% safety area markers can be overlaid on the display. A 4:3 aspect marker can also be overlaid.

Pattern Scrolling

This option is equipped with a function for scrolling patterns in eight directions. The moving speed can be varied.

Moving Box

A moving box can be overlaid on the display. Its color, size, and moving speed can be varied.

Circle

90%, 80%, and 70% circles can be overlaid on the display. Their brightness can be changed, and they can be displayed in a blinking state.

Time Code

A time code can be overlaid at any position on the display. Its character size and brightness can be changed.

Audio Embedding

Embedded audio of 16 channels (four channel × four groups) can be embedded. The frequency, level, and the like can be set for each channel.

Lip Sync Pattern

Lip sync patterns in which the video and audio are synchronized can be output. By using a waveform monitor that features a lip sync measurement function, such as the Leader's LV5600, it is possible to measure the offset between the video and audio in SDI signal transmissions.

3.3 Standards

3.3.1 LT4670

General Specifications

Model Number	LT4670
Model Name	SYNC GENERATOR
Use	1U full-rack size sync signal generator that outputs analog video sync signal and audio word-clock signals
Environmental Conditions	
Operating Temperature	0 – 40°C
Operating Humidity Range	85% RH or less (no condensation)
Optimal Temperature	10 – 35°C
Operating Environment	Indoors
Operating Altitude	Up to 2,000 m
Overvoltage Category	II
Pollution Degree	2
Power Supply	
Voltage	100 – 240 VAC
Voltage Variation	±10%
Power Consumption	150 W max. (when all options are used)
Dimensions	482 (W) × 44 (H) × 400 (D) mm (excluding protrusions)
Weight	4.2 kg (excluding options) 5.4 kg (when SER01, SER02×2, SER03, and SER11 are installed) 5.4 kg (when SER01, SER03, SER04, and SER11 are installed)
Accessories	Power cord AC cord clamp General safety summary
Sold Separately	SFP transceiver (LC2141 / LC2142 / LC2148 / LC2149 / LC2151 / LC2152) GNSS antenna Fan unit (LP2184) LTC cable (LC2185)(for connecting with LT4448) L-SYNC cable (LC2186)

Power Supply Unit

Number of Units in Main Unit	
Standard	1
Maximum	2 (when LT4670-SER11 is installed)
Power Supply Redundancy	When LT4670-SER11 is installed
Replacement Method	The installed LT4670-SER11 can be replaced without turning off the power of the main unit.
Alarm	A power supply alarm is indicated on the LED and LCD and notified by an SNMP trap.

Fan Unit

Number of Fans	2 (one on front, one on rear)
Replacement Method	The fan can be stopped using the panel and replaced without turning off the power of the main unit.
Alarm	A fan alarm is indicated on the LED and LCD and notified by an SNMP trap.

Corresponding Standard

Analog Video Sync Signal	
NTSC Black Burst Signal	SMPTE ST 170, SMPTE ST 318, SMPTE RP 154
PAL Black Burst Signal	ITU-R BT 1700, EBU N14
HD Tri-level Sync Signal	SMPTE ST 240, SMPTE ST 274, SMPTE ST 296
AES/EBU Signal	ANSI S4.40, AES3-2009, AES11-2009, SMPTE ST 276
LTC Signal	SMPTE 12M-1
Phase Management	SMPTE ST 2059-1

I/O Connectors

Genlock Input Connector	
Connector	2 BNC connectors
Input Signal	Analog composite sync signal
HD Tri-level Sync Signal	Analog composite sync signal
Format	Loop-through
Input Impedance	47 k Ω
Maximum Input Voltage	± 5 V (DC + peak AC)
Operating Input Level Range	± 6 dB
External Lock Range	± 5 ppm
Jitter	1 ns (when genlock is in use)
10 MHz CW Input Connector	
Connector	1 BNC connector (used in combination with the genlock input connector)
Input Impedance	47 k Ω (used with 50 Ω terminated to the loop-through)
Input Signal Level	0.5 - 1 V _{rms} (50 Ω termination)
Input Signal Frequency	10 MHz
Locking Frequency Range	± 5 ppm
10 MHz CW/1PPS Output Connectors	
Connector	1 BNC connector (used in combination with 10 MHz CW and 1PPS)
Output Amplitude Signal Level	
10 MHz CW	2 V _{p-p} \pm 20% (1 V _{rms}) for square waves; 50 Ω termination
1PPS	4.8 \pm 0.5 V (no termination, high level) 2.4 \pm 0.25 V (50 Ω termination, high level)
Output Impedance	50 Ω unbalanced
Output Signal Frequency	10 MHz/1PPS

3 SPECIFICATIONS

LTC I/O Connector

Connector	D-sub 26-pin (female)
LTC	
Number of Inputs	1
Input Impedance	1 k Ω (balanced) 500 Ω (unbalanced)
Input Signal Level	0.5 - 4 Vp-p
Number of Outputs	3
Output Impedance	24 Ω balanced
Output Signal Level	2 Vp-p \pm 10%

Analog Video Sync Signal Output Connector

Connector	6 BNC connectors, 6 outputs
Output Signal	NTSC black burst signal, PAL black burst signal, HD tri-level sync signal
Output Impedance	75 Ω
Sync Level	
NTSC	40 \pm 1IRE
PAL	-300 \pm 6mV
HD	\pm 300 \pm 6mV
Blanking	0 \pm 15 mV

AES/EBU Digital Audio Output Connector

Connector	1 DIN 1.0/2.3 connector
Output Amplitude	1 Vp-p \pm 0.1 V
Output Impedance	75 Ω unbalanced

AES/EBU Silence Output Connector

Connector	1 DIN 1.0/2.3 connector
Output Amplitude	1 Vp-p \pm 0.1 V
Output Impedance	75 Ω unbalanced

Word-Clock Output Connector

Connector	1 DIN 1.0/2.3 connector
Output Frequency	48 kHz
Output Amplitude	4.8 V or more (no termination, high level) 2.4 V or more (75 Ω termination, high level)

Control Connectors

Ethernet Port	
Standard	IEEE 802.3
Protocol	
SNMP v2c/v3	Command control, status query, trap transmission
REST-API (future support)	Command control, status query
HTTP/HTTPS (HTTPS to be supported in the future)	Monitoring and operation using a browser
NTP	Internal clock synchronization, time distribution
Connector	RJ-45
Type	10BASE-T, 100BASE-TX, 1000BASE-T (auto switching)
USB Port	
Standard	USB 2.0
Supported Media	USB memory device
Supported Format	FAT32
Functions	Preset, logo, ID character, and user pattern loading; preset and log saving; MIB file retrieval; HTTP authentication key retrieval (future support); firmware update
Connector	USB Type A
Remote Connector	
Connector Shape	D-sub 26-pin (female)
Locking Screw	Inch screw (No.4-40UNC)
Number of Ports	1
Control Signal	
Preset Recall	LV-TTL level (low active)
Alarm Output	HC-CMOS level
Input Voltage Range (Preset Recall)	0 - 5 VDC
	All inputs are pulled up to +3.3 V (control is also possible using +5 V).
Output Voltage Range (Alarm Output)	0 - 5 VDC
Functions	Preset recall
	Alarm output (when an error occurs, when the fan malfunctions, or when the power supply malfunctions)

Inter-instrument Synchronization Connector (L-SYNC)

Connector Shape	D-sub 15-pin (female)
Number of Ports	1
Control Signal	LV-CMOS
	6 main-side outputs
	6 backup-side inputs
Input Voltage Range	0 - 3.3 VDC
Function	The time of the two instruments is synchronized in a redundant configuration.

* It is not supported when the reference signal format is 23.98 Hz.

LCD

Number of Characters	24 characters × 2 lines
Backlight	On/off

Genlock Function

Signal Format	NTSC BB, NTSC BB+REF, NTSC BB+ID, NTSC BB+REF+ID, PAL BB, PAL BB+REF, 525/59.94I, 525/59.94P, 625/50I, 625/50P, 1125/60P, 1125/59.94P, 1125/50P, 1125/60I, 1125/59.94I, 1125/50I, 1125/30P, 1125/29.97P, 1125/25P, 1125/24P, 1125/23.98P, 1125/24PsF, 1125/23.98PsF, 750/60P, 750/59.94P, 750/50P, 750/30P, 750/29.97P, 750/25P, 750/24P, 750/23.98P
Timing Adjustment	
Adjustment Range	
FINE	±100 (in units of 0.5 ns)
Reference Source	
Internal Reference Signal	INTERNAL
External Reference Signal	GENLOCK FMT-AUTO / GENLOCK FMT-MANUAL / 10MHz CW / GNSS (SER01) / PTP (SER03)
Recovery Mode	
AUTO	Resynchronizes according to the auto setting when the external reference signal recovers.
MANUAL	Retains the STAY IN SYNC state when the external sync signal recovers.
Auto Setting	
IMMEDIATE	Resets the lock when the external sync signal recovers.
FAST	Quickly resynchronizes when the external sync signal recovers.
SLOW	Slowly resynchronizes when the external sync signal recovers.

Manual Setting	
IMMEDIATE	Resets the lock when the external sync signal recovers and REFERENCE READJUST operation is performed.
FAST	Quickly resynchronizes when the external sync signal recovers and REFERENCE READJUST operation is performed.
SLOW	Slowly resynchronizes when the external sync signal recovers and REFERENCE READJUST operation is performed.
REFERENCE READJUST	Resynchronizes immediately.
Stay in Sync Function	Retains the frequency (video phase) immediately before error occurrence when an error occurs in the external reference signal. Retains the previous frequency if the 10 MHz CW signal is interrupted when 10 MHz CW is input.

Analog Video Sync Signal Output

Signal Format	Each of the 6 outputs can be configured independently. NTSC BB, NTSC BB+REF, NTSC BB+ID, NTSC BB+REF+ID, NTSC BB+SETUP, NTSC BB+S+REF, NTSC BB+S+ID, NTSC BB+S+R+ID, PAL BB, PAL BB+REF, 525/59.94I, 525/59.94P, 625/50I, 625/50P, 1125/60P, 1125/59.94P, 1125/50P, 1125/60I, 1125/59.94I, 1125/50I, 1125/30P, 1125/29.97P, 1125/25P, 1125/24P, 1125/23.98P, 1125/24PsF, 1125/23.98PsF, 750/60P, 750/59.94P, 750/50P, 750/30P, 750/29.97P, 750/25P, 750/24P, 750/23.98P
Timing Adjustment	Each of the 6 outputs can be configured independently.
Adjustment Range	
NTSC Black Burst Signal	±5 frames
PAL Black Burst Signal	±2 frames
HD Tri-Level Sync Signal	1 frame (entire frame)
Adjustment Unit	
NTSC/PAL Black Burst Signal	In units of 0.0185 μ s (54 MHz clock)
HD Tri-Level Sync Signal	In units of 0.0135 μ s (74.25/1.001 MHz clock unit or 74.25 MHz clock unit)

AES/EBU Digital Audio Output

Timing Adjustment	
Adjustment Range	±1 AES/EBU frame (±511)
Adjustment Unit	In units of 512 fs (24.576 MHz)
Sampling Frequency	48 kHz sampling (synced with the video signal)
Resolution	20 bits, 24 bits
Pre-emphasis	OFF, 50/15, CCITT (only the CS bit is switched)
Frequency	SILENCE, 400 Hz, 800 Hz, 1 kHz
Level	-60 – 0 dBFS (in units of 1 dBFS)
Audio Click	OFF, 1, 2, 4 sec
Lip Sync	Synchronization with SDI-1
Sampling Clock Accuracy	Grade 2 (±10 ppm)

* The frequency, level, and audio click can be set for each channel.

AES/EBU Silence Output

Timing Adjustment	
Adjustment Range	±1 AES/EBU frame (±511)
Adjustment Unit	In units of 512 fs (24.576 MHz)
Sampling Frequency	48 kHz sampling (synced with the video signal)
Resolution	20 bits, 24 bits
Pre-emphasis	OFF
Frequency	SILENCE
Level	MUTE
Sampling Clock Accuracy	Grade 2 (±10 ppm)

* Supports DARS.

* When EQUAL TO AES/EBU is set to on, the same signal as the AES/EBU digital audio signal is output.

Word-Clock Output

Timing Adjustment	
Adjustment Range	±1 AES/EBU frame (±511)
Adjustment Unit	In units of 512 fs (24.576 MHz)

Time Code Function

Reference Time	Internal / NTP / LTC / VITC / GNSS (SER01) / PTP (SER03)
Frame Rate	30 / 29.97 / 25 / 24 / 23.98 Hz
Dropped Frame Mode	On/Off
JAM SYNC	
Application Setting	Set the application time with a timer.
ATC Setting	
LTC Insertion Setting	On/Off
VITC Insertion Setting	On/Off

Black Setting	
VITC Insertion Setting	On/Off
Superimposed Line	
NTSC	10 - 20 (*1)
PAL	6 - 22 (*2)
AES/EBU Setting	
Insertion Setting	On/Off
LTC Setting	
Output Setting	On/Off
Leap Second	
Application Setting	Set the application date/time with a timer. (The PTP (SER03) does not support timer setting.)
Daylight Savings Time	
Application Setting	Set the application date and time with a timer.

*1 When REF is included in the black format, it cannot be superimposed on the 10th line.

When ID is included in the black format, it cannot be superimposed on the 15th line.

*2 When the black format is PAL BB+REF, it cannot be superimposed on the 7th line.

Preset Function

Preset	Saves the panel settings.
Number of Presets	10
Recall Method	Panel, remote connector, SNMP, REST-API (future support), browser
Copy Method	Copy from this instrument to a USB memory device or copy from the USB memory device to this instrument.

* Logo data and device-specific information (IP address, time, etc.) cannot be saved.

Logging Feature

Saved Items	Genlock status change, instrument operation, alarm information, attention information
Number of Logs	Up to 1000
Copy Method	Copy from this instrument to a USB memory device.
Display	Panel, browser

3.3.2 LT4670-SER01 (GNSS)

I/O Connectors

GNSS Input Connectors

Connector	1 BNC connectors
Input Impedance	50 Ω
Antenna, Pre-amp Power Supply	
Voltage	5 V / 3.3 V / OFF
Current	50 mA max. (built-in overcurrent protection circuit)

GNSS Lock

GNSS Receiver

Receive Frequency	
GPS	1575.42MHz (L1)
GLONASS	1602 MHz + k×562.5kHz (L1OF) (k = -7, ..., 5, 6)
GALILEO	1575.42MHz (E1-B/C)
BDS	1561.098MHz (B1)
GPS+QZSS	1575.42MHz (L1)
Status	GNSS No Fix, ADJUST FREQ TO GNSS, ADJUST PHASE TO GNSS, TRACKING, LOCK, STAY, RECOVERY
Stay in Sync Function	Retains the previous frequency and phase when the GPS, GLONASS, GALILEO, BDS, or GPS+QZSS signal is interrupted.

3.3.3 LT4670-SER02/SER04/SER21 (SDI)

This section describes the following options:

- LT4670-SER02 (SDI)
- SDI functions of the LT4670-SER04 (25G-IP/12G-SDI TSG)
- LT4670-SER21 (4K 3G-Quad Link)

Depending on the option added to the instrument, the supported SDI format differs as follows. See the items appropriate to the respective options.

Table 3-1 | SDI format

Option	2K			4K	
	SD-SDI	HD-SDI	3G-SDI	3G-Quad Link	12G-SDI
SER02	●	●	●	-	-
SER02×2 + SER21	●	●	●	●	-
SER04	●	●	●	●	●

Corresponding Standard

SDI Embedded Audio

12G, 3G, HD

SMPTE ST 299

SD

SMPTE ST 272

SDI Payload ID

SMPTE ST 352

SDI Formats and Standards

Table 3-2| HD and SD video signal formats and standards

Color System	Quantization	Image	Frame (Field) Frequency/Scanning	Corresponding Standard
YCbCr 4:2:2	10bit	1280×720	60/59.94/50/30/29.97/25/24/23.98/P	SMPTE ST 292-1 SMPTE ST 296
		1920×1080	60/59.94/50/I	SMPTE ST 292-1
			30/29.97/25/24/23.98/P	SMPTE ST 274
			30/29.97/25/24/23.98/PsF	SMPTE ST 292-1 SMPTE RP 211
		720×487	59.94/I	SMPTE ST 259
		720×576	50/I	

3 SPECIFICATIONS

Table 3-3 | 3G-A video signal formats and standards

Color System	Quantization	Image	Frame (Field) Frequency/Scanning	Corresponding Standard
YCbCr 4:2:2	10bit	1920×1080	60/59.94/50/P	SMPTE ST 274
	12bit	1920×1080	60/59.94/50/I	SMPTE ST 425-1
			30/29.97/25/24/23.98/P	
			30/29.97/25/24/23.98/PsF	
RGB 4:4:4	10bit	1280×720	60/59.94/50/30/29.97/25/24/23.98/P	SMPTE ST 296 SMPTE ST 425-1
		1920×1080	60/59.94/50/I	SMPTE ST 274
			30/29.97/25/24/23.98/P	SMPTE ST 425-1
	30/29.97/25/24/23.98/PsF			
	12bit	1920×1080	60/59.94/50/I	
			30/29.97/25/24/23.98/P	

Table 3-4 | 3G-B video signal formats and standards

Color System	Quantization	Image	Frame (Field) Frequency/Scanning	Corresponding Standard
YCbCr 4:2:2	10bit	1920×1080	60/59.94/50/P	SMPTE ST 274
	12bit	1920×1080	60/59.94/50/I	SMPTE ST 372
			30/29.97/25/24/23.98/P	SMPTE ST 425-1
			30/29.97/25/24/23.98/PsF	
RGB 4:4:4	10bit	1920×1080	60/59.94/50/I	
			30/29.97/25/24/23.98/P	
			30/29.97/25/24/23.98/PsF	
	12bit	1920×1080	60/59.94/50/I	
			30/29.97/25/24/23.98/P	
			30/29.97/25/24/23.98/PsF	

3 SPECIFICATIONS

Table 3-5 | 3G-Quad Link video signal formats and standards

Division Transmission System	Color System	Quantization	Image	Frame Frequency/ Scanning	Corresponding Standard
2 sample interleave	YCbCr 4:2:2	10bit	3840×2160	60/59.94/50/P	SMPTE ST 425-5 SMPTE ST 2036-1
			4096×2160	60/59.94/50/48/47.95/P	SMPTE ST 425-5 SMPTE ST 2048-1
		12bit	3840×2160	30/29.97/25/24/23.98/P	SMPTE ST 425-5 SMPTE ST 2036-1
			4096×2160	30/29.97/25/24/23.98/P	SMPTE ST 425-5 SMPTE ST 2048-1
	RGB 4:4:4	10bit	3840×2160	30/29.97/25/24/23.98/P	SMPTE ST 425-5 SMPTE ST 2036-1
			4096×2160	30/29.97/25/24/23.98/P	SMPTE ST 425-5 SMPTE ST 2048-1
		12bit	3840×2160	30/29.97/25/24/23.98/P	SMPTE ST 425-5 SMPTE ST 2036-1
			4096×2160	30/29.97/25/24/23.98/P	SMPTE ST 425-5 SMPTE ST 2048-1

Table 3-6 | 12G video signal formats and standards

Division Transmission System	Color System	Quantization	Image	Frame Frequency/ Scanning	Corresponding Standard
2 sample interleave	YCbCr 4:2:2	10bit	3840×2160	60/59.94/50/P	SMPTE ST 2082-10 SMPTE ST 2036-1
			4096×2160	60/59.94/50/48/47.95/P	SMPTE ST 2082-10 SMPTE ST 2048-1
		12bit	3840×2160	30/29.97/25/24/23.98/P	SMPTE ST 2082-10 SMPTE ST 2036-1
			4096×2160	30/29.97/25/24/23.98/P	SMPTE ST 2082-10 SMPTE ST 2048-1
	RGB 4:4:4	10bit	3840×2160	30/29.97/25/24/23.98/P	SMPTE ST 2082-10 SMPTE ST 2036-1
			4096×2160	30/29.97/25/24/23.98/P	SMPTE ST 2082-10 SMPTE ST 2048-1
		12bit	3840×2160	30/29.97/25/24/23.98/P	SMPTE ST 2082-10 SMPTE ST 2036-1
			4096×2160	30/29.97/25/24/23.98/P	SMPTE ST 2082-10 SMPTE ST 2048-1

I/O Connectors

SDI Output Connector	
SER02	2 BNC connectors
SER04	4 Micro-BNC connectors
Output Impedance	75 Ω
Output Amplitude	800 mVp-p ± 10%
Output Return Loss	
5 MHz – 1.485 GHz	15 dB or more
1.485 GHz – 2.97 GHz	10 dB or more
2.97GHz - 6GHz	7 dB or more
6GHz - 12GHz	4 dB or more
Overshoot	Less than 10%
Rise and Fall Times	
12G	45 ps or less (20 – 80%)
3G	135 ps or less (20 – 80%)
HD	270 ps or less (20 – 80%)
SD	0.4 ns or more, 1.5 ns or less (20 – 80%)
DC Offset	0 ± 0.5 V

* For SER04, the value when the following Micro-BNC-BNC conversion cable is used is indicated.

Product Name:	Micro BNC Cable
Model:	DM2.5HWSC002EA-BJ
Length:	200 mm
Manufacturer:	Canare Electric Co., Ltd.

SDI Video Output

SDI Signal	
Bit Rate	
12G	11.880Gbps, 11.880/1.001Gbps
3G	2.970Gbps, 2.970/1.001Gbps
HD	1.485Gbps, 1.485/1.001Gbps
SD	270Mbps
Timing Adjustment	
Adjustment Range	Entire frame
Adjustment Unit	
V	Lines
H	Clocks (148.5 MHz, 148.5/1.001 MHz, 74.25 MHz, 74.25/1.001 MHz, 27 MHz)
Selecting the Timing Reference	SD and HD only; SERIAL only for 12G and 3G
SERIAL	Signals are output at the timing defined in the signal standard.
LEGACY	Signals are output at the same timing as Leader’s conventional signal generators.

3 SPECIFICATIONS

Test Patterns	
12G, 3G, HD	100% color bar, 75% color bar, multiformat color bar (ARIB STD-B28, pattern 2 area can be set to 100% white, 75% white, or +I), check field, flat field white 100%, white 50%, black 0%, red 100%, green 100%, blue 100%
SD	
525/ 59.94I	100% color bar, 75% color bar, SMPTE color bar, check field, flat field white 100%, white 50%, black 0%, red 100%, green 100%, blue 100%
625/50I	EBU color bar, BBC color bar, check field, flat field white 100%, white 50%, black 0%, red 100%, green 100%, blue 100%
4K Additional Test Patterns (future support)	
UHDColBar	ARIB STD-B66 UHDTV MULTIFORMAT COLOR BAR
HLGCB	ARIB STD-B72 Color Bar Test Pattern for HLG HDR-TV System
	Recommendation ITU-R BT.2111 HLG
Slog3_LiveHDR_narrow_V11	S-Log3 (Live HDR) Ver.1.11 narrow range scale
User Pattern Display	Select one from INT1 to INT4 for SD, HD, and 4K, respectively.
File Format	24-bit full color bitmap format (.bmp) 24/48-bit TIFF format (.tif) uncompressed only
Automatic Switching	Automatically switches between selectable color bar patterns.
Switch Time	1 – 255 sec
Pattern Scrolling	
Direction	Eight directions (up, down, left, right, and their combinations)
Speed Range and Unit	
Interlace	In unit of fields
V	±256 lines (in 1-line steps)
H	±256 dots (in 2-dot steps)
Progressive	In unit of frames
V	±256 lines (in 1- or 2-line steps)
H	±256 dots (in 2- or 4-dot steps)

* Not available when the check field pattern is selected.

3 SPECIFICATIONS

Safety Area Markers

12G, 3G, HD	Action safe area (90%) Title safe area (80%) 4:3 aspect ratio (can be turned on and off separately)
SD	Action safe area (90%) Title safe area (80%) (can be turned on and off separately)

* Not available when the check field pattern is selected.

ID Characters

Number of Characters	Up to 20 characters
Size	32 × 32, 64 × 64, 128 × 128, 256 × 256 dots
Brightness	100%, 75% (black only for the background)
Display Position	Anywhere on the display
Display Position Adjustment Range	
V	0 - 100% (in units of 1%)
H	0 - 100% (in units of 1%)
Blinking Display (*1)	On/Off
On Time	1 - 9 sec (in units of 1 sec)
Off Time	1 - 9 sec (in units of 1 sec)
Scrolling (*1)	
Function	Scroll including the ID character background
Direction	Two directions (left and right)
Speed Range and Unit	
Interlace	In unit of fields ±256 dots (in 2-dot steps)
Progressive	In unit of frames ±256 dots (in 2- or 4-dot steps)

* Not available when the check field pattern is selected.

*1 The blinking display and scrolling can be set simultaneously.

Logo Mark

Logo Mark Data	24-bit full-color data
Maximum Size	640 (dots) × 480 (lines) (VGA size)
Number of Logo Marks That Can Be Saved in the Instrument	Up to 4 types
Display Position	Anywhere on the display
Display Position Adjustment Range	
V	0 - 100% (in units of 1%)
H	0 - 100% (in units of 1%)
File Format	24-bit full color bitmap format (.bmp)
Logo Mark Data Transfer	The data is transfer from a USB memory device to the instrument.

* Not available when the check field pattern is selected.

3 SPECIFICATIONS

Component On/Off

Function Each of the Y/G, Cb/B, and Cr/R components can be turned on and off independently.

* Not available when the check field pattern is selected.

Moving Box

Box Color White, yellow, cyan, green, blue, red, magenta, black
 Speed Setting V/H LOW / MIDDLE / HIGH
 Size Setting V/H SIZE 1 - 5

* Not available when the check field pattern is selected.

Circle

Display Position 90%, 80%, or 70% of the resolution
 Brightness 100% / 75%
 Blinking Display On/Off
 On Time 1 - 9 sec (in units of 1 sec)
 Off Time 1 - 9 sec (in units of 1 sec)

* Not available when the check field pattern is selected.

Time Code

Size 32 × 32, 64 × 64, 128 × 128, 256 × 256 dots
 Brightness 100%, 75% (black only for the background)
 Display Position Anywhere on the display
 Display Position Adjustment Range
 V 0 - 100% (in units of 1%)
 H 0 - 100% (in units of 1%)

* Not available when the check field pattern is selected.

Image Overlay

Display Priority Test pattern < Circle < Moving box < Safety area marker < Logo mark < ID character < Time code (The display order cannot be changed.)
 Simultaneous Display The test pattern, circle, moving box, safety area marker, logo mark, ID character, and time code can be displayed simultaneously.

Embedded Audio

Embedded Channels Can be turned on and off at the group level.
 16 channels (4 channels × 4 groups)
 Sampling Frequency 48 kHz sampling (synced with the video signal)
 Resolution 20 bits, 24 bits
 Pre-emphasis OFF, 50/15, CCITT (only the CS bit is switched)
 Frequency SILENCE, 400 Hz, 800 Hz, 1 kHz
 Level -60 – 0 dBFS (in units of 1 dBFS)
 Audio Click OFF, 1 sec, 2 sec, 4 sec

3 SPECIFICATIONS

- * Audio (including packets) cannot be embedded when the check field pattern is selected.
- * The frequency, level, and audio click can be set for each channel.
- * The audio click and digital audio are asynchronous.
- * Not available when lip sync is enabled.
- * The following limitations apply for SD (525/59.94I).
 - For 16 channel output, the resolution is set to 20 bits.
 - Up to three groups (12 channels) can be output at 24-bit resolution.

Lip Sync Pattern

Setting	On/Off
* AES/EBU is synchronized with SDI1.	
* Not available when the check field pattern is selected.	
* Safety area markers, ID characters, logo marks, moving boxes, circles, and time codes cannot be overlaid.	
* The audio click of embedded audio is disabled, and audio synchronized to the lip sync pattern is output.	

User Payload (future support)

Setting	On/Off
* The content of the user payload ID can be edited only with a web browser.	

3.3.4 LT4670-SER03 (PTP)

Corresponding Standard

Internet Protocol Version	IPv4
PTP Standard	IEEE 1588 – 2008
Supported Profile	SMPTE ST 2059 / AES67 / General

I/O Connectors

SFP/SPF+ connector	
Number of Ports	2
Port Type	SFP gauge
Compliant Standard	MSA
Supported Modules and Types	
SFP Transceiver RJ-45	1000Base-T
SFP + Optical Transceiver	10GBase-SR and 10GBase-SW
* The SFP/SFP+ module is optional.	

Leader Function

Number of Controllable Leader Devices	2
Communication Mode	Multicast / Unicast / MIXED SMPTE / MIXED SMPTE without negotiation
Domain Number	0 – 127 (SMPTE ST 2059) 0 – 255 (AES67 / General)
Announce Message Rate (*1)	0.125s 8Hz / 0.25s 4Hz / 0.5s 2Hz / 1s 1Hz / 2s 0.5Hz / 4s 0.25Hz / 8s 0.125Hz / 16s 0.0625Hz
Sync Message Rate (*1)	0.0078s 128Hz / 0.015s 64Hz / 0.0312s 32Hz / 0.0625s 16Hz / 0.125s 8Hz / 0.25s 4Hz / 0.5s 2Hz / 1s 1Hz / 2s 0.5Hz / 4s 0.25Hz / 8s 0.125Hz / 16s 0.0625Hz
Priority 1	0 – 255
Priority 2	0 – 255
Number of Connectable Followers	1000 (theoretical value when the sync message is 8 Hz)

*1 The message rate setting range varies depending on the profile.

Follower Function

Number of Controllable Follower Devices	2
Communication Mode	Multicast / Unicast / MIXED SMPTE / MIXED SMPTE without negotiation
Domain Number	0 – 127 (SMPTE ST 2059) 0 – 255 (AES67 / General)
Delay Message Rate	0.0078s 128Hz / 0.015s 64Hz / 0.0312s 32Hz / 0.0625s 16Hz / 0.125s 8Hz / 0.25s 4Hz / 0.5s 2Hz / 1s 1Hz / 2s 0.5Hz / 4s 0.25Hz / 8s 0.125Hz / 16s 0.0625Hz
Announce Timeout Count	2 - 10

3.3.5 LT4670-SER04 (25G-IP)

This section describes the IP functions of the LT4670-SER04 (25G-IP/12G-SDI TSG).

IP Corresponding Standard

IP Format	SMPTE ST 2022-6 SMPTE ST 2110-20/21/30/31/40
Synchronization Mode	PTP (SMPTE ST 2059)

IP Formats and Standards

Table 3-7| HD video signal formats and standards (*1)

Color System	Quantization	Image	Frame (Field) Frequency/Scanning	Corresponding Standard
YCbCr 4:2:2	10bit	1280×720	60/59.94/50/30/29.97/25/24/23.98/P	SMPTE ST 292-1 SMPTE ST 296
		1920×1080	60/59.94/50/I	SMPTE ST 292-1
			30/29.97/25/24/23.98/P	SMPTE ST 274
			30/29.97/25/24/23.98/PsF	SMPTE ST 292-1 SMPTE RP 211

Table 3-8 | 3G-A video signal formats and standards (*1)

Color System	Quantization	Image	Frame (Field) Frequency/Scanning	Corresponding Standard
YCbCr 4:2:2	10bit	1920×1080	60/59.94/50/P	SMPTE ST 274
	12bit	1920×1080	60/59.94/50/I	SMPTE ST 425-1
			30/29.97/25/24/23.98/P	
			30/29.97/25/24/23.98/PsF	
RGB 4:4:4	10bit	1280×720	60/59.94/50/30/29.97/25/24/23.98/P	SMPTE ST 296 SMPTE ST 425-1
		1920×1080	60/59.94/50/I	SMPTE ST 274
	30/29.97/25/24/23.98/P		SMPTE ST 425-1	
	30/29.97/25/24/23.98/PsF			
	12bit	1920×1080	60/59.94/50/I	SMPTE ST 425-1
		30/29.97/25/24/23.98/P		

3 SPECIFICATIONS

Table 3-9 | 12G video signal formats and standards (*1)

Division Transmission System	Color System	Quantization	Image	Frame Frequency/ Scanning	Corresponding Standard
2 sample interleave	YCbCr 4:2:2	10bit	3840×2160	60/59.94/50/P	SMPTE ST 2082-10 SMPTE ST 2036-1
			4096×2160	60/59.94/50/48/47.95/P	SMPTE ST 2082-10 SMPTE ST 2048-1
		12bit	3840×2160	30/29.97/25/24/23.98/P	SMPTE ST 2082-10 SMPTE ST 2036-1
			4096×2160	30/29.97/25/24/23.98/P	SMPTE ST 2082-10 SMPTE ST 2048-1
	RGB 4:4:4	10bit	3840×2160	30/29.97/25/24/23.98/P	SMPTE ST 2082-10 SMPTE ST 2036-1
			4096×2160	30/29.97/25/24/23.98/P	SMPTE ST 2082-10 SMPTE ST 2048-1
		12bit	3840×2160	30/29.97/25/24/23.98/P	SMPTE ST 2082-10 SMPTE ST 2036-1
			4096×2160	30/29.97/25/24/23.98/P	SMPTE ST 2082-10 SMPTE ST 2048-1

Test Patterns

100% color bar, 75% color bar, multiformat color bar (ARIB STD-B28, pattern 2 area can be set to 100% white, 75% white, or +I), check field, flat field white 100%, white 50%, black 0%, red 100%, green 100%, blue 100%

User Patterns

Select one from INT1 to INT4

Audio Signals

SMPTE ST 2110-30/31

SILENCE, 400Hz, 800Hz, 1kHz

*1 Can be set to formats not listed here, but the output is unstable.

Supported Protocols

Supported Protocols

IPv4 (Internet Protocol version 4)
IGMPv2/v3 (Internet Group Management Protocol)
NMOS (IS-04/05) (future support)

IP Output Connector

Connector Type

SFP+ / SFP28

Number of Ports

2 (*1)

Compliant Standards

10GBASE-SR / 10GBASE-LR / 25GBASE-SR /
25GBASE-LR

Fiber Type

Multi mode / Single mode

*1 The standard must be matched between the two output connectors.

IP Packet Emulation (future support)

Function	Adding jitter and checksum errors to the test signals of SMPTE ST 2110-20
Error	FCS ERROR / IP CS / UDP CS
Jitter	1 / 10 / 20 / 30 / 40 / 50 / 60 / 70 / 80 / 90 / 100 packet

- * Errors and jitter will be reflected in the output from port 1.
- * Jitter during 4K output will be up to 20 packets.
- * The duration of jitter varies depending on the output signal format.
- * There is a ±10% error margin in the duration of jitter.
- * RTP timestamps cause a delay twice the packet transmission interval.

3.3.6 LT4670-SER11 (POWER UNIT)

Power Supply Redundancy	Supported
Replacement Method	Can be replaced without turning off the power of the main unit.
Alarm	A power supply alarm is indicated on the LED and LCD and notified by an SNMP trap.

3.3.7 SFP Transceiver (Sold Separately)

LC2148

Product Name	SFP+ MULTI-MODE
Classification	Class 1
Output Level	-1 dBm max.
Wavelength	850 nm
Manufacturer	GIGALIGHT TECHNOLOGY

LC2149

Product Name	SFP+ SINGLE-MODE
Classification	Class 1
Output Level	+0.5 dBm max.
Wavelength	1310 nm
Manufacturer	GIGALIGHT TECHNOLOGY

LC2151

Product Name	SFP28 MULTI-MODE
Classification	Class 1
Output Level	+2.4 dBm max.
Wavelength	850 nm
Manufacturer	GIGALIGHT TECHNOLOGY

LC2152

Product Name	SFP28 SINGLE-MODE
Classification	Class 1
Output Level	+2.0 dBm max.
Wavelength	1310 nm
Manufacturer	GIGALIGHT TECHNOLOGY

4 PANEL DESCRIPTION

4.1 Front Panel

An overall and enlarged view of the front panel is shown below.

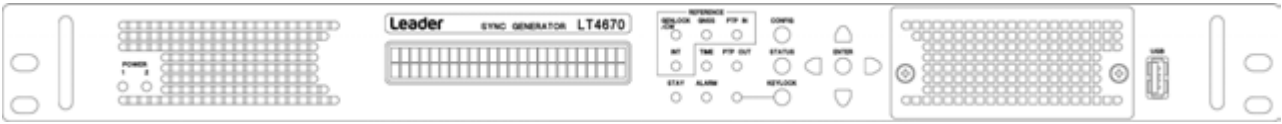

Figure 4-1 | Front panel (overall view)

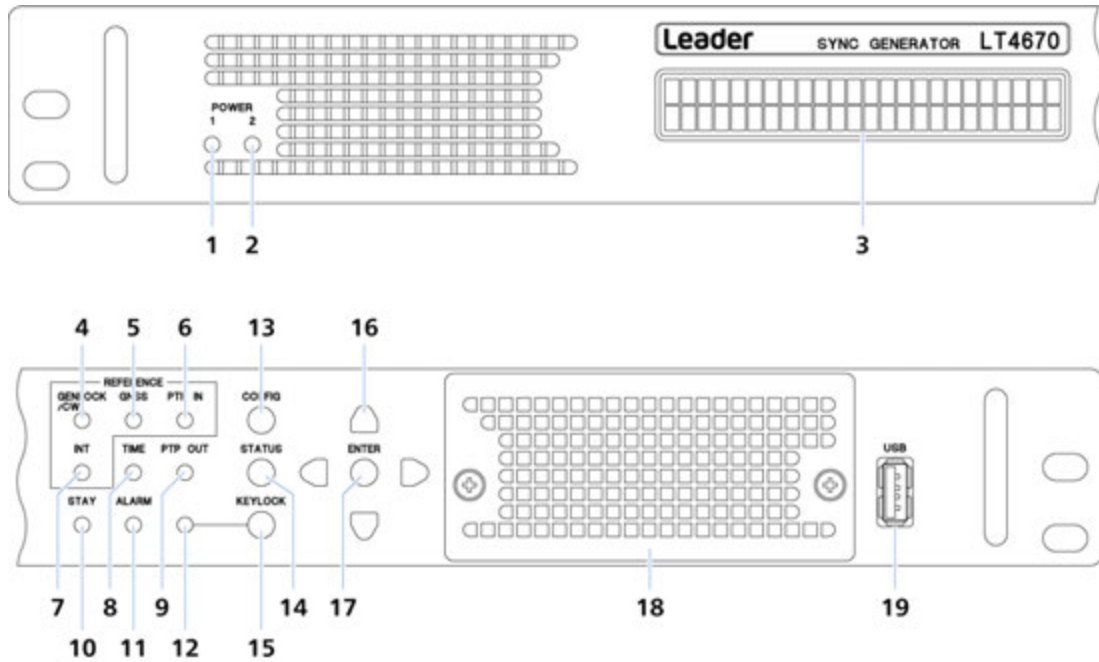

Figure 4-2 | Front panel (enlarged view)

1 POWER 1

Lights in green when POWER1 is on.

Lights red in the following cases.

- When an error occurs in the POWER1 fan
- When the power supply is redundant and an error occurs on POWER1
- When the power supply is redundant and POWER1 is off

[See also] "5.2 Turning the Power On"

2 POWER 2 (SER11)

Lights in green when POWER2 is on.

Lights red in the following cases.

- When an error occurs in the POWER2 fan
- When the power supply is redundant and an error occurs on POWER2
- When the power supply is redundant and POWER2 is off

[See also] "5.2 Turning the Power On"

3 LCD panel

Displays various information.

4 GENLOCK/CW

Lights in green when the reference signal is locked in GENLOCK or CW.

Flashes in orange until locked, lights in orange during stay in sync.

[See also] "6.2.2 Genlock Mode" "6.2.3 CW Mode"

5 GNSS (SER01)

Lights in green when the reference signal is locked in GNSS.

Flashes in orange until locked, lights in orange during stay in sync.

[See also] "6.2.4 GNSS mode (SER01)"

6 PTP IN (SER03)

Lights in green when the reference signal is locked in PTP.

Flashes in orange until locked, lights in orange during stay in sync.

[See also] "6.2.5 PTP mode (SER03)"

7 INT

Lights in green when the reference signal is INTERNAL.

[See also] "6.2.1 Internal Mode"

8 TIME

Lights in green when the time is successfully acquired from the selected TIME SOURCE.

Lights in orange when the time has not been obtained or when the TIME SOURCE has been changed.

When TIME SOURCE is LTC, LTC ST309, VITC, VITC ST309, or NTP, it flashes in orange if the time regularly obtained from TIME SOURCE and the internal time differ by more than 1 second.

9 PTP OUT

Lights in green when the PTP output is operating normally.

[See also] "6.3.5 PTP Signal Output (SER03)"

10 STAY

Lights in orange when in stay-in-sync mode.

[See also] "6.2 Signal Input (Genlock Operation)"

11 ALARM

Lights in red when an alarm occurs.

[See also] "6.5 Alarm Display"

12 KEYLOCK

Lights in green when the key lock is enabled.

[See also] "6.1.2 Enabling the Key Lock"

13 CONFIG

The CONFIG menu is displayed.

Switches the top menu or returns to the higher level menu. It also cancels the settings.

[See also] "6.1.3 Menu Operations"

14 STATUS

The STATUS menu is displayed.

Switches the top menu or returns to the higher level menu.

[See also] "6.1.3 Menu Operations" "16 STATUS MENU"

15 KEYLOCK

Holding the key locks the keys or releases the key lock.

[See also] "6.1.2 Enabling the Key Lock"

16 Arrow keys

Used to move the cursor and to set values.

[See also] "6.1.3 Menu Operations"

17 ENTER

Confirms values and enters a lower level menu.

[See also] "6.1.3 Menu Operations"

18 Fan (LP2184)

Cooling fan for the instrument. It needs to be replaced periodically.

[See also] "19.2.2 Front Fan Unit Replacement"

19 USB

USB port. Used to save and load various data.

[See also] "6.1.1 Connecting a USB Memory Device"

4.2 Rear Panel

An overall and enlarged view of the rear panel is shown below.

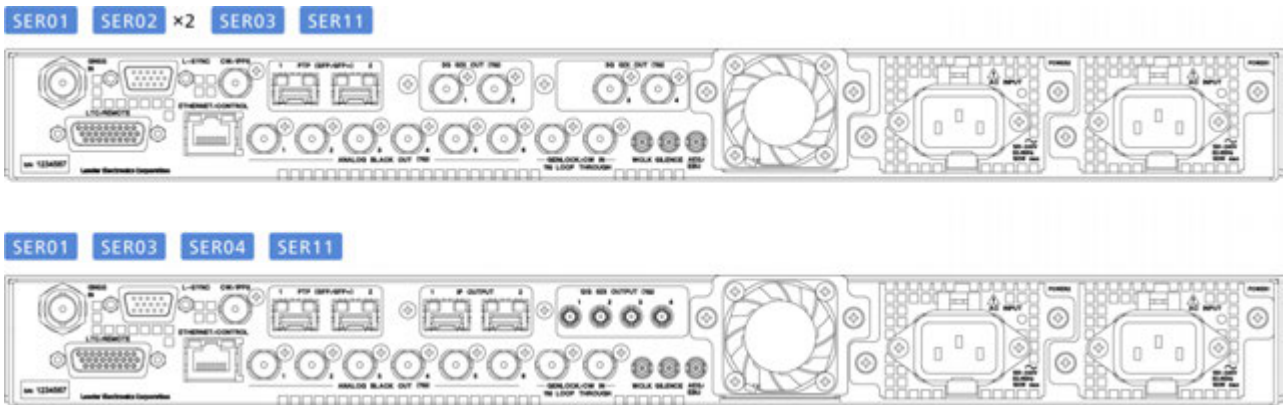

Figure 4-3 | Rear panel (overall view)

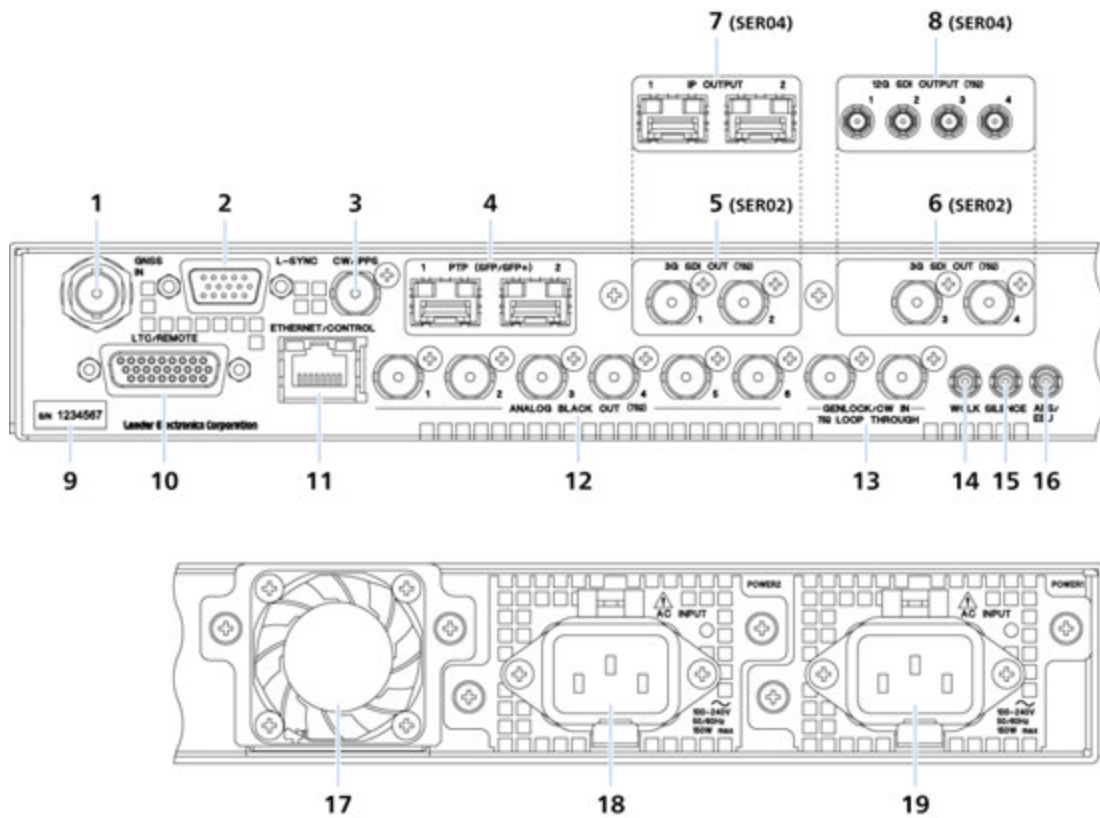

Figure 4-4 | Rear panel (enlarged view)

1 GNSS IN (SER01)

Optional GNSS input connector. It supports GPS, GLONASS, GALILEO, BDS, and QZSS. A separately sold GNSS antenna is available.

[See also "6.2.4 GNSS mode (SER01)" "15.5 Setting the GNSS (SER01)"]

2 L-SYNC

Control port for synchronizing the time of two LT4670 units. A separately sold L-SYNC cable (LC2186) is available.

[See also "6.6 L-SYNC"]

3 CW/1PPS

10 MHz CW or 1PPS output connector.

[See also "6.3.3 CW/1PPS Signal Output" "11 CW/1PPS CONFIG MENU"]

4 SFP/SFP+ 1, 2 (SER03)

Optional SFP/SFP+ port.

To use this port, insert one of the following SFP modules sold separately.

- SFP RJ-45 (LC2141/LC2142)
- SFP+ MULTI-MODE (LC2148)
- SFP+ SINGLE-MODE (LC2149)

[See also "6.2.5 PTP mode (SER03)" "13 PTP CONFIG MENU (SER03)" "15.6 Configuring the PTP Settings (SER03)"]

5 3G SDI OUT 1, 2 (SER02)**6 3G SDI OUT 3, 4 (SER02)**

Optional SDI output connector. It outputs SD, HD, and 3G signals.

Adding SER21 allows the connector to output the 4K 3G-Quad signal as well. (Two SER02 units are required.)

[See also "6.3.4 SDI Signal Output (SER02)" "12 SDI CONFIG MENU (SER02/SER04)"]

7 IP OUTPUT (SER04)

Optional SFP+/SFP28 port. It outputs signals compliant with ST 2022-6 and ST 2110.

To use this port, insert one of the following SFP modules sold separately.

- SFP+ MULTI-MODE (LC2148)
- SFP+ SINGLE-MODE (LC2149)
- SFP28 MULTI-MODE (LC2151)
- SFP28 SINGLE-MODE (LC2152)

[See also "6.3.7 IP Signal Output (SER04)" "14 IP CONFIG MENU (SER04)" "15.7 Setting the IP (SER04)"]

8 12G SDI OUTPUT (SER04)

Optional SDI output connector. It outputs SD, HD, 3G, and 12G signals.

[See also "6.3.5 SDI Signal Output (SER04)" "12 SDI CONFIG MENU (SER02/SER04)"]

9 Serial number label

The serial number is printed on this label.

10 LTC/REMOTE

Time code and remote I/O connector.

A separately sold LTC cable (LC2185) is available for connection with LT4448.

[See also] "6.3.7 LTC Signal I/O and Remote Control" "10 LTC CONFIG MENU"

11 ETHERNET/CONTROL

Ethernet port.

It supports SNMP, REST-API (future support), HTTP/HTTPS (HTTPS to be supported in the future), and NTP.

12 ANALOG BLACK OUT 1-6

Analog black output connectors.

They output HD tri-level sync or NTSC/PAL black burst signals.

[See also] "6.3.1 Analog Black Signal Output" "8 BLACK CONFIG MENU"

13 GENLOCK/CW IN

Loop-through analog sync signal or 10 MHz CW input connectors.

For analog sync signals, input HD tri-level sync or NTSC/PAL black burst signals.

[See also] "6.2.2 Genlock Mode" "6.2.3 CW Mode" "7 REFERENCE CONFIG MENU"

14 WCLK

48 kHz word-clock output connector.

[See also] "6.3.2 Audio Signal Output" "9.3 Setting the Word-clock Output"

15 SILENCE

AES/EBU output connector compatible with DARS.

[See also] "6.3.2 Audio Signal Output" "9.2 Setting the Silence Output"

16 AES/EBU

AES/EBU output connector.

[See also] "6.3.2 Audio Signal Output" "9.1 Setting the AES/EBU Output"

17 Fan (LP2184)

Cooling fan for the instrument. It needs to be replaced periodically.

[See also] "19.2.3 Rear Fan Unit Replacement"

18 POWER2 (SER11)

Optional AC inlet. Adding this option provides power supply redundancy.

It needs to be replaced periodically.

The LED lights in green or red in conjunction with the POWER2 LED on the front panel.

[See also] "5.2 Turning the Power On" "19.2.1 Power Supply Unit Replacement"

19 POWER1

AC inlet. It needs to be replaced periodically.

The LED lights in green or red in conjunction with the POWER1 LED on the front panel.

[See also] "5.2 Turning the Power On" "19.2.1 Power Supply Unit Replacement"

5 PREPARATIONS

5.1 Installation

The instrument can be mounted on a rack or placed on a stand or shelf for use.

5.1.1 Rack Mounting

If you are mounting this instrument on a rack, be sure to provide additional support for the body of the instrument. If you use only the front panel to mount the instrument, the instrument case may deform or fall. This instrument can be mounted on a 19-inch EIA standard rack.

The recommended slide rails are shown in the following table. To mount this instrument on a rack, two slide rails, one for the left side and one for the right side of the instrument, are required.

Table 5-1 | Recommended slide rails

Model Number	Manufacturer
KC-251-16	TAKIGEN MFG CO., LTD.
C203-16	Accuride Japan Co., Ltd.
C-203-16	Settsu Metal Industrial Co., Ltd.

Slide Rail Attachment

Attach slide rails to the instrument using binding head machine screws (M4×10).

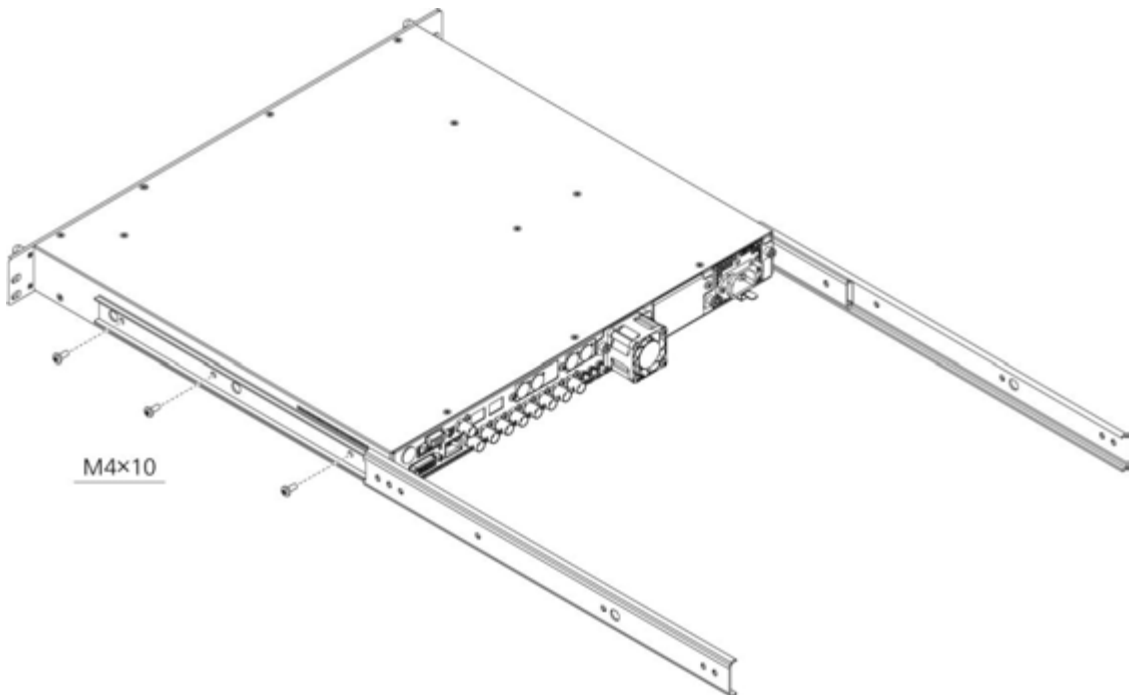

Figure 5-1 | Slide rail attachment

Rack Mounting

Insert the instrument into the rack, and then fasten the front panel to the rack. Use M5, 10-32UNF, or 12-24UNC screws.

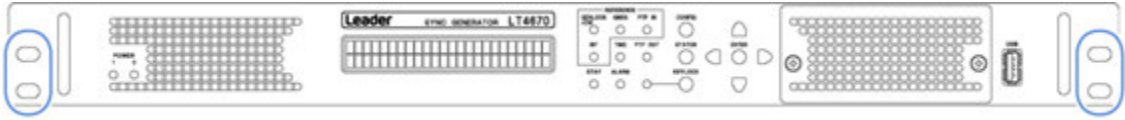

Figure 5-2 | Rack mounting

5.1.2 Installation Without Using a Rack

When installing the instrument without using a rack, place it horizontally on a securely installed stand or shelf.

Use it with great care to prevent it from falling.

5.2 Turning the Power On

5.2.1 Turning the Instrument On and Off

This instrument does not have a power switch. To turn on the power, connect the supplied power cord to POWER1 on the rear panel.

When you turn on the power, the following screens are displayed. During this time, key operations are not possible.

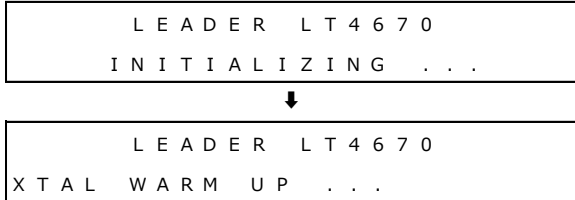

When the following screen is displayed, the startup is complete.

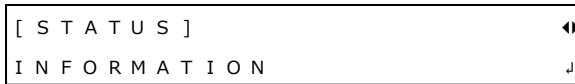

When you turn on the power, POWER 1 on the front panel and the LED on the rear panel light in green.

If an error occurs in the fan of the power supply unit, these LEDs turn red. In this case, check the power supply unit where the error occurred and contact your local LEADER agent.

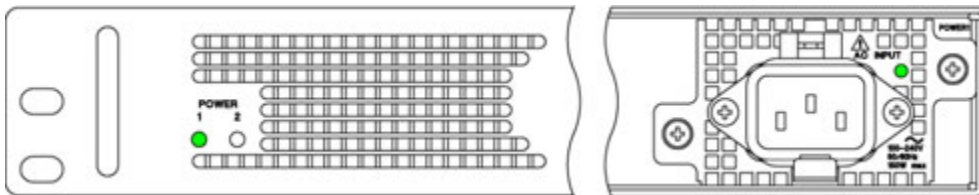

Figure 5-3 | POWER LEDs

Immediately after the power is turned on, the instrument is set to the conditions that it was in when the power was turned off the last time.

However, if POWER ON RECALL on the SYSTEM CONFIG menu is set to an option other than OFF, the instrument starts with the specified preset.

[See also] "15.2.4 Power-on Settings"

5.2.2 Mounting the AC Cord Clamp

An AC cord clamp is included with the instrument to prevent the power cord from being pulled free of the AC inlet. To mount it, follow the procedure below.

1 Mount the AC cord clamp to the LT4670.

Insert it until it clicks into place.

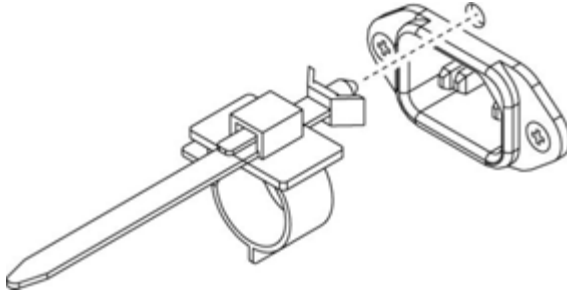

Figure 5-4 | Mounting the AC cord clamp 1

2 Connect the power cable.

Ensure that the power cable is inserted within the loop of the AC cord clamp.

3 Adjust the position of the loop portion of the AC cord clamp.

Move the loop portion forward or backward to position it as shown below.

To pull the loop portion forward, lift the lever first and then move the loop portion.

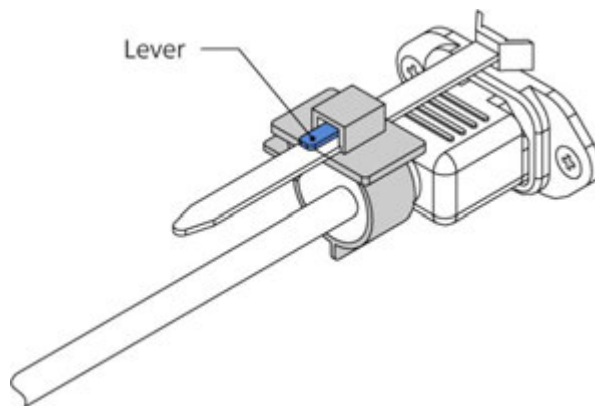

Figure 5-5 | Mounting the AC cord clamp 2

4 Adjust the size of the loop portion of the AC cord clamp.

Turn the knob to tighten the loop portion until the knob stops.

To loosen the loop portion, lift the lever first and then move the loop portion.

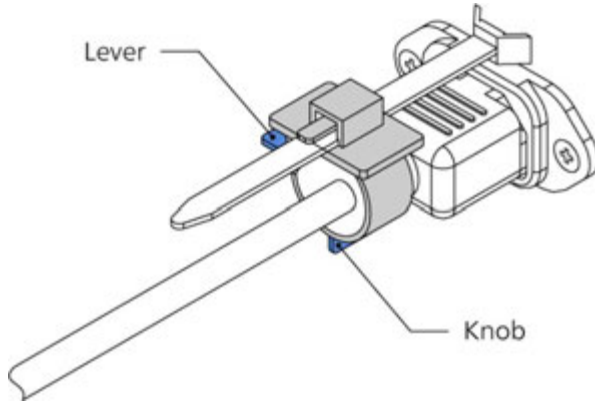

Figure 5-6 | Mounting the AC cord clamp 3

5 Pull the power cord to check that it does not come loose.

5.2.3 Adding the Power Supply Unit (SER11)

Adding the optional power supply unit (SER11) to POWER2 on the rear panel provides power supply redundancy. Even if one of the power supplies fails, the instrument can continue to run with the other power supply, enabling you to build a highly reliable system.

It is possible to add the power supply unit with the power turned on. The following is the procedure for adding the power supply unit to POWER2 with the power of POWER1 turned on as an example.

The power supply unit must be added by LEADER or the designated service personnel. Contact your local LEADER agent.

1 Insert the new power supply unit to POWER2.

Insert the unit until it clicks into place.

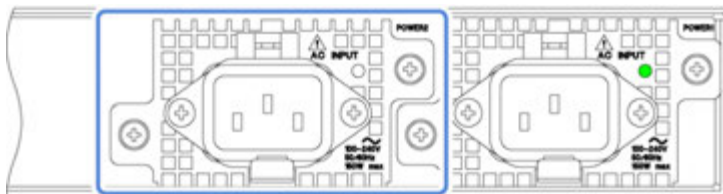

Figure 5-7 | Adding the power supply unit 1

2 Tighten the two screws.



Figure 5-8 | Adding the power supply unit 2

3 Connect the power cable to POWER2.



Install the power supply unit first and then connect the power cable.
Failure to follow this procedure may result in electric shock.

4 Check that the LED on the power supply unit lights in green.



Figure 5-9 | Adding the power supply unit 3

When the power is supplied to POWER1 and POWER2, the POWER LEDs on the front panel light in green. Usually, use the product in this state.

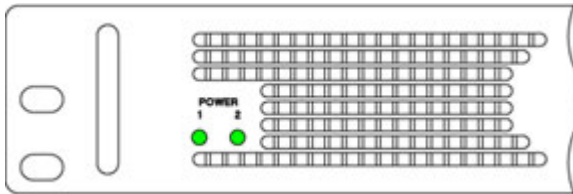

Figure 5-10 | POWER LEDs (during normal operation)

In one of the following situations, either of the POWER LEDs on the front panel turns red and an alarm is displayed.

- An error occurs in the fans of the power supply units.
- An error occurs in the power supply units.
- The power is not supplied to either of the power supply units.

In this case, check the power supply units in which an error occurred and contact your local LEADER agent.

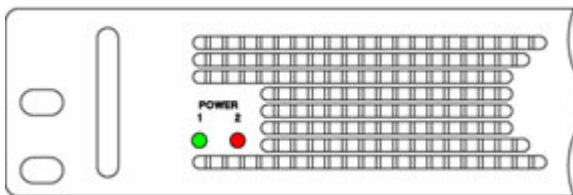

Figure 5-11 | POWER LEDs (when an error occurs)

6 BASIC OPERATION

6.1 Operation Basics

6.1.1 Connecting a USB Memory Device

To write and read various types of data, you can use a USB memory device.

You can connect and disconnect a USB memory device with the power turned on.

Use a USB memory device with USB DEVICE on the SYSTEM CONFIG menu set to ENABLE.

```
1 . U S B   D E V I C E
   ■ E N A B L E   □ D I S A B L E
```

Connecting a USB Memory Device

When you connect a USB memory device, the following message appears.

Do not turn the power off or remove the USB memory device while it is being accessed.

```
* U S B   S T O R A G E   D E V I C E *
*           I N S E R T           *
```

Removing the USB Memory Device

When you remove the USB memory device, the following message appears.

```
* U S B   S T O R A G E   D E V I C E *
*           E J E C T           *
```

6.1.2 Enabling the Key Lock

You can enable the key lock to prevent settings from being changed when keys are pressed by mistake.

Enabling the Key Lock

Hold down the KEYLOCK key until the following message is displayed.

This enables the key lock, causing the LED to light in green.

While the key lock is enabled, the following message is displayed if you press a key; no key operations are possible.

```
*           K E Y   L O C K           *
P U S H   < K E Y L O C K >   3 S E C
```

Releasing the Key Lock

Hold down the KEYLOCK key until the following message is displayed.

This releases the key lock, causing the LED to turn off.

```
*           K E Y   L O C K           *
*   U N L O C K   S U C C E S S   *
```

6.1.3 Menu Operations

The menu is largely divided into two types, the CONFIG menu and the STATUS menu.

CONFIG Menu

This menu is used to configure this instrument. Press the CONFIG key to display it.

When the menu level is 0, press the CONFIG key or the ► key to switch from one menu to another in the order below. Press the ◀ key to switch from one menu to another in the reverse order. (This includes option menus).

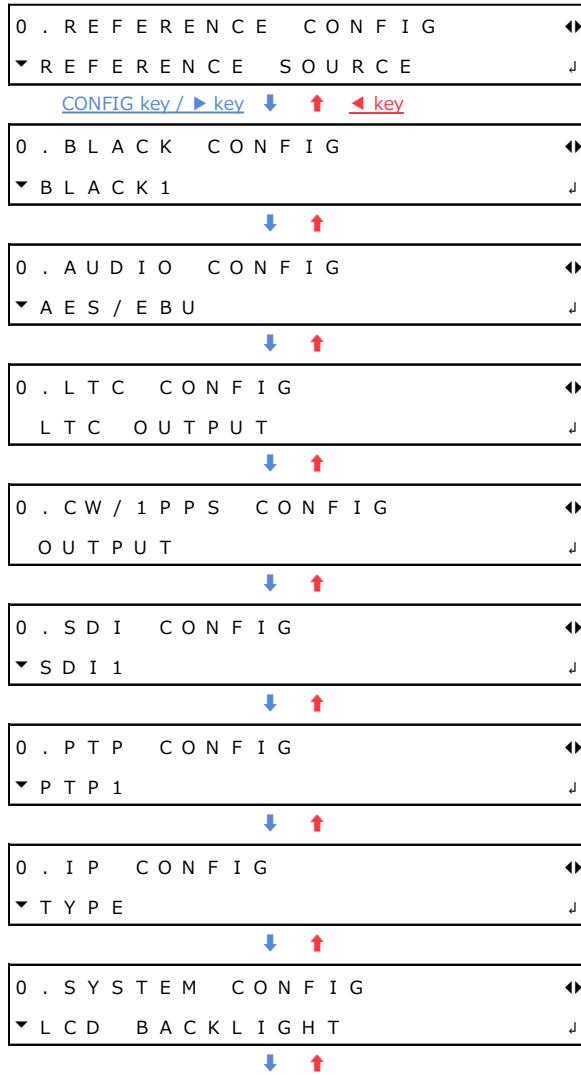

Except for some cases, a number is displayed at the upper left of the CONFIG menu. This number indicates the menu level. The larger the number, the deeper the level. To enter a lower level menu, press the ENTER key. To return to a higher level menu, press the CONFIG key. When the menu level is other than 0, hold down the CONFIG key to return to menu level 0.

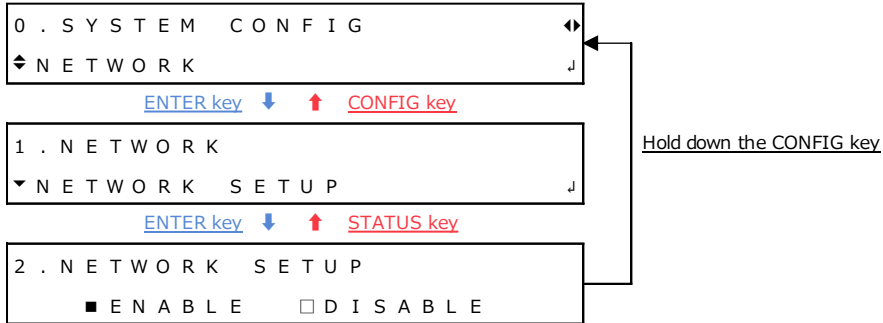

STATUS Menu

This menu displays the status of this instrument. Press the STATUS key to display it. When you are the top level, press the STATUS key or the ► key to switch from one menu to another in the order below. Press the ◀ key to switch from one menu to another in the reverse order.

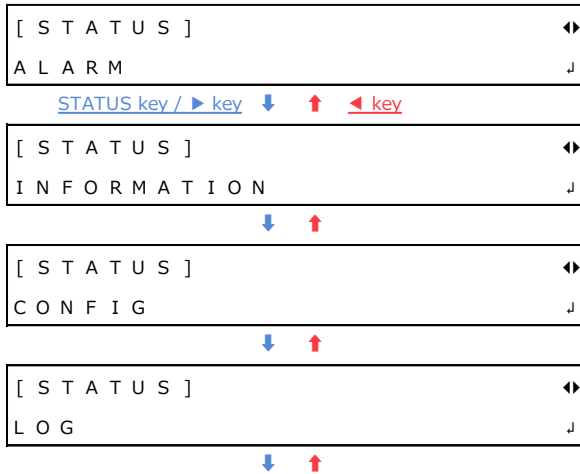

No levels are indicated on the STATUS menu. As with the CONFIG menu, to enter a lower level menu, press the ENTER key. To return to a higher level menu, press the STATUS key. When you are at a level other than the top level, hold down the STATUS key to return to the top level.

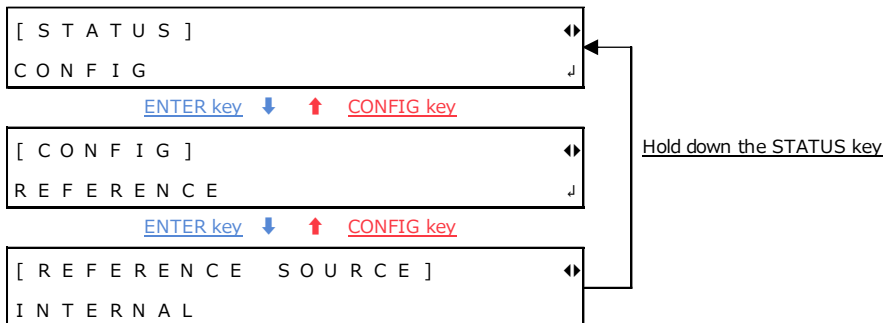

Specifying Values

To specify a value, select a digit with the ◀ and ▶ keys first and then change it with the ▲ and ▼ keys. Hold down the ▲ or ▼ key to change the value quickly.

Except for some cases, value modifications are applied immediately, but the value is not confirmed until you press the ENTER key.

```
1 . G E N L O C K   T I M I N G   F I N E
  F I N E :       0
```

Selecting Items

To select an item, use the ◀ and ▶ keys.

```
1 . L C D   B A C K L I G H T
■ O N   □ A U T O   O F F   □ O F F
```

If a menu contains many items, the menu may look like the one shown below. An * is displayed for the currently set item.

```
1 . R E F E R E N C E   S O U R C E
◆▶ * G E N L O C K   F M T - A U T O
```

If a cursor (◻) is displayed, use the ◀ and ▶ keys to move the cursor, and use the ▲ key to turn the item on and the ▼ key to turn it off.

```
3 . S D I 1   C O M P O N E N T
◻ Y / G       ■ C b / B       ■ C r / R
```

To select a single item from multiple menus, use the ▲ and ▼ key to select a menu and then use the ◀ and ▶ key to select the item.

```
4 . S D I 1   C O L O R   B A R
▼▶ * 1 0 0 %

4 . S D I 1   M O N I T O R
◆▶ F L A T   F I E L D   1 0 0 %

4 . S D I 1   S D I
▲   C H E C K   F I E L D
```

Confirming and Canceling Settings

To confirm settings, press the ENTER key.

After you change settings, press the CONFIG key instead of the ENTER key to return the settings to their original values.

6.2 Signal Input (Genlock Operation)

Genlock refers to the act of establishing synchronization using a reference signal. Here, the operation in the following five modes is explained according to the following flow of steps.

Internal mode:	Mode in which an internal signal is used as a reference signal (factory default value)
Genlock mode:	Mode in which an external analog sync signal is used as a reference signal
CW mode:	Mode in which an external 10MHz CW signal is used as a reference signal
GNSS mode (SER01):	Mode in which an external GNSS signal is used as a reference signal
PTP mode (SER03):	Mode in which a PTP signal is used as a reference signal

1. Setting
 2. Input of a reference signal
 3. Lock
 4. An error occurs in the reference signal
 5. The reference signal is restored
 6. Relock
-

The operation performed when the reference signal is restored differs depending on RECOVERY MODE on the REFERENCE CONFIG menu. When RECOVERY MODE is set to AUTO, relock is automatically performed. When it is set to MANUAL, relock is not performed. Here, the operation performed when the mode is AUTO, in which relock is automatically performed, is explained.

```

2 . R E C O V E R Y   M O D E
  ■ A U T O   □ M A N U A L

```

If "INT PLL" is displayed on "STATUS > INFORMATION > REF SRC" during genlock operation, it indicates that the crystal inside the instrument is faulty. If this happens, contact your local LEADER agent.

```

[ R E F   S R C ] G L - F M T - ( A )   ◀▶
I N T   P L L

```

6.2.1 Internal Mode

1. Setting

On the REFERENCE CONFIG menu, set REFERENCE SOURCE to INTERNAL.

```
1 . REFERENCE SOURCE
▶ * INTERNAL
```

Under "STATUS > INFORMATION > REF SRC", "INTERNAL" appears, and INT on the front panel lights in green. Use the instrument in this state.

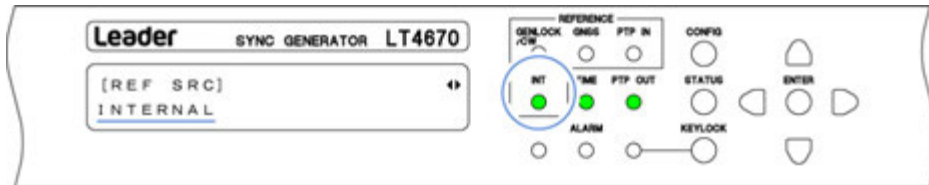

6.2.2 Genlock Mode

1. Setting

On the REFERENCE CONFIG menu, set REFERENCE SOURCE to GENLOCK FMT-AUTO or GENLOCK FMT-MANUAL.



When you set it to GENLOCK FMT-MANUAL, set the reference signal format manually. Use GENLOCK FORMAT on the REFERENCE CONFIG menu to select the reference signal format.

When you set it to GENLOCK FMT-AUTO, this instrument automatically identifies the reference signal format; this setting is not necessary.



When you set REFERENCE SOURCE to GENLOCK, GENLOCK/CW on the front panel blinks in orange, and under "STATUS > INFORMATION > REF SRC", "INITIALIZE" appears. From now on, this screen is used for explanation.



2. Input of a reference signal

Apply an HD tri-level sync or NTSC/PAL black burst signal to one of the GENLOCK/CW IN connectors on the rear panel. Use either of the following method to apply it.

- Apply to one connector and terminate the other at 75 Ω.
- Apply to one connector, connect the other to another device, and terminate the device at the end of the chain at 75 Ω.

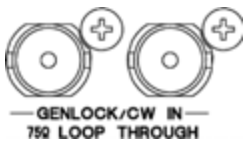

When you apply the signal, the message changes to "TRACKING" and the reference signal is introduced. Wait in this state.

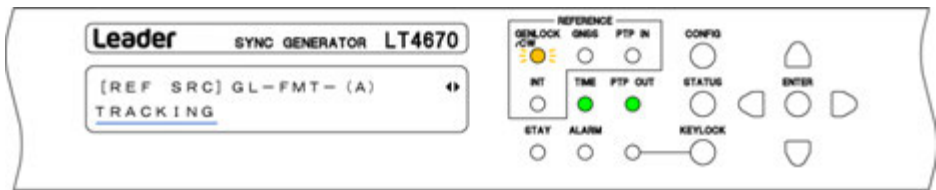

3. Lock

When the instrument is locked with the reference signal, GENLOCK/CW on the front panel lights in green, and the message changes to "LOCK". Use the instrument in this state.

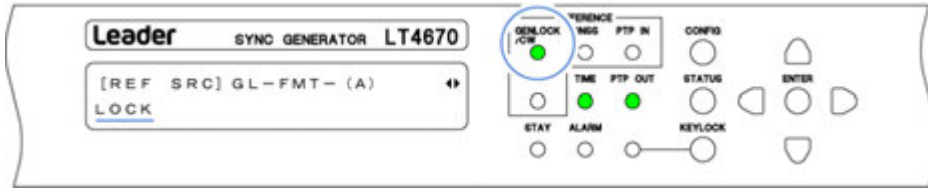

4. An error occurs in the reference signal

If an error occurs in the reference signal, the frequency that was in use immediately before the error occurred is maintained (stay-in-sync function).

When stay-in-sync becomes active, GENLOCK/CW and STAY light in orange, and the message changes to "STAY". In this case, check the reference signal.

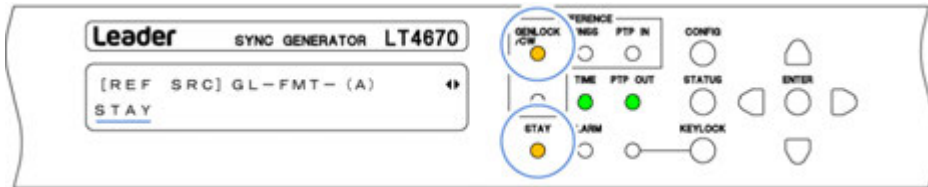

5. The reference signal is restored

When the reference signal is restored, STAY on the front panel blinks in orange, and the message changes to "RECOVERY". Wait in this state.

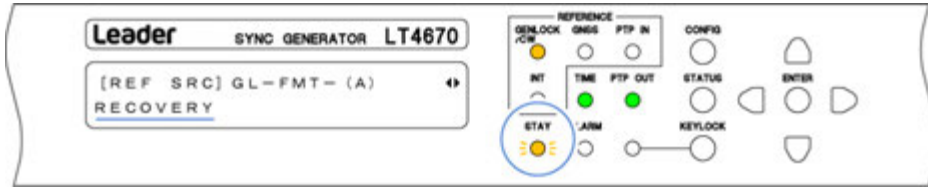

6. Relock

When the instrument is relocked with the reference signal, GENLOCK/CW on the front panel lights in green and STAY turns off. In addition, the message changes to "LOCK". Use the instrument in this state.

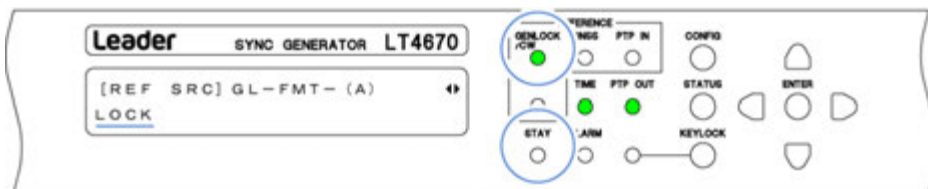

6.2.3 CW Mode

1. Setting

On the REFERENCE CONFIG menu, set REFERENCE SOURCE to 10MHz CW.



When you set REFERENCE SOURCE to 10MHz CW, GENLOCK/CW on the front panel blinks in orange, and under "STATUS > INFORMATION > REF SRC", "INITIALIZE" appears. From now on, this screen is used for explanation.

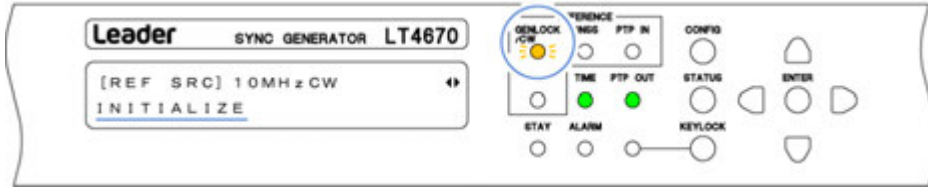

2. Input of a reference signal

Apply a 10MHz CW signal to one of the GENLOCK/CW IN connectors on the rear panel. Use either of the following methods to apply it.

- Apply to one connector and terminate the other at 75 Ω.
- Apply to one connector, connect the other to another device, and terminate the device at the end of the chain at 75 Ω.

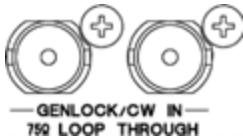

When you apply the signal, the message changes to "TRACKING" and the reference signal is introduced. Wait in this state.

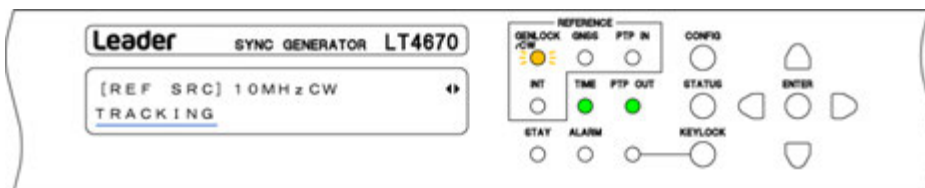

3. Lock

When the instrument is locked with the reference signal, GENLOCK/CW on the front panel lights in green, and the message changes to "LOCK". Use the instrument in this state.

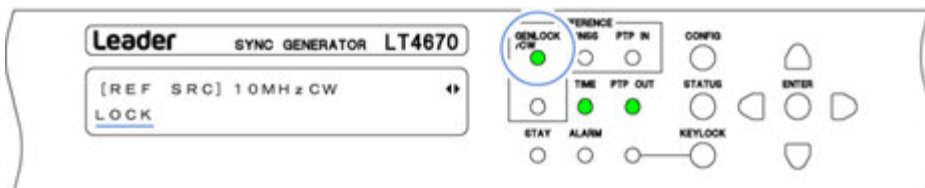

4. An error occurs in the reference signal

If an error occurs in the reference signal, the frequency that was in use immediately before the error occurred is maintained (stay-in-sync function).

When stay-in-sync becomes active, GENLOCK/CW and STAY light in orange, and the message changes to "STAY". In this case, check the reference signal.

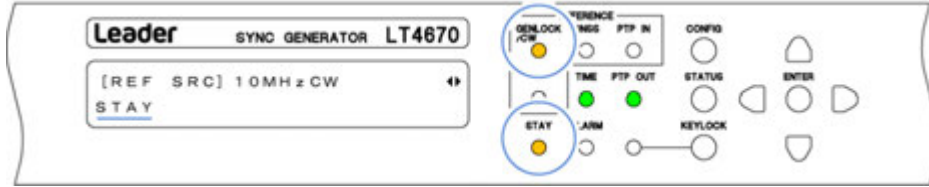

5. The reference signal is restored

When the reference signal is restored, STAY on the front panel blinks in orange, and the message changes to "RECOVERY". Wait in this state.

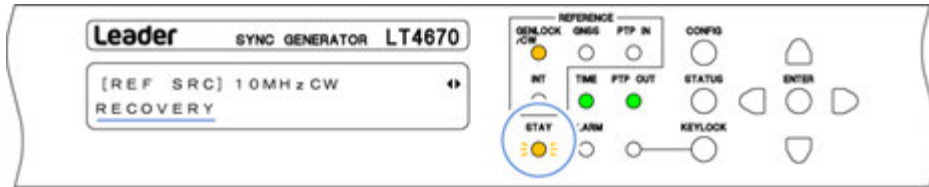

6. Relock

When the instrument is relocked with the reference signal, GENLOCK/CW on the front panel lights in green and STAY turns off. In addition, the message changes to "LOCK". Use the instrument in this state.

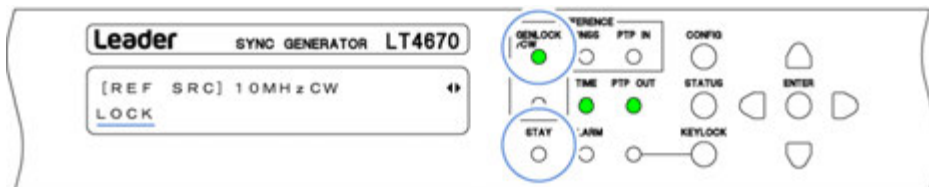

6.2.4 GNSS mode (SER01)

1. Setting

On the REFERENCE CONFIG menu, set REFERENCE SOURCE to GNSS.



When you set REFERENCE SOURCE to GNSS, GNSS on the front panel blinks in orange, and under "STATUS > INFORMATION > REF SRC", "GNSS No. Fix" appears. From now on, this screen is used for explanation.

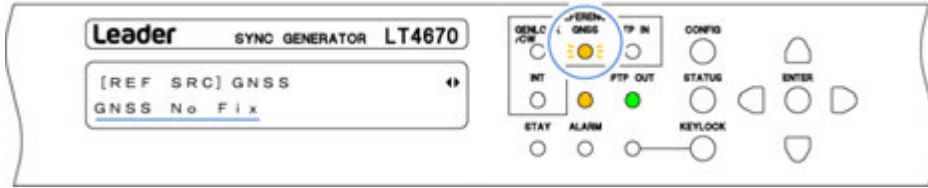

2. Input of a reference signal

Apply a GNSS signal to the GNSS IN connector on the rear panel.



When you apply the signal, an "*" is attached after "GNSS". In addition, the message changes to "ADJUST FREQ TO GNSS" > "ADJUST PHASE TO GNSS" > "TRACKING" in this order, and the reference signal is introduced. Wait in this state.

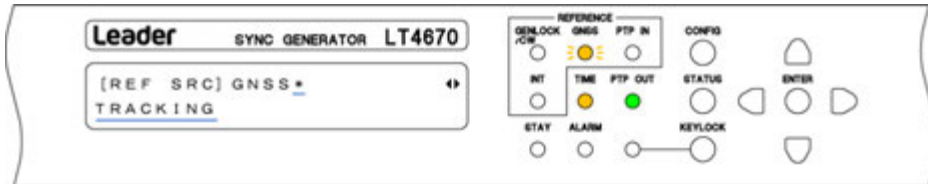

3. Lock

When the instrument is locked with the reference signal, GNSS on the front panel lights in green, and the message changes to "LOCK". Use the instrument in this state.

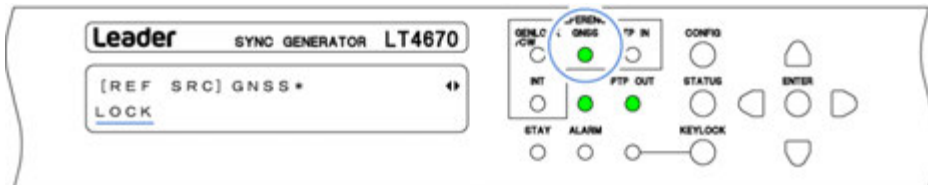

4. An error occurs in the reference signal

If an error occurs in the reference signal, the frequency that was in use immediately before the error occurred is maintained (stay-in-sync function).

When stay-in-sync becomes active, GNSS and STAY light in orange, and the message changes to "STAY". In this case, check the reference signal.

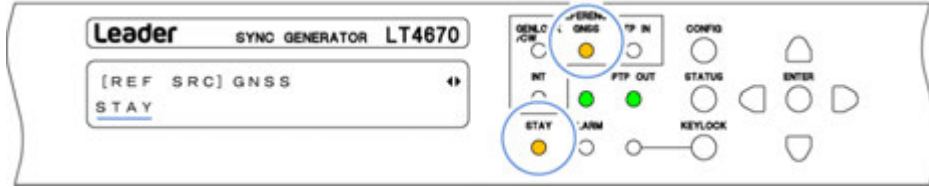

5. The reference signal is restored

When the reference signal is restored, STAY on the front panel blinks in orange, and the message changes to "RECOVERY". Wait in this state.

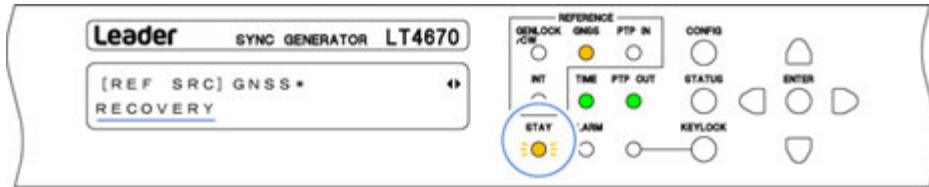

6. Relock

When the instrument is relocked with the reference signal, GNSS on the front panel lights in green and STAY turns off. In addition, the message changes to "LOCK". Use the instrument in this state.

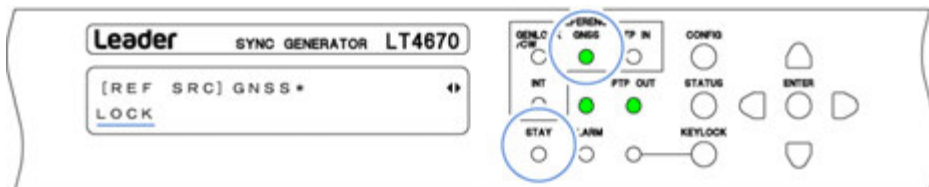

6.2.5 PTP mode (SER03)

1. Setting

In the REFERENCE CONFIG menu, set REFERENCE SOURCE to PTP1, PTP2, or PTP1/2. In the following example, it is set to PTP1.

```
1 . REFERENCE SOURCE
◀ * P T P 1
```

When you set REFERENCE SOURCE to PTP1 or PTP2, PTP IN on the front panel blinks in orange, and under "STATUS > INFORMATION > REF SRC", "PTP FOLLOWER AGING" > "PTP LEADER NOT FOUND" appears. From now on, this screen is used for explanation.

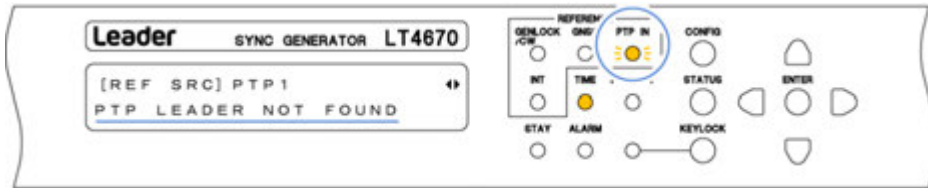

2. Input of a reference signal

Apply PTP signals to PTP connectors on the rear panel.

Mount and use one of the SFP and SFP+ modules listed below, which are sold separately. You can connect and disconnect the SFP and SFP+ modules with the power turned on.

- SFP RJ-45 (LC2141/LC2142)
- SFP+ MULTI-MODE (LC2148)
- SFP+ SINGLE-MODE (LC2149)

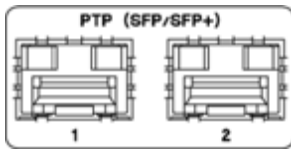

When you apply the signal, the message changes to "PTP ADJUST FREQ" > "PTP ADJUST PHASE" > "TRACKING" in this order, and the reference signal is introduced. Wait in this state.

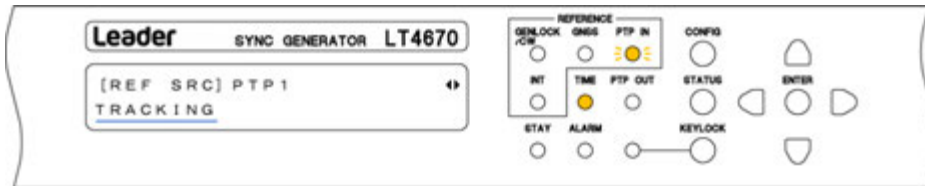

3. Lock

When the instrument is locked with the reference signal, PTP IN on the front panel lights in green, and the message changes to "LOCK". Use the instrument in this state.

When REFERENCE SOURCE is set to PTP1/2, the instrument automatically selects the reference signal. "LOCK" is displayed for the reference signal, and "PASSIVE" is displayed for the other signal.

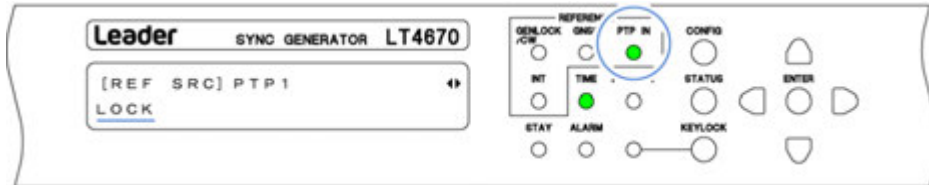

4. An error occurs in the reference signal

If an error occurs in the reference signal, the frequency that was in use immediately before the error occurred is maintained (stay-in-sync function).

When stay-in-sync becomes active, PTP IN and STAY light in orange, and the message changes to "STAY". In this case, check the reference signal.

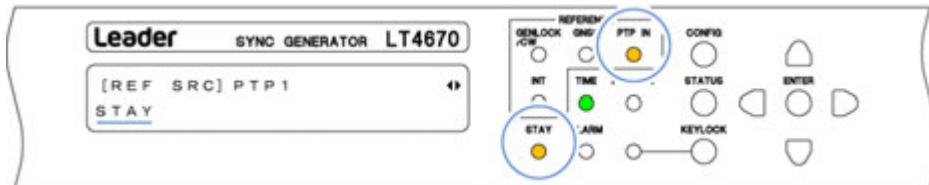

5. The reference signal is restored

When the reference signal is restored, STAY on the front panel blinks in orange, and the message changes to "PTP ADJUST FREQ" > "PTP ADJUST PHASE" > "RECOVERY" in this order. Wait in this state.

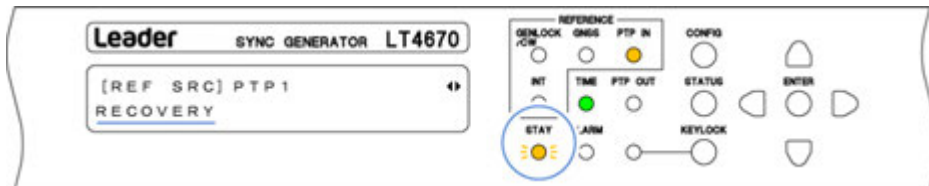

6. Relock



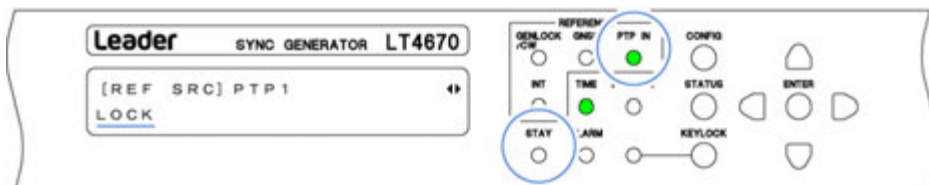





When the instrument is relocked with the reference signal, PTP IN on the front panel lights in green and STAY turns off. In addition, the message changes to "LOCK". Use the instrument in this state.



6 BASIC OPERATION

When REFERENCE SOURCE is set to PTP1/2, the PTP IN LED on the front panel is displayed as shown below according to the combination of the PTP1 state and the PTP2 state.

Table 6-1 | PTP IN LED

		PTP1		
		·LOCK ·PASSIVE	·STAY ·PTP ADJUST FREQ (when restored) ·PTP ADJUST PHASE (when restored) ·RECOVERY	·PTP FOLLOWER AGING ·PTP LEADER NOT FOUND ·PTP ADJUST FREQ (when locked) ·PTP ADJUST PHASE (when locked) ·TRACKING
PTP2	·LOCK ·PASSIVE	Lit in green 	Lit in orange 	Blinking orange 
	·STAY ·PTP ADJUST FREQ (when restored) ·PTP ADJUST PHASE (when restored) ·RECOVERY	Lit in orange 	Lit in orange 	Blinking orange 
	·PTP FOLLOWER AGING ·PTP LEADER NOT FOUND ·PTP ADJUST FREQ (when locked) ·PTP ADJUST PHASE (when locked) ·TRACKING	Blinking orange 	Blinking orange 	Blinking orange 

6.3 Signal Output

6.3.1 Analog Black Signal Output

Six analog black signals synchronized with the reference signal are output from ANALOG BLACK OUT connectors 1 to 6 on the rear panel.

You can set the analog black signals on the BLACK CONFIG menu.

[See also] "8 BLACK CONFIG MENU"

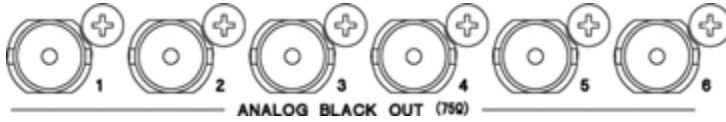

6.3.2 Audio Signal Output

An AES/EBU signal synchronized with the reference signal is output from the AES/EBU connector on the rear panel; a silence (DARS) signal synchronized with the reference signal is output from the SILENCE connector; and a word-clock signal synchronized with the reference signal is output from the WCLK connector. Use DIN cables.

You can set the audio signals on the AUDIO CONFIG menu.

[See also] "9 AUDIO CONFIG MENU"



6.3.3 CW/1PPS Signal Output

A 10MHz CW signal or 1PPS signal synchronized with the reference signal is output from the CW/1PPS connector on the rear panel.

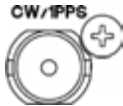

You can select the output signal type with CW/1PPS OUTPUT on the CW/1PPS CONFIG menu.

[See also] "11 CW/1PPS CONFIG MENU"



6.3.4 SDI Signal Output (SER02)

Four SDI signals synchronized with the reference signal are output from 3G SDI OUT connectors 1 to 4 on the rear panel.

You can set the SDI signal on the SDI CONFIG menu.

[See also] "12 SDI CONFIG MENU (SER02/SER04)"



6.3.5 SDI Signal Output (SER04)

Four SDI signals synchronized with the reference signal are output from 12G SDI OUT connectors 1 to 4 on the rear panel.

You can set the SDI signal on the SDI CONFIG menu.

[See also] "12 SDI CONFIG MENU (SER02/SER04)"

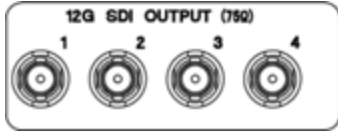

When using Micro BNC-BNC conversion cables, please prepare the following or contact your local LEADER agent.

Product Name:	Micro BNC Cable
Model:	DM2.5HWSC002EA-BJ
Length:	200 mm
Manufacturer:	Canare Electric Co., Ltd.

6.3.6 PTP Signal Output (SER03)



The SFP transceiver is a Class 1 laser product.
Ensure that laser light does not directly strike the eyes.

Two PTP signals synchronized with the reference signal are output from PTP connectors 1 and 2 on the rear panel.

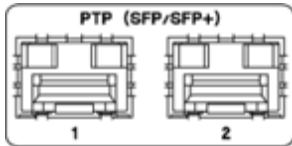

Mount and use one of the SFP and SFP+ modules listed below, which are sold separately. You can connect and disconnect the SFP and SFP+ modules with the power turned on.

- SFP RJ-45 (LC2141/LC2142)
- SFP+ MULTI-MODE (LC2148)
- SFP+ SINGLE-MODE (LC2149)

To output the PTP signal requires setting the PTP Leader. In the PTP CONFIG menu, set PTP1 MODE or PTP2 MODE to ENABLE LEADER.

[See also] "13.1 PTP Leader and PTP Follower"



When you set PTP1 MODE or PTP2 MODE to ENABLE LEADER, PTP OUT on the front panel blinks in orange, and the "STATUS > INFORMATION > PTP OUTPUT" message is switched to "TIME MEASURING" > "TIME SETTING" > "LISTENING" > "PRELEADER" in this order and displayed.

During this time, the PTP signal is not output correctly. Wait in this state.

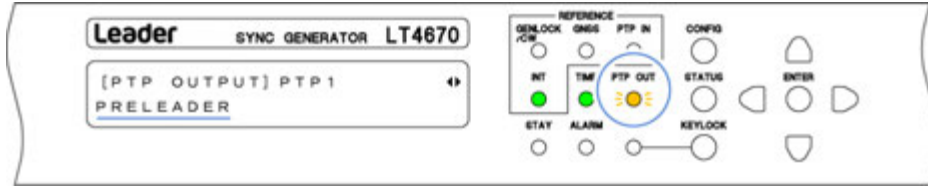

When the PTP output becomes normal, PTP OUT on the front panel lights in green, and the message changes to "LEADER". Use the instrument in this state.

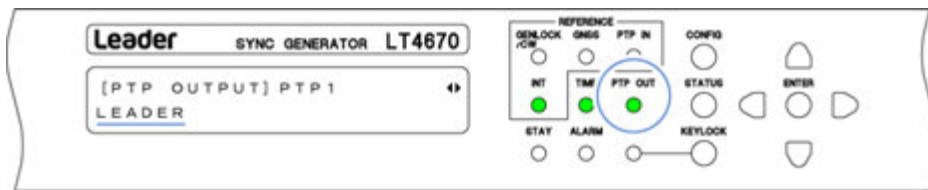

Note that when the BMCA function causes this instrument to enter the passive state, PTP OUT on the front panel lights in orange and the message changes to "PASSIVE".

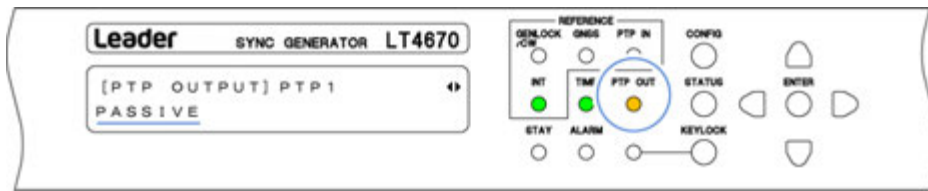

When PTP1 and PTP2 are both leaders, the PTP OUT LED on the front panel is displayed as shown below according to the combination of the PTP1 state and the PTP2 state.

Table 6-2 | PTP OUT LED

		PTP1		
		·LEADER	·PASSIVE	·TIME MEASURING ·TIME SETTING ·LISTENING ·PRELEADER
PTP2	·LEADER	Lit in green 	Lit in orange 	Blinking orange
	·PASSIVE	Lit in orange 	Lit in orange 	Blinking orange
	·TIME MEASURING ·TIME SETTING ·LISTENING ·PRELEADER	Blinking orange 	Blinking orange 	Blinking orange

6.3.7 IP Signal Output (SER04)



The SFP transceiver is a Class 1 laser product.
Ensure that laser light does not directly strike the eyes.

Two IP signals synchronized with the reference signal are output from IP OUTPUT connectors 1 and 2 on the rear panel.

You can set the IP signal on the IP CONFIG menu and IP OPTION menu.

[See also] "14 IP CONFIG MENU (SER04)" "15.7 Setting the IP (SER04)"

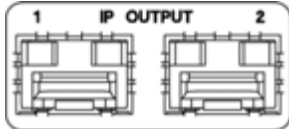

For IP signals, the patterns specified on the SDI CONFIG menu are output as follows. Up to four streams can be output per port within the band.

[See also] "12 SDI CONFIG MENU (SER02/SER04)"

- IP OUTPUT1/2 Stream1: Output the pattern specified with SDI1
- IP OUTPUT1/2 Stream2: Output the pattern specified with SDI2
- IP OUTPUT1/2 Stream3: Output the pattern specified with SDI3
- IP OUTPUT1/2 Stream4: Output the pattern specified with SDI4

Mount and use one of the SFP+ and SFP28 modules listed below, which are sold separately. You can connect and disconnect the SFP+ and SFP28 modules with the power turned on.

- SFP+ MULTI-MODE (LC2148)
- SFP+ SINGLE-MODE (LC2149)
- SFP28 MULTI-MODE (LC2151)
- SFP28 SINGLE-MODE (LC2152)

6.4 LTC Signal I/O and Remote Control

The LTC/REMOTE connector on the rear panel is used to input an LTC signal (1 input), output three LTC signals (3 outputs), and perform remote control (alarm output, preset recall).

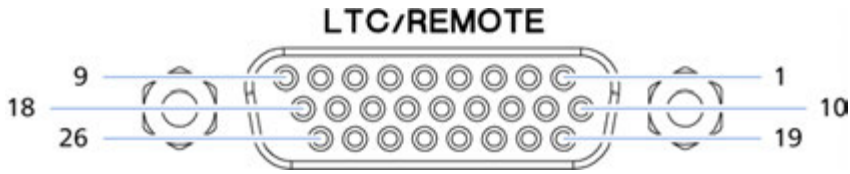

Figure 6-1 | LTC/REMOTE

Table 6-3 | Pinout

Pin No.	I/O	Pin Name
1	I	LTC+
2	-	GND
3	O	LTC1+
4	O	LTC2+
5	O	LTC3+
6	-	GND
7	O	ALARM1
8	O	ALARM2
9	-	RESERVED
10	I	LTC-
11	-	GND
12	O	LTC1-
13	O	LTC2-
14	O	LTC3-
15	-	GND
16	-	RESERVED
17	-	RESERVED
18	-	OPEN
19	-	SHIELD GND
20	I	PRESET1
21	I	PRESET2
22	I	PRESET3
23	I	PRESET4
24	-	GND
25	-	RESERVED
26	-	SHIELD GND

LTC Signal Input (1 input)

It is possible to insert time codes received through LTC into the black output, AES/EBU output, and SDI output (SER02/SER04) and output from LTC1 to LTC3.

LTC Signal Output (3 Outputs)

Time codes synchronized with the reference time are output from LTC1 to LTC3. You can select the time code type with TIME SOURCE on the REFERENCE CONFIG menu.

Alarm Output

When any of the alarms set to ENABLE with ALARM OPTION on the SYSTEM CONFIG menu occurs, the alarm is output from ALARM1 or ALARM2 at the 5V CMOS level. (The polarity can be inverted.)

[See also] "15.8.2 Turning the Alarm Output On and Off"

Table 6-4 | Alarm output

Alarm	Alarm Condition
UNIT POWER1	When an error occurs in POWER1 When power supply redundancy is provided and the power is not supplied to POWER1 (SER11)
UNIT POWER2	When an error occurs in POWER2 (SER11) When power supply redundancy is provided and the power is not supplied to POWER2 (SER11)
FAN POWER1	When an error occurs in the POWER1 fan
FAN POWER2	When an error occurs in the POWER2 fan (SER11)
FAN FRONT	When an error occurs in the front fan unit
FAN REAR	When an error occurs in the rear fan unit
INT PLL	When the crystal inside the instrument becomes fault
TIME LAG	When TIME SOURCE on the REFERENCE CONFIG menu is set to LTC, LTC ST309, VITC, VITC ST309, or NTP and the time acquired from TIME SOURCE differs from the internal time by 1 second or more
REFERENCE NO SIGNAL	When the set reference signal is not received
REFERENCE STAY	When an error occurs in the reference signal, and stay-in-sync is in operation.
GNSS ANTENNA	When ANTENNA POWER on the SYSTEM CONFIG menu is set to 3.3V or 5V and a short circuit occurs (SER01)

Recalling Presets

You can use PRESET1 to PRESET4 to recall presets 0 to 9.
Apply L according to the table below.

Table 6-5 | Recalling presets

Preset Numbers	23p	22p	21p	20p
	PRESET4	PRESET3	PRESET2	PRESET1
0	H	H	H	L
1	H	H	L	H
2	H	H	L	L
3	H	L	H	H
4	H	L	H	L
5	H	L	L	H
6	H	L	L	L
7	L	H	H	H
8	L	H	H	L
9	L	H	L	H

6.5 Alarm Display

If an alarm occurs, the ALARM indicator on the front panel lights in red.

To check the description of the alarm, select ALARM from the STATUS menu.

If multiple alarms have occurred, you can use the ◀ and ▶ keys to switch from the description of one alarm to that of another.

For information about the types of alarms displayed, see "16.1 ALARM Menu".

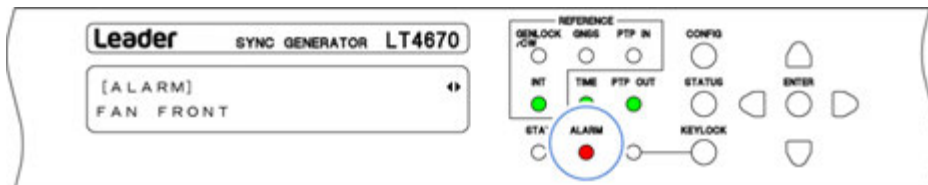

Figure 6-2 | Alarm display

6.6 L-SYNC

L-SYNC refers to a function whereby, in a redundant system, the primary and backup instruments, synchronized with the same analog sync signal, can be synchronized in time with each other.

The following explains how to use it, considering the following system as an example.

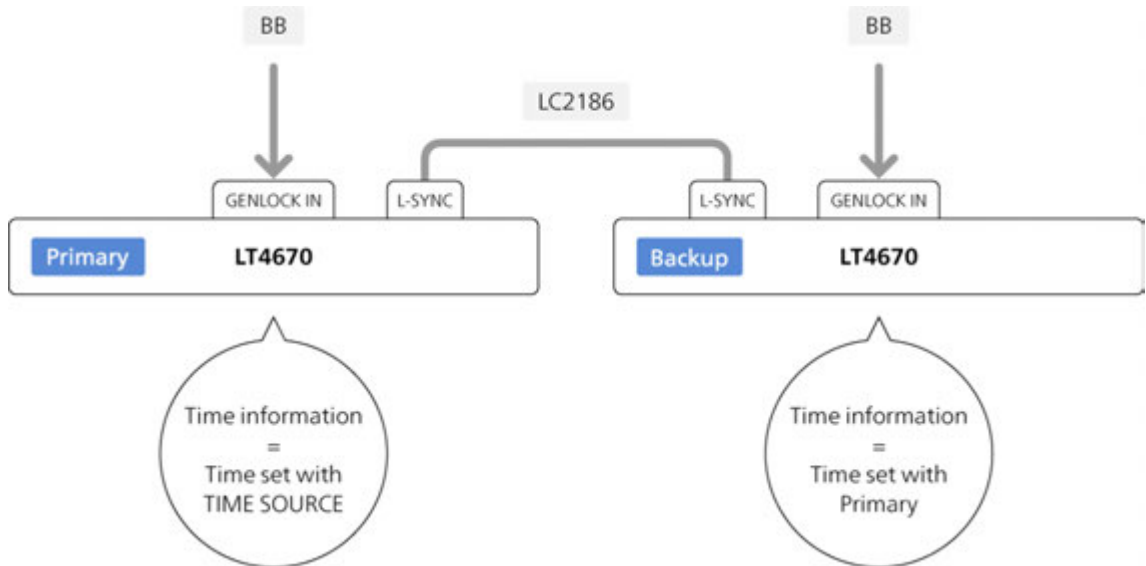
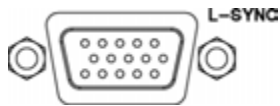

Figure 6-3 | L-SYNC

1. Connect the L-SYNC connectors of the LT4670s with an L-SYNC cable.

For the L-SYNC cable, use the LC2186 (sold separately).



2. Apply an analog sync signal to one of the GENLOCK/CW IN connectors of each of the LT4670 (primary) and the LT4670 (backup).

Apply the same analog sync signal to the primary and backup instruments. Terminate the unused connector of each of the primary and backup instruments at 75 Ω.

L-SYNC is not supported when the analog sync signal format is 23.98 Hz.

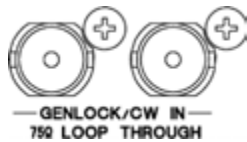

3. On each of the LT4670 (primary) and the LT4670 (backup), set REFERENCE SOURCE.

You can set REFERENCE SOURCE with "REFERENCE CONFIG > REFERENCE SOURCE".
Set it to "GENLOCK FMT-AUTO" or "GENLOCK FMT-MANUAL".

```
1 . R E F E R E N C E   S O U R C E
◀ * G E N L O C K   F M T - A U T O
```

When the operation is performed properly, GENLOCK/CW on the front panel lights in green.

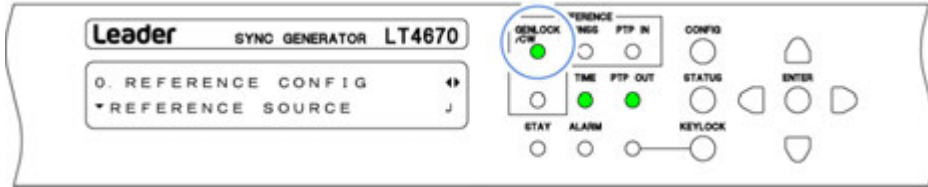

4. On the LT4670 (primary), set TIME SOURCE.

You can set TIME SOURCE with "REFERENCE CONFIG > TIME SOURCE". Select one of the options.

The TIME SOURCE setting of the LT4670 (backup) is fixed to INTERNAL by setting L-SYNC SETUP to BACKUP in step 5.

```
1 . T I M E   S O U R C E
▶ * I N T E R N A L
```

When the operation is performed properly, TIME on the front panel lights in green.

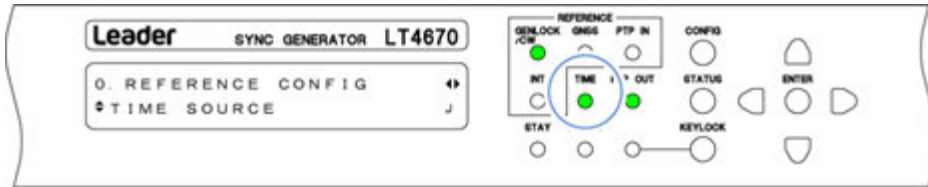

5. On each of the LT4670 (primary) and LT4670 (backup), set L-SYNC SETUP.

You can set L-SYNC SETUP with "SYSTEM CONFIG > TIME MANAGEMENT > L-SYNC SETUP".

For the LT4670 (primary), set it to "PRIMARY".

```
2 . L - S Y N C   S E T U P
▶ * P R I M A R Y
```

For the LT4670 (backup), set it to "BACKUP".

```
2 . L - S Y N C   S E T U P
▶ * B A C K U P
```

Subsequently, the time of LT4670 (backup) will be the same as the time set by the LT4670 (primary). When the time of the LT4670 (primary) changes, the time of the LT4670 (backup) will also change accordingly.

7 REFERENCE CONFIG MENU

The REFERENCE CONFIG menu is used to specify settings related to the reference signal and genlock operation.

To display the REFERENCE CONFIG menu, press CONFIG several times until the following menu appears.

```
0 . REFERENCE CONFIG
▼ GENLOCK SOURCE
```

7.1 Selecting the Reference Signal

To select the reference signal, follow the procedure below.

```
1 . REFERENCE SOURCE
▶ * INTERNAL
```

Procedure

REFERENCE CONFIG > REFERENCE SOURCE

Parameters

INTERNAL:	The internal reference signal is used.
GENLOCK FMT-AUTO:	An external reference signal received through GENLOCK/CW IN on the rear panel is used. The format is automatically identified.
GENLOCK FMT-MANUAL:	An external reference signal received through GENLOCK/CW IN on the rear panel is used. The format should be set manually.
10MHz CW:	An external reference signal received through GENLOCK/CW IN on the rear panel is used.
GNSS (SER01):	An external reference signal received through GNSS IN on the rear panel is used.
PTP1 (SER03):	An external reference signal received through PTP on the rear panel is used. PTP1 operates as a PTP follower.
PTP2 (SER03):	An external reference signal received through PTP on the rear panel is used. PTP2 operates as a PTP follower.
PTP1/2 (SER03):	An external reference signal received through PTP on the rear panel is used. Both PTP1 and PTP2 operate as PTP followers, and the instrument automatically selects the reference signal. You can check the selection result using "STATUS > INFORMATION > REF SRC". "LOCK" is displayed for the reference signal, and "PASSIVE" is displayed for the other signal.

Initial value

INTERNAL

7.2 Selecting the Genlock Format

When REFERENCE SOURCE is set to GENLOCK FMT-MANUAL, to select the genlock format, follow the procedure below. To select an item, use the ▲, ▼, ◀, and ▶ keys.

The genlock formats are expressed in terms of the total number of lines, not the number of effective lines. REF represents the field reference pulse, and ID represents the field ID.

1 . G E N L O C K N T S C
▼ ▶ * N T S C B B
1 . G E N L O C K P A L
◆ ▶ P A L B B
1 . G E N L O C K C O M P O N E N T
◆ ▶ 5 2 5 / 5 9 . 9 4 I
1 . G E N L O C K 1 1 2 5 : H D
◆ ▶ 1 1 2 5 / 6 0 I
1 . G E N L O C K 7 5 0 : H D
▲ ▶ 7 5 0 / 6 0 P

Procedure

REFERENCE CONFIG > GENLOCK FORMAT

Parameters

NTSC:	NTSC BB / NTSC BB+REF / NTSC BB+ID / NTSC BB+REF+ID
PAL:	PAL BB / PAL BB+REF
COMPONENT:	525/59.94I / 525/59.94P / 625/50I / 625/50P
1125:HD:	1125/60I / 1125/59.94I / 1125/50I / 1125/30P / 1125/29.97P / 1125/25P / 1125/24P / 1125/23.98P / 1125/24PsF / 1125/23.98PsF / 1125/60P / 1125/59.94P / 1125/50P
750:HD:	750/60P / 750/59.94P / 750/50P / 750/30P / 750/29.97P / 750/25P / 750/24P / 750/23.98P

Initial value

NTSC BB (when FORMAT SETTING on the SYSTEM CONFIG menu is set to NTSC)

PAL BB (when FORMAT SETTING on the SYSTEM CONFIG menu is set to PAL)

7.3 Setting the Genlock Timing

When REFERENCE SOURCE is set to GENLOCK, you can collectively adjust the timing of the output signals (ANALOG BLACK OUT, 3G SDI OUT, AES/EBU, SILENCE, WCLK, and LTC) relative to the reference signal. (You can also adjust them individually.)

One step is approximately 0.5 ns, which covers a 1-dot cycle.

```
1 . G E N L O C K   T I M I N G   F I N E
  F I N E :         0
```

Procedure

REFERENCE CONFIG > GENLOCK TIMING FINE

Parameters

±100

Initial value

0

7.4 Selecting the Satellite (SER01)

When REFERENCE SOURCE is set to GNSS, to select the satellite, follow the procedure below. Leave this set to ALL under standard operating circumstances.

```
1 . G N S S   S A T E L L I T E
  ▶ * A L L
```

Procedure

REFERENCE CONFIG > GNSS SATELLITE

Parameters

ALL / GPS / GLONASS / GALILEO / BDS / GPS+QZSS

Initial value

ALL

7.5 Setting the Recovery Operation

Under RECOVERY/TRACKING on the REFERENCE CONFIG menu, you can set the recovery operation that takes place when the reference signal is lost during genlock operation. This menu appears when REFERENCE SOURCE is set to an option other than INTERNAL.

```
0 . REFERENCE CONFIG
◆ RECOVERY / TRACKING
```

7.5.1 Selecting the Recovery Mode

To select the operation to perform when the reference signal recovers after it is lost during genlock operation, follow the procedure below.

```
2 . RECOVERY MODE
  ■ AUTO   □ MANUAL
```

Procedure

REFERENCE CONFIG > RECOVERY/TRACKING > MODE

Parameters

AUTO:	Relocks onto the reference signal.
MANUAL:	Stay-in-sync operation is held. Use REFERENCE READJUST to relock.

Initial value

AUTO

7.5.2 Selecting the Relock Speed (Auto)

When RECOVERY MODE is set to AUTO, to select the relock speed, follow the procedure below. From the time this instrument is started until the time set with IMMEDIATE MODE TIME elapses, the instrument operates with IMMEDIATE regardless of the selection made here. (This does not apply when REFERENCE SOURCE is set to GNSS.)

```
2 . AUTO SETTING
◆ * FAST
```

Procedure

REFERENCE CONFIG > RECOVERY/TRACKING > AUTO SETTING

Parameters

IMMEDIATE:	Immediately relocks onto the reference signal. This cannot be selected when REFERENCE SOURCE is set to GNSS.
FAST:	Quickly relocks onto the reference signal.
SLOW:	Slowly relocks onto the reference signal.

Initial value

FAST

7.5.3 Selecting the Relock Speed (Manual)

When RECOVERY MODE is set to MANUAL, to select the relock speed, follow the procedure below.

From the time this instrument is started until the time set with IMMEDIATE MODE TIME elapses, the instrument operates with IMMEDIATE regardless of the selection made here.

```
2 . M A N U A L   S E T T I N G
◆ * I M M E D I A T E
```

Procedure

REFERENCE CONFIG > RECOVERY/TRACKING > MANUAL SETTING

Parameters

IMMEDIATE:	Immediately relocks onto the reference signal.
FAST:	Quickly relocks onto the reference signal.
SLOW:	Slowly relocks onto the reference signal.

Initial value

IMMEDIATE

7.5.4 Power-on Settings

From the time this instrument is started until the set time elapses, the instrument operates with IMMEDIATE regardless of the selection made with AUTO SETTING or MANUAL SETTING.

To set the time for which the instrument operates with IMMEDIATE, follow the procedure below.

```
2 . I M M E D I A T E   M O D E   T I M E
B O O T - U P :       5   m i n
```

Procedure

REFERENCE CONFIG > RECOVERY/TRACKING > IMMEDIATE MODE TIME

Parameters

OFF / 5 - 30 [min]

Initial value

5 [min]

7.6 Setting the Relock

When REFERENCE SOURCE is set to an option other than INTERNAL, relock onto the reference signal, select OK by following the procedure below.

```
1 . R E F E R E N C E   R E A D J U S T
    O K            C A N C E L
```

Procedure

REFERENCE CONFIG > REFERENCE READJUST

7.7 Selecting the Time Source

To select the time source to use with this instrument, follow the procedure below.

The date and time selected here is used for the log and the time code and for storing to a USB memory device, for example.

```
1 . T I M E   S O U R C E
▶ * I N T E R N A L
```

Procedure

REFERENCE CONFIG > TIME SOURCE

Parameters

INTERNAL / LTC / LTC ST309 / VITC / VITC ST309 / NTP /
GNSS (SER01) / PTP1 (SER03) / PTP2 (SER03) / PTP1/2 (SER03)

Initial value

INTERNAL

The selectable TIME SOURCES depend on the setting of REFERENCE SOURCE as shown below.

Table 7-1 | TIME SOURCE

REFERENCE SOURCE	TIME SOURCE	Description
INTERNAL	INTERNAL	The internal clock is used.
	LTC (*1)	At power-on and when REFERENCE SOURCE or TIME SOURCE is changed, the hours, minutes, and seconds are loaded from TIME SOURCE once and are set in the internal clock. The internal year, month, and day are used.
	LTC ST309 (*1)	At power-on and when REFERENCE SOURCE or TIME SOURCE is changed, the year, month, and day, as well as the hours, minutes, and seconds, are loaded from TIME SOURCE and are set in the internal clock.
	NTP (*2)	
	GNSS (SER01)	
	PTP1 (SER03)	
PTP2 (SER03)		
GENLOCK FMT-AUTO GENLOCK FMT-MANUAL (*3)	INTERNAL	The internal clock is used. The internal clock is counted up in sync with REFERENCE SOURCE.
	LTC (*1)	At power-on and when REFERENCE SOURCE or TIME SOURCE is changed, the hours, minutes, and seconds are loaded from TIME SOURCE once and are set in the internal clock. The internal year, month, and day are used. The internal clock is counted up in sync with REFERENCE SOURCE. (*4)
	VITC (*1)	
	LTC ST309 (*1)	At power-on and when REFERENCE SOURCE or TIME SOURCE is changed, the year, month, and day, as well as the hours, minutes, and seconds, are loaded from TIME SOURCE and are set in the internal clock. The internal clock is counted up in sync with REFERENCE SOURCE. (*4)
	VITC ST309 (*1)	
	NTP (*2)	
	GNSS (SER01)	
	PTP1 (SER03)	
	PTP2 (SER03)	

REFERENCE SOURCE	TIME SOURCE	Time information
10MHz CW	INTERNAL	The internal clock is used. The internal clock is counted up in sync with REFERENCE SOURCE.
	LTC (*1)	At power-on and when REFERENCE SOURCE or TIME SOURCE is changed, the hours, minutes, and seconds are loaded from TIME SOURCE once and are set in the internal clock. The internal year, month, and day are used. The internal clock is counted up in sync with REFERENCE SOURCE. (*4)
	LTC ST309 (*1)	At power-on and when REFERENCE SOURCE or TIME SOURCE is changed, the year, month, and day, as well as the hours, minutes, and seconds, are loaded from TIME SOURCE and are set in the internal clock. The internal clock is counted up in sync with REFERENCE SOURCE. (*4)
	NTP (*2)	
	GNSS (SER01)	
	PTP1 (SER03)	
	PTP2 (SER03)	
GNSS (SER01)	GNSS	The time acquired from the satellite is used.
PTP1 (SER03)	PTP1	The time received by the PTP follower is used.
PTP2 (SER03)	PTP2	The time received by the PTP follower is used.
PTP1/2 (SER03)	PTP1/2	The time received by the PTP follower is used. The instrument automatically selects the time source, and you can check the selection result using "STATUS > INFORMATION > REF SRC". "LOCK" is displayed for the time source, and "PASSIVE" is displayed for the other signal.

- *1 The input and output frame counts do not match.
- *2 Available when both NETWORK SETUP and NTP SETUP are set to ENABLE in the SYSTEM CONFIG menu.
- *3 TIME SOURCE is fixed to INTERNAL when L-SYNC SETUP in the SYSTEM CONFIG menu is set to BACKUP.
- *4 If REFERENCE SOURCE differs from TIME SOURCE, the internal clock will shift from the TIME SOURCE time.

7.8 Loading the Date and Time

When REFERENCE SOURCE is locked and the time can be acquired from TIME SOURCE normally, load the time selected with TIME SOURCE, select OK by following the procedure below.

1 . T I M E R E A D J U S T
<input type="checkbox"/> O K <input checked="" type="checkbox"/> C A N C E L

Procedure

REFERENCE CONFIG > TIME READJUST

8 BLACK CONFIG MENU

The BLACK CONFIG menu is used to specify settings related to the black output.

To display the REFERENCE CONFIG menu, press CONFIG several times until the following menu appears.

```
0 . B L A C K   C O N F I G
▼ B L A C K 1
```

On the BLACK CONFIG menu, you can specify settings for BLACK1 to BLACK6 individually. The procedure below is for BLACK1, but the same procedure can also be applied to BLACK2 to BLACK6.

8.1 Selecting the Black Format

To select the black format, follow the procedure below. To select an item, use the ▲, ▼, ◀, and ▶ keys.

The black formats are expressed in terms of the total number of lines, not the number of effective lines. REF and R represent the field reference pulse, ID represents the field ID, and S represents setup.

```
2 . B L A C K 1   N T S C
▼ ▶ * N T S C   B B

2 . B L A C K 1   P A L
◆ ▶   P A L   B B

2 . B L A C K 1   C O M P O N E N T
◆ ▶   5 2 5 / 5 9 . 9 4 I

2 . B L A C K 1   1 1 2 5 : H D
◆ ▶   1 1 2 5 / 6 0 I

2 . B L A C K 1   7 5 0 : H D
▲ ▶   7 5 0 / 6 0 P
```

Procedure

BLACK CONFIG > BLACK1 > FORMAT

Parameters

NTSC:	NTSC BB / NTSC BB+REF / NTSC BB+ID / NTSC BB+REF+ID / NTSC BB+SETUP / NTSC BB+S+REF / NTSC BB+S+ID / NTSC BB+S+R+ID
PAL:	PAL BB / PAL BB+REF
COMPONENT:	525/59.94I / 525/59.94P / 625/50I / 625/50P
1125:HD:	1125/60I / 1125/59.94I / 1125/50I / 1125/30P / 1125/29.97P / 1125/25P / 1125/24P / 1125/23.98P / 1125/24PsF / 1125/23.98PsF / 1125/60P / 1125/59.94P / 1125/50P
750:HD:	750/60P / 750/59.94P / 750/50P / 750/30P / 750/29.97P / 750/25P / 750/24P / 750/23.98P

Initial value

NTSC BB (when FORMAT SETTING on the SYSTEM CONFIG menu is set to NTSC)

PAL BB (when FORMAT SETTING on the SYSTEM CONFIG menu is set to PAL)

8.2 Configuring Timing Data

Under TIMING on the BLACK1 menu, you can adjust the timing of the black output relative to the reference signal.

```
1 . B L A C K 1
◆ T I M I N G
```

8.2.1 Adjusting the Timing (Frame)

When the black format is set to NTSC or PAL, to adjust the timing of the black output relative to the reference signal at the frame level, follow the procedure below.

```
3 . B L A C K 1 T I M I N G F
  0 F R A M E
```

Procedure

BLACK CONFIG > BLACK1 > TIMING > FRAME

Parameters

±5 [FRAME] (when FORMAT is set to NTSC)

±2 [FRAME] (when FORMAT is set to PAL)

Initial value

0 [FRAME]

8.2.2 Adjusting the Timing (Line)

To adjust the timing of the black output relative to the reference signal at the line level, follow the procedure below.

The variable range varies depending on the black format.

```
3 . B L A C K 1 T I M I N G V
  0 L I N E
```

Procedure

BLACK CONFIG > BLACK1 > TIMING > VERTICAL

Parameters

±1124 [LINE]

Initial value

0 [LINE]

8.2.3 Adjusting the Timing (Dot)

To adjust the timing of the black output relative to the reference signal at the dot level, follow the procedure below. At the lower right of the screen, the value in dots converted to time is displayed.

The variable range varies depending on the black format.



Procedure

BLACK CONFIG > BLACK1 > TIMING > HORIZONTAL

Parameters

±4124 [DOT]

Initial value

0 [DOT]

8.3 Setting the Time Code

Under VITC SETTING on the BLACK1 menu, you can specify settings for the time code to insert into the black output.

This menu appears when the black format is set to NTSC or PAL.



8.3.1 Turning Time Code Insertion On and Off

To turn time code insertion on and off, follow the procedure below.

The time code selected with TIME SOURCE on the REFERENCE CONFIG menu is used.



Procedure

BLACK CONFIG > BLACK1 > VITC SETTING > VITC

Parameters

ON / OFF

Initial value

OFF

8.3.2 Setting Dropped Frames

To select the dropped frame setting, follow the procedure below.

This setting is valid when the frame frequency of the black output is set to 59.94 or 29.97.



Procedure

BLACK CONFIG > BLACK1 > VITC SETTING > DROP FRAME

Parameters

ON: Dropped frame time code is used.

OFF: Non-dropped frame time code is used.

Initial value

ON

8.3.3 Setting the Time Code Superimposition Line

To set the line number on which the time code will be superimposed, follow the procedure below.

Set the line number for field 1. The line number in field 2 is displayed in parentheses.

There are some lines that cannot be selected as shown below.

- When the black format is NTSC and REF is included: Line 10 cannot be selected
- When the black format is NTSC and ID is included: Line 15 cannot be selected
- When the black format is PAL BB+REF: Line 7 cannot be selected



Procedure

BLACK CONFIG > BLACK1 > VITC SETTING > LINE NUMBER

Parameters

10 - 20 [LINE] (when FORMAT is set to NTSC)

6 - 22 [LINE] (when FORMAT is set to PAL)

Initial value

14 (when FORMAT is set to NTSC)

19 (when FORMAT is set to PAL)

8.4 Setting the Black Output

Under OUTPUT SETTING on the BLACK1 menu, you can specify settings for the black output.

```
1 . B L A C K 1
^ O U T P U T   S E T T I N G           ↓
```

8.4.1 Turning the Black Output On and Off

To turn the black output on and off, follow the procedure below.

```
3 . B L A C K 1   O U T P U T
   ■ E N A B L E   □ D I S A B L E
```

Procedure

BLACK CONFIG > BLACK1 > OUTPUT SETTING > OUTPUT

Parameters

ENABLE / DISABLE

Initial value

ENABLE

8.4.2 Turning BMCA Linkage On and Off (SER03)

If you set ENABLE in the procedure below, the black output is stopped in linkage with BMCA of the selected PTP. Once the black output is stopped, this menu and the OUTPUT menu are both changed to DISABLE.

To enable the black output again, set the OUTPUT menu to ENABLE.

```
3 . B L A C K 1   L I N K E D   T O   P T P 1
   □ E N A B L E   ■ D I S A B L E
```

Procedure

BLACK CONFIG > BLACK1 > OUTPUT SETTING >
LINKED TO PTP1 BMCA / LINKED TO PTP2 BMCA

Parameters

ENABLE / DISABLE

Initial value

DISABLE

8.5 Settings Shared by Black Outputs

To specify the settings for BLACK2 to be the same as those for BLACK1, select ON by following the procedure below. In this case, you cannot specify the settings for BLACK2.

Similarly, you can also specify the settings for BLACK3 to BLACK6 to be the same as those for BLACK1.

2 . B L A C K 2 E Q U A L T O B L A C K 1
<input type="checkbox"/> O N <input checked="" type="checkbox"/> O F F

Procedure

BLACK CONFIG > BLACK2 > EQUAL TO BLACK1

Parameters

ON / OFF

Initial value

OFF

9 AUDIO CONFIG MENU

The AUDIO CONFIG menu is used to specify settings related to the AES/EBU output, silence output, and word-clock output.

To display the AUDIO CONFIG menu, press CONFIG several times until the following menu appears.

```
0 . A U D I O   C O N F I G   ◀▶
▼ A E S / E B U                ↓
```

9.1 Setting the AES/EBU Output

Under AES/EBU on the AUDIO CONFIG menu, you can specify settings for the AES/EBU output.

```
0 . A U D I O   C O N F I G   ◀▶
▼ A E S / E B U                ↓
```

9.1.1 Selecting the Frequency

To select the frequency of the selected channel, follow the procedure below.

```
4 . A E S / E B U   C H 1   F R E Q
◀ * 1 k H z
```

Procedure

AUDIO CONFIG > AES/EBU > SETTING > CH1 / CH2 > FREQ

Parameters

SILENCE / 400Hz / 800Hz / 1kHz

Initial value

1kHz

9.1.2 Setting the Level

To set the level of the selected channel, follow the procedure below.

```
4 . A E S / E B U   C H 1   L E V E L
                               - 2 0   [ d B F S ]
```

Procedure

AUDIO CONFIG > AES/EBU > SETTING > CH1 / CH2 > LEVEL

Parameters

-60 - 0 [dBFS]

Initial value

-20 [dBFS]

9.1.3 Setting Clicks

To insert click sounds into the selected channel at the specified interval, follow the procedure below.

This is invalid when LIPSYNC(SYNC TO SDI1) is set to ON and the SDI pattern is a lip sync one.

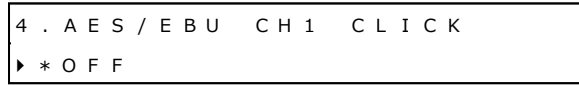

Procedure

AUDIO CONFIG > AES/EBU > SETTING > CH1 / CH2 > CLICK

Parameters

OFF / 1sec / 2sec / 4sec

Initial value

OFF

9.1.4 Settings Shared by Channels

To specify the settings for CH2 (frequency, level, and click sound) to be the same as those for CH1, select ON by following the procedure below. In this case, you cannot specify the settings for CH2.



Procedure

AUDIO CONFIG > AES/EBU > SETTING > CH2 > EQUAL TO CH1

Parameters

ON / OFF

Initial value

OFF

9.1.5 Selecting the Resolution

To select the resolution, follow the procedure below.



Procedure

AUDIO CONFIG > AES/EBU > SETTING > RESOLUTION

Parameters

20BIT / 24BIT

Initial value

20BIT

9.1.6 Selecting the Pre-emphasis Mode

To select the pre-emphasis mode, follow the procedure below.

```
3 . AES / EBU E M P H A S I S
    5 0 / 1 5    C C I T T    O F F
```

Procedure

AUDIO CONFIG > AES/EBU > SETTING > EMPHASIS

Parameters

50/15 / CCITT / OFF

Initial value

OFF

9.1.7 Turning Time Code Insertion On and Off

To turn time code insertion on and off, follow the procedure below.

The time code selected with TIME SOURCE on the REFERENCE CONFIG menu is used.

```
3 . AES / EBU T I M E C O D E
    O N            O F F
```

Procedure

AUDIO CONFIG > AES/EBU > SETTING > TIMECODE

Parameters

ON / OFF

Initial value

OFF

9.1.8 Adjusting the Timing

To adjust the timing of the AES/EBU output relative to the reference signal in the range of ± 1 AES/EBU frame, follow the procedure below.

```
2 . AES / EBU T I M I N G
                               0 [ F S ]
```

Procedure

AUDIO CONFIG > AES/EBU > TIMING

Parameters

± 511 [FS]

Initial value

0 [FS]

9.1.9 Turning Lip Sync Interlock On and Off (SER02/SER04)

When SDI1 LIP SYNC on the SDI CONFIG menu is set to ON, to output a sound interlocked with the lip sync pattern, select ON by following the procedure below.

[See also] "12.15 Turning Lip Sync On and Off"



Procedure

AUDIO CONFIG > AES/EBU > LIPSYNC(SYNC TO SDI1)

Parameters

ON / OFF

Initial value

OFF

9.2 Setting the Silence Output

Under SILENCE on the AUDIO CONFIG menu, you can specify settings for the silence output.



9.2.1 Settings Shared with the AES/EBU Output

To specify the settings for the silence output (resolution and timing) to be the same as those for the AES/EBU output, select ON by following the procedure below. In this case, you cannot specify the settings for the silence output.



Procedure

AUDIO CONFIG > SILENCE > EQUAL TO AES/EBU

Parameters

ON / OFF

Initial value

OFF

9.3 Setting the Word-clock Output

Under WCLK on the AUDIO CONFIG menu, you can specify settings for the word-clock output.

```
0 . A U D I O   C O N F I G   ◀▶
^ W C L K                       ↓
```

9.3.1 Adjusting the Timing

To adjust the timing of the word-clock output relative to the reference signal in the range of ± 1 AES/EBU frame, follow the procedure below.

```
2 . W C L K   T I M I N G
                                0 [ F S ]
```

Procedure

AUDIO CONFIG > WCLK > TIMING

Parameters

± 511 [FS]

Initial value

0 [FS]

10 LTC CONFIG MENU

The LTC CONFIG menu is used to specify settings related to LTC output.

To display the LTC CONFIG menu, press CONFIG several times until the following menu appears.

```

0 . L T C   C O N F I G   ◀▶
L T C   O U T P U T       ↓
  
```

On the LTC CONFIG menu, you can specify settings for LTC1 to LTC3 individually. The procedure below is for LTC1, but the same procedure can also be applied to LTC2 and LTC3.

10.1 Turning the LTC Output On and Off

To turn the LTC output on and off, follow the procedure below.

```

3 . L T C 1
   ◻ O N       ◼ O F F
  
```

Procedure

LTC CONFIG > LTC OUTPUT > LTC1 > ON/OFF

Parameters

ON / OFF

Initial value

OFF

10.2 Selecting the LTC Format

To select the LTC format, follow the procedure below.

```

3 . L T C 1   F O R M A T
▶ * 2 9 . 9 7   f p s
  
```

Procedure

LTC CONFIG > LTC OUTPUT > LTC1 > FORMAT

Parameters

30 / 29.97 / 25 / 24 / 23.98 fps

Initial value

29.97 fps (when FORMAT SETTING on the SYSTEM CONFIG menu is set to NTSC)
 25 fps (when FORMAT SETTING on the SYSTEM CONFIG menu is set to PAL)

10.3 Adjusting the Timing (Frame)

To adjust the timing of the LTC output relative to the reference signal at the frame level, follow the procedure below.

```
4 . L T C 1   T I M I N G   F R A M E
      0   F R A M E
```

Procedure

LTC CONFIG > LTC OUTPUT > LTC1 > TIMING > FRAME

Parameters

±29 [FRAME] (when the LTC format is set to 30 fps or 29.97 fps)

±24 [FRAME] (when the LTC format is set to 25 fps)

±23 [FRAME] (when the LTC format is set to 24 fps or 23.98 fps)

Initial value

0 [FRAME]

10.4 Adjusting the Timing (Bit)

To adjust the timing of the LTC output relative to the reference signal at the bit level, follow the procedure below. At the lower right of the screen, the value in bits converted to time is displayed.

```
4 . L T C 1   T I M I N G   B I T
      0   B I T       0 . 0 0 0 m s
```

Procedure

LTC CONFIG > LTC OUTPUT > LTC1 > TIMING > BIT

Parameters

±39 [BIT]

Initial value

0 [BIT]

10.5 Adjusting the Offset

To adjust the offset of the LTC output relative to the reference signal, follow the procedure below.

```
3 . L T C 1   O F F S E T
+ 0 0 : 0 0 : 0 0   [ H H : M M : S S ]
```

Procedure

LTC CONFIG > LTC OUTPUT > LTC1 > OFFSET

Parameters

±23:59:59

Initial value

+00:00:00

10.6 Setting Dropped Frames

To select the dropped frame setting, follow the procedure below.

This setting is valid when the frame frequency of the LTC output is set to 29.97.

3 . L T C 1 D R O P F R A M E
<input checked="" type="checkbox"/> O N <input type="checkbox"/> O F F

Procedure

LTC CONFIG > LTC OUTPUT > LTC1 > DROP FRAME

Parameters

ON: Dropped frame time code is used.

OFF: Non-dropped frame time code is used.

Initial value

ON

10.7 Settings Shared by LTC Outputs

To specify the settings for LTC2 to be the same as those for LTC1, select ON by following the procedure below. In this case, you cannot specify the settings for LTC2.

Similarly, you can also specify the settings for LTC3 to be the same as those for LTC1.

3 . L T C 2 E Q U A L T O L T C 1
<input type="checkbox"/> O N <input checked="" type="checkbox"/> O F F

Procedure

LTC CONFIG > LTC OUTPUT > LTC2 > EQUAL TO LTC1

Parameters

ON / OFF

Initial value

OFF

11 CW/1PPS CONFIG MENU

The CW/1PPS CONFIG menu is used to specify settings related to the 10MHz CW output and the 1PPS output.

To display the CW/1PPS CONFIG menu, press CONFIG several times until the following menu appears.

```

1 . C W / 1 P P S   O U T P U T
    ■ C W           □ 1 P P S
  
```

11.1 Switching the Output Signal

To select the signal to output from the CW/1PPS connector on the rear panel, follow the procedure below.

```

1 . C W / 1 P P S   O U T P U T
    ■ C W           □ 1 P P S
  
```

Procedure

CW/1PPS CONFIG > OUTPUT

Parameters

CW / 1PPS

Initial value

CW

12 SDI CONFIG MENU (SER02/SER04)

The SDI CONFIG menu is used to specify settings related to SDI output.

To display the SDI CONFIG menu, press CONFIG several times until the following menu appears.

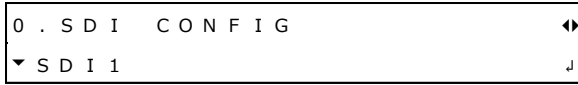

On the SDI CONFIG menu, you can specify settings for SDI1 to SDI4 individually. The procedure below is for SDI1, but the same procedure can also be applied to SDI2 to SDI4.

The SDI formats corresponding to the options added to the instrument are listed below.

Table 12-1 | SDI format

Option	2K				4K	
	SD	HD	3G-A	3G-B	3G-Quad Link	12G
SER02	●	●	●	●	-	-
SER02×2 + SER21	●	●	●	●	●	-
SER04 (SDI)	●	●	●	●	●	●
SER04 (IP)	ST2110	-	●	●	-	●
	ST2022-6	-	●	●	-	-

When One SER02 Unit is Added

You can specify settings for SDI1 and SDI2. You cannot specify settings for SDI3 or SDI4.

When Two SER02 Units are Added

You can specify settings for SDI1 to SDI4.

4K 3G-Quad Link can be supported by adding SER21. For the 4K 3G-Quad Link settings, there is only one output, and you cannot specify settings for SDI2 to SDI4.

When SER04 is Added

You can specify settings for SDI1 to SDI4.

For the 4K 3G-Quad Link settings, there is only one output, and you cannot specify settings for SDI2 to SDI4.

For IP outputs, the patterns specified on the SDI CONFIG menu are output as follows. Up to four streams can be output per port within the band. If the SDI format is set to an unsupported one (indicated by "-" in the table above), IP outputs are unstable.

- IP OUTPUT1/2 Stream1: Output the pattern specified with SDI1
- IP OUTPUT1/2 Stream2: Output the pattern specified with SDI2
- IP OUTPUT1/2 Stream3: Output the pattern specified with SDI3
- IP OUTPUT1/2 Stream4: Output the pattern specified with SDI4

12.1 Selecting the Frequency Group

To select the frequency group that can be selected with the frame frequency of the SDI output, follow the procedure below.

The settings specified here are shared among SDI1 to SDI4.

1 . S D I F R E Q U E N C Y G R O U P
<input checked="" type="checkbox"/> 5 9 . 9 4 H z <input type="checkbox"/> 6 0 / 5 0 H z

Procedure

SDI CONFIG > SDI FREQUENCY GROUP

Parameters

59.94Hz:	Select the frame frequency from 59.94, 29.97, and 23.98.
60/50Hz:	Select the frame frequency from 60, 50, 30, 25, and 24.

Initial value

59.94Hz (when FORMAT SETTING on the SYSTEM CONFIG menu is set to NTSC)
 60/50Hz (when FORMAT SETTING on the SYSTEM CONFIG menu is set to PAL)

- * When SDI FREQUENCY GROUP is set to 59.94Hz, you cannot select "720x 487 SD (59.94I)". When it is set to 60/50Hz, you can select it.
- * When SDI format is 4K (SER04/SER21), all frequencies can be selected, regardless of the setting you make here.

12.2 Setting the SDI Format

Under FORMAT on the SDI1 menu, you can specify settings for the SDI output format. For the available combinations of "SYSTEM", "STRUCTURE", "RATE", see "3.3.3 LT4670-SER02/SER04/SER21 (SDI)".

```
1 . S D I 1
◆ F O R M A T
```

12.2.1 Selecting the System

To select the system of the SDI output, follow the procedure below. To select an item, use the ▲, ▼, ◀, and ▶ key.

Changing this setting also changes the STRUCTURE And RATE settings.

```
3 . S D I 1   S Y S T E M   1 2 G
▼▶ 3 8 4 0 x 2 1 6 0   1 2 G

3 . S D I 1   S Y S T E M   4 K ( Q L ) 2 S I
▼▶ 3 8 4 0 x 2 1 6 0   3 G - A

3 . S D I 1   S Y S T E M   3 G
◆▶ 1 2 8 0 x   7 2 0   3 G - A

3 . S D I 1   S Y S T E M   H D
◆◀ * 1 9 2 0 x 1 0 8 0   H D

3 . S D I 1   S Y S T E M   S D
▲▶   7 2 0 x   4 8 7   S D
```

Procedure

SDI CONFIG > SDI1 > FORMAT > SYSTEM

Parameters

12G	3840x2160 12G / 4096x2160 12G (SER04) SER02 and ST2022-6 of IP outputs are not supported.
4K(QL)2SI:	3840x2160 3G-A / 4096x2160 3G-A / 3840x2160 3G-B-DL / 4096x2160 3G-B-DL (SER21) You cannot select this for SDI2 to SDI4. IP outputs are not supported.
3G:	1280x 720 3G-A / 1920x1080 3G-A / 1920x1080 3G-B-DL 3G-B does not support IP outputs.
HD:	1280x 720 HD / 1920x1080 HD
SD:	720x 487 SD / 720x 576 SD You cannot select this when SDI FREQUENCY GROUP is set to 59.94Hz. IP outputs are not supported.

Initial value

1920x1080 HD

12.2.2 Selecting the Color System

To select the color system and the quantization accuracy of the SDI output, follow the procedure below.

Changing this setting also changes the RATE settings.

```
3 . S D I 1   S T R U C T U R E
▶ * 4 2 2 ( Y C b C r ) 1 0 - b i t
```

Procedure

SDI CONFIG > SDI1 > FORMAT > STRUCTURE

Parameters

422(YCbCr)10-bit / 422(YCbCr)12-bit / 444(RGB)10-bit / 444(RGB)12-bit

Initial value

422(YCbCr)10-bit

12.2.3 Selecting the Frame Frequency

To select the frame (field) frequency of the SDI output, follow the procedure below.

The selectable frequencies depend on SDI FREQUENCY GROUP.

```
3 . S D I 1   R A T E
◀ * 5 9 . 9 4 I
```

Procedure

SDI CONFIG > SDI1 > FORMAT > RATE

Parameters

59.94P / 29.97P / 23.98P / 29.97PsF / 23.98PsF / 59.94I

(when SDI FREQUENCY GROUP is set to 59.94Hz)

60P / 50P / 30P / 25P / 24P / 30PsF / 25PsF / 24PsF / 60I / 50I

(when SDI FREQUENCY GROUP is set to 60/50Hz)

48P / 47.95P

Initial value

59.94I (when FORMAT SETTING on the SYSTEM CONFIG menu is set to NTSC)

50I (when FORMAT SETTING on the SYSTEM CONFIG menu is set to PAL)

- * When SDI FREQUENCY GROUP is set to 59.94Hz, you cannot select "720x 487 SD (59.94I)". When it is set to 60/50Hz, you can select it.
- * When SDI format is 4K (SER04/SER21), all frequencies can be selected, regardless of the setting for SDI FREQUENCY GROUP.

12.3 Configuring Timing Data

Under TIMING on the SDI1 menu, you can adjust the timing of the SDI output relative to the reference signal.

```
1 . S D I 1
  ◆ T I M I N G
```

12.3.1 Selecting the Timing Reference

When the SDI format is set to SD or HD, to select the output timing used as a reference for the SDI and black outputs, follow the procedure below.

When the SDI format is set to 3G or 12G, this is fixed to SERIAL.

```
3 . S D I 1 0 H T I M I N G
  ■ S E R I A L   □ L E G A C Y
```

Procedure

SDI CONFIG > SDI1 > TIMING > 0H TIMING

Parameters

SERIAL:	Signals are output at the timing defined in the signal standard.
LEGACY:	Signals are output at the same timing as LEADER's conventional signal generators.

Initial value

SERIAL

12.3.2 Adjusting the Timing (Line)

To adjust the timing of the SDI output relative to the reference signal at the line level, follow the procedure below.

The variable range varies depending on the SDI format.

This is invalid when the SDI format is 4K 3G-Quad Link (SER04/SER21).

```
3 . S D I 1 T I M I N G V
  0 L I N E
```

Procedure

SDI CONFIG > SDI1 > TIMING > VERTICAL

Parameters

±1124 [LINE]

Initial value

0 [LINE]

12.3.3 Adjusting the Timing (Dot)

To adjust the timing of the SDI output relative to the reference signal at the dot level, follow the procedure below. At the lower right of the screen, the value in dots converted to time is displayed.

The variable range varies depending on the SDI format.

This is invalid when the SDI format is 4K 3G-Quad Link (SER04/SER21).



Procedure

SDI CONFIG > SDI1 > TIMING > HORIZONTAL

Parameters

±4124 [DOT]

Initial value

0 [DOT]

12.4 Configuring Fixed Patterns

There are two types of SDI output patterns: internal fixed patterns within the instrument and user patterns, which display images that the user prepares. This section describes fixed patterns.

To select the fixed patterns, follow the procedure below. To select an item, use the ▲, ▼, ◀, and ▶ key.

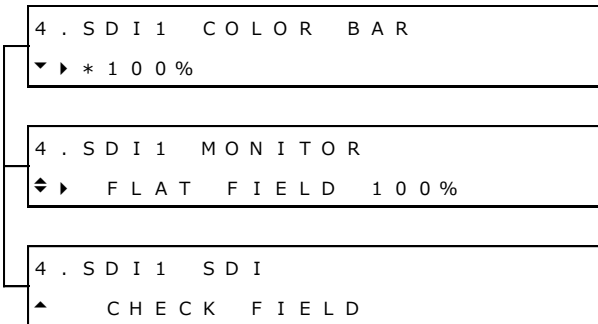

Procedure

SDI CONFIG > SDI1 > PATTERN > PATTERN SELECT > FIX PATTERN

Parameters

COLOR BAR:	100% / 75% / MULTI 100% / MULTI 75% / MULTI (+I) / SMPTE / EBU / BBC
MONITOR:	FLAT FIELD 100% / FLAT FIELD 50% / FLAT FIELD 0% / RED FIELD 100% / GREEN FIELD 100% / BLUE FIELD 100%
SDI:	CHECK FIELD

Initial value

100%

The selectable patterns depend on the SDI format as shown below.

(○: Selectable, ×: Not selectable)

Table 12-2 | FIX PATTERN

Pattern		SDI Format		
		Other Than Those on the Right	720x487 SD	720x576 SD
COLOR BAR	100%	○	○	○
	75%	○	○	×
	MULTI 100%	○	×	×
	MULTI 75%	○	×	×
	MULTI (+I)	○	×	×
	SMPTE	×	○	×
	EBU	×	×	○
	BBC	×	×	○
MONITOR	-	○	○	○
SDI	-	○	○	○

100%

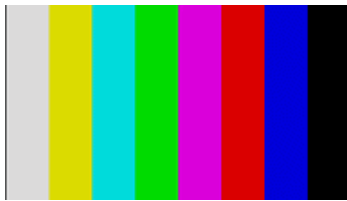

75%

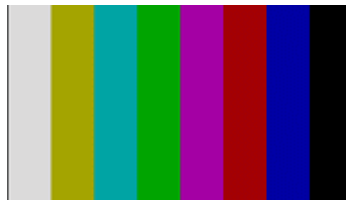

MULTI 100%



MULTI 75%



MULTI (+I)



SMPTE



EBU

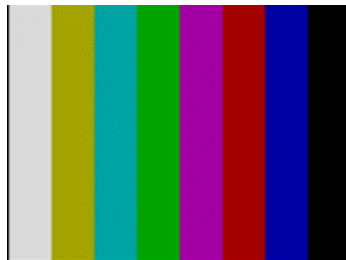

BBC



12 SDI CONFIG MENU (SER02/SER04)

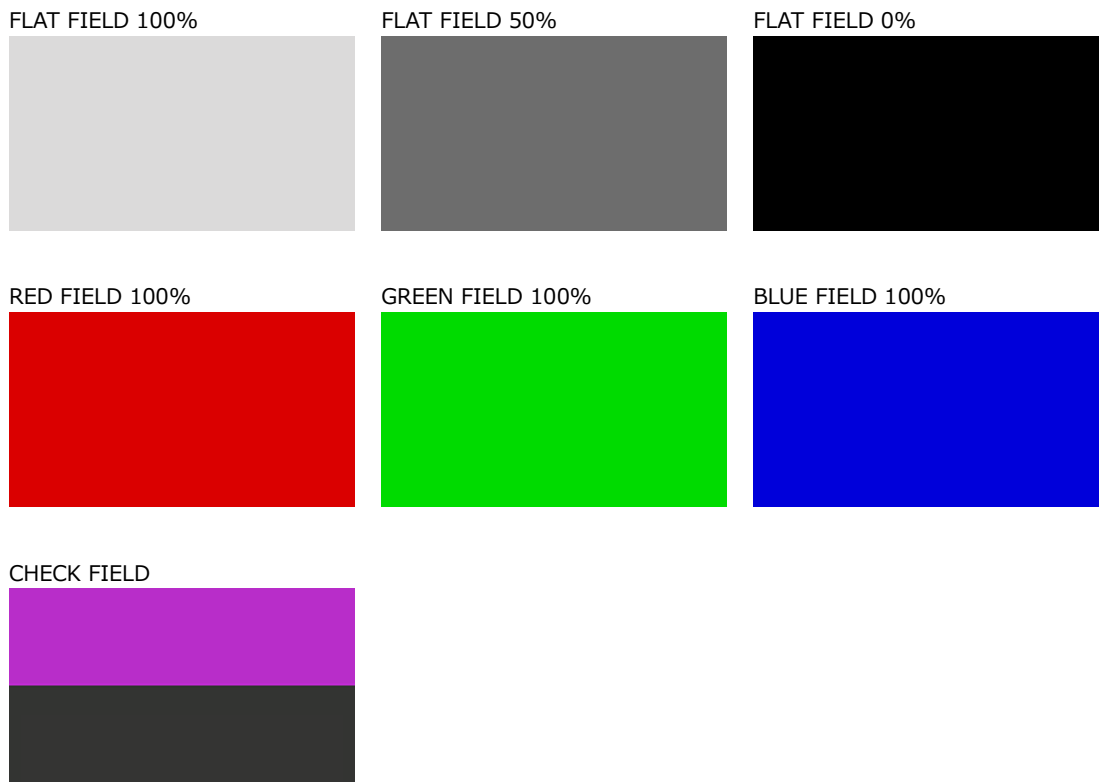

Figure 12-1 | Selecting the pattern

12.5 Configuring User Patterns

There are two types of SDI output patterns: internal fixed patterns within the instrument and user patterns, which display images that the user prepares. This section describes user patterns.

12.5.1 Displaying a User Pattern

Here is an overview of the procedure from preparing a user pattern to displaying it.

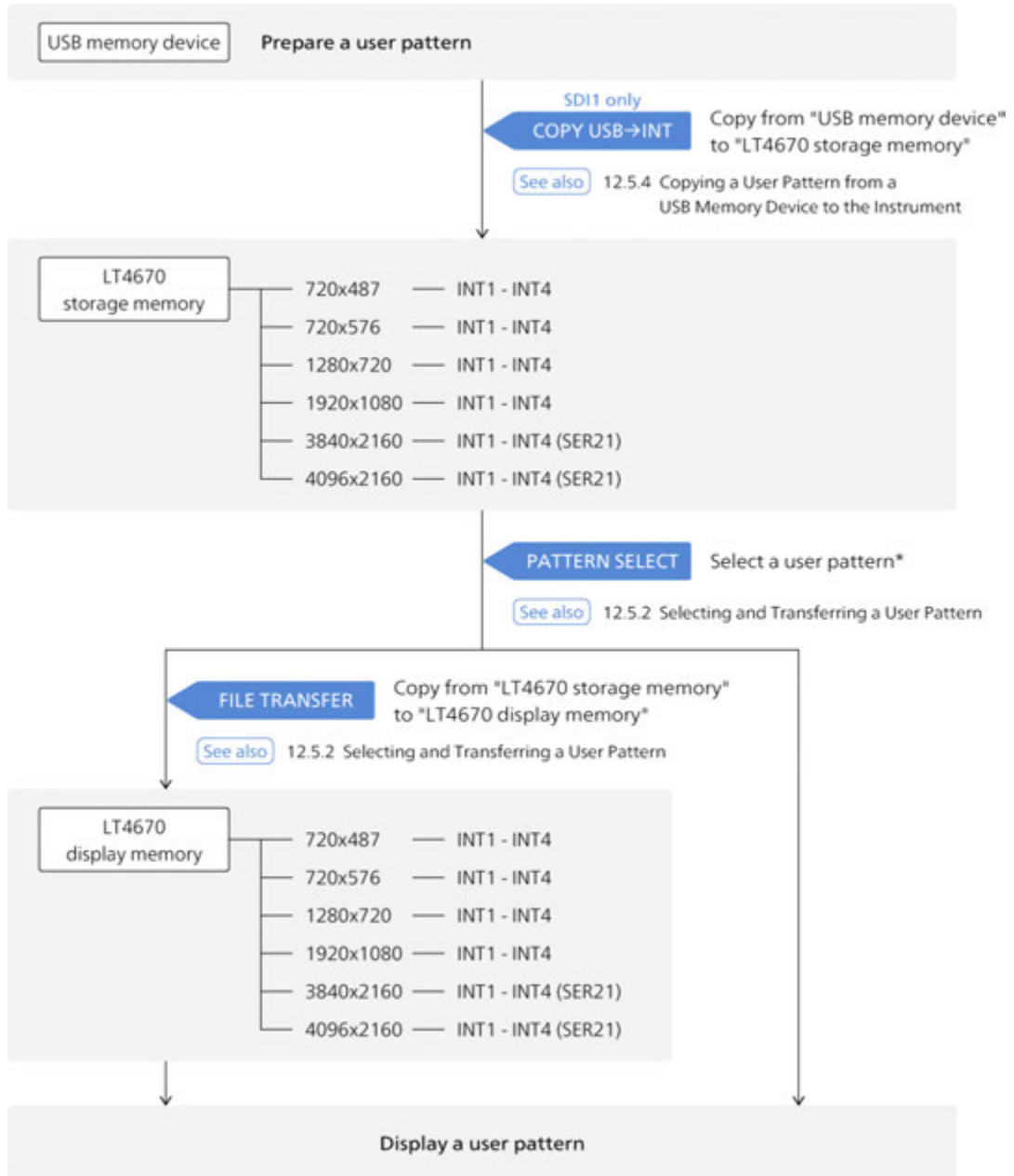

Figure 12-2 | Displaying a user pattern

* If the selected user pattern has been transferred, you can display the user pattern at the time you select it. If it has not been transferred, you can display it after transferring it to the LT4670 display memory. Once transferred, it will remain effective until you turn off the power.

The detailed procedure from preparing a user pattern to displaying it are as follows:

1. Prepare a user pattern.

Prepare an image in bitmap format or TIFF format according to the following conditions.

Select one of the image sizes according to the output SDI format.

Here, as an example, a user pattern is prepared with the file name "leader.bmp" and an image size of "1920x1080".

File name: Up to 64 alphanumeric characters or underscore
 File format: 24-bit bitmap format (.bmp)
 24/48-bit TIFF format (.tif)
 Image size: 720x487 (SD)
 720x576 (SD)
 1280x720 (HD, 3G)
 1920x1080 (HD, 3G)
 3840x2160 (4K)
 4096x2160 (4K)

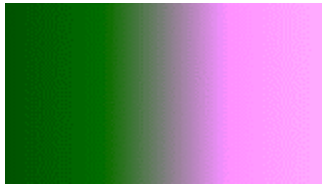

- * The extension ".tiff" is not supported.
- * Compressed TIFF is not supported.

2. Save the user pattern to a USB memory device.

Set up the folder structure on the USB memory device as follows and save the user pattern to the 1920_1080 folder.

- USB memory device
 - └─ ■ LT4670_USER
 - └─ ■ USER_PATTERN
 - └─ ■ 1920_1080
 - └─ ■ leader.bmp

3. Connect the USB memory device to the instrument.

4. Using the COPY USB→INT menu, copy the user pattern from the USB memory device to the LT4670 storage memory.

For each image size, you can copy up to four user patterns (INT1 to INT4) to the instrument. The user pattern copies will be common to SDI1 to SDI4.

Here, as an example, "leader.bmp" is copied from a USB memory device to "INT1" on the instrument.

This menu appears only for SDI1 when a USB memory device is connected and contains an image size folder (folder with a name from an image size).

From "SDI CONFIG > SDI1 > PATTERN > COPY USB→INT", select an image size.

```
3 . S D I 1   C O P Y   U S B → I N T
◀ 1 9 2 0 x 1 0 8 0 ▶
```

Select the copy source in the USB memory device.

```
4 . C O P Y   U S B → I N T
▶ l e a d e r . b m p           1 / 1
```

Select a copy destination from INT1 to INT4. If there are already user patterns stored in the instrument, they will be overwritten.

```
5 . C O P Y   U S B → I N T
▶   I N T 1           N O   D A T A
```

Select the colorimetry.

```
6 . C O L O R I M E T R Y
 6 0 1    7 0 9    2 0 2 0
```

Select the range.

```
7 . R A N G E
 N A R R O W    F U L L
```

Select the HDR standard. When you select the HDR standard, the user pattern is copied to the LT4670 storage memory.

```
8 . H D R
 S D R    H L G    P Q    U n s p c
```

[See also] "12.5.4 Copying a User Pattern from a USB Memory Device to the Instrument"

5. On the PATTERN SELECT menu, select the user pattern.

From "SDI CONFIG > SDI1 > PATTERN > PATTERN SELECT > USER PATTERN", select INT1.

Here, user patterns appear according to the current image size. If user patterns do not appear, select 1920x1080 from "SDI CONFIG > SDI1 > FORMAT > SYSTEM".

If the selected user pattern has been transferred, the user pattern appears at this time, but to make it appear for the first time after you turn on the power, the transfer described later is necessary.

```
4 . U S E R   P A T   1   7 0 9   N R   S D R
▶ * I N T 1                   l e a d e r . b m p
```

[See also] "12.5.2 Selecting and Transferring a User Pattern"

6. On the FILE TRANSFER menu, transfer the user pattern from the LT4670 storage memory to the LT4670 display memory.

Press the ENTER key with the * symbol attached in step 5, and "FILE TRANSFER" will appear.

Select OK.

```
5 . F I L E   T R A N S F E R
   ■ O K           □ C A N C E L
```

When you select OK, the user pattern is transferred to the LT4670 display memory. Wait until it is completed.

```
F I L E   T R A N S F E R
P L E A S E   W A I T .
```

Set POWER ON LOAD. When you select either option, the user pattern appears.

If you select YES, the pattern will be transferred to the LT4670 display memory when you restart the instrument. This eliminates the need to transfer the user pattern each time you turn the instrument on and off, but may take extra time when you turn on the power.

If you select NO, the user pattern will not be transferred to the LT4670 display memory when you restart the instrument. This does not take extra time when you turn on the power, but requires you to transfer the user pattern each time you turn the instrument on and off.

```
6 . P O W E R   O N   L O A D
   □ Y E S           ■ N O
```

[See also] "12.5.2 Selecting and Transferring a User Pattern"

12.5.2 Selecting and Transferring a User Pattern

To display a user pattern, the user pattern, stored on the LT4670 storage memory, must be transferred to the LT4670 display memory.

To select and transfer a user pattern, follow the procedure below.

The user pattern must be copied to INT1 to INT4 in advance using the COPY USB→INT menu.

Procedure

SDI CONFIG > SDI1 > PATTERN > PATTERN SELECT > USER PATTERN

Parameters

INT1 - INT4

Initial value

INT1

To select and transfer a user pattern, follow the procedure below.

1. Select a user pattern.

Select from INT1 to INT4. Here, user patterns appear according to the current image size. The colorimetry, range, and HDR standard appear in the upper right of the menu.

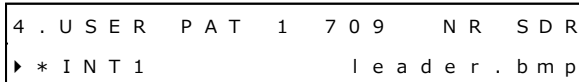

If the selected user pattern has been transferred, the user pattern appears at this time. Once transferred, the user pattern will remain effective until you turn off the power, but must be re-transferred when you restart the instrument. Note, however, that if you set "POWER ON LOAD" to YES when transferring it, you need not re-transfer it even after you restart the instrument.

If the selected user pattern has not been transferred, nothing appears at this time. Go to step 2.

2. Press the ENTER key.

Press the ENTER key with the * symbol attached in step 1, and "FILE TRANSFER" will appear.



3. Select OK.

When you select OK, the user pattern is transferred to the LT4670 display memory. Wait until it is completed.



4. Set POWER ON LOAD.

When you select either option, the user pattern appears.

If you select YES, the pattern will be transferred to the LT4670 display memory when you restart the instrument. This eliminates the need to transfer the user pattern each time you turn the instrument on and off, but may take extra time when you turn on the power.

If you select NO, the user pattern will not be transferred to the LT4670 display memory when you restart the instrument. This does not take extra time when you turn on the power, but requires you to transfer the user pattern each time you turn the instrument on and off.

```

6 . P O W E R   O N   L O A D
       Y E S            N O
  
```

12.5.3 Clearing a User Pattern

To clear a user pattern saved in the instrument, follow the procedure below.

This menu appears only for SDI1.

Procedure

SDI CONFIG > SDI1 > PATTERN > DELETE

To clear a user pattern, follow the procedure below.

1. Select the image size of the user pattern you want to clear.

Select from 720x487, 720x576, 1280x720, 1920x1080, 3840x2160, and 4096x2160.

```

3 . D E L E T E   P A T T E R N
  ◀ 1 9 2 0 x 1 0 8 0 ▶
  
```

2. Select the user pattern you want to clear.

Select from INT1 to INT4.

```

4 . D E L E T E   P A T T E R N
  ▶ I N T 1       l e a d e r . b m p
  
```

3. Select OK.

If you clear the currently displayed user pattern, the user pattern will continue to appear even after you select OK. By switching the output pattern, you can no longer display it again.

```

5 . D E L E T E   P A T T E R N
       O K            C A N C E L
  
```

12.5.4 Copying a User Pattern from a USB Memory Device to the Instrument

To copy up to four user patterns, for each image size, from a USB memory device to the LT4670 storage memory, follow the procedure below. The user pattern copies will be common to SDI1 to SDI4. (Copy the user pattern to the USB memory device in advance using the COPY INT→USB menu or create and place the user pattern.)

This menu appears only for SDI1 when a USB memory device is connected and contains an image size folder.

Procedure

SDI CONFIG > SDI1 > PATTERN > COPY USB→INT

To copy a user pattern, follow the procedure below.

1. Select the image size of the user pattern you want to copy.

Select from 720x487, 720x576, 1280x720, 1920x1080, 3840x2160, and 4096x2160.

```
3 . S D I 1   C O P Y   U S B → I N T
♦ 1 9 2 0 x 1 0 8 0                                     ↓
```

2. Select the copy source in the USB memory device.

The bmp or tif files in the image size folder of the USB memory device are displayed here.

```
4 . C O P Y   U S B → I N T
▶ l e a d e r . b m p                                     1 / 1
```

3. Select the copy destination in the instrument.

Select from INT1 to INT4. If there are already user patterns stored in the instrument, they will be overwritten.

```
5 . C O P Y   U S B → I N T
▶   I N T 1           N O   D A T A
```

4. Select the colorimetry.

```
6 . C O L O R I M E T R Y
 6 0 1    7 0 9    2 0 2 0
```

5. Select the range.

```
7 . R A N G E
 N A R R O W    F U L L
```

6. Select the HDR standard.

Unspc represents undefined.

When you select the HDR standard, the user pattern is copied to the LT4670 storage memory.



● **USB Memory Device Structure**

User patterns are copied from the image size folder of the USB memory device.

To prepare a user pattern, set the image size as follows:

■ USB memory device

└─ ■ LT4670_USER

└─ ■ USER_PATTERN

└─ ■ 720_487

| └─ ■ *.tif 720×487 tif file

| └─ ■ *.bmp 720×487 bmp file

└─ ■ 720_576

| └─ ■ *.tif 720×576 tif file

| └─ ■ *.bmp 720×576 bmp file

└─ ■ 1280_720

| └─ ■ *.tif 1280×720 tif file

| └─ ■ *.bmp 1280×720 bmp file

└─ ■ 1920_1080

| └─ ■ *.tif 1920×1080 tif file

| └─ ■ *.bmp 1920×1080 bmp file

└─ ■ 3840_2160

| └─ ■ *.tif 3840×2160 tif file (SER21)

| └─ ■ *.bmp 3840×2160 bmp file (SER21)

└─ ■ 4096_2160

| └─ ■ *.tif 4096×2160 tif file (SER21)

| └─ ■ *.bmp 4096×2160 bmp file (SER21)

12.5.5 Copying a User Pattern from the Instrument to a USB Memory Device

To copy a user pattern from the LT4670 storage memory to a USB memory device, follow the procedure below. (Copy the user pattern to the instrument in advance using the COPY USB→INT menu.)

This menu appears only for SDI1 when a USB memory device is connected.

Procedure

SDI CONFIG > SDI1 > PATTERN > COPY INT→USB

To copy a user pattern, follow the procedure below.

1. Select the image size of the user pattern you want to copy.

Select from 720x487, 720x576, 1280x720, 1920x1080, 3840x2160, and 4096x2160.

```

3 . S D I 1   C O P Y   I N T → U S B
◆ 1 9 2 0 x 1 0 8 0

```

2. Select the copy source in the instrument.

Select from INT1 to INT4.

```

4 . C O P Y   I N T → U S B
▶ I N T 1       l e a d e r . b m p

```

3. Select OK.

If there are already user patterns with the same file names stored in the USB memory device, they will be overwritten.

```

5 . C O P Y   I N T → U S B
  ■ O K           □ C A N C E L

```

- **USB Memory Device Structure**

User patterns are copied to the image size folder of the USB memory device.

- USB memory device

- └─ ■ LT4670_USER

- └─ └─ ■ USER_PATTERN

- └─ └─ └─ ■ 720_487

- └─ └─ └─ └─ ■ ****.tif 720×487 tif file

- └─ └─ └─ └─ └─ ■ ****.bmp 720×487 bmp file

- └─ └─ └─ ■ 720_576

- └─ └─ └─ └─ ■ ****.tif 720×576 tif file

- └─ └─ └─ └─ └─ ■ ****.bmp 720×576 bmp file

- └─ └─ └─ ■ 1280_720

- └─ └─ └─ └─ ■ ****.tif 1280×720 tif file

- └─ └─ └─ └─ └─ ■ ****.bmp 1280×720 bmp file

- └─ └─ └─ ■ 1920_1080

- └─ └─ └─ └─ ■ ****.tif 1920×1080 tif file

- └─ └─ └─ └─ └─ ■ ****.bmp 1920×1080 bmp file

- └─ └─ └─ ■ 3840_2160

- └─ └─ └─ └─ ■ ****.tif 3840×2160 tif file (SER21)

- └─ └─ └─ └─ └─ ■ ****.bmp 3840×2160 bmp file (SER21)

- └─ └─ └─ ■ 4096_2160

- └─ └─ └─ └─ ■ ****.tif 4096×2160 tif file (SER21)

- └─ └─ └─ └─ └─ ■ ****.bmp 4096×2160 bmp file (SER21)

12.6 Turning YCbCr/GBR On and Off

To turn individual components in a YCbCr or GBR signal on and off, follow the procedure below. This is invalid when the pattern is check field.

3 . S D I 1 C O M P O N E N T
<input checked="" type="checkbox"/> Y / G <input checked="" type="checkbox"/> C b / B <input checked="" type="checkbox"/> C r / R

Procedure

SDI CONFIG > SDI1 > VIDEO > COMPONENT

Parameters

ON / OFF

Initial value

ON

12.7 Turning Safety Area Markers On and Off

To turn each safety area marker on and off, follow the procedure below.

If the 4:3 marker is off, the 90% marker and 80% marker are displayed at the outer frame of the picture. If it is on, the 4:3 marker is assumed to be 100%.

When the SDI format is set to SD, the 4:3 marker cannot be set. Moreover, this is invalid when the pattern is check field.

3 . S D I 1 S A F E T Y A R E A
<input type="checkbox"/> 9 0 % <input type="checkbox"/> 8 0 % <input type="checkbox"/> 4 : 3

Procedure

SDI CONFIG > SDI1 > VIDEO > SAFETY AREA

Parameters

ON / OFF

Initial value

OFF

90%, 80% = ON

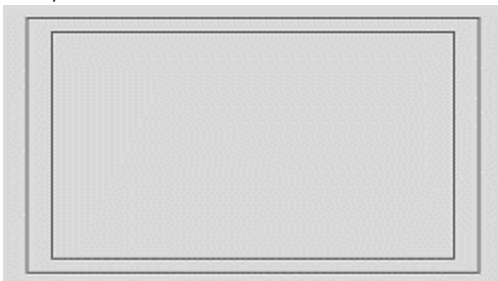

90%, 80%, 4:3 = ON

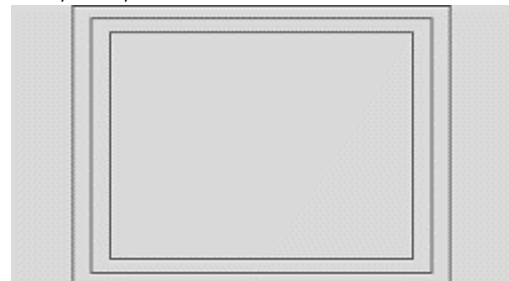

Figure 12-3 | Turning safety area markers on and off

12.8 Configuring the Pattern Scroll Feature

Under SCROLL on the VIDEO menu, you can configure the pattern scroll feature. This is invalid when the pattern is check field.

```
2 . S D I 1  V I D E O
  ◆ S C R O L L
```

12.8.1 Turning Scrolling On and Off

To turn scrolling on and off, follow the procedure shown below.

```
4 . S D I 1  S C R O L L
  □ O N      ■ O F F
```

Procedure

SDI CONFIG > SDI1 > VIDEO > SCROLL > ON/OFF

Parameters

ON / OFF

Initial value

OFF

12.8.2 Setting the Scroll Speed (Vertical)

To set the vertical scroll speed and direction, follow the procedure below.

The unit is line/field (frame). Setting a positive value scrolls upward and a negative value downward. When the SDI format is set to 4K (SER04/SER21), set them in 2-line steps.

```
4 . S D I 1  S C R O L L  V - S P E E D
                        0 [ L I N E ]
```

Procedure

SDI CONFIG > SDI1 > VIDEO > SCROLL > V-SPEED

Parameters

±256 [LINE]

Initial value

0 [LINE]

12.8.3 Setting the Scroll Speed (Horizontal)

To set the horizontal scroll speed and direction, follow the procedure below.

The unit is dot/field (frame). Setting a positive value scrolls from left to right and a negative value from right to left. Usually, set them in 2-dot steps. When the SDI format is set to 4K (SER04/SER21), set them in 4-dot steps.

```
4 . S D I 1   S C R O L L   H - S P E E D
                0   [ D O T ]
```

Procedure

SDI CONFIG > SDI1 > VIDEO > SCROLL > H-SPEED

Parameters

±256 [DOT]

Initial value

0 [DOT]

12.9 Setting the Pattern Change

Under PATTERN CHANGE on the VIDEO menu, you can set the pattern change.

This is invalid when the pattern is check field. This menu does not appear when a user pattern is selected.

```
2 . S D I 1   V I D E O
  ◆ P A T T E R N   C H A N G E   J
```

12.9.1 Turning Pattern Change On and Off

To turn pattern change on and off, follow the procedure shown below.

If set to ON, the pattern is switched automatically between the available color bar patterns for the current format.

```
4 . S D I 1   P A T T E R N   C H A N G E
  □ O N           ■ O F F
```

Procedure

SDI CONFIG > SDI1 > VIDEO > PATTERN CHANGE > ON/OFF

Parameters

ON / OFF

Initial value

OFF

12.9.2 Setting the Change Interval

To select the pattern change interval, follow the procedure below.

```
4 . S D I 1   P A T T E R N   C H G   S P E E D
                + 1   [ S E C ]
```

Procedure

SDI CONFIG > SDI1 > VIDEO > PATTERN CHANGE > SPEED

Parameters

+1 - +255 [SEC]

Initial value

+1 [SEC]

12.10 Setting ID Characters

Under ID CHARACTER on the VIDEO menu, you can set ID characters.

A character string that you created on the instrument can be displayed in a pattern.

This is invalid when the pattern is check field.

```
2 . S D I 1   V I D E O
  ◆ I D   C H A R A C T E R   ↓
```

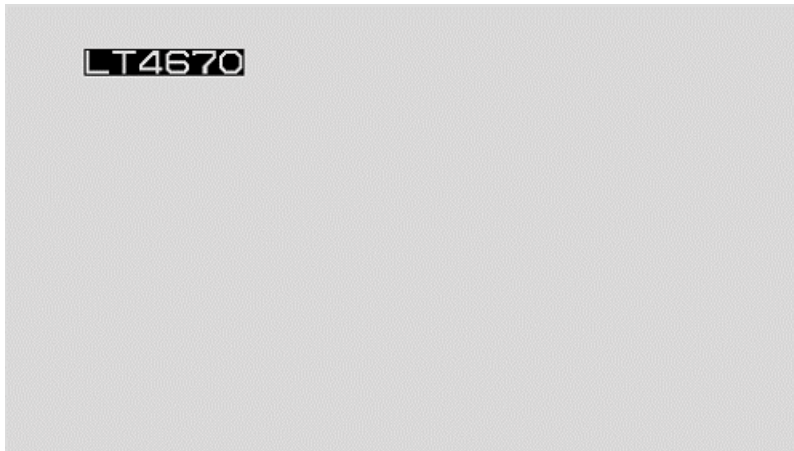

Figure 12-4 | Setting ID characters

12.10.1 Turning ID Characters On and Off

To turn ID characters on and off, follow the procedure below.

```
4 . S D I 1 I D C H A R A C T E R
   □ O N           ■ O F F
```

Procedure

SDI CONFIG > SDI1 > VIDEO > ID CHARACTER > ON/OFF

Parameters

ON / OFF

Initial value

OFF

12.10.2 Recalling ID Characters

To recall and display ID characters that have been saved in the instrument using the STORE menu, follow the procedure below.

```
4 . S D I 1 I D R E C A L L
▶ N O D A T A I N T 1
```

Procedure

SDI CONFIG > SDI1 > VIDEO > ID CHARACTER > RECALL

Parameters

INT1 - INT4

12.10.3 Creating ID Characters

To create ID characters, follow the procedure below. You can enter up to 20 characters.

The ID character background is displayed in black for 20 characters worth. If you enter ◀ at the end of the ID character string, only the background of the entered characters will be displayed. (◀ is not displayed.)

If you enter ◀ in the middle of the ID character string, characters after this character will disappear, and you will not be able to edit them.

```
4 . S D I 1 I D S E T
L T 4 6 7 0 ◀
```

Procedure

SDI CONFIG > SDI1 > VIDEO > ID CHARACTER > SET

Parameters

◀ ! " # \$ % & ' () * + , - . / 0 1 2 3 4 5 6 7 8 9 : ; < = > ? @
A B C D E F G H I J K L M N O P Q R S T U V W X Y Z [¥] ^ _ → ←

Initial value

LT4670◀



Figure 12-5 | Creating ID characters

12.10.4 Setting the Position of ID Characters (Vertical)

To set the vertical position of ID characters, follow the procedure below.

The value represents the position of the top of the ID characters. The top of the pattern is 0%.

4 . S D I 1 I D V - P O S I
0 [%]

Procedure

SDI CONFIG > SDI1 > VIDEO > ID CHARACTER > V-POSI

Parameters

0 - 100 [%]

Initial value

0 [%]

12.10.5 Setting the Position of ID Characters (Horizontal)

To set the horizontal position of ID characters, follow the procedure below.

The value represents the position of the left end of the ID characters. The left end of the pattern is 0%.

4 . S D I 1 I D H - P O S I
0 [%]

Procedure

SDI CONFIG > SDI1 > VIDEO > ID CHARACTER > H-POSI

Parameters

0 - 100 [%]

Initial value

0 [%]

12.10.6 Selecting the Size of ID Characters

To set the size of ID characters, follow the procedure below.
The size of x1 is 32×32 dot/character.

4 . S D I 1 I D S I Z E
<input checked="" type="checkbox"/> x 1 <input type="checkbox"/> x 2 <input type="checkbox"/> x 4 <input type="checkbox"/> x 8

Procedure

SDI CONFIG > SDI1 > VIDEO > ID CHARACTER > SIZE

Parameters

x1 / x2 / x4 / x8

Initial value

x1

12.10.7 Selecting the Level of ID Characters

To set the intensity level of ID characters, follow the procedure below.

4 . S D I 1 I D L E V E L
<input checked="" type="checkbox"/> 1 0 0 % <input type="checkbox"/> 7 5 %

Procedure

SDI CONFIG > SDI1 > VIDEO > ID CHARACTER > LEVEL

Parameters

100% / 75%

Initial value

100%

12.10.8 Turning ID Character Blinking On and Off

To turn ID character blinking on and off, follow the procedure below.

5 . S D I 1 I D B L I N K
<input type="checkbox"/> O N <input checked="" type="checkbox"/> O F F

Procedure

SDI CONFIG > SDI1 > VIDEO > ID CHARACTER > BLINK > ON/OFF

Parameters

ON / OFF

Initial value

OFF

12.10.9 Setting the ID Character On-Time

To set the on-time of ID character blinking, follow the procedure below.

```
5 . S D I 1   I D   B L I N K   O N   T I M E
                        1   [ S E C ]
```

Procedure

SDI CONFIG > SDI1 > VIDEO > ID CHARACTER > BLINK > ON TIME

Parameters

1 - 9 [SEC]

Initial value

1 [SEC]

12.10.10 Setting the ID Character Off-Time

To set the off-time of ID character blinking, follow the procedure below.

```
5 . S D I 1   I D   B L I N K   O F F   T I M E
                        1   [ S E C ]
```

Procedure

SDI CONFIG > SDI1 > VIDEO > ID CHARACTER > BLINK > OFF TIME

Parameters

1 - 9 [SEC]

Initial value

1 [SEC]

12.10.11 Turning ID Character Scrolling On and Off

To turn ID character scrolling on and off, follow the procedure below.

If set to ON, the ID characters scroll horizontally over the pattern.

```
5 . S D I 1   I D   S C R O L L
   O N            O F F
```

Procedure

SDI CONFIG > SDI1 > VIDEO > ID CHARACTER > SCROLL > ON/OFF

Parameters

ON / OFF

Initial value

OFF

12.10.12 Setting ID Character Scroll Speed

To set the ID character scroll speed and direction, follow the procedure below. The unit is dot/frame (frame). Setting a positive value scrolls from left to right and a negative value from right to left. Usually, set them in 2-dot steps. When the SDI format is set to 4K (SER04/SER21), set them in 4-dot steps.

```
5 . S D I 1   I D   S C R O L L   S P E E D
                                0 [ D O T ]
```

Procedure

SDI CONFIG > SDI1 > VIDEO > ID CHARACTER > SCROLL > SPEED

Parameters

±256 [DOT]

Initial value

0 [DOT]

12.10.13 Turning ID Character Background Transparency On and Off

To select whether to make the ID character background transparent, follow the procedure below.

```
4 . S D I 1   I D   T R A N S P A R E N C Y
     O N            O F F
```

Procedure

SDI CONFIG > SDI1 > VIDEO > ID CHARACTER > TRANSPARENCY

Parameters

ON / OFF

Initial value

OFF

TRANSPARENCY = ON

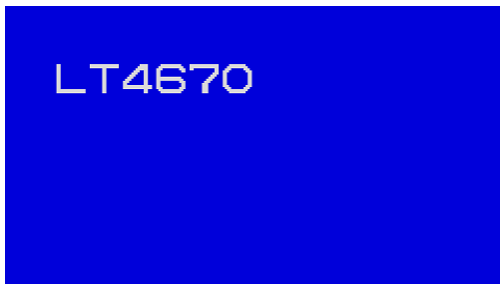

TRANSPARENCY = OFF



Figure 12-6 | Turning ID character background transparency on and off

12.10.14 Saving ID Characters

To store up to four sets of ID characters that you create on the SET menu, follow the procedure below.

Only the characters are saved. Position, size, and the like are not saved.

Procedure

SDI CONFIG > SDI1 > VIDEO > ID CHARACTER > STORE

To save ID characters, follow the procedure below.

1. Enter a file name.

Select "STORE" to display the file name input menu. This is the name assigned to the ID characters and is also the file name when the ID characters are copied to a USB memory device.

The characters that you can use are as follows. Up to eight characters can be entered.

◀ 0 1 2 3 4 5 6 7 8 9 A B C D E F G H I J K L M N O P Q R S T U V W X Y Z _

Enter ◀ to clear the characters that follow it. In this case, ◀ is not included in the file name.

```
4 . S D I 1   I D   S T O R E
L T 4 6 7 0 ◀
```

2. Select the save destination in the instrument.

Select from INT1 to INT4. If there are already ID characters stored at the destination, they are overwritten.

```
5 . S D I 1   I D   S T O R E
▶ N O   D A T A                               I N T 1
```

3. Select OK.

```
6 . S D I 1   I D   S T O R E
   ■ O K           □ C A N C E L
```

12.10.15 Copying ID Characters from a USB Memory Device to the Instrument

To copy up to four sets of ID characters from a USB memory device to the instrument, follow the procedure below. This feature is useful when you want to use multiple instruments with the same settings. (Copy the ID characters to the USB memory device in advance by using the COPY INT→USB menu.)

This setting appears when a USB memory device is connected.

Procedure

SDI CONFIG > SDI1 > VIDEO > ID CHARACTER > COPY USB→INT

To copy ID characters, follow the procedure below.

1. Select the copy destination in the instrument.

Select from INT1 to INT4. If there are already ID characters stored in the instrument, they are overwritten.

```
4 . S D I 1   I D   C O P Y   U S B → I N T
▶ N O   D A T A                               I N T 1
```

2. Select the copy source in the USB memory device.

The id file in the ID folder of the USB memory device is displayed here.

```
5 . S D I 1   I D   C O P Y   U S B → I N T
▶ L T 4 6 7 0 . i d                           1 / 1
```

3. Select OK.

```
6 . S D I 1   I D   C O P Y   U S B → I N T
   ■ O K                               □ C A N C E L
```

● **USB Memory Device Structure**

ID characters are copied from the ID folder of the USB memory device.

- USB memory device
 - └ ■ LT4670_USER
 - └ ■ ID
 - └ ■ ***,id

12.10.16 Copying ID Characters from the Instrument to a USB Memory Device

To copy ID characters in a dedicated format (.id) from the instrument to a USB memory device, follow the procedure below. This feature is useful when you want to use multiple instruments with the same settings. (Save the ID characters in the instrument in advance by using the STORE menu.)

This setting appears when a USB memory device is connected.

Procedure

SDI CONFIG > SDI1 > VIDEO > ID CHARACTER > COPY INT→USB

To copy ID characters, follow the procedure below.

1. Select the copy source in the instrument.

Select ALL or from INT1 to INT4.



2. Select OK.



● **USB Memory Device Structure**

ID characters are copied to the ID folder of the USB memory device.

The date and time of the file will be the date and time selected with TIME SOURCE on the REFERENCE CONFIG menu.

- USB memory device
 - └ ■ LT4670_USER
 - └ ■ ID
 - └ ■ ****.id

12.10.17 Clearing ID Characters

To clear ID characters that have been saved in the instrument, follow the procedure below.

Procedure

SDI CONFIG > SDI1 > VIDEO > ID CHARACTER > DELETE

To clear ID characters, follow the procedure below.

1. Select the ID characters you want to clear.

Select ALL or from INT1 to INT4.



2. Select OK.



12.11 Setting Logos

Under LOGO on the VIDEO menu, you can set a logo.

Here, you can display bitmap format images created in advance in a pattern.

This is invalid when the pattern is check field.



Figure 12-7 | Setting a logo

12.11.1 Displaying a Logo

This section describes the procedure for preparing a logo to displaying it in a pattern.

1. Create a logo.

Create an image in bitmap format according to the following conditions.

Here, as an example, a logo is created with the file name "leader.bmp".

File name: Up to 64 alphanumeric characters or underscore

File format: 24-bit bitmap format (.bmp)

Image size: 640 (width) × 480 (height) or less



2. Save the logo to a USB memory device.

Set up the folder structure on the USB memory device as follows and save the logo to the LOGO folder.

- USB memory device
 - └─ ■ LT4670_USER
 - └─ ■ LOGO
 - └─ ■ leader.bmp

3. **Connect the USB memory device to the instrument.**
4. **Using the COPY USB→INT menu, copy the logo from the USB memory device to the instrument.**

You can copy up to four logos (INT1 to INT4) to the instrument. The logo copies will be common to SDI1 to SDI4.

Here, as an example, "leader.bmp" is copied from a USB memory device to "INT1" on the instrument.

This menu appears only for SDI1 when a USB memory device is connected and contains a LOGO folder.

Using "SDI CONFIG > SDI1 > VIDEO > LOGO > COPY USB→INT", select a copy destination from INT1 to INT4. If there are already logos stored in the instrument, they will be overwritten.

```
4 . S D I 1   L O G O   C O P Y   U S B → I N T
▶ N O   D A T A                               I N T 1
```

Select the copy source in the USB memory device.

```
5 . S D I 1   L O G O   C O P Y   U S B → I N T
l e a d e r . b m p                             1 / 1
```

Select OK.

```
6 . S D I 1   L O G O   C O P Y   U S B → I N T
  ■ O K                               □ C A N C E L
```

5. **On the SELECT menu, select the logo.**

Select from INT1 to INT4.

```
4 . S D I 1   L O G O   S E L E C T
▶ * l e a d e r . b m p                       I N T 1
```

6. **On the ON/OFF menu, select ON.**

```
4 . S D I 1   L O G O
  ■ O N                               □ O F F
```

12.11.2 Turning the Logo On and Off

To turn the logo on and off, follow the procedure below.

```
4 . S D I 1   L O G O
       O N            O F F
```

Procedure

SDI CONFIG > SDI1 > VIDEO > LOGO > ON/OFF

Parameters

ON / OFF

Initial value

OFF

12.11.3 Selecting a Logo

To select the logo to be displayed, follow the procedure below.

A logo must be copied to INT1 to INT4 in advance using the COPY USB→INT menu.

```
4 . S D I 1   L O G O   S E L E C T
▶ * l e a d e r . b m p           I N T 1
```

Procedure

SDI CONFIG > SDI1 > VIDEO > LOGO > SELECT

Parameters

INT1 - INT4

Initial value

INT1

12.11.4 Setting the Logo Position (Vertical)

To set the logo position in the vertical direction, follow the procedure below.

The value represents the position of the top of the logo. The top of the pattern is 0%.

```
4 . S D I 1   L O G O   V - P O S I
                        0 [ % ]
```

Procedure

SDI CONFIG > SDI1 > VIDEO > LOGO > V-POSI

Parameters

0 - 100 [%]

Initial value

0 [%]

12.11.5 Setting the Logo Position (Horizontal)

To set the logo position in the horizontal direction, follow the procedure below.

The value represents the position of the left end of the logo. The left end of the pattern is 0%.

```
4 . S D I 1   L O G O   H - P O S I
                0   [ % ]
```

Procedure

SDI CONFIG > SDI1 > VIDEO > LOGO > H-POSI

Parameters

0 - 100 [%]

Initial value

0 [%]

12.11.6 Turning the Logo Transparency On and Off

To select whether to make the logo transparent, follow the procedure below.

You can specify the portions to be made transparent with LEVEL.

```
5 . S D I 1   L O G O   T R A N S P A R E N C Y
     O N            O F F
```

Procedure

SDI CONFIG > SDI1 > VIDEO > LOGO > TRANSPARENCY > ON/OFF

Parameters

ON / OFF

Initial value

OFF

12.11.7 Setting the Logo Transparency Level

To select the luminance level for transparency, follow the procedure below.

The luminance level is represented from 0 to 255. The logo will be displayed by making transparent the portions at or below the set level.

```
5 . S D I 1   L O G O   T R A N S P A R E N C Y
                1 6
```

Procedure

SDI CONFIG > SDI1 > VIDEO > LOGO > TRANSPARENCY > LEVEL

Parameters

0 - 255

Initial value

16

LEVEL = 16 (portions at or below the luminance level of 16 are made transparent)



LEVEL = 128 (portions at or below the luminance level of 128 are made transparent)



Figure 12-8 | Setting the logo transparency level

12.11.8 Copying Logos from a USB Memory Device to the Instrument

To copy up to four logos from a USB memory device to the instrument, follow the procedure below. The logo copies will be common to SDI1 to SDI4. (Copy the logo to the USB memory device in advance using the COPY INT→USB menu or create and place the logo.)

This menu appears only for SDI1 when a USB memory device is connected and contains a LOGO folder.

Procedure

SDI CONFIG > SDI1 > VIDEO > LOGO > COPY USB→INT

To copy logos, follow the procedure below.

1. Select the copy destination in the instrument.

Select from INT1 to INT4. If there are already logos stored in the instrument, they will be overwritten.

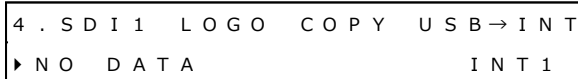

2. Select the copy source in the USB memory device.

The bmp file in the LOGO folder of the USB memory device is displayed here.

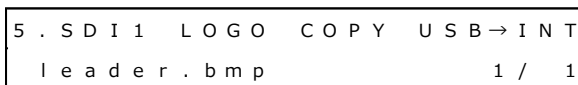

3. Select OK.

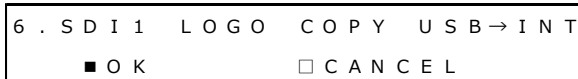

● **USB Memory Device Structure**

Logos are copied from the LOGO folder of the USB memory device.

- USB memory device
 - └ ■ LT4670_USER
 - └ ■ LOGO
 - └ ■ ****.bmp

12.11.9 Copying a Logo from the Instrument to a USB Memory Device

To copy a logo in bmp format from the instrument to a USB memory device, follow the procedure below. (Copy the logo to the instrument in advance using the COPY USB→INT menu.)

This menu appears only for SDI1 when a USB memory device is connected.

Procedure

SDI CONFIG > SDI1 > VIDEO > LOGO > COPY INT→USB

To copy logos, follow the procedure below.

1. Select the copy source in the instrument.

Select ALL or from INT1 to INT4.

```
4 . S D I 1   L O G O   C O P Y   I N T → U S B
▶ A L L
```

2. Select OK.

If a logo with the same file name is saved in the USB memory device, it will be overwritten.

If ALL is selected and logos with the same file name are saved in INT1 to INT4, only a single set with the largest number (INT*) is saved.

```
5 . S D I 1   L O G O   C O P Y   I N T → U S B
  ■ O K           □ C A N C E L
```

● **USB Memory Device Structure**

Logos are copied to the LOGO folder of the USB memory device.

- USB memory device
 - └ ■ LT4670_USER
 - └ ■ LOGO
 - └ ■ ****.bmp

12.11.10 Clearing a Logo

To clear a logo stored in the instrument, follow the procedure below.
This menu appears only for SDI1.

Procedure

SDI CONFIG > SDI1 > VIDEO > LOGO > DELETE

To clear logos, follow the procedure below.

1. Select the logo you want to clear.

Select ALL or from INT1 to INT4.

```
4 . S D I 1   L O G O   D E L E T E
▶ A L L
```

2. Select OK.

If you clear the currently displayed logo, the logo will continue to appear even after you select OK. By switching the logo, you can no longer display it again.

```
5 . S D I 1   L O G O   D E L E T E
  ■ O K           □ C A N C E L
```

12.12 Setting the Moving Box

Under MOVING BOX on the VIDEO menu, you can set the moving box. This is invalid when the pattern is check field.

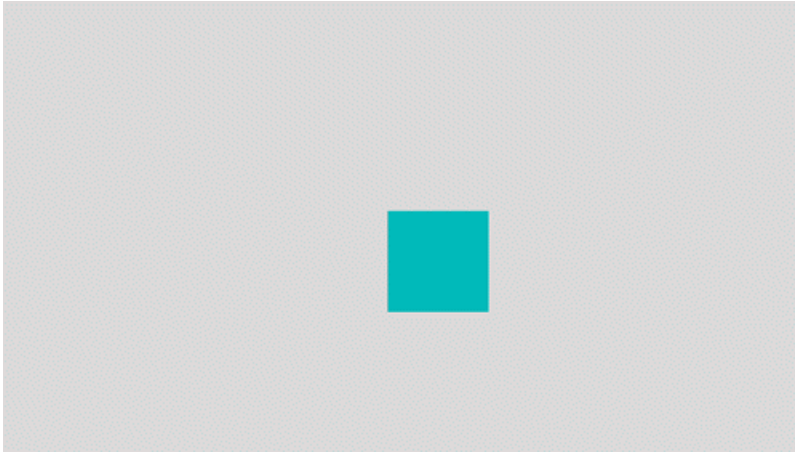

Figure 12-9 | Setting the moving box

12.12.1 Turning the Moving Box On and Off

To turn moving box on and off, follow the procedure below.



Procedure

SDI CONFIG > SDI1 > VIDEO > MOVING BOX > ON/OFF

Parameters

ON/OFF

Initial value

OFF

12.12.2 Selecting the Moving Box Color

To select the moving box color, follow the procedure below.

```
4 . S D I 1   B O X   C O L O R
▶ *   W H I T E
```

 Procedure

 SDI CONFIG > SDI1 > VIDEO > MOVING BOX > BOX COLOR

 Parameters

 WHITE / YELLOW / CYAN / GREEN / BLUE / RED / MAGENTA / BLACK

 Initial value

 WHITE

12.12.3 Selecting the Moving Box Speed (Vertical)

To select the vertical moving box speed, follow the procedure below.

```
4 . S D I 1   B O X   V - S P E E D
◀ *   M I D D L E
```

 Procedure

 SDI CONFIG > SDI1 > VIDEO > MOVING BOX > V-SPEED

 Parameters

 LOW / MIDDLE / HIGH

 Initial value

 MIDDLE

12.12.4 Selecting the Moving Box Speed (Horizontal)

To select the horizontal moving box speed, follow the procedure below.

```
4 . S D I 1   B O X   H - S P E E D
◀ *   M I D D L E
```

 Procedure

 SDI CONFIG > SDI1 > VIDEO > MOVING BOX > H-SPEED

 Parameters

 LOW / MIDDLE / HIGH

 Initial value

 MIDDLE

12.12.5 Selecting the Moving Box Height

To select the moving box height, follow the procedure below.
The larger the value, the larger the size.

```
4 . S D I 1   B O X   V - S I Z E
◆ *   S I Z E 2
```

Procedure

SDI CONFIG > SDI1 > VIDEO > MOVING BOX > V-SIZE

Parameters

SIZE1 / SIZE2 / SIZE3 / SIZE4 / SIZE5

Initial value

SIZE2

12.12.6 Selecting the Moving Box Width

To select the moving box width, follow the procedure below.
The larger the value, the larger the size.

```
4 . S D I 1   B O X   H - S I Z E
◆ *   S I Z E 2
```

Procedure

SDI CONFIG > SDI1 > VIDEO > MOVING BOX > H-SIZE

Parameters

SIZE1 / SIZE2 / SIZE3 / SIZE4 / SIZE5

Initial value

SIZE2

12.13 Setting a Circle

Under CIRCLE on the VIDEO menu, you can set a circle.
This is invalid when the pattern is check field.

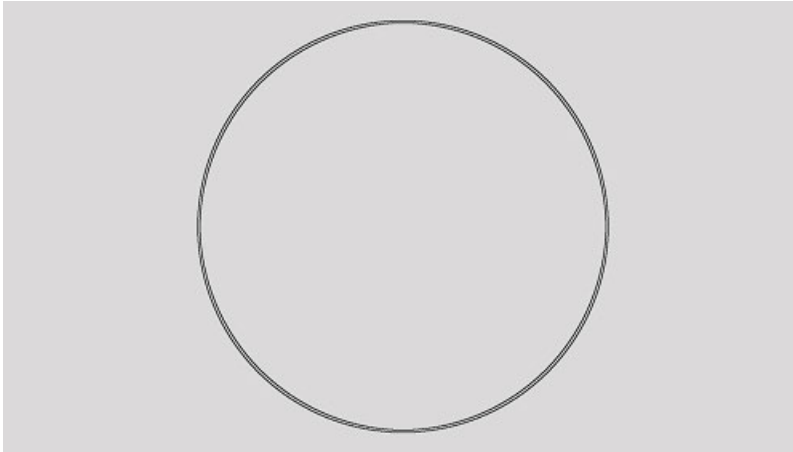

Figure 12-10 | Setting a circle

12.13.1 Turning the Circle On and Off

To turn the circle on and off, follow the procedure below.



Procedure

SDI CONFIG > SDI1 > VIDEO > CIRCLE > ON/OFF

Parameters

ON/OFF

Initial value

OFF

12.13.2 Selecting the Circle Level

To set the intensity level of the circle, follow the procedure below.



Procedure

SDI CONFIG > SDI1 > VIDEO > CIRCLE > LEVEL

Parameters

100% / 75%

Initial value

100%

12.13.3 Selecting the Circle Size

To select the circle size, follow the procedure below.
The vertical dimension of the picture is 100%.

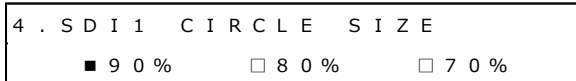

Procedure

SDI CONFIG > SDI1 > VIDEO > CIRCLE > SIZE

Parameters

90% / 80% / 70%

Initial value

90%

12.13.4 Turning Circle Blinking On and Off

To turn circle blinking on and off, follow the procedure below.



Procedure

SDI CONFIG > SDI1 > VIDEO > CIRCLE > BLINK > ON/OFF

Parameters

ON / OFF

Initial value

OFF

12.13.5 Setting the Circle Blinking On-Time

To set the circle blinking on-time, follow the procedure below.

5 . S D I 1 I D B L I N K O N T I M E
1 [S E C]

Procedure

SDI CONFIG > SDI1 > VIDEO > CIRCLE > BLINK > ON TIME

Parameters

1 - 9 [SEC]

Initial value

1 [SEC]

12.13.6 Setting the Circle Blinking Off-Time

To set the circle blinking off-time, follow the procedure below.

5 . S D I 1 I D B L I N K O F F T I M E
1 [S E C]

Procedure

SDI CONFIG > SDI1 > VIDEO > CIRCLE > BLINK > OFF TIME

Parameters

1 - 9 [SEC]

Initial value

1 [SEC]

12.14 Setting the Time Code

Under TIMECODE on the VIDEO menu, you can set the time code. This is invalid when the pattern is check field.

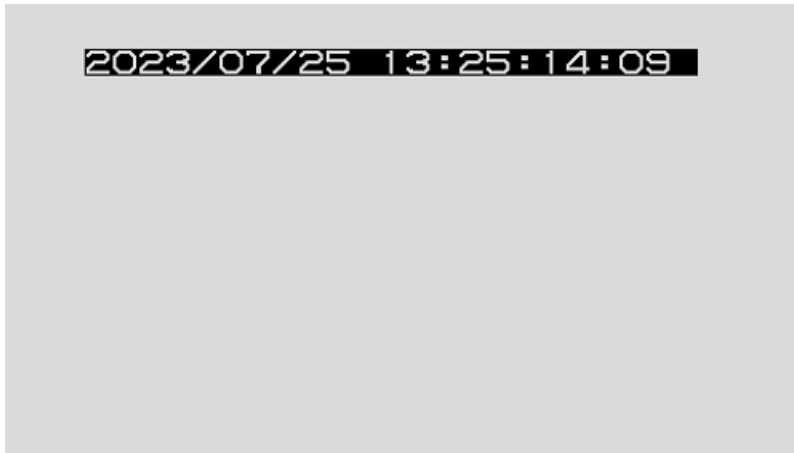

Figure 12-11 | Setting the time code

12.14.1 Turning the Time Code On and Off

Turn the time code on and off, follow the procedure below.

If it is set to ON, the date and time selected with TIME SOURCE on the REFERENCE CONFIG menu is displayed.



Procedure

SDI CONFIG > SDI1 > VIDEO > TIMECODE > ON/OFF

Parameters

ON/OFF

Initial value

OFF

12.14.2 Setting the Time Code Position (Vertical)

To set the vertical time code position, follow the procedure below.

The value represents the position of the top of the time code. The top of the pattern is 0%.

4 . S D I 1 T I M E C O D E V - P O S I
0 [%]

Procedure

SDI CONFIG > SDI1 > VIDEO > TIMECODE > V-POSI

Parameters

0 - 100 [%]

Initial value

0 [%]

12.14.3 Setting the Time Code Position (Horizontal)

To set the horizontal time code position, follow the procedure below.

The value represents the position of the left end of the time code. The left end of the pattern is 0%.

4 . S D I 1 T I M E C O D E H - P O S I
0 [%]

Procedure

SDI CONFIG > SDI1 > VIDEO > TIMECODE > H-POSI

Parameters

0 - 100 [%]

Initial value

0 [%]

12.14.4 Selecting the Time Code Size

To select the time code size, follow the procedure below.

The size of x1 is 32×32 dot/character.

4 . S D I 1 T I M E C O D E S I Z E
<input checked="" type="checkbox"/> x 1 <input type="checkbox"/> x 2 <input type="checkbox"/> x 4 <input type="checkbox"/> x 8

Procedure

SDI CONFIG > SDI1 > VIDEO > TIMECODE > SIZE

Parameters

x1 / x2 / x4 / x8

Initial value

x1

12.14.5 Selecting the Time Code Level

To select the time code intensity level, follow the procedure below.



Procedure

SDI CONFIG > SDI1 > VIDEO > TIMECODE > LEVEL

Parameters

100% / 75%

Initial value

100%

12.14.6 Turning Time Code Background Transparency On and Off

To select whether to make the time code background transparent, follow the procedure below.



Procedure

SDI CONFIG > SDI1 > VIDEO > TIMECODE > TRANSPARENCY

Parameters

ON / OFF

Initial value

OFF

TRANSPARENCY = ON

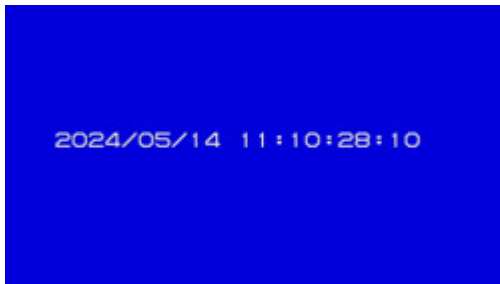

TRANSPARENCY = OFF

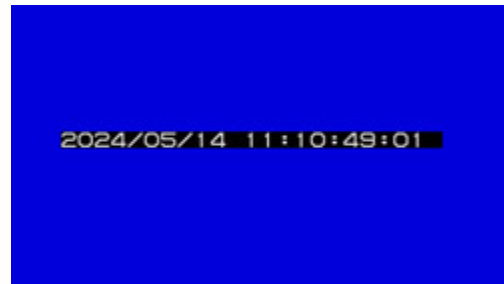

Figure 12-12 | Turning time code background transparency on and off

12.15 Turning Lip Sync On and Off

To turn lip sync pattern on and off, follow the procedure below.

When it is turned on, the instrument outputs lip sync patterns. Combining these with our lip-sync-compatible waveform monitor makes it possible to measure the offset between the video signal and the audio signal that occurs in the transfer route for each channel. For details, see the instruction manual of the waveform monitor.



Procedure

SDI CONFIG > SDI1 > VIDEO > LIPSYNC

Parameters

ON/OFF

Initial value

OFF

A lip sync pattern is divided into three areas. From the top, they are the pattern, raster, and scale areas. Audio is turned on or muted in sync with the image signal.

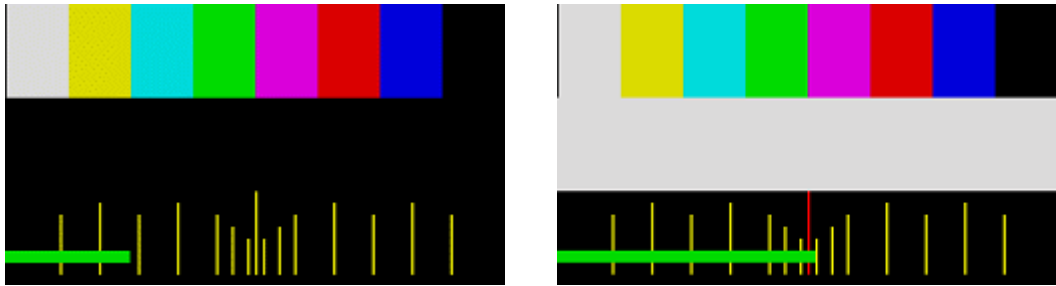

Figure 12-13 | Lip sync pattern

Pattern

The pattern selected from "PATTERN" on the SDI CONFIG menu is displayed. If the check field pattern is selected, a 100% color bar is displayed.

Raster

If the scale slide bar is between 0 and +15 [frames], a white raster is displayed. If not, a black raster is displayed.

Scale

A green slide bar scrolls from left to right (approximately 6 seconds for 1080/59.94I). The center scale turns red when the slide bar is between 0 and +15 [frames].

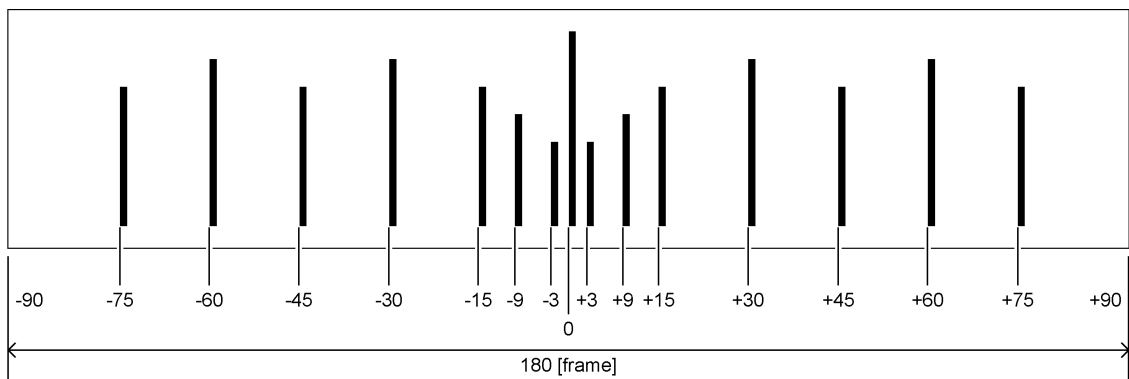

Figure 12-14 | Scale

Audio

If the scale slide bar is between 0 and +15 [frames], audio turns on. If not, audio is muted. The click setting is invalid.

12.16 Configuring Embedded Audio

Under EMBEDDED AUDIO on the SDI1 menu, you can configure embedded audio.



16 audio channels can be embedded in the SDI output.
(Embedding is not possible when the pattern is a check field.)

Channels 1 to 4, 5 to 8, 9 to 12, and 13 to 16 are called groups 1, 2, 3, and 4, respectively. The frequency, level, and the like can be set for each channel separately. The resolution, pre-emphasis, and the like can be set for each group separately.

In addition, settings shared by channels and settings shared by groups can also be set. For example, if settings shared with channel 1 are turned ON for channel 2, merely specifying settings for channel 1 causes channel 2 to automatically have the same settings as those for channel 1.

Table 12-3 | Channels and groups

Channel	Group
1ch	Group 1
Ch2 (Ch1 also possible)	
Ch3 (Ch1 also possible)	
Ch4 (Ch1 also possible)	
5ch	Group 2 (can also be set equal to group 1)
Ch6 (Ch5 also possible)	
Ch7 (Ch5 also possible)	
Ch8 (Ch5 also possible)	
9ch	Group 3 (can also be set equal to group 1)
Ch10 (Ch9 also possible)	
Ch11 (Ch9 also possible)	
Ch12 (Ch9 also possible)	
13ch	Group 4 (can also be set equal to group 3)
Ch14 (Ch13 also possible)	
Ch15 (Ch13 also possible)	
Ch16 (Ch13 also possible)	

12.16.1 Turning the Audio On and Off

To turn the audio on or off at the group level, follow the procedure below.

3 . S D I 1	E M B	A U D I O	O N / O F F
<input checked="" type="checkbox"/> G 1	<input checked="" type="checkbox"/> G 2	<input checked="" type="checkbox"/> G 3	<input checked="" type="checkbox"/> G 4

Procedure

SDI CONFIG > SDI1 > EMBEDDED AUDIO > ON/OFF

Parameters

ON / OFF

Initial value

ON

12.16.2 Selecting the Resolution

To select the resolution for the selected group, follow the procedure below.

If the SDI format is set to 720x487 SD, not all groups can be set to 24BIT. Up to three groups can be set to 24BIT.

4 . S D I 1	G 1	R E S O L U T I O N
<input checked="" type="checkbox"/> 2 0 B I T	<input type="checkbox"/> 2 4 B I T	

Procedure

SDI CONFIG > SDI1 > EMBEDDED AUDIO > G1 - 4 > RESOLUTION

Parameters

20BIT / 24BIT

Initial value

20BIT

12.16.3 Selecting the Pre-emphasis Mode

To select the pre-emphasis mode for the selected group, follow the procedure below.

4 . S D I 1	G 1	E M P H A S I S
<input type="checkbox"/> 5 0 / 1 5	<input type="checkbox"/> C C I T T	<input checked="" type="checkbox"/> O F F

Procedure

SDI CONFIG > SDI1 > EMBEDDED AUDIO > G1 - 4 > EMPHASIS

Parameters

50/15 / CCITT / OFF

Initial value

OFF

12.16.4 Selecting the Frequency

To select the frequency of the selected channel, follow the procedure below.

```
5 . S D I 1   G 1 / C H 1   F R E Q
◀ * 1 k H z
```

Procedure

SDI CONFIG > SDI1 > EMBEDDED AUDIO > G1 - 4 > CH1 - 16 > FREQ

Parameters

SILENCE / 400Hz / 800Hz / 1kHz

Initial value

1kHz

12.16.5 Setting the Level

To set the level of the selected channel, follow the procedure below.

```
5 . S D I 1   G 1 / C H 1   L E V E L
- 2 0 [ d B F S ]
```

Procedure

SDI CONFIG > SDI1 > EMBEDDED AUDIO > G1 - 4 > CH1 - 16 > LEVEL

Parameters

-60 - 0 [dBFS]

Initial value

-20 [dBFS]

12.16.6 Setting Clicks

You can insert click sounds into the selected channel. Follow the procedure below to set the insertion interval to a value other than OFF.

This is invalid when LIPSYNC is set to ON.

```
5 . S D I 1   G 1 / C H 1   C L I C K
▶ * O F F
```

Procedure

SDI CONFIG > SDI1 > EMBEDDED AUDIO > G1 - 4 > CH1 - 16 > CLICK

Parameters

OFF / 1sec / 2sec / 4sec

Initial value

OFF

12.16.7 Settings Shared by Channels

To specify the settings for CH2 (frequency, level, and click sound) to be the same as those for CH1, select ON by following the procedure below. In this case, you cannot specify the settings for CH2.

The same holds true for other channels.

5 . S D I 1 G 1 / C H 2 E Q U A L C H 1
<input type="checkbox"/> O N <input checked="" type="checkbox"/> O F F

Procedure

SDI CONFIG > SDI1 > EMBEDDED AUDIO

> G1 > CH2 - 4 > EQUAL TO CH1

> G2 > CH6 - 8 > EQUAL TO CH5

> G3 > CH10 - 12 > EQUAL TO CH9

> G4 > CH14 - 16 > EQUAL TO CH13

Parameters

ON / OFF

Initial value

OFF

12.16.8 Settings Shared by Groups

To specify the settings for group 2 to be the same as those for group 1, select ON by following the procedure below. In this case, you cannot specify the settings for group 2.

The same holds true for group 3 and group 4.

4 . S D I 1 G 2 E Q U A L T O G 1
<input type="checkbox"/> O N <input checked="" type="checkbox"/> O F F

Procedure

SDI CONFIG > SDI1 > EMBEDDED AUDIO

> G2 > EQUAL TO G1

> G3 > EQUAL TO G1

> G4 > EQUAL TO G3

Parameters

ON / OFF

Initial value

OFF

12.17 Setting Ancillary Data

Under ANC on the SDI1 menu, you can set ancillary data.

```
1 . S D I 1
  ◆ A N C
```

12.17.1 Turning the LTC Signals On and Off

To turn LTC insertion on and off, follow the procedure below.

```
3 . S D I 1   A N C   A T C - L T C
  □ O N       ■ O F F
```

Procedure

SDI CONFIG > SDI1 > ANC > ATC-LTC

Parameters

ON / OFF

Initial value

OFF

12.17.2 Turning the VITC Signals On and Off

To turn VITC insertion on and off, follow the procedure below.

```
3 . S D I 1   A N C   A T C - V I T C
  □ O N       ■ O F F
```

Procedure

SDI CONFIG > SDI1 > ANC > ATC-VITC

Parameters

ON / OFF

Initial value

OFF

12.17.3 Setting Dropped Frames

To select the dropped frame setting, follow the procedure below.

This setting is valid when the frame frequency of the SDI output is set to 59.94 or 29.97.

```
3 . S D I 1   D R O P   F R A M E
      ■ O N           □ O F F
```

Procedure

SDI CONFIG > SDI1 > ANC > DROP FRAME

Parameters

ON: Dropped frame time code is used.

OFF: Non-dropped frame time code is used.

Initial value

ON

12.18 Setting the SDI Output

Under OUTPUT SETTING on the SDI1 menu, you can set the SDI output.

```
1 . S D I 1
  ▲ O U T P U T   S E T T I N G   ↓
```

12.18.1 Turning the SDI Output On and Off

To turn the SDI output on and off, follow the procedure below.

```
3 . S D I 1   O U T P U T
      ■ E N A B L E   □ D I S A B L E
```

Procedure

SDI CONFIG > SDI1 > OUTPUT SETTING > OUTPUT

Parameters

ENABLE / DISABLE

Initial value

ENABLE

12.18.2 Turning BMCA Linkage On and Off (SER03)

If you set ENABLE in the procedure below, the SDI output is stopped in linkage with BMCA of the selected PTP. Once the SDI output is stopped, this menu and the OUTPUT menu are both changed to DISABLE.

To enable the SDI output again, set the OUTPUT menu to ENABLE.

```
3 . S D I 1   L I N K E D   T O   P T P 1
    E N A B L E    D I S A B L E
```

Procedure

SDI CONFIG > SDI1 > OUTPUT SETTING > LINKED TO PTP1 BMCA / LINKED TO PTP2 BMCA

Parameters

ENABLE / DISABLE

Initial value

DISABLE

12.19 Settings Shared by SDI Outputs

To specify the settings for SDI2 to be same as those for SDI1, select ON by following the procedure below. In this case, you cannot specify the settings for SDI2.

The same holds true for SDI3 and SDI4.

```
2 . S D I 2   E Q U A L   T O   S D I 1
    O N    O F F
```

Procedure

SDI CONFIG

> SDI2 > EQUAL TO SDI1

> SDI3 > EQUAL TO SDI1

> SDI4 > EQUAL TO SDI3

Parameters

ON / OFF

Initial value

OFF

13 PTP CONFIG MENU (SER03)

The PTP CONFIG menu is used to specify PTP settings.

To display the PTP CONFIG menu, press CONFIG several times until the following menu appears.

```
0 . P T P   C O N F I G
▼ P T P 1
```

On the PTP CONFIG menu, you can specify settings for PTP1 and PTP2 individually. The procedure below is for PTP1, but the same procedure can also be applied to PTP2.

13.1 PTP Leader and PTP Follower

PTP involves cases in which this instrument is used as a leader and cases in which it is used as a follower.

These operation modes can be set individually for PTP1 and PTP2. The operation modes are determined by the REFERENCE SOURCE and TIME SOURCE settings in the REFERENCE CONFIG menu, as shown below.

Table 13-1 | PTP leader and PTP follower

REFERENCE SOURCE	TIME SOURCE	PTP1	PTP2
Other than PTP	Other than PTP	Leader	Leader
INTERNAL, GENLOCK, 10MHz CW, PTP1	PTP1	Follower	Leader
INTERNAL, GENLOCK, 10MHz CW, PTP2	PTP2	Leader	Follower
PTP1/2	PTP1/2	Follower	Follower

13.2 Setting the PTP Leader

13.2.1 Selecting the Mode

To select whether to enable the PTP leader, follow the procedure below.

```
2 . P T P 1   M O D E
▶ * E N A B L E   L E A D E R
```

Procedure

PTP CONFIG > PTP1 > MODE

Parameters

ENABLE LEADER / DISABLE LEADER

Initial value

ENABLE LEADER (PTP1)

DISABLE LEADER (PTP2)

13.2.2 Configuring BMCA

To select whether to enable BMCA, follow the procedure below.

```
3 . P T P 1   B M C A   S E T U P
▶ * E N A B L E
```

Procedure

PTP CONFIG > PTP1 > BMCA > BMCA SETUP

Parameters

ENABLE:	BMCA is enabled.
ENABLE ONLY ONCE:	BMCA is enabled only once.
DISABLE:	BMCA is disabled.

Initial value

ENABLE

13.2.3 Recovering Priority 1

If BMCA works when ENABLE ONLY ONCE is set in BMCA SETUP, Priority 1 lowers internally.

To recover the value of Priority 1, select OK by following the procedure below.

```
3 . P T P 1   P R I 1   R E C O V E R Y
    O K            C A N C E L
```

Procedure

PTP CONFIG > PTP1 > BMCA > PRIORITY1 RECOVERY

13.2.4 Selecting the Profile

To select the profile, follow the procedure below.

```
2 . P T P 1   P R O F I L E   T Y P E
▶ * S T 2 0 5 9
```

Procedure

PTP CONFIG > PTP1 > PROFILE TYPE

Parameters

ST2059 / AES67 / GENERAL

Initial value

ST2059

13.2.5 Profile Default Settings

To set the default values of the selected profile, press the ENTER key by following the procedure below.

```
3 . P T P 1   P R O F I L E
E N T E R   T O   D E F A U L T
```

Procedure

PTP CONFIG > PTP1 > DETAIL SETTING > PROFILE SET DEFAULT

13.2.6 Setting the Domain

To set the domain number, follow the procedure below.

```
3 . P T P 1   D O M A I N
          1 2 7
```

Procedure

PTP CONFIG > PTP1 > DETAIL SETTING > DOMAIN

Parameters

0 to 127 (when PROFILE TYPE is set to ST2059)

0 to 255 (when PROFILE TYPE is set to AES67 or GENERAL)

Initial value

127 (when PTP1 is to be configured and PROFILE TYPE is set to ST2059)

126 (when PTP2 is to be configured and PROFILE TYPE is set to ST2059)

0 (when PROFILE TYPE is set to AES67 or GENERAL)

13.2.7 Selecting the Communication Mode

To select the communication mode, follow the procedure below.

```
3 . P T P 1   C O M M U N I C A T I O N
♦ * M I X E D   S M P T E   w / o   N E
```

Procedure

PTP CONFIG > PTP1 > DETAIL SETTING > COMMUNICATION MODE

Parameters

MIXED SMPTE / MIXED SMPTE w/o NE / UNICAST / MULTICAST (when PROFILE TYPE is set to ST2059)

UNICAST / MULTICAST (when PROFILE TYPE is set to AES67 or GENERAL)

Initial value

MIXED SMPTE w/o NE (when PROFILE TYPE is set to ST2059)

MULTICAST (when PROFILE TYPE is set to AES67 or GENERAL)

13.2.8 Setting the Announce Message Transmission Interval

To select the announce message transmission interval, follow the procedure below.
This menu item is not displayed when COMMUNICATION MODE is set to UNICAST.

```

3 . P T P 1   A N N O U N C E   I N T
◆ *   0 . 2 5 s       4 H z
    
```

Procedure

PTP CONFIG > PTP1 > DETAIL SETTING > ANNOUNCE INTERVAL

Parameters

0.125s / 0.25s / 0.5s / 1s / 2s (when PROFILE TYPE is set to ST2059)
 1s / 2s / 4s / 8s / 16s (when PROFILE TYPE is set to AES67)
 0.125s / 0.25s / 0.5s / 1s / 2s / 4s / 8s / 16s (when PROFILE TYPE is set to GENERAL)

Initial value

0.25s (when PROFILE TYPE is set to ST2059)
 2s (when PROFILE TYPE is set to AES67 or GENERAL)

13.2.9 Setting the Sync Message Transmission Interval

To select the sync message transmission interval, follow the procedure below.
This menu item is not displayed when COMMUNICATION MODE is set to UNICAST.

```

3 . P T P 1   S Y N C   I N T E R V A L
◆ *   0 . 1 2 5 s       8 H z
    
```

Procedure

PTP CONFIG > PTP1 > DETAIL SETTING > SYNC INTERVAL

Parameters

0.0078s / 0.015s / 0.0312s / 0.0625s / 0.125s / 0.25s / 0.5s
 (when PROFILE TYPE is set to ST2059)
 0.0625s / 0.125s / 0.25s / 0.5s / 1s (when PROFILE TYPE is set to AES67)
 0.125s / 0.25s / 0.5s / 1s / 2s / 4s / 8s / 16s (when PROFILE TYPE is set to GENERAL)

Initial value

0.125s (when PROFILE TYPE is set to ST2059 or AES67)
 1s (when PROFILE TYPE is set to GENERAL)

13.2.10 Setting the Announce Timeout

To set the number of announce messages used to judge whether a timeout occurs, follow the procedure below.

If the specified number of messages are not received consecutively at the interval specified by the leader, a timeout occurs.

```
3 . P T P 1   A N N O U N C E
    T I M E O U T   C O U N T :   3
```

Procedure

PTP CONFIG > PTP1 > DETAIL SETTING > ANNOUNCE TIMEOUT

Parameters

2 - 10

Initial value

3

13.2.11 Setting Priority 1

To set priority 1 of the leader, follow the procedure below.

```
3 . P T P 1   P R I O R I T Y 1
    1 2 8
```

Procedure

PTP CONFIG > PTP1 > DETAIL SETTING > PRIORITY1

Parameters

0 - 255

Initial value

128

13.2.12 Setting Priority 2

To set priority 2 of the leader, follow the procedure below.

```
3 . P T P 1   P R I O R I T Y 2
    1 2 8
```

Procedure

PTP CONFIG > PTP1 > DETAIL SETTING > PRIORITY2

Parameters

0 - 255

Initial value

128

13.2.13 Selecting the Step

To select the step, follow the procedure below.

```
3 . P T P 1   S T E P
▶ * O N E   S T E P
```

Procedure

PTP CONFIG > PTP1 > DETAIL SETTING > STEP

Parameters

ONE STEP: A timestamp is sent with a sync message.
TWO STEP: A timestamp is sent with a follow-up message, apart from a sync message.

Initial value

ONE STEP

13.2.14 Selecting the Default Frame

When PROFILE TYPE is set to ST2059, to select the default frame, follow the procedure below.

```
4 . P T P 1   S T 2 0 5 9
◀ * F R A M E : 2 9 . 9 7
```

Procedure

PTP CONFIG > PTP1 > DETAIL SETTING > ST2059 > DEFAULT FRAME

Parameters

23.98 / 24 / 25 / 29.97 / 30 / 47.95 / 48 / 50 / 59.94 / 60 / 71.92 / 72 / 100 / 119.9 / 120

Initial value

29.97

13.2.15 Setting the Dropped Frame Flag

When PROFILE TYPE is set to ST2059, to select whether to enable the dropped frame flag, follow the procedure below.

```
4 . P T P 1   S T 2 0 5 9
▶ * D R O P   F R A M E : E N A B L E
```

Procedure

PTP CONFIG > PTP1 > DETAIL SETTING > ST2059 > DROP FRAME FLAG

Parameters

ENABLE / DISABLE

Initial value

ENABLE

13.2.16 Setting the Color Frame ID

When PROFILE TYPE is set to ST2059, to select whether to enable the color frame ID, follow the procedure below.

```
4 . P T P 1   S T 2 0 5 9
▶ * C F I D : E N A B L E
```

Procedure

PTP CONFIG > PTP1 > DETAIL SETTING > ST2059 > COLOR FRAME ID

Parameters

ENABLE / DISABLE

Initial value

ENABLE

13.2.17 Selecting the Propagation Time Measurement Method

To select the propagation time measurement method, follow the procedure below.

```
3 . P T P 1   D E L A Y   M E C H A N I S M
▶ * E N D   T O   E N D
```

Procedure

PTP CONFIG > PTP1 > DETAIL SETTING > DELAY MECHANISM

Parameters

END TO END / PEER TO PEER

Initial value

END TO END

13.3 Setting the PTP Follower

13.3.1 Selecting the Mode

The mode is fixed to PTP follower, and you cannot change it.

```
2 . P T P 1   M O D E
* F O L L O W E R
```

Procedure

PTP CONFIG > PTP1 > MODE

Parameters

FOLLOWER

13.3.2 Selecting the Profile

To select the profile, follow the procedure below.

```
2 . P T P 1   P R O F I L E   T Y P E
▶ * S T 2 0 5 9
```

Procedure

PTP CONFIG > PTP1 > PROFILE TYPE

Parameters

ST2059 / AES67 / GENERAL

Initial value

ST2059

13.3.3 Profile Default Settings

To set the default values of the selected profile, press the ENTER key by following the procedure below.

```
3 . P T P 1   P R O F I L E
E N T E R   T O   D E F A U L T
```

Procedure

PTP CONFIG > PTP1 > DETAIL SETTING > PROFILE SET DEFAULT

13.3.4 Setting the Domain

To set the domain number, follow the procedure below.

```
3 . P T P 1   D O M A I N
      1 2 7
```

Procedure

PTP CONFIG > PTP1 > DETAIL SETTING > DOMAIN

Parameters

0 to 127 (when PROFILE TYPE is set to ST2059)

0 to 255 (when PROFILE TYPE is set to AES67 or GENERAL)

Initial value

127 (when PTP1 is to be configured and PROFILE TYPE is set to ST2059)

0 (when PROFILE TYPE is set to AES67 or GENERAL)

13.3.5 Setting the Communication Mode

To select the communication mode, follow the procedure below.

```
3 . P T P 1   C O M M U N I C A T I O N
  * M U L T I C A S T
```

Procedure

PTP CONFIG > PTP1 > DETAIL SETTING > COMMUNICATION MODE

Parameters

MIXED SMPTE / MIXED SMPTE w/o NE / UNICAST / MULTICAST (when PROFILE TYPE is set to ST2059)

UNICAST / MULTICAST (when PROFILE TYPE is set to AES67 or GENERAL)

Initial value

MULTICAST

13.3.6 Selecting the Desired Announce Message Transmission Interval

When COMMUNICATION MODE is set to UNICAST, to select the interval at which you want the announce message to be transmitted to the destination leader, follow the procedure below. Select an interval shorter than ANNOUNCE REQD INT.

```

3 . P T P 1   A N C   D E S I R   I N T
◀ *   0 . 2 5 s       4 H z
    
```

Procedure

PTP CONFIG > PTP1 > DETAIL SETTING > ANNOUNCE DESIR INT

Parameters

0.125s / 0.25s / 0.5s / 1s / 2s (when PROFILE TYPE is set to ST2059)
 1s / 2s / 4s / 8s / 16s (when PROFILE TYPE is set to AES67)
 0.125s / 0.25s / 0.5s / 1s / 2s / 4s / 8s / 16s (when PROFILE TYPE is set to GENERAL)

Initial value

0.25s (when PROFILE TYPE is set to ST2059)
 2s (when PROFILE TYPE is set to AES67 or GENERAL)

13.3.7 Selecting the Announce Message Reception Interval

When COMMUNICATION MODE is set to UNICAST, to set the minimum interval at which the follower can receive the announce message, follow the procedure below.

```

3 . P T P 1   A N C   R E Q D   I N T
◀ *           2 s   0 . 5 H z
    
```

Procedure

PTP CONFIG > PTP1 > DETAIL SETTING > ANNOUNCE REQD INT

Parameters

0.125s / 0.25s / 0.5s / 1s / 2s (when PROFILE TYPE is set to ST2059)
 1s / 2s / 4s / 8s / 16s (when PROFILE TYPE is set to AES67)
 0.125s / 0.25s / 0.5s / 1s / 2s / 4s / 8s / 16s (when PROFILE TYPE is set to GENERAL)

Initial value

2s (when PROFILE TYPE is set to ST2059)
 16s (when PROFILE TYPE is set to AES67 or GENERAL)

13.3.8 Selecting the Desired Sync Message Transmission Interval

When COMMUNICATION MODE is set to UNICAST, to select the interval at which you want the sync message to be transmitted to the destination leader, follow the procedure below.
Select an interval shorter than SYNC REQD INT.

```

3 . P T P 1   S Y N   D E S I R   I N T
◀ *   0 . 1 2 5 s       8 H z
    
```

Procedure

PTP CONFIG > PTP1 > DETAIL SETTING > SYNC DESIR INT

Parameters

0.0078s / 0.015s / 0.0312s / 0.0625s / 0.125s / 0.25s / 0.5s (when PROFILE TYPE is set to ST2059)

0.0625s / 0.125s / 0.25s / 0.5s / 1s / 2s (when PROFILE TYPE is set to AES67)

0.0078s / 0.015s / 0.0312s / 0.0625s / 0.125s / 0.25s / 0.5s / 1s / 2s / 4s / 8s (when PROFILE TYPE is set to GENERAL)

Initial value

0.125s (when PROFILE TYPE is set to ST2059)

1s (when PROFILE TYPE is set to AES67)

2s (when PROFILE TYPE is set to GENERAL)

13.3.9 Selecting the Sync Message Reception Interval

When COMMUNICATION MODE is set to UNICAST, to select the minimum interval at which the follower can receive the sync message, follow the procedure below.

```

3 . P T P 1   S Y N   R E Q D   I N T
◀ *           0 . 5 s       2 H z
    
```

Procedure

PTP CONFIG > PTP1 > DETAIL SETTING > SYNC REQD INT

Parameters

0.0078s / 0.015s / 0.0312s / 0.0625s / 0.125s / 0.25s / 0.5s (when PROFILE TYPE is set to ST2059)

0.0625s / 0.125s / 0.25s / 0.5s / 1s / 2s (when PROFILE TYPE is set to AES67)

0.0078s / 0.015s / 0.0312s / 0.0625s / 0.125s / 0.25s / 0.5s / 1s / 2s / 4s / 8s (when PROFILE TYPE is set to GENERAL)

Initial value

0.5s (when PROFILE TYPE is set to ST2059)

2s (when PROFILE TYPE is set to AES67)

8s (when PROFILE TYPE is set to GENERAL)

13.3.10 Selecting the Delay Message Transmission Interval

When COMMUNICATION MODE is set to MIXED SMPTE w/o NE or MULTICAST, to select the delay message transmission interval, follow the procedure below.

```
3 . P T P 1   D E L A Y   M S G   I N T
◆ *   0 . 1 2 5 s       8 H z
```

Procedure

PTP CONFIG > PTP1 > DETAIL SETTING > DELAY MSG INTERVAL

Parameters

0.0078s / 0.015s / 0.0312s / 0.0625s / 0.125s / 0.25s / 0.5s (when PROFILE TYPE is set to ST2059)

0.125s / 0.25s / 0.5s / 1s / 2s / 4s / 8s / 16s (when PROFILE TYPE is set to AES67)

0.0078s / 0.015s / 0.0312s / 0.0625s / 0.125s / 0.25s / 0.5s / 1s / 2s / 4s / 8s / 16s (when PROFILE TYPE is set to GENERAL)

Initial value

0.125s (when PROFILE TYPE is set to ST2059)

1s (when PROFILE TYPE is set to AES67 or GENERAL)

13.3.11 Selecting the Desired Delay Message Transmission Interval

When COMMUNICATION MODE is set to MIXED SMPTE or UNICAST, to select the interval at which you want the delay message to be transmitted to the connection leader, follow the procedure below.

```
3 . P T P 1   D L Y   D E S I R   I N T
◆ *   0 . 1 2 5 s       8 H z
```

Procedure

PTP CONFIG > PTP1 > DETAIL SETTING > DLY MSG DESIRED INT

Parameters

0.0078s / 0.015s / 0.0312s / 0.0625s / 0.125s / 0.25s / 0.5s (when PROFILE TYPE is set to ST2059)

0.125s / 0.25s / 0.5s / 1s / 2s / 4s / 8s / 16s (when PROFILE TYPE is set to AES67)

0.0078s / 0.015s / 0.0312s / 0.0625s / 0.125s / 0.25s / 0.5s / 1s / 2s / 4s / 8s / 16s (when PROFILE TYPE is set to GENERAL)

Initial value

0.125s (when PROFILE TYPE is set to ST2059 or AES67)

2s (when PROFILE TYPE is set to GENERAL)

13.3.12 Selecting the Delay Message Reception Interval

When COMMUNICATION MODE is set to MIXED SMPTE or UNICAST, to select the minimum interval at which the follower can receive the delay message, follow the procedure below.

```
3 . P T P 1   D L Y   R E Q D   I N T
*           0 . 5 s       2 H z
```

Procedure

PTP CONFIG > PTP1 > DETAIL SETTING > DLY MSG REQD INT

Parameters

0.0078s / 0.015s / 0.0312s / 0.0625s / 0.125s / 0.25s / 0.5s (when PROFILE TYPE is set to ST2059)

0.125s / 0.25s / 0.5s / 1s / 2s / 4s / 8s / 16s (when PROFILE TYPE is set to AES67)

0.0078s / 0.015s / 0.0312s / 0.0625s / 0.125s / 0.25s / 0.5s / 1s / 2s / 4s / 8s / 16s (when PROFILE TYPE is set to GENERAL)

Initial value

0.5s (when PROFILE TYPE is set to ST2059)

2s (when PROFILE TYPE is set to AES67)

8s (when PROFILE TYPE is set to GENERAL)

13.3.13 Setting the Announce Timeout

To set the number of announce messages used to judge whether a timeout occurs, follow the procedure below.

If the specified number of messages are not received consecutively at the interval specified by the leader, a timeout occurs.

```
3 . P T P 1   A N N O U N C E
T I M E O U T   C O U N T :   3
```

Procedure

PTP CONFIG > PTP1 > DETAIL SETTING > ANNOUNCE TIMEOUT

Parameters

2 - 10

Initial value

3

13.3.14 Selecting the Propagation Time Measurement Method

To select the propagation time measurement method, follow the procedure below.

```
3 . P T P 1   D E L A Y   M E C H A N I S M
▶ * E N D   T O   E N D
```

Procedure

PTP CONFIG > PTP1 > DETAIL SETTING > DELAY MECHANISM

Parameters

END TO END / PEER TO PEER

Initial value

END TO END

13.3.15 Setting the IP Address

When COMMUNICATION MODE is set to MIXED SMPTE w/o NE or UNICAST, to set the IP address of the leader to connect to, follow the procedure below.

```
4 . P T P 1   A M T   A D D R E S S 1
0 0 0 . 0 0 0 . 0 0 0 . 0 0 0
```

Procedure

PTP CONFIG > PTP1 > DETAIL SETTING > AMT CONFIGURATION >
PTP1 AMT ADDRESS1 - PTP AMT ADDRESS8

Parameters

000.000.000.000 - 255.255.255.255

Initial value

000.000.000.000

13.3.16 Setting the Asymmetric Delay

To correct the phase, follow the procedure below.

```
3 . P T P 1   A S Y M   D E L A Y
0 . 0 0 0   u s e c
```

Procedure

PTP CONFIG > PTP1 > DETAIL SETTING > ASYMMETRIC DELAY

Parameters

±20.000 usec

Initial value

0.000 usec

14 IP CONFIG MENU (SER04)

The IP CONFIG menu is used to specify settings related to IP output.

To display the IP CONFIG menu, press CONFIG several times until the following menu appears.

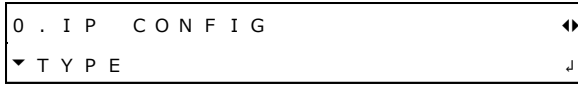

For IP outputs, the patterns specified on the SDI CONFIG menu are output. For details of output patterns, see "12 SDI CONFIG MENU (SER02/SER04)".

14.1 Selecting the Standard

To select the IP output standard, follow the procedure below.

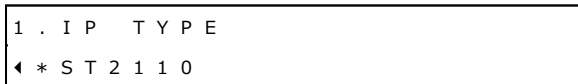

Procedure

IP CONFIG > TYPE

Parameters

ST2022-6:	Outputs signals compliant with SMPTE ST 2022-6.
ST2110:	Outputs signals compliant with SMPTE ST 2110.

Initial value

ST2110

14.2 Turning the IP Output On and Off

To turn the IP output on and off, follow the procedure below.



Procedure

IP CONFIG > IP1 / IP2 > OUTPUT

Parameters

ON / OFF

Initial value

ON

14.3 Turning Video, Audio, and ANC On and Off

To turn the video, audio, and ANC on and off, follow the procedure below.
When TYPE is set to ST2022-6, you can only turn the video on and off.

```
5 . I P 1   S T R E A M 1   V I D
      ■ O N           □ O F F
```

```
5 . I P 1   S T R E A M 1   A U D
      ■ O N           □ O F F
```

```
5 . I P 1   S T R E A M 1   A N C
      ■ O N           □ O F F
```

Procedure

IP CONFIG > IP1 / IP2 > STREAM SETTING > STREAM1 / STREAM2 / STREAM3 / STREAM4 >
VIDEO / AUDIO / ANC > ON / OFF

Parameters

ON / OFF

Initial value

ON

14.4 Setting the Payload Types

When TYPE is set to ST2110, to set the video, audio, and ANC payload types, follow the procedure below.

```
5 . I P 1   S T R E A M 1   V I D   P A Y L D
      9 6
```

```
5 . I P 1   S T R E A M 1   A U D   P A Y L D
      9 7
```

```
5 . I P 1   S T R E A M 1   A N C   P A Y L D
      1 0 0
```

Procedure

IP CONFIG > IP1 / IP2 > STREAM SETTING > STREAM1 / STREAM2 / STREAM3 / STREAM4 >
VIDEO / AUDIO / ANC > PAYLOAD TYPE

Parameters

96 - 127

Initial value

96 (VIDEO)

97 (AUDIO)

100 (ANC)

14.5 Configuring VLAN

14.5.1 Turning the VLAN Signals On and Off

To turn the video, audio, and ANC VLANs (Virtual Local Area Networks) on and off, follow the procedure below.

When TYPE is set to ST2022-6, you can turn only the video VLAN on and off.

6 . I P 1	S T R E A M 1	V I D	V L A N
		<input type="checkbox"/> O N	<input checked="" type="checkbox"/> O F F

6 . I P 1	S T R E A M 1	A U D	V L A N
		<input type="checkbox"/> O N	<input checked="" type="checkbox"/> O F F

6 . I P 1	S T R E A M 1	A N C	V L A N
		<input type="checkbox"/> O N	<input checked="" type="checkbox"/> O F F

Procedure

IP CONFIG > IP1 / IP2 > STREAM SETTING > STREAM1 / STREAM2 / STREAM3 / STREAM4 > VIDEO / AUDIO / ANC > VLAN > ON/OFF

Parameters

ON / OFF

Initial value

OFF

14.5.2 Setting the VLAN Tags

To set the video, audio, and ANC VLAN (Virtual Local Area Network) tags, follow the procedure below.

When TYPE is set to ST2022-6, you can set only the video VLAN tag.

6 . I P 1	S T R E A M 1	V I D	V L A N
		1	

6 . I P 1	S T R E A M 1	A U D	V L A N
		1	

6 . I P 1	S T R E A M 1	A N C	V L A N
		1	

Procedure

IP CONFIG > IP1 / IP2 > STREAM SETTING > STREAM1 / STREAM2 / STREAM3 / STREAM4 > VIDEO / AUDIO / ANC > VLAN > VLAN TAG

Parameters

1 - 4094

Initial value

1

14.6 Configuring DSCP

14.6.1 Turning the DSCP On and Off

To turn the video, audio, and ANC DSCPs (Differentiated Services Code Points) on and off, follow the procedure below.

When TYPE is set to ST2022-6, you can turn only the video DSCP on and off.

6 . I P 1	S T R E A M 1	V I D	D S C P
		<input type="checkbox"/> O N	<input checked="" type="checkbox"/> O F F

6 . I P 1	S T R E A M 1	A U D	D S C P
		<input type="checkbox"/> O N	<input checked="" type="checkbox"/> O F F

6 . I P 1	S T R E A M 1	A N C	D S C P
		<input type="checkbox"/> O N	<input checked="" type="checkbox"/> O F F

Procedure

IP CONFIG > IP1 / IP2 > STREAM SETTING > STREAM1 / STREAM2 / STREAM3 / STREAM4 > VIDEO / AUDIO / ANC > DSCP > ON/OFF

Parameters

ON / OFF

Initial value

OFF

14.6.2 Setting the DSCP Tags

To set the video, audio, and ANC DSCP (Differentiated Services Code Point) tags, follow the procedure below.

When TYPE is set to ST2022-6, you can set only the video DSCP tag.

6 . I P 1	S T R E A M 1	V I D	D S C P
0			

6 . I P 1	S T R E A M 1	A U D	D S C P
0			

6 . I P 1	S T R E A M 1	A N C	D S C P
0			

Procedure

IP CONFIG > IP1 / IP2 > STREAM SETTING > STREAM1 / STREAM2 / STREAM3 / STREAM4 > VIDEO / AUDIO / ANC > DSCP > DSCP TAG

Parameters

0 - 63

Initial value

0

14.7 Setting the Destination IP Addresses

To set the video, audio, and ANC destination IP addresses, follow the procedure below.
When TYPE is set to ST2022-6, you can set only the video IP address.

```
5 . I P 1   S T R E A M 1   V I D   D S T I P
2 3 9 . 0 0 0 . 0 0 0 . 0 0 1
```

```
5 . I P 1   S T R E A M 1   A U D   D S T I P
2 3 9 . 0 0 0 . 0 0 2 . 0 0 1
```

```
5 . I P 1   S T R E A M 1   A N C   D S T I P
2 3 9 . 0 0 0 . 0 0 3 . 0 0 1
```

Procedure

IP CONFIG > IP1 / IP2 > STREAM SETTING > STREAM1 / STREAM2 / STREAM3 / STREAM4 >
VIDEO / AUDIO / ANC > DESTINATION IP ADDRESS

Parameters

000.000.000.000 - 255.255.255.255

Initial value

239.000.000.001 (IP1 / STREAM1 / VIDEO)	239.000.000.005 (IP2 / STREAM1 / VIDEO)
239.000.000.002 (IP1 / STREAM2 / VIDEO)	239.000.000.006 (IP2 / STREAM2 / VIDEO)
239.000.000.003 (IP1 / STREAM3 / VIDEO)	239.000.000.007 (IP2 / STREAM3 / VIDEO)
239.000.000.004 (IP1 / STREAM4 / VIDEO)	239.000.000.008 (IP2 / STREAM4 / VIDEO)
239.000.002.001 (IP1 / STREAM1 / AUDIO)	239.000.002.005 (IP2 / STREAM1 / AUDIO)
239.000.002.002 (IP1 / STREAM2 / AUDIO)	239.000.002.006 (IP2 / STREAM2 / AUDIO)
239.000.002.003 (IP1 / STREAM3 / AUDIO)	239.000.002.007 (IP2 / STREAM3 / AUDIO)
239.000.002.004 (IP1 / STREAM4 / AUDIO)	239.000.002.008 (IP2 / STREAM4 / AUDIO)
239.000.003.001 (IP1 / STREAM1 / ANC)	239.000.003.005 (IP2 / STREAM1 / ANC)
239.000.003.002 (IP1 / STREAM2 / ANC)	239.000.003.006 (IP2 / STREAM2 / ANC)
239.000.003.003 (IP1 / STREAM3 / ANC)	239.000.003.007 (IP2 / STREAM3 / ANC)
239.000.003.004 (IP1 / STREAM4 / ANC)	239.000.003.008 (IP2 / STREAM4 / ANC)

14.8 Setting the Destination Port Numbers

To set the video, audio, and ANC destination port numbers, follow the procedure below. When TYPE is set to ST2022-6, you can set only the video port number.

```
5 . I P 1   S T R E A M 1   V I D   D S T P T
      5 0 0 4
```

```
5 . I P 1   S T R E A M 1   A U D   D S T P T
      5 0 0 4
```

```
5 . I P 1   S T R E A M 1   A N C   D S T P T
      5 0 0 4
```

Procedure

IP CONFIG > IP1 / IP2 > STREAM SETTING > STREAM1 / STREAM2 / STREAM3 / STREAM4 > VIDEO / AUDIO / ANC > DESTINATION PORT

Parameters

0 - 65535

Initial value

5004

14.9 Selecting the Audio Standard

When TYPE is set to ST2110, to select the audio output standard, follow the procedure below.

```
5 . I P 1   S T R E A M 1   A U D   M O D E
▶ * S T 2 1 1 0 - 3 0
```

Procedure

IP CONFIG > IP1 / IP2 > STREAM SETTING > STREAM1 / STREAM2 / STREAM3 / STREAM4 > AUDIO > MODE

Parameters

ST2110-30 / ST2110-31

Initial value

ST2110-30

14.10 Selecting the Audio Packet Time

When TYPE is set to ST2110, to select the audio output packet time, follow the procedure below.

```
5 . I P 1   S T R E A M 1   A U D   T I M E
▶ * 1 m s
```

Procedure

IP CONFIG > IP1 / IP2 > STREAM SETTING > STREAM1 / STREAM2 / STREAM3 / STREAM4 > AUDIO > PACKET TIME

Parameters

1ms / 125us

Initial value

1ms

15 SYSTEM CONFIG MENU

The SYSTEM CONFIG menu is used to specify settings related to the instrument.

To display the SYSTEM CONFIG menu, press CONFIG several times until the following menu appears.

These settings are not stored to presets.

```
0 . SYSTEM CONFIG      ◀▶
▼ LCD BACKLIGHT      ↓
```

15.1 Setting the Backlight

To set the backlight, follow the procedure below.

```
1 . LCD BACKLIGHT
■ ON   □ AUTO OFF □ OFF
```

Procedure

SYSTEM CONFIG > LCD BACKLIGHT

Parameters

ON:	The backlight is on at all times.
AUTO OFF:	The backlight turns off if none of the keys are used for 30 seconds. It turns back on when a key is used.
OFF:	The backlight is off at all times.

Initial value

ON

15.2 Configuring Presets

Under PRESET on the SYSTEM CONFIG menu, you can configure presets.

A preset is a collection of instrument settings that are registered. It can be recalled automatically when the instrument starts.

```
0 . SYSTEM CONFIG      ◀▶
◆ PRESET                ↓
```

The following items are not stored in preset settings.

- SDI CONFIG > User patterns saved in the instrument (INT1 - INT4)
- SDI CONFIG > ID characters saved in the instrument (INT1 - INT4)
- SDI CONFIG > Logos stored in the instrument (INT1 - INT4)
- Settings of the SYSTEM CONFIG menu

15.2.1 Recalling Presets

To recall a preset that has been stored with the STORE menu, follow the procedure below.

Procedure

SYSTEM CONFIG > PRESET > RECALL

To recall a preset, follow the procedure below.

1. Select a preset number.

Select a number from NUMBER 0 to NUMBER 9.

If a comment was added on the COMMENT INPUT menu, the comment is also displayed.

With no comment

```
2 . R E C A L L
▶ N U M B E R   0
```

With a comment

```
2 . R E C A L L   N U M B E R   0
▶ N A M E [ R E F = B B , T I M E = G N S S ]
```

2. Select OK.

```
3 . R E C A L L   N U M B E R   0
   ■ O K           □ C A N C E L
```

15.2.2 Storing Presets

You can save up to 10 presets by following the procedure below.

Procedure

SYSTEM CONFIG > PRESET > STORE

To store a preset, follow the procedure below.

1. Select a preset number.

Select a number from NUMBER 0 to NUMBER 9.

```
2 . S T O R E
▶ N U M B E R   0
```

2. Select OK.

```
3 . S T O R E   N U M B E R   0
   ■ O K           □ C A N C E L
```

If the preset is already stored, an overwrite confirmation message is displayed.

To overwrite it, select OK. Otherwise, select CANCEL.

```
3 . N U M B E R   0   O V E R   W R I T E   ?
   ■ O K           □ C A N C E L
```

15.2.3 Adding a Comment

To add a comment to a preset stored with the STORE menu, follow the procedure below. The comment added here can be displayed when you recall the preset with the RECALL menu or when you copy it from the instrument to a USB memory device.

Procedure

SYSTEM CONFIG > PRESET > POWER ON RECALL

Parameters

◀ 0 1 2 3 4 5 6 7 8 9 A B C D E F G H I J K L M N O P Q R S T U V W X Y Z
a b c d e f g h i j k l m n o p q r s t u v w x y z ! # \$ % & ' () + , - . ; = @ [] ^ _ { }

Initial value

◀

To enter a comment, follow the procedure below.

1. Select a preset number.

Select a number from NUMBER 0 to NUMBER 9.

```
2 . C O M M E N T   I N P U T
▶ N U M B E R   0
```

2. Enter a comment.

You can enter up to 17 characters.

Enter ◀ to clear the characters that follow it. In this case, ◀ is not included in the comment. Enter only ◀ to erase the comment.

```
3 . C O M M E N T   I N P U T   N U M B E R   0
R E F = B B , T I M E = G N S S ◀
```

15.2.4 Power-on Settings

To select the settings to use for starting the instrument, follow the procedure below.

```
2 . P O W E R   O N   R E C A L L
▶ * O F F
```

Procedure

SYSTEM CONFIG > PRESET > POWER ON RECALL

Parameters

OFF: The instrument starts with the same settings that were set when it was last turned OFF.
NUMBER 0 to NUMBER 9: The instrument starts with the selected preset.

Initial value

OFF

15.2.5 Copying Presets from a USB Memory Device to the Instrument

To copy presets from a USB memory device to the instrument, follow the procedure below. This feature is useful when you want to use multiple instruments with the same settings. (Copy the presets to the USB memory device in advance by using the COPY INT→USB menu.)

If there is already a preset stored in the instrument, it will be overwritten.
This setting appears when a USB memory device is connected.

Procedure

SYSTEM CONFIG > PRESET > COPY USB→INT

To copy a preset, follow the procedure below.

1. Select the copy source in the USB memory device.

Select ALL or a number from NUMBER 0 to NUMBER 9.

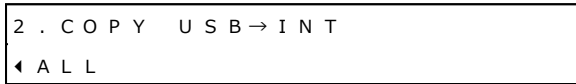

2. Select OK.

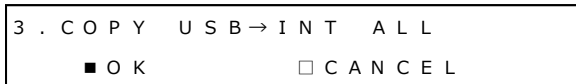

● **USB Memory Device Structure**

Presets are copied from the PSET folder of the USB memory device.

The "_****" portion of each file name is added if you add a comment to the preset.

Note that if you use a PC to edit the name of a file, you will no longer be able to copy the file.

- USB memory device
 - └─ ■ LT4670_USER
 - └─ ■ PSET
 - └─ ■ PRESET_00_****.PRE
 - | :
 - └─ ■ PRESET_09_****.PRE

15.2.6 Copying Presets from the Instrument to a USB Memory Device

To copy presets in a dedicated format (.PRE) from the instrument to a USB memory device, follow the procedure below. This feature is useful when you want to use multiple instruments with the same settings. (Save the presets in the instrument in advance by using the STORE menu.)

If there is already a preset with the same number in the USB memory device, it will be overwritten. (It will be overwritten even if the comment is different.)

This setting appears when a USB memory device is connected.

Procedure

SYSTEM CONFIG > PRESET > COPY INT→USB

To copy a preset, follow the procedure below.

1. Select the copy source in the instrument.

Select ALL or a number from NUMBER 0 to NUMBER 9.

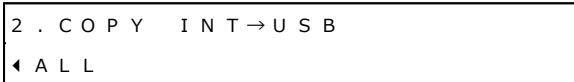

2. Select OK.



● **USB Memory Device Structure**

Presets are copied from the PSET folder of the USB memory device.

The date and time of the file will be the date and time selected with TIME SOURCE on the REFERENCE CONFIG menu.

The "_****" portion of each file name is added if you add a comment to the preset.

- USB memory device
 - └─ ■ LT4670_USER
 - └─ ■ PSET
 - └─ ■ PRESET_00_****.PRE
 - | :
 - └─ ■ PRESET_09_****.PRE

15.2.7 Clearing Presets

To clear presets stored in the instrument, follow the procedure below.

Procedure

SYSTEM CONFIG > PRESET > DELETE

To clear a preset, follow the procedure below.

1. Select the preset to clear.

Select ALL or a number from NUMBER 0 to NUMBER 9.



2. Select OK.



15.3 Setting the Network

Under NETWORK on the SYSTEM CONFIG menu, you can set the network function.



15.3.1 Setting the Network

To select whether to enable the network function, follow the procedure below.



Procedure

SYSTEM CONFIG > NETWORK > NETWORK SETUP

Parameters

ENABLE / DISABLE

Initial value

ENABLE

15.3.2 Setting the IP Address

To set the IP address, follow the procedure below.

```
3 . I P   A D D R E S S
1 9 2 . 1 6 8 . 0 0 0 . 0 0 1
```

Procedure

SYSTEM CONFIG > NETWORK > ETHERNET > IP ADDRESS

Parameters

000.000.000.000 - 255.255.255.255

Initial value

192.168.000.001

15.3.3 Setting the Subnet Mask

To set the subnet mask, follow the procedure below.

```
3 . S U B N E T   M A S K
2 5 5 . 2 5 5 . 2 5 5 . 0 0 0
```

Procedure

SYSTEM CONFIG > NETWORK > ETHERNET > SUBNET MASK

Parameters

000.000.000.000 - 255.255.255.255

Initial value

255.255.255.000

15.3.4 Setting the Default Gateway

To set the default gateway, follow the procedure below.

```
3 . D E F A U L T   G A T E W A Y
0 0 0 . 0 0 0 . 0 0 0 . 0 0 0
```

Procedure

SYSTEM CONFIG > NETWORK > ETHERNET > DEFAULT GATEWAY

Parameters

000.000.000.000 - 255.255.255.255

Initial value

000.000.000.000

15.3.5 Configuring SNMP

To select whether to enable or disable the SNMP function and select which version to support, follow the procedure below.

```
3 . S N M P   S E T U P
    ■ D I S A B L E   □ V 2 C   □ V 3
```

Procedure

SYSTEM CONFIG > NETWORK > SNMP > SNMP SETUP

Parameters

DISABLE:	The SNMP function is disabled.
V2C:	The SNMP function is enabled and V2C is supported.
V3:	The SNMP function is enabled and V3 is supported.

Initial value

DISABLE

15.3.6 Displaying the SNMP Engine ID

When SNMP SETUP is V3, to display the SNMP engine ID, follow the procedure below.

```
3 . S N M P   E N G I N E   I D
0 x 0 0 0 0 0 0 0 0 0 0 0 0 0 0 0 0 0 0 0 0 0 0 0 0 0 0 0 0 0 0 0 0
```

Procedure

SYSTEM CONFIG > NETWORK > SNMP > SNMP ENGINE ID

15.3.7 Setting the SNMP Trap Transmission Destinations

To select whether to enable the four SNMP trap transmission destinations, follow the procedure below.

To alleviate communication load, disable the transmission destinations that you are not using.

```
3 . S N M P   T R A P   1
    □ E N A B L E   ■ D I S A B L E
```

Procedure

SYSTEM CONFIG > NETWORK > SNMP > SNMP TRAP 1 - SNMP TRAP 4

Parameters

ENABLE / DISABLE

Initial value

DISABLE

15.3.8 Setting the IP Addresses of the SNMP Trap Transmission Destinations

To set the IP addresses of the four SNMP trap transmission destinations, follow the procedure below.

```
3 . S N M P   M A N A G E R   I P   1
   0 0 0 . 0 0 0 . 0 0 0 . 0 0 0
```

Procedure

SYSTEM CONFIG > NETWORK > SNMP > SNMP MANAGER IP 1 - SNMP MANAGER IP 4

Parameters

000.000.000.000 - 255.255.255.255

Initial value

000.000.000.000

15.3.9 Copying MIB Files from the Instrument to a USB Memory Device

To copy a MIB file from the instrument to a USB memory device, select ON by following the procedure below.

If there is already a MIB file stored in the USB memory device, it will be overwritten. This setting appears when a USB memory device is connected.

```
3 . C O P Y   M I B   I N T → U S B
    O K            C A N C E L
```

Procedure

SYSTEM CONFIG > NETWORK > SNMP > COPY MIB INT→USB

● **USB Memory Device Structure**

The MIB file is saved in the MIB folder of the USB memory device.

The date and time of the file will be the date and time selected with TIME SOURCE on the REFERENCE CONFIG menu.

- USB memory device
 - └ ■ LT4670_USER
 - └ ■ MIB
 - └ ■ lt4670.my

15.3.10 Setting the SNMP Community Names

When SNMP SETUP is V2C, to change each SNMP community name, follow the procedure below.

You can enter up to 15 characters. Enter ◀ to clear the characters that follow it. In this case, ◀ is not included in the community name.

When SNMP SETUP is V3, to display each SNMP community name, follow the procedure below. You cannot change it.

Changes to community names are applied when SNMP RESTART is executed or the next time the power is turned on.

4 . R E A D C O M M U N I T Y L D R U s e r ◀
4 . W R I T E C O M M U N I T Y L D R A d m ◀
4 . T R A P C O M M U N I T Y L D R U s e r ◀

Procedure

SYSTEM CONFIG > NETWORK > SNMP > SNMP COMMUNITY
 > READ COMMUNITY
 > WRITE COMMUNITY
 > TRAP COMMUNITY

Parameters

◀ 0 1 2 3 4 5 6 7 8 9 A B C D E F G H I J K L M N O P Q R S T U V W X Y Z
 a b c d e f g h i j k l m n o p q r s t u v w x y z

Initial value

LDRUser◀ (V2C, READ COMMUNITY)
 LDRAdm◀ (V2C, WRITE COMMUNITY)
 LDRUser◀ (V2C, TRAP COMMUNITY)
 LDuser (V3, READ COMMUNITY)
 LDadm (V3, WRITE COMMUNITY)
 LDuser (V3, TRAP COMMUNITY)

15.3.11 Restarting SNMP

When SNMP SETUP is V2C or V3, to restart SNMP, select OK by following the procedure below. Do so after changing community names, for example.

4 . S N M P R E S T A R T <input type="checkbox"/> O K <input checked="" type="checkbox"/> C A N C E L

Procedure

SYSTEM CONFIG > NETWORK > SNMP > SNMP COMMUNITY > SNMP RESTART

15.3.12 Configuring HTTP

To select whether to enable the HTTP function, follow the procedure below.

```

3 . H T T P   S E T U P
    E N A B L E    D I S A B L E
    
```

Procedure

SYSTEM CONFIG > NETWORK > HTTP > HTTP SETUP

Parameters

ENABLE / DISABLE

Initial value

DISABLE

15.3.13 Configuring the Web Browser

To select whether to enable the Web browser function, follow the procedure below.

```

3 . W E B   B R O W S E R
    E N A B L E    D I S A B L E
    
```

Procedure

SYSTEM CONFIG > NETWORK > HTTP > WEB BROWSER

Parameters

ENABLE / DISABLE

Initial value

DISABLE

15.3.14 Configuring NTP

To select whether to enable the NTP function, follow the procedure below.

```

3 . N T P   S E T U P
    E N A B L E    D I S A B L E
    
```

Procedure

SYSTEM CONFIG > NETWORK > NTP > NTP SETUP

Parameters

ENABLE / DISABLE

Initial value

DISABLE

15.3.15 Setting the NTP Server

To set the NTP server address, follow the procedure below.

3 . N T P S E R V E R A D D R E S S
0 0 0 . 0 0 0 . 0 0 0 . 0 0 0

Procedure

SYSTEM CONFIG > NETWORK > NTP > NTP SERVER ADDRESS

Parameters

000.000.000.000 - 255.255.255.255

Initial value

000.000.000.000

15.4 Setting the Time

Under TIME MANAGEMENT on the SYSTEM CONFIG menu, you can set the time.

```
0 . SYSTEM CONFIG
◆ TIME MANAGEMENT
```

15.4.1 Setting the Date and Time

When TIME SOURCE on the REFERENCE CONFIG menu is set to INTERNAL, to set the internal date and time of the instrument, follow the procedure below.

These settings are not initialized with CLEAR SETTING or DEFAULT SETTING.

```
2 . INTERNAL CLOCK ADJUST
2023 / 04 / 01 00 : 00 : 00
```

Procedure

SYSTEM CONFIG > TIME MANAGEMENT > INTERNAL CLOCK ADJUST

Parameters

2000/01/01 00:00:00 - 2037/12/31 23:59:59

15.4.2 Selecting the Time Zone

To select the time zone, follow the procedure below. Select it according to your region.

```
2 . TIMEZONE OFFSET
◆ * UTC + 09 : 00
```

Procedure

SYSTEM CONFIG > TIME MANAGEMENT > TIMEZONE OFFSET

Parameters

-12:00 / -11:00 / -10:00 / -09:00 / -08:00 / -07:00 / -06:00 / -05:00 / -04:30 / -04:00 /
 -03:00 / -02:00 / -01:00 / +00:00 / +01:00 / +02:00 / +03:00 / +04:00 / +04:30 /
 +05:00 / +05:30 / +06:00 / +07:00 / +08:00 / +09:00 / +09:30 / +10:00 / +11:00 /
 +12:00 / -09:30 / -03:30 / +03:30 / +06:30 / +10:30 / +11:30

Initial value

+09:00

15.4.3 Turning Jam Sync On and Off

To turn the jam sync function on and off, follow the procedure below.
 When set to ON, the time code is reset once a day at the time set on the ADJUST menu.



Procedure

SYSTEM CONFIG > TIME MANAGEMENT > JAM SYNC > ON/OFF

Parameters

ON / OFF

Initial value

ON

15.4.4 Setting the Jam Sync Time

To set when to reset the time code using the jam sync function, follow the procedure below.
 This setting is valid when JAM SYNC is set to ON.



Procedure

SYSTEM CONFIG > TIME MANAGEMENT > JAM SYNC > ADJUST

Parameters

00:00:00 - 23:59:59

Initial value

00:00:00

15.4.5 Turning the Daylight Saving Time On and Off (SER01)

When TIME SOURCE on the REFERENCE CONFIG menu is set to GNSS, to select whether to apply Daylight Saving Time, follow the procedure below.



Procedure

SYSTEM CONFIG > TIME MANAGEMENT > DAYLIGHT SAVING > ON/OFF

Parameters

ON / OFF

Initial value

OFF

15.4.6 Setting the Daylight Saving Time Start Date (SER01)

When TIME SOURCE on the REFERENCE CONFIG menu is set to GNSS, to set the Daylight Saving Time start date, follow the procedure below. (You cannot set seconds.)

```
3 . C H A N G E   D A Y
      0 1 / 0 1   0 0 : 0 0 : 0 0
```

Procedure

SYSTEM CONFIG > TIME MANAGEMENT > DAYLIGHT SAVING > CHANGE DAY

Parameters

01/01 00:00:00 - 12/31 23:59:00

Initial value

01/01 00:00:00

15.4.7 Setting the Daylight Saving Time Offset (SER01)

When TIME SOURCE on the REFERENCE CONFIG menu is set to GNSS, to set the Daylight Saving Time offset, follow the procedure below.

```
3 . T I M E C O D E   O F F S E T
+ 0 0 : 0 0 : 0 0   [ H H : M M : S S ]
```

Procedure

SYSTEM CONFIG > TIME MANAGEMENT > DAYLIGHT SAVING > TIMECODE OFFSET

Parameters

±23:59:59

Initial value

+00:00:00

15.4.8 Setting the Daylight Saving Time End Date (SER01)

When TIME SOURCE on the REFERENCE CONFIG menu is set to GNSS, to set the Daylight Saving Time end date, follow the procedure below. (You cannot set seconds.)

```
3 . R E T U R N   D A Y
      0 1 / 0 1   0 0 : 0 0 : 0 0
```

Procedure

SYSTEM CONFIG > TIME MANAGEMENT > DAYLIGHT SAVING > RETURN DAY

Parameters

01/01 00:00:00 - 12/31 23:59:00

Initial value

01/01 00:00:00

15.4.9 Setting the Leap Second (SER01)

The leap second is automatically inserted to the last time of June 30 or December 31 UTC. When TIME SOURCE on the REFERENCE CONFIG menu is set to GNSS, to set the time by which to delay the time to insert the leap second, follow the procedure below. (You cannot set seconds.)

This function is not applied to PTP.

```
2 . S C H E D U L E D   T I M E
   0 0 : 0 0 : 0 0   [ H H : M M : S S ]
```

Procedure

SYSTEM CONFIG > TIME MANAGEMENT > LEAP SECOND

Parameters

00:00:00 - 23:59:00

Initial value

00:00:00

15.4.10 Setting L-SYNC

To set L-SYNC, follow the procedure below.

[See also] "6.6 L-SYNC"

```
2 . L - S Y N C   S E T U P
▶ * D I S A B L E
```

Procedure

SYSTEM CONFIG > TIME MANAGEMENT > L-SYNC SETUP

Parameters

DISABLE:	The L-SYNC function is disabled.
PRIMARY:	The L-SYNC function is enabled, and the instrument operates as a primary instrument.
BACKUP:	The L-SYNC function is enabled, and the instrument operates as a backup.
	TIME SOURCE is fixed to INTERNAL when REFERENCE SOURCE in the REFERENCE CONFIG menu is set to GENLOCK.

Initial value

DISABLE

15.5 Setting the GNSS (SER01)

Under GNSS OPTION on the SYSTEM CONFIG menu, you can set the GNSS.



15.5.1 Setting the Power Supply

To select the supply voltage to apply to the GNSS antenna, follow the procedure below. Select OFF to select not to supply power.

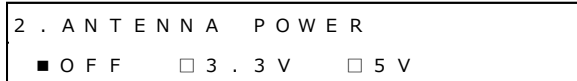

Procedure

SYSTEM CONFIG > GNSS OPTION > ANTENNA POWER

Parameters

OFF / 3.3V / 5V

Initial value

OFF

15.5.2 Setting the Cable Delay

To correct the GNSS cable delay level, follow the procedure below.



Procedure

SYSTEM CONFIG > GNSS OPTION > CABLE DELAY

Parameters

±100 [nsec]

Initial value

0 [nsec]

15.6 Configuring the PTP Settings (SER03)

Under PTP OPTION on the SYSTEM CONFIG menu, you can specify settings related to PTP.

```
0 . S Y S T E M   C O N F I G      ◀▶
◀ P T P   O P T I O N             ↓
```

15.6.1 Setting the IP Address

To set the IP address of the selected PTP, follow the procedure below.

```
3 . P T P 1   I P   A D D R E S S
1 9 2 . 1 6 8 . 0 0 0 . 0 0 1
```

Procedure

SYSTEM CONFIG > PTP OPTION > PTP1 / PTP2 > IP ADDRESS

Parameters

000.000.000.000 - 255.255.255.255

Initial value

192.168.000.001

15.6.2 Setting the Subnet Mask

To set the subnet mask of the selected PTP, follow the procedure below.

```
3 . P T P 1   S U B N E T   M A S K
2 5 5 . 2 5 5 . 2 5 5 . 0 0 0
```

Procedure

SYSTEM CONFIG > PTP OPTION > PTP1 / PTP2 > SUBNET MASK

Parameters

000.000.000.000 - 255.255.255.255

Initial value

255.255.255.000

15.6.3 Setting the Gateway

To set the gateway of the selected PTP, follow the procedure below.

```
3 . P T P 1   G A T E W A Y
  1 9 2 . 1 6 8 . 0 0 0 . 2 5 4
```

Procedure

SYSTEM CONFIG > PTP OPTION > PTP1 / PTP2 > DEFAULT GATEWAY

Parameters

000.000.000.000 - 255.255.255.255

Initial value

192.168.000.254

15.6.4 Configuring SFP

To select the type of the SFP of the selected PTP, follow the procedure below.

Make the selection with the module connected with a cable.

Connection may not be established if the module is inserted or the cable is connected after making the selection.

```
3 . P T P 1   S F P / S F P +
  ◀ * S F P +
```

Procedure

SYSTEM CONFIG > PTP OPTION > PTP1 / PTP2 > SFP/SFP+

Parameters

SFP / SFP+

Initial value

SFP+

15.6.5 Setting Port Mirroring

To select the settings for port mirroring, follow the procedure below.

```
2 . P T P   P O R T   M I R R O R I N G
  ▶ * O F F
```

Procedure

SYSTEM CONFIG > PTP OPTION > PTP PORT MIRRORING

Parameters

OFF:	Port mirroring is not performed.
PTP1 to PTP2:	PTP1 packets are copied and transmitted to PTP2.
PTP2 to PTP1:	PTP2 packets are copied and transmitted to PTP1.

Initial value

OFF

15.7 Setting the IP (SER04)

Under IP OPTION on the SYSTEM CONFIG menu, you can specify settings related to IP.

```
0 . S Y S T E M   C O N F I G
◀ I P   O P T I O N ▶
```

15.7.1 Setting the IP Address

To set the IP address of the selected IP, follow the procedure below.

```
3 . I P 1   I P   A D D R E S S
1 9 2 . 1 6 8 . 0 0 0 . 0 0 1
```

Procedure

SYSTEM CONFIG > IP OPTION > IP1 / IP2 > IP ADDRESS

Parameters

000.000.000.000 - 255.255.255.255

Initial value

192.168.000.001

15.7.2 Setting the Subnet Mask

To set the subnet mask of the selected IP, follow the procedure below.

```
3 . I P 1   S U B N E T   M A S K
2 5 5 . 2 5 5 . 2 5 5 . 0 0 0
```

Procedure

SYSTEM CONFIG > IP OPTION > IP1 / IP2 > SUBNET MASK

Parameters

000.000.000.000 - 255.255.255.255

Initial value

255.255.255.000

15.7.3 Setting the Gateway

To set the gateway of the selected IP, follow the procedure below.

```
3 . I P 1   D E F A U L T   G A T E W A Y
    1 9 2 . 1 6 8 . 0 0 0 . 2 5 4
```

Procedure

SYSTEM CONFIG > IP OPTION > IP1 / IP2 > DEFAULT GATEWAY

Parameters

000.000.000.000 - 255.255.255.255

Initial value

192.168.000.254

15.7.4 Configuring SFP

To select the type of the SFP transceiver used with the selected IP, follow the procedure below. When using SFP+, select 10G, and when using SFP28, select 25G.

```
3 . I P 1   1 0 G / 2 5 G
    * 2 5 G
```

Procedure

SYSTEM CONFIG > IP OPTION > IP1 / IP2 > 10G/25G

Parameters

10G / 25G

Initial value

25G

15.7.5 Turning RS-FEC On and Off

When 10G/25G is set to 25G, to turn the RS-FEC (Reed-Solomon Forward Error Correction) of the selected IP on and off, follow the procedure below.

```
3 . I P 1   R S - F E C
    * O N
```

Procedure

SYSTEM CONFIG > IP OPTION > IP1 / IP2 > RS-FEC

Parameters

OFF / ON

Initial value

ON

15.7.6 Selecting the IGMP Version

To select the IGMP (Internet Group Management Protocol) version of the selected IP, follow the procedure below.

```

3 . I P 1   I G M P
  * A U T O
    
```

Procedure

SYSTEM CONFIG > IP OPTION > IP1 / IP2 > IGMP

Parameters

V2 / V3 / AUTO

Initial value

AUTO

15.8 Setting the Alarm

Under ALARM on the SYSTEM CONFIG menu, you can set the alarm to be output from LTC/REMOTE on the rear panel. INDICATOR 1 and INDICATOR 2 correspond to alarm output 1 and alarm output 2, respectively.

[See also] "6.3.7 LTC Signal I/O and Remote Control"

```

0 . S Y S T E M   C O N F I G      ◀▶
  ◀ A L A R M                       ↓
    
```

15.8.1 Selecting the Polarity

To select the polarity of the alarm output from the selected connector, follow the procedure below.

```

3 . A L A R M   P O L A R I T Y
  ■ P O S I T I V E   □ N E G A T I V E
    
```

Procedure

SYSTEM CONFIG > ALARM > INDICATOR 1 / INDICATOR 2 > ALARM POLARITY

Parameters

POSITIVE / NEGATIVE

Initial value

POSITIVE

15.8.2 Turning the Alarm Output On and Off

To turn on or off the alarm output from the selected connector, follow the procedure below. If any of the alarms that are enabled occurs, an alarm is output.



Procedure

SYSTEM CONFIG > ALARM > INDICATOR 1 / INDICATOR 2 > ALARM OPTION

- > UNIT POWER1: When an error occurs in POWER1
When power supply redundancy is provided and the power is not supplied to POWER1 (SER11)
- > UNIT POWER2: When an error occurs in POWER2 (SER11)
When power supply redundancy is provided and the power is not supplied to POWER2 (SER11)
- > FAN POWER1: When an error occurs in the POWER1 fan
- > FAN POWER2: When an error occurs in the POWER2 fan (SER11)
- > FAN FRONT: When an error occurs in the front fan unit
- > FAN REAR: When an error occurs in the rear fan unit
- > INT PLL: When the crystal inside the instrument becomes fault
- > TIME LAG: When TIME SOURCE on the REFERENCE CONFIG menu is set to LTC, LTC ST309, VITC, VITC ST309, or NTP and the time acquired from TIME SOURCE differs from the internal time by 1 second or more
- > REFERENCE NO SIGNAL: When the set reference signal is not received
- > REFERENCE STAY: When an error occurs in the reference signal, and stay-in-sync is in operation.
- > GNSS ANTENNA: When ANTENNA POWER on the SYSTEM CONFIG menu is set to 3.3V or 5V and a short circuit occurs (SER01)

Parameters

ENABLE / DISABLE

Initial value

DISABLE

15.9 Configuring the Log

Under LOG on the SYSTEM CONFIG menu, you can display and configure the log.

A log is an automatic recording of the status of the instrument or errors that have occurred in the instrument in chronological order.



15.9.1 Viewing the Log

To view the log, follow the procedure below.

Press the ▲ key to view newer log entries, the ▼ key to view older log entries, and the ◀ and ▶ keys to switch between date and time display and log display.

You can view up to 1000 entries from 000 to 999. Subsequent entries that occur overwrite the oldest entries.

The date and time of the log will be the date and time selected with TIME SOURCE on the REFERENCE CONFIG menu.

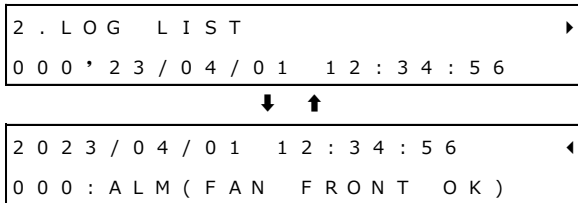

Procedure

SYSTEM CONFIG > LOG > LIST

15.9.2 Copying the Log from the Instrument to a USB Memory Device

To copy the log in txt format from the instrument to a USB memory device, select OK by following the procedure below.

This setting appears when a USB memory device is connected.



Procedure

SYSTEM CONFIG > LOG > COPY INT→USB

- **USB Memory Device Structure**

The log is copied to the LOG folder of the USB memory device.

The date and time of the file will be the date and time selected with TIME SOURCE on the REFERENCE CONFIG menu.

- USB memory device
 - └─ ■ LT4670_USER
 - └─ ■ LOG
 - └─ ■ YYYYMMDDhmmss.txt

● **Log Example**

```
000:2023/06/23 05:13:05 ALM(UNIT POWER2)
001:2023/06/23 05:13:05 ALM(FAN POWER2)
002:2023/06/23 05:13:42 REF SRC(NO SIGNAL)
003:2023/06/23 05:14:00 REF SRC(LOCK)
004:2023/06/23 05:14:14 1PPS CAPTCHA
005:2023/06/23 05:14:16 TIME CAPTCHA
006:2023/06/23 05:17:46 REFERENCE:REFERENCE_SOURCE[GL FMT-AUTO]
007:2023/06/23 05:17:46 REF SRC(TRACKING)
008:2023/06/23 05:17:53 REF SRC(LOCK)[NTSC BB]
```

15.9.3 Clearing the Log

To clear the log, select OK by following the procedure below.

```
2 . D E L E T E   L O G
       O K            C A N C E L
```

Procedure

SYSTEM CONFIG > LOG > DELETE

15.10 Initialization

Under INITIALIZE on the SYSTEM CONFIG menu, you can initialize the settings.

```
0 . S Y S T E M   C O N F I G
  ◆ I N I T I A L I Z E
```

There are two types of initialization: CLEAR SETTING and DEFAULT SETTING. They differ in the settings that are initialized as follows. (○: initialized, ×: not initialized)

Table 15-1 | Initialization

Setting		CLEAR SETTING	DEFAULT SETTING
REFERENCE CONFIG		○	○
BLACK CONFIG		○	○
AUDIO CONFIG		○	○
LTC CONFIG		○	○
CW/1PPS CONFIG		○	○
SDI CONFIG	Other than those below	○	○
	User patterns saved in the instrument (INT1 - INT4)	×	○
	ID characters saved in the instrument (INT1 - INT4)	×	○
	Logos stored in the instrument (INT1 - INT4)	×	○
PTP CONFIG		○	○
IP CONFIG		○	○
SYSTEM CONFIG	Other than those below	×	○
	INTERNAL CLOCK ADJUST	×	×
	FORMAT SETTING	×	×

15.10.1 Initializing the Settings

To initialize the settings except for some settings, select OK by following the procedure below.



Procedure

SYSTEM CONFIG > INITIALIZE > CLEAR SETTING

15.10.2 Factory Default Initialization

To initialize the settings to the factory default settings, select OK by following the procedure below.



Procedure

SYSTEM CONFIG > INITIALIZE > DEFAULT SETTING

15.10.3 Selecting the Initial Value for the Format

To select the format that is applied when CLEAR SETTING or DEFAULT SETTING is used to initialize the instrument, follow the procedure below.



Procedure

SYSTEM CONFIG > INITIALIZE > FORMAT SETTING

Parameters

NTSC / PAL

Initial value

NTSC

The initial value varies according to the setting made here.

Table 15-2 | Initial value

Setting	FORMAT SETTING	
	NTSC	PAL
REFERENCE CONFIG > GENLOCK FORMAT	NTSC BB	PAL BB
BLACK CONFIG > BLACK* > FORMAT	NTSC BB	PAL BB
LTC CONFIG > LTC OUTPUT > LTC* > FORMAT	29.97 fps	25 fps
SDI CONFIG > SDI FREQUENCY GROUP (SER02/SER04)	59.94Hz	60/50Hz
SDI CONFIG > SDI* > FORMAT > RATE (SER02/SER04)	59.94I	50I

15.11 Viewing and Adding Software Options

Under LICENSE INFO. on the SYSTEM CONFIG menu, you can view and add software options.

```
0 . S Y S T E M   C O N F I G      ◀▶
◀ L I C E N S E   I N F O .      ↓
```

15.11.1 Viewing Software Options

To view the software options that have been added, follow the procedure below.
Only the software options that have been added are displayed.

```
1 . L I C E N S E   I N F O .
▼ S E R 2 1 : 4 K
```

Procedure

SYSTEM CONFIG >LICENSE INFO.

15.11.2 Adding Software Options

To add software options, follow the procedure below.
Enter the issued license key and then press the ENTER key.

When the add operation completes, "Accepted." is displayed.
If "Failed." is displayed, retry from the entry of the license key.

```
2 . L I C E N S E   K E Y   I N P U T
0 0 0 0 0 0 0 0 0 0
↓
2 . L I C E N S E   K E Y   I N P U T
A c c e p t e d .
```

Procedure

SYSTEM CONFIG >LICENSE INFO. > LICENSE KEY INPUT

15.12 Configuring USB

To select whether to enable the USB function on the front panel, follow the procedure below.

```
1 . U S B   D E V I C E
    ■ E N A B L E   □ D I S A B L E
```

Procedure

SYSTEM CONFIG > USB DEVICE

Parameters

ENABLE / DISABLE

Initial value

ENABLE

15.13 Turning the Fans On and Off

To turn each of the fans of the front and rear fan units, follow the procedure below.

You may turn off the fans only when performing maintenance tasks such as unit replacement; usually, use the instrument by keeping the fans on at all times.

[See also] "19.2.2 Front Fan Unit Replacement" "19.2.3 Rear Fan Unit Replacement"

```
2 . F A N   M A I N T E N A N C E   F R O N T
    ■ O N   □ O F F
```

Procedure

SYSTEM CONFIG > FAN MAINTENANCE
> FRONT
> REAR

Parameters

ON / OFF

Initial value

ON

15.14 Copying the System Settings

Under SYSTEM COPY on the SYSTEM CONFIG menu, you can copy system settings. This feature is useful when you want to use multiple instruments with the same settings.



The system settings include the following:

- Settings of the SYSTEM CONFIG menu
- Preset (0 - 9)
- ID character (INT1 - INT4)
- Logo (INT1 - INT4)

15.14.1 Copying System Settings from a USB Memory Device to the Instrument

To copy system settings from a USB memory device to the instrument, select OK by following the procedure below. (Copy system settings to the USB memory device in advance by using the COPY INT→USB menu.)



Procedure

SYSTEM CONFIG > SYSTEM COPY > COPY USB→INT

● USB Memory Device Structure

System settings are copied from the ID folder, LOGO folder, PSET folder, and SYS folder of the USB memory device.

- USB memory device
 - └─ ■ LT4670_USER
 - └─ ■ ID
 - └─ ■ LOGO
 - └─ ■ PSET
 - └─ ■ SYS

15.14.2 Copying System Settings from the Instrument to a USB Memory Device

To copy system settings from the instrument to a USB memory device, select OK by following the procedure below.

2 . S Y S C O P Y I N T → U S B
<input checked="" type="checkbox"/> O K <input type="checkbox"/> C A N C E L

 Procedure

 SYSTEM CONFIG > SYSTEM COPY > COPY INT→USB

- **USB Memory Device Structure**

System settings are copied to the ID folder, LOGO folder, PSET folder, and SYS folder of the USB memory device.

The date and time of the file will be the date and time selected with TIME SOURCE on the REFERENCE CONFIG menu.

- USB memory device
 - └─ ■ LT4670_USER
 - ├─ ■ ID
 - ├─ ■ LOGO
 - ├─ ■ PSET
 - └─ ■ SYS

16 STATUS MENU

The STATUS menu shows the instrument status.
To display the STATUS menu, press the STATUS key.

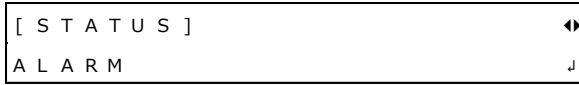

16.1 ALARM Menu

ALARM on the STATUS menu shows the details of the alarms that have occurred.
To display the ALARM menu, press STATUS several times until the following menu appears.
If no alarms have occurred, the ALARM menu itself is not displayed.



If multiple alarms have occurred, you can use the ◀ and ▶ keys to switch from the description of one alarm to that of another.



Displayable alarms are listed below.

Table 16-1 | Alarm display

Alarm	Alarm Condition
FAN FRONT	When an error occurs in the front fan unit
FAN REAR	When an error occurs in the rear fan unit
FAN POWER1	When an error occurs in the POWER1 fan
FAN POWER2	When an error occurs in the POWER2 fan (SER11)
UNIT POWER1	When an error occurs in POWER1 When power supply redundancy is provided and the power is not supplied to POWER1 (SER11)
UNIT POWER2	When an error occurs in POWER2 (SER11) When power supply redundancy is provided and the power is not supplied to POWER2 (SER11)
INT PLL	When the crystal inside the instrument becomes fault
GNSS ANTENNA	When ANTENNA POWER on the SYSTEM CONFIG menu is set to 3.3V or 5V and a short circuit occurs (SER01)

16.2 INFORMATION Menu

INFORMATION on the STATUS menu shows the instrument status.

To display the INFORMATION menu, press STATUS several times until the following menu appears.

```
[ S T A T U S ]      ◀▶
I N F O R M A T I O N  ↓
```

Table 16-2 | INFORMATION menu

Item	Description
[R E F S R C] G L - F M T - (A) ◀▶ L O C K ↓	The reference signal type is displayed in the top row, and the lock status is displayed in the bottom row. When REFERENCE SOURCE is set to INTERNAL, "INTERNAL" is displayed in the bottom row.
[G E N L O C K F O R M A T] ◀▶ N T S C B B ↓	When REFERENCE SOURCE is set to GENLOCK FMT-AUTO, the input signal format is displayed.
[A T T E N T I O N] G N S S ◀▶ L E A P - S E C O N D ↓	Displayed when REFERENCE SOURCE is set to GNSS and leap second information cannot be received. (SER01)
[S A T E L L I T E U S E D] ◀▶ G P : 4 G L : 3 G A : 2 G B : 1 ↓	When REFERENCE SOURCE is set to GNSS, the number of effective satellites is displayed. An example displayed when GNSS SATELLITE is set to ALL is shown on the left. The details are as below. (SER01) GP: Number of GPS + QZSS satellites GL: Number of GLONASS satellites GA: Number of GALILEO satellites GB: Number of BDS satellites
[G P S C / N 0 [d B H z]] ◀▶ ▼ G 1 : 3 9 G 1 7 : 3 9 G 2 0 : 3 9 ↓	When REFERENCE SOURCE is set to GNSS, C/N0 is displayed for each satellite. When the number of effective satellites is 4 or greater, you can use the ▲ and ▼ keys to switch between satellites. When the number of effective satellites is 0, "Satellite not visible." is displayed. (SER01)
[G L O N A S S C / N 0 [d B H z]] ◀▶ R 6 : 2 6 R 8 : 3 5 R 1 2 : 2 1 ↓	
[G A L I L E O C / N 0 [d B H z]] ◀▶ E 6 : 2 6 E 8 : 3 5 ↓	
[B D S C / N 0 [d B H z]] ◀▶ B 6 : 2 6 ↓	
[Q Z S S C / N 0 [d B H z]] ◀▶ S a t e l l i t e n o t v i s i b l e . ↓	
[P T P 1 L E A D E R I D] ◀▶ 0 0 0 0 0 0 0 0 0 0 0 0 0 0 0 0 ↓	
[P T P 2 L E A D E R I D] ◀▶ 0 0 0 0 0 0 0 0 0 0 0 0 0 0 0 0 ↓	

16 STATUS MENU

Item	Description
<pre>[P T P 1 P H A S E] 1 . 2 3 4 n s</pre>	<p>When REFERENCE SOURCE is set to PTP, the phase difference from the leader is displayed. (SER03)</p>
<pre>[U T C T I M E] 2 0 2 3 / 0 4 / 0 1 1 2 : 3 4 : 5 6</pre>	<p>When TIME SOURCE is set to NTP, GNSS (SER01), or PTP (SER03), the Coordinated Universal Time loaded from TIME SOURCE is displayed.</p>
<pre>[L O C A L T I M E] 2 0 2 3 / 0 4 / 0 1 1 2 : 3 4 : 5 6</pre>	<p>The internal clock of the instrument is displayed.</p>
<pre>[T I M E S O U R C E] I N T E R N A L 2 0 2 3 / 0 4 / 0 1 1 2 : 3 4 : 5 6</pre>	<p>The date and time selected with TIME SOURCE on the REFERENCE CONFIG menu is displayed.</p>
<pre>[T I M E S O U R C E] L T C 1 2 : 3 4 : 5 6 2 9 . 9 7 f p s D F</pre>	<p>When TIME SOURCE is set to LTC, the time, transmission rate, and whether there is a dropped frame (DF) are displayed.</p>
<pre>[T I M E S O U R C E] L T C S T 3 0 9 2 0 2 3 / 0 4 / 0 1 1 2 : 3 4 : 5 6 [T I M E S O U R C E] L T C S T 3 0 9 2 9 . 9 7 f p s D F T Z : U T C + 0 9 : 0 0</pre>	<p>When TIME SOURCE is set to LTC ST309, the date and time, transmission rate, whether there is a dropped frame (DF), and time zone (TZ) are displayed.</p>
<pre>[T I M E S O U R C E] V I T C 1 2 : 3 4 : 5 6 1 4 L 2 9 . 9 7 f p s D F</pre>	<p>When TIME SOURCE is set to VITC, the time, superimposed line, transmission rate, and whether there is a dropped frame (DF) are displayed.</p>
<pre>[T I M E S O U R C E] V I T C S T 3 0 9 2 0 2 3 / 0 4 / 0 1 1 2 : 3 4 : 5 6 1 4 L [T I M E S O U R C E] V I T C S T 3 0 9 2 9 . 9 7 f p s D F T Z : U T C + 0 9 : 0 0</pre>	<p>When TIME SOURCE is set to LTC ST309, the date and time, superimposed line, transmission rate, whether there is a dropped frame (DF), and time zone (TZ) are displayed.</p>
<pre>[T I M E S O U R C E] G N S S - - - - -</pre>	<p>If the time cannot be acquired, "-----" is displayed.</p>
<pre>[P T P O U T P U T] P T P 1 L E A D E R</pre>	<p>When PTP1 MODE on the PTP CONFIG menu is set to ENABLE LEADER, the output status is displayed. (SER03)</p>
<pre>[P T P O U T P U T] P T P 2 L E A D E R</pre>	<p>When PTP2 MODE on the PTP CONFIG menu is set to ENABLE LEADER, the output status is displayed. (SER03)</p>

16.3 CONFIG Menu

CONFIG on the STATUS menu shows the instrument settings.

To display the CONFIG menu, press STATUS several times until the following menu appears.

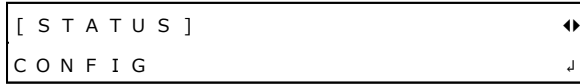

16.3.1 REFERENCE Menu

REFERENCE on the CONFIG menu shows settings related to the reference signal that have been specified on the REFERENCE CONFIG menu.

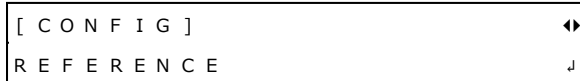

Table 16-3 | REFERENCE menu

Item	Description
[REFERENCE SOURCE] INTERNAL	The reference signal selected with REFERENCE SOURCE is displayed.
[GENLOCK FORMAT] NTSC BB	When REFERENCE SOURCE is set to GENLOCK FMT-MANUAL, the genlock format selected with GENLOCK FORMAT is displayed.
[GENLOCK TIMING] OFN	When REFERENCE SOURCE is set to GENLOCK, the timing set with GENLOCK TIMING FINE is displayed.
[GNSS SATELLITE] ALL	When REFERENCE SOURCE is set to GNSS, the satellite selected with GNSS SATELLITE is displayed. (SER01)
[RECOVERY / TRACKING] FAST	When REFERENCE SOURCE is set to an option other than INTERNAL, the relock speed selected with AUTO SETTING or MANUAL SETTING is displayed.
[TIME SOURCE] INTERNAL	The time source selected with TIME SOURCE is displayed.

16.3.2 BLACK Menu

BLACK on the CONFIG menu shows settings related to the black output that have been specified on the BLACK CONFIG menu.

```
[ C O N F I G ]
B L A C K
```

Table 16-4 | BLACK menu

Item	Description
[B L A C K 1 F O R M A T] N T S C B B	The BLACK1 format selected with FORMAT is displayed. The same holds true for BLACK2 to BLACK6.
[B L A C K 1 T I M I N G] O F O L O D	The BLACK1 timing set with FRAME, VERTICAL, and HORIZONTAL is displayed. The same holds true for BLACK2 to BLACK6.

16.3.3 GNSS Menu (SER01)

GNSS on the CONFIG menu shows settings related to the GNSS option.

```
[ C O N F I G ]
G N S S ( S E R 0 1 )
```

Table 16-5 | GNSS menu

Item	Description
[G N S S A N T E N N A] O F F	The voltage of the power supplied to the GNSS antenna that has been selected with ANTENNA POWER on the SYSTEM CONFIG menu is displayed.
[S E R 0 1 : 0 0 / 0 0 0 0 0 0 0] G N S S H W : 0 0 0 0 0 0 0 0	The board ID and the serial number are displayed in the top row, and the internal management number is displayed in the bottom row.

16.3.4 SDI Menu (SER02)

SDI on the CONFIG menu shows settings related to the SDI option that have been specified on the SDI CONFIG menu.

```
[ C O N F I G ]
S D I ( S E R 0 2 )
```

Table 16-6 | SDI menu

Item	Description
<pre>[S D I 1 F O R M A T] 1 0 8 0 H D / 5 9 . 9 4 I</pre>	<p>The SDI1 format that has been set with FORMAT is displayed.</p> <p>The same holds true for SDI2 to SDI4.</p>
<pre>[S D I 1 T I M I N G] 0 L 0 D</pre>	<p>The SDI1 timing that has been set with VERTICAL and HORIZONTAL is displayed.</p> <p>The same holds true for SDI2 to SDI4.</p>
<pre>[S E R 0 2 : 0 0 / 0 0 0 0 0 0 0] 1 / 2 C 4 : 0 0 0 0 0 0 0 0 C 5 : 0 0 0 0 0 0 0 0</pre>	<p>The board ID and serial number of SDI 1/2 are displayed in the top row, and the FPGA version is displayed in the bottom row.</p> <p>The same holds true for SDI 3/4.</p>

16.3.5 PTP Menu (SER03)

PTP on the CONFIG menu shows settings related to the PTP option that have been specified on the PTP CONFIG menu.

```
[ C O N F I G ]
P T P   ( S E R 0 3 )
```

Table 16-7 | PTP menu

Item	Description
<pre>[P T P 1 M O D E] E N A B L E L E A D E R</pre>	<p>The PTP1 mode selected with MODE is displayed.</p> <p>The same holds true for PTP2.</p>
<pre>[P T P 1 B M C A] E N A B L E</pre>	<p>The BMCA setting of PTP1 that has been selected with BMCA SETUP is displayed.</p> <p>The same holds true for PTP2.</p>
<pre>[P T P 1 P R O F I L E T Y P E] S T 2 0 5 9</pre>	<p>The PTP1 profile selected with PROFILE is displayed.</p> <p>The same holds true for PTP2.</p>
<pre>[P T P 1 M A C A D D R E S S] 0 0 : 0 0 : 0 0 : 0 0 : 0 0 : 0 0</pre>	<p>The MAC address of PTP1 is displayed.</p> <p>The same holds true for PTP2.</p>
<pre>[P T P 1 I D E N T I T Y] 0 x 0 0 0 0 0 0 0 0 0 0 0 0 0 0 0 0</pre>	<p>The PTP1 ID is displayed.</p> <p>The same holds true for PTP2.</p>
<pre>[S E R 0 3 : 0 0 / 0 0 0 0 0 0 0] R 0 . 0 . 0 : R 0 . 0 . 0</pre>	<p>The board ID and the serial number are displayed in the top row, and the internal management number is displayed in the bottom row.</p>

16.3.6 IP/SDI menu (SER04)

IP/SDI on the CONFIG menu shows settings related to the SDI option that have been specified on the SDI CONFIG menu, as well as settings related to the IP option that have been specified on the IP CONFIG menu.

```
[ C O N F I G ]
I P / S D I   ( S E R 0 4 )
```

Table 16-8 | IP/SDI menu

Item	Description
[S D I 1 F O R M A T] 1 0 8 0 H D / 5 9 . 9 4 I	The SDI1 format that has been set with FORMAT is displayed. The same holds true for SDI2 to SDI4.
[S D I 1 T I M I N G] 0 L 0 D	The SDI1 timing that has been set with VERTICAL and HORIZONTAL is displayed. The same holds true for SDI2 to SDI4.
[I P T Y P E] S T 2 1 1 0	The IP standard selected with TYPE is displayed.
[I P 1 O U T P U T] O N	The IP1 output selected with OUTPUT is displayed. The same holds true for IP2.
[I P 1 S T R E A M 1 P A Y L O A D] V : 9 6 A U : 9 7 A N : 1 0 0	The IP1/ST1 payload types specified with PAYLOAD TYPE are displayed. The same holds true for IP1/ST2 to 4, IP2/ST1 to 4. (V: Video, AU: Audio, and AN: ANC)
[I P 1 S T R E A M 1 V L A N T A G] V : O F F A U : O F F A N : O F F	The IP1/ST1 VLAN tags specified with VLAN TAG (OFF if the setting is OFF) are displayed. The same holds true for IP1/ST2 to 4, IP2/ST1 to 4. (V: Video, AU: Audio, and AN: ANC)
[I P 1 S T R E A M 1 D S C P T A G] V : O F F A U : O F F A N : O F F	The IP1/ST1 DSCP tags specified with DSCP TAG (OFF if the setting is OFF) are displayed. The same holds true for IP1/ST2 to 4, IP2/ST1 to 4. (V: Video, AU: Audio, and AN: ANC)
[I P 1 S T R E A M 1 V I D D S T I P] 2 3 9 . 0 0 0 . 0 0 0 . 0 0 1	The IP1/ST1/video destination IP address specified with DESTINATION IP ADDRESS is displayed. The same holds true for IP1/ST2 to 4, IP2/ST1 to 4.
[I P 1 S T R E A M 1 V I D D S T P T] 5 0 0 4	The IP1/ST1/video destination port number specified with DESTINATION PORT is displayed.

16 STATUS MENU

Item	Description
	The same holds true for IP1/ST2 to 4, IP2/ST1 to 4.
<pre>[I P 1 S T R E A M 1 A U D M O D E] ◀▶ S T 2 1 1 0 - 3 0</pre>	<p>The IP1/ST1/audio standard selected with MODE is displayed.</p> <p>The same holds true for IP1/ST2 to 4, IP2/ST1 to 4.</p>
<pre>[I P 1 S T R E A M 1 A U D T I M E] ◀▶ 1 m s</pre>	<p>The IP1/ST1/audio packet times selected with PACKET TIME are displayed.</p> <p>The same holds true for IP1/ST2 to 4, IP2/ST1 to 4.</p>
<pre>[I P 1 S T R E A M 1 A U D D S T I P] ◀▶ 2 3 9 . 0 0 0 . 0 0 2 . 0 0 1</pre>	<p>The IP1/ST1/audio destination IP address specified with DESTINATION IP ADDRESS is displayed.</p> <p>The same holds true for IP1/ST2 to 4, IP2/ST1 to 4.</p>
<pre>[I P 1 S T R E A M 1 A U D D S T P T] ◀▶ 5 0 0 4</pre>	<p>The IP1/ST1/audio destination port number specified with DESTINATION PORT is displayed.</p> <p>The same holds true for IP1/ST2 to 4, IP2/ST1 to 4.</p>
<pre>[I P 1 S T R E A M 1 A N C D S T I P] ◀▶ 2 3 9 . 0 0 0 . 0 0 3 . 0 0 1</pre>	<p>The IP1/ST1/ANC destination IP address specified with DESTINATION IP ADDRESS is displayed.</p> <p>The same holds true for IP1/ST2 to 4, IP2/ST1 to 4.</p>
<pre>[I P 1 S T R E A M 1 A N C D S T P T] ◀▶ 5 0 0 4</pre>	<p>The IP1/ST1/ANC destination port number specified with DESTINATION PORT is displayed.</p> <p>The same holds true for IP1/ST2 to 4, IP2/ST1 to 4.</p>
<pre>[I P 1 M A C A D D R E S S] ◀▶ 0 0 : 0 0 : 0 0 : 0 0 : 0 0 : 0 0</pre>	<p>The MAC address of IP1 is displayed.</p> <p>The same holds true for IP2.</p>
<pre>[S E R 0 4 : 0 0 / 0 0 0 0 0 0 0] ◀▶ I P : 0 0 0 0 0 0 0 0</pre>	<p>The board ID and serial number are displayed in the top row, and the FPGA version is displayed in the bottom row.</p>

16.3.7 SYSTEM Menu

SYSTEM on the CONFIG menu shows the instrument settings.

```
[ C O N F I G ]      ⬅
S Y S T E M        ⬇
```

Table 16-9 | SYSTEM menu

Item	Description
<pre>[F I R M W A R E V E R S I O N] ⬅ 1 . 2</pre>	The firmware version is displayed.
<pre>[M A I N : 0 0 / 0 0 0 0 0 0 0] ⬅ C 5 : 0 0 0 0 0 0 0 0 C 1 0 : 0 0 0 0 0 0 0 0</pre>	The board ID and serial number are displayed in the top row, and the FPGA version is displayed in the bottom row.
<pre>[M A C A D D R E S S] ⬅ 0 0 : 0 0 : 0 0 : 0 0 : 0 0 : 0 0</pre>	Displays the MAC address.
<pre>[L I C E N S E] ⬅ S E R 2 1 : 4 K</pre>	Added software options are displayed. If no options are added, nothing is displayed.
<pre>[S O N U M B E R] ⬅ 0 0 0 0 0 0 0</pre>	For a custom model, the custom number is displayed. For a standard model, nothing is displayed.
<pre>[P O W E R / F A N] ⬅ 0 0 / 0 0 0 / 0</pre>	The board IDs of power supply unit 1, power supply unit 2 (SER11), front fan unit, and rear fan unit are displayed.

16.4 LOG Menu

LOG on the STATUS menu is used to display and clear the log.

To display the LOG menu, press STATUS several times until the following menu appears.

```
[ S T A T U S ]
LOG
```

16.4.1 Viewing the Log

To view the log, follow the procedure below.

Press the ▲ key to view newer log entries, the ▼ key to view older log entries, and the ◀ and ▶ keys to switch between date and time display and log display.

You can view up to 1000 entries from 000 to 999. Subsequent entries that occur overwrite the oldest entries.

The date and time of the log will be the date and time selected with TIME SOURCE on the REFERENCE CONFIG menu.

```
[ L O G   L I S T ]
0 0 0 ' 2 3 / 0 4 / 0 1   1 2 : 3 4 : 5 6
      ↓   ↑
2 0 2 3 / 0 4 / 0 1   1 2 : 3 4 : 5 6
0 0 0 : A L M ( F A N   F R O N T   O K )
```

Procedure

STATUS > LOG > LIST

16.4.2 Clearing the Log

To clear the log, select OK by following the procedure below.

```
[ L O G   D E L E T E ]
  □ O K           ■ C A N C E L
```

Procedure

STATUS > LOG > DELETE

17 SNMP

By using SNMP (Simple Network Management Protocol), you can control the instrument from SNMP managers. In addition, when the fan stops or other errors occur, traps can be sent from the instrument to SNMP managers.

- * The Ethernet features of this instrument have only been confirmed to work in a local network environment. LEADER does not guarantee that the features will work in all network environments.
- * DHCP client and DNS resolver features are not supported.
- * This instrument does not come with an SNMP manager. Prepare one by yourself. For details of how to use an SNMP manager, see the instruction manual for the SNMP manager.

17.1 SNMP Versions

SNMPv2c

SNMPv3

17.2 SMI Definitions

IMPORTS

MODULE-IDENTITY, OBJECT-TYPE, NOTIFICATION-TYPE, IPAddress, Counter32, enterprises

FROM SNMPv2-SMI

DisplayString, MacAddress

FROM SNMPv2-TC

OBJECT-GROUP, MODULE-COMPLIANCE

FROM SNMPv2-CONF;

17.3 How to Use

The following describes how to use SNMPv2c as an example.

1. On the LT4670, set the IP address.

To set the IP address, choose "SYSTEM CONFIG > NETWORK > ETHERNET > IP ADDRESS".

```
3 . I P   A D D R E S S
   1 9 2 . 1 6 8 . 0 0 0 . 0 0 1
```

2. On the LT4670, enable the network settings.

You need to enable "NETWORK SETUP" and "SNMP SETUP" individually.

Choose "SYSTEM CONFIG > NETWORK > NETWORK SETUP", and set "ENABLE" for "NETWORK SETUP".

```
2 . N E T W O R K   S E T U P
   ■ E N A B L E   □ D I S A B L E
```

Choose "SYSTEM CONFIG > NETWORK > SNMP > SNMP SETUP", and set "V2C" for "SNMP SETUP".

```

3 . S N M P   S E T U P
    D I S A B L E    V 2 C    V 3
    
```

3. Enable the trap transmission destinations to use with the LT4670.

Choose "SYSTEM CONFIG > NETWORK > SNMP > SNMP TRAP 1 - SNMP TRAP 4", and set "ENABLE".

You can use up to four trap transmission destinations. To alleviate communication load, disable the transmission destinations that you are not using.

```

3 . S N M P   T R A P   1
    E N A B L E    D I S A B L E
    
```

4. Set the IP addresses of the trap transmission destinations to use with the LT4670.

Choose "SYSTEM CONFIG > NETWORK > SNMP > SNMP MANAGER IP 1 - SNMP MANAGER IP 4", and set the IP address.

```

3 . S N M P   M A N A G E R   I P   1
   0 0 0 . 0 0 0 . 0 0 0 . 0 0 0
    
```

5. Connect ETHERNET/CONTROL on the LT4670 rear panel to the network device.

Connect to a network where an SNMP manager is available.

6. Start the SNMP manager on the PC.

The initial values for community names are as listed below.

You can change them, using "SYSTEM CONFIG > NETWORK > SNMP > SNMP COMMUNITY".

```

READ COMMUNITY:   LDRUser
WRITE COMMUNITY:  LDRAdm
TRAP COMMUNITY:   LDRUser
    
```

7. Restart the LT4670.

8. When the instrument restarts, check that the standard trap "ColdStart" is received by the SNMP manager.

For SNMPv3, use the following parameters:

Table 17-1 | SNMPv3

User setting	READ COMMUNITY	LDuser (not to be changed)
	WRITE COMMUNITY	LDadm (not to be changed)
	TRAP COMMUNITY	LDuser (not to be changed)
Authentication setting	Authentication password	leader23
	Authentication method	SHA
Encryption setting	Encryption password	LT4670xt
	Encryption method	AES

17.4 Enterprise MIB

The enterprise MIBs available when all options (SER01, SER02, SER03, SER04, SER11, and SER21) are added are listed below.

Retrieving the MIB file

Download it from the Web browser or copy it from the LT4670.

To download it from the Web browser, click the GET MIB button on the SYSTEM screen.

[See also] "18.4.9 SYSTEM Screen"

To copy it from the LT4670, connect a USB memory device to the LT4670, choose "SYSTEM CONFIG > NETWORK > SNMP > COPY MIB INT→USB", and set "OK". "lt4670.my" will be copied to "USB memory device > LT4670_USER > MIB".



Enterprise number

Leader's enterprise number is 20111.

iso(1).org(3).dod(6).internet(1).private(4).enterprises(1).leader(20111)

MIB structure

lt4670	OBJECT IDENTIFIER ::= { leader 44 }
lt4670ST1	OBJECT IDENTIFIER ::= { lt4670 1 }
l44notificationTBL	OBJECT IDENTIFIER ::= { lt4670ST1 0 }
l44systemTBL	OBJECT IDENTIFIER ::= { lt4670ST1 1 }
l44statusTBL	OBJECT IDENTIFIER ::= { lt4670ST1 2 }
l44referenceTBL	OBJECT IDENTIFIER ::= { lt4670ST1 3 }
l44blackTBL	OBJECT IDENTIFIER ::= { lt4670ST1 4 }
l44audioTBL	OBJECT IDENTIFIER ::= { lt4670ST1 5 }
l44lrcTBL	OBJECT IDENTIFIER ::= { lt4670ST1 6 }
l44cw1ppsTBL	OBJECT IDENTIFIER ::= { lt4670ST1 7 }
l44trapTBL	OBJECT IDENTIFIER ::= { lt4670ST1 8 }
lt4670ser02	OBJECT IDENTIFIER ::= { lt4670 2 }
l44sdi1TBL	OBJECT IDENTIFIER ::= { lt4670ser02 1 }
l44sdi2TBL	OBJECT IDENTIFIER ::= { lt4670ser02 2 }
l44sdi3TBL	OBJECT IDENTIFIER ::= { lt4670ser02 3 }
l44sdi4TBL	OBJECT IDENTIFIER ::= { lt4670ser02 4 }
l44sdiFrequencyGroup	OBJECT IDENTIFIER ::= { lt4670ser02 5 }
lt4670ser03	OBJECT IDENTIFIER ::= { lt4670 3 }
l44ptp1TBL	OBJECT IDENTIFIER ::= { lt4670ser03 1 }
l44ptp2TBL	OBJECT IDENTIFIER ::= { lt4670ser03 2 }
lt4670ser04	OBJECT IDENTIFIER ::= { lt4670 4 }

ACCESS

R/O: Read only
 R/W: Read and write
 W/O: Write only

17.4.1 I44notificationTBL Group

Table 17-2 | I44notificationTBL group

OID	Access	Syntax	Description
I44trapContentTBL {I44notificationTBL.1}	-	Aggregate	-
I44trapErrorTBL {I44trapContentTBL.1}	-	Aggregate	-
I44trapErrorFanFront {I44TrapErrorTBL.1}	-	-	Front fan unit error
I44trapErrorFanRear {I44TrapErrorTBL.2}	-	-	Rear fan unit error
I44trapErrorFanPower1 {I44TrapErrorTBL.3}	-	-	POWER1 fan error
I44trapErrorFanPower2 {I44TrapErrorTBL.4}	-	-	POWER2 fan error
I44trapErrorUnitPower1 {I44TrapErrorTBL.5}	-	-	POWER1 error
I44trapErrorUnitPower2 {I44TrapErrorTBL.6}	-	-	POWER2 error
I44trapErrorGnssAntenna {I44TrapErrorTBL.7}	-	-	GNSS antenna error
I44trapErrorIntPll {I44TrapErrorTBL.9}	-	-	Crystal error
I44trapErrorReferenceStatus {I44TrapErrorTBL.10}	-	-	Reference signal error (No input signal, stay-in-sync)
I44trapErrorTimeLag {I44TrapErrorTBL.11}	-	-	Time error
I44trapErrorPtp1BMCAStatus {I44TrapErrorTBL.20}	-	-	Stoppage of output by BMCA of PTP1
I44trapErrorPtp2BMCAStatus {I44TrapErrorTBL.21}	-	-	Stoppage of output by BMCA of PTP2
I44trapNormalTBL {I44trapContentTBL.2}	-	Aggregate	-
I44trapNormalFanFront {I44TrapNormalTBL.1}	-	-	Front fan unit recovery
I44trapNormalFanRear {I44TrapNormalTBL.2}	-	-	Rear fan unit recovery
I44trapNormalFanPower1 {I44TrapNormalTBL.3}	-	-	POWER1 fan recovery
I44trapNormalFanPower2 {I44TrapNormalTBL.4}	-	-	POWER2 fan recovery

OID	Access	Syntax	Description
I44trapNormalUnitPower1 {I44TrapNormalTBL.5}	-	-	POWER1 recovery
I44trapNormalUnitPower2 {I44TrapNormalTBL.6}	-	-	POWER2 recovery
I44trapNormalGnssAntenna {I44TrapNormalTBL.7}	-	-	GNSS antenna recovery
I44trapNormalIntPll {I44TrapNormalTBL.9}	-	-	Crystal recovery
I44trapNormalReferenceStatus {I44TrapNormalTBL.10}	-	-	Reference signal lock
I44trapNormalDly1Sec {I44TrapNormalTBL.11}	-	-	Time recovery
I44trapNormalPtp1BMCAStatus {I44TrapNormalTBL.20}	-	-	Recovery of output by BMCA of PTP1
I44trapNormalPtp2BMCAStatus {I44TrapNormalTBL.21}	-	-	Recovery of output by BMCA of PTP2
I44trapStrTBL {I44notificationTBL.2}	-	Aggregate	-
I44trapCounter {I44trapStrTBL.1}	-	Counter32	The total number of enterprise traps sent after starting up 1 - 4294967295
I44trapInternalTimestamp {I44trapStrTBL.2}	-	Display String	Date and time of error occurrence
I44trapContent {I44trapStrTBL.3}	-	Display String	Error Information Character String
I44statusAlarm/I44statusReference {I44trapStrTBL.4}	-	Integer	Alarm status and reference signal status

17.4.2 I44systemTBL Group

Table 17-3 | I44systemTBL group

OID	Access	Syntax	Description
I44systemConfigTBL {I44systemTBL.1}	-	Aggregate	-
I44systemSerialNumber {I44systemConfigTBL.1}	R/O	Display String	Serial number xxxxxxx
I44systemVersion {I44systemConfigTBL.2}	R/O	Display String	Firmware version x.x
I44presetTBL {I44systemTBL.2}	-	Aggregate	-
I44systemRecall {I44presetTBL.1}	R/W	Integer	Preset numbers 0 - 9
I44systemPowerOnRecall {I44presetTBL.2}	R/W	Integer	Preset number at startup -1 = OFF 0 - 9 = Preset numbers
I44networkEthernetTBL	-	Aggregate	-

OID	Access	Syntax	Description
{I44systemTBL.3}			
I44systemMacAddress {I44networkEthernetTBL.1}	R/O	Mac Address	MAC address of the instrument xx:xx:xx:xx:xx:xx
I44systemIPAddress {I44networkEthernetTBL.2}	R/O	IpAddress	IP address of the instrument xxx.xxx.xxx.xxx
I44systemSubnet {I44networkEthernetTBL.3}	R/O	IpAddress	Subnet mask of the instrument xxx.xxx.xxx.xxx
I44systemGeteway {I44networkEthernetTBL.4}	R/O	IpAddress	Default gateway of the instrument xxx.xxx.xxx.xxx
I44ptpOptionTBL {I44systemTBL.4}	-	Aggregate	-
I44ptp1MacAddress {I44ptpOptionTBL.1}	R/O	Mac Address	MAC address of PTP1 xx:xx:xx:xx:xx:xx
I44ptp1IPAddress {I44ptpOptionTBL.2}	R/O	IpAddress	IP address of PTP1 xxx.xxx.xxx.xxx
I44ptp1Subnet {I44ptpOptionTBL.3}	R/O	IpAddress	Subnet mask of PTP1 xxx.xxx.xxx.xxx
I44ptp1Geteway {I44ptpOptionTBL.4}	R/O	IpAddress	Default gateway of PTP1 xxx.xxx.xxx.xxx
I44ptp2MacAddress {I44ptpOptionTBL.5}	R/O	Mac Address	MAC address of PTP2 xx:xx:xx:xx:xx:xx
I44ptp2IPAddress {I44ptpOptionTBL.6}	R/O	IpAddress	IP address of PTP2 xxx.xxx.xxx.xxx
I44ptp2Subnet {I44ptpOptionTBL.7}	R/O	IpAddress	Subnet mask of PTP2 xxx.xxx.xxx.xxx
I44ptp2Geteway {I44ptpOptionTBL.8}	R/O	IpAddress	Default gateway of PTP2 xxx.xxx.xxx.xxx
I44ipOptionTBL {I44systemTBL.5}	-	Aggregate	-
I44ip1MacAddress {I44ipOptionTBL.1}	R/O	MacAddress	MAC address of IP1 xx:xx:xx:xx:xx:xx
I44ip1IPAddress {I44ipOptionTBL.2}	R/O	IpAddress	IP address of IP1 xxx.xxx.xxx.xxx
I44ip1Subnet {I44ipOptionTBL.3}	R/O	IpAddress	Subnet mask of IP1 xxx.xxx.xxx.xxx
I44ip1Geteway {I44ipOptionTBL.4}	R/O	IpAddress	Default gateway of IP1 xxx.xxx.xxx.xxx
I44ip1Speed {I44ipOptionTBL.5}	R/W	INTEGER	SFP transceiver type of IP1 1 = speed-10g 2 = speed-25g
I44ip1RsFec {I44ipOptionTBL.6}	R/W	INTEGER	RS-FEC of IP1 1 = off 2 = on
I44ip1Igmp {I44ipOptionTBL.7}	R/W	INTEGER	IGMP version of IP1 1 = v2 2 = v3

OID	Access	Syntax	Description
			3 = auto
I44ip2MacAddress {I44ipOptionTBL.8}	R/O	MacAddress	MAC address of IP2 xx:xx:xx:xx:xx:xx
I44ip2IPAddress {I44ipOptionTBL.9}	R/O	IpAddress	IP address of IP2 xxx.xxx.xxx.xxx
I44ip2Subnet {I44ipOptionTBL.10}	R/O	IpAddress	Subnet mask of IP2 xxx.xxx.xxx.xxx
I44ip2Geteway {I44ipOptionTBL.11}	R/O	IpAddress	Default gateway of IP2 xxx.xxx.xxx.xxx
I44ip2Speed {I44ipOptionTBL.12}	R/W	INTEGER	SFP transceiver type of IP2 1 = speed-10g 2 = speed-25g
I44ip2RsFec {I44ipOptionTBL.13}	R/W	INTEGER	RS-FEC of IP2 1 = off 2 = on
I44ip2Igmp {I44ipOptionTBL.14}	R/W	INTEGER	IGMP version of IP2 1 = v2 2 = v3 3 = auto

17.4.3 I44statusTBL Group

Table 17-4 | I44statusTBL group

OID	Access	Syntax	Description
I44statusAlarmTBL {I44statusTBL.1}	-	Aggregate	-
I44statusAlarmFanFront {I44statusAlarmTBL.1}	R/O	Integer	Front fan unit alarm 1 = normal 2 = stop
I44statusAlarmFanRear {I44statusAlarmTBL.2}	R/O	Integer	Rear fan unit alarm 1 = normal 2 = stop
I44statusAlarmFanPower1 {I44statusAlarmTBL.3}	R/O	Integer	POWER1 fan alarm 1 = normal 2 = stop
I44statusAlarmFanPower2 {I44statusAlarmTBL.4}	R/O	Integer	POWER2 fan alarm 1 = normal 2 = stop
I44statusAlarmUnitPower1 {I44statusAlarmTBL.5}	R/O	Integer	POWER1 alarm 1 = normal 2 = error
I44statusAlarmUnitPower2 {I44statusAlarmTBL.6}	R/O	Integer	POWER2 alarm 1 = normal 2 = error
I44statusAlarmGnssAntenna {I44statusAlarmTBL.7}	R/O	Integer	GNSS antenna alarm 1 = normal

OID	Access	Syntax	Description
			2 = error
I44statusAlarmIntPll {I44statusAlarmTBL.9}	R/O	Integer	Crystal alarm 1 = normal 2 = error
I44statusAlarmTimeLag {I44statusAlarmTBL.10}	R/O	Integer	Time alarm 1 = normal 2 = error
I44statusReferenceTBL {I44statusTBL.2}	-	Aggregate	-
I44statusReference {I44statusReferenceTBL.1}	R/O	Integer	Reference signal lock status 1 = initialize 2 = tracking 3 = lock 4 = stay 5 = recovery 11 = gnss-no-fix (SER01) 12 = adjust-freq-to-gnss (SER01) 13 = adjust-phase-to-gnss (SER01) 14 = tracking (SER01) 15 = lock (SER01) 16 = stay (SER01) 17 = recovery (SER01) 21 = ptp-follower-aging (SER03) 22 = ptp-leader-not-found (SER03) 23 = ptp-adjust-freq (SER03) 24 = ptp-adjust-phase (SER03) 25 = tracking (SER03) 26 = lock (SER03) 27 = stay (SER03) 28 = recovery (SER03) 30 = internal 40 = int-pll-error
I44statusReferencePtp1 {I44statusReferenceTBL.2}	R/O	Integer	PTP1 lock status 21 = ptp-follower-aging 22 = ptp-leader-not-found 23 = ptp-adjust-freq 24 = ptp-adjust-phase 25 = tracking 26 = lock 27 = stay 28 = recovery 29 = passive
I44statusReferencePtp2 {I44statusReferenceTBL.3}	R/O	Integer	PTP2 lock status 21 = ptp-follower-aging 22 = ptp-leader-not-found 23 = ptp-adjust-freq

OID	Access	Syntax	Description
			24 = ptp-adjust-phase 25 = tracking 26 = lock 27 = stay 28 = recovery 29 = passive
I44statusGenlockFormat {I44statusReferenceTBL.4}	R/O	Integer	Genlock format 1 = f1125-60i 2 = f1125-59p94i 3 = f1125-50i 4 = f1125-30p 5 = f1125-29p97p 6 = f1125-25p 7 = f1125-24p 8 = f1125-23p98p 9 = f1125-24psf 10 = f1125-23p98psf 11 = f750-60p 12 = f750-59p94p 13 = f750-50p 14 = f750-30p 15 = f750-29p97p 16 = f750-25p 17 = f750-24p 18 = f750-23p98p 19 = f525-59p94i 20 = fNTSC-BB 21 = fNTSC-BB-REF 22 = fNTSC-BB-ID 23 = fNTSC-BB-REF-ID 24 = f525-59p94p 25 = f625-50i 26 = fPAL-BB 27 = fPAL-BB-REF 28 = f625-50p 29 = f1125-60p 30 = f1125-59p94p 31 = f1125-50p 100 = unknown
I44statusUtcTime {I44statusReferenceTBL.5}	R/O	Display String	Coordinated Universal Time (UTC) YYYY/MM/DD HH:MM:SS
I44statusLocalTime {I44statusReferenceTBL.6}	R/O	Display String	Internal clock of the instrument YYYY/MM/DD HH:MM:SS Ntp Running Ntp Server Error
I44statusTime	R/O	Display	Date and time selected by TIME SOURCE

OID	Access	Syntax	Description
{I44statusReferenceTBL.7}		String	YYYY/MM/DD HH:MM:SS HH:MM:SS -----
I44statusPTP1Output {I44statusReferenceTBL.8}	R/O	Integer	Output status of PTP1 1 = time-measuring 2 = time-setting 3 = listening 4 = preleader 5 = leader 6 = passive
I44statusPTP2Output {I44statusReferenceTBL.9}	R/O	Integer	Output status of PTP2 1 = time-measuring 2 = time-setting 3 = listening 4 = preleader 5 = leader 6 = passive
I44statusGnssTBL {I44statusTBL.3}	-	Aggregate	-
I44statusSatelliteUsed {I44statusGnssTBL.1}	R/O	Display String	Number of effective satellites
I44statusC/N0 {I44statusGnssTBL.2}	R/O	Display String	C/N0
I44statusPtpTBL {I44statusTBL.4}	-	Aggregate	-
I44statusPtp1TBL {I44statusPtpTBL.1}	-	Aggregate	-
I44statusPtp1ClockClass {I44statusPtp1TBL.1}	R/O	Display String	Clock class of PTP1
I44statusPtp1ClockAccuracy {I44statusPtp1TBL.2}	R/O	Display String	Clock accuracy of PTP1
I44statusPtp1ClockSource {I44statusPtp1TBL.3}	R/O	Display String	Time source of PTP1
I44statusPtp1LeaderID {I44statusPtp1TBL.4}	R/O	Display String	Leader ID of PTP1
I44statusPtp1PhaseLag {I44statusPtp1TBL.5}	R/O	Display String	Phase difference between PTP1 and leader
I44statusPtp1LockValue {I44statusPtp1TBL.6}	R/O	Display String	Lock strength of PTP1
I44statusPtp1PacketNoise {I44statusPtp1TBL.7}	R/O	Display String	Noise of PTP1
I44statusPtp1ST2059LocalOffset {I44statusPtp1TBL.8}	R/O	Display String	Offset time for TAI of PTP1
I44statusPtp1ST2059JumpSeconds {I44statusPtp1TBL.9}	R/O	Display String	Offset time during PTP1 daylight saving
I44statusPtp1ST2059NextJump	R/O	Display	Start or end date and time of PTP1 daylight

OID	Access	Syntax	Description
{I44statusPtp1TBL.10}		String	saving
I44statusPtp1ST2059NextJamTime {I44statusPtp1TBL.11}	R/O	Display String	Date and time on which jam sync will occur after PTP1
I44statusPtp1ST2059PreviosJamTime {I44statusPtp1TBL.12}	R/O	Display String	Date and time on which PTP1 jam sync occurred
I44statusPtp2TBL {I44statusPtpTBL.2}	-	Aggregate	-
I44statusPtp2ClockClass {I44statusPtp2TBL.1}	R/O	Display String	Clock class of PTP2
I44statusPtp2ClockAccuracy {I44statusPtp2TBL.2}	R/O	Display String	Clock accuracy of PTP2
I44statusPtp2ClockSource {I44statusPtp2TBL.3}	R/O	Display String	Time source of PTP2
I44statusPtp2LeaderID {I44statusPtp2TBL.4}	R/O	Display String	Leader ID of PTP2
I44statusPtp2PhaseLag {I44statusPtp2TBL.5}	R/O	Display String	Phase difference between PTP2 and leader
I44statusPtp2LockValue {I44statusPtp2TBL.6}	R/O	Display String	Lock strength of PTP2
I44statusPtp2PacketNoise {I44statusPtp2TBL.7}	R/O	Display String	Noise of PTP2
I44statusPtp2ST2059LocalOffset {I44statusPtp2TBL.8}	R/O	Display String	Offset time for TAI of PTP2
I44statusPtp2ST2059JumpSeconds {I44statusPtp2TBL.9}	R/O	Display String	Offset time during PTP2 daylight saving
I44statusPtp2ST2059NextJump {I44statusPtp2TBL.10}	R/O	Display String	Start or end date and time of PTP2 daylight saving
I44statusPtp2ST2059NextJamTime {I44statusPtp2TBL.11}	R/O	Display String	Date and time on which jam sync will occur after PTP2
I44statusPtp2ST2059PreviosJamTime {I44statusPtp2TBL.12}	R/O	Display String	Date and time on which PTP2 jam sync occurred
I44statusBlackTBL {I44statusTBL.5}	-	Aggregate	-
I44statusBlackVitcNumber {I44statusBlackTBL.1}	R/O	Display String	Black output timecode superimposition line

17.4.4 I44referenceTBL Group

Table 17-5 | I44referenceTBL group

OID	Access	Syntax	Description
I44referenceSourceTBL {I44referenceTBL.1}	-	Aggregate	-
I44referenceSource {I44referenceSourceTBL.1}	R/W	Integer	Reference signal 1 = internal 2 = gl-fmt-auto 3 = gl-fmt-manual

OID	Access	Syntax	Description
			4 = cw 5 = gnss 6 = ptp1 7 = ptp2 8 = ptp1-2
144referenceGenlockFormat {144ReferenceTBL.2}	R/W	Integer	Genlock format 1 = f1125-60i 2 = f1125-59p94i 3 = f1125-50i 4 = f1125-30p 5 = f1125-29p97p 6 = f1125-25p 7 = f1125-24p 8 = f1125-23p98p 9 = f1125-24psf 10 = f1125-23p98psf 11 = f750-60p 12 = f750-59p94p 13 = f750-50p 14 = f750-30p 15 = f750-29p97p 16 = f750-25p 17 = f750-24p 18 = f750-23p98p 19 = f525-59p94i 20 = fNTSC-BB 21 = fNTSC-BB-REF 22 = fNTSC-BB-ID 23 = fNTSC-BB-REF-ID 24 = f525-59p94p 25 = f625-50i 26 = fPAL-BB 27 = fPAL-BB-REF 28 = f625-50p 29 = f1125-60p 30 = f1125-59p94p 31 = f1125-50p 100 = unknown
144referenceGenlockTimingFine {144ReferenceTBL.3}	R/W	Integer	Genlock timing ±100
144referenceGnssSatellite {144ReferenceTBL.4}	R/W	Integer	Satellite 1 = all 2 = gps 3 = glonass 4 = galileo 5 = bds

OID	Access	Syntax	Description
			6 = gps-qzss
I44referenceRecoveryMode {I44ReferenceTBL.5}	R/W	Integer	Recovery mode 1 = auto 2 = manual
I44referenceRecoveryAutoSpeed {I44ReferenceTBL.6}	R/W	Integer	Relock speed in auto mode 1 = immediate 2 = fast 3 = slow
I44referenceRecoveryManualSpeed {I44ReferenceTBL.7}	R/W	Integer	Relock speed in manual mode 1 = immediate 2 = fast 3 = slow
I44referenceReadjust {I44ReferenceTBL.8}	W/O	Integer	Relock 1 = Fixed
I44referenceTimeSource {I44ReferenceTBL.9}	R/W	Integer	Time source 1 = internal 2 = ltc 3 = ltc-st309 4 = vitc 5 = vitc-st309 6 = ntp 7 = gnss 8 = ptp1 9 = ptp2 10 = ptp1-2
I44referenceTimeReadjust {I44ReferenceTBL.10}	W/O	Integer	Loading the date and time 1 = Fixed

17.4.5 I44blackTBL Group

Table 17-6 | I44blackTBL group

OID	Access	Syntax	Description
I44black1TBL {I44blackTBL.1}	-	Aggregate	-
I44black1Format {I44black1TBL.2}	R/W	Integer	Black output 1 format 2 = f1125-60i 3 = f1125-59p94i 4 = f1125-50i 5 = f1125-30p 6 = f1125-29p97p 7 = f1125-25p 8 = f1125-24p 9 = f1125-23p98p 10 = f1125-24psf 11 = f1125-23p98psf 12 = f750-60p

OID	Access	Syntax	Description
			13 = f750-59p94p 14 = f750-50p 15 = f750-30p 16 = f750-29p97p 17 = f750-25p 18 = f750-24p 19 = f750-23p98p 20 = fNTSC-BB 21 = fNTSC-BB-REF 22 = fNTSC-BB-ID 23 = fNTSC-BB-REF-ID 24 = fNTSC-BB-S 25 = fNTSC-BB-S-R 26 = fNTSC-BB-S-ID 27 = fNTSC-BB-S-R-ID 28 = f525-59p94i 29 = f525-59p94p 30 = fPAL-BB 31 = fPAL-BB-REF 32 = f625-50i 33 = f625-50p 34 = f1125-60p 35 = f1125-59p94p 36 = f1125-50p
I44black1TimingFrame {I44black1TBL.3}	R/W	Integer	Black output 1 timing relative to the reference signal (in frames) ±5
I44black1TimingVertical {I44black1TBL.4}	R/W	Integer	Black output 1 timing relative to the reference signal (in lines) ±1125
I44black1TimingHorizontal {I44black1TBL.5}	R/W	Integer	Black output 1 timing relative to the reference signal (in dots) ±4124
I44black1Vitc {I44black1TBL.6}	R/W	Integer	Insertion of time code into black output 1 1 = off 2 = on
I44black1VitcDropframe {I44black1TBL.7}	R/W	Integer	Black output 1 dropped frame 1 = off 2 = on
I44black1Output {I44black1TBL.8}	R/W	Integer	Black output 1 1 = enable 2 = disable
I44black1OutputLinktoPtp1Bmca {I44black1TBL.9}	R/W	Integer	Black output 1 BMCA linking (PTP1) 1 = enable 2 = disable
I44black1OutputLinktoPtp2Bmca	R/W	Integer	Black output 1 BMCA linking (PTP2)

OID	Access	Syntax	Description
{I44black1TBL.10}			1 = enable 2 = disable
I44black1VtcNtsc {I44black1TBL.11}	R/W	Integer	Black output 1 timecode superimposition line (NTSC) 10 = vtc-ntsc-10 11 = vtc-ntsc-11 12 = vtc-ntsc-12 13 = vtc-ntsc-13 14 = vtc-ntsc-14 15 = vtc-ntsc-15 16 = vtc-ntsc-16 17 = vtc-ntsc-17 18 = vtc-ntsc-18 19 = vtc-ntsc-19 20 = vtc-ntsc-20
I44black1VtcPal {I44black1TBL.12}	R/W	Integer	Black output 1 timecode superimposition line (PAL) 6 = vtc-pal-6 7 = vtc-pal-7 8 = vtc-pal-8 9 = vtc-pal-9 10 = vtc-pal-10 11 = vtc-pal-11 12 = vtc-pal-12 13 = vtc-pal-13 14 = vtc-pal-14 15 = vtc-pal-15 16 = vtc-pal-16 17 = vtc-pal-17 18 = vtc-pal-18 19 = vtc-pal-19 20 = vtc-pal-20 21 = vtc-pal-21 22 = vtc-pal-22
I44black2TBL {I44blackTBL.2}	-	Aggregate	-
I44black2EqualToBlack1 {I44black2TBL.1}	R/W	Integer	Setting shared by black output 2 and black output 1 1 = off 2 = on
I44black2Format {I44black2TBL.2}	R/W	Integer	Black output 2 format 2 = f1125-60i 3 = f1125-59p94i 4 = f1125-50i 5 = f1125-30p 6 = f1125-29p97p

OID	Access	Syntax	Description
			7 = f1125-25p 8 = f1125-24p 9 = f1125-23p98p 10 = f1125-24psf 11 = f1125-23p98psf 12 = f750-60p 13 = f750-59p94p 14 = f750-50p 15 = f750-30p 16 = f750-29p97p 17 = f750-25p 18 = f750-24p 19 = f750-23p98p 20 = fNTSC-BB 21 = fNTSC-BB-REF 22 = fNTSC-BB-ID 23 = fNTSC-BB-REF-ID 24 = fNTSC-BB-S 25 = fNTSC-BB-S-R 26 = fNTSC-BB-S-ID 27 = fNTSC-BB-S-R-ID 28 = f525-59p94i 29 = f525-59p94p 30 = fPAL-BB 31 = fPAL-BB-REF 32 = f625-50i 33 = f625-50p 34 = f1125-60p 35 = f1125-59p94p 36 = f1125-50p
I44black2TimingFrame {I44black2TBL.3}	R/W	Integer	Black output 2 timing relative to the reference signal (in frames) ±5
I44black2TimingVertical {I44black2TBL.4}	R/W	Integer	Black output 2 timing relative to the reference signal (in lines) ±1125
I44black2TimingHorizontal {I44black2TBL.5}	R/W	Integer	Black output 2 timing relative to the reference signal (in dots) ±4124
I44black2Vitc {I44black2TBL.6}	R/W	Integer	Insertion of time code into black output 2 1 = off 2 = on
I44black2VitcDropframe {I44black2TBL.7}	R/W	Integer	Black output 2 dropped frame 1 = off 2 = on
I44black2Output	R/W	Integer	Black output 2

OID	Access	Syntax	Description
{I44black2TBL.8}			1 = enable 2 = disable
I44black2OutputLinktoPtp1Bmca {I44black2TBL.9}	R/W	Integer	Black output 2 BMCA linking (PTP1) 1 = enable 2 = disable
I44black2OutputLinktoPtp2Bmca {I44black2TBL.10}	R/W	Integer	Black output 2 BMCA linking (PTP2) 1 = enable 2 = disable
I44black2VitcNtsc {I44black2TBL.11}	R/W	Integer	Black output 2 timecode superimposition line (NTSC) 10 = vitc-ntsc-10 11 = vitc-ntsc-11 12 = vitc-ntsc-12 13 = vitc-ntsc-13 14 = vitc-ntsc-14 15 = vitc-ntsc-15 16 = vitc-ntsc-16 17 = vitc-ntsc-17 18 = vitc-ntsc-18 19 = vitc-ntsc-19 20 = vitc-ntsc-20
I44black2VitcPal {I44black2TBL.12}	R/W	Integer	Black output 2 timecode superimposition line (PAL) 6 = vitc-pal-6 7 = vitc-pal-7 8 = vitc-pal-8 9 = vitc-pal-9 10 = vitc-pal-10 11 = vitc-pal-11 12 = vitc-pal-12 13 = vitc-pal-13 14 = vitc-pal-14 15 = vitc-pal-15 16 = vitc-pal-16 17 = vitc-pal-17 18 = vitc-pal-18 19 = vitc-pal-19 20 = vitc-pal-20 21 = vitc-pal-21 22 = vitc-pal-22
I44black3TBL {I44blackTBL.3}	-	Aggregate	-
I44black3EqualToBlack1 {I44black3TBL.1}	R/W	Integer	Setting shared by black output 3 and black output 1 1 = off 2 = on

OID	Access	Syntax	Description
I44black3Format {I44black3TBL.2}	R/W	Integer	Black output 3 format 2 = f1125-60i 3 = f1125-59p94i 4 = f1125-50i 5 = f1125-30p 6 = f1125-29p97p 7 = f1125-25p 8 = f1125-24p 9 = f1125-23p98p 10 = f1125-24psf 11 = f1125-23p98psf 12 = f750-60p 13 = f750-59p94p 14 = f750-50p 15 = f750-30p 16 = f750-29p97p 17 = f750-25p 18 = f750-24p 19 = f750-23p98p 20 = fNTSC-BB 21 = fNTSC-BB-REF 22 = fNTSC-BB-ID 23 = fNTSC-BB-REF-ID 24 = fNTSC-BB-S 25 = fNTSC-BB-S-R 26 = fNTSC-BB-S-ID 27 = fNTSC-BB-S-R-ID 28 = f525-59p94i 29 = f525-59p94p 30 = fPAL-BB 31 = fPAL-BB-REF 32 = f625-50i 33 = f625-50p 34 = f1125-60p 35 = f1125-59p94p 36 = f1125-50p
I44black3TimingFrame {I44black3TBL.3}	R/W	Integer	Black output 3 timing relative to the reference signal (in frames) ±5
I44black3TimingVertical {I44black3TBL.4}	R/W	Integer	Black output 3 timing relative to the reference signal (in lines) ±1125
I44black3TimingHorizontal {I44black3TBL.5}	R/W	Integer	Black output 3 timing relative to the reference signal (in dots) ±4124
I44black3Vitic	R/W	Integer	Insertion of time code into black output 3

OID	Access	Syntax	Description
{I44black3TBL.6}			1 = off 2 = on
I44black3VtcDropframe {I44black3TBL.7}	R/W	Integer	Black output 3 dropped frame 1 = off 2 = on
I44black3Output {I44black3TBL.8}	R/W	Integer	Black output 3 1 = enable 2 = disable
I44black3OutputLinktoPtp1Bmca {I44black3TBL.9}	R/W	Integer	Black output 3 BMCA linking (PTP1) 1 = enable 2 = disable
I44black3OutputLinktoPtp2Bmca {I44black3TBL.10}	R/W	Integer	Black output 3 BMCA linking (PTP2) 1 = enable 2 = disable
I44black3VtcNtsc {I44black3TBL.11}	R/W	Integer	Black output 3 timecode superimposition line (NTSC) 10 = vitc-ntsc-10 11 = vitc-ntsc-11 12 = vitc-ntsc-12 13 = vitc-ntsc-13 14 = vitc-ntsc-14 15 = vitc-ntsc-15 16 = vitc-ntsc-16 17 = vitc-ntsc-17 18 = vitc-ntsc-18 19 = vitc-ntsc-19 20 = vitc-ntsc-20
I44black3VtcPal {I44black3TBL.12}	R/W	Integer	Black output 3 timecode superimposition line (PAL) 6 = vitc-pal-6 7 = vitc-pal-7 8 = vitc-pal-8 9 = vitc-pal-9 10 = vitc-pal-10 11 = vitc-pal-11 12 = vitc-pal-12 13 = vitc-pal-13 14 = vitc-pal-14 15 = vitc-pal-15 16 = vitc-pal-16 17 = vitc-pal-17 18 = vitc-pal-18 19 = vitc-pal-19 20 = vitc-pal-20 21 = vitc-pal-21 22 = vitc-pal-22

OID	Access	Syntax	Description
I44black4TBL {I44blackTBL.4}	-	Aggregate	-
I44black4EqualToBlack1 {I44black4TBL.1}	R/W	Integer	Setting shared by black output 4 and black output 1 1 = off 2 = on
I44black4Format {I44black4TBL.2}	R/W	Integer	Black output 4 format 2 = f1125-60i 3 = f1125-59p94i 4 = f1125-50i 5 = f1125-30p 6 = f1125-29p97p 7 = f1125-25p 8 = f1125-24p 9 = f1125-23p98p 10 = f1125-24psf 11 = f1125-23p98psf 12 = f750-60p 13 = f750-59p94p 14 = f750-50p 15 = f750-30p 16 = f750-29p97p 17 = f750-25p 18 = f750-24p 19 = f750-23p98p 20 = fNTSC-BB 21 = fNTSC-BB-REF 22 = fNTSC-BB-ID 23 = fNTSC-BB-REF-ID 24 = fNTSC-BB-S 25 = fNTSC-BB-S-R 26 = fNTSC-BB-S-ID 27 = fNTSC-BB-S-R-ID 28 = f525-59p94i 29 = f525-59p94p 30 = fPAL-BB 31 = fPAL-BB-REF 32 = f625-50i 33 = f625-50p 34 = f1125-60p 35 = f1125-59p94p 36 = f1125-50p
I44black4TimingFrame {I44black4TBL.3}	R/W	Integer	Black output 4 timing relative to the reference signal (in frames) ±5
I44black4TimingVertical	R/W	Integer	Black output 4 timing relative to the reference

OID	Access	Syntax	Description
{I44black4TBL.4}			signal (in lines) ±1125
I44black4TimingHorizontal {I44black4TBL.5}	R/W	Integer	Black output 4 timing relative to the reference signal (in dots) ±4124
I44black4Vitc {I44black4TBL.6}	R/W	Integer	Insertion of time code into black output 4 1 = off 2 = on
I44black4VitcDropframe {I44black4TBL.7}	R/W	Integer	Black output 4 dropped frame 1 = off 2 = on
I44black4Output {I44black4TBL.8}	R/W	Integer	Black output 4 1 = enable 2 = disable
I44black4OutputLinktoPtp1Bmca {I44black4TBL.9}	R/W	Integer	Black output 4 BMCA linking (PTP1) 1 = enable 2 = disable
I44black4OutputLinktoPtp2Bmca {I44black4TBL.10}	R/W	Integer	Black output 4 BMCA linking (PTP2) 1 = enable 2 = disable
I44black4VitcNtsc {I44black4TBL.11}	R/W	Integer	Black output 4 timecode superimposition line (NTSC) 10 = vitc-ntsc-10 11 = vitc-ntsc-11 12 = vitc-ntsc-12 13 = vitc-ntsc-13 14 = vitc-ntsc-14 15 = vitc-ntsc-15 16 = vitc-ntsc-16 17 = vitc-ntsc-17 18 = vitc-ntsc-18 19 = vitc-ntsc-19 20 = vitc-ntsc-20
I44black4VitcPal {I44black4TBL.12}	R/W	Integer	Black output 4 timecode superimposition line (PAL) 6 = vitc-pal-6 7 = vitc-pal-7 8 = vitc-pal-8 9 = vitc-pal-9 10 = vitc-pal-10 11 = vitc-pal-11 12 = vitc-pal-12 13 = vitc-pal-13 14 = vitc-pal-14 15 = vitc-pal-15 16 = vitc-pal-16

OID	Access	Syntax	Description
			17 = vitc-pal-17 18 = vitc-pal-18 19 = vitc-pal-19 20 = vitc-pal-20 21 = vitc-pal-21 22 = vitc-pal-22
I44black5TBL {I44blackTBL.5}	-	Aggregate	-
I44black5EqualToBlack1 {I44black5TBL.1}	R/W	Integer	Setting shared by black output 5 and black output 1 1 = off 2 = on
I44black5Format {I44black5TBL.2}	R/W	Integer	Black output 5 format 2 = f1125-60i 3 = f1125-59p94i 4 = f1125-50i 5 = f1125-30p 6 = f1125-29p97p 7 = f1125-25p 8 = f1125-24p 9 = f1125-23p98p 10 = f1125-24psf 11 = f1125-23p98psf 12 = f750-60p 13 = f750-59p94p 14 = f750-50p 15 = f750-30p 16 = f750-29p97p 17 = f750-25p 18 = f750-24p 19 = f750-23p98p 20 = fNTSC-BB 21 = fNTSC-BB-REF 22 = fNTSC-BB-ID 23 = fNTSC-BB-REF-ID 24 = fNTSC-BB-S 25 = fNTSC-BB-S-R 26 = fNTSC-BB-S-ID 27 = fNTSC-BB-S-R-ID 28 = f525-59p94i 29 = f525-59p94p 30 = fPAL-BB 31 = fPAL-BB-REF 32 = f625-50i 33 = f625-50p 34 = f1125-60p

OID	Access	Syntax	Description
			35 = f1125-59p94p 36 = f1125-50p
I44black5TimingFrame {I44black5TBL.3}	R/W	Integer	Black output 5 timing relative to the reference signal (in frames) ±5
I44black5TimingVertical {I44black5TBL.4}	R/W	Integer	Black output 5 timing relative to the reference signal (in lines) ±1125
I44black5TimingHorizontal {I44black5TBL.5}	R/W	Integer	Black output 5 timing relative to the reference signal (in dots) ±4124
I44black5Vitc {I44black5TBL.6}	R/W	Integer	Insertion of time code into black output 5 1 = off 2 = on
I44black5VitcDropframe {I44black5TBL.7}	R/W	Integer	Black output 5 dropped frame 1 = off 2 = on
I44black5Output {I44black5TBL.8}	R/W	Integer	Black output 5 1 = enable 2 = disable
I44black5OutputLinktoPtp1Bmca {I44black5TBL.9}	R/W	Integer	Black output 5 BMCA linking (PTP1) 1 = enable 2 = disable
I44black5OutputLinktoPtp2Bmca {I44black5TBL.10}	R/W	Integer	Black output 5 BMCA linking (PTP2) 1 = enable 2 = disable
I44black5VitcNtsc {I44black5TBL.11}	R/W	Integer	Black output 5 timecode superimposition line (NTSC) 10 = vitc-ntsc-10 11 = vitc-ntsc-11 12 = vitc-ntsc-12 13 = vitc-ntsc-13 14 = vitc-ntsc-14 15 = vitc-ntsc-15 16 = vitc-ntsc-16 17 = vitc-ntsc-17 18 = vitc-ntsc-18 19 = vitc-ntsc-19 20 = vitc-ntsc-20
I44black5VitcPal {I44black5TBL.12}	R/W	Integer	Black output 5 timecode superimposition line (PAL) 6 = vitc-pal-6 7 = vitc-pal-7 8 = vitc-pal-8 9 = vitc-pal-9 10 = vitc-pal-10

17 SNMP

OID	Access	Syntax	Description
			11 = vitc-pal-11 12 = vitc-pal-12 13 = vitc-pal-13 14 = vitc-pal-14 15 = vitc-pal-15 16 = vitc-pal-16 17 = vitc-pal-17 18 = vitc-pal-18 19 = vitc-pal-19 20 = vitc-pal-20 21 = vitc-pal-21 22 = vitc-pal-22
I44black6TBL {I44blackTBL.6}	-	Aggregate	-
I44black6EqualToBlack1 {I44black6TBL.1}	R/W	Integer	Setting shared by black output 6 and black output 1 1 = off 2 = on
I44black6Format {I44black6TBL.2}	R/W	Integer	Black output 6 format 2 = f1125-60i 3 = f1125-59p94i 4 = f1125-50i 5 = f1125-30p 6 = f1125-29p97p 7 = f1125-25p 8 = f1125-24p 9 = f1125-23p98p 10 = f1125-24psf 11 = f1125-23p98psf 12 = f750-60p 13 = f750-59p94p 14 = f750-50p 15 = f750-30p 16 = f750-29p97p 17 = f750-25p 18 = f750-24p 19 = f750-23p98p 20 = fNTSC-BB 21 = fNTSC-BB-REF 22 = fNTSC-BB-ID 23 = fNTSC-BB-REF-ID 24 = fNTSC-BB-S 25 = fNTSC-BB-S-R 26 = fNTSC-BB-S-ID 27 = fNTSC-BB-S-R-ID 28 = f525-59p94i

OID	Access	Syntax	Description
			29 = f525-59p94p 30 = fPAL-BB 31 = fPAL-BB-REF 32 = f625-50i 33 = f625-50p 34 = f1125-60p 35 = f1125-59p94p 36 = f1125-50p
I44black6TimingFrame {I44black6TBL.3}	R/W	Integer	Black output 6 timing relative to the reference signal (in frames) ±5
I44black6TimingVertical {I44black6TBL.4}	R/W	Integer	Black output 6 timing relative to the reference signal (in lines) ±1125
I44black6TimingHorizontal {I44black6TBL.5}	R/W	Integer	Black output 6 timing relative to the reference signal (in dots) ±4124
I44black6Vitc {I44black6TBL.6}	R/W	Integer	Insertion of time code into black output 6 1 = off 2 = on
I44black6VitcDropframe {I44black6TBL.7}	R/W	Integer	Black output 6 dropped frame 1 = off 2 = on
I44black6Output {I44black6TBL.8}	R/W	Integer	Black output 6 1 = enable 2 = disable
I44black6OutputLinktoPtp1Bmca {I44black6TBL.9}	R/W	Integer	Black output 6 BMCA linking (PTP1) 1 = enable 2 = disable
I44black6OutputLinktoPtp2Bmca {I44black6TBL.10}	R/W	Integer	Black output 6 BMCA linking (PTP2) 1 = enable 2 = disable
I44black6VitcNtsc {I44black6TBL.11}	R/W	Integer	Black output 6 timecode superimposition line (NTSC) 10 = vitc-ntsc-10 11 = vitc-ntsc-11 12 = vitc-ntsc-12 13 = vitc-ntsc-13 14 = vitc-ntsc-14 15 = vitc-ntsc-15 16 = vitc-ntsc-16 17 = vitc-ntsc-17 18 = vitc-ntsc-18 19 = vitc-ntsc-19 20 = vitc-ntsc-20
I44black6VitcPal	R/W	Integer	Black output 6 timecode superimposition line

OID	Access	Syntax	Description
{I44black6TBL.12}			(PAL) 6 = vitc-pal-6 7 = vitc-pal-7 8 = vitc-pal-8 9 = vitc-pal-9 10 = vitc-pal-10 11 = vitc-pal-11 12 = vitc-pal-12 13 = vitc-pal-13 14 = vitc-pal-14 15 = vitc-pal-15 16 = vitc-pal-16 17 = vitc-pal-17 18 = vitc-pal-18 19 = vitc-pal-19 20 = vitc-pal-20 21 = vitc-pal-21 22 = vitc-pal-22

17.4.6 I44audioTBL Group

Table 17-7 | I44audioTBL group

OID	Access	Syntax	Description
I44aesEbuTBL {I44audioTBL.1}	-	Aggregate	-
I44aesEbuCh1TBL {I44aesEbuTBL.1}	-	Aggregate	-
I44aesEbuCh1Frequency {I44aesEbuCh1TBL.2}	R/W	Integer	AES/EBU output CH1 frequency 1 = silence 8 = freq400Hz 12 = freq800Hz 13 = freq1000Hz
I44aesEbuCh1Level {I44aesEbuCh1TBL.3}	R/W	Integer	AES/EBU output CH1 level 0 - -60
I44aesEbuCh1Click {I44aesEbuCh1TBL.4}	R/W	Integer	AES/EBU output CH1 click insertion interval 1 = off 2 = click1sec 3 = click2sec 4 = click4sec
I44aesEbuCh2TBL {I44aesEbuTBL.2}	-	Aggregate	-
I44aesEbuEqualToCh1 {I44aesEbuCh2TBL.1}	R/W	Integer	Setting shared by AES/EBU output CH2 and CH1 1 = off 2 = on
I44aesEbuCh2Frequency {I44aesEbuCh2TBL.2}	R/W	Integer	AES/EBU output CH2 frequency 1 = silence

OID	Access	Syntax	Description
			8 = freq400Hz 12 = freq800Hz 13 = freq1000Hz
I44aesEbuCh2Level {I44aesEbuCh2TBL.3}	R/W	Integer	AES/EBU output CH2 level 0 - -60
I44aesEbuCh2Click {I44aesEbuCh2TBL.4}	R/W	Integer	AES/EBU output CH2 click insertion interval 1 = off 2 = click1sec 3 = click2sec 4 = click4sec
I44aesEbuResolution {I44aesEbuTBL.3}	R/W	Integer	AES/EBU output resolution 1 = resolution20bit 2 = resolution24bit
I44aesEbuEmphasis {I44aesEbuTBL.4}	R/W	Integer	AES/EBU output pre-emphasis mode 1 = emphasis50-15 2 = ccittl 3 = off
I44aesEbuTimecode {I44aesEbuTBL.5}	R/W	Integer	Insertion of time code into AES/EBU output 1 = off 2 = on
I44aesEbuTiming {I44aesEbuTBL.6}	R/W	Integer	AES/EBU output timing relative to the reference signal ±511
I44aesEbuLipsync {I44aesEbuTBL.7}	R/W	Integer	AES/EBU output lip sync linking 1 = off 2 = on
I44silenceTBL {I44audioTBL.2}	-	Aggregate	-
I44silenceEqualToAesEbu {I44silenceTBL.1}	R/W	Integer	Setting shared by silence output and AES/EBU output 1 = off 2 = on
I44silenceResolution {I44silenceTBL.2}	R/W	Integer	Silence output resolution 1 = resolution20bit 2 = resolution24bit
I44silenceTiming {I44silenceTBL.3}	R/W	Integer	Silence output timing relative to the reference signal ±511
I44wclkTBL {I44audioTBL.3}	-	Aggregate	-
I44wclkTiming {I44wclkTBL.2}	R/W	Integer	Word-clock timing relative to the reference signal ±511

17.4.7 I44ltcTBL Group

Table 17-8 | I44ltcTBL group

OID	Access	Syntax	Description
I44ltc1TBL {I44ltcTBL.1}	-	Aggregate	-
I44ltc1 {I44ltc1TBL.2}	R/W	Integer	LTC output 1 1 = off 2 = on
I44ltc1Format {I44ltc1TBL.3}	R/W	Integer	LTC output 1 format 1 = f30 2 = f29p97 3 = f25 4 = f24 5 = f23p98
I44ltc1TimingFrame {I44ltc1TBL.4}	R/W	Integer	LTC output 1 timing relative to the reference signal (in frames) ±29
I44ltc1TimingBit {I44ltc1TBL.5}	R/W	Integer	LTC output 1 timing relative to the reference signal (in bits) ±39
I44ltc1OffsetTBL {I44ltc1TBL.6}	-	Aggregate	-
I44ltc1OffsetSign {I44ltc1OffsetTBL.1}	R/W	Integer	LTC output 1 offset relative to the reference signal (sign) 1 = minus 2 = plus
I44ltc1OffsetHour {I44ltc1OffsetTBL.2}	R/W	Integer	LTC output 1 offset relative to the reference signal (hours) 0 - 23
I44ltc1OffsetMinute {I44ltc1OffsetTBL.3}	R/W	Integer	LTC output 1 offset relative to the reference signal (minutes) 0 - 59
I44ltc1OffSecond {I44ltc1OffsetTBL.4}	R/W	Integer	LTC output 1 offset relative to the reference signal (seconds) 0 - 59
I44ltc1DropFrame {I44ltc1TBL.7}	R/W	Integer	LTC output 1 dropped frame 1 = off 2 = on
I44ltc2TBL {I44ltcTBL.2}	-	Aggregate	-
I44ltc2EqualToLtc1 {I44ltc2TBL.1}	R/W	Integer	Setting shared by LTC output 2 and LTC output 1 1 = off 2 = on
I44ltc2 {I44ltc2TBL.2}	R/W	Integer	LTC output 2 1 = off

OID	Access	Syntax	Description
			2 = on
I44ltc2Format {I44ltc2TBL.3}	R/W	Integer	LTC output 2 format 1 = f30 2 = f29p97 3 = f25 4 = f24 5 = f23p98
I44ltc2TimingFrame {I44ltc2TBL.4}	R/W	Integer	LTC output 2 timing relative to the reference signal (in frames) ±29
I44ltc2TimingBit {I44ltc2TBL.5}	R/W	Integer	LTC output 2 timing relative to the reference signal (in bits) ±39
I44ltc2OffsetTBL {I44ltc2TBL.6}	-	Aggregate	-
I44ltc2OffsetSign {I44ltc2OffsetTBL.1}	R/W	Integer	LTC output 2 offset relative to the reference signal (sign) 1 = minus 2 = plus
I44ltc2OffsetHour {I44ltc2OffsetTBL.2}	R/W	Integer	LTC output 2 offset relative to the reference signal (hours) 0 - 23
I44ltc2OffsetMinute {I44ltc2OffsetTBL.3}	R/W	Integer	LTC output 2 offset relative to the reference signal (minutes) 0 - 59
I44ltc2OffSecond {I44ltc2OffsetTBL.4}	R/W	Integer	LTC output 2 offset relative to the reference signal (seconds) 0 - 59
I44ltc2DropFrame {I44ltc2TBL.7}	R/W	Integer	LTC output 2 dropped frame 1 = off 2 = on
I44ltc3TBL {I44ltc3TBL.3}	-	Aggregate	-
I44ltc3EqualToLtc1 {I44ltc3TBL.1}	R/W	Integer	Setting shared by LTC output 3 and LTC output 1 1 = off 2 = on
I44ltc3 {I44ltc3TBL.2}	R/W	Integer	LTC output 3 1 = off 2 = on
I44ltc3Format {I44ltc3TBL.3}	R/W	Integer	LTC output 3 format 1 = f30 2 = f29p97 3 = f25 4 = f24 5 = f23p98

OID	Access	Syntax	Description
I44ltc3TimingFrame {I44ltc3TBL.4}	R/W	Integer	LTC output 3 timing relative to the reference signal (in frames) ±29
I44ltc3TimingBit {I44ltc3TBL.5}	R/W	Integer	LTC output 3 timing relative to the reference signal (in bits) ±39
I44ltc3OffsetTBL {I44ltc3TBL.6}	-	Aggregate	-
I44ltc3OffsetSign {I44ltc3OffsetTBL.1}	R/W	Integer	LTC output 3 offset relative to the reference signal (sign) 1 = minus 2 = plus
I44ltc3OffsetHour {I44ltc3OffsetTBL.2}	R/W	Integer	LTC output 3 offset relative to the reference signal (hours) 0 - 23
I44ltc3OffsetMinute {I44ltc3OffsetTBL.3}	R/W	Integer	LTC output 3 offset relative to the reference signal (minutes) 0 - 59
I44ltc3OffSecond {I44ltc3OffsetTBL.4}	R/W	Integer	LTC output 3 offset relative to the reference signal (seconds) 0 - 59
I44ltc3DropFrame {I44ltc3TBL.7}	R/W	Integer	LTC output 3 dropped frame 1 = off 2 = on

17.4.8 I44cw1ppsTBL Group

Table 17-9 | I44cw1ppsTBL group

OID	Access	Syntax	Description
I44output {I44cw1ppsTBL.1}	R/W	Integer	Output signal from the CW/1PPS connector 1 = out-cw 2 = out-1pps

17.4.9 I44trapTBL Group

Table 17-10 | I44trapTBL group

OID	Access	Syntax	Description
I44trapIpTBL {I44trapTBL.1}	-	Aggregate	-
I44trapIp1TBL {I44trapIpTBL.1}	-	Aggregate	-
I44trapManagerIp1 {I44trapIp1TBL.1}	R/W	IpAddress	IP address of trap transmission destination 1 xxx.xxx.xxx.xxx
I44trapManagerIp1Act {I44trapIp1TBL.2}	R/W	Integer	Trap transmission destination 1 1 = enable 2 = disable
I44trapManagerIp2	R/W	IpAddress	IP address of trap transmission destination 2

OID	Access	Syntax	Description
{I44trapIp1TBL.3}			xxx.xxx.xxx.xxx
I44trapManagerIp2Act {I44trapIp1TBL.4}	R/W	Integer	Trap transmission destination 2 1 = enable 2 = disable
I44trapManagerIp3 {I44trapIp1TBL.5}	R/W	IpAddress	IP address of trap transmission destination 3 xxx.xxx.xxx.xxx
I44trapManagerIp3Act {I44trapIp1TBL.6}	R/W	Integer	Trap transmission destination 3 1 = enable 2 = disable
I44trapManagerIp4 {I44trapIp1TBL.7}	R/W	IpAddress	IP address of trap transmission destination 4 xxx.xxx.xxx.xxx
I44trapManagerIp4Act {I44trapIp1TBL.8}	R/W	Integer	Trap transmission destination 4 1 = enable 2 = disable

17.4.10 It4670ser02 Group

Table 17-11 | It4670ser02 group

OID	Access	Syntax	Description
I44sdi1TBL {It4670ser02.1}	-	Aggregate	-
I44sdi1EqualToSDI1TBL {I44sdi1TBL.1}	-	Aggregate	-
I44sdi1FormatTBL {I44sdi1TBL.2}	-	Aggregate	-
I44sdi1System {I44sdi1FormatTBL.1}	R/W	Integer	SDI output 1 format 1 = f720x487-SD 2 = f720x576-SD 3 = f1280x720-HD 4 = f1920x1080-HD 5 = f1280x720-3G-A 6 = f1920x1080-3G-A 7 = f1920x1080-3G-B-DL 8 = f3840x2160-3G-A-QL 9 = f4096x2160-3G-A-QL 10 = f3840x2160-3G-B-DL-QL 11 = f4096x2160-3G-B-DL-QL 12 = f3840x2160-12G 13 = f4096x2160-12G
I44sdi1Structure {I44sdi1FormatTBL.2}	R/W	Integer	Color system and quantization accuracy of SDI output 1 1 = fYCbCr-422-10bit 2 = fYCbCr-422-12bit 3 = fRGB-444-10bit 4 = fRGB-444-12bit
I44sdi1Framerate	R/W	Integer	SDI output 1 frame (field) frequency

OID	Access	Syntax	Description
{I44sdi1FormatTBL.3}			1 = f60p 2 = f59p94p 3 = f50p 4 = f48p 5 = f30p 6 = f29p97p 7 = f25p 8 = f47p95p 9 = f24p 10 = f23p98p 11 = f30psf 12 = f29.97psf 13 = f25psf 14 = f24psF 15 = f23p98psf 16 = f60i 17 = f59.94i 18 = f50i
I44sdi1TimingTBL {I44sdi1TBL.3}	-	Aggregate	-
I44sdi10HTiming {I44sdi1TimingTBL.1}	R/W	Integer	Reference timing for SDI output 1 1 = serial 2 = legacy
I44sdi1TimingVertical {I44sdi1TimingTBL.2}	R/W	Integer	SDI output 1 timing relative to the reference signal (in lines) ±1124
I44sdi1TimingHorizontal {I44sdi1TimingTBL.3}	R/W	Integer	SDI output 1 timing relative to the reference signal (in dots) ±4124
I44sdi1PatternTBL {I44sdi1TBL.4}	-	Aggregate	-
I44sdi1Pattern {I44sdi1PatternTBL.1}	R/W	Integer	SDI output 1 pattern 1 = colorbar100 2 = colorbar75 3 = multiCB100 4 = multiCB75 5 = multiCBplusI 6 = smpteCB 7 = ebuColorbar 8 = bbcColorbar 9 = flatField100 10 = flatField50 11 = flatField0 12 = redFiled 13 = greenField 14 = blueField

OID	Access	Syntax	Description
			15 = checkfield
I44sdi1VideoTBL {I44sdi1TBL.5}	-	Aggregate	-
I44sdi1ComponentTBL {I44sdi1VideoTBL.1}	-	Aggregate	-
I44sdi1Component {I44sdi1ComponentTBL.1}	R/W	Integer	SDI output 1 component (Y/G-Cb/B-Cr/R) 1 = off-off-off 2 = on-off-off 3 = off-on-off 4 = on-on-off 5 = off-off-on 6 = on-off-on 7 = off-on-on 8 = on-on-on
I44sdi1SafetyAreaTBL {I44sdi1VideoTBL.2}	-	Aggregate	-
I44sdi1SafetyArea90 {I44sdi1SafetyAreaTBL.1}	R/W	Integer	90% safety area marker of SDI output 1 1 = off 2 = on
I44sdi1SafetyArea80 {I44sdi1SafetyAreaTBL.2}	R/W	Integer	80% safety area marker of SDI output 1 1 = off 2 = on
I44sdi1SafetyArea43 {I44sdi1SafetyAreaTBL.3}	R/W	Integer	4:3 safety area marker of SDI output 1 1 = off 2 = on
I44sdi1ScrollTBL {I44sdi1VideoTBL.3}	-	Aggregate	-
I44sdi1Scroll {I44sdi1ScrollTBL.1}	R/W	Integer	SDI output 1 scroll 1 = off 2 = on
I44sdi1ScrollVspeed {I44sdi1ScrollTBL.2}	R/W	Integer	Vertical scroll speed and direction of SDI output 1 ±256
I44sdi1ScrollHspeed {I44sdi1ScrollTBL.3}	R/W	Integer	Horizontal scroll speed and direction of SDI output 1 ±256
I44sdi1PatternChangeTBL {I44sdi1VideoTBL.4}	-	Aggregate	-
I44sdi1PatternChange {I44sdi1PatternChangeTBL.1}	R/W	Integer	SDI output 1 pattern change 1 = off 2 = on
I44sdi1PatrnChangespeed {I44sdi1PatternChangeTBL.2}	R/W	Integer	SDI output 1 pattern switching interval 1 - 255
I44sdi1IdCharacterTBL {I44sdi1VideoTBL.5}	-	Aggregate	-
I44sdi1IdCharacter	R/W	Integer	SDI output 1 ID characters

OID	Access	Syntax	Description
{I44sdi1IdCharacterTBL.1}			1 = off 2 = on
I44sdi1IdCharacterVposition {I44sdi1IdCharacterTBL.2}	R/W	Integer	Vertical ID character position of SDI output 1 0 - 100
I44sdi1IdCharacterHposition {I44sdi1IdCharacterTBL.3}	R/W	Integer	Horizontal ID character position of SDI output 1 0 - 100
I44sdi1IdCharacterSize {I44sdi1IdCharacterTBL.4}	R/W	Integer	SDI output 1 ID character size 1 = x1 2 = x2 3 = x4 4 = x8
I44sdi1IdCharacterLevel {I44sdi1IdCharacterTBL.5}	R/W	Integer	SDI output 1 ID character luminance level 1 = per-100 2 = per-75
I44sdi1IdCharacterBlinkTBL {I44sdi1IdCharacterTBL.6}	-	Aggregate	-
I44sdi1IdCharacterBlink {I44sdi1IdCharacterBlinkTBL.1}	R/W	Integer	SDI output 1 ID character blinking 1 = off 2 = on
I44sdi1IdCharacterBlinkOffTime {I44sdi1IdCharacterBlinkTBL.2}	R/W	Integer	SDI output 1 ID character blinking off-time 1 - 9
I44sdi1IdCharacterBlinkOnTime {I44sdi1IdCharacterBlinkTBL.3}	R/W	Integer	SDI output 1 ID character blinking on-time 1 - 9
I44sdi1IdCharacterScrollTBL {I44sdi1IdCharacterTBL.7}	-	Aggregate	-
I44sdi1IdCharacterScroll {I44sdi1IdCharacterScrollTBL.1}	R/W	Integer	SDI output 1 ID character scroll 1 = off 2 = on
I44sdi1IdCharacterScrollSpeed {I44sdi1IdCharacterScrollTBL.2}	R/W	Integer	SDI output 1 ID character scroll speed and direction ±256
I44sdi1IdCharacterBackground {I44sdi1IdCharacterTBL.8}	R/W	Integer	SDI output 1 ID character background transparency 1 = off 2 = on
I44sdi1LogoTBL {I44sdi1VideoTBL.6}	-	Aggregate	-
I44sdi1Logo {I44sdi1LogoTBL.1}	R/W	Integer	SDI output 1 logo 1 = off 2 = on
I44sdi1LogoSelect {I44sdi1LogoTBL.2}	R/W	Integer	SDI output 1 logo number 1 - 4
I44sdi1LogoVposition {I44sdi1LogoTBL.3}	R/W	Integer	Vertical logo position of SDI output 1 0 - 100
I44sdi1LogoHposition {I44sdi1LogoTBL.4}	R/W	Integer	Horizontal logo position of SDI output 1 0 - 100

OID	Access	Syntax	Description
I44sdi1LogoTransParency {I44sdi1LogoTBL.5}	R/W	Integer	SDI output 1 logo transparency 1 = off 2 = on
I44sdi1LogoTransParencyLevel {I44sdi1LogoTBL.6}	R/W	Integer	SDI output 1 logo transparency level 0 - 255
I44sdi1MovingBoxTBL {I44sdi1VideoTBL.7}	-	Aggregate	-
I44sdi1MovingBox {I44sdi1MovingBoxTBL.1}	R/W	Integer	SDI output 1 moving box 1 = off 2 = on
I44sdi1MovingBoxColor {I44sdi1MovingBoxTBL.2}	R/W	Integer	SDI output 1 moving box color 1 = white 2 = yellow 3 = cyan 4 = green 5 = blue 6 = red 7 = magenta 8 = black
I44sdi1MovingBoxVspeed {I44sdi1MovingBoxTBL.3}	R/W	Integer	Vertical moving box speed of SDI output 1 1 = low 2 = middle 3 = high
I44sdi1MovingBoxHspeed {I44sdi1MovingBoxTBL.4}	R/W	Integer	Horizontal moving box speed of SDI output 1 1 = low 2 = middle 3 = high
I44sdi1MovingBoxVsize {I44sdi1MovingBoxTBL.5}	R/W	Integer	SDI output 1 moving box height 1 = size1 2 = size2 3 = size3 4 = size4 5 = size5
I44sdi1MovingBoxHsize {I44sdi1MovingBoxTBL.6}	R/W	Integer	SDI output 1 moving box width 1 = size1 2 = size2 3 = size3 4 = size4 5 = size5
I44sdi1CircleTBL {I44sdi1VideoTBL.8}	-	Aggregate	-
I44sdi1Circle {I44sdi1CircleTBL.1}	R/W	Integer	SDI output 1 circle 1 = off 2 = on
I44sdi1CircleSize {I44sdi1CircleTBL.2}	R/W	Integer	SDI output 1 circle size 1 = per-90

OID	Access	Syntax	Description
			2 = per-80 3 = per-70
I44sdi1CircleLevel {I44sdi1CircleTBL.3}	R/W	Integer	SDI output 1 circle luminance level 1 = per-100 2 = per-75
I44sdi1CircleBlinkTBL {I44sdi1CircleTBL.4}	-	Aggregate	-
I44sdi1CircleBlink {I44sdi1CircleBlinkTBL.1}	R/W	Integer	SDI output 1 circle blinking 1 = off 2 = on
I44sdi1CircleBlinkOffTime {I44sdi1CircleBlinkTBL.2}	R/W	Integer	SDI output 1 circle blinking off-time 1 - 9
I44sdi1CircleBlinkOnTime {I44sdi1CircleBlinkTBL.3}	R/W	Integer	SDI output 1 circle blinking on-time 1 - 9
I44sdi1TimecodeTBL {I44sdi1VideoTBL.9}	-	Aggregate	-
I44sdi1Timecode {I44sdi1TimecodeTBL.1}	R/W	Integer	SDI output 1 time code 1 = off 2 = on
I44sdi1TimecodeVposition {I44sdi1TimecodeTBL.2}	R/W	Integer	Vertical time code position of SDI output 1 0 - 100
I44sdi1TimecodeHposition {I44sdi1TimecodeTBL.3}	R/W	Integer	Horizontal time code position of SDI output 1 0 - 100
I44sdi1TimecodeSize {I44sdi1TimecodeTBL.4}	R/W	Integer	SDI output 1 time code size 1 = x1 2 = x2 3 = x4 4 = x8
I44sdi1TimecodeLevel {I44sdi1TimecodeTBL.5}	R/W	Integer	SDI output 1 time code luminance level 1 = per-100 2 = per-75
I44sdi1TimecodeBackground {I44sdi1TimecodeTBL.6}	R/W	Integer	SDI output 1 time code background transparency 1 = off 2 = on
I44sdi1LipsyncTBL {I44sdi1VideoTBL.10}	-	Aggregate	-
I44sdi1Lipsync {I44sdi1LipsyncTBL.1}	R/W	Integer	SDI output 1 lip sync pattern 1 = off 2 = on
I44sdi1AudioTBL {I44sdi1TBL.6}	-	Aggregate	-
I44sdi1AudioGroup1TBL {I44sdi1AudioTBL.1}	-	Aggregate	-
I44sdi1AudioGroup1 {I44sdi1AudioGroup1TBL.1}	R/W	Integer	SDI output 1 audio group 1 1 = off

OID	Access	Syntax	Description
			2 = on
I44sdi1AudioGroup1Ch1TBL {I44sdi1AudioGroup1TBL.3}	-	Aggregate	-
I44sdi1AudioGroup1Ch1Frequency {I44sdi1AudioGroup1Ch1TBL.2}	R/W	Integer	SDI output 1 CH1 frequency 1 = silence 2 = freq400Hz 3 = freq800Hz 4 = freq1000Hz
I44sdi1AudioGroup1Ch1Level {I44sdi1AudioGroup1Ch1TBL.3}	R/W	Integer	SDI output 1 CH1 level 0 - -60
I44sdi1AudioGroup1Ch1Click {I44sdi1AudioGroup1Ch1TBL.4}	R/W	Integer	SDI output 1 CH1 click insertion interval 1 = off 2 = click1sec 3 = click2sec 4 = click4sec
I44sdi1AudioGroup1Ch2TBL {I44sdi1AudioGroup1TBL.4}	-	Aggregate	-
I44sdi1AudioGroup1Ch2EqualToCh1 {I44sdi1AudioGroup1Ch2TBL.1}	R/W	Integer	Setting shared by SDI output 1 CH2 and CH1 1 = off 2 = on
I44sdi1AudioGroup1Ch2Frequency {I44sdi1AudioGroup1Ch2TBL.2}	R/W	Integer	SDI output 1 CH2 frequency 1 = silence 2 = freq400Hz 3 = freq800Hz 4 = freq1000Hz
I44sdi1AudioGroup1Ch2Level {I44sdi1AudioGroup1Ch2TBL.3}	R/W	Integer	SDI output 1 CH2 level 0 - -60
I44sdi1AudioGroup1Ch2Click {I44sdi1AudioGroup1Ch2TBL.4}	R/W	Integer	SDI output 1 CH2 click insertion interval 1 = off 2 = click1sec 3 = click2sec 4 = click4sec
I44sdi1AudioGroup1Ch3TBL {I44sdi1AudioGroup1TBL.5}	-	Aggregate	-
I44sdi1AudioGroup1Ch3EqualToCh1 {I44sdi1AudioGroup1Ch3TBL.1}	R/W	Integer	Setting shared by SDI output 1 CH3 and CH1 1 = off 2 = on
I44sdi1AudioGroup1Ch3Frequency {I44sdi1AudioGroup1Ch3TBL.2}	R/W	Integer	SDI output 1 CH3 frequency 1 = silence 2 = freq400Hz 3 = freq800Hz 4 = freq1000Hz
I44sdi1AudioGroup1Ch3Level {I44sdi1AudioGroup1Ch3TBL.3}	R/W	Integer	SDI output 1 CH3 level 0 - -60
I44sdi1AudioGroup1Ch3Click {I44sdi1AudioGroup1Ch3TBL.4}	R/W	Integer	SDI output 1 CH3 click insertion interval 1 = off

OID	Access	Syntax	Description
			2 = click1sec 3 = click2sec 4 = click4sec
I44sdi1AudioGroup1Ch4TBL {I44sdi1AudioGroup1TBL.6}	-	Aggregate	-
I44sdi1AudioGroup1Ch4EqualToCh1 {I44sdi1AudioGroup1Ch4TBL.1}	R/W	Integer	Setting shared by SDI output 1 CH4 and CH1 1 = off 2 = on
I44sdi1AudioGroup1Ch4Frequency {I44sdi1AudioGroup1Ch4TBL.2}	R/W	Integer	SDI output 1 CH4 frequency 1 = silence 2 = freq400Hz 3 = freq800Hz 4 = freq1000Hz
I44sdi1AudioGroup1Ch4Level {I44sdi1AudioGroup1Ch4TBL.3}	R/W	Integer	SDI output 1 CH4 level 0 - -60
I44sdi1AudioGroup1Ch4Click {I44sdi1AudioGroup1Ch4TBL.4}	R/W	Integer	SDI output 1 CH4 click insertion interval 1 = off 2 = click1sec 3 = click2sec 4 = click4sec
I44sdi1AudioGroup1Resolution {I44sdi1AudioGroup1TBL.7}	R/W	Integer	SDI output 1 audio group 1 resolution 1 = resolution20bit 2 = resolution24bit
I44sdi1AudioGroup1Emphasis {I44sdi1AudioGroup1TBL.8}	R/W	Integer	SDI output 1 audio group 1 pre-emphasis mode 1 = emphasis50-15 2 = ccittl 3 = off
I44sdi1AudioGroup2TBL {I44sdi1AudioTBL.2}	-	Aggregate	-
I44sdi1AudioGroup2 {I44sdi1AudioGroup2TBL.1}	R/W	Integer	SDI output 1 audio group 2 1 = off 2 = on
I44sdi1AudioGroup2EqualToG1 {I44sdi1AudioGroup2TBL.2}	R/W	Integer	Setting shared by SDI output 1 audio group 2 and audio group 1 1 = off 2 = on
I44sdi1AudioGroup2Ch5TBL {I44sdi1AudioGroup2TBL.3}	-	Aggregate	-
I44sdi1AudioGroup2Ch5Frequency {I44sdi1AudioGroup2Ch5TBL.2}	R/W	Integer	SDI output 1 CH5 frequency 1 = silence 2 = freq400Hz 3 = freq800Hz 4 = freq1000Hz
I44sdi1AudioGroup2Ch5Level {I44sdi1AudioGroup2Ch5TBL.3}	R/W	Integer	SDI output 1 CH5 level 0 - -60
I44sdi1AudioGroup2Ch5Click	R/W	Integer	SDI output 1 CH5 click insertion interval

OID	Access	Syntax	Description
{I44sdi1AudioGroup2Ch5TBL.4}			1 = off 2 = click1sec 3 = click2sec 4 = click4sec
I44sdi1AudioGroup2Ch6TBL {I44sdi1AudioGroup2TBL.4}	-	Aggregate	-
I44sdi1AudioGroup2Ch6EqualToCh5 {I44sdi1AudioGroup2Ch6TBL.1}	R/W	Integer	Setting shared by SDI output 1 CH6 and CH5 1 = off 2 = on
I44sdi1AudioGroup2Ch6Frequency {I44sdi1AudioGroup2Ch6TBL.2}	R/W	Integer	SDI output 1 CH6 frequency 1 = silence 2 = freq400Hz 3 = freq800Hz 4 = freq1000Hz
I44sdi1AudioGroup2Ch6Level {I44sdi1AudioGroup2Ch6TBL.3}	R/W	Integer	SDI output 1 CH6 level 0 - -60
I44sdi1AudioGroup2Ch6Click {I44sdi1AudioGroup2Ch6TBL.4}	R/W	Integer	SDI output 1 CH6 click insertion interval 1 = off 2 = click1sec 3 = click2sec 4 = click4sec
I44sdi1AudioGroup2Ch7TBL {I44sdi1AudioGroup2TBL.5}	-	Aggregate	-
I44sdi1AudioGroup2Ch7EqualToCh5 {I44sdi1AudioGroup2Ch7TBL.1}	R/W	Integer	Setting shared by SDI output 1 CH7 and CH5 1 = off 2 = on
I44sdi1AudioGroup2Ch7Frequency {I44sdi1AudioGroup2Ch7TBL.2}	R/W	Integer	SDI output 1 CH7 frequency 1 = silence 2 = freq400Hz 3 = freq800Hz 4 = freq1000Hz
I44sdi1AudioGroup2Ch7Level {I44sdi1AudioGroup2Ch7TBL.3}	R/W	Integer	SDI output 1 CH7 level 0 - -60
I44sdi1AudioGroup2Ch7Click {I44sdi1AudioGroup2Ch7TBL.4}	R/W	Integer	SDI output 1 CH7 click insertion interval 1 = off 2 = click1sec 3 = click2sec 4 = click4sec
I44sdi1AudioGroup2Ch8TBL {I44sdi1AudioGroup2TBL.6}	-	Aggregate	-
I44sdi1AudioGroup2Ch8EqualToCh5 {I44sdi1AudioGroup2Ch8TBL.1}	R/W	Integer	Setting shared by SDI output 1 CH8 and CH5 1 = off 2 = on
I44sdi1AudioGroup2Ch8Frequency {I44sdi1AudioGroup2Ch8TBL.2}	R/W	Integer	SDI output 1 CH8 frequency 1 = silence 2 = freq400Hz

OID	Access	Syntax	Description
			3 = freq800Hz 4 = freq1000Hz
I44sdi1AudioGroup2Ch8Level {I44sdi1AudioGroup2Ch8TBL.3}	R/W	Integer	SDI output 1 CH8 level 0 - -60
I44sdi1AudioGroup2Ch8Click {I44sdi1AudioGroup2Ch8TBL.4}	R/W	Integer	SDI output 1 CH8 click insertion interval 1 = off 2 = click1sec 3 = click2sec 4 = click4sec
I44sdi1AudioGroup2Resolution {I44sdi1AudioGroup2TBL.7}	R/W	Integer	SDI output 1 audio group 2 resolution 1 = resolution20bit 2 = resolution24bit
I44sdi1AudioGroup2Emphasis {I44sdi1AudioGroup2TBL.8}	R/W	Integer	SDI output 1 audio group 2 pre-emphasis mode 1 = emphasis50-15 2 = ccittl 3 = off
I44sdi1AudioGroup3TBL {I44sdi1AudioTBL.3}	-	Aggregate	-
I44sdi1AudioGroup3 {I44sdi1AudioGroup3TBL.1}	R/W	Integer	SDI output 1 audio group 3 1 = off 2 = on
I44sdi1AudioGroup3EqualToG1 {I44sdi1AudioGroup3TBL.2}	R/W	Integer	Setting shared by SDI output 1 audio group 3 and audio group 1 1 = off 2 = on
I44sdi1AudioGroup3Ch9TBL {I44sdi1AudioGroup3TBL.3}	-	Aggregate	-
I44sdi1AudioGroup3Ch9Frequency {I44sdi1AudioGroup3Ch9TBL.2}	R/W	Integer	SDI output 1 CH9 frequency 1 = silence 2 = freq400Hz 3 = freq800Hz 4 = freq1000Hz
I44sdi1AudioGroup3Ch9Level {I44sdi1AudioGroup3Ch9TBL.3}	R/W	Integer	SDI output 1 CH9 level 0 - -60
I44sdi1AudioGroup3Ch9Click {I44sdi1AudioGroup3Ch9TBL.4}	R/W	Integer	SDI output 1 CH9 click insertion interval 1 = off 2 = click1sec 3 = click2sec 4 = click4sec
I44sdi1AudioGroup3Ch10TBL {I44sdi1AudioGroup3TBL.4}	-	Aggregate	-
I44sdi1AudioGroup3Ch10EqualToCh9 {I44sdi1AudioGroup3Ch10TBL.1}	R/W	Integer	Setting shared by SDI output 1 CH10 and CH9 1 = off 2 = on
I44sdi1AudioGroup3Ch10Frequency {I44sdi1AudioGroup3Ch10TBL.2}	R/W	Integer	SDI output 1 CH10 frequency 1 = silence

OID	Access	Syntax	Description
			2 = freq400Hz 3 = freq800Hz 4 = freq1000Hz
I44sdi1AudioGroup3Ch10Level {I44sdi1AudioGroup3Ch10TBL.3}	R/W	Integer	SDI output 1 CH10 level 0 - -60
I44sdi1AudioGroup3Ch10Click {I44sdi1AudioGroup3Ch10TBL.4}	R/W	Integer	SDI output 1 CH10 click insertion interval 1 = off 2 = click1sec 3 = click2sec 4 = click4sec
I44sdi1AudioGroup3Ch11TBL {I44sdi1AudioGroup3TBL.5}	-	Aggregate	-
I44sdi1AudioGroup3Ch11EqualToCh9 {I44sdi1AudioGroup3Ch11TBL.1}	R/W	Integer	Setting shared by SDI output 1 CH11 and CH9 1 = off 2 = on
I44sdi1AudioGroup3Ch11Frequency {I44sdi1AudioGroup3Ch11TBL.2}	R/W	Integer	SDI output 1 CH11 frequency 1 = silence 2 = freq400Hz 3 = freq800Hz 4 = freq1000Hz
I44sdi1AudioGroup3Ch11Level {I44sdi1AudioGroup3Ch11TBL.3}	R/W	Integer	SDI output 1 CH11 level 0 - -60
I44sdi1AudioGroup3Ch11Click {I44sdi1AudioGroup3Ch11TBL.4}	R/W	Integer	SDI output 1 CH11 click insertion interval 1 = off 2 = click1sec 3 = click2sec 4 = click4sec
I44sdi1AudioGroup3Ch12TBL {I44sdi1AudioGroup3TBL.6}	-	Aggregate	-
I44sdi1AudioGroup3Ch12EqualToCh9 {I44sdi1AudioGroup3Ch12TBL.1}	R/W	Integer	Setting shared by SDI output 1 CH12 and CH9 1 = off 2 = on
I44sdi1AudioGroup3Ch12Frequency {I44sdi1AudioGroup3Ch12TBL.2}	R/W	Integer	SDI output 1 CH12 frequency 1 = silence 2 = freq400Hz 3 = freq800Hz 4 = freq1000Hz
I44sdi1AudioGroup3Ch12Level {I44sdi1AudioGroup3Ch12TBL.3}	R/W	Integer	SDI output 1 CH12 level 0 - -60
I44sdi1AudioGroup3Ch12Click {I44sdi1AudioGroup3Ch12TBL.4}	R/W	Integer	SDI output 1 CH12 click insertion interval 1 = off 2 = click1sec 3 = click2sec 4 = click4sec
I44sdi1AudioGroup3Resolution {I44sdi1AudioGroup3TBL.7}	R/W	Integer	SDI output 1 audio group 3 resolution 1 = resolution20bit

OID	Access	Syntax	Description
			2 = resolution24bit
I44sdi1AudioGroup3Emphasis {I44sdi1AudioGroup3TBL.8}	R/W	Integer	SDI output 1 audio group 3 pre-emphasis mode 1 = emphasis50-15 2 = ccittl 3 = off
I44sdi1AudioGroup4TBL {I44sdi1AudioTBL.4}	-	Aggregate	-
I44sdi1AudioGroup4 {I44sdi1AudioGroup4TBL.1}	R/W	Integer	SDI output 1 audio group 4 1 = off 2 = on
I44sdi1AudioGroup4EqualToG3 {I44sdi1AudioGroup4TBL.2}	R/W	Integer	Setting shared by SDI output 1 audio group 4 and audio group 3 1 = off 2 = on
I44sdi1AudioGroup4Ch13TBL {I44sdi1AudioGroup4TBL.3}	-	Aggregate	-
I44sdi1AudioGroup4Ch13Frequency {I44sdi1AudioGroup4Ch13TBL.2}	R/W	Integer	SDI output 1 CH13 frequency 1 = silence 2 = freq400Hz 3 = freq800Hz 4 = freq1000Hz
I44sdi1AudioGroup4Ch13Level {I44sdi1AudioGroup4Ch13TBL.3}	R/W	Integer	SDI output 1 CH13 level 0 - -60
I44sdi1AudioGroup4Ch13Click {I44sdi1AudioGroup4Ch13TBL.4}	R/W	Integer	SDI output 1 CH13 click insertion interval 1 = off 2 = click1sec 3 = click2sec 4 = click4sec
I44sdi1AudioGroup4Ch14TBL {I44sdi1AudioGroup4TBL.4}	-	Aggregate	-
I44sdi1AudioGroup4Ch14EqualToCh13 {I44sdi1AudioGroup4Ch14TBL.1}	R/W	Integer	Setting shared by SDI output 1 CH14 and CH13 1 = off 2 = on
I44sdi1AudioGroup4Ch14Frequency {I44sdi1AudioGroup4Ch14TBL.2}	R/W	Integer	SDI output 1 C14 frequency 1 = silence 2 = freq400Hz 3 = freq800Hz 4 = freq1000Hz
I44sdi1AudioGroup4Ch14Level {I44sdi1AudioGroup4Ch14TBL.3}	R/W	Integer	SDI output 1 CH14 level 0 - -60
I44sdi1AudioGroup4Ch14Click {I44sdi1AudioGroup4Ch14TBL.4}	R/W	Integer	SDI output 1 CH14 click insertion interval 1 = off 2 = click1sec 3 = click2sec 4 = click4sec
I44sdi1AudioGroup4Ch15TBL	-	Aggregate	-

OID	Access	Syntax	Description
{I44sdi1AudioGroup4TBL.5}			
I44sdi1AudioGroup4Ch15EqualToCh13 {I44sdi1AudioGroup4Ch15TBL.1}	R/W	Integer	Setting shared by SDI output 1 CH15 and CH13 1 = off 2 = on
I44sdi1AudioGroup4Ch15Frequency {I44sdi1AudioGroup4Ch15TBL.2}	R/W	Integer	SDI output 1 CH15 frequency 1 = silence 2 = freq400Hz 3 = freq800Hz 4 = freq1000Hz
I44sdi1AudioGroup4Ch15Level {I44sdi1AudioGroup4Ch15TBL.3}	R/W	Integer	SDI output 1 CH15 level 0 - -60
I44sdi1AudioGroup4Ch15Click {I44sdi1AudioGroup4Ch15TBL.4}	R/W	Integer	SDI output 1 CH15 click insertion interval 1 = off 2 = click1sec 3 = click2sec 4 = click4sec
I44sdi1AudioGroup4Ch16TBL {I44sdi1AudioGroup4TBL.6}	-	Aggregate	-
I44sdi1AudioGroup4Ch16EqualToCh13 {I44sdi1AudioGroup4Ch16TBL.1}	R/W	Integer	Setting shared by SDI output 1 CH16 and CH13 1 = off 2 = on
I44sdi1AudioGroup4Ch16Frequency {I44sdi1AudioGroup4Ch16TBL.2}	R/W	Integer	SDI output 1 CH16 frequency 1 = silence 2 = freq400Hz 3 = freq800Hz 4 = freq1000Hz
I44sdi1AudioGroup4Ch16Level {I44sdi1AudioGroup4Ch16TBL.3}	R/W	Integer	SDI output 1 CH16 level 0 - -60
I44sdi1AudioGroup4Ch16Click {I44sdi1AudioGroup4Ch16TBL.4}	R/W	Integer	SDI output 1 CH16 click insertion interval 1 = off 2 = click1sec 3 = click2sec 4 = click4sec
I44sdi1AudioGroup4Resolution {I44sdi1AudioGroup4TBL.7}	R/W	Integer	SDI output 1 audio group 4 resolution 1 = resolution20bit 2 = resolution24bit
I44sdi1AudioGroup4Emphasis {I44sdi1AudioGroup4TBL.8}	R/W	Integer	SDI output 1 audio group 4 pre-emphasis mode 1 = emphasis50-15 2 = ccittl 3 = off
I44sdi1AncTBL {I44sdi1TBL.7}	-	Aggregate	-
I44sdi1AtcLtc {I44sdi1AncTBL.1}	R/W	Integer	Insertion of LTC into SDI output 1 1 = off 2 = on
I44sdi1AtcVtc	R/W	Integer	Insertion of VITC into SDI output 1

OID	Access	Syntax	Description
{I44sdi1AncTBL.2}			1 = off 2 = on
I44sdi1AtcDropFrame {I44sdi1AncTBL.3}	R/W	Integer	SDI output 1 dropped frame 1 = off 2 = on
I44sdi1OutputTBL {I44sdi1TBL.8}	-	Aggregate	-
I44sdi1Output {I44sdi1OutputTBL.1}	R/W	Integer	SDI output 1 1 = enable 2 = disable
I44sdi1OutputLinktoPtp1Bmca {I44sdi1OutputTBL.2}	R/W	Integer	SDI output 1 BMCA linking (PTP1) 1 = enable 2 = disable
I44sdi1OutputLinktoPtp2Bmca {I44sdi1OutputTBL.3}	R/W	Integer	SDI output 1 BMCA linking (PTP2) 1 = enable 2 = disable
I44sdi2TBL {I44sdi2TBL.1}	-	Aggregate	-
I44sdi2EqualToSDI1TBL {I44sdi2TBL.1}	-	Aggregate	-
I44sdi2EqualToSDI1 {I44sdi2EqualToSDI1TBL.1}	R/W	Integer	Setting shared by SDI output 2 and SDI output 1 1 = off 2 = on
I44sdi2FormatTBL {I44sdi2TBL.2}	-	Aggregate	-
I44sdi2System {I44sdi2FormatTBL.1}	R/W	Integer	SDI output 2 format 1 = f720x487-SD 2 = f720x576-SD 3 = f1280x720-HD 4 = f1920x1080-HD 5 = f1280x720-3G-A 6 = f1920x1080-3G-A 7 = f1920x1080-3G-B-DL 12 = f3840x2160-12G 13 = f4096x2160-12G
I44sdi2Structure {I44sdi2FormatTBL.2}	R/W	Integer	Color system and quantization accuracy of SDI output 2 1 = fYCbCr-422-10bit 2 = fYCbCr-422-12bit 3 = fRGB-444-10bit 4 = fRGB-444-12bit
I44sdi2Framerate {I44sdi2FormatTBL.3}	R/W	Integer	SDI output 2 frame (field) frequency 1 = f60p 2 = f59p94p 3 = f50p

OID	Access	Syntax	Description
			4 = f48p 5 = f30p 6 = f29p97p 7 = f25p 8 = f47p95p 9 = f24p 10 = f23p98p 11 = f30psf 12 = f29.97psf 13 = f25psf 14 = f24psF 15 = f23p98psf 16 = f60i 17 = f59.94i 18 = f50i
I44sdi2TimingTBL {I44sdi2TBL.3}	-	Aggregate	-
I44sdi20HTiming {I44sdi2TimingTBL.1}	R/W	Integer	Reference timing for SDI output 2 1 = serial 2 = legacy
I44sdi2TimingVertical {I44sdi2TimingTBL.2}	R/W	Integer	SDI output 2 timing relative to the reference signal (in lines) ±1124
I44sdi2TimingHorizontal {I44sdi2TimingTBL.3}	R/W	Integer	SDI output 2 timing relative to the reference signal (in dots) ±4124
I44sdi2PatternTBL {I44sdi2TBL.4}	-	Aggregate	-
I44sdi2Pattern {I44sdi2PatternTBL.1}	R/W	Integer	SDI output 2 pattern 1 = colorbar100 2 = colorbar75 3 = multiCB100 4 = multiCB75 5 = multiCBplusI 6 = smpteCB 7 = ebuColorbar 8 = bbcColorbar 9 = flatField100 10 = flatField50 11 = flatField0 12 = redFiled 13 = greenField 14 = blueField 15 = checkfield
I44sdi2VideoTBL {I44sdi2TBL.5}	-	Aggregate	-

OID	Access	Syntax	Description
I44sdi2ComponentTBL {I44sdi2VideoTBL.1}	-	Aggregate	-
I44sdi2Component {I44sdi2ComponentTBL.1}	R/W	Integer	SDI output 2 component (Y/G-Cb/B-Cr/R) 1 = off-off-off 2 = on-off-off 3 = off-on-off 4 = on-on-off 5 = off-off-on 6 = on-off-on 7 = off-on-on 8 = on-on-on
I44sdi2SafetyAreaTBL {I44sdi2VideoTBL.2}	-	Aggregate	-
I44sdi2SafetyArea90 {I44sdi2SafetyAreaTBL.1}	R/W	Integer	90% safety area marker of SDI output 2 1 = off 2 = on
I44sdi2SafetyArea80 {I44sdi2SafetyAreaTBL.2}	R/W	Integer	80% safety area marker of SDI output 2 1 = off 2 = on
I44sdi2SafetyArea43 {I44sdi2SafetyAreaTBL.3}	R/W	Integer	4:3 safety area marker of SDI output 2 1 = off 2 = on
I44sdi2ScrollTBL {I44sdi2VideoTBL.3}	-	Aggregate	-
I44sdi2Scroll {I44sdi2ScrollTBL.1}	R/W	Integer	SDI output 2 scroll 1 = off 2 = on
I44sdi2ScrollVspeed {I44sdi2ScrollTBL.2}	R/W	Integer	Vertical scroll speed and direction of SDI output 2 ±256
I44sdi2ScrollHspeed {I44sdi2ScrollTBL.3}	R/W	Integer	Horizontal scroll speed and direction of SDI output 2 ±256
I44sdi2PatternChangeTBL {I44sdi2VideoTBL.4}	-	Aggregate	-
I44sdi2PatternChange {I44sdi2PatternChangeTBL.1}	R/W	Integer	SDI output 2 pattern change 1 = off 2 = on
I44sdi2PatternChangespeed {I44sdi2PatternChangeTBL.2}	R/W	Integer	SDI output 2 pattern switching interval 1 - 255
I44sdi2IdCharacterTBL {I44sdi2VideoTBL.5}	-	Aggregate	-
I44sdi2IdCharacter {I44sdi2IdCharacterTBL.1}	R/W	Integer	SDI output 2 ID characters 1 = off 2 = on
I44sdi2IdCharacterVposition	R/W	Integer	Vertical ID character position of SDI output 2

OID	Access	Syntax	Description
{I44sdi2IdCharacterTBL.2}			0 - 100
I44sdi2IdCharacterHposition {I44sdi2IdCharacterTBL.3}	R/W	Integer	Horizontal ID character position of SDI output 2 0 - 100
I44sdi2IdCharacterSize {I44sdi2IdCharacterTBL.4}	R/W	Integer	SDI output 2 ID character size 1 = x1 2 = x2 3 = x4 4 = x8
I44sdi2IdCharacterLevel {I44sdi2IdCharacterTBL.5}	R/W	Integer	SDI output 2 ID character luminance level 1 = per-100 2 = per-75
I44sdi2IdCharacterBlinkTBL {I44sdi2IdCharacterTBL.6}	-	Aggregate	-
I44sdi2IdCharacterBlink {I44sdi2IdCharacterBlinkTBL.1}	R/W	Integer	SDI output 2 ID character blinking 1 = off 2 = on
I44sdi2IdCharacterBlinkOffTime {I44sdi2IdCharacterBlinkTBL.2}	R/W	Integer	SDI output 2 ID character blinking off-time 1 - 9
I44sdi2IdCharacterBlinkOnTime {I44sdi2IdCharacterBlinkTBL.3}	R/W	Integer	SDI output 2 ID character blinking on-time 1 - 9
I44sdi2IdCharacterScrollTBL {I44sdi2IdCharacterTBL.7}	-	Aggregate	-
I44sdi2IdCharacterScroll {I44sdi2IdCharacterScrollTBL.1}	R/W	Integer	SDI output 2 ID character scroll 1 = off 2 = on
I44sdi2IdCharacterScrollSpeed {I44sdi2IdCharacterScrollTBL.2}	R/W	Integer	SDI output 2 ID character scroll speed and direction ±256
I44sdi2IdCharacterBackground {I44sdi2IdCharacterTBL.8}	R/W	Integer	SDI output 2 ID character background transparency 1 = off 2 = on
I44sdi2LogoTBL {I44sdi2VideoTBL.6}	-	Aggregate	-
I44sdi2Logo {I44sdi2LogoTBL.1}	R/W	Integer	SDI output 2 logo 1 = off 2 = on
I44sdi2LogoSelect {I44sdi2LogoTBL.2}	R/W	Integer	SDI output 2 logo number 1 - 4
I44sdi2LogoVposition {I44sdi2LogoTBL.3}	R/W	Integer	Vertical logo position of SDI output 2 0 - 100
I44sdi2LogoHposition {I44sdi2LogoTBL.4}	R/W	Integer	Horizontal logo position of SDI output 2 0 - 100
I44sdi2LogoTransparency {I44sdi2LogoTBL.5}	R/W	Integer	SDI output 2 logo transparency 1 = off 2 = on

OID	Access	Syntax	Description
I44sdi2LogoTransparencyLevel {I44sdi2LogoTBL.6}	R/W	Integer	SDI output 2 logo transparency level 0 - 255
I44sdi2MovingBoxTBL {I44sdi2VideoTBL.7}	-	Aggregate	-
I44sdi2MovingBox {I44sdi2MovingBoxTBL.1}	R/W	Integer	SDI output 2 moving box 1 = off 2 = on
I44sdi2MovingBoxColor {I44sdi2MovingBoxTBL.2}	R/W	Integer	SDI output 2 moving box color 1 = white 2 = yellow 3 = cyan 4 = green 5 = blue 6 = red 7 = magenta 8 = black
I44sdi2MovingBoxVspeed {I44sdi2MovingBoxTBL.3}	R/W	Integer	Vertical moving box speed of SDI output 2 1 = low 2 = middle 3 = high
I44sdi2MovingBoxHspeed {I44sdi2MovingBoxTBL.4}	R/W	Integer	Horizontal moving box speed of SDI output 2 1 = low 2 = middle 3 = high
I44sdi2MovingBoxVsize {I44sdi2MovingBoxTBL.5}	R/W	Integer	SDI output 2 moving box height 1 = size1 2 = size2 3 = size3 4 = size4 5 = size5
I44sdi2MovingBoxHsize {I44sdi2MovingBoxTBL.6}	R/W	Integer	SDI output 2 moving box width 1 = size1 2 = size2 3 = size3 4 = size4 5 = size5
I44sdi2CircleTBL {I44sdi2VideoTBL.8}	-	Aggregate	-
I44sdi2Circle {I44sdi2CircleTBL.1}	R/W	Integer	SDI output 2 circle 1 = off 2 = on
I44sdi2CircleSize {I44sdi2CircleTBL.2}	R/W	Integer	SDI output 2 circle size 1 = per-90 2 = per-80 3 = per-70
I44sdi2CircleLevel	R/W	Integer	SDI output 2 circle luminance level

OID	Access	Syntax	Description
{I44sdi2CircleTBL.3}			1 = per-100 2 = per-75
I44sdi2CircleBlinkTBL {I44sdi2CircleTBL.4}	-	Aggregate	-
I44sdi2CircleBlink {I44sdi2CircleBlinkTBL.1}	R/W	Integer	SDI output 2 circle blinking 1 = off 2 = on
I44sdi2CircleBlinkOffTime {I44sdi2CircleBlinkTBL.2}	R/W	Integer	SDI output 2 circle blinking off-time 1 - 9
I44sdi2CircleBlinkOnTime {I44sdi2CircleBlinkTBL.3}	R/W	Integer	SDI output 2 circle blinking on-time 1 - 9
I44sdi2TimecodeTBL {I44sdi2VideoTBL.9}	-	Aggregate	-
I44sdi2Timecode {I44sdi2TimecodeTBL.1}	R/W	Integer	SDI output 2 time code 1 = off 2 = on
I44sdi2TimecodeVposition {I44sdi2TimecodeTBL.2}	R/W	Integer	Vertical time code position of SDI output 2 0 - 100
I44sdi2TimecodeHposition {I44sdi2TimecodeTBL.3}	R/W	Integer	Horizontal time code position of SDI output 2 0 - 100
I44sdi2TimecodeSize {I44sdi2TimecodeTBL.4}	R/W	Integer	SDI output 2 time code size 1 = x1 2 = x2 3 = x4 4 = x8
I44sdi2TimecodeLevel {I44sdi2TimecodeTBL.5}	R/W	Integer	SDI output 2 time code luminance level 1 = per-100 2 = per-75
I44sdi2TimecodeBackground {I44sdi2TimecodeTBL.6}	R/W	Integer	SDI output 2 time code background transparency 1 = off 2 = on
I44sdi2LipsyncTBL {I44sdi2VideoTBL.10}	-	Aggregate	-
I44sdi2Lipsync {I44sdi2LipsyncTBL.1}	R/W	Integer	SDI output 2 lip sync pattern 1 = off 2 = on
I44sdi2AudioTBL {I44sdi2TBL.6}	-	Aggregate	-
I44sdi2AudioGroup1TBL {I44sdi2AudioTBL.1}	-	Aggregate	-
I44sdi2AudioGroup1 {I44sdi2AudioGroup1TBL.1}	R/W	Integer	SDI output 2 audio group 1 1 = off 2 = on
I44sdi2AudioGroup1Ch1TBL {I44sdi2AudioGroup1TBL.3}	-	Aggregate	-

OID	Access	Syntax	Description
I44sdi2AudioGroup1Ch1Frequency {I44sdi2AudioGroup1Ch1TBL.2}	R/W	Integer	SDI output 2 CH1 frequency 1 = silence 2 = freq400Hz 3 = freq800Hz 4 = freq1000Hz
I44sdi2AudioGroup1Ch1Level {I44sdi2AudioGroup1Ch1TBL.3}	R/W	Integer	SDI output 2 CH1 level 0 - -60
I44sdi2AudioGroup1Ch1Click {I44sdi2AudioGroup1Ch1TBL.4}	R/W	Integer	SDI output 2 CH1 click insertion interval 1 = off 2 = click1sec 3 = click2sec 4 = click4sec
I44sdi2AudioGroup1Ch2TBL {I44sdi2AudioGroup1TBL.4}	-	Aggregate	-
I44sdi2AudioGroup1Ch2EqualToCh1 {I44sdi2AudioGroup1Ch2TBL.1}	R/W	Integer	Setting shared by SDI output 2 CH2 and CH1 1 = off 2 = on
I44sdi2AudioGroup1Ch2Frequency {I44sdi2AudioGroup1Ch2TBL.2}	R/W	Integer	SDI output 2 CH2 frequency 1 = silence 2 = freq400Hz 3 = freq800Hz 4 = freq1000Hz
I44sdi2AudioGroup1Ch2Level {I44sdi2AudioGroup1Ch2TBL.3}	R/W	Integer	SDI output 2 CH2 level 0 - -60
I44sdi2AudioGroup1Ch2Click {I44sdi2AudioGroup1Ch2TBL.4}	R/W	Integer	SDI output 2 CH2 click insertion interval 1 = off 2 = click1sec 3 = click2sec 4 = click4sec
I44sdi2AudioGroup1Ch3TBL {I44sdi2AudioGroup1TBL.5}	-	Aggregate	-
I44sdi2AudioGroup1Ch3EqualToCh1 {I44sdi2AudioGroup1Ch3TBL.1}	R/W	Integer	Setting shared by SDI output 2 CH3 and CH1 1 = off 2 = on
I44sdi2AudioGroup1Ch3Frequency {I44sdi2AudioGroup1Ch3TBL.2}	R/W	Integer	SDI output 2 CH3 frequency 1 = silence 2 = freq400Hz 3 = freq800Hz 4 = freq1000Hz
I44sdi2AudioGroup1Ch3Level {I44sdi2AudioGroup1Ch3TBL.3}	R/W	Integer	SDI output 2 CH3 level 0 - -60
I44sdi2AudioGroup1Ch3Click {I44sdi2AudioGroup1Ch3TBL.4}	R/W	Integer	SDI output 2 CH3 click insertion interval 1 = off 2 = click1sec 3 = click2sec 4 = click4sec

OID	Access	Syntax	Description
I44sdi2AudioGroup1Ch4TBL {I44sdi2AudioGroup1TBL.6}	-	Aggregate	-
I44sdi2AudioGroup1Ch4EqualToCh1 {I44sdi2AudioGroup1Ch4TBL.1}	R/W	Integer	Setting shared by SDI output 2 CH4 and CH1 1 = off 2 = on
I44sdi2AudioGroup1Ch4Frequency {I44sdi2AudioGroup1Ch4TBL.2}	R/W	Integer	SDI output 2 CH4 frequency 1 = silence 2 = freq400Hz 3 = freq800Hz 4 = freq1000Hz
I44sdi2AudioGroup1Ch4Level {I44sdi2AudioGroup1Ch4TBL.3}	R/W	Integer	SDI output 2 CH4 level 0 - -60
I44sdi2AudioGroup1Ch4Click {I44sdi2AudioGroup1Ch4TBL.4}	R/W	Integer	SDI output 2 CH4 click insertion interval 1 = off 2 = click1sec 3 = click2sec 4 = click4sec
I44sdi2AudioGroup1Resolution {I44sdi2AudioGroup1TBL.7}	R/W	Integer	SDI output 2 audio group 1 resolution 1 = resolution20bit 2 = resolution24bit
I44sdi2AudioGroup1Emphasis {I44sdi2AudioGroup1TBL.8}	R/W	Integer	SDI output 2 audio group 1 pre-emphasis mode 1 = emphasis50-15 2 = ccittl 3 = off
I44sdi2AudioGroup2TBL {I44sdi2AudioTBL.2}	-	Aggregate	-
I44sdi2AudioGroup2 {I44sdi2AudioGroup2TBL.1}	R/W	Integer	SDI output 2 audio group 2 1 = off 2 = on
I44sdi2AudioGroup2EtqlToG1 {I44sdi2AudioGroup2TBL.2}	R/W	Integer	Setting shared by SDI output 2 audio group 2 and audio group 1 1 = off 2 = on
I44sdi2AudioGroup2Ch5TBL {I44sdi2AudioGroup2TBL.3}	-	Aggregate	-
I44sdi2AudioGroup2Ch5Frequency {I44sdi2AudioGroup2Ch5TBL.2}	R/W	Integer	SDI output 2 CH5 frequency 1 = silence 2 = freq400Hz 3 = freq800Hz 4 = freq1000Hz
I44sdi2AudioGroup2Ch5Level {I44sdi2AudioGroup2Ch5TBL.3}	R/W	Integer	SDI output 2 CH5 level 0 - -60
I44sdi2AudioGroup2Ch5Click {I44sdi2AudioGroup2Ch5TBL.4}	R/W	Integer	SDI output 2 CH5 click insertion interval 1 = off 2 = click1sec 3 = click2sec

OID	Access	Syntax	Description
			4 = click4sec
I44sdi2AudioGroup2Ch6TBL {I44sdi2AudioGroup2TBL.4}	-	Aggregate	-
I44sdi2AudioGroup2Ch6EqualToCh5 {I44sdi2AudioGroup2Ch6TBL.1}	R/W	Integer	Setting shared by SDI output 2 CH6 and CH5 1 = off 2 = on
I44sdi2AudioGroup2Ch6Frequency {I44sdi2AudioGroup2Ch6TBL.2}	R/W	Integer	SDI output 2 CH6 frequency 1 = silence 2 = freq400Hz 3 = freq800Hz 4 = freq1000Hz
I44sdi2AudioGroup2Ch6Level {I44sdi2AudioGroup2Ch6TBL.3}	R/W	Integer	SDI output 2 CH6 level 0 - -60
I44sdi2AudioGroup2Ch6Click {I44sdi2AudioGroup2Ch6TBL.4}	R/W	Integer	SDI output 2 CH6 click insertion interval 1 = off 2 = click1sec 3 = click2sec 4 = click4sec
I44sdi2AudioGroup2Ch7TBL {I44sdi2AudioGroup2TBL.5}	-	Aggregate	-
I44sdi2AudioGroup2Ch7EqualToCh5 {I44sdi2AudioGroup2Ch7TBL.1}	R/W	Integer	Setting shared by SDI output 2 CH7 and CH5 1 = off 2 = on
I44sdi2AudioGroup2Ch7Frequency {I44sdi2AudioGroup2Ch7TBL.2}	R/W	Integer	SDI output 2 CH7 frequency 1 = silence 2 = freq400Hz 3 = freq800Hz 4 = freq1000Hz
I44sdi2AudioGroup2Ch7Level {I44sdi2AudioGroup2Ch7TBL.3}	R/W	Integer	SDI output 2 CH7 level 0 - -60
I44sdi2AudioGroup2Ch7Click {I44sdi2AudioGroup2Ch7TBL.4}	R/W	Integer	SDI output 2 CH7 click insertion interval 1 = off 2 = click1sec 3 = click2sec 4 = click4sec
I44sdi2AudioGroup2Ch8TBL {I44sdi2AudioGroup2TBL.6}	-	Aggregate	-
I44sdi2AudioGroup2Ch8EqualToCh5 {I44sdi2AudioGroup2Ch8TBL.1}	R/W	Integer	Setting shared by SDI output 2 CH8 and CH5 1 = off 2 = on
I44sdi2AudioGroup2Ch8Frequency {I44sdi2AudioGroup2Ch8TBL.2}	R/W	Integer	SDI output 2 CH8 frequency 1 = silence 2 = freq400Hz 3 = freq800Hz 4 = freq1000Hz
I44sdi2AudioGroup2Ch8Level	R/W	Integer	SDI output 2 CH8 level

OID	Access	Syntax	Description
{I44sdi2AudioGroup2Ch8TBL.3}			0 - -60
I44sdi2AudioGroup2Ch8Click {I44sdi2AudioGroup2Ch8TBL.4}	R/W	Integer	SDI output 2 CH8 click insertion interval 1 = off 2 = click1sec 3 = click2sec 4 = click4sec
I44sdi2AudioGroup2Resolution {I44sdi2AudioGroup2TBL.7}	R/W	Integer	SDI output 2 audio group 2 resolution 1 = resolution20bit 2 = resolution24bit
I44sdi2AudioGroup2Emphasis {I44sdi2AudioGroup2TBL.8}	R/W	Integer	SDI output 2 audio group 2 pre-emphasis mode 1 = emphasis50-15 2 = ccittl 3 = off
I44sdi2AudioGroup3TBL {I44sdi2AudioTBL.3}	-	Aggregate	-
I44sdi2AudioGroup3 {I44sdi2AudioGroup3TBL.1}	R/W	Integer	SDI output 2 audio group 3 1 = off 2 = on
I44sdi2AudioGroup3EqualToG1 {I44sdi2AudioGroup3TBL.2}	R/W	Integer	Setting shared by SDI output 2 audio group 3 and audio group 1 1 = off 2 = on
I44sdi2AudioGroup3Ch9TBL {I44sdi2AudioGroup3TBL.3}	-	Aggregate	-
I44sdi2AudioGroup3Ch9Frequency {I44sdi2AudioGroup3Ch9TBL.2}	R/W	Integer	SDI output 2 CH9 frequency 1 = silence 2 = freq400Hz 3 = freq800Hz 4 = freq1000Hz
I44sdi2AudioGroup3Ch9Level {I44sdi2AudioGroup3Ch9TBL.3}	R/W	Integer	SDI output 2 CH9 level 0 - -60
I44sdi2AudioGroup3Ch9Click {I44sdi2AudioGroup3Ch9TBL.4}	R/W	Integer	SDI output 2 CH9 click insertion interval 1 = off 2 = click1sec 3 = click2sec 4 = click4sec
I44sdi2AudioGroup3Ch10TBL {I44sdi2AudioGroup3TBL.4}	-	Aggregate	-
I44sdi2AudioGroup3Ch10EqualToCh9 {I44sdi2AudioGroup3Ch10TBL.1}	R/W	Integer	Setting shared by SDI output 2 CH10 and CH9 1 = off 2 = on
I44sdi2AudioGroup3Ch10Frequency {I44sdi2AudioGroup3Ch10TBL.2}	R/W	Integer	SDI output 2 CH10 frequency 1 = silence 2 = freq400Hz 3 = freq800Hz 4 = freq1000Hz

OID	Access	Syntax	Description
I44sdi2AudioGroup3Ch10Level {I44sdi2AudioGroup3Ch10TBL.3}	R/W	Integer	SDI output 2 CH10 level 0 - -60
I44sdi2AudioGroup3Ch10Click {I44sdi2AudioGroup3Ch10TBL.4}	R/W	Integer	SDI output 2 CH10 click insertion interval 1 = off 2 = click1sec 3 = click2sec 4 = click4sec
I44sdi2AudioGroup3Ch11TBL {I44sdi2AudioGroup3TBL.5}	-	Aggregate	-
I44sdi2AudioGroup3Ch11EqualToCh9 {I44sdi2AudioGroup3Ch11TBL.1}	R/W	Integer	Setting shared by SDI output 2 CH11 and CH9 1 = off 2 = on
I44sdi2AudioGroup3Ch11Frequency {I44sdi2AudioGroup3Ch11TBL.2}	R/W	Integer	SDI output 2 CH11 frequency 1 = silence 2 = freq400Hz 3 = freq800Hz 4 = freq1000Hz
I44sdi2AudioGroup3Ch11Level {I44sdi2AudioGroup3Ch11TBL.3}	R/W	Integer	SDI output 2 CH11 level 0 - -60
I44sdi2AudioGroup3Ch11Click {I44sdi2AudioGroup3Ch11TBL.4}	R/W	Integer	SDI output 2 CH11 click insertion interval 1 = off 2 = click1sec 3 = click2sec 4 = click4sec
I44sdi2AudioGroup3Ch12TBL {I44sdi2AudioGroup3TBL.6}	-	Aggregate	-
I44sdi2AudioGroup3Ch12EqualToCh9 {I44sdi2AudioGroup3Ch12TBL.1}	R/W	Integer	Setting shared by SDI output 2 CH12 and CH9 1 = off 2 = on
I44sdi2AudioGroup3Ch12Frequency {I44sdi2AudioGroup3Ch12TBL.2}	R/W	Integer	SDI output 2 CH12 frequency 1 = silence 2 = freq400Hz 3 = freq800Hz 4 = freq1000Hz
I44sdi2AudioGroup3Ch12Level {I44sdi2AudioGroup3Ch12TBL.3}	R/W	Integer	SDI output 2 CH12 level 0 - -60
I44sdi2AudioGroup3Ch12Click {I44sdi2AudioGroup3Ch12TBL.4}	R/W	Integer	SDI output 2 CH12 click insertion interval 1 = off 2 = click1sec 3 = click2sec 4 = click4sec
I44sdi2AudioGroup3Resolution {I44sdi2AudioGroup3TBL.7}	R/W	Integer	SDI output 2 audio group 3 resolution 1 = resolution20bit 2 = resolution24bit
I44sdi2AudioGroup3Emphasis {I44sdi2AudioGroup3TBL.8}	R/W	Integer	SDI output 2 audio group 3 pre-emphasis mode 1 = emphasis50-15

OID	Access	Syntax	Description
			2 = ccittl 3 = off
I44sdi2AudioGroup4TBL {I44sdi2AudioTBL.4}	-	Aggregate	-
I44sdi2AudioGroup4 {I44sdi2AudioGroup4TBL.1}	R/W	Integer	SDI output 2 audio group 4 1 = off 2 = on
I44sdi2AudioGroup4EqualToG3 {I44sdi2AudioGroup4TBL.2}	R/W	Integer	Setting shared by SDI output 2 audio group 4 and audio group 3 1 = off 2 = on
I44sdi2AudioGroup4Ch13TBL {I44sdi2AudioGroup4TBL.3}	-	Aggregate	-
I44sdi2AudioGroup4Ch13Frequency {I44sdi2AudioGroup4Ch13TBL.2}	R/W	Integer	SDI output 2 CH13 frequency 1 = silence 2 = freq400Hz 3 = freq800Hz 4 = freq1000Hz
I44sdi2AudioGroup4Ch13Level {I44sdi2AudioGroup4Ch13TBL.3}	R/W	Integer	SDI output 2 CH13 level 0 - -60
I44sdi2AudioGroup4Ch13Click {I44sdi2AudioGroup4Ch13TBL.4}	R/W	Integer	SDI output 2 CH13 click insertion interval 1 = off 2 = click1sec 3 = click2sec 4 = click4sec
I44sdi2AudioGroup4Ch14TBL {I44sdi2AudioGroup4TBL.4}	-	Aggregate	-
I44sdi2AudioGroup4Ch14EqualToCh13 {I44sdi2AudioGroup4Ch14TBL.1}	R/W	Integer	Setting shared by SDI output 2 CH14 and CH13 1 = off 2 = on
I44sdi2AudioGroup4Ch14Frequency {I44sdi2AudioGroup4Ch14TBL.2}	R/W	Integer	SDI output 2 C14 frequency 1 = silence 2 = freq400Hz 3 = freq800Hz 4 = freq1000Hz
I44sdi2AudioGroup4Ch14Level {I44sdi2AudioGroup4Ch14TBL.3}	R/W	Integer	SDI output 2 CH14 level 0 - -60
I44sdi2AudioGroup4Ch14Click {I44sdi2AudioGroup4Ch14TBL.4}	R/W	Integer	SDI output 2 CH14 click insertion interval 1 = off 2 = click1sec 3 = click2sec 4 = click4sec
I44sdi2AudioGroup4Ch15TBL {I44sdi2AudioGroup4TBL.5}	-	Aggregate	-
I44sdi2AudioGroup4Ch15EqualToCh13 {I44sdi2AudioGroup4Ch15TBL.1}	R/W	Integer	Setting shared by SDI output 2 CH15 and CH13 1 = off

OID	Access	Syntax	Description
			2 = on
I44sdi2AudioGroup4Ch15Frequency {I44sdi2AudioGroup4Ch15TBL.2}	R/W	Integer	SDI output 2 CH15 frequency 1 = silence 2 = freq400Hz 3 = freq800Hz 4 = freq1000Hz
I44sdi2AudioGroup4Ch15Level {I44sdi2AudioGroup4Ch15TBL.3}	R/W	Integer	SDI output 2 CH15 level 0 - -60
I44sdi2AudioGroup4Ch15Click {I44sdi2AudioGroup4Ch15TBL.4}	R/W	Integer	SDI output 2 CH15 click insertion interval 1 = off 2 = click1sec 3 = click2sec 4 = click4sec
I44sdi2AudioGroup4Ch16TBL {I44sdi2AudioGroup4TBL.6}	-	Aggregate	-
I44sdi2AudioGroup4Ch16EqualToCh13 {I44sdi2AudioGroup4Ch16TBL.1}	R/W	Integer	Setting shared by SDI output 2 CH16 and CH13 1 = off 2 = on
I44sdi2AudioGroup4Ch16Frequency {I44sdi2AudioGroup4Ch16TBL.2}	R/W	Integer	SDI output 2 CH16 frequency 1 = silence 2 = freq400Hz 3 = freq800Hz 4 = freq1000Hz
I44sdi2AudioGroup4Ch16Level {I44sdi2AudioGroup4Ch16TBL.3}	R/W	Integer	SDI output 2 CH16 level 0 - -60
I44sdi2AudioGroup4Ch16Click {I44sdi2AudioGroup4Ch16TBL.4}	R/W	Integer	SDI output 2 CH16 click insertion interval 1 = off 2 = click1sec 3 = click2sec 4 = click4sec
I44sdi2AudioGroup4Resolution {I44sdi2AudioGroup4TBL.7}	R/W	Integer	SDI output 2 audio group 4 resolution 1 = resolution20bit 2 = resolution24bit
I44sdi2AudioGroup4Emphasis {I44sdi2AudioGroup4TBL.8}	R/W	Integer	SDI output 2 audio group 4 pre-emphasis mode 1 = emphasis50-15 2 = ccittl 3 = off
I44sdi2AncTBL {I44sdi2TBL.7}	-	Aggregate	-
I44sdi2AtcLtc {I44sdi2AncTBL.1}	R/W	Integer	Insertion of LTC into SDI output 2 1 = off 2 = on
I44sdi2AtcVtc {I44sdi2AncTBL.2}	R/W	Integer	Insertion of VITC into SDI output 2 1 = off 2 = on
I44sdi2AtcDropFrame	R/W	Integer	SDI output 2 dropped frame

OID	Access	Syntax	Description
{I44sdi2AncTBL.3}			1 = off 2 = on
I44sdi2OutputTBL {I44sdi2TBL.8}	-	Aggregate	-
I44sdi2Output {I44sdi2OutputTBL.1}	R/W	Integer	SDI output 2 1 = enable 2 = disable
I44sdi2OutputLinktoPtp1Bmca {I44sdi2OutputTBL.2}	R/W	Integer	SDI output 2 BMCA linking (PTP1) 1 = enable 2 = disable
I44sdi2OutputLinktoPtp2Bmca {I44sdi2OutputTBL.3}	R/W	Integer	SDI output 2 BMCA linking (PTP2) 1 = enable 2 = disable
I44sdi3TBL {I44sdi3TBL.1}	-	Aggregate	-
I44sdi3EqualToSDI1TBL {I44sdi3TBL.1}	-	Aggregate	-
I44sdi3EqualToSDI1 {I44sdi3EqualToSDI1TBL.1}	R/W	Integer	Setting shared by SDI output 3 and SDI output 1 1 = off 2 = on
I44sdi3FormatTBL {I44sdi3TBL.2}	-	Aggregate	-
I44sdi3System {I44sdi3FormatTBL.1}	R/W	Integer	SDI output 3 format 1 = f720x487-SD 2 = f720x576-SD 3 = f1280x720-HD 4 = f1920x1080-HD 5 = f1280x720-3G-A 6 = f1920x1080-3G-A 7 = f1920x1080-3G-B-DL 12 = f3840x2160-12G 13 = f4096x2160-12G
I44sdi3Structure {I44sdi3FormatTBL.2}	R/W	Integer	Color system and quantization accuracy of SDI output 3 1 = fYCbCr-422-10bit 2 = fYCbCr-422-12bit 3 = fRGB-444-10bit 4 = fRGB-444-12bit
I44sdi3Framerate {I44sdi3FormatTBL.3}	R/W	Integer	SDI output 3 frame (field) frequency 1 = f60p 2 = f59p94p 3 = f50p 4 = f48p 5 = f30p 6 = f29p97p

OID	Access	Syntax	Description
			7 = f25p 8 = f47p95p 9 = f24p 10 = f23p98p 11 = f30psf 12 = f29.97psf 13 = f25psf 14 = f24psF 15 = f23p98psf 16 = f60i 17 = f59.94i 18 = f50i
I44sdi3TimingTBL {I44sdi3TBL.3}	-	Aggregate	-
I44sdi30HTiming {I44sdi3TimingTBL.1}	R/W	Integer	Reference timing for SDI output 3 1 = serial 2 = legacy
I44sdi3TimingVertical {I44sdi3TimingTBL.2}	R/W	Integer	SDI output 3 timing relative to the reference signal (in lines) ±1124
I44sdi3TimingHorizontal {I44sdi3TimingTBL.3}	R/W	Integer	SDI output 3 timing relative to the reference signal (in dots) ±4124
I44sdi3PatternTBL {I44sdi3TBL.4}	-	Aggregate	-
I44sdi3Pattern {I44sdi3PatternTBL.1}	R/W	Integer	SDI output 3 pattern 1 = colorbar100 2 = colorbar75 3 = multiCB100 4 = multiCB75 5 = multiCBplusI 6 = smpteCB 7 = ebuColorbar 8 = bbcColorbar 9 = flatField100 10 = flatField50 11 = flatField0 12 = redFiled 13 = greenField 14 = blueField 15 = checkfield
I44sdi3VideoTBL {I44sdi3TBL.5}	-	Aggregate	-
I44sdi3ComponentTBL {I44sdi3VideoTBL.1}	-	Aggregate	-
I44sdi3Component	R/W	Integer	SDI output 3 component (Y/G-Cb/B-Cr/R)

OID	Access	Syntax	Description
{I44sdi3ComponentTBL.1}			1 = off-off-off 2 = on-off-off 3 = off-on-off 4 = on-on-off 5 = off-off-on 6 = on-off-on 7 = off-on-on 8 = on-on-on
I44sdi3SafetyAreaTBL {I44sdi3VideoTBL.2}	-	Aggregate	-
I44sdi3SafetyArea90 {I44sdi3SafetyAreaTBL.1}	R/W	Integer	90% safety area marker of SDI output 3 1 = off 2 = on
I44sdi3SafetyArea80 {I44sdi3SafetyAreaTBL.2}	R/W	Integer	80% safety area marker of SDI output 3 1 = off 2 = on
I44sdi3SafetyArea43 {I44sdi3SafetyAreaTBL.3}	R/W	Integer	4:3 safety area marker of SDI output 3 1 = off 2 = on
I44sdi3ScrollTBL {I44sdi3VideoTBL.3}	-	Aggregate	-
I44sdi3Scroll {I44sdi3ScrollTBL.1}	R/W	Integer	SDI output 3 scroll 1 = off 2 = on
I44sdi3ScrollVspeed {I44sdi3ScrollTBL.2}	R/W	Integer	Vertical scroll speed and direction of SDI output 3 ±256
I44sdi3ScrollHspeed {I44sdi3ScrollTBL.3}	R/W	Integer	Horizontal scroll speed and direction of SDI output 3 ±256
I44sdi3PatternChangeTBL {I44sdi3VideoTBL.4}	-	Aggregate	-
I44sdi3PatternChange {I44sdi3PatternChangeTBL.1}	R/W	Integer	SDI output 3 pattern change 1 = off 2 = on
I44sdi3PatternChangespeed {I44sdi3PatternChangeTBL.2}	R/W	Integer	SDI output 3 pattern switching interval 1 - 255
I44sdi3IdCharacterTBL {I44sdi3VideoTBL.5}	-	Aggregate	-
I44sdi3IdCharacter {I44sdi3IdCharacterTBL.1}	R/W	Integer	SDI output 3 ID characters 1 = off 2 = on
I44sdi3IdCharacterVposition {I44sdi3IdCharacterTBL.2}	R/W	Integer	Vertical ID character position of SDI output 3 0 - 100
I44sdi3IdCharacterHposition {I44sdi3IdCharacterTBL.3}	R/W	Integer	Horizontal ID character position of SDI output 3 0 - 100

OID	Access	Syntax	Description
I44sdi3IdCharacterSize {I44sdi3IdCharacterTBL.4}	R/W	Integer	SDI output 3 ID character size 1 = x1 2 = x2 3 = x4 4 = x8
I44sdi3IdCharacterLevel {I44sdi3IdCharacterTBL.5}	R/W	Integer	SDI output 3 ID character luminance level 1 = per-100 2 = per-75
I44sdi3IdCharacterBlinkTBL {I44sdi3IdCharacterTBL.6}	-	Aggregate	-
I44sdi3IdCharacterBlink {I44sdi3IdCharacterBlinkTBL.1}	R/W	Integer	SDI output 3 ID character blinking 1 = off 2 = on
I44sdi3IdCharacterBlinkOffTime {I44sdi3IdCharacterBlinkTBL.2}	R/W	Integer	SDI output 3 ID character blinking off-time 1 - 9
I44sdi3IdCharacterBlinkOnTime {I44sdi3IdCharacterBlinkTBL.3}	R/W	Integer	SDI output 3 ID character blinking on-time 1 - 9
I44sdi3IdCharacterScrollTBL {I44sdi3IdCharacterTBL.7}	-	Aggregate	-
I44sdi3IdCharacterScroll {I44sdi3IdCharacterScrollTBL.1}	R/W	Integer	SDI output 3 ID character scroll 1 = off 2 = on
I44sdi3IdCharacterScrollSpeed {I44sdi3IdCharacterScrollTBL.2}	R/W	Integer	SDI output 3 ID character scroll speed and direction ±256
I44sdi3IdCharacterBackground {I44sdi3IdCharacterTBL.8}	R/W	Integer	SDI output 3 ID character background transparency 1 = off 2 = on
I44sdi3LogoTBL {I44sdi3VideoTBL.6}	-	Aggregate	-
I44sdi3Logo {I44sdi3LogoTBL.1}	R/W	Integer	SDI output 3 logo 1 = off 2 = on
I44sdi3LogoSelect {I44sdi3LogoTBL.2}	R/W	Integer	SDI output 3 logo number 1 - 4
I44sdi3LogoVposition {I44sdi3LogoTBL.3}	R/W	Integer	Vertical logo position of SDI output 3 0 - 100
I44sdi3LogoHposition {I44sdi3LogoTBL.4}	R/W	Integer	Horizontal logo position of SDI output 3 0 - 100
I44sdi3LogoTransParency {I44sdi3LogoTBL.5}	R/W	Integer	SDI output 3 logo transparency 1 = off 2 = on
I44sdi3LogoTransParencyLevel {I44sdi3LogoTBL.6}	R/W	Integer	SDI output 3 logo transparency level 0 - 255
I44sdi3MovingBoxTBL	-	Aggregate	-

OID	Access	Syntax	Description
{I44sdi3VideoTBL.7}			
I44sdi3MovingBox {I44sdi3MovingBoxTBL.1}	R/W	Integer	SDI output 3 moving box 1 = off 2 = on
I44sdi3MovingBoxColor {I44sdi3MovingBoxTBL.2}	R/W	Integer	SDI output 3 moving box color 1 = white 2 = yellow 3 = cyan 4 = green 5 = blue 6 = red 7 = magenta 8 = black
I44sdi3MovingBoxVspeed {I44sdi3MovingBoxTBL.3}	R/W	Integer	Vertical moving box speed of SDI output 3 1 = low 2 = middle 3 = high
I44sdi3MovingBoxHspeed {I44sdi3MovingBoxTBL.4}	R/W	Integer	Horizontal moving box speed of SDI output 3 1 = low 2 = middle 3 = high
I44sdi3MovingBoxVsize {I44sdi3MovingBoxTBL.5}	R/W	Integer	SDI output 3 moving box height 1 = size1 2 = size2 3 = size3 4 = size4 5 = size5
I44sdi3MovingBoxHsize {I44sdi3MovingBoxTBL.6}	R/W	Integer	SDI output 3 moving box width 1 = size1 2 = size2 3 = size3 4 = size4 5 = size5
I44sdi3CircleTBL {I44sdi3VideoTBL.8}	-	Aggregate	-
I44sdi3Circle {I44sdi3CircleTBL.1}	R/W	Integer	SDI output 3 circle 1 = off 2 = on
I44sdi3CircleSize {I44sdi3CircleTBL.2}	R/W	Integer	SDI output 3 circle size 1 = per-90 2 = per-80 3 = per-70
I44sdi3CircleLevel {I44sdi3CircleTBL.3}	R/W	Integer	SDI output 3 circle luminance level 1 = per-100 2 = per-75
I44sdi3CircleBlinkTBL	-	Aggregate	-

OID	Access	Syntax	Description
{I44sdi3CircleTBL.4}			
I44sdi3CircleBlink {I44sdi3CircleBlinkTBL.1}	R/W	Integer	SDI output 3 circle blinking 1 = off 2 = on
I44sdi3CircleBlinkOffTime {I44sdi3CircleBlinkTBL.2}	R/W	Integer	SDI output 3 circle blinking off-time 1 - 9
I44sdi3CircleBlinkOnTime {I44sdi3CircleBlinkTBL.3}	R/W	Integer	SDI output 3 circle blinking on-time 1 - 9
I44sdi3TimecodeTBL {I44sdi3VideoTBL.9}	-	Aggregate	-
I44sdi3Timecode {I44sdi3TimecodeTBL.1}	R/W	Integer	SDI output 3 time code 1 = off 2 = on
I44sdi3TimecodeVposition {I44sdi3TimecodeTBL.2}	R/W	Integer	Vertical time code position of SDI output 3 0 - 100
I44sdi3TimecodeHposition {I44sdi3TimecodeTBL.3}	R/W	Integer	Horizontal time code position of SDI output 3 0 - 100
I44sdi3TimecodeSize {I44sdi3TimecodeTBL.4}	R/W	Integer	SDI output 3 time code size 1 = x1 2 = x2 3 = x4 4 = x8
I44sdi3TimecodeLevel {I44sdi3TimecodeTBL.5}	R/W	Integer	SDI output 3 time code luminance level 1 = per-100 2 = per-75
I44sdi3TimecodeBackground {I44sdi3TimecodeTBL.6}	R/W	Integer	SDI output 3 time code background transparency 1 = off 2 = on
I44sdi3LipsyncTBL {I44sdi3VideoTBL.10}	-	Aggregate	-
I44sdi3Lipsync {I44sdi3LipsyncTBL.1}	R/W	Integer	SDI output 3 lip sync pattern 1 = off 2 = on
I44sdi3AudioTBL {I44sdi3TBL.6}	-	Aggregate	-
I44sdi3AudioGroup1TBL {I44sdi3AudioTBL.1}	-	Aggregate	-
I44sdi3AudioGroup1 {I44sdi3AudioGroup1TBL.1}	R/W	Integer	SDI output 3 audio group 1 1 = off 2 = on
I44sdi3AudioGroup1Ch1TBL {I44sdi3AudioGroup1TBL.3}	-	Aggregate	-
I44sdi3AudioGroup1Ch1Frequency {I44sdi3AudioGroup1Ch1TBL.2}	R/W	Integer	SDI output 3 CH1 frequency 1 = silence 2 = freq400Hz

OID	Access	Syntax	Description
			3 = freq800Hz 4 = freq1000Hz
I44sdi3AudioGroup1Ch1Level {I44sdi3AudioGroup1Ch1TBL.3}	R/W	Integer	SDI output 3 CH1 level 0 - -60
I44sdi3AudioGroup1Ch1Click {I44sdi3AudioGroup1Ch1TBL.4}	R/W	Integer	SDI output 3 CH1 click insertion interval 1 = off 2 = click1sec 3 = click2sec 4 = click4sec
I44sdi3AudioGroup1Ch2TBL {I44sdi3AudioGroup1TBL.4}	-	Aggregate	-
I44sdi3AudioGroup1Ch2EqualToCh1 {I44sdi3AudioGroup1Ch2TBL.1}	R/W	Integer	Setting shared by SDI output 3 CH2 and CH1 1 = off 2 = on
I44sdi3AudioGroup1Ch2Frequency {I44sdi3AudioGroup1Ch2TBL.2}	R/W	Integer	SDI output 3 CH2 frequency 1 = silence 2 = freq400Hz 3 = freq800Hz 4 = freq1000Hz
I44sdi3AudioGroup1Ch2Level {I44sdi3AudioGroup1Ch2TBL.3}	R/W	Integer	SDI output 3 CH2 level 0 - -60
I44sdi3AudioGroup1Ch2Click {I44sdi3AudioGroup1Ch2TBL.4}	R/W	Integer	SDI output 3 CH2 click insertion interval 1 = off 2 = click1sec 3 = click2sec 4 = click4sec
I44sdi3AudioGroup1Ch3TBL {I44sdi3AudioGroup1TBL.5}	-	Aggregate	-
I44sdi3AudioGroup1Ch3EqualToCh1 {I44sdi3AudioGroup1Ch3TBL.1}	R/W	Integer	Setting shared by SDI output 3 CH3 and CH1 1 = off 2 = on
I44sdi3AudioGroup1Ch3Frequency {I44sdi3AudioGroup1Ch3TBL.2}	R/W	Integer	SDI output 3 CH3 frequency 1 = silence 2 = freq400Hz 3 = freq800Hz 4 = freq1000Hz
I44sdi3AudioGroup1Ch3Level {I44sdi3AudioGroup1Ch3TBL.3}	R/W	Integer	SDI output 3 CH3 level 0 - -60
I44sdi3AudioGroup1Ch3Click {I44sdi3AudioGroup1Ch3TBL.4}	R/W	Integer	SDI output 3 CH3 click insertion interval 1 = off 2 = click1sec 3 = click2sec 4 = click4sec
I44sdi3AudioGroup1Ch4TBL {I44sdi3AudioGroup1TBL.6}	-	Aggregate	-
I44sdi3AudioGroup1Ch4EqualToCh1	R/W	Integer	Setting shared by SDI output 3 CH4 and CH1

OID	Access	Syntax	Description
{I44sdi3AudioGroup1Ch4TBL.1}			1 = off 2 = on
I44sdi3AudioGroup1Ch4Frequency {I44sdi3AudioGroup1Ch4TBL.2}	R/W	Integer	SDI output 3 CH4 frequency 1 = silence 2 = freq400Hz 3 = freq800Hz 4 = freq1000Hz
I44sdi3AudioGroup1Ch4Level {I44sdi3AudioGroup1Ch4TBL.3}	R/W	Integer	SDI output 3 CH4 level 0 - -60
I44sdi3AudioGroup1Ch4Click {I44sdi3AudioGroup1Ch4TBL.4}	R/W	Integer	SDI output 3 CH4 click insertion interval 1 = off 2 = click1sec 3 = click2sec 4 = click4sec
I44sdi3AudioGroup1Resolution {I44sdi3AudioGroup1TBL.7}	R/W	Integer	SDI output 3 audio group 1 resolution 1 = resolution20bit 2 = resolution24bit
I44sdi3AudioGroup1Emphasis {I44sdi3AudioGroup1TBL.8}	R/W	Integer	SDI output 3 audio group 1 pre-emphasis mode 1 = emphasis50-15 2 = ccittl 3 = off
I44sdi3AudioGroup2TBL {I44sdi3AudioTBL.2}	-	Aggregate	-
I44sdi3AudioGroup2 {I44sdi3AudioGroup2TBL.1}	R/W	Integer	SDI output 3 audio group 2 1 = off 2 = on
I44sdi3AudioGroup2EqualToG1 {I44sdi3AudioGroup2TBL.2}	R/W	Integer	Setting shared by SDI output 3 audio group 2 and audio group 1 1 = off 2 = on
I44sdi3AudioGroup2Ch5TBL {I44sdi3AudioGroup2TBL.3}	-	Aggregate	-
I44sdi3AudioGroup2Ch5Frequency {I44sdi3AudioGroup2Ch5TBL.2}	R/W	Integer	SDI output 3 CH5 frequency 1 = silence 2 = freq400Hz 3 = freq800Hz 4 = freq1000Hz
I44sdi3AudioGroup2Ch5Level {I44sdi3AudioGroup2Ch5TBL.3}	R/W	Integer	SDI output 3 CH5 level 0 - -60
I44sdi3AudioGroup2Ch5Click {I44sdi3AudioGroup2Ch5TBL.4}	R/W	Integer	SDI output 3 CH5 click insertion interval 1 = off 2 = click1sec 3 = click2sec 4 = click4sec
I44sdi3AudioGroup2Ch6TBL {I44sdi3AudioGroup2TBL.4}	-	Aggregate	-

OID	Access	Syntax	Description
I44sdi3AudioGroup2Ch6EqualToCh5 {I44sdi3AudioGroup2Ch6TBL.1}	R/W	Integer	Setting shared by SDI output 3 CH6 and CH5 1 = off 2 = on
I44sdi3AudioGroup2Ch6Frequency {I44sdi3AudioGroup2Ch6TBL.2}	R/W	Integer	SDI output 3 CH6 frequency 1 = silence 2 = freq400Hz 3 = freq800Hz 4 = freq1000Hz
I44sdi3AudioGroup2Ch6Level {I44sdi3AudioGroup2Ch6TBL.3}	R/W	Integer	SDI output 3 CH6 level 0 - -60
I44sdi3AudioGroup2Ch6Click {I44sdi3AudioGroup2Ch6TBL.4}	R/W	Integer	SDI output 3 CH6 click insertion interval 1 = off 2 = click1sec 3 = click2sec 4 = click4sec
I44sdi3AudioGroup2Ch7TBL {I44sdi3AudioGroup2TBL.5}	-	Aggregate	-
I44sdi3AudioGroup2Ch7EqualToCh5 {I44sdi3AudioGroup2Ch7TBL.1}	R/W	Integer	Setting shared by SDI output 3 CH7 and CH5 1 = off 2 = on
I44sdi3AudioGroup2Ch7Frequency {I44sdi3AudioGroup2Ch7TBL.2}	R/W	Integer	SDI output 3 CH7 frequency 1 = silence 2 = freq400Hz 3 = freq800Hz 4 = freq1000Hz
I44sdi3AudioGroup2Ch7Level {I44sdi3AudioGroup2Ch7TBL.3}	R/W	Integer	SDI output 3 CH7 level 0 - -60
I44sdi3AudioGroup2Ch7Click {I44sdi3AudioGroup2Ch7TBL.4}	R/W	Integer	SDI output 3 CH7 click insertion interval 1 = off 2 = click1sec 3 = click2sec 4 = click4sec
I44sdi3AudioGroup2Ch8TBL {I44sdi3AudioGroup2TBL.6}	-	Aggregate	-
I44sdi3AudioGroup2Ch8EqualToCh5 {I44sdi3AudioGroup2Ch8TBL.1}	R/W	Integer	Setting shared by SDI output 3 CH8 and CH5 1 = off 2 = on
I44sdi3AudioGroup2Ch8Frequency {I44sdi3AudioGroup2Ch8TBL.2}	R/W	Integer	SDI output 3 CH8 frequency 1 = silence 2 = freq400Hz 3 = freq800Hz 4 = freq1000Hz
I44sdi3AudioGroup2Ch8Level {I44sdi3AudioGroup2Ch8TBL.3}	R/W	Integer	SDI output 3 CH8 level 0 - -60
I44sdi3AudioGroup2Ch8Click {I44sdi3AudioGroup2Ch8TBL.4}	R/W	Integer	SDI output 3 CH8 click insertion interval 1 = off

OID	Access	Syntax	Description
			2 = click1sec 3 = click2sec 4 = click4sec
I44sdi3AudioGroup2Resolution {I44sdi3AudioGroup2TBL.7}	R/W	Integer	SDI output 3 audio group 2 resolution 1 = resolution20bit 2 = resolution24bit
I44sdi3AudioGroup2Emphasis {I44sdi3AudioGroup2TBL.8}	R/W	Integer	SDI output 3 audio group 2 pre-emphasis mode 1 = emphasis50-15 2 = ccittl 3 = off
I44sdi3AudioGroup3TBL {I44sdi3AudioTBL.3}	-	Aggregate	-
I44sdi3AudioGroup3 {I44sdi3AudioGroup3TBL.1}	R/W	Integer	SDI output 3 audio group 3 1 = off 2 = on
I44sdi3AudioGroup3EqualToG1 {I44sdi3AudioGroup3TBL.2}	R/W	Integer	Setting shared by SDI output 3 audio group 3 and audio group 1 1 = off 2 = on
I44sdi3AudioGroup3Ch9TBL {I44sdi3AudioGroup3TBL.3}	-	Aggregate	-
I44sdi3AudioGroup3Ch9Frequency {I44sdi3AudioGroup3Ch9TBL.2}	R/W	Integer	SDI output 3 CH9 frequency 1 = silence 2 = freq400Hz 3 = freq800Hz 4 = freq1000Hz
I44sdi3AudioGroup3Ch9Level {I44sdi3AudioGroup3Ch9TBL.3}	R/W	Integer	SDI output 3 CH9 level 0 - -60
I44sdi3AudioGroup3Ch9Click {I44sdi3AudioGroup3Ch9TBL.4}	R/W	Integer	SDI output 3 CH9 click insertion interval 1 = off 2 = click1sec 3 = click2sec 4 = click4sec
I44sdi3AudioGroup3Ch10TBL {I44sdi3AudioGroup3TBL.4}	-	Aggregate	-
I44sdi3AudioGroup3Ch10EqualToCh9 {I44sdi3AudioGroup3Ch10TBL.1}	R/W	Integer	Setting shared by SDI output 3 CH10 and CH9 1 = off 2 = on
I44sdi3AudioGroup3Ch10Frequency {I44sdi3AudioGroup3Ch10TBL.2}	R/W	Integer	SDI output 3 CH10 frequency 1 = silence 2 = freq400Hz 3 = freq800Hz 4 = freq1000Hz
I44sdi3AudioGroup3Ch10Level {I44sdi3AudioGroup3Ch10TBL.3}	R/W	Integer	SDI output 3 CH10 level 0 - -60
I44sdi3AudioGroup3Ch10Click	R/W	Integer	SDI output 3 CH10 click insertion interval

OID	Access	Syntax	Description
{I44sdi3AudioGroup3Ch10TBL.4}			1 = off 2 = click1sec 3 = click2sec 4 = click4sec
I44sdi3AudioGroup3Ch11TBL {I44sdi3AudioGroup3TBL.5}	-	Aggregate	-
I44sdi3AudioGroup3Ch11EqualToCh9 {I44sdi3AudioGroup3Ch11TBL.1}	R/W	Integer	Setting shared by SDI output 3 CH11 and CH9 1 = off 2 = on
I44sdi3AudioGroup3Ch11Frequency {I44sdi3AudioGroup3Ch11TBL.2}	R/W	Integer	SDI output 3 CH11 frequency 1 = silence 2 = freq400Hz 3 = freq800Hz 4 = freq1000Hz
I44sdi3AudioGroup3Ch11Level {I44sdi3AudioGroup3Ch11TBL.3}	R/W	Integer	SDI output 3 CH11 level 0 - -60
I44sdi3AudioGroup3Ch11Click {I44sdi3AudioGroup3Ch11TBL.4}	R/W	Integer	SDI output 3 CH11 click insertion interval 1 = off 2 = click1sec 3 = click2sec 4 = click4sec
I44sdi3AudioGroup3Ch12TBL {I44sdi3AudioGroup3TBL.6}	-	Aggregate	-
I44sdi3AudioGroup3Ch12EqualToCh9 {I44sdi3AudioGroup3Ch12TBL.1}	R/W	Integer	Setting shared by SDI output 3 CH12 and CH9 1 = off 2 = on
I44sdi3AudioGroup3Ch12Frequency {I44sdi3AudioGroup3Ch12TBL.2}	R/W	Integer	SDI output 3 CH12 frequency 1 = silence 2 = freq400Hz 3 = freq800Hz 4 = freq1000Hz
I44sdi3AudioGroup3Ch12Level {I44sdi3AudioGroup3Ch12TBL.3}	R/W	Integer	SDI output 3 CH12 level 0 - -60
I44sdi3AudioGroup3Ch12Click {I44sdi3AudioGroup3Ch12TBL.4}	R/W	Integer	SDI output 3 CH12 click insertion interval 1 = off 2 = click1sec 3 = click2sec 4 = click4sec
I44sdi3AudioGroup3Resolution {I44sdi3AudioGroup3TBL.7}	R/W	Integer	SDI output 3 audio group 3 resolution 1 = resolution20bit 2 = resolution24bit
I44sdi3AudioGroup3Emphasis {I44sdi3AudioGroup3TBL.8}	R/W	Integer	SDI output 3 audio group 3 pre-emphasis mode 1 = emphasis50-15 2 = ccittl 3 = off
I44sdi3AudioGroup4TBL	-	Aggregate	-

OID	Access	Syntax	Description
{I44sdi3AudioTBL.4}			
I44sdi3AudioGroup4 {I44sdi3AudioGroup4TBL.1}	R/W	Integer	SDI output 3 audio group 4 1 = off 2 = on
I44sdi3AudioGroup4EqualToG3 {I44sdi3AudioGroup4TBL.2}	R/W	Integer	Setting shared by SDI output 3 audio group 4 and audio group 3 1 = off 2 = on
I44sdi3AudioGroup4Ch13TBL {I44sdi3AudioGroup4TBL.3}	-	Aggregate	-
I44sdi3AudioGroup4Ch13Frequency {I44sdi3AudioGroup4Ch13TBL.2}	R/W	Integer	SDI output 3 CH13 frequency 1 = silence 2 = freq400Hz 3 = freq800Hz 4 = freq1000Hz
I44sdi3AudioGroup4Ch13Level {I44sdi3AudioGroup4Ch13TBL.3}	R/W	Integer	SDI output 3 CH13 level 0 - -60
I44sdi3AudioGroup4Ch13Click {I44sdi3AudioGroup4Ch13TBL.4}	R/W	Integer	SDI output 3 CH13 click insertion interval 1 = off 2 = click1sec 3 = click2sec 4 = click4sec
I44sdi3AudioGroup4Ch14TBL {I44sdi3AudioGroup4TBL.4}	-	Aggregate	-
I44sdi3AudioGroup4Ch14EqualToCh13 {I44sdi3AudioGroup4Ch14TBL.1}	R/W	Integer	Setting shared by SDI output 3 CH14 and CH13 1 = off 2 = on
I44sdi3AudioGroup4Ch14Frequency {I44sdi3AudioGroup4Ch14TBL.2}	R/W	Integer	SDI output 3 CH14 frequency 1 = silence 2 = freq400Hz 3 = freq800Hz 4 = freq1000Hz
I44sdi3AudioGroup4Ch14Level {I44sdi3AudioGroup4Ch14TBL.3}	R/W	Integer	SDI output 3 CH14 level 0 - -60
I44sdi3AudioGroup4Ch14Click {I44sdi3AudioGroup4Ch14TBL.4}	R/W	Integer	SDI output 3 CH14 click insertion interval 1 = off 2 = click1sec 3 = click2sec 4 = click4sec
I44sdi3AudioGroup4Ch15TBL {I44sdi3AudioGroup4TBL.5}	-	Aggregate	-
I44sdi3AudioGroup4Ch15EqualToCh13 {I44sdi3AudioGroup4Ch15TBL.1}	R/W	Integer	Setting shared by SDI output 3 CH15 and CH13 1 = off 2 = on
I44sdi3AudioGroup4Ch15Frequency {I44sdi3AudioGroup4Ch15TBL.2}	R/W	Integer	SDI output 3 CH15 frequency 1 = silence

OID	Access	Syntax	Description
			2 = freq400Hz 3 = freq800Hz 4 = freq1000Hz
I44sdi3AudioGroup4Ch15Level {I44sdi3AudioGroup4Ch15TBL.3}	R/W	Integer	SDI output 3 CH15 level 0 - -60
I44sdi3AudioGroup4Ch15Click {I44sdi3AudioGroup4Ch15TBL.4}	R/W	Integer	SDI output 3 CH15 click insertion interval 1 = off 2 = click1sec 3 = click2sec 4 = click4sec
I44sdi3AudioGroup4Ch16TBL {I44sdi3AudioGroup4TBL.6}	-	Aggregate	-
I44sdi3AudioGroup4Ch16EqualToCh13 {I44sdi3AudioGroup4Ch16TBL.1}	R/W	Integer	Setting shared by SDI output 3 CH16 and CH13 1 = off 2 = on
I44sdi3AudioGroup4Ch16Frequency {I44sdi3AudioGroup4Ch16TBL.2}	R/W	Integer	SDI output 3 CH16 frequency 1 = silence 2 = freq400Hz 3 = freq800Hz 4 = freq1000Hz
I44sdi3AudioGroup4Ch16Level {I44sdi3AudioGroup4Ch16TBL.3}	R/W	Integer	SDI output 3 CH16 level 0 - -60
I44sdi3AudioGroup4Ch16Click {I44sdi3AudioGroup4Ch16TBL.4}	R/W	Integer	SDI output 3 CH16 click insertion interval 1 = off 2 = click1sec 3 = click2sec 4 = click4sec
I44sdi3AudioGroup4Resolution {I44sdi3AudioGroup4TBL.7}	R/W	Integer	SDI output 3 audio group 4 resolution 1 = resolution20bit 2 = resolution24bit
I44sdi3AudioGroup4Emphasis {I44sdi3AudioGroup4TBL.8}	R/W	Integer	SDI output 3 audio group 4 pre-emphasis mode 1 = emphasis50-15 2 = ccittl 3 = off
I44sdi3AncTBL {I44sdi3TBL.7}	-	Aggregate	-
I44sdi3AtcLtc {I44sdi3AncTBL.1}	R/W	Integer	Insertion of LTC into SDI output 3 1 = off 2 = on
I44sdi3AtcVtc {I44sdi3AncTBL.2}	R/W	Integer	Insertion of VITC into SDI output 3 1 = off 2 = on
I44sdi3AtcDropFrame {I44sdi3AncTBL.3}	R/W	Integer	SDI output 3 dropped frame 1 = off 2 = on
I44sdi3OutputTBL	-	Aggregate	-

OID	Access	Syntax	Description
{I44sdi3TBL.8}			
I44sdi3Output {I44sdi3OutputTBL.1}	R/W	Integer	SDI output 3 1 = enable 2 = disable
I44sdi3OutputLinktoPtp1Bmca {I44sdi3OutputTBL.2}	R/W	Integer	SDI output 3 BMCA linking (PTP1) 1 = enable 2 = disable
I44sdi3OutputLinktoPtp2Bmca {I44sdi3OutputTBL.3}	R/W	Integer	SDI output 3 BMCA linking (PTP2) 1 = enable 2 = disable
I44sdi4TBL {It4670ser02.4}	-	Aggregate	-
I44sdi4EqualToSDI3TBL {I44sdi4TBL.1}	-	Aggregate	-
I44sdi4EqualToSDI3 {I44sdi4EqualToSDI3TBL.1}	R/W	Integer	Setting shared by SDI output 4 and SDI output 3 1 = off 2 = on
I44sdi4FormatTBL {I44sdi4TBL.2}	-	Aggregate	-
I44sdi4System {I44sdi4FormatTBL.1}	R/W	Integer	SDI output 4 format 1 = f720x487-SD 2 = f720x576-SD 3 = f1280x720-HD 4 = f1920x1080-HD 5 = f1280x720-3G-A 6 = f1920x1080-3G-A 7 = f1920x1080-3G-B-DL 12 = f3840x2160-12G 13 = f4096x2160-12G
I44sdi4Structure {I44sdi4FormatTBL.2}	R/W	Integer	Color system and quantization accuracy of SDI output 4 1 = fYCbCr-422-10bit 2 = fYCbCr-422-12bit 3 = fRGB-444-10bit 4 = fRGB-444-12bit
I44sdi4Framerate {I44sdi4FormatTBL.3}	R/W	Integer	SDI output 4 frame (field) frequency 1 = f60p 2 = f59p94p 3 = f50p 4 = f48p 5 = f30p 6 = f29p97p 7 = f25p 8 = f47p95p 9 = f24p

OID	Access	Syntax	Description
			10 = f23p98p 11 = f30psf 12 = f29.97psf 13 = f25psf 14 = f24psF 15 = f23p98psf 16 = f60i 17 = f59.94i 18 = f50i
I44sdi4TimingTBL {I44sdi4TBL.3}	-	Aggregate	-
I44sdi40HTiming {I44sdi4TimingTBL.1}	R/W	Integer	Reference timing for SDI output 4 1 = serial 2 = legacy
I44sdi4TimingVertical {I44sdi4TimingTBL.2}	R/W	Integer	SDI output 4 timing relative to the reference signal (in lines) ±1124
I44sdi4TimingHorizontal {I44sdi4TimingTBL.3}	R/W	Integer	SDI output 4 timing relative to the reference signal (in dots) ±4124
I44sdi4PatternTBL {I44sdi4TBL.4}	-	Aggregate	-
I44sdi4Pattern {I44sdi4PatternTBL.1}	R/W	Integer	SDI output 4 pattern 1 = colorbar100 2 = colorbar75 3 = multiCB100 4 = multiCB75 5 = multiCBplusI 6 = smpteCB 7 = ebuColorbar 8 = bbcColorbar 9 = flatField100 10 = flatField50 11 = flatField0 12 = redFiled 13 = greenField 14 = blueField 15 = checkfield
I44sdi4VideoTBL {I44sdi4TBL.5}	-	Aggregate	-
I44sdi4ComponentTBL {I44sdi4VideoTBL.1}	-	Aggregate	-
I44sdi4Component {I44sdi4ComponentTBL.1}	R/W	Integer	SDI output 4 component (Y/G-Cb/B-Cr/R) 1 = off-off-off 2 = on-off-off 3 = off-on-off

OID	Access	Syntax	Description
			4 = on-on-off 5 = off-off-on 6 = on-off-on 7 = off-on-on 8 = on-on-on
I44sdi4SafetyAreaTBL {I44sdi4VideoTBL.2}	-	Aggregate	-
I44sdi4SafetyArea90 {I44sdi4SafetyAreaTBL.1}	R/W	Integer	90% safety area marker of SDI output 4 1 = off 2 = on
I44sdi4SafetyArea80 {I44sdi4SafetyAreaTBL.2}	R/W	Integer	80% safety area marker of SDI output 4 1 = off 2 = on
I44sdi4SafetyArea43 {I44sdi4SafetyAreaTBL.3}	R/W	Integer	4:3 safety area marker of SDI output 4 1 = off 2 = on
I44sdi4ScrollTBL {I44sdi4VideoTBL.3}	-	Aggregate	-
I44sdi4Scroll {I44sdi4ScrollTBL.1}	R/W	Integer	SDI output 4 scroll 1 = off 2 = on
I44sdi4ScrollVspeed {I44sdi4ScrollTBL.2}	R/W	Integer	Vertical scroll speed and direction of SDI output 4 ±256
I44sdi4ScrollHspeed {I44sdi4ScrollTBL.3}	R/W	Integer	Horizontal scroll speed and direction of SDI output 4 ±256
I44sdi4PatternChangeTBL {I44sdi4VideoTBL.4}	-	Aggregate	-
I44sdi4PatternChange {I44sdi4PatternChangeTBL.1}	R/W	Integer	SDI output 4 pattern change 1 = off 2 = on
I44sdi4PattnrChangespeed {I44sdi4PatternChangeTBL.2}	R/W	Integer	SDI output 4 pattern switching interval 1 - 255
I44sdi4IdCharacterTBL {I44sdi4VideoTBL.5}	-	Aggregate	-
I44sdi4IdCharacter {I44sdi4IdCharacterTBL.1}	R/W	Integer	SDI output 4 ID characters 1 = off 2 = on
I44sdi4IdCharacterVposition {I44sdi4IdCharacterTBL.2}	R/W	Integer	Vertical ID character position of SDI output 4 0 - 100
I44sdi4IdCharacterHposition {I44sdi4IdCharacterTBL.3}	R/W	Integer	Horizontal ID character position of SDI output 4 0 - 100
I44sdi4IdCharacterSize {I44sdi4IdCharacterTBL.4}	R/W	Integer	SDI output 4 ID character size 1 = x1 2 = x2

OID	Access	Syntax	Description
			3 = x4 4 = x8
I44sdi4IdCharacterLevel {I44sdi4IdCharacterTBL.5}	R/W	Integer	SDI output 4 ID character luminance level 1 = per-100 2 = per-75
I44sdi4IdCharacterBlinkTBL {I44sdi4IdCharacterTBL.6}	-	Aggregate	-
I44sdi4IdCharacterBlink {I44sdi4IdCharacterBlinkTBL.1}	R/W	Integer	SDI output 4 ID character blinking 1 = off 2 = on
I44sdi4IdCharacterBlinkOffTime {I44sdi4IdCharacterBlinkTBL.2}	R/W	Integer	SDI output 4 ID character blinking off-time 1 - 9
I44sdi4IdCharacterBlinkOnTime {I44sdi4IdCharacterBlinkTBL.3}	R/W	Integer	SDI output 4 ID character blinking on-time 1 - 9
I44sdi4IdCharacterScrollTBL {I44sdi4IdCharacterTBL.7}	-	Aggregate	-
I44sdi4IdCharacterScroll {I44sdi4IdCharacterScrollTBL.1}	R/W	Integer	SDI output 4 ID character scroll 1 = off 2 = on
I44sdi4IdCharacterScrollSpeed {I44sdi4IdCharacterScrollTBL.2}	R/W	Integer	SDI output 4 ID character scroll speed and direction ±256
I44sdi4IdCharacterBackground {I44sdi4IdCharacterTBL.8}	R/W	Integer	SDI output 4 ID character background transparency 1 = off 2 = on
I44sdi4LogoTBL {I44sdi4VideoTBL.6}	-	Aggregate	-
I44sdi4Logo {I44sdi4LogoTBL.1}	R/W	Integer	SDI output 4 logo 1 = off 2 = on
I44sdi4LogoSelect {I44sdi4LogoTBL.2}	R/W	Integer	SDI output 4 logo number 1 - 4
I44sdi4LogoVposition {I44sdi4LogoTBL.3}	R/W	Integer	Vertical logo position of SDI output 4 0 - 100
I44sdi4LogoHposition {I44sdi4LogoTBL.4}	R/W	Integer	Horizontal logo position of SDI output 4 0 - 100
I44sdi4LogoTransParency {I44sdi4LogoTBL.5}	R/W	Integer	SDI output 4 logo transparency 1 = off 2 = on
I44sdi4LogoTransParencyLevel {I44sdi4LogoTBL.6}	R/W	Integer	SDI output 4 logo transparency level 0 - 255
I44sdi4MovingBoxTBL {I44sdi4VideoTBL.7}	-	Aggregate	-
I44sdi4MovingBox {I44sdi4MovingBoxTBL.1}	R/W	Integer	SDI output 4 moving box 1 = off

OID	Access	Syntax	Description
			2 = on
I44sdi4MovingBoxColor {I44sdi4MovingBoxTBL.2}	R/W	Integer	SDI output 4 moving box color 1 = white 2 = yellow 3 = cyan 4 = green 5 = blue 6 = red 7 = magenta 8 = black
I44sdi4MovingBoxVspeed {I44sdi4MovingBoxTBL.3}	R/W	Integer	Vertical moving box speed of SDI output 4 1 = low 2 = middle 3 = high
I44sdi4MovingBoxHspeed {I44sdi4MovingBoxTBL.4}	R/W	Integer	Horizontal moving box speed of SDI output 4 1 = low 2 = middle 3 = high
I44sdi4MovingBoxVsize {I44sdi4MovingBoxTBL.5}	R/W	Integer	SDI output 4 moving box height 1 = size1 2 = size2 3 = size3 4 = size4 5 = size5
I44sdi4MovingBoxHsize {I44sdi4MovingBoxTBL.6}	R/W	Integer	SDI output 4 moving box width 1 = size1 2 = size2 3 = size3 4 = size4 5 = size5
I44sdi4CircleTBL {I44sdi4VideoTBL.8}	-	Aggregate	-
I44sdi4Circle {I44sdi4CircleTBL.1}	R/W	Integer	SDI output 4 circle 1 = off 2 = on
I44sdi4CircleSize {I44sdi4CircleTBL.2}	R/W	Integer	SDI output 4 circle size 1 = per-90 2 = per-80 3 = per-70
I44sdi4CircleLevel {I44sdi4CircleTBL.3}	R/W	Integer	SDI output 4 circle luminance level 1 = per-100 2 = per-75
I44sdi4CircleBlinkTBL {I44sdi4CircleTBL.4}	-	Aggregate	-
I44sdi4CircleBlink {I44sdi4CircleBlinkTBL.1}	R/W	Integer	SDI output 4 circle blinking 1 = off

OID	Access	Syntax	Description
			2 = on
I44sdi4CircleBlinkOffTime {I44sdi4CircleBlinkTBL.2}	R/W	Integer	SDI output 4 circle blinking off-time 1 - 9
I44sdi4CircleBlinkOnTime {I44sdi4CircleBlinkTBL.3}	R/W	Integer	SDI output 4 circle blinking on-time 1 - 9
I44sdi4TimecodeTBL {I44sdi4VideoTBL.9}	-	Aggregate	-
I44sdi4Timecode {I44sdi4TimecodeTBL.1}	R/W	Integer	SDI output 4 time code 1 = off 2 = on
I44sdi4TimecodeVposition {I44sdi4TimecodeTBL.2}	R/W	Integer	Vertical time code position of SDI output 4 0 - 100
I44sdi4TimecodeHposition {I44sdi4TimecodeTBL.3}	R/W	Integer	Horizontal time code position of SDI output 4 0 - 100
I44sdi4TimecodeSize {I44sdi4TimecodeTBL.4}	R/W	Integer	SDI output 4 time code size 1 = x1 2 = x2 3 = x4 4 = x8
I44sdi4TimecodeLevel {I44sdi4TimecodeTBL.5}	R/W	Integer	SDI output 4 time code luminance level 1 = per-100 2 = per-75
I44sdi4TimecodeBackground {I44sdi4TimecodeTBL.6}	R/W	Integer	SDI output 4 time code background transparency 1 = off 2 = on
I44sdi4LipsyncTBL {I44sdi4VideoTBL.10}	-	Aggregate	-
I44sdi4Lipsync {I44sdi4LipsyncTBL.1}	R/W	Integer	SDI output 4 lip sync pattern 1 = off 2 = on
I44sdi4AudioTBL {I44sdi4TBL.6}	-	Aggregate	-
I44sdi4AudioGroup1TBL {I44sdi4AudioTBL.1}	-	Aggregate	-
I44sdi4AudioGroup1 {I44sdi4AudioGroup1TBL.1}	R/W	Integer	SDI output 4 audio group 1 1 = off 2 = on
I44sdi4AudioGroup1Ch1TBL {I44sdi4AudioGroup1TBL.3}	-	Aggregate	-
I44sdi4AudioGroup1Ch1Frequency {I44sdi4AudioGroup1Ch1TBL.2}	R/W	Integer	SDI output 4 CH1 frequency 1 = silence 2 = freq400Hz 3 = freq800Hz 4 = freq1000Hz
I44sdi4AudioGroup1Ch1Level	R/W	Integer	SDI output 4 CH1 level

OID	Access	Syntax	Description
{I44sdi4AudioGroup1Ch1TBL.3}			0 - -60
I44sdi4AudioGroup1Ch1Click {I44sdi4AudioGroup1Ch1TBL.4}	R/W	Integer	SDI output 4 CH1 click insertion interval 1 = off 2 = click1sec 3 = click2sec 4 = click4sec
I44sdi4AudioGroup1Ch2TBL {I44sdi4AudioGroup1TBL.4}	-	Aggregate	-
I44sdi4AudioGroup1Ch2EqualToCh1 {I44sdi4AudioGroup1Ch2TBL.1}	R/W	Integer	Setting shared by SDI output 4 CH2 and CH1 1 = off 2 = on
I44sdi4AudioGroup1Ch2Frequency {I44sdi4AudioGroup1Ch2TBL.2}	R/W	Integer	SDI output 4 CH2 frequency 1 = silence 2 = freq400Hz 3 = freq800Hz 4 = freq1000Hz
I44sdi4AudioGroup1Ch2Level {I44sdi4AudioGroup1Ch2TBL.3}	R/W	Integer	SDI output 4 CH2 level 0 - -60
I44sdi4AudioGroup1Ch2Click {I44sdi4AudioGroup1Ch2TBL.4}	R/W	Integer	SDI output 4 CH2 click insertion interval 1 = off 2 = click1sec 3 = click2sec 4 = click4sec
I44sdi4AudioGroup1Ch3TBL {I44sdi4AudioGroup1TBL.5}	-	Aggregate	-
I44sdi4AudioGroup1Ch3EqualToCh1 {I44sdi4AudioGroup1Ch3TBL.1}	R/W	Integer	Setting shared by SDI output 4 CH3 and CH1 1 = off 2 = on
I44sdi4AudioGroup1Ch3Frequency {I44sdi4AudioGroup1Ch3TBL.2}	R/W	Integer	SDI output 4 CH3 frequency 1 = silence 2 = freq400Hz 3 = freq800Hz 4 = freq1000Hz
I44sdi4AudioGroup1Ch3Level {I44sdi4AudioGroup1Ch3TBL.3}	R/W	Integer	SDI output 4 CH3 level 0 - -60
I44sdi4AudioGroup1Ch3Click {I44sdi4AudioGroup1Ch3TBL.4}	R/W	Integer	SDI output 4 CH3 click insertion interval 1 = off 2 = click1sec 3 = click2sec 4 = click4sec
I44sdi4AudioGroup1Ch4TBL {I44sdi4AudioGroup1TBL.6}	-	Aggregate	-
I44sdi4AudioGroup1Ch4EqualToCh1 {I44sdi4AudioGroup1Ch4TBL.1}	R/W	Integer	Setting shared by SDI output 4 CH4 and CH1 1 = off 2 = on
I44sdi4AudioGroup1Ch4Frequency	R/W	Integer	SDI output 4 CH4 frequency

OID	Access	Syntax	Description
{I44sdi4AudioGroup1Ch4TBL.2}			1 = silence 2 = freq400Hz 3 = freq800Hz 4 = freq1000Hz
I44sdi4AudioGroup1Ch4Level {I44sdi4AudioGroup1Ch4TBL.3}	R/W	Integer	SDI output 4 CH4 level 0 - -60
I44sdi4AudioGroup1Ch4Click {I44sdi4AudioGroup1Ch4TBL.4}	R/W	Integer	SDI output 4 CH4 click insertion interval 1 = off 2 = click1sec 3 = click2sec 4 = click4sec
I44sdi4AudioGroup1Resolution {I44sdi4AudioGroup1TBL.7}	R/W	Integer	SDI output 4 audio group 1 resolution 1 = resolution20bit 2 = resolution24bit
I44sdi4AudioGroup1Emphasis {I44sdi4AudioGroup1TBL.8}	R/W	Integer	SDI output 4 audio group 1 pre-emphasis mode 1 = emphasis50-15 2 = ccittl 3 = off
I44sdi4AudioGroup2TBL {I44sdi4AudioTBL.2}	-	Aggregate	-
I44sdi4AudioGroup2 {I44sdi4AudioGroup2TBL.1}	R/W	Integer	SDI output 4 audio group 2 1 = off 2 = on
I44sdi4AudioGroup2EqualToG1 {I44sdi4AudioGroup2TBL.2}	R/W	Integer	Setting shared by SDI output 4 audio group 2 and audio group 1 1 = off 2 = on
I44sdi4AudioGroup2Ch5TBL {I44sdi4AudioGroup2TBL.3}	-	Aggregate	-
I44sdi4AudioGroup2Ch5Frequency {I44sdi4AudioGroup2Ch5TBL.2}	R/W	Integer	SDI output 4 CH5 frequency 1 = silence 2 = freq400Hz 3 = freq800Hz 4 = freq1000Hz
I44sdi4AudioGroup2Ch5Level {I44sdi4AudioGroup2Ch5TBL.3}	R/W	Integer	SDI output 4 CH5 level 0 - -60
I44sdi4AudioGroup2Ch5Click {I44sdi4AudioGroup2Ch5TBL.4}	R/W	Integer	SDI output 4 CH5 click insertion interval 1 = off 2 = click1sec 3 = click2sec 4 = click4sec
I44sdi4AudioGroup2Ch6TBL {I44sdi4AudioGroup2TBL.4}	-	Aggregate	-
I44sdi4AudioGroup2Ch6EqualToCh5 {I44sdi4AudioGroup2Ch6TBL.1}	R/W	Integer	Setting shared by SDI output 4 CH6 and CH5 1 = off 2 = on

OID	Access	Syntax	Description
I44sdi4AudioGroup2Ch6Frequency {I44sdi4AudioGroup2Ch6TBL.2}	R/W	Integer	SDI output 4 CH6 frequency 1 = silence 2 = freq400Hz 3 = freq800Hz 4 = freq1000Hz
I44sdi4AudioGroup2Ch6Level {I44sdi4AudioGroup2Ch6TBL.3}	R/W	Integer	SDI output 4 CH6 level 0 - -60
I44sdi4AudioGroup2Ch6Click {I44sdi4AudioGroup2Ch6TBL.4}	R/W	Integer	SDI output 4 CH6 click insertion interval 1 = off 2 = click1sec 3 = click2sec 4 = click4sec
I44sdi4AudioGroup2Ch7TBL {I44sdi4AudioGroup2TBL.5}	-	Aggregate	-
I44sdi4AudioGroup2Ch7EqualToCh5 {I44sdi4AudioGroup2Ch7TBL.1}	R/W	Integer	Setting shared by SDI output 4 CH7 and CH5 1 = off 2 = on
I44sdi4AudioGroup2Ch7Frequency {I44sdi4AudioGroup2Ch7TBL.2}	R/W	Integer	SDI output 4 CH7 frequency 1 = silence 2 = freq400Hz 3 = freq800Hz 4 = freq1000Hz
I44sdi4AudioGroup2Ch7Level {I44sdi4AudioGroup2Ch7TBL.3}	R/W	Integer	SDI output 4 CH7 level 0 - -60
I44sdi4AudioGroup2Ch7Click {I44sdi4AudioGroup2Ch7TBL.4}	R/W	Integer	SDI output 4 CH7 click insertion interval 1 = off 2 = click1sec 3 = click2sec 4 = click4sec
I44sdi4AudioGroup2Ch8TBL {I44sdi4AudioGroup2TBL.6}	-	Aggregate	-
I44sdi4AudioGroup2Ch8EqualToCh5 {I44sdi4AudioGroup2Ch8TBL.1}	R/W	Integer	Setting shared by SDI output 4 CH8 and CH5 1 = off 2 = on
I44sdi4AudioGroup2Ch8Frequency {I44sdi4AudioGroup2Ch8TBL.2}	R/W	Integer	SDI output 4 CH8 frequency 1 = silence 2 = freq400Hz 3 = freq800Hz 4 = freq1000Hz
I44sdi4AudioGroup2Ch8Level {I44sdi4AudioGroup2Ch8TBL.3}	R/W	Integer	SDI output 4 CH8 level 0 - -60
I44sdi4AudioGroup2Ch8Click {I44sdi4AudioGroup2Ch8TBL.4}	R/W	Integer	SDI output 4 CH8 click insertion interval 1 = off 2 = click1sec 3 = click2sec 4 = click4sec

OID	Access	Syntax	Description
I44sdi4AudioGroup2Resolution {I44sdi4AudioGroup2TBL.7}	R/W	Integer	SDI output 4 audio group 2 resolution 1 = resolution20bit 2 = resolution24bit
I44sdi4AudioGroup2Emphasis {I44sdi4AudioGroup2TBL.8}	R/W	Integer	SDI output 4 audio group 2 pre-emphasis mode 1 = emphasis50-15 2 = ccittl 3 = off
I44sdi4AudioGroup3TBL {I44sdi4AudioTBL.3}	-	Aggregate	-
I44sdi4AudioGroup3 {I44sdi4AudioGroup3TBL.1}	R/W	Integer	SDI output 4 audio group 3 1 = off 2 = on
I44sdi4AudioGroup3EqualToG1 {I44sdi4AudioGroup3TBL.2}	R/W	Integer	Setting shared by SDI output 4 audio group 3 and audio group 1 1 = off 2 = on
I44sdi4AudioGroup3Ch9TBL {I44sdi4AudioGroup3TBL.3}	-	Aggregate	-
I44sdi4AudioGroup3Ch9Frequency {I44sdi4AudioGroup3Ch9TBL.2}	R/W	Integer	SDI output 4 CH9 frequency 1 = silence 2 = freq400Hz 3 = freq800Hz 4 = freq1000Hz
I44sdi4AudioGroup3Ch9Level {I44sdi4AudioGroup3Ch9TBL.3}	R/W	Integer	SDI output 4 CH9 level 0 - -60
I44sdi4AudioGroup3Ch9Click {I44sdi4AudioGroup3Ch9TBL.4}	R/W	Integer	SDI output 4 CH9 click insertion interval 1 = off 2 = click1sec 3 = click2sec 4 = click4sec
I44sdi4AudioGroup3Ch10TBL {I44sdi4AudioGroup3TBL.4}	-	Aggregate	-
I44sdi4AudioGroup3Ch10EqualToCh9 {I44sdi4AudioGroup3Ch10TBL.1}	R/W	Integer	Setting shared by SDI output 4 CH10 and CH9 1 = off 2 = on
I44sdi4AudioGroup3Ch10Frequency {I44sdi4AudioGroup3Ch10TBL.2}	R/W	Integer	SDI output 4 CH10 frequency 1 = silence 2 = freq400Hz 3 = freq800Hz 4 = freq1000Hz
I44sdi4AudioGroup3Ch10Level {I44sdi4AudioGroup3Ch10TBL.3}	R/W	Integer	SDI output 4 CH10 level 0 - -60
I44sdi4AudioGroup3Ch10Click {I44sdi4AudioGroup3Ch10TBL.4}	R/W	Integer	SDI output 4 CH10 click insertion interval 1 = off 2 = click1sec 3 = click2sec

OID	Access	Syntax	Description
			4 = click4sec
I44sdi4AudioGroup3Ch11TBL {I44sdi4AudioGroup3TBL.5}	-	Aggregate	-
I44sdi4AudioGroup3Ch11EqualToCh9 {I44sdi4AudioGroup3Ch11TBL.1}	R/W	Integer	Setting shared by SDI output 4 CH11 and CH9 1 = off 2 = on
I44sdi4AudioGroup3Ch11Frequency {I44sdi4AudioGroup3Ch11TBL.2}	R/W	Integer	SDI output 4 CH11 frequency 1 = silence 2 = freq400Hz 3 = freq800Hz 4 = freq1000Hz
I44sdi4AudioGroup3Ch11Level {I44sdi4AudioGroup3Ch11TBL.3}	R/W	Integer	SDI output 4 CH11 level 0 - -60
I44sdi4AudioGroup3Ch11Click {I44sdi4AudioGroup3Ch11TBL.4}	R/W	Integer	SDI output 4 CH11 click insertion interval 1 = off 2 = click1sec 3 = click2sec 4 = click4sec
I44sdi4AudioGroup3Ch12TBL {I44sdi4AudioGroup3TBL.6}	-	Aggregate	-
I44sdi4AudioGroup3Ch12EqualToCh9 {I44sdi4AudioGroup3Ch12TBL.1}	R/W	Integer	Setting shared by SDI output 4 CH12 and CH9 1 = off 2 = on
I44sdi4AudioGroup3Ch12Frequency {I44sdi4AudioGroup3Ch12TBL.2}	R/W	Integer	SDI output 4 CH12 frequency 1 = silence 2 = freq400Hz 3 = freq800Hz 4 = freq1000Hz
I44sdi4AudioGroup3Ch12Level {I44sdi4AudioGroup3Ch12TBL.3}	R/W	Integer	SDI output 4 CH12 level 0 - -60
I44sdi4AudioGroup3Ch12Click {I44sdi4AudioGroup3Ch12TBL.4}	R/W	Integer	SDI output 4 CH12 click insertion interval 1 = off 2 = click1sec 3 = click2sec 4 = click4sec
I44sdi4AudioGroup3Resolution {I44sdi4AudioGroup3TBL.7}	R/W	Integer	SDI output 4 audio group 3 resolution 1 = resolution20bit 2 = resolution24bit
I44sdi4AudioGroup3Emphasis {I44sdi4AudioGroup3TBL.8}	R/W	Integer	SDI output 4 audio group 3 pre-emphasis mode 1 = emphasis50-15 2 = ccittl 3 = off
I44sdi4AudioGroup4TBL {I44sdi4AudioTBL.4}	-	Aggregate	-
I44sdi4AudioGroup4 {I44sdi4AudioGroup4TBL.1}	R/W	Integer	SDI output 4 audio group 4 1 = off

OID	Access	Syntax	Description
			2 = on
I44sdi4AudioGroup4EqualToG3 {I44sdi4AudioGroup4TBL.2}	R/W	Integer	Setting shared by SDI output 4 audio group 4 and audio group 3 1 = off 2 = on
I44sdi4AudioGroup4Ch13TBL {I44sdi4AudioGroup4TBL.3}	-	Aggregate	-
I44sdi4AudioGroup4Ch13Frequency {I44sdi4AudioGroup4Ch13TBL.2}	R/W	Integer	SDI output 4 CH13 frequency 1 = silence 2 = freq400Hz 3 = freq800Hz 4 = freq1000Hz
I44sdi4AudioGroup4Ch13Level {I44sdi4AudioGroup4Ch13TBL.3}	R/W	Integer	SDI output 4 CH13 level 0 - -60
I44sdi4AudioGroup4Ch13Click {I44sdi4AudioGroup4Ch13TBL.4}	R/W	Integer	SDI output 4 CH13 click insertion interval 1 = off 2 = click1sec 3 = click2sec 4 = click4sec
I44sdi4AudioGroup4Ch14TBL {I44sdi4AudioGroup4TBL.4}	-	Aggregate	-
I44sdi4AudioGroup4Ch14EqualToCh13 {I44sdi4AudioGroup4Ch14TBL.1}	R/W	Integer	Setting shared by SDI output 4 CH14 and CH13 1 = off 2 = on
I44sdi4AudioGroup4Ch14Frequency {I44sdi4AudioGroup4Ch14TBL.2}	R/W	Integer	SDI output 4 C14 frequency 1 = silence 2 = freq400Hz 3 = freq800Hz 4 = freq1000Hz
I44sdi4AudioGroup4Ch14Level {I44sdi4AudioGroup4Ch14TBL.3}	R/W	Integer	SDI output 4 CH14 level 0 - -60
I44sdi4AudioGroup4Ch14Click {I44sdi4AudioGroup4Ch14TBL.4}	R/W	Integer	SDI output 4 CH14 click insertion interval 1 = off 2 = click1sec 3 = click2sec 4 = click4sec
I44sdi4AudioGroup4Ch15TBL {I44sdi4AudioGroup4TBL.5}	-	Aggregate	-
I44sdi4AudioGroup4Ch15EqualToCh13 {I44sdi4AudioGroup4Ch15TBL.1}	R/W	Integer	Setting shared by SDI output 4 CH15 and CH13 1 = off 2 = on
I44sdi4AudioGroup4Ch15Frequency {I44sdi4AudioGroup4Ch15TBL.2}	R/W	Integer	SDI output 4 CH15 frequency 1 = silence 2 = freq400Hz 3 = freq800Hz 4 = freq1000Hz

OID	Access	Syntax	Description
I44sdi4AudioGroup4Ch15Level {I44sdi4AudioGroup4Ch15TBL.3}	R/W	Integer	SDI output 4 CH15 level 0 - -60
I44sdi4AudioGroup4Ch15Click {I44sdi4AudioGroup4Ch15TBL.4}	R/W	Integer	SDI output 4 CH15 click insertion interval 1 = off 2 = click1sec 3 = click2sec 4 = click4sec
I44sdi4AudioGroup4Ch16TBL {I44sdi4AudioGroup4TBL.6}	-	Aggregate	-
I44sdi4AudioGroup4Ch16EqualToCh13 {I44sdi4AudioGroup4Ch16TBL.1}	R/W	Integer	Setting shared by SDI output 4 CH16 and CH13 1 = off 2 = on
I44sdi4AudioGroup4Ch16Frequency {I44sdi4AudioGroup4Ch16TBL.2}	R/W	Integer	SDI output 4 CH16 frequency 1 = silence 2 = freq400Hz 3 = freq800Hz 4 = freq1000Hz
I44sdi4AudioGroup4Ch16Level {I44sdi4AudioGroup4Ch16TBL.3}	R/W	Integer	SDI output 4 CH16 level 0 - -60
I44sdi4AudioGroup4Ch16Click {I44sdi4AudioGroup4Ch16TBL.4}	R/W	Integer	SDI output 4 CH16 click insertion interval 1 = off 2 = click1sec 3 = click2sec 4 = click4sec
I44sdi4AudioGroup4Resolution {I44sdi4AudioGroup4TBL.7}	R/W	Integer	SDI output 4 audio group 4 resolution 1 = resolution20bit 2 = resolution24bit
I44sdi4AudioGroup4Emphasis {I44sdi4AudioGroup4TBL.8}	R/W	Integer	SDI output 4 audio group 4 pre-emphasis mode 1 = emphasis50-15 2 = ccittl 3 = off
I44sdi4AncTBL {I44sdi4TBL.7}	-	Aggregate	-
I44sdi4AtcLtc {I44sdi4AncTBL.1}	R/W	Integer	Insertion of LTC into SDI output 4 1 = off 2 = on
I44sdi4AtcVitc {I44sdi4AncTBL.2}	R/W	Integer	Insertion of VITC into SDI output 4 1 = off 2 = on
I44sdi4AtcDropFrame {I44sdi4AncTBL.3}	R/W	Integer	SDI output 4 dropped frame 1 = off 2 = on
I44sdi4OutputTBL {I44sdi4TBL.8}	-	Aggregate	-
I44sdi4Output {I44sdi4OutputTBL.1}	R/W	Integer	SDI output 4 1 = enable

OID	Access	Syntax	Description
			2 = disable
I44sdi4OutputLinktoPtp1Bmca {I44sdi4OutputTBL.2}	R/W	Integer	SDI output 4 BMCA linking (PTP1) 1 = enable 2 = disable
I44sdi4OutputLinktoPtp2Bmca {I44sdi4OutputTBL.3}	R/W	Integer	SDI output 4 BMCA linking (PTP2) 1 = enable 2 = disable
I44sdiFrequencyGroup {I44670ser02.5}	R/W	Integer	Frequency group 1 = freq60-50Hz 2 = freq59p94Hz

17.4.11 I44670ser03 Group

Table 17-12 | I44670ser03 group

OID	Access	Syntax	Description
I44ptp1TBL {I44670ser03.1}	-	Aggregate	-
I44ptp1Mode {I44ptp1TBL.1}	R/W	Integer	PTP1 mode 1 = enable-leader 2 = disable-leader 3 = follower
I44ptp1Bmca {I44ptp1TBL.2}	R/W	Integer	BMCA of PTP1 1 = enable 2 = enable-only-once 3 = disable
I44ptp1PriorityRecovery {I44ptp1TBL.3}	W/O	Integer	PTP1 priority 1 recovery 1 = Fixed
I44ptp1ProfileType {I44ptp1TBL.4}	R/W	Integer	PTP1 profile 1 = st2059 2 = aes67 3 = general
I44ptp1DetailSettingTBL {I44ptp1TBL.5}	-	Aggregate	-
I44ptp1ProfileSetDefault {I44ptp1DetailSettingTBL.1}	W/O	Integer	PTP1 profile initialization 1 = Fixed
I44ptp1Domain {I44ptp1DetailSettingTBL.2}	R/W	Integer	PTP1 domain number 0 - 255
I44ptp1CommunicationMode {I44ptp1DetailSettingTBL.3}	R/W	Integer	PTP1 communication mode 1 = mixed-smpte 2 = mixed-smpte-wo-ne 3 = unicast 4 = multicast
I44ptp1AnnounceInterval {I44ptp1DetailSettingTBL.4}	R/W	Integer	PTP1 announce message transmission interval 1 = f0p125s-8Hz 2 = f0p25s-4Hz 3 = f0p5s-2Hz

OID	Access	Syntax	Description
			4 = f1s-1Hz 5 = f2s-0p5Hz 6 = f4s-0p25Hz 7 = f8s-0p125Hz 8 = f16s-0p0625Hz
I44ptp1SyncInterval {I44ptp1DetailSettingTBL.5}	R/W	Integer	PTP1 sync message transmission interval 1 = f0p0078s-128Hz 2 = f0p015s-64Hz 3 = f0p0312s-32Hz 4 = f0p0625s-16Hz 5 = f0p125s-8Hz 6 = f0p25s-4Hz 7 = f0p5s-2Hz 8 = f1s-1Hz 9 = f2s-0p5Hz 10 = f4s-0p25Hz 11 = f8s-0p125Hz 12 = f16s-0p0625Hz
I44ptp1Priority1 {I44ptp1DetailSettingTBL.6}	R/W	Integer	PTP1 priority 1 0 - 255
I44ptp1Priority2 {I44ptp1DetailSettingTBL.7}	R/W	Integer	PTP1 priority 2 0 - 255
I44ptp1Step {I44ptp1DetailSettingTBL.8}	R/W	Integer	PTP1 step 1 = one-step 2 = two-step
I44ptp1DefaultFrame {I44ptp1DetailSettingTBL.9}	R/W	Integer	PTP1 default frame 2 = f23p98 3 = f24 4 = f25 5 = f29p97 6 = f30 7 = f47p95 8 = f48 9 = f50 10 = f59p94 11 = f60 12 = f71p92 13 = f72 14 = f100 15 = f119p9 16 = f120
I44ptp1DropFrame {I44ptp1DetailSettingTBL.10}	R/W	Integer	PTP1 dropped frame 1 = enable 2 = disable
I44ptp1ColorFrame {I44ptp1DetailSettingTBL.11}	R/W	Integer	PTP1 color frame ID 1 = enable

OID	Access	Syntax	Description
			2 = disable
I44ptp1AnnounceTimeout {I44ptp1DetailSettingTBL.12}	R/W	Integer	Number of announce messages used to judge whether a PTP1 timeout occurs 2 - 10
I44ptp1DelayMechanism {I44ptp1DetailSettingTBL.13}	R/W	Integer	PTP1 propagation time measurement method 1 = end-to-end 2 = peer-to-peer
I44ptp1AmtrationTBL {I44ptp1DetailSettingTBL.14}	-	Aggregate	-
I44ptp1AmtrationIP1 {I44ptp1AmtrationTBL.1}	R/W	IpAddress	IP address of leader 1 to which PTP1 is to connect xxx.xxx.xxx.xxx
I44ptp1AmtrationIP2 {I44ptp1AmtrationTBL.2}	R/W	IpAddress	IP address of leader 2 to which PTP1 is to connect xxx.xxx.xxx.xxx
I44ptp1AmtrationIP3 {I44ptp1AmtrationTBL.3}	R/W	IpAddress	IP address of leader 3 to which PTP1 is to connect xxx.xxx.xxx.xxx
I44ptp1AmtrationIP4 {I44ptp1AmtrationTBL.4}	R/W	IpAddress	IP address of leader 4 to which PTP1 is to connect xxx.xxx.xxx.xxx
I44ptp1AmtrationIP5 {I44ptp1AmtrationTBL.5}	R/W	IpAddress	IP address of leader 5 to which PTP1 is to connect xxx.xxx.xxx.xxx
I44ptp1AmtrationIP6 {I44ptp1AmtrationTBL.6}	R/W	IpAddress	IP address of leader 6 to which PTP1 is to connect xxx.xxx.xxx.xxx
I44ptp1AmtrationIP7 {I44ptp1AmtrationTBL.7}	R/W	IpAddress	IP address of leader 7 to which PTP1 is to connect xxx.xxx.xxx.xxx
I44ptp1AmtrationIP8 {I44ptp1AmtrationTBL.8}	R/W	IpAddress	IP address of leader 8 to which PTP1 is to connect xxx.xxx.xxx.xxx
I44ptp1AsymmetricDelay {I44ptp1DetailSettingTBL.15}	R/W	Integer	PTP1 phase correction amount ±20.000(±20000)
I44ptp1DelayMsgInterval {I44ptp1DetailSettingTBL.16}	R/W	Integer	PTP1 delay message transmission interval 1 = f0p0078s-128Hz 2 = f0p015s-64Hz 3 = f0p0312s-32Hz 4 = f0p0625s-16Hz 5 = f0p125s-8Hz 6 = f0p25s-4Hz 7 = f0p5s-2Hz 8 = f1s-1Hz 9 = f2s-0p5Hz 10 = f4s-0p25Hz

OID	Access	Syntax	Description
			11 = f8s-0p125Hz 12 = f16s-0p0625Hz
I44ptp1AnnounceDesirInt {I44ptp1DetailSettingTBL.17}	R/W	Integer	PTP1-desired announce message transmission interval 1 = f0p125s-8Hz 2 = f0p25s-4Hz 3 = f0p5s-2Hz 4 = f1s-1Hz 5 = f2s-0p5Hz 6 = f4s-0p25Hz 7 = f8s-0p125Hz 8 = f16s-0p0625Hz
I44ptp1AnnounceReqdInt {I44ptp1DetailSettingTBL.18}	R/W	Integer	PTP1 announce message reception interval 1 = f0p125s-8Hz 2 = f0p25s-4Hz 3 = f0p5s-2Hz 4 = f1s-1Hz 5 = f2s-0p5Hz 6 = f4s-0p25Hz 7 = f8s-0p125Hz 8 = f16s-0p0625Hz
I44ptp1SyncDesirInt {I44ptp1DetailSettingTBL.19}	R/W	Integer	PTP1-desired sync message transmission interval 1 = f0p0078s-128Hz 2 = f0p015s-64Hz 3 = f0p0312s-32Hz 4 = f0p0625s-16Hz 5 = f0p125s-8Hz 6 = f0p25s-4Hz 7 = f0p5s-2Hz 8 = f1s-1Hz 9 = f2s-0p5Hz 10 = f4s-0p25Hz 11 = f8s-0p125Hz
I44ptp1SyncReqdInt {I44ptp1DetailSettingTBL.20}	R/W	Integer	PTP1 sync message reception interval 1 = f0p0078s-128Hz 2 = f0p015s-64Hz 3 = f0p0312s-32Hz 4 = f0p0625s-16Hz 5 = f0p125s-8Hz 6 = f0p25s-4Hz 7 = f0p5s-2Hz 8 = f1s-1Hz 9 = f2s-0p5Hz 10 = f4s-0p25Hz 11 = f8s-0p125Hz

OID	Access	Syntax	Description
I44ptp1DlyMsgDesirInt {I44ptp1DetailSettingTBL.21}	R/W	Integer	PTP1-desired delay message transmission interval 1 = f0p0078s-128Hz 2 = f0p015s-64Hz 3 = f0p0312s-32Hz 4 = f0p0625s-16Hz 5 = f0p125s-8Hz 6 = f0p25s-4Hz 7 = f0p5s-2Hz 8 = f1s-1Hz 9 = f2s-0p5Hz 10 = f4s-0p25Hz 11 = f8s-0p125Hz 12 = f16s-0p0625Hz
I44ptp1DlyMsgReqdInt {I44ptp1DetailSettingTBL.22}	R/W	Integer	PTP1 delay message reception interval 1 = f0p0078s-128Hz 2 = f0p015s-64Hz 3 = f0p0312s-32Hz 4 = f0p0625s-16Hz 5 = f0p125s-8Hz 6 = f0p25s-4Hz 7 = f0p5s-2Hz 8 = f1s-1Hz 9 = f2s-0p5Hz 10 = f4s-0p25Hz 11 = f8s-0p125Hz 12 = f16s-0p0625Hz
I44ptp2TBL {I44ptp2TBL.1}	-	Aggregate	-
I44ptp2Mode {I44ptp2TBL.1}	R/W	Integer	PTP2 mode 1 = enable-leader 2 = disable-leader 3 = follower
I44ptp2Bmca {I44ptp2TBL.2}	R/W	Integer	BMCA of PTP2 1 = enable 2 = enable-only-once 3 = disable
I44ptp2PriorityRecovery {I44ptp2TBL.3}	W/O	Integer	PTP2 priority 1 recovery 1 = Fixed
I44ptp2ProfileType {I44ptp2TBL.4}	R/W	Integer	PTP2 profile 1 = st2059 2 = aes67 3 = general
I44ptp2DetailSettingTBL {I44ptp2TBL.5}	-	Aggregate	-
I44ptp2ProfileSetDefault	W/O	Integer	PTP2 profile initialization

OID	Access	Syntax	Description
{I44ptp2DetailSettingTBL.1}			1 = Fixed
I44ptp2Domain {I44ptp2DetailSettingTBL.2}	R/W	Integer	PTP2 domain number 0 - 255
I44ptp2CommunicationMode {I44ptp2DetailSettingTBL.3}	R/W	Integer	PTP2 communication mode 1 = mixed-smpte 2 = mixed-smpte-wo-ne 3 = unicast 4 = multicast
I44ptp2AnnounceInterval {I44ptp2DetailSettingTBL.4}	R/W	Integer	PTP2 announce message transmission interval 1 = f0p125s-8Hz 2 = f0p25s-4Hz 3 = f0p5s-2Hz 4 = f1s-1Hz 5 = f2s-0p5Hz 6 = f4s-0p25Hz 7 = f8s-0p125Hz 8 = f16s-0p0625Hz
I44ptp2SyncInterval {I44ptp2DetailSettingTBL.5}	R/W	Integer	PTP2 sync message transmission interval 1 = f0p0078s-128Hz 2 = f0p015s-64Hz 3 = f0p0312s-32Hz 4 = f0p0625s-16Hz 5 = f0p125s-8Hz 6 = f0p25s-4Hz 7 = f0p5s-2Hz 8 = f1s-1Hz 9 = f2s-0p5Hz 10 = f4s-0p25Hz 11 = f8s-0p125Hz 12 = f16s-0p0625Hz
I44ptp2Priority1 {I44ptp2DetailSettingTBL.6}	R/W	Integer	PTP2 priority 1 0 - 255
I44ptp2Priority2 {I44ptp2DetailSettingTBL.7}	R/W	Integer	PTP2 priority 2 0 - 255
I44ptp2Step {I44ptp2DetailSettingTBL.8}	R/W	Integer	PTP2 step 1 = one-step 2 = two-step
I44ptp2DefaultFrame {I44ptp2DetailSettingTBL.9}	R/W	Integer	PTP2 default frame 2 = f23p98 3 = f24 4 = f25 5 = f29p97 6 = f30 7 = f47p95 8 = f48 9 = f50

OID	Access	Syntax	Description
			10 = f59p94 11 = f60 12 = f71p92 13 = f72 14 = f100 15 = f119p9 16 = f120
I44ptp2DropFrame {I44ptp2DetailSettingTBL.10}	R/W	Integer	PTP2 dropped frame 1 = enable 2 = disable
I44ptp2ColorFrame {I44ptp2DetailSettingTBL.11}	R/W	Integer	PTP2 color frame ID 1 = enable 2 = disable
I44ptp2AnnounceTimeout {I44ptp2DetailSettingTBL.12}	R/W	Integer	Number of announce messages used to judge whether a PTP2 timeout occurs 2 - 10
I44ptp2DelayMechanism {I44ptp2DetailSettingTBL.13}	R/W	Integer	PTP2 propagation time measurement method 1 = end-to-end 2 = peer-to-peer
I44ptp2AmtrationTBL {I44ptp2DetailSettingTBL.14}	-	Aggregate	-
I44ptp2AmtrationIP1 {I44ptp2AmtrationTBL.1}	R/W	IpAddress	IP address of leader 1 to which PTP2 is to connect xxx.xxx.xxx.xxx
I44ptp2AmtrationIP2 {I44ptp2AmtrationTBL.2}	R/W	IpAddress	IP address of leader 2 to which PTP2 is to connect xxx.xxx.xxx.xxx
I44ptp2AmtrationIP3 {I44ptp2AmtrationTBL.3}	R/W	IpAddress	IP address of leader 3 to which PTP2 is to connect xxx.xxx.xxx.xxx
I44ptp2AmtrationIP4 {I44ptp2AmtrationTBL.4}	R/W	IpAddress	IP address of leader 4 to which PTP2 is to connect xxx.xxx.xxx.xxx
I44ptp2AmtrationIP5 {I44ptp2AmtrationTBL.5}	R/W	IpAddress	IP address of leader 5 to which PTP2 is to connect xxx.xxx.xxx.xxx
I44ptp2AmtrationIP6 {I44ptp2AmtrationTBL.6}	R/W	IpAddress	IP address of leader 6 to which PTP2 is to connect xxx.xxx.xxx.xxx
I44ptp2AmtrationIP7 {I44ptp2AmtrationTBL.7}	R/W	IpAddress	IP address of leader 7 to which PTP2 is to connect xxx.xxx.xxx.xxx
I44ptp2AmtrationIP8 {I44ptp2AmtrationTBL.8}	R/W	IpAddress	IP address of leader 8 to which PTP2 is to connect xxx.xxx.xxx.xxx
I44ptp2AsymmetricDelay	R/W	Integer	PTP2 phase correction amount

OID	Access	Syntax	Description
{I44ptp2DetailSettingTBL.15}			±20.000(±20000)
I44ptp2DelayMsgInterval {I44ptp2DetailSettingTBL.16}	R/W	Integer	PTP2 delay message transmission interval 1 = f0p0078s-128Hz 2 = f0p015s-64Hz 3 = f0p0312s-32Hz 4 = f0p0625s-16Hz 5 = f0p125s-8Hz 6 = f0p25s-4Hz 7 = f0p5s-2Hz 8 = f1s-1Hz 9 = f2s-0p5Hz 10 = f4s-0p25Hz 11 = f8s-0p125Hz 12 = f16s-0p0625Hz
I44ptp2AnnounceDesirInt {I44ptp2DetailSettingTBL.17}	R/W	Integer	PTP2-desired announce message transmission interval 1 = f0p125s-8Hz 2 = f0p25s-4Hz 3 = f0p5s-2Hz 4 = f1s-1Hz 5 = f2s-0p5Hz 6 = f4s-0p25Hz 7 = f8s-0p125Hz 8 = f16s-0p0625Hz
I44ptp2AnnounceReqdInt {I44ptp2DetailSettingTBL.18}	R/W	Integer	PTP2 announce message reception interval 1 = f0p125s-8Hz 2 = f0p25s-4Hz 3 = f0p5s-2Hz 4 = f1s-1Hz 5 = f2s-0p5Hz 6 = f4s-0p25Hz 7 = f8s-0p125Hz 8 = f16s-0p0625Hz
I44ptp2SyncDesirInt {I44ptp2DetailSettingTBL.19}	R/W	Integer	PTP2-desired sync message transmission interval 1 = f0p0078s-128Hz 2 = f0p015s-64Hz 3 = f0p0312s-32Hz 4 = f0p0625s-16Hz 5 = f0p125s-8Hz 6 = f0p25s-4Hz 7 = f0p5s-2Hz 8 = f1s-1Hz 9 = f2s-0p5Hz 10 = f4s-0p25Hz 11 = f8s-0p125Hz

OID	Access	Syntax	Description
I44ptp2SyncReqdInt {I44ptp2DetailSettingTBL.20}	R/W	Integer	PTP2 sync message reception interval 1 = f0p0078s-128Hz 2 = f0p015s-64Hz 3 = f0p0312s-32Hz 4 = f0p0625s-16Hz 5 = f0p125s-8Hz 6 = f0p25s-4Hz 7 = f0p5s-2Hz 8 = f1s-1Hz 9 = f2s-0p5Hz 10 = f4s-0p25Hz 11 = f8s-0p125Hz
I44ptp2DlyMsgDesirInt {I44ptp2DetailSettingTBL.21}	R/W	Integer	PTP2-desired delay message transmission interval 1 = f0p0078s-128Hz 2 = f0p015s-64Hz 3 = f0p0312s-32Hz 4 = f0p0625s-16Hz 5 = f0p125s-8Hz 6 = f0p25s-4Hz 7 = f0p5s-2Hz 8 = f1s-1Hz 9 = f2s-0p5Hz 10 = f4s-0p25Hz 11 = f8s-0p125Hz 12 = f16s-0p0625Hz
I44ptp2DlyMsgReqdInt {I44ptp2DetailSettingTBL.22}	R/W	Integer	PTP2 delay message reception interval 1 = f0p0078s-128Hz 2 = f0p015s-64Hz 3 = f0p0312s-32Hz 4 = f0p0625s-16Hz 5 = f0p125s-8Hz 6 = f0p25s-4Hz 7 = f0p5s-2Hz 8 = f1s-1Hz 9 = f2s-0p5Hz 10 = f4s-0p25Hz 11 = f8s-0p125Hz 12 = f16s-0p0625Hz

17.4.12 It4670ser04 Group

Table 17-13 | It4670ser04 group

OID	Access	Syntax	Description
I44ipTBL {It4670ser04.1}	-	Aggregate	-

OID	Access	Syntax	Description
I44ipType {I44ipTBL.1}	R/W	Integer	IP output standard 1 = st2022-6 2 = st2110
I44ip1ConfigTBL {I44ipTBL.3}	-	Aggregate	-
I44ip1Output {I44ip1ConfigTBL.1}	R/W	Integer	IP output 1 1 = off 2 = on
I44ip1StreamTBL {I44ip1ConfigTBL.3}	-	Aggregate	-
I44ip1Stream1TBL {I44ip1StreamTBL.1}	-	Aggregate	-
I44ip1Stream1VideoTBL {I44ip1Stream1TBL.1}	-	Aggregate	-
I44ip1Stream1VideoPayload {I44ip1Stream1VideoTBL.1}	R/W	Integer	IP output 1/stream 1/video payload type 96 - 127
I44ip1Stream1VideoVlanEnable {I44ip1Stream1VideoTBL.2}	R/W	Integer	IP output 1/stream 1/video VLAN setting 1 = off 2 = on
I44ip1Stream1VideoVlanTag {I44ip1Stream1VideoTBL.3}	R/W	Integer	IP output 1/stream 1/video VLAN tag 1 - 4096
I44ip1Stream1VideoDscpEnable {I44ip1Stream1VideoTBL.4}	R/W	Integer	IP output 1/stream 1/video DSCP setting 1 = off 2 = on
I44ip1Stream1VideoDscpTag {I44ip1Stream1VideoTBL.5}	R/W	Integer	IP output 1/stream 1/video DSCP tag 0 - 63
I44ip1Stream1VideoDestAddress {I44ip1Stream1VideoTBL.6}	R/O	IpAddress	IP output 1/stream 1/video destination IP address xxx.xxx.xxx.xxx
I44ip1Stream1VideoDestPort {I44ip1Stream1VideoTBL.7}	R/W	Integer	IP output 1/stream 1/video destination port number 0 - 65535
I44ip1Stream1VideoSdi {I44ip1Stream1VideoTBL.8}	R/W	Integer	IP output 1/stream 1/video 1 = off 2 = on
I44ip1Stream1AudioTBL {I44ip1Stream1TBL.2}	-	Aggregate	-
I44ip1Stream1AudioPayload {I44ip1Stream1AudioTBL.1}	R/W	Integer	IP output 1/stream 1/audio payload type 96 - 127
I44ip1Stream1AudioVlanEnable {I44ip1Stream1AudioTBL.2}	R/W	Integer	IP output 1/stream 1/audio VLAN setting 1 = off 2 = on
I44ip1Stream1AudioVlanTag {I44ip1Stream1AudioTBL.3}	R/W	Integer	IP output 1/stream 1/audio VLAN tag 1 - 4096
I44ip1Stream1AudioDscpEnable {I44ip1Stream1AudioTBL.4}	R/W	Integer	IP output 1/stream 1/audio DSCP setting 1 = off

OID	Access	Syntax	Description
			2 = on
I44ip1Stream1AudioDscpTag {I44ip1Stream1AudioTBL.5}	R/W	Integer	IP output 1/stream 1/audio DSCP tag 0 - 63
I44ip1Stream1AudioMode {I44ip1Stream1AudioTBL.6}	R/W	Integer	IP output 1/stream 1/audio standard 1 = st2110-30 2 = st2110-31
I44ip1Stream1AudioPacketTime {I44ip1Stream1AudioTBL.7}	R/W	Integer	IP output 1/stream 1/audio packet time 1 = time-1ms 2 = time-125us
I44ip1Stream1AudioDestAddress {I44ip1Stream1AudioTBL.24}	R/O	IpAddress	IP output 1/stream 1/audio destination IP address xxx.xxx.xxx.xxx
I44ip1Stream1AudioDestPort {I44ip1Stream1AudioTBL.25}	R/W	Integer	IP output 1/stream 1/audio destination port number 0 - 65535
I44ip1Stream1AudioSdi {I44ip1Stream1AudioTBL.26}	R/W	Integer	IP output 1/stream 1/audio 1 = off 2 = on
I44ip1Stream1AncTBL {I44ip1Stream1TBL.3}	-	Aggregate	-
I44ip1Stream1AncPayload {I44ip1Stream1AncTBL.1}	R/W	Integer	IP output 1/stream 1/ANC payload type 96 - 127
I44ip1Stream1AncVlanEnable {I44ip1Stream1AncTBL.2}	R/W	Integer	IP output 1/stream 1/ANC VLAN setting 1 = off 2 = on
I44ip1Stream1AncVlanTag {I44ip1Stream1AncTBL.3}	R/W	Integer	IP output 1/stream 1/ANC VLAN tag 1 - 4096
I44ip1Stream1AncDscpEnable {I44ip1Stream1AncTBL.4}	R/W	Integer	IP output 1/stream 1/ANC DSCP setting 1 = off 2 = on
I44ip1Stream1AncDscpTag {I44ip1Stream1AncTBL.5}	R/W	Integer	IP output 1/stream 1/ANC DSCP tag 0 - 63
I44ip1Stream1AncDestAddress {I44ip1Stream1AncTBL.6}	R/O	IpAddress	IP output 1/stream 1/ANC destination IP address xxx.xxx.xxx.xxx
I44ip1Stream1AncDestPort {I44ip1Stream1AncTBL.7}	R/W	Integer	IP output 1/stream 1/ANC destination port number 0 - 65535
I44ip1Stream1AncSdi {I44ip1Stream1AncTBL.8}	R/W	Integer	IP output 1/stream 1/ANC 1 = off 2 = on
I44ip1Stream2TBL {I44ip1StreamTBL.2}	-	Aggregate	-
I44ip1Stream2VideoTBL {I44ip1Stream2TBL.1}	-	Aggregate	-
I44ip1Stream2VideoPayload	R/W	Integer	IP output 1/stream 2/video payload type

OID	Access	Syntax	Description
{I44ip1Stream2VideoTBL.1}			96 - 127
I44ip1Stream2VideoVlanEnable {I44ip1Stream2VideoTBL.2}	R/W	Integer	IP output 1/stream 2/video VLAN setting 1 = off 2 = on
I44ip1Stream2VideoVlanTag {I44ip1Stream2VideoTBL.3}	R/W	Integer	IP output 1/stream 2/video VLAN tag 1 - 4096
I44ip1Stream2VideoDscpEnable {I44ip1Stream2VideoTBL.4}	R/W	Integer	IP output 1/stream 2/video DSCP setting 1 = off 2 = on
I44ip1Stream2VideoDscpTag {I44ip1Stream2VideoTBL.5}	R/W	Integer	IP output 1/stream 2/video DSCP tag 0 - 63
I44ip1Stream2VideoDestAddress {I44ip1Stream2VideoTBL.6}	R/O	IpAddress	IP output 1/stream 2/video destination IP address xxx.xxx.xxx.xxx
I44ip1Stream2VideoDestPort {I44ip1Stream2VideoTBL.7}	R/W	Integer	IP output 1/stream 2/video destination port number 0 - 65535
I44ip1Stream2VideoSdi {I44ip1Stream2VideoTBL.8}	R/W	Integer	IP output 1/stream 2/video 1 = off 2 = on
I44ip1Stream2AudioTBL {I44ip1Stream2TBL.2}	-	Aggregate	-
I44ip1Stream2AudioPayload {I44ip1Stream2AudioTBL.1}	R/W	Integer	IP output 1/stream 2/audio payload type 96 - 127
I44ip1Stream2AudioVlanEnable {I44ip1Stream2AudioTBL.2}	R/W	Integer	IP output 1/stream 2/audio VLAN setting 1 = off 2 = on
I44ip1Stream2AudioVlanTag {I44ip1Stream2AudioTBL.3}	R/W	Integer	IP output 1/stream 2/audio VLAN tag 1 - 4096
I44ip1Stream2AudioDscpEnable {I44ip1Stream2AudioTBL.4}	R/W	Integer	IP output 1/stream 2/audio DSCP setting 1 = off 2 = on
I44ip1Stream2AudioDscpTag {I44ip1Stream2AudioTBL.5}	R/W	Integer	IP output 1/stream 2/audio DSCP tag 0 - 63
I44ip1Stream2AudioMode {I44ip1Stream2AudioTBL.6}	R/W	Integer	IP output 1/stream 2/audio standard 1 = st2110-30 2 = st2110-31
I44ip1Stream2AudioPacketTime {I44ip1Stream2AudioTBL.7}	R/W	Integer	IP output 1/stream 2/audio packet time 1 = time-1ms 2 = time-125us
I44ip1Stream2AudioDestAddress {I44ip1Stream2AudioTBL.24}	R/O	IpAddress	IP output 1/stream 2/audio destination IP address xxx.xxx.xxx.xxx
I44ip1Stream2AudioDestPort {I44ip1Stream2AudioTBL.25}	R/W	Integer	IP output 1/stream 2/audio destination port number 0 - 65535

OID	Access	Syntax	Description
I44ip1Stream2AudioSdi {I44ip1Stream2AudioTBL.26}	R/W	Integer	IP output 1/stream 2/audio 1 = off 2 = on
I44ip1Stream2AncTBL {I44ip1Stream2TBL.3}	-	Aggregate	-
I44ip1Stream2AncPayload {I44ip1Stream2AncTBL.1}	R/W	Integer	IP output 1/stream 2/ANC payload type 96 - 127
I44ip1Stream2AncVlanEnable {I44ip1Stream2AncTBL.2}	R/W	Integer	IP output 1/stream 2/ANC VLAN setting 1 = off 2 = on
I44ip1Stream2AncVlanTag {I44ip1Stream2AncTBL.3}	R/W	Integer	IP output 1/stream 2/ANC VLAN tag 1 - 4096
I44ip1Stream2AncDscpEnable {I44ip1Stream2AncTBL.4}	R/W	Integer	IP output 1/stream 2/ANC DSCP setting 1 = off 2 = on
I44ip1Stream2AncDscpTag {I44ip1Stream2AncTBL.5}	R/W	Integer	IP output 1/stream 2/ANC DSCP tag 0 - 63
I44ip1Stream2AncDestAddress {I44ip1Stream2AncTBL.6}	R/O	IpAddress	IP output 1/stream 2/ANC destination IP address xxx.xxx.xxx.xxx
I44ip1Stream2AncDestPort {I44ip1Stream2AncTBL.7}	R/W	Integer	IP output 1/stream 2/ANC destination port number 0 - 65535
I44ip1Stream2AncSdi {I44ip1Stream2AncTBL.8}	R/W	Integer	IP output 1/stream 2/ANC 1 = off 2 = on
I44ip1Stream3TBL {I44ip1StreamTBL.1}	-	Aggregate	-
I44ip1Stream3VideoTBL {I44ip1Stream3TBL.1}	-	Aggregate	-
I44ip1Stream3VideoPayload {I44ip1Stream3VideoTBL.1}	R/W	Integer	IP output 1/stream 3/video payload type 96 - 127
I44ip1Stream3VideoVlanEnable {I44ip1Stream3VideoTBL.2}	R/W	Integer	IP output 1/stream 3/video VLAN setting 1 = off 2 = on
I44ip1Stream3VideoVlanTag {I44ip1Stream3VideoTBL.3}	R/W	Integer	IP output 1/stream 3/video VLAN tag 1 - 4096
I44ip1Stream3VideoDscpEnable {I44ip1Stream3VideoTBL.4}	R/W	Integer	IP output 1/stream 3/video DSCP setting 1 = off 2 = on
I44ip1Stream3VideoDscpTag {I44ip1Stream3VideoTBL.5}	R/W	Integer	IP output 1/stream 3/video DSCP tag 0 - 63
I44ip1Stream3VideoDestAddress {I44ip1Stream3VideoTBL.6}	R/O	IpAddress	IP output 1/stream 3/video destination IP address xxx.xxx.xxx.xxx
I44ip1Stream3VideoDestPort	R/W	Integer	IP output 1/stream 3/video destination port

OID	Access	Syntax	Description
{I44ip1Stream3VideoTBL.7}			number 0 - 65535
I44ip1Stream3VideoSdi {I44ip1Stream3VideoTBL.8}	R/W	Integer	IP output 1/stream 3/video 1 = off 2 = on
I44ip1Stream3AudioTBL {I44ip1Stream3TBL.2}	-	Aggregate	-
I44ip1Stream3AudioPayload {I44ip1Stream3AudioTBL.1}	R/W	Integer	IP output 1/stream 3/audio payload type 96 - 127
I44ip1Stream3AudioVlanEnable {I44ip1Stream3AudioTBL.2}	R/W	Integer	IP output 1/stream 3/audio VLAN setting 1 = off 2 = on
I44ip1Stream3AudioVlanTag {I44ip1Stream3AudioTBL.3}	R/W	Integer	IP output 1/stream 3/audio VLAN tag 1 - 4096
I44ip1Stream3AudioDscpEnable {I44ip1Stream3AudioTBL.4}	R/W	Integer	IP output 1/stream 3/audio DSCP setting 1 = off 2 = on
I44ip1Stream3AudioDscpTag {I44ip1Stream3AudioTBL.5}	R/W	Integer	IP output 1/stream 3/audio DSCP tag 0 - 63
I44ip1Stream3AudioMode {I44ip1Stream3AudioTBL.6}	R/W	Integer	IP output 1/stream 3/audio standard 1 = st2110-30 2 = st2110-31
I44ip1Stream3AudioPacketTime {I44ip1Stream3AudioTBL.7}	R/W	Integer	IP output 1/stream 3/audio packet time 1 = time-1ms 2 = time-125us
I44ip1Stream3AudioDestAddress {I44ip1Stream3AudioTBL.24}	R/O	IpAddress	IP output 1/stream 3/audio destination IP address xxx.xxx.xxx.xxx
I44ip1Stream3AudioDestPort {I44ip1Stream3AudioTBL.25}	R/W	Integer	IP output 1/stream 3/audio destination port number 0 - 65535
I44ip1Stream3AudioSdi {I44ip1Stream3AudioTBL.26}	R/W	Integer	IP output 1/stream 3/audio 1 = off 2 = on
I44ip1Stream3AncTBL {I44ip1Stream3TBL.3}	-	Aggregate	-
I44ip1Stream3AncPayload {I44ip1Stream3AncTBL.1}	R/W	Integer	IP output 1/stream 3/ANC payload type 96 - 127
I44ip1Stream3AncVlanEnable {I44ip1Stream3AncTBL.2}	R/W	Integer	IP output 1/stream 3/ANC VLAN setting 1 = off 2 = on
I44ip1Stream3AncVlanTag {I44ip1Stream3AncTBL.3}	R/W	Integer	IP output 1/stream 3/ANC VLAN tag 1 - 4096
I44ip1Stream3AncDscpEnable {I44ip1Stream3AncTBL.4}	R/W	Integer	IP output 1/stream 3/ANC DSCP setting 1 = off 2 = on

OID	Access	Syntax	Description
I44ip1Stream3AncDscpTag {I44ip1Stream3AncTBL.5}	R/W	Integer	IP output 1/stream 3/ANC DSCP tag 0 - 63
I44ip1Stream3AncDestAddress {I44ip1Stream3AncTBL.6}	R/O	IpAddress	IP output 1/stream 3/ANC destination IP address xxx.xxx.xxx.xxx
I44ip1Stream3AncDestPort {I44ip1Stream3AncTBL.7}	R/W	Integer	IP output 1/stream 3/ANC destination port number 0 - 65535
I44ip1Stream3AncSdi {I44ip1Stream3AncTBL.8}	R/W	Integer	IP output 1/stream 3/ANC 1 = off 2 = on
I44ip1Stream4TBL {I44ip1StreamTBL.2}	-	Aggregate	-
I44ip1Stream4VideoTBL {I44ip1Stream4TBL.1}	-	Aggregate	-
I44ip1Stream4VideoPayload {I44ip1Stream4VideoTBL.1}	R/W	Integer	IP output 1/stream 4/video payload type 96 - 127
I44ip1Stream4VideoVlanEnable {I44ip1Stream4VideoTBL.2}	R/W	Integer	IP output 1/stream 4/video VLAN setting 1 = off 2 = on
I44ip1Stream4VideoVlanTag {I44ip1Stream4VideoTBL.3}	R/W	Integer	IP output 1/stream 4/video VLAN tag 1 - 4096
I44ip1Stream4VideoDscpEnable {I44ip1Stream4VideoTBL.4}	R/W	Integer	IP output 1/stream 4/video DSCP setting 1 = off 2 = on
I44ip1Stream4VideoDscpTag {I44ip1Stream4VideoTBL.5}	R/W	Integer	IP output 1/stream 4/video DSCP tag 0 - 63
I44ip1Stream4VideoDestAddress {I44ip1Stream4VideoTBL.6}	R/O	IpAddress	IP output 1/stream 4/video destination IP address xxx.xxx.xxx.xxx
I44ip1Stream4VideoDestPort {I44ip1Stream4VideoTBL.7}	R/W	Integer	IP output 1/stream 4/video destination port number 0 - 65535
I44ip1Stream4VideoSdi {I44ip1Stream4VideoTBL.8}	R/W	Integer	IP output 1/stream 4/video 1 = off 2 = on
I44ip1Stream4AudioTBL {I44ip1Stream4TBL.2}	-	Aggregate	-
I44ip1Stream4AudioPayload {I44ip1Stream4AudioTBL.1}	R/W	Integer	IP output 1/stream 4/audio payload type 96 - 127
I44ip1Stream4AudioVlanEnable {I44ip1Stream4AudioTBL.2}	R/W	Integer	IP output 1/stream 4/audio VLAN setting 1 = off 2 = on
I44ip1Stream4AudioVlanTag {I44ip1Stream4AudioTBL.3}	R/W	Integer	IP output 1/stream 4/audio VLAN tag 1 - 4096
I44ip1Stream4AudioDscpEnable	R/W	Integer	IP output 1/stream 4/audio DSCP setting

OID	Access	Syntax	Description
{I44ip1Stream4AudioTBL.4}			1 = off 2 = on
I44ip1Stream4AudioDscpTag {I44ip1Stream4AudioTBL.5}	R/W	Integer	IP output 1/stream 4/audio DSCP tag 0 - 63
I44ip1Stream4AudioMode {I44ip1Stream4AudioTBL.6}	R/W	Integer	IP output 1/stream 4/audio standard 1 = st2110-30 2 = st2110-31
I44ip1Stream4AudioPacketTime {I44ip1Stream4AudioTBL.7}	R/W	Integer	IP output 1/stream 4/audio packet time 1 = time-1ms 2 = time-125us
I44ip1Stream4AudioDestAddress {I44ip1Stream4AudioTBL.24}	R/O	IpAddress	IP output 1/stream 4/audio destination IP address xxx.xxx.xxx.xxx
I44ip1Stream4AudioDestPort {I44ip1Stream4AudioTBL.25}	R/W	Integer	IP output 1/stream 4/audio destination port number 0 - 65535
I44ip1Stream4AudioSdi {I44ip1Stream4AudioTBL.26}	R/W	Integer	IP output 1/stream 4/audio 1 = off 2 = on
I44ip1Stream4AncTBL {I44ip1Stream4TBL.3}	-	Aggregate	-
I44ip1Stream4AncPayload {I44ip1Stream4AncTBL.1}	R/W	Integer	IP output 1/stream 4/ANC payload type 96 - 127
I44ip1Stream4AncVlanEnable {I44ip1Stream4AncTBL.2}	R/W	Integer	IP output 1/stream 4/ANC VLAN setting 1 = off 2 = on
I44ip1Stream4AncVlanTag {I44ip1Stream4AncTBL.3}	R/W	Integer	IP output 1/stream 4/ANC VLAN tag 1 - 4096
I44ip1Stream4AncDscpEnable {I44ip1Stream4AncTBL.4}	R/W	Integer	IP output 1/stream 4/ANC DSCP setting 1 = off 2 = on
I44ip1Stream4AncDscpTag {I44ip1Stream4AncTBL.5}	R/W	Integer	IP output 1/stream 4/ANC DSCP tag 0 - 63
I44ip1Stream4AncDestAddress {I44ip1Stream4AncTBL.6}	R/O	IpAddress	IP output 1/stream 4/ANC destination IP address xxx.xxx.xxx.xxx
I44ip1Stream4AncDestPort {I44ip1Stream4AncTBL.7}	R/W	Integer	IP output 1/stream 4/ANC destination port number 0 - 65535
I44ip1Stream4AncSdi {I44ip1Stream4AncTBL.8}	R/W	Integer	IP output 1/stream 4/ANC 1 = off 2 = on
I44ip2ConfigTBL {I44ipTBL.4}	-	Aggregate	-
I44ip2Output {I44ip2ConfigTBL.1}	R/W	Integer	IP output 2 1 = off

OID	Access	Syntax	Description
			2 = on
I44ip2StreamTBL {I44ip2ConfigTBL.3}	-	Aggregate	-
I44ip2Stream1TBL {I44ip2StreamTBL.1}	-	Aggregate	-
I44ip2Stream1VideoTBL {I44ip2Stream1TBL.1}	-	Aggregate	-
I44ip2Stream1VideoPayload {I44ip2Stream1VideoTBL.1}	R/W	Integer	IP output 2/stream 1/video payload type 96 - 127
I44ip2Stream1VideoVlanEnable {I44ip2Stream1VideoTBL.2}	R/W	Integer	IP output 2/stream 1/video VLAN setting 1 = off 2 = on
I44ip2Stream1VideoVlanTag {I44ip2Stream1VideoTBL.3}	R/W	Integer	IP output 2/stream 1/video VLAN tag 1 - 4096
I44ip2Stream1VideoDscpEnable {I44ip2Stream1VideoTBL.4}	R/W	Integer	IP output 2/stream 1/video DSCP setting 1 = off 2 = on
I44ip2Stream1VideoDscpTag {I44ip2Stream1VideoTBL.5}	R/W	Integer	IP output 2/stream 1/video DSCP tag 0 - 63
I44ip2Stream1VideoDestAddress {I44ip2Stream1VideoTBL.6}	R/O	IpAddress	IP output 2/stream 1/video destination IP address xxx.xxx.xxx.xxx
I44ip2Stream1VideoDestPort {I44ip2Stream1VideoTBL.7}	R/W	Integer	IP output 2/stream 1/video destination port number 0 - 65535
I44ip2Stream1VideoSdi {I44ip2Stream1VideoTBL.8}	R/W	Integer	IP output 2/stream 1/video 1 = off 2 = on
I44ip2Stream1AudioTBL {I44ip2Stream1TBL.2}	-	Aggregate	-
I44ip2Stream1AudioPayload {I44ip2Stream1AudioTBL.1}	R/W	Integer	IP output 2/stream 1/audio payload type 96 - 127
I44ip2Stream1AudioVlanEnable {I44ip2Stream1AudioTBL.2}	R/W	Integer	IP output 2/stream 1/audio VLAN setting 1 = off 2 = on
I44ip2Stream1AudioVlanTag {I44ip2Stream1AudioTBL.3}	R/W	Integer	IP output 2/stream 1/audio VLAN tag 1 - 4096
I44ip2Stream1AudioDscpEnable {I44ip2Stream1AudioTBL.4}	R/W	Integer	IP output 2/stream 1/audio DSCP setting 1 = off 2 = on
I44ip2Stream1AudioDscpTag {I44ip2Stream1AudioTBL.5}	R/W	Integer	IP output 2/stream 1/audio DSCP tag 0 - 63
I44ip2Stream1AudioMode {I44ip2Stream1AudioTBL.6}	R/W	Integer	IP output 2/stream 1/audio standard 1 = st2110-30 2 = st2110-31
I44ip2Stream1AudioPacketTime	R/W	Integer	IP output 2/stream 1/audio packet time

OID	Access	Syntax	Description
{I44ip2Stream1AudioTBL.7}			1 = time-1ms 2 = time-125us
I44ip2Stream1AudioDestAddress {I44ip2Stream1AudioTBL.24}	R/O	IpAddress	IP output 2/stream 1/audio destination IP address xxx.xxx.xxx.xxx
I44ip2Stream1AudioDestPort {I44ip2Stream1AudioTBL.25}	R/W	Integer	IP output 2/stream 1/audio destination port number 0 - 65535
I44ip2Stream1AudioSdi {I44ip2Stream1AudioTBL.26}	R/W	Integer	IP output 2/stream 1/audio 1 = off 2 = on
I44ip2Stream1AncTBL {I44ip2Stream1TBL.3}	-	Aggregate	-
I44ip2Stream1AncPayload {I44ip2Stream1AncTBL.1}	R/W	Integer	IP output 2/stream 1/ANC payload type 96 - 127
I44ip2Stream1AncVlanEnable {I44ip2Stream1AncTBL.2}	R/W	Integer	IP output 2/stream 1/ANC VLAN setting 1 = off 2 = on
I44ip2Stream1AncVlanTag {I44ip2Stream1AncTBL.3}	R/W	Integer	IP output 2/stream 1/ANC VLAN tag 1 - 4096
I44ip2Stream1AncDscpEnable {I44ip2Stream1AncTBL.4}	R/W	Integer	IP output 2/stream 1/ANC DSCP setting 1 = off 2 = on
I44ip2Stream1AncDscpTag {I44ip2Stream1AncTBL.5}	R/W	Integer	IP output 2/stream 1/ANC DSCP tag 0 - 63
I44ip2Stream1AncDestAddress {I44ip2Stream1AncTBL.6}	R/O	IpAddress	IP output 2/stream 1/ANC destination IP address xxx.xxx.xxx.xxx
I44ip2Stream1AncDestPort {I44ip2Stream1AncTBL.7}	R/W	Integer	IP output 2/stream 1/ANC destination port number 0 - 65535
I44ip2Stream1AncSdi {I44ip2Stream1AncTBL.8}	R/W	Integer	IP output 2/stream 1/ANC 1 = off 2 = on
I44ip2Stream2TBL {I44ip2StreamTBL.2}	-	Aggregate	-
I44ip2Stream2VideoTBL {I44ip2Stream2TBL.1}	-	Aggregate	-
I44ip2Stream2VideoPayload {I44ip2Stream2VideoTBL.1}	R/W	Integer	IP output 2/stream 2/video payload type 96 - 127
I44ip2Stream2VideoVlanEnable {I44ip2Stream2VideoTBL.2}	R/W	Integer	IP output 2/stream 2/video VLAN setting 1 = off 2 = on
I44ip2Stream2VideoVlanTag {I44ip2Stream2VideoTBL.3}	R/W	Integer	IP output 2/stream 2/video VLAN tag 1 - 4096
I44ip2Stream2VideoDscpEnable	R/W	Integer	IP output 2/stream 2/video DSCP setting

OID	Access	Syntax	Description
{I44ip2Stream2VideoTBL.4}			1 = off 2 = on
I44ip2Stream2VideoDscpTag {I44ip2Stream2VideoTBL.5}	R/W	Integer	IP output 2/stream 2/video DSCP tag 0 - 63
I44ip2Stream2VideoDestAddress {I44ip2Stream2VideoTBL.6}	R/O	IpAddress	IP output 2/stream 2/video destination IP address xxx.xxx.xxx.xxx
I44ip2Stream2VideoDestPort {I44ip2Stream2VideoTBL.7}	R/W	Integer	IP output 2/stream 2/video destination port number 0 - 65535
I44ip2Stream2VideoSdi {I44ip2Stream2VideoTBL.8}	R/W	Integer	IP output 2/stream 2/video 1 = off 2 = on
I44ip2Stream2AudioTBL {I44ip2Stream2TBL.2}	-	Aggregate	-
I44ip2Stream2AudioPayload {I44ip2Stream2AudioTBL.1}	R/W	Integer	IP output 2/stream 2/audio payload type 96 - 127
I44ip2Stream2AudioVlanEnable {I44ip2Stream2AudioTBL.2}	R/W	Integer	IP output 2/stream 2/audio VLAN setting 1 = off 2 = on
I44ip2Stream2AudioVlanTag {I44ip2Stream2AudioTBL.3}	R/W	Integer	IP output 2/stream 2/audio VLAN tag 1 - 4096
I44ip2Stream2AudioDscpEnable {I44ip2Stream2AudioTBL.4}	R/W	Integer	IP output 2/stream 2/audio DSCP setting 1 = off 2 = on
I44ip2Stream2AudioDscpTag {I44ip2Stream2AudioTBL.5}	R/W	Integer	IP output 2/stream 2/audio DSCP tag 0 - 63
I44ip2Stream2AudioMode {I44ip2Stream2AudioTBL.6}	R/W	Integer	IP output 2/stream 2/audio standard 1 = st2110-30 2 = st2110-31
I44ip2Stream2AudioPacketTime {I44ip2Stream2AudioTBL.7}	R/W	Integer	IP output 2/stream 2/audio packet time 1 = time-1ms 2 = time-125us
I44ip2Stream2AudioDestAddress {I44ip2Stream2AudioTBL.24}	R/O	IpAddress	IP output 2/stream 2/audio destination IP address xxx.xxx.xxx.xxx
I44ip2Stream2AudioDestPort {I44ip2Stream2AudioTBL.25}	R/W	Integer	IP output 2/stream 2/audio destination port number 0 - 65535
I44ip2Stream2AudioSdi {I44ip2Stream2AudioTBL.26}	R/W	Integer	IP output 2/stream 2/audio 1 = off 2 = on
I44ip2Stream2AncTBL {I44ip2Stream2TBL.3}	-	Aggregate	-
I44ip2Stream2AncPayload {I44ip2Stream2AncTBL.1}	R/W	Integer	IP output 2/stream 2/ANC payload type 96 - 127

OID	Access	Syntax	Description
I44ip2Stream2AncVlanEnable {I44ip2Stream2AncTBL.2}	R/W	Integer	IP output 2/stream 2/ANC VLAN setting 1 = off 2 = on
I44ip2Stream2AncVlanTag {I44ip2Stream2AncTBL.3}	R/W	Integer	IP output 2/stream 2/ANC VLAN tag 1 - 4096
I44ip2Stream2AncDscpEnable {I44ip2Stream2AncTBL.4}	R/W	Integer	IP output 2/stream 2/ANC DSCP setting 1 = off 2 = on
I44ip2Stream2AncDscpTag {I44ip2Stream2AncTBL.5}	R/W	Integer	IP output 2/stream 2/ANC DSCP tag 0 - 63
I44ip2Stream2AncDestAddress {I44ip2Stream2AncTBL.6}	R/O	IpAddress	IP output 2/stream 2/ANC destination IP address xxx.xxx.xxx.xxx
I44ip2Stream2AncDestPort {I44ip2Stream2AncTBL.7}	R/W	Integer	IP output 2/stream 2/ANC destination port number 0 - 65535
I44ip2Stream2AncSdi {I44ip2Stream2AncTBL.8}	R/W	Integer	IP output 2/stream 2/ANC 1 = off 2 = on
I44ip2Stream3TBL {I44ip2StreamTBL.1}	-	Aggregate	-
I44ip2Stream3VideoTBL {I44ip2Stream3TBL.1}	-	Aggregate	-
I44ip2Stream3VideoPayload {I44ip2Stream3VideoTBL.1}	R/W	Integer	IP output 2/stream 3/video payload type 96 - 127
I44ip2Stream3VideoVlanEnable {I44ip2Stream3VideoTBL.2}	R/W	Integer	IP output 2/stream 3/video VLAN setting 1 = off 2 = on
I44ip2Stream3VideoVlanTag {I44ip2Stream3VideoTBL.3}	R/W	Integer	IP output 2/stream 3/video VLAN tag 1 - 4096
I44ip2Stream3VideoDscpEnable {I44ip2Stream3VideoTBL.4}	R/W	Integer	IP output 2/stream 3/video DSCP setting 1 = off 2 = on
I44ip2Stream3VideoDscpTag {I44ip2Stream3VideoTBL.5}	R/W	Integer	IP output 2/stream 3/video DSCP tag 0 - 63
I44ip2Stream3VideoDestAddress {I44ip2Stream3VideoTBL.6}	R/O	IpAddress	IP output 2/stream 3/video destination IP address xxx.xxx.xxx.xxx
I44ip2Stream3VideoDestPort {I44ip2Stream3VideoTBL.7}	R/W	Integer	IP output 2/stream 3/video destination port number 0 - 65535
I44ip2Stream3VideoSdi {I44ip2Stream3VideoTBL.8}	R/W	Integer	IP output 2/stream 3/video 1 = off 2 = on
I44ip2Stream3AudioTBL {I44ip2Stream3TBL.2}	-	Aggregate	-

OID	Access	Syntax	Description
I44ip2Stream3AudioPayload {I44ip2Stream3AudioTBL.1}	R/W	Integer	IP output 2/stream 3/audio payload type 96 - 127
I44ip2Stream3AudioVlanEnable {I44ip2Stream3AudioTBL.2}	R/W	Integer	IP output 2/stream 3/audio VLAN setting 1 = off 2 = on
I44ip2Stream3AudioVlanTag {I44ip2Stream3AudioTBL.3}	R/W	Integer	IP output 2/stream 3/audio VLAN tag 1 - 4096
I44ip2Stream3AudioDscpEnable {I44ip2Stream3AudioTBL.4}	R/W	Integer	IP output 2/stream 3/audio DSCP setting 1 = off 2 = on
I44ip2Stream3AudioDscpTag {I44ip2Stream3AudioTBL.5}	R/W	Integer	IP output 2/stream 3/audio DSCP tag 0 - 63
I44ip2Stream3AudioMode {I44ip2Stream3AudioTBL.6}	R/W	Integer	IP output 2/stream 3/audio standard 1 = st2110-30 2 = st2110-31
I44ip2Stream3AudioPacketTime {I44ip2Stream3AudioTBL.7}	R/W	Integer	IP output 2/stream 3/audio packet time 1 = time-1ms 2 = time-125us
I44ip2Stream3AudioDestAddress {I44ip2Stream3AudioTBL.24}	R/O	IpAddress	IP output 2/stream 3/audio destination IP address xxx.xxx.xxx.xxx
I44ip2Stream3AudioDestPort {I44ip2Stream3AudioTBL.25}	R/W	Integer	IP output 2/stream 3/audio destination port number 0 - 65535
I44ip2Stream3AudioSdi {I44ip2Stream3AudioTBL.26}	R/W	Integer	IP output 2/stream 3/audio 1 = off 2 = on
I44ip2Stream3AncTBL {I44ip2Stream3TBL.3}	-	Aggregate	-
I44ip2Stream3AncPayload {I44ip2Stream3AncTBL.1}	R/W	Integer	IP output 2/stream 3/ANC payload type 96 - 127
I44ip2Stream3AncVlanEnable {I44ip2Stream3AncTBL.2}	R/W	Integer	IP output 2/stream 3/ANC VLAN setting 1 = off 2 = on
I44ip2Stream3AncVlanTag {I44ip2Stream3AncTBL.3}	R/W	Integer	IP output 2/stream 3/ANC VLAN tag 1 - 4096
I44ip2Stream3AncDscpEnable {I44ip2Stream3AncTBL.4}	R/W	Integer	IP output 2/stream 3/ANC DSCP setting 1 = off 2 = on
I44ip2Stream3AncDscpTag {I44ip2Stream3AncTBL.5}	R/W	Integer	IP output 2/stream 3/ANC DSCP tag 0 - 63
I44ip2Stream3AncDestAddress {I44ip2Stream3AncTBL.6}	R/O	IpAddress	IP output 2/stream 3/ANC destination IP address xxx.xxx.xxx.xxx
I44ip2Stream3AncDestPort {I44ip2Stream3AncTBL.7}	R/W	Integer	IP output 2/stream 3/ANC destination port number

OID	Access	Syntax	Description
			0 - 65535
I44ip2Stream3AncSdi {I44ip2Stream3AncTBL.8}	R/W	Integer	IP output 2/stream 3/ANC 1 = off 2 = on
I44ip2Stream4TBL {I44ip2StreamTBL.2}	-	Aggregate	-
I44ip2Stream4VideoTBL {I44ip2Stream4TBL.1}	-	Aggregate	-
I44ip2Stream4VideoPayload {I44ip2Stream4VideoTBL.1}	R/W	Integer	IP output 2/stream 4/video payload type 96 - 127
I44ip2Stream4VideoVlanEnable {I44ip2Stream4VideoTBL.2}	R/W	Integer	IP output 2/stream 4/video VLAN setting 1 = off 2 = on
I44ip2Stream4VideoVlanTag {I44ip2Stream4VideoTBL.3}	R/W	Integer	IP output 2/stream 4/video VLAN tag 1 - 4096
I44ip2Stream4VideoDscpEnable {I44ip2Stream4VideoTBL.4}	R/W	Integer	IP output 2/stream 4/video DSCP setting 1 = off 2 = on
I44ip2Stream4VideoDscpTag {I44ip2Stream4VideoTBL.5}	R/W	Integer	IP output 2/stream 4/video DSCP tag 0 - 63
I44ip2Stream4VideoDestAddress {I44ip2Stream4VideoTBL.6}	R/O	IpAddress	IP output 2/stream 4/video destination IP address xxx.xxx.xxx.xxx
I44ip2Stream4VideoDestPort {I44ip2Stream4VideoTBL.7}	R/W	Integer	IP output 2/stream 4/video destination port number 0 - 65535
I44ip2Stream4VideoSdi {I44ip2Stream4VideoTBL.8}	R/W	Integer	IP output 2/stream 4/video 1 = off 2 = on
I44ip2Stream4AudioTBL {I44ip2Stream4TBL.2}	-	Aggregate	-
I44ip2Stream4AudioPayload {I44ip2Stream4AudioTBL.1}	R/W	Integer	IP output 2/stream 4/audio payload type 96 - 127
I44ip2Stream4AudioVlanEnable {I44ip2Stream4AudioTBL.2}	R/W	Integer	IP output 2/stream 4/audio VLAN setting 1 = off 2 = on
I44ip2Stream4AudioVlanTag {I44ip2Stream4AudioTBL.3}	R/W	Integer	IP output 2/stream 4/audio VLAN tag 1 - 4096
I44ip2Stream4AudioDscpEnable {I44ip2Stream4AudioTBL.4}	R/W	Integer	IP output 2/stream 4/audio DSCP setting 1 = off 2 = on
I44ip2Stream4AudioDscpTag {I44ip2Stream4AudioTBL.5}	R/W	Integer	IP output 2/stream 4/audio DSCP tag 0 - 63
I44ip2Stream4AudioMode {I44ip2Stream4AudioTBL.6}	R/W	Integer	IP output 2/stream 4/audio standard 1 = st2110-30 2 = st2110-31

OID	Access	Syntax	Description
I44ip2Stream4AudioPacketTime {I44ip2Stream4AudioTBL.7}	R/W	Integer	IP output 2/stream 4/audio packet time 1 = time-1ms 2 = time-125us
I44ip2Stream4AudioDestAddress {I44ip2Stream4AudioTBL.24}	R/O	IpAddress	IP output 2/stream 4/audio destination IP address xxx.xxx.xxx.xxx
I44ip2Stream4AudioDestPort {I44ip2Stream4AudioTBL.25}	R/W	Integer	IP output 2/stream 4/audio destination port number 0 - 65535
I44ip2Stream4AudioSdi {I44ip2Stream4AudioTBL.26}	R/W	Integer	IP output 2/stream 4/audio 1 = off 2 = on
I44ip2Stream4AncTBL {I44ip2Stream4TBL.3}	-	Aggregate	-
I44ip2Stream4AncPayload {I44ip2Stream4AncTBL.1}	R/W	Integer	IP output 2/stream 4/ANC payload type 96 - 127
I44ip2Stream4AncVlanEnable {I44ip2Stream4AncTBL.2}	R/W	Integer	IP output 2/stream 4/ANC VLAN setting 1 = off 2 = on
I44ip2Stream4AncVlanTag {I44ip2Stream4AncTBL.3}	R/W	Integer	IP output 2/stream 4/ANC VLAN tag 1 - 4096
I44ip2Stream4AncDscpEnable {I44ip2Stream4AncTBL.4}	R/W	Integer	IP output 2/stream 4/ANC DSCP setting 1 = off 2 = on
I44ip2Stream4AncDscpTag {I44ip2Stream4AncTBL.5}	R/W	Integer	IP output 2/stream 4/ANC DSCP tag 0 - 63
I44ip2Stream4AncDestAddress {I44ip2Stream4AncTBL.6}	R/O	IpAddress	IP output 2/stream 4/ANC destination IP address xxx.xxx.xxx.xxx
I44ip2Stream4AncDestPort {I44ip2Stream4AncTBL.7}	R/W	Integer	IP output 2/stream 4/ANC destination port number 0 - 65535
I44ip2Stream4AncSdi {I44ip2Stream4AncTBL.8}	R/W	Integer	IP output 2/stream 4/ANC 1 = off 2 = on

17.5 Extended Trap

index 1

OID: iso(1).org(3).dod(6).internet(1).mib-2(1).system(1).sysUpTime(1).0
 Syntax: TimeTicks
 Range: 1 - 4294967295 (overflow occurs if this range is exceeded)
 Description: Elapsed time after starting the agent

index 2

OID: iso(1).org(3).dod(6).internet(1).snmpV2(6).snmpModules(3).snmpMIB(1).snmpMIBObjects(1).snmpTrap(4).snmpTrapOID(1).0
 Syntax: Object Identifier
 Description: Trap OID

index 3

OID: leader(20111).lt4670(44).lt4670ST1(1).l44notificationTBL(0).l44trapStrTBL(2).l44trapCounter(1).0
 Syntax: Counter32
 Range: 1 - 4294967295
 Description: Total number of enterprise traps sent after starting up

index 4

OID: leader(20111).lt4670(44).lt4670ST1(1).l44notificationTBL(0).l44trapStrTBL(2).l44trapInternalTimestamp(2).0
 Syntax: DisplayString
 Range: Up to 20 characters
 Description: Date and time of error occurrence

index 5

OID: leader(20111).lt4670(44).lt4670ST1(1).l44notificationTBL(0).l44trapContentTBL(1).l44trapErrorTBL(1).X
 leader(20111).lt4670(44).lt4670ST1(1).l44notificationTBL(0).l44trapContentTBL(1).l44trapNormalTBL(2).X
 Syntax: DisplayString
 Range: Up to 16 characters
 Description: Error information character string
 When an error occurs, the OID of l44trapContentTBL(1).l44trapErrorTBL(1).X and error information character string are sent.
 When the error recovers, the OID of l44trapContentTBL(1).l44trapNormalTBL(2).X and error information character string are sent.

index 6

OID: leader(20111).lt4670(44).lt4670ST1(1).l44statusTBL(2).l44statusAlarmTBL(1).
X
leader(20111).lt4670(44).lt4670ST1(1).l44statusTBL(2).l44statusReferenceTBL
(2).X

Syntax: Integer

Description: Alarm status and reference signal status

18 WEB BROWSER

You can control this instrument from a general-purpose Web Browser on a PC.

* The Ethernet features of this instrument have only been confirmed to work in a local network environment. LEADER does not guarantee that the features will work in all network environments.

18.1 Operating Environment

This function has been confirmed to work with the following Web browsers.

- Google Chrome Ver. 118
- Microsoft Edge Ver. 118

18.2 How to Use

1. On the LT4670, set the IP address.

To set the IP address, choose "SYSTEM CONFIG > NETWORK > ETHERNET > IP ADDRESS".

```
3 . I P   A D D R E S S
   1 9 2 . 1 6 8 . 0 0 0 . 0 0 1
```

2. On the LT4670, enable the network settings.

You need to enable "NETWORK SETUP", "HTTP SETUP", and "WEB BROWSER" individually.

Choose "SYSTEM CONFIG > NETWORK > NETWORK SETUP", and set "ENABLE" for "NETWORK SETUP".

```
2 . N E T W O R K   S E T U P
    E N A B L E    D I S A B L E
```

Choose "SYSTEM CONFIG > NETWORK > HTTP > HTTP SETUP", and set "ENABLE" for "HTTP SETUP".

```
3 . H T T P   S E T U P
    E N A B L E    D I S A B L E
```

Choose "SYSTEM CONFIG > NETWORK > HTTP > WEB BROWSER", and set "ENABLE" for "WEB BROWSER".

```
3 . W E B   B R O W S E R
    E N A B L E    D I S A B L E
```

3. Connect **ETHERNET/CONTROL** on the **LT4670** rear panel to the network device.
4. Start the Web Browser on your PC.

5. Enter the URL in the address box of the Web Browser.

Enter "http://" and the IP address that you set in step 1.

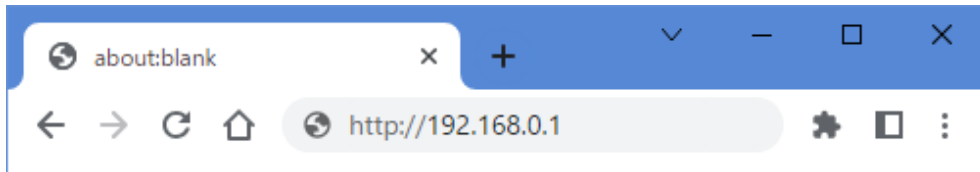

Figure 18-1 | URL

If you enter the correct URL, the STATUS screen of the LT4670 appears.

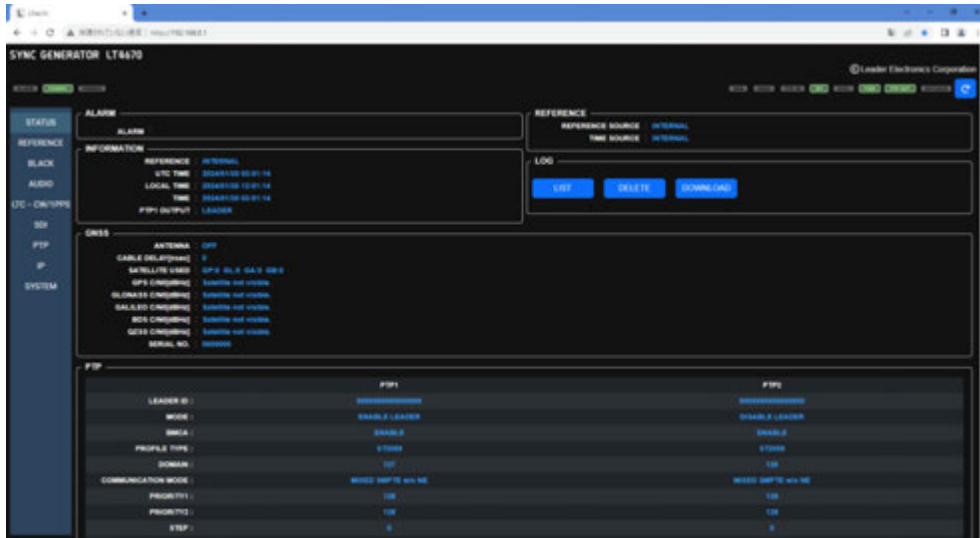

Figure 18-2 | STATUS screen

6. Control this instrument from the Web browser.

From the menu on the left, select an item and set values. Do not operate any key on the main unit while you control this instrument from the Web browser.

18.3 Procedure

Indicators and reload

The indicators at the top of the screen represent the LEDs on the LT4670 front panel. They light and blink as do the LEDs.

Clicking the reload button in the upper right of the screen reloads the screen, displaying the STATUS screen again.



Figure 18-3 | Indicators and reload

Selecting a menu

You can switch the setting items by selecting a menu on the left of the screen.

STATUS displays the STATUS menu of the LT4670. REFERENCE to SYSTEM mainly display the contents of the CONFIG menu of the LT4670. STATUS is for viewing the values only; it cannot be used to set the items.

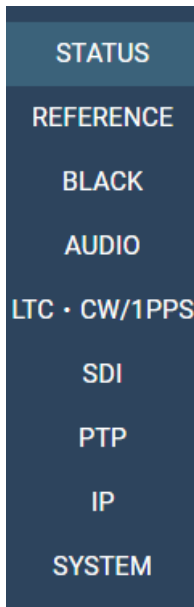

Figure 18-4 | Selecting a menu

Expanding the setting items

Some items of the setup screen have a hierarchical structure.

Immediately after you select a menu, all the items appear with their hierarchy shrunk. You can expand an item by clicking the "V" mark next to the title.

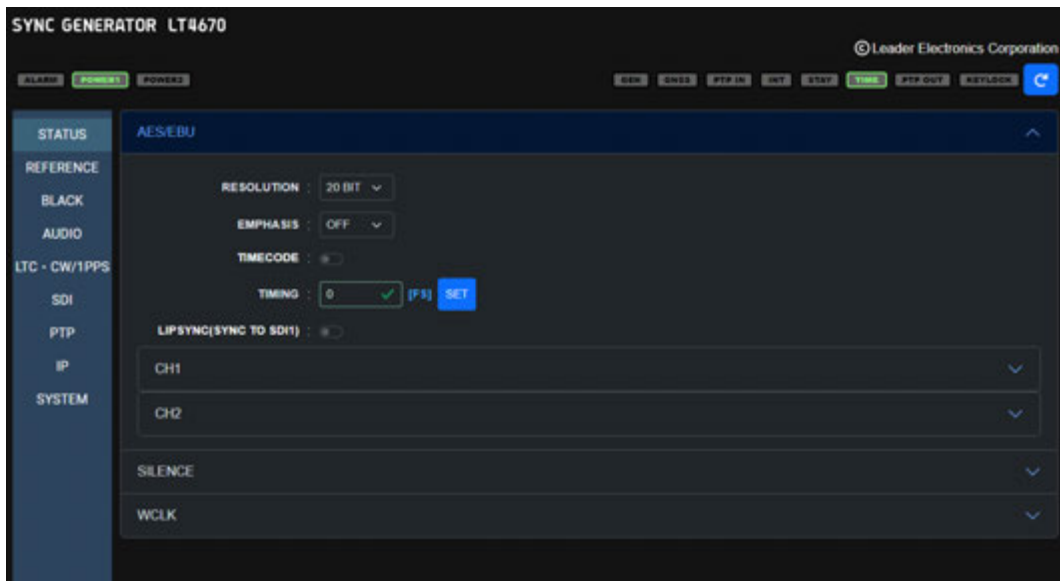

Figure 18-5 | Expanding the setting items

Selecting items

To select an item, click the selection box to select it.

Some selecting items have the SET button, and some don't.

If you change the value of an item that has the SET button, the changed value is applied when you click the SET button.

If the item does not have the SET button, the changed value is applied immediately.

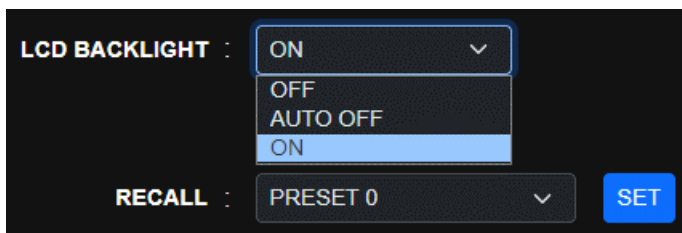

Figure 18-6 | Selecting items

Entering values

To enter a value, use the ▲ and ▼ buttons or enter a value directly.
The changed value is applied when you click the SET button.

When the value is within the specified range, a green check mark appears. If the value is outside the range, a red warning mark appears. If the red warning mark appears, the value is not applied. Enter a valid value.



Figure 18-7 | Entering values

18.4 Screen Description

This section describes the screens that appear when all options (SER01, SER02, SER03, SER04, SER11, and SER21) are added.

18.4.1 STATUS Screen

The STATUS screen displays the LT4670 status. This screen is for viewing the values only; it cannot be used to set the values.

SYNC GENERATOR LT4670

Leader Electronics Corporation

STATUS

REFERENCE

REFERENCE SOURCE : PTP2
 RECOVERY MODE : AUTO
 AUTO SETTING : FAST
 TIME SOURCE : PTP2

ALARM

ALARM : []

INFORMATION

REFERENCE : **PTP LEADER NOT FOUND**
 UTC TIME : 2024/01/01 06:26:45
 LOCAL TIME : 2024/01/01 15:26:45
 TIME : []
 PTP1 OUTPUT : **TIME MEASURING**

LOG

[LIST] [DELETE] [DOWNLOAD]

GNSS

ANTENNA : OFF
 CABLE DELAY[mm] : 0
 SATELLITE USED : GPS GLONASS GALILEO BDS QZSS
 GPS C/N0[dBHz] : Satellite not visible.
 GLONASS C/N0[dBHz] : Satellite not visible.
 GALILEO C/N0[dBHz] : Satellite not visible.
 BDS C/N0[dBHz] : Satellite not visible.
 QZSS C/N0[dBHz] : Satellite not visible.
 SERIAL NO. : 0000000

PTP

	PTP1	PTP2
LEADER ID :	0x0000000000000001	0x0000000000000000
MODE :	ENABLE LEADER	FOLLOWER
BMCA :	ENABLE	
PROFILE TYPE :	ST2059	ST2058
DOMAIN :	127	127
COMMUNICATION MODE :	MIXED SMPTE v10 NE	MULTICAST
PRIORITY1 :	128	
PRIORITY2 :	128	
STEP :	ONE STEP	
CLOCK CLASS :	248	13
CLOCK ACCURACY :		
CLOCK SOURCE :	ATOM	ATOM
PHASE LAG :		0.000 ps
LOCK VALUE :		
PACKET NOISE :		
ST2059 LOCAL OFFSET :	08:59:23	08:59:23
ST2059 JUMP SECONDS :	00:00:00	00:00:00
ST2059 NEXT JUMP :	01/01 00:00:00	01/01 00:00:00
ST2059 NEXT JAM TIME :	2024/01/01 06:00:27	2024/01/01 06:00:27
ST2059 PREVIOUS JAM TIME :	1970/01/01 00:00:00	1970/01/01 00:00:00
SERIAL NO. :	0000000	

BLACK

	BLACK1	BLACK2	BLACK3	BLACK4	BLACK5	BLACK6
FORMAT :	NTSC BB	NTSC BB	NTSC BB	NTSC BB	NTSC BB	NTSC BB
TIMING :	F : S, L : S, D : S	F : S, L : S, D : S	F : S, L : S, D : S	F : S, L : S, D : S	F : S, L : S, D : S	F : S, L : S, D : S
OUTPUT :	ENABLE	ENABLE	ENABLE	ENABLE	ENABLE	ENABLE
LINK TO PTP1 BMCA :	DISABLE	DISABLE	DISABLE	DISABLE	DISABLE	DISABLE
LINK TO PTP2 BMCA :	DISABLE	DISABLE	DISABLE	DISABLE	DISABLE	DISABLE



Figure 18-8 | STATUS screen

Table 18-1 | Description of the STATUS screen

	Item	Description
ALARM	ALARM	The details of the alarm that currently exists are displayed in red.
INFORMATION	REFERENCE	The lock status is displayed. When not locked, the item is displayed in orange.
	GENLOCK FORMAT	The input signal format is displayed.
	UTC TIME	The Coordinated Universal Time loaded from TIME SOURCE is displayed.
	LOCAL TIME	The internal clock of the instrument is displayed.
	TIME	The date and time selected with TIME SOURCE on the REFERENCE CONFIG menu is displayed.
	GNSS	The input status of the GNSS signal and attention information is displayed.
	PTP* OUTPUT	The output status of the PTP is displayed.
REFERENCE	REFERENCE SOURCE	The reference signal is displayed.
	GENLOCK FORMAT	The genlock format is displayed.
	TIMING FINE	The output signal timing relative to the reference signal is displayed.
	GNSS SATELLITE	The satellite type is displayed.

	Item	Description
	RECOVERY MODE	The recovery mode is displayed.
	AUTO SETTING	The relock speed when the recovery mode is AUTO is displayed.
	MANUAL SETTING	The relock speed when the recovery mode is MANUAL is displayed.
	TIME SOURCE	The time source is displayed.
LOG	LIST	The log is displayed in a pop-up.
	DELETE	Delete the log.
	DOWNLOAD	Download the log in txt format.
GNSS	ANTENNA	The voltage of the power supplied to the GNSS antenna is displayed.
	CABLE DELAY	The delay correction value of the GNSS cable is displayed.
	SATELLITE USED	The number of effective satellites is displayed.
	GPS C/N0	C/N0 of GPS is displayed.
	GLONASS C/N0	C/N0 of GLONASS is displayed.
	GALILEO C/N0	C/N0 of GALILEO is displayed.
	BDS C/N0	C/N0 of BDS is displayed.
	QZSS C/N0	C/N0 of QZSS is displayed.
	SERIAL NO.	The serial number of the GNSS option is displayed.
PTP	LEADER ID	The ID of the leader locked when the instrument is a follower is displayed.
	MODE	Displays the mode
	BMCA	The BMCA setting is displayed when the instrument is a leader.
	PROFILE TYPE	The profile is displayed.
	DOMAIN	The domain number is displayed.
	COMMUNICATION MODE	The communication mode is displayed.
	PRIORITY*	The priority is displayed when the instrument is a leader.
	STEP	The step is displayed.
	CLOCK CLASS	The value of the clock class defined in IEEE1588 is displayed.
	CLOCK ACCURACY	The clock accuracy is displayed.
	CLOCK SOURCE	The time source used is displayed.
	PHASE LAG	The phase difference between the leader and follower is displayed when the instrument is a follower.
	LOCK VALUE	The lock strength of the leader and follower is displayed when the instrument is a follower.
	PACKET NOISE	The average value of the PTP noise is displayed when the instrument is a follower.
	ST2059 LOCAL OFFSET	The offset time for TAI is displayed.
	ST2059 JUMP SECONDS	The offset time during the daylight saving time is displayed.
	ST2059 NEXT JUMP	The start or end date and time of the daylight saving time is displayed.
	ST2059 NEXT JAM TIME	The date and time on which jam sync will occur next is displayed.
	ST2059 PREVIOUS JAM TIME	The date and time on which jam sync occurred is displayed.
	SERIAL NO.	The serial number of the PTP option is displayed.
BLACK	FORMAT	The black format and EQUAL TO BLACK1 information is displayed.
	TIMING	The black output timing relative to the reference signal is displayed.

Item		Description
	OUTPUT	Whether the black output is enabled or disabled is displayed.
	LINK TO PTP* BMCA	Whether to stop the black output in linkage with BMCA is displayed.
LTC	ON/OFF	The LTC output on/off state and EQUAL TO LTC1 information is displayed.
	FORMAT	The LTC format is displayed.
	OFFSET	The offset of the LTC output relative to the reference signal is displayed.
	DROP FRAME	The dropped frame on/off state is displayed.
SYSTEM	SERIAL NO.	The serial number of LT4670 is displayed.
	FIRMWARE VERSION	The firmware version is displayed.
	OPTION	The added software option is displayed.
CW/1PPS	OUTPUT	The signal output from the CW/1PPS connector on the rear panel is displayed.
SDI	FORMAT	The SDI format and EQUAL TO SDI* information is displayed.
	TIMING	The SDI output timing relative to the reference signal is displayed.
	PATTERN	The pattern is displayed.
	OUTPUT	Whether the SDI output is enabled or disabled is displayed.
	LINK TO PTP* BMCA	Whether to stop SDI output in linkage with BMCA is displayed.
	SERIAL NO.	The serial number of the SDI option is displayed.
	FW	The FPGA version is displayed.
IP	TYPE	The IP output standard is displayed.
	OUTPUT	The IP output is displayed.
	VIDEO	The video output is displayed.
	VIDEO PAYLOAD	The payload type of the video is displayed.
	VIDEO VLAN	The VLAN setting of the video is displayed.
	VIDEO VLAN TAG	The VLAN tag of the video is displayed.
	VIDEO DSCP	The DSCP setting of the video is displayed.
	VIDEO DSCP TAG	The DSCP tag of the video is displayed.
	VIDEO DESTINATION IP	The destination IP address of the video is displayed.
	VIDEO DESTINATION PORT	The destination port number of the video is displayed.
	AUDIO	The audio output is displayed.
	AUDIO PAYLOAD	The payload type of the audio is displayed.
	AUDIO VLAN	The VLAN setting of the audio is displayed.
	AUDIO VLAN TAG	The VLAN tag of the audio is displayed.
	AUDIO DSCP	The DSCP setting of the audio is displayed.
	AUDIO DSCP TAG	The DSCP tag of the audio is displayed.
	AUDIO MODE	The audio output standard is displayed.
	AUDIO PACKET TIME	The packet time of the audio is displayed.
	AUDIO DESTINATION IP	The destination IP address of the audio is displayed.
	AUDIO DESTINATION PORT	The destination port number of the audio is displayed.
	ANC	The ANC output is displayed.
	ANC PAYLOAD	The payload type of the ANC is displayed.
	ANC VLAN	The VLAN setting of the ANC is displayed.
	ANC VLAN TAG	The VLAN tag of the ANC is displayed.
ANC DSCP	The DSCP setting of the ANC is displayed.	

18 WEB BROWSER

Item	Description
ANC DSCP TAG	The DSCP tag of the ANC is displayed.
ANC DESTINATION IP	The destination IP address of the ANC is displayed.
ANC DESTINATION PORT	The destination port number of the ANC is displayed.
MAC ADDRESS	The MAC address of the IP option is displayed.
SERIAL NO.	The serial number of the IP option is displayed.
FW	The FPGA version is displayed.

18.4.2 REFERENCE Screen

The REFERENCE screen lets you set the items of the REFERENCE CONFIG menu of LT4670.

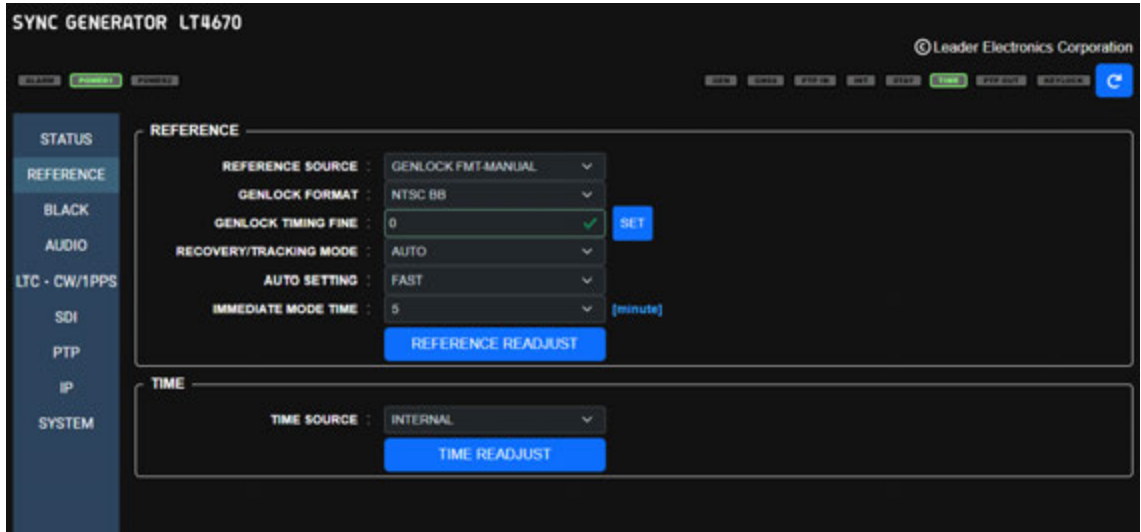

Figure 18-9 | REFERENCE screen

Table 18-2 | Description of the REFERENCE screen

Item	Description	Initial Value
REFERENCE SOURCE	Select the reference signal.	INTERNAL
GENLOCK FORMAT	Select the genlock format.	NTSC BB (NTSC) PAL (PAL)
GENLOCK TIMING FINE	Set the output signal timing relative to the reference signal.	0
GNSS SATELLITE	Select the satellite type.	ALL
RECOVERY/TRACKING MODE	Select the recovery mode.	AUTO
AUTO SETTING	Select the relock speed when the recovery mode is AUTO.	FAST
MANUAL SETTING	Select the relock speed when the recovery mode is MANUAL.	IMMEDIATE
IMMEDIATE MODE TIME	Set the time for which the instrument operates with IMMEDIATE at power-on.	5
REFERENCE READJUST	Relock manually to the reference signal.	-
TIME SOURCE	Select the time source.	INTERNAL
TIME READJUST	Load the time manually.	-

18.4.3 BLACK Screen

The BLACK screen lets you set the items of the BLACK CONFIG menu of LT4670.

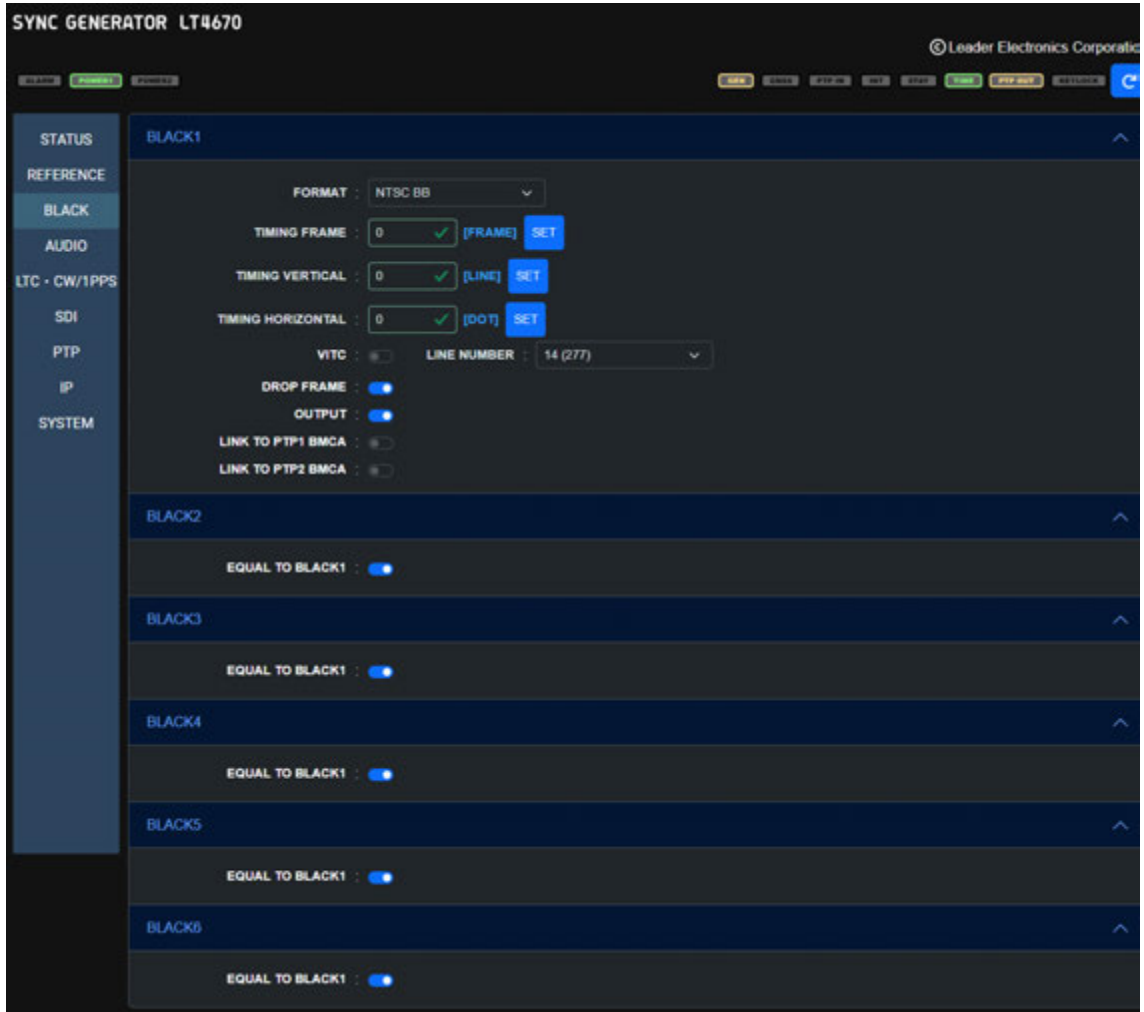

Figure 18-10 | BLACK screen

Table 18-3 | Description of BLACK screen

Item	Description	Initial Value
FORMAT	Select the black format.	NTSC BB (NTSC) PAL BB (PAL)
TIMING FRAME	Set the black output timing relative to the reference signal in frames.	0
TIMING VERTICAL	Set the black output timing relative to the reference signal in lines.	0
TIMING HORIZONTAL	Set the black output timing relative to the reference signal in dots.	0
VITC	Turn time code insertion on or off.	OFF
LINE NUMBER	Set the time code superimposition line.	14 (NTSC) 19 (PAL)
DROP FRAME	Turn the dropped frame on or off.	ON
OUTPUT	Turn the black output on or off.	ON
LINKED TO PTP* BMCA	Select whether to stop the black output in linkage with BMCA.	OFF
EQUAL TO BLACK1	Select whether to make the settings the same as those for BLACK1.	OFF

18.4.4 AUDIO Screen

The AUDIO screen lets you set the items of the AUDIO CONFIG menu of LT4670.

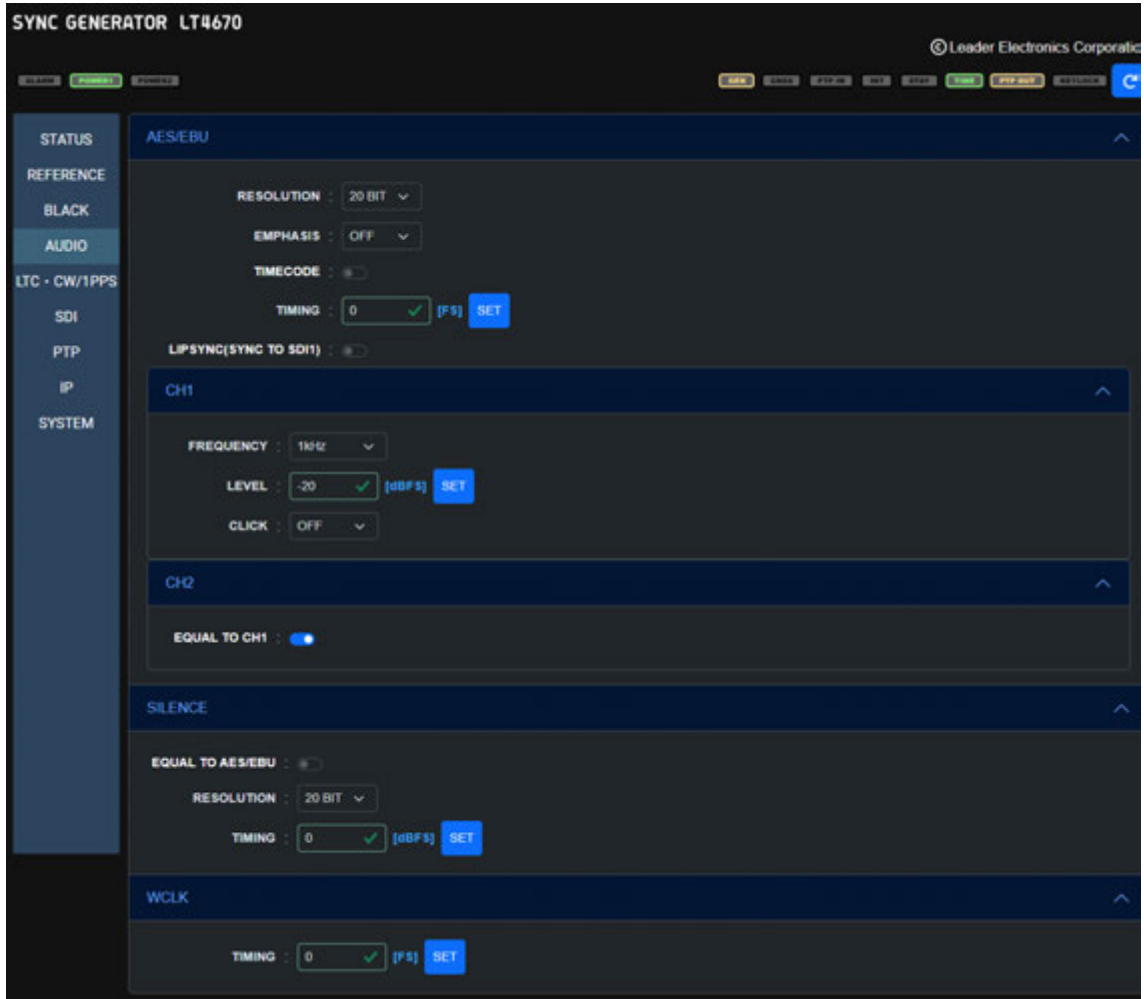

Figure 18-11 | AUDIO screen

Table 18-4 | Description of AUDIO screen

Item		Description	Initial Value
AES/EBU	RESOLUTION	Select the resolution.	20 BIT
	EMPHASIS	Select the pre-emphasis mode.	OFF
	TIMECODE	Turn time code insertion on or off.	OFF
	TIMING	Set the AES/EBU output timing relative to the reference signal.	0
	LIPSYNC(SYNC TO SDI1)	Select whether to link with lip sync.	OFF
	FREQUENCY	Select the frequency.	1kHz
	LEVEL	Set the level.	-20
	CLICK	Select the click insertion interval.	OFF
	EQUAL TO CH1	Select whether to make the settings the same as those for CH1.	OFF
SILENCE	EQUAL TO AES/EBU	Select whether to make the settings the same as those for AES/EBU.	OFF
	RESOLUTION	Select the resolution.	20 BIT
	TIMING	Set the silence output timing relative to the reference signal.	0
WCLK	TIMING	Set the word-clock output timing relative to the reference signal.	0

18.4.5 LTC & CW/1PPS Screen

The LTC & CW/1PPS screen lets you set the items of the LTC CONFIG menu and CW/1PPS CONFIG menu of LT4670.

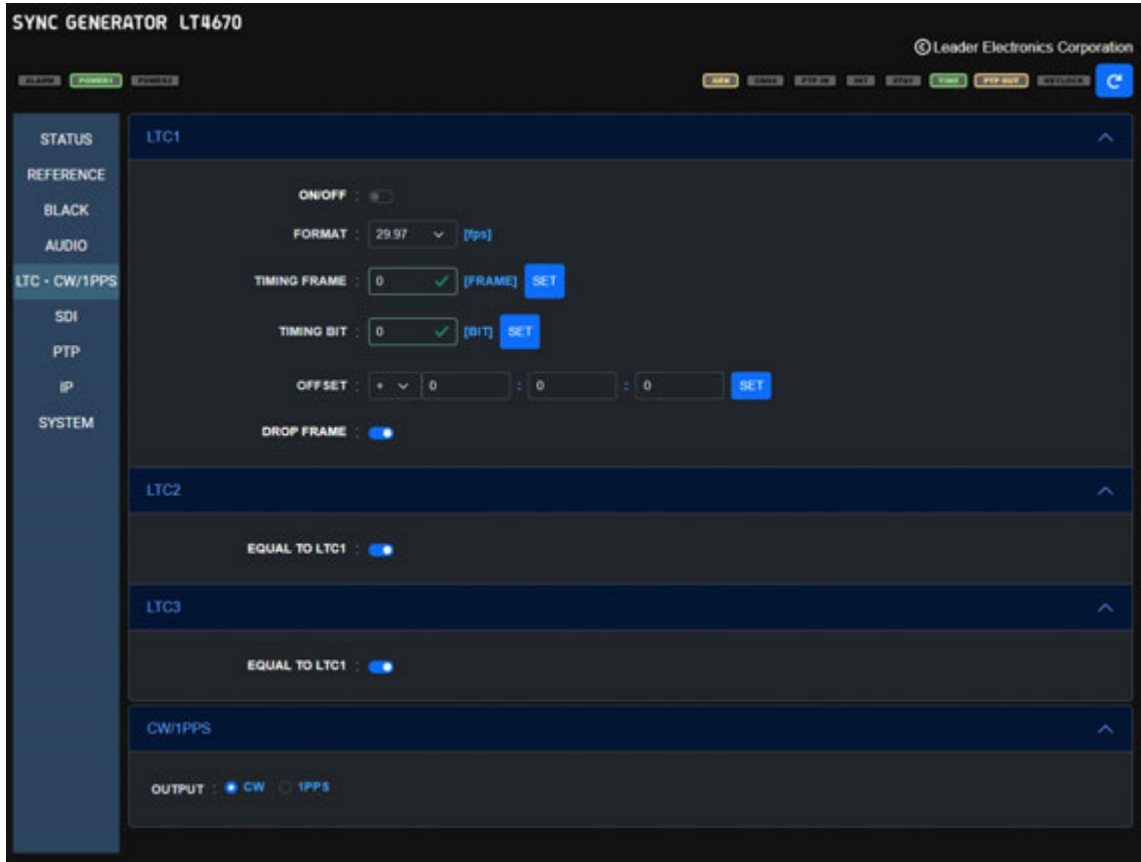

Figure 18-12 | LTC & CW/1PPS screen

Table 18-5 | Description of the LTC & CW/1PPS screen

Item	Description	Initial Value
ON/OFF	Turn the LTC output on or off.	OFF
FORMAT	Select the LTC format.	29.97 (NTSC) 25 (PAL)
TIMING FRAME	Set the LTC output timing relative to the reference signal in frames.	0
TIMING BIT	Set the LTC output timing relative to the reference signal in bits.	0
OFFSET	Set the offset of the LTC output relative to the reference signal.	+00:00:00
DROP FRAME	Turn the dropped frame on or off.	ON
EQUAL TO LTC1	Select whether to make the settings the same as those for LTC1.	OFF
OUTPUT	Select the signal output from the CW/1PPS connector on the rear panel.	CW

18.4.6 SDI Screen (SER02/SER04)

The SDI screen lets you set the items of the SDI CONFIG menu of LT4670.

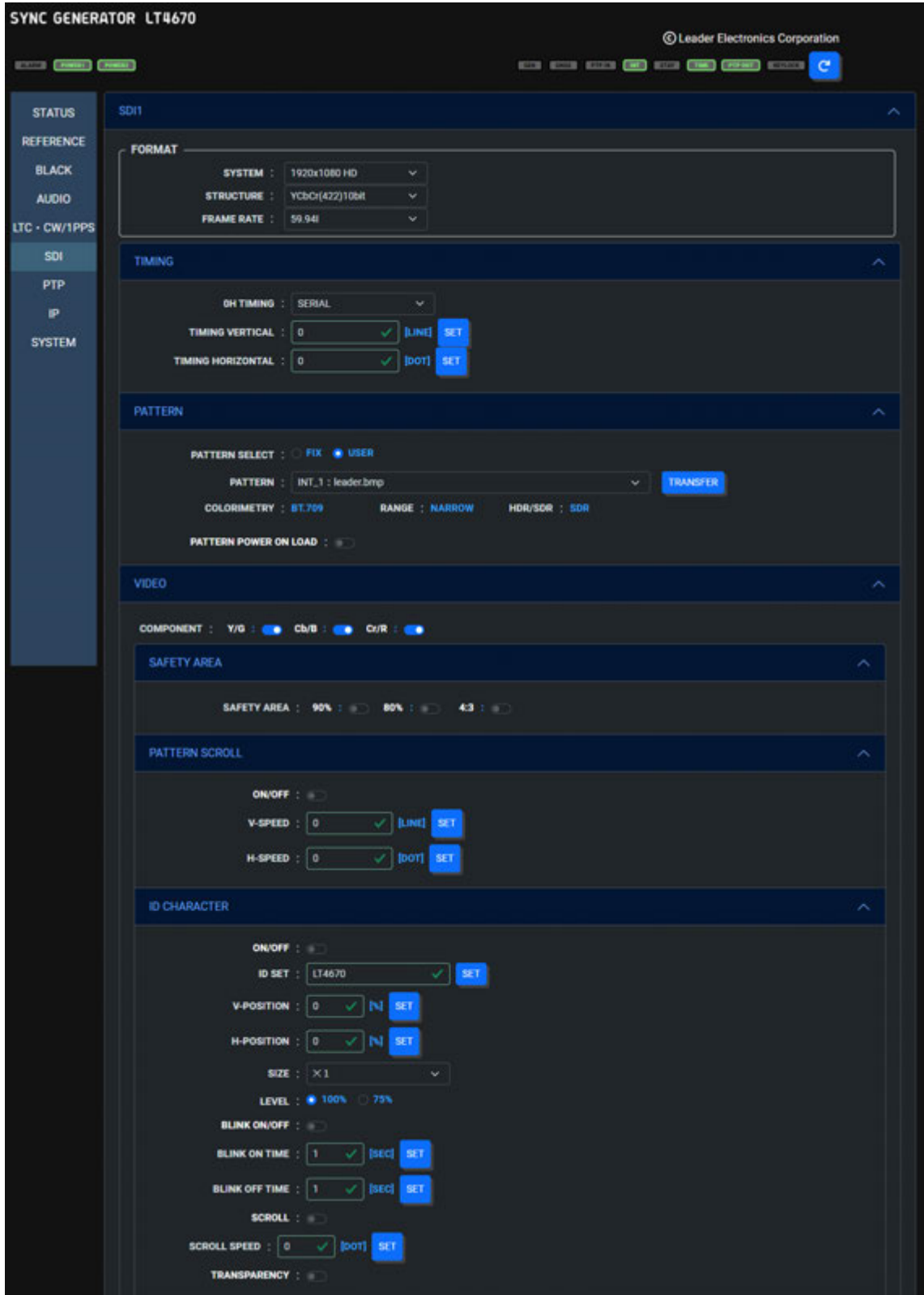

LOGO

ON/OFF :

SELECT : INT_1 : NO DATA

V-POSITION : 0 ✓ [N] SET

H-POSITION : 0 ✓ [N] SET

TRANSPARENCY :

TRANSPARENCY LEVEL : 16 ✓ SET

MOVING BOX

ON/OFF :

BOX COLOR : WHITE

V-SPEED : MIDDLE

H-SPEED : MIDDLE

V-SIZE : SIZE2

H-SIZE : SIZE2

CIRCLE

ON/OFF :

SIZE : 90%

LEVEL : 100% 75%

BLINK ON/OFF :

BLINK ON TIME : 1 ✓ [SEC] SET

BLINK OFF TIME : 1 ✓ [SEC] SET

TIME CODE

ON/OFF :

V-POSITION : 0 ✓ [N] SET

H-POSITION : 0 ✓ [N] SET

SIZE : X 1

LEVEL : 100% 75%

TRANSPARENCY :

LIPSYNC

ON/OFF :

EMS AUDIO

AUDIO ON/OFF : G1 : G2 : G3 : G4 :

GROUP 1

RESOLUTION	EMPHASIS	CH 1	CH 2	CH 3	CH 4	EQUAL TO CH1
20 BIT	OFF	FERQ : 1kHz	FERQ : 1kHz	FERQ : 1kHz	FERQ : 1kHz	<input type="checkbox"/>
		LEVEL : -20 ✓ [dBFS] SET	LEVEL : -20 ✓ [dBFS] SET	LEVEL : -20 ✓ [dBFS] SET	LEVEL : -20 ✓ [dBFS] SET	<input type="checkbox"/>
		CLICK : OFF	CLICK : OFF	CLICK : OFF	CLICK : OFF	<input type="checkbox"/>

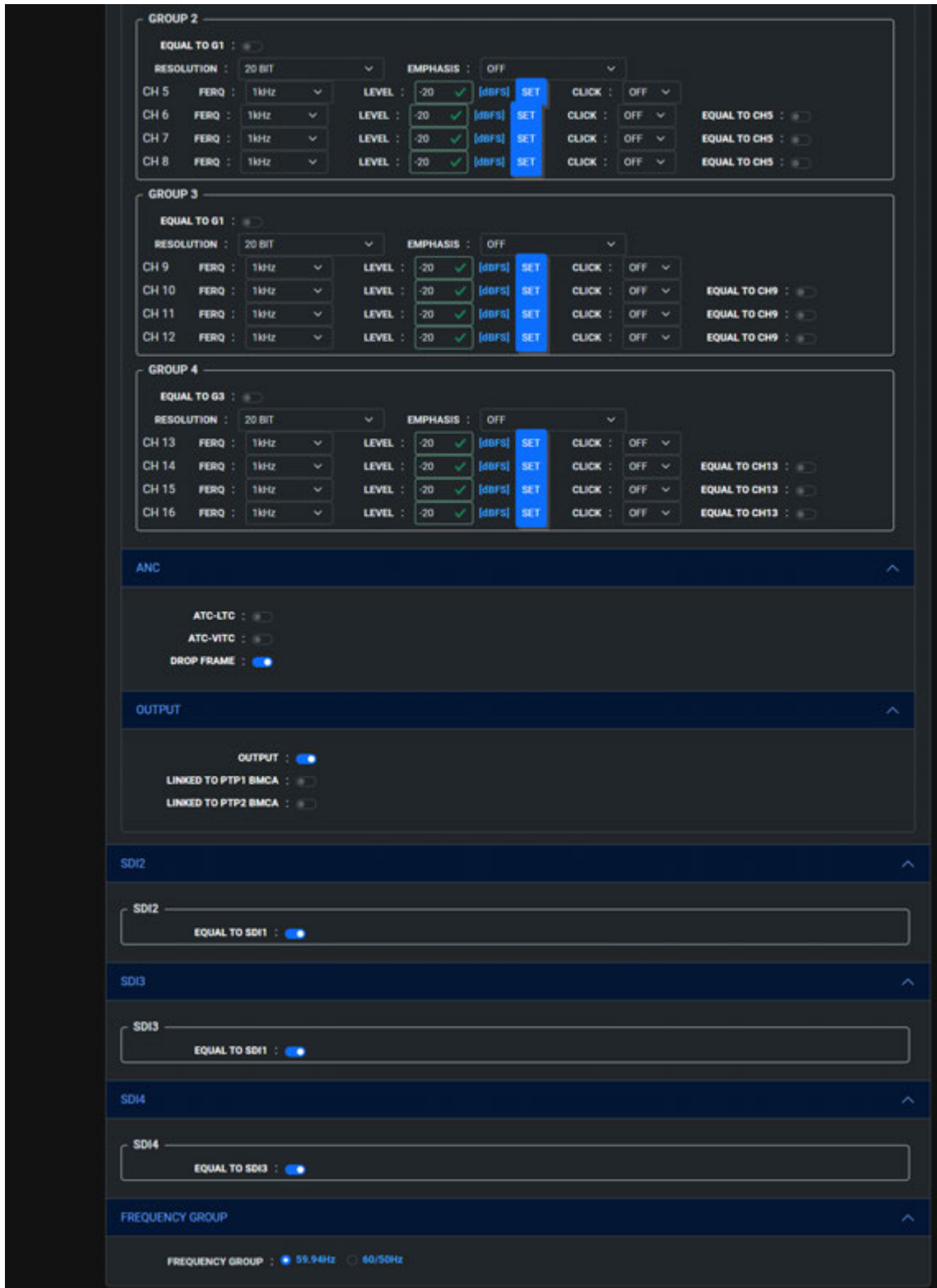

Figure 18-13 | SDI screen

Table 18-6 | Description of SDI screen

Item		Description	Initial Value
FORMAT	SYSTEM	Select the SDI format.	1920x1080 HD
	STRUCTURE	Select the color system and quantization accuracy.	YCbCr(422)10bit
	FRAME RATE	Select the frame (field) frequency.	59.94I (NTSC) 50I (PAL)
TIMING	0H TIMING	Select the reference timing for the SDI output and black output.	SERIAL
	TIMING VERTICAL	Set the SDI output timing relative to the reference signal in lines.	0
	TIMING HORIZONTAL	Set the SDI output timing relative to the reference signal in dots.	0
PATTERN	PATTERN SELECT	Select the pattern type.	FIX
	PATTERN	Select the pattern.	COLOR BAR 100%
	TRANSFER	Transfer user patterns.	-
	COLORIMETRY	The user pattern colorimetry is displayed.	-
	RANGE	The user pattern range is displayed.	-
	HDR/SDR	The user pattern HDR standard is displayed.	-
	PATTERN POWER ON LOAD	Select whether to transfer user patterns at startup.	OFF
VIDEO	COMPONENT	Turn the output signal on or off for each component.	All ON
SAFETY AREA	SAFETY AREA	Turn the safety area marker on or off.	All OFF
PATTERN SCROLL	ON/OFF	Turn the scroll on or off.	OFF
	V-SPEED	Set the vertical scroll speed and direction.	0
	H-SPEED	Set the horizontal scroll speed and direction.	0
PATTERN CHANGE	ON/OFF	Turn pattern change on or off.	OFF
	SPEED	Set the pattern change interval.	1
ID CHARACTER	ON/OFF	Turn ID characters on or off.	OFF
	ID SET	Create ID characters.	LT4670
	V-POSITION	Set the vertical position of ID characters.	0
	H-POSITION	Set the horizontal position of ID characters.	0
	SIZE	Select the size of ID characters.	×1
	LEVEL	Select the luminance level of ID characters.	100%
	BLINK ON/OFF	Turn the blinking of ID characters on or off.	OFF
	BLINK ON TIME	Set the blinking on-time of ID characters.	1
	BLINK OFF TIME	Set the blinking off-time of ID characters.	1
	SCROLL	Turn the scroll of ID characters on or off.	OFF
	SCROLL SPEED	Set the ID character scroll speed and direction.	0
TRANSPARENCY	Turn ID character background transparency on or off.	OFF	
LOGO	ON/OFF	Turn the logo on or off.	OFF
	SELECT	Select the logo.	INT_1
	V-POSITION	Set the vertical logo position.	0

	Item	Description	Initial Value
	H-POSITION	Set the horizontal logo position.	0
	TRANSPARENCY	Turn the logo transparency on or off.	OFF
	TRANSPARENCY LEVEL	Set the transparency level of the logo.	16
MOVING BOX	ON/OFF	Turn the moving box on or off.	OFF
	BOX COLOR	Select the moving box color.	WHITE
	V-SPEED	Set the vertical moving box speed.	MIDDLE
	H-SPEED	Set the horizontal moving box speed.	MIDDLE
	V-SIZE	Select the moving box height.	SIZE2
	H-SIZE	Select the moving box width.	SIZE2
CIRCLE	ON/OFF	Turn the circle on or off.	OFF
	SIZE	Select the circle size.	90%
	LEVEL	Select the luminance level of the circle.	100%
	BLINK ON/OFF	Turn the blinking of the circle on or off.	OFF
	BLINK ON TIME	Set the circle blinking on-time.	1
	BLINK OFF TIME	Set the circle blinking off-time.	1
TIME CODE	ON/OFF	Turn the time code on or off.	OFF
	V-POSITION	Set the vertical time code position.	0
	H-POSITION	Set the horizontal time code position.	0
	SIZE	Select the time code size.	×1
	LEVEL	Select the time code luminance level.	100%
	TRANSPARENCY	Turn time code background transparency on or off.	OFF
LIPSYNC	ON/OFF	Turn the lip sync pattern on or off.	OFF
EMB AUDIO	AUDIO ON/OFF	Turn the audio on or off for each group.	All ON
	RESOLUTION	Select the resolution.	20 BIT
	EMPHASIS	Select the pre-emphasis mode.	OFF
	FREQ	Select the frequency.	1kHz
	LEVEL	Set the level.	-20
	CLICK	Select the click insertion interval.	OFF
	EQUAL TO CH1	Select whether to make the settings the same as those for CH1.	OFF
	EQUAL TO CH5	Select whether to make the settings the same as those for CH5.	OFF
	EQUAL TO CH9	Select whether to make the settings the same as those for CH9.	OFF
	EQUAL TO CH13	Select whether to make the settings the same as those for CH13.	OFF
	EQUAL TO G1	Select whether to make the settings the same as those for Group 1.	OFF
	EQUAL TO G3	Select whether to make the settings the same as those for Group 3.	OFF
ANC	ATC-LTC	Turn the LTC insertion on or off.	OFF
	ATC-VITC	Turn the VITC insertion on or off.	OFF
	DROP FRAME	Turn the dropped frame on or off.	ON
OUTPUT	OUTPUT	Turn the SDI output on or off.	ENABLE

18 WEB BROWSER

Item		Description	Initial Value
	LINKED TO PTP* BMCA	Select whether to stop SDI output in linkage with BMCA.	DISABLE
SDI2, SDI3	EQUAL TO SDI1	Select whether to make the settings the same as those for SDI1.	OFF
SDI4	EQUAL TO SDI3	Select whether to make the settings the same as those for SDI3.	OFF
FREQUENCY GROUP	FREQUENCY GROUP	Select the frequency group that can be selected for the frame frequency of the SDI output.	59.94Hz (NTSC) 60/50Hz (PAL)

18.4.7 PTP Screen (SER03)

The PTP screen lets you set the items of the PTP CONFIG menu of LT4670.



Figure 18-14 | PTP screen

Table 18-7 | Description of the PTP screen (when the instrument is a PTP leader)

Item	Description	Initial Value
MODE	Select whether to enable the PTP leader.	ENABLE LEADER
BMCA	Select whether to enable BMCA.	ENABLE
PROFILE TYPE	Select the profile.	ST2059
PRIORITY1 RECOVERY	Recover the value of Priority 1.	-
PROFILE SET DEFAULT	Return to the default value of the selected profile.	-
DOMAIN	Set the domain number.	127 (PTP1, ST2059) 126 (PTP2, ST2059) 0 (AES67/GENERAL)
COMMUNICATION MODE	Select the communication mode.	MIXED SMPTE w/o NE
ANNOUNCE INTERVAL	Select the announce message transmission interval.	0.25s (ST2059) 2s (AES67/GENERAL)
SYNC INTERVAL	Select the sync message transmission interval.	0.125s (ST2059/AES67) 1s (GENERAL)
PRIORITY*	Specify the priority.	128
STEP	Select the step.	ONE STEP
DEFAULT FRAME	Select the default frame.	29.97
DROP FRAME	Select whether to enable the dropped frame flag.	ENABLE
COLOR FRAME ID	Select whether to enable the color frame ID.	ENABLE
ANNOUNCE TIMEOUT	Set the number of announce messages used to judge whether a timeout occurs.	3
DELAY MECHANISM	Select the propagation time measurement method.	END TO END
IP ADDRESS	The IP address of the PTP option is displayed.	-
SUBNET MASK	The subnet mask of the PTP option is displayed.	-
DEFAULT GATEWAY	The default gateway of the PTP option is displayed.	-
MAC ADDRESS	The MAC address of the PTP option is displayed.	-

Table 18-8 | Description of the PTP screen (when the instrument is a PTP follower)

Item	Description	Initial Value
MODE	Fixed to FOLLOWER.	FOLLOWER
PROFILE TYPE	Select the profile.	ST2059
PROFILE SET DEFAULT	Return to the default value of the selected profile.	-
DOMAIN	Set the domain number.	127 (PTP1, ST2059) 126 (PTP2, ST2059) 0 (AES67/GENERAL)
COMMUNICATION MODE	Select the communication mode.	MULTICAST
ANNOUNCE DESIR INT	Select the desired announce message transmission interval.	0.25s (ST2059) 2s (AES67/GENERAL)
ANNOUNCE REQD INT	Select the announce message reception interval.	2s (ST2059) 16s (AES67/GENERAL)
SYNC DESIR INT	Select the desired sync message transmission interval.	0.125s (ST2059) 1s (AES67) 2s (GENERAL)
SYNC REQD INT	Select the sync message reception interval.	0.5s (ST2059) 2s (AES67) 8s (GENERAL)
DLY MSG INT	Select the delay message transmission interval.	0.125s (ST2059) 1s (AES67/GENERAL)
DLY MSG DESIR INT	Select the desired delay message transmission interval.	0.125s (ST2059/AES67) 2s (GENERAL)
DLY MSG REQD INT	Select the delay message reception interval.	0.5s (ST2059) 2s (AES67) 0.125Hz (GENERAL)
AMT ADDRESS *	Set the IP address of the leader to be connected.	000.000.000.000
ANNOUNCE TIMEOUT	Set the number of announce messages used to judge whether a timeout occurs.	3
DELAY MECHANISM	Select the propagation time measurement method.	END TO END
ASYMMETRIC DELAY	Set the phase correction value.	0
IP ADDRESS	The IP address of the PTP option is displayed.	-
SUBNET MASK	The subnet mask of the PTP option is displayed.	-
DEFAULT GATEWAY	The default gateway of the PTP option is displayed.	-
MAC ADDRESS	The MAC address of the PTP option is displayed.	-

18.4.8 IP Screen (SER04)

The IP screen lets you set the items of the IP CONFIG menu of LT4670.

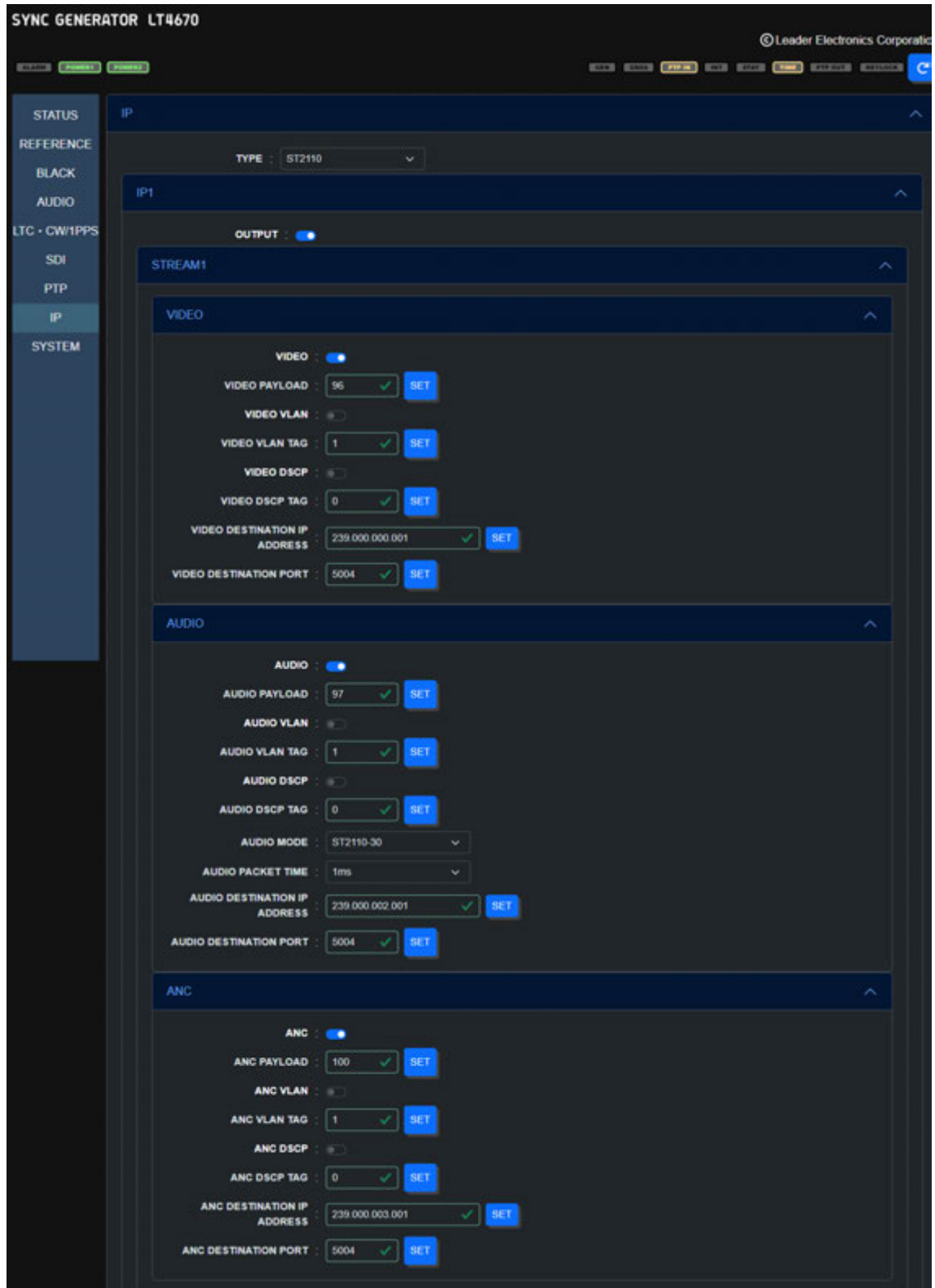

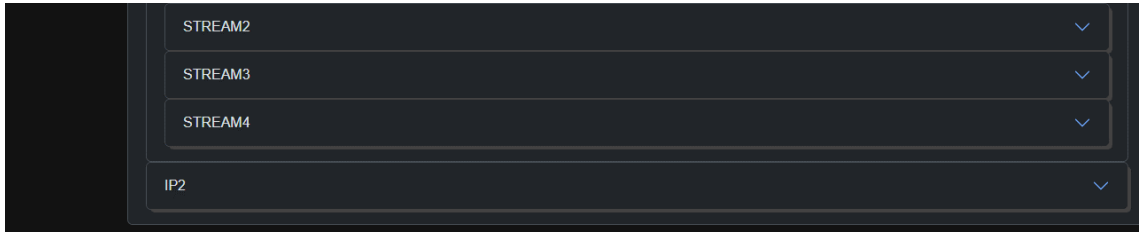

Figure 18-15 | IP screen

Table 18-9 | Description of the IP screen

Item	Description	Initial Value
TYPE	Select the IP output standard.	ST2110
OUTPUT	Turn the IP output on or off.	ON
VIDEO	Turn the video output on or off.	ON
VIDEO PAYLOAD	Set the payload type of the video.	96
VIDEO VLAN	Turn the VLAN setting of the video on or off.	OFF
VIDEO VLAN TAG	Set the VLAN tag of the video.	1
VIDEO DSCP	Turn the DSCP setting of the video on or off.	OFF
VIDEO DSCP TAG	Set the DSCP tag of the video.	0
VIDEO DESTINATION IP ADDRESS	Set the destination IP address of the video.	239.000.000.001 (IP1, ST1) 239.000.000.002 (IP1, ST2) 239.000.000.003 (IP1, ST3) 239.000.000.004 (IP1, ST4) 239.000.000.005 (IP2, ST1) 239.000.000.006 (IP2, ST2) 239.000.000.007 (IP2, ST3) 239.000.000.008 (IP2, ST4)
VIDEO DESTINATION PORT	Set the destination port number of the video.	5004
AUDIO	Turn the audio output on or off.	ON
AUDIO PAYLOAD	Set the payload type of the audio.	97
AUDIO VLAN	Turn the VLAN setting of the audio on or off.	OFF
AUDIO VLAN TAG	Set the VLAN tag of the audio.	1
AUDIO DSCP	Turn the DSCP setting of the audio on or off.	OFF
AUDIO DSCP TAG	Set the DSCP tag of the audio.	0
AUDIO MODE	Select the audio output standard.	ST2110-30
AUDIO PACKET TIME	Select the packet time of the audio.	1ms
AUDIO DESTINATION IP ADDRESS	Set the destination IP address of the audio.	239.000.002.001 (IP1, ST1) 239.000.002.002 (IP1, ST2) 239.000.002.003 (IP1, ST3) 239.000.002.004 (IP1, ST4) 239.000.002.005 (IP2, ST1) 239.000.002.006 (IP2, ST2) 239.000.002.007 (IP2, ST3) 239.000.002.008 (IP2, ST4)
AUDIO DESTINATION PORT	Set the destination port number of the audio.	5004

18 WEB BROWSER

Item	Description	Initial Value
ANC	Turn the ANC output on or off.	ON
ANC PAYLOAD	Set the payload type of the ANC.	100
ANC VLAN	Turn the VLAN setting of the ANC on or off.	OFF
ANC VLAN TAG	Set the VLAN tag of the ANC.	1
ANC DSCP	Turn the DSCP setting of the ANC on or off.	OFF
ANC DSCP TAG	Set the DSCP tag of the ANC.	0
ANC DESTINATION IP ADDRESS	Set the destination IP address of the ANC.	239.000.003.001 (IP1, ST1) 239.000.003.002 (IP1, ST2) 239.000.003.003 (IP1, ST3) 239.000.003.004 (IP1, ST4) 239.000.003.005 (IP2, ST1) 239.000.003.006 (IP2, ST2) 239.000.003.007 (IP2, ST3) 239.000.003.008 (IP2, ST4)
ANC DESTINATION PORT	Set the destination port number of the ANC.	5004

18.4.9 SYSTEM Screen

The SYSTEM screen lets you set the items of the SYSTEM CONFIG menu of LT4670.

SYNC GENERATOR LT4670 Leader Electronics Corporation

UTILITY

- LCD BACKLIGHT : ON
- KEY LOCK ON/OFF :

PRESET

- RECALL : PRESET 0 [SET]
- POWER ON RECALL : OFF [SET]
- STORE : PRESET 0 [SET]
- COMMENT : PRESET 0 [SET]
- COPY : PRESET 0 [DOWNLOAD]

NETWORK

- IP ADDRESS : 192.168.0.001
- SUBNET MASK : 255.255.255.000
- DEFAULT GATEWAY : 000.000.000.000
- MAC ADDRESS : 00:00:00:00:00:00

SNMP

- SETUP : V3
- ENGINEID : 0x00000000000000000000
- TRAP1 : MANAGER IP1 : 000.000.000.000 [SET]
- TRAP2 : MANAGER IP2 : 000.000.000.000 [SET]
- TRAP3 : MANAGER IP3 : 000.000.000.000 [SET]
- TRAP4 : MANAGER IP4 : 000.000.000.000 [SET]
- [GET MIB]

HTTP

- : ENABLE

NTP

- ON/OFF :
- SERVER ADDRESS : 000.000.000.000 [SET]

TIME MANAGEMENT

- TIMEZONE OFFSET : UTC+9:00
- JAM SYNC :
- JAM SYNC ADJUST : 00:00:00 [SET]

DAYLIGHT SAVING

- ON/OFF :
- CHANGE DAY : 1 / 1 0 : 0 [SET]
- TIMECODE OFFSET : + 0 : 0 : 0 [SET]
- RETURN DAY : 1 / 1 0 : 0 [SET]
- LEAP SECOND : 0 : 0 [SET]
- L-SYNC SETUP : DISABLE

GNSS OPTION

- ANTENNA POWER : OFF 3.3V 5V
- CABLE DELAY : 0 [msec] [SET]

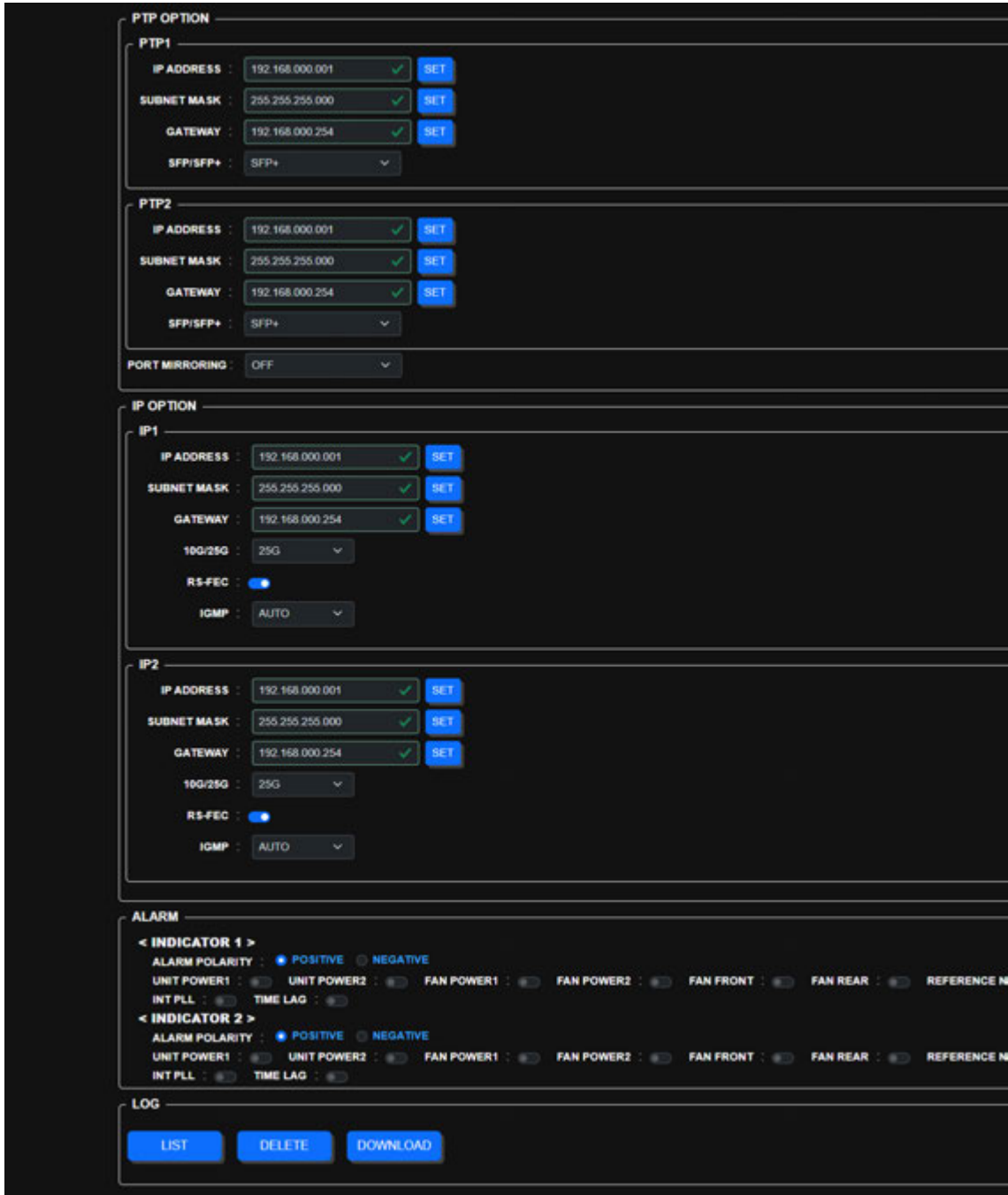

Figure 18-16 | SYSTEM screen

Table 18-10 | Description of SYSTEM screen

	Item	Description	Initial Value
UTILITY	LCD BACKLIGHT	Select the backlight setting.	ON
	KEY LOCK ON/OFF	Turn on or off the key lock of LT4670.	OFF
PRESET	RECALL	Load the selected preset.	-
	POWER ON RECALL	Select the number of the preset to be loaded at the time of startup.	OFF
	STORE	Save the current settings to the selected preset number.	PRESET 0
	COMMENT	Add a comment to the selected preset.	-
	COPY	Download the selected preset.	-

18 WEB BROWSER

	Item	Description	Initial Value
NETWORK	IP ADDRESS	The IP address of LT4670 is displayed.	-
	SUBNET MASK	The subnet mask of LT4670 is displayed.	-
	DEFAULT GATEWAY	The default gateway of LT4670 is displayed.	-
	MAC ADDRESS	The MAC address of LT4670 is displayed.	-
	SETUP	Select whether to enable or disable the SNMP function and which version to support.	DISABLE
	ENGINEID	The Engine ID of SNMP V3 is displayed.	-
	TRAP*	Turn the trap transmission destination on or off.	OFF
	MANAGER IP*	Set the IP address of the trap transmission destination.	000.000.000.000
	GET MIB	Download the MIB file.	-
	HTTP	The HTTP function settings is displayed. Fixed to ENABLE.	OFF
	NTP	Turn the NTP function on or off.	OFF
SERVER ADDRESS	Set the address of the NTP server.	000.000.000.000	
TIME MANAGEMENT	INTERNAL CLOCK ADJUST	Set the internal date and time of the instrument.	2000/01/01 00:00:00
	TIMEZONE OFFSET	Select the time zone.	UTC+9:00
	JAM SYNC	Turn the jam sync function on or off.	ON
	JAM SYNC ADJUST	Set when to reset the time code using the jam sync function.	00:00:00
	LEAP SECOND	Set the adjustment time to which to insert the leap second.	0:0:0
	L-SYNC SETUP	Select the L-SYNC setting.	DISABLE
DAYLIGHT SAVING	ON/OFF	Turn the daylight saving time on or off.	OFF
	CHANGE DAY	Set the date and time when the daylight saving time starts.	2000/01/01 00:00:00
	TIMECODE OFFSET	Set the daylight saving time offset.	+0:0:0
	RETURN DAY	Set the date and time when the daylight saving time ends.	2000/01/01 00:00:00
GNSS OPTION	ANTENNA POWER	Select the supply voltage to the GNSS antenna.	OFF
	CABLE DELAY	Set the delay correction value of the GNSS cable.	0
PTP OPTION	IP ADDRESS	Set the IP address of the PTP option.	192.168.000.001
	SUBNET MASK	Set the subnet mask of the PTP option.	255.255.255.000
	GATEWAY	Set the default gateway of the PTP option.	192.168.000.254
	SFP/SFP+	Select the SFP type.	SFP+
	PORT MIRRORING	Select the settings for port mirroring.	OFF
IP OPTION	IP ADDRESS	Set the IP address of the IP option.	192.168.000.001
	SUBNET MASK	Set the subnet mask of the IP option.	255.255.255.000

18 WEB BROWSER

	Item	Description	Initial Value
	GATEWAY	Set the default gateway of the IP option.	192.168.000.254
	10G/25G	Select the SFP type.	25G
	RS-FEC	Turn the RS-FEC on or off.	ON
	IGMP	Select the IGMP version.	AUTO
ALARM	ALARM POLARITY	Select the alarm polarity.	POSITIVE
	UNIT POWER*	Turn on or off the power supply unit alarm.	OFF
	FAN POWER*	Turn on or off the power supply unit fan alarm.	OFF
	FAN FRONT	Turn on or off the front fan unit alarm.	OFF
	FAN REAR	Turn on or off the rear fan unit alarm.	OFF
	REFERENCE NO SIGNAL	Turn on or off the alarm for no reference signal.	OFF
	REFERENCE STAY	Turn the stay-in-sync alarm on or off.	OFF
	GNSS ANTENNA	Turn the GNSS antenna alarm on or off.	OFF
	INT PLL	Turn the crystal alarm on or off.	OFF
	TIME LAG	Turn the time alarm on or off.	OFF
LOG	LIST	The log is displayed in a pop-up.	-
	DELETE	Delete the log.	-
	DOWNLOAD	Download the log in txt format.	-

19 MAINTENANCE

19.1 Calibration and Repair

This instrument has been carefully examined at the factory to ensure that its performance is in accordance with the standards. However, because of factors such as parts wearing out over time, the performance of the instrument may degrade. To ensure stable performance, we recommend that you have the instrument calibrated regularly. Also, if the instrument malfunctions, repairs are necessary. For repairs and calibration, contact your local Leader agent.

19.2 Replacement of Parts

To use this instrument for a long period of time, you need to replace its parts periodically. Replace parts when the specified "replacement interval" passes after the last replacement or when a malfunction occurs.

Parts are replaced by Leader or the designated service personnel. Contact your local Leader agent.

Table 19-1 | Replacement of parts

No.	Name	Model Number	Name	Replacement Interval	Quantity Used
1	Power Supply Unit	LT4670-SER11	POWER UNIT	5	1 or 2
2	Fan Unit (*1)	LP2184	FAN UNIT	5	1
3	Backup Battery	CR2450	Coin-type lithium battery	5	1

*1 There is a pair of fan units, one for the front panel and one for the rear panel.

19.2.1 Power Supply Unit Replacement

To replace the power supply unit, follow the procedure below.

If you have two power supply units installed, you can replace one of them with the power turned on.

The following procedure is an example in which you have two power supply units installed and replace POWER1 with the power of POWER2 on.

1 Disconnect the power cable from power supply unit POWER1.



Disconnect the power cable first and then remove the power supply unit. Failure to follow this procedure may result in electric shock.

2 Loosen the two screws.

The screws cannot be removed from the power supply unit even when they are loosened.

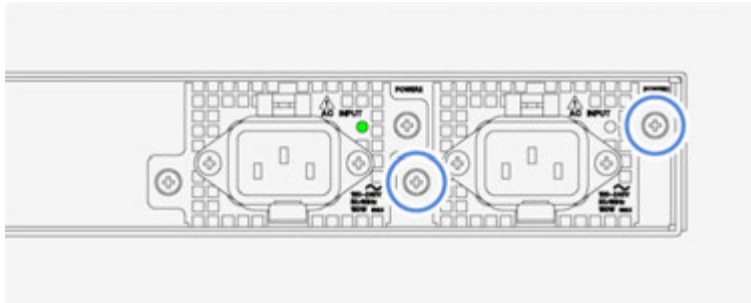

3 Pull up the lever, and then pull out the power supply unit.

First, pull up the lever at the bottom of the power supply unit.



Next, with the lever pulled up, pull out the power supply unit.

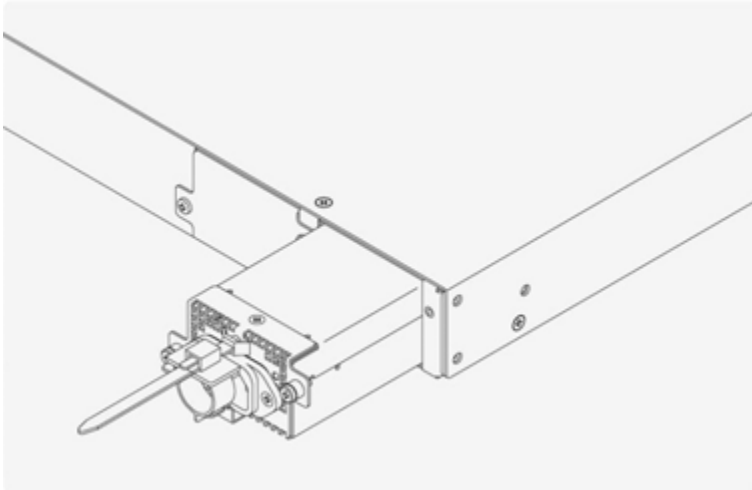

4 Insert a new power supply unit.

Insert the unit until it clicks into place.

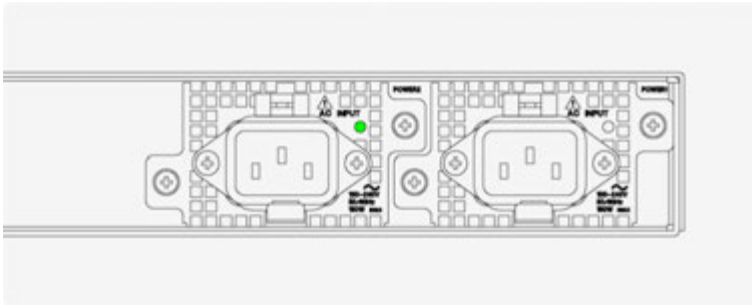

5 Tighten the two screws.

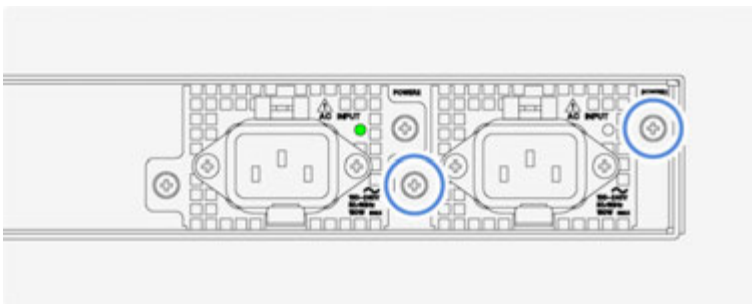

6 Connect the power cable.



Install the power supply unit first and then connect the power cable.
Failure to follow this procedure may result in electric shock.

- 7 Check that the LED on the power supply unit lights in green.

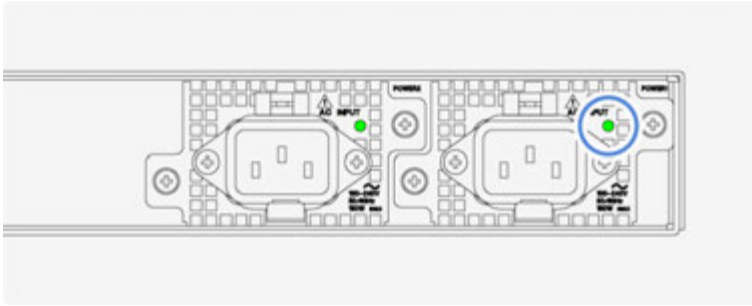

19.2.2 Front Fan Unit Replacement

The instrument has two fan units installed, one on the front panel and one on the rear panel. You can replace one of these fan units with the power on.

The following procedure is an example in which you replace the fan unit on the front panel with the power on.

There is a pair of fan units, one for the front panel and one for the rear panel. Note that these fan units are different in shape.



If you want to remove a fan unit with the power to the instrument on, follow the procedure below to stop the fan before removing the fan unit.

Failure to follow this procedure may result in injury.



When replacing a fan unit with the power on, install a new fan unit and start the fan quickly after stopping the existing fan. If the fan is stopped for an extended length of time, the internal temperature becomes very high, potentially damaging the instrument.

1 Stop the fan on the front panel.

Press the CONFIG key several times until SYSTEM CONFIG is displayed. Then, make the necessary setting by following the procedure below.

SYSTEM CONFIG > FAN MAINTENANCE > FRONT > OFF



2 Check that the fan on the front panel has stopped.

3 Remove the two screws on the front panel, and take off the fan cover.

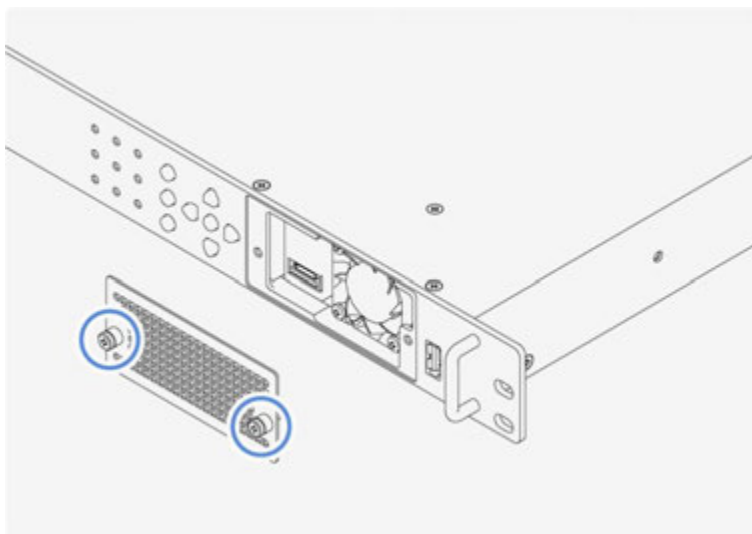

4 Loosen the two screws on the front panel, and pull out the fan unit.

The screws cannot be removed from the fan unit even when they are loosened.

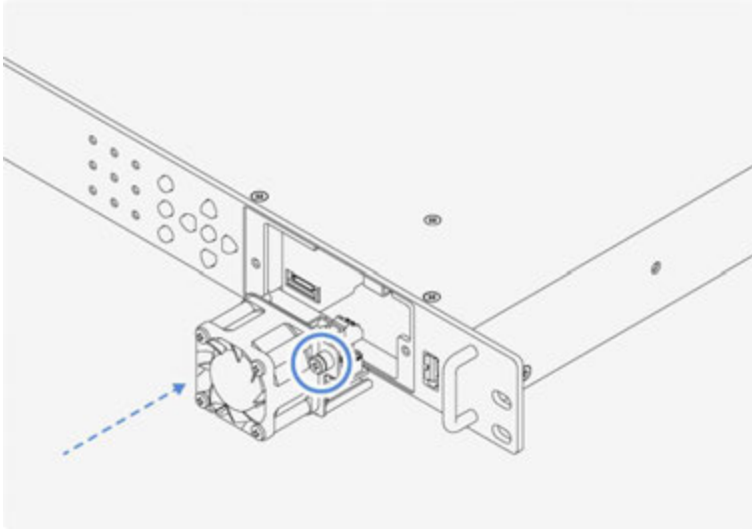

5 Insert a new fan unit, and tighten the two screws.

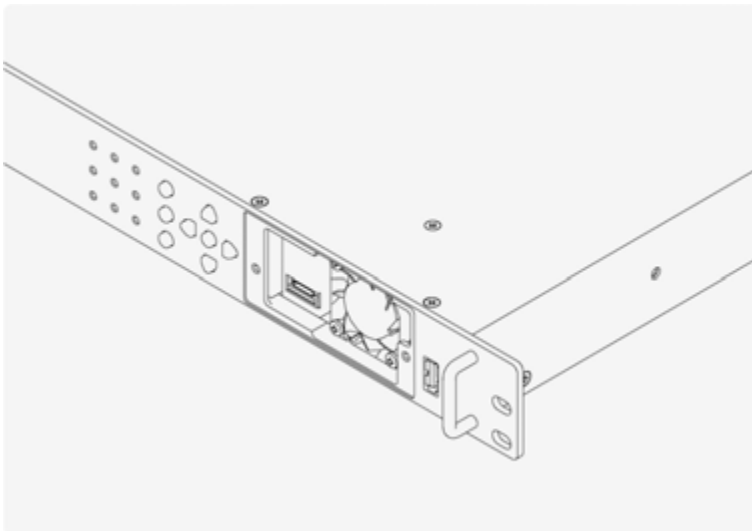

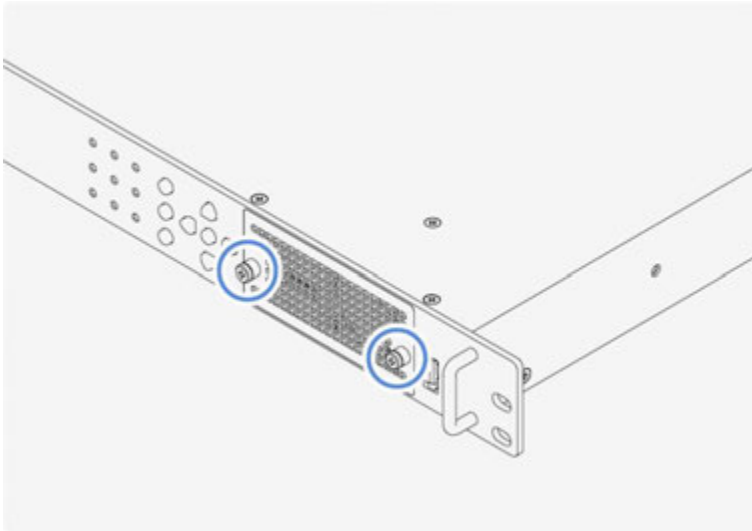
6 Attach the fan cover, and tighten the two screws.**7 Start the fan on the front panel.**

Press the CONFIG key several times until SYSTEM CONFIG is displayed. Then, make the necessary setting by following the procedure below.

SYSTEM CONFIG > FAN MAINTENANCE > FRONT > ON

```
2 . F A N   M A I N T E N A N C E   F R O N T
  ■ O N           □ O F F
```

8 Check that the fan on the front panel is operating.

19.2.3 Rear Fan Unit Replacement

The instrument has two fan units installed, one on the front panel and one on the rear panel. You can replace one of these fan units with the power on.

The following procedure is an example in which you replace the fan unit on the rear panel with the power on.

There is a pair of fan units, one for the front panel and one for the rear panel. Note that these fan units are different in shape.



If you want to remove a fan unit with the power to the instrument on, follow the procedure below to stop the fan before removing the fan unit.

Failure to follow this procedure may result in injury.



When replacing a fan unit with the power on, install a new fan unit and start the fan quickly after stopping the existing fan. If the fan is stopped for an extended length of time, the internal temperature becomes very high, potentially damaging the instrument.

1 Stop the fan on the rear panel.

Press the CONFIG key several times until SYSTEM CONFIG is displayed. Then, make the necessary setting by following the procedure below.

SYSTEM CONFIG > FAN MAINTENANCE > REAR > OFF



2 Check that the fan on the rear panel has stopped.

3 Loosen the two screws on the rear panel.

The screws cannot be removed from the fan unit even when they are loosened.

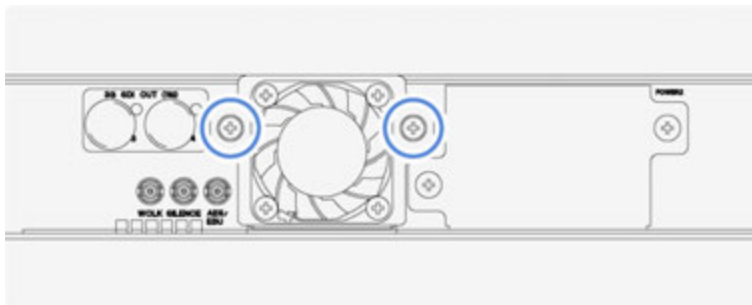

4 Pull out the fan unit.

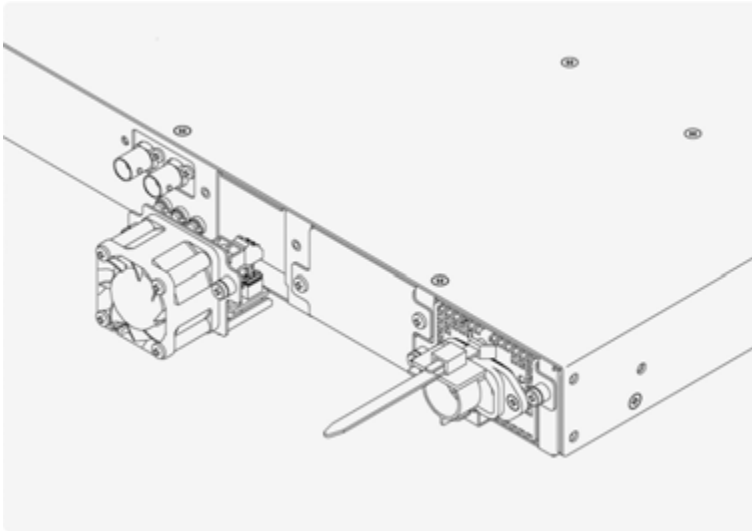

5 Insert a new fan unit, and tighten the two screws.

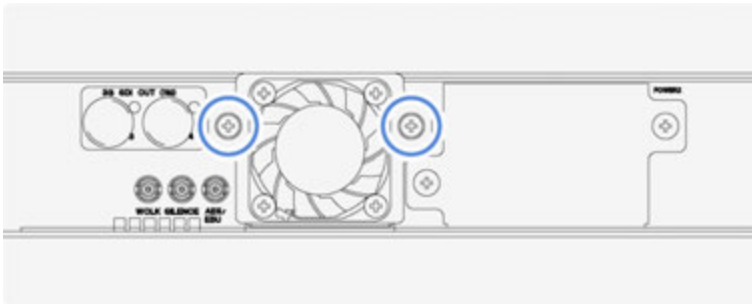

6 Start the fan on the rear panel.

Press the CONFIG key several times until SYSTEM CONFIG is displayed. Then, make the necessary setting by following the procedure below.

SYSTEM CONFIG > FAN MAINTENANCE > REAR > ON

2 . F A N M A I N T E N A N C E R E A R
■ O N □ O F F

7 Check that the fan on the rear panel is operating.

20 APPENDIX

20.1 List of Settings

The settings available when all options (SER01, SER02, SER03, SER04, SER11, and SER21) are added are listed below.

20.1.1 REFERENCE CONFIG Menu

Table 20-1 | REFERENCE CONFIG menu

Setting	Value	Initial Value
REFERENCE SOURCE	INTERNAL / GENLOCK FMT-AUTO / GENLOCK FMT-MANUAL / 10MHz CW / GNSS / PTP1 / PTP2 / PTP1/2	INTERNAL
GENLOCK FORMAT	NTSC BB / NTSC BB+REF / NTSC BB+ID / NTSC BB+REF+ID / PAL BB / PAL BB+REF / 525/59.94I / 525/59.94P / 625/50I / 625/50P / 1125/60I / 1125/59.94I / 1125/50I / 1125/30P / 1125/29.97P / 1125/25P / 1125/24P / 1125/23.98P / 1125/24PsF / 1125/23.98PsF / 1125/60P / 1125/59.94P / 1125/50P / 750/60P / 750/59.94P / 750/50P / 750/30P / 750/29.97P / 750/25P / 750/24P / 750/23.98P	NTSC BB (NTSC) PAL (PAL)
GENLOCK TIMING FINE	±100	0
GNSS SATELLITE	ALL / GPS / GLONASS / GALILEO / BDS / GPS+QZSS	ALL
RECOVERY MODE	AUTO / MANUAL	AUTO
AUTO SETTING	IMMEDIATE / FAST / SLOW	FAST
MANUAL SETTING	IMMEDIATE / FAST / SLOW	IMMEDIATE
IMMEDIATE MODE TIME	OFF / 5 - 30	5
TIME SOURCE	INTERNAL / LTC / LTC ST309 / VITC / VITC ST309 / NTP / GNSS / PTP1 / PTP2 / PTP1/2	INTERNAL

20.1.2 BLACK CONFIG Menu

Table 20-2 | BLACK CONFIG menu

Setting	Value	Initial Value
BLACK* FORMAT	NTSC BB / NTSC BB+REF / NTSC BB+ID / NTSC BB+REF+ID / NTSC BB+SETUP / NTSC BB+S+REF / NTSC BB+S+ID / NTSC BB+S+R+ID / PAL BB / PAL BB+REF / 525/59.94I / 525/59.94P / 625/50I / 625/50P / 1125/60I / 1125/59.94I / 1125/50I / 1125/30P / 1125/29.97P / 1125/25P / 1125/24P / 1125/23.98P / 1125/24PsF / 1125/23.98PsF / 1125/60P / 1125/59.94P / 1125/50P / 750/60P / 750/59.94P / 750/50P / 750/30P / 750/29.97P / 750/25P / 750/24P / 750/23.98P	NTSC BB (NTSC) PAL BB (PAL)
BLACK* TIMING F	±5	0
BLACK* TIMING V	±1124	0
BLACK* TIMING H	±4124	0
BLACK* VITC	ON / OFF	OFF

Setting	Value	Initial Value
BLACK* DROP FRAME	ON / OFF	ON
BLACK* LINE NUMBER	10 - 20 (NTSC) 6 - 22 (PAL)	14 (NTSC) 19 (PAL)
BLACK* OUTPUT	ENABLE / DISABLE	ENABLE
BLACK* LINKED TO PTP*	ENABLE / DISABLE	DISABLE
BLACK2 EQUAL TO BLACK1	ON / OFF	OFF
BLACK3 EQUAL TO BLACK1	ON / OFF	OFF
BLACK4 EQUAL TO BLACK1	ON / OFF	OFF
BLACK5 EQUAL TO BLACK1	ON / OFF	OFF
BLACK6 EQUAL TO BLACK1	ON / OFF	OFF

20.1.3 AUDIO CONFIG Menu

Table 20-3 | AUDIO CONFIG menu

Setting	Value	Initial Value
AES/EBU CH* FREQ	SILENCE / 400Hz / 800Hz / 1kHz	1kHz
AES/EBU CH* LEVEL	-60 - 0	-20
AES/EBU CH* CLICK	OFF / 1sec / 2sec / 4sec	OFF
CH2 EQUAL TO CH1	ON / OFF	OFF
AES/EBU RESOLUTION	20BIT / 24BIT	20BIT
AES/EBU EMPHASIS	50/15 / CCITT / OFF	OFF
AES/EBU TIMECODE	ON / OFF	OFF
AES/EBU TIMING	±511	0
LIPSYNC(SYNC TO SDI1)	ON / OFF	OFF
EQUAL TO AES/EBU	ON / OFF	OFF
SILENCE RESOLUTION	20BIT / 24BIT	20BIT
SILENCE TIMING	±511	0
WCLK TIMING	±511	0

20.1.4 LTC CONFIG Menu

Table 20-4 | LTC CONFIG menu

Setting	Value	Initial Value
LTC*	ON / OFF	OFF
LTC* FORMAT	30 / 29.97 / 25 / 24 / 23.98	29.97 (NTSC) 25 (PAL)
LTC* TIMING FRAME	±29	0
LTC* TIMING BIT	±39	0
LTC* OFFSET	±23:59:59	+00:00:00
LTC* DROP FRAME	ON / OFF	ON
LTC2 EQUAL TO LTC1	ON / OFF	OFF
LTC3 EQUAL TO LTC1	ON / OFF	OFF

20.1.5 CW/1PPS CONFIG Menu

Table 20-5 | CW/1PPS CONFIG menu

Setting	Value	Initial Value
CW/1PPS OUTPUT	CW / 1PPS	CW

20.1.6 SDI CONFIG Menu (SER02/SER04)

Table 20-6 | SDI CONFIG menu

Setting	Value	Initial Value
SDI FREQUENCY GROUP	59.94Hz / 60/50Hz	59.94Hz (NTSC) 60/50Hz (PAL)
SDI* SYSTEM	3840x2160 12G / 4096x2160 12G / 3840x2160 3G-A / 4096x2160 3G-A / 3840x2160 3G-B-DL / 4096x2160 3G-B-DL / 1280x 720 3G-A / 1920x1080 3G-A / 1920x1080 3G-B-DL / 1280x 720 HD / 1920x1080 HD / 720x 487 SD / 720x 576 SD	1920x1080 HD
SDI* STRUCTURE	422(YCbCr)10-bit / 422(YCbCr)12-bit / 444(RGB)10-bit / 444(RGB)12-bit	422(YCbCr) 10-bit
SDI* RATE	59.94P / 29.97P / 23.98P / 29.97PsF / 23.98PsF / 59.94I / 60P / 50P / 30P / 25P / 24P / 30PsF / 25PsF / 24PsF / 60I / 50I / 48P / 47.95P	59.94I (NTSC) 50I (PAL)
SDI* 0H TIMING	SERIAL / LEGACY	SERIAL
SDI* TIMING V	±1124	0
SDI* TIMING H	±4124	0
SDI* PATTERN (FIX PATTERN)	100% / 75% / MULTI 100% / MULTI 75% / MULTI (+I) / SMPTE / EBU / BBC / FLAT FIELD 100% / FLAT FIELD 50% / FLAT FIELD 0% / RED FIELD 100% / GREEN FIELD 100% / BLUE FIELD 100% / CHECK FIELD	100%
SDI* PATTERN (USER PATTERN)	INT1 - INT4	INT 1
SDI* COMPONENT	ON / OFF	All ON
SDI* SAFETY AREA	ON / OFF	All OFF
SDI* SCROLL	ON / OFF	OFF
SDI* SCROLL V-SPEED	±256	0
SDI* SCROLL H-SPEED	±256	0
SDI* PATTERN CHANGE	ON / OFF	OFF
SDI* PATTERN CHG SPEED	+1 - +255	+1
SDI* ID CHARACTER	ON / OFF	OFF
SDI* ID SET	◀ !"#%&'()*+,-./0123456789:;<=>?@ABCDEFGHIJKLMNOPS TUVWXYZ[¥]^_→← (up to 20 characters)	LT4670◀
SDI* ID V-POSI	0 - 100	0
SDI* ID H-POSI	0 - 100	0
SDI* ID SIZE	x1 / x2 / x4 / x8	x1
SDI* ID LEVEL	100% / 75%	100%

20 APPENDIX

Setting	Value	Initial Value
SDI* ID BLINK	ON / OFF	OFF
SDI* ID BLINK ON TIME	1 - 9	1
SDI* ID BLINK OFF TIME	1 - 9	1
SDI* ID SCROLL	ON / OFF	OFF
SDI* ID SCROLL SPEED	±256	0
SDI* ID TRANSPARENCY	ON / OFF	OFF
SDI* LOGO	ON / OFF	OFF
SDI* LOGO SELECT	INT1 - INT4	INT 1
SDI* LOGO V-POSI	0 - 100	0
SDI* LOGO H-POSI	0 - 100	0
SDI* LOGO TRANSPARENCY	ON / OFF	OFF
SDI* LOGO TRANSPARENCY	0 - 255	16
SDI* MOVING BOX	ON / OFF	OFF
SDI* BOX COLOR	WHITE / YELLOW / CYAN / GREEN / BLUE / RED / MAGENTA / BLACK	WHITE
SDI* BOX V-SPEED	LOW / MIDDLE / HIGH	MIDDLE
SDI* BOX H-SPEED	LOW / MIDDLE / HIGH	MIDDLE
SDI* BOX V-SIZE	SIZE1 / SIZE2 / SIZE3 / SIZE4 / SIZE5	SIZE2
SDI* BOX H-SIZE	SIZE1 / SIZE2 / SIZE3 / SIZE4 / SIZE5	SIZE2
SDI* CIRCLE	ON / OFF	OFF
SDI* CIRCLE LEVEL	100% / 75%	100%
SDI* CIRCLE SIZE	90% / 80% / 70%	90%
SDI* BLINK	ON / OFF	OFF
SDI* BLINK ON TIME	1 - 9	1
SDI* BLINK OFF TIME	1 - 9	1
SDI* TIMECODE	ON / OFF	OFF
SDI* TIMECODE V-POSI	0 - 100	0
SDI* TIMECODE H-POSI	0 - 100	0
SDI* TIMECODE SIZE	x1 / x2 / x4 / x8	x1
SDI* TIMECODE LEVEL	100% / 75%	100%
SDI* TIMECODE TRANS	ON / OFF	OFF
SDI* LIPSYNC	ON / OFF	OFF
SDI* EMB AUDIO ON/OFF	ON / OFF	All ON
SDI* G*/CH* FREQ	SILENCE / 400Hz / 800Hz / 1kHz	1kHz
SDI* G*/CH* LEVEL	-60 - 0	-20
SDI* G*/CH* CLICK	OFF / 1sec / 2sec / 4sec	OFF
SDI* G1/CH* EQUAL CH1	ON / OFF	OFF
SDI* G2/CH* EQUAL CH5	ON / OFF	OFF
SDI* G3/CH* EQUAL CH9	ON / OFF	OFF
SDI* G4/CH* EQUAL CH13	ON / OFF	OFF
SDI* G* RESOLUTION	20BIT / 24BIT	20BIT
SDI* G* EMPHASIS	50/15 / CCITT / OFF	OFF
SDI* G2 EQUAL TO G1	ON / OFF	OFF

Setting	Value	Initial Value
SDI* G3 EQUAL TO G1	ON / OFF	OFF
SDI* G4 EQUAL TO G3	ON / OFF	OFF
SDI* ANC ATC-LTC	ON / OFF	OFF
SDI* ANC ATC-VITC	ON / OFF	OFF
SDI* DROP FRAME	ON / OFF	ON
SDI* OUTPUT	ENABLE / DISABLE	ENABLE
SDI* LINKED TO PTP*	ENABLE / DISABLE	DISABLE
SDI2 EQUAL TO SDI1	ON / OFF	OFF
SDI3 EQUAL TO SDI1	ON / OFF	OFF
SDI4 EQUAL TO SDI3	ON / OFF	OFF

20.1.7 PTP CONFIG Menu (SER03)

Table 20-7 | PTP CONFIG menu (when the instrument is a PTP leader)

Setting	Value	Initial Value
PTP1 MODE	ENABLE LEADER / DISABLE LEADER	ENABLE LEADER
PTP2 MODE	ENABLE LEADER / DISABLE LEADER	DISABLE LEADER
PTP* BMCA SETUP	ENABLE / ENABLE ONLY ONCE / DISABLE	ENABLE
PTP* PROFILE TYPE	ST2059 / AES67 / GENERAL	ST2059
PTP1 DOMAIN	0 - 255	127 (ST2059) 0 (AES67/ GENERAL)
PTP2 DOMAIN	0 - 255	126 (ST2059) 0 (AES67/ GENERAL)
PTP* COMMUNICATION	MIXED SMPTE / MIXED SMPTE w/o NE / UNICAST / MULTICAST	MIXED SMPTE w/o NE
PTP* ANNOUNCE INT	0.125s / 0.25s / 0.5s / 1s / 2s / 4s / 8s / 16s	0.25s (ST2059) 2s (AES67/ GENERAL)
PTP* SYNC INTERVAL	0.0078s / 0.015s / 0.0312s / 0.0625s / 0.125s / 0.25s / 0.5s / 1s / 2s / 4s / 8s / 16s	0.125s (ST2059/ AES67) 1s (GENERAL)
PTP* ANNOUNCE	2 - 10	3
PTP* PRIORITY*	0 - 255	128
PTP* STEP	ONE STEP / TWO STEP	ONE STEP
PTP* ST2059 FRAME	23.98 / 24 / 25 / 29.97 / 30 / 47.95 / 48 / 50 / 59.94 / 60 / 71.92 / 72 / 100 / 119.9 / 120	29.97
PTP* ST2059 DROP FRAME	ENABLE / DISABLE	ENABLE
PTP* ST2059 CFID	ENABLE / DISABLE	ENABLE
PTP* DELAY MECH	END TO END / PEER TO PEER	END TO END

Table 20-8 | PTP CONFIG menu (when the instrument is a PTP follower)

Setting	Value	Initial Value
PTP* MODE	FOLLOWER	FOLLOWER
PTP* PROFILE TYPE	ST2059 / AES67 / GENERAL	ST2059
PTP1 DOMAIN	0 - 255	127 (ST2059) 0 (AES67/ GENERAL)
PTP2 DOMAIN	0 - 255	126 (ST2059) 0 (AES67/ GENERAL)
PTP* COMMUNICATION	MIXED SMPTE / MIXED SMPTE w/o NE / UNICAST / MULTICAST	MULTICAST
PTP* ANC DESIR INT	0.125s / 0.25s / 0.5s / 1s / 2s / 4s / 8s / 16s	0.25s (ST2059) 2s (AES67/ GENERAL)
PTP* ANC REQD INT	0.125s / 0.25s / 0.5s / 1s / 2s / 4s / 8s / 16s	2s (ST2059) 16s (AES67/ GENERAL)
PTP* SYN DESIR INT	0.0078s / 0.015s / 0.0312s / 0.0625s / 0.125s / 0.25s / 0.5s / 1s / 2s / 4s / 8s	0.125s (ST2059) 1s (AES67) 2s (GENERAL)
PTP* SYN REQD INT	0.0078s / 0.015s / 0.0312s / 0.0625s / 0.125s / 0.25s / 0.5s / 1s / 2s / 4s / 8s	0.5s (ST2059) 2s (AES67) 8s (GENERAL)
PTP* DELAY MSG INT	0.0078s / 0.015s / 0.0312s / 0.0625s / 0.125s / 0.25s / 0.5s / 1s / 2s / 4s / 8s / 16s	0.125s (ST2059) 1s (AES67/ GENERAL)
PTP* DLY DESIR INT	0.0078s / 0.015s / 0.0312s / 0.0625s / 0.125s / 0.25s / 0.5s / 1s / 2s / 4s / 8s / 16s	0.125s (ST2059/ AES67) 2s (GENERAL)
PTP* DLY REQD INT	0.0078s / 0.015s / 0.0312s / 0.0625s / 0.125s / 0.25s / 0.5s / 1s / 2s / 4s / 8s / 16s	0.5s (ST2059) 2s (AES67) 0.125Hz (GENERAL)
PTP* ANNOUNCE	2 - 10	3
PTP* DELAY MECH	END TO END / PEER TO PEER	END TO END
PTP* AMT ADDRESS*	000.000.000.000 - 255.255.255.255	000.000.000.000
PTP* ASYM DELAY	±20.000	0.000

20.1.8 IP CONFIG Menu (SER04)

Table 20-9 | IP CONFIG Menu

Setting	Value	Initial Value
IP TYPE	ST2022-6 / ST2110	ST2110
IP* OUTPUT	ON / OFF	ON
IP* STREAM* VID	ON / OFF	ON
IP* STREAM* VID PAYLD	96 - 127	96
IP* STREAM* VID VLAN	ON / OFF	OFF

Setting	Value	Initial Value
IP* STREAM* VID VLAN	1 - 4094	1
IP* STREAM* VID DSCP	ON / OFF	OFF
IP* STREAM* VID DSCP	0 - 63	0
IP1 STREAM1 VID DSTIP	000.000.000.000 - 255.255.255.255	239.000.000.001
IP1 STREAM2 VID DSTIP	000.000.000.000 - 255.255.255.255	239.000.000.002
IP1 STREAM3 VID DSTIP	000.000.000.000 - 255.255.255.255	239.000.000.003
IP1 STREAM4 VID DSTIP	000.000.000.000 - 255.255.255.255	239.000.000.004
IP2 STREAM1 VID DSTIP	000.000.000.000 - 255.255.255.255	239.000.000.005
IP2 STREAM2 VID DSTIP	000.000.000.000 - 255.255.255.255	239.000.000.006
IP2 STREAM3 VID DSTIP	000.000.000.000 - 255.255.255.255	239.000.000.007
IP2 STREAM4 VID DSTIP	000.000.000.000 - 255.255.255.255	239.000.000.008
IP* STREAM* VID DSTPT	0 - 65535	5004
IP* STREAM* AUD	ON / OFF	ON
IP* STREAM* AUD PAYLD	96 - 127	97
IP* STREAM* AUD VLAN	ON / OFF	OFF
IP* STREAM* AUD VLAN	1 - 4094	1
IP* STREAM* AUD DSCP	ON / OFF	OFF
IP* STREAM* AUD DSCP	0 - 63	0
IP* STREAM* AUD MODE	ST2110-30 / ST2110-31	ST2110-30
IP* STREAM* AUD TIME	1ms / 125us	1ms
IP1 STREAM1 AUD DSTIP	000.000.000.000 - 255.255.255.255	239.000.002.001
IP1 STREAM2 AUD DSTIP	000.000.000.000 - 255.255.255.255	239.000.002.002
IP1 STREAM3 AUD DSTIP	000.000.000.000 - 255.255.255.255	239.000.002.003
IP1 STREAM4 AUD DSTIP	000.000.000.000 - 255.255.255.255	239.000.002.004
IP2 STREAM1 AUD DSTIP	000.000.000.000 - 255.255.255.255	239.000.002.005
IP2 STREAM2 AUD DSTIP	000.000.000.000 - 255.255.255.255	239.000.002.006
IP2 STREAM3 AUD DSTIP	000.000.000.000 - 255.255.255.255	239.000.002.007
IP2 STREAM4 AUD DSTIP	000.000.000.000 - 255.255.255.255	239.000.002.008
IP* STREAM* AUD DSTPT	0 - 65535	5004
IP* STREAM* ANC	ON / OFF	ON
IP* STREAM* ANC PAYLD	96 - 127	100
IP* STREAM* ANC VLAN	ON / OFF	OFF
IP* STREAM* ANC VLAN	1 - 4094	1
IP* STREAM* ANC DSCP	ON / OFF	OFF
IP* STREAM* ANC DSCP	0 - 63	0
IP1 STREAM1 ANC DSTIP	000.000.000.000 - 255.255.255.255	239.000.003.001
IP1 STREAM2 ANC DSTIP	000.000.000.000 - 255.255.255.255	239.000.003.002
IP1 STREAM3 ANC DSTIP	000.000.000.000 - 255.255.255.255	239.000.003.003
IP1 STREAM4 ANC DSTIP	000.000.000.000 - 255.255.255.255	239.000.003.004
IP2 STREAM1 ANC DSTIP	000.000.000.000 - 255.255.255.255	239.000.003.005
IP2 STREAM2 ANC DSTIP	000.000.000.000 - 255.255.255.255	239.000.003.006
IP2 STREAM3 ANC DSTIP	000.000.000.000 - 255.255.255.255	239.000.003.007
IP2 STREAM4 ANC DSTIP	000.000.000.000 - 255.255.255.255	239.000.003.008
IP* STREAM* ANC DSTPT	0 - 65535	5004

20.1.9 SYSTEM CONFIG Menu

Table 20-10 | SYSTEM CONFIG menu

Setting	Value	Initial Value
LCD BACKLIGHT	ON / AUTO OFF / OFF	ON
COMMENT INPUT	◀0123456789ABCDEFGHIJKLMN OPQRSTUVWXYZabcdefghijklmnopqrstuvwxyz!#\$%&'()+,-.;=@[]^_{ } (up to 17 characters)	◀
POWER ON RECALL	OFF / 0 - 9	OFF
NETWORK SETUP	ENABLE / DISABLE	ENABLE
IP ADDRESS	000.000.000.000 - 255.255.255.255	192.168.000.001
SUBNET MASK	000.000.000.000 - 255.255.255.255	255.255.255.000
HTTP SETUP	ENABLE / DISABLE	DISABLE
WEB BROWSER	ENABLE / DISABLE	DISABLE
DEFAULT GATEWAY	000.000.000.000 - 255.255.255.255	000.000.000.000
SNMP SETUP	DISABLE / V2C / V3	DISABLE
SNMP TRAP *	ENABLE / DISABLE	DISABLE
SNMP MANAGER IP *	000.000.000.000 - 255.255.255.255	000.000.000.000
READ COMMUNITY	◀0123456789ABCDEFGHIJKLMN OPQRSTUVWXYZabcdefghijklmnopqrstuvwxyz (up to 15 characters)	LDRUser◀ (V2C) LDuser (V3)
WRITE COMMUNITY	◀0123456789ABCDEFGHIJKLMN OPQRSTUVWXYZabcdefghijklmnopqrstuvwxyz (up to 15 characters)	LDRAdm◀ (V2C) LDadm (V3)
TRAP COMMUNITY	◀0123456789ABCDEFGHIJKLMN OPQRSTUVWXYZabcdefghijklmnopqrstuvwxyz (up to 15 characters)	LDRUser◀ (V2C) LDuser (V3)
NTP SETUP	ENABLE / DISABLE	DISABLE
NTP SERVER ADDRESS	000.000.000.000 - 255.255.255.255	000.000.000.000
INTERNAL CLOCK ADJUST	2000/01/01 00:00:00 - 2037/12/31 23:59:59	Current time
TIMEZONE OFFSET	-12:00 / -11:00 / -10:00 / -09:00 / -08:00 / -07:00 / -06:00 / -05:00 / -04:30 / -04:00 / -03:00 / -02:00 / -01:00 / +00:00 / +01:00 / +02:00 / +03:00 / +04:00 / +04:30 / +05:00 / +05:30 / +06:00 / +07:00 / +08:00 / +09:00 / +09:30 / +10:00 / +11:00 / +12:00 / -09:30 / -03:30 / +03:30 / +06:30 / +10:30 / +11:30	+09:00
JAM SYNC	ON / OFF	ON
JAM SYNC ADJUST	00:00:00 - 23:59:59	00:00:00
DAYLIGHT SAVING	ON / OFF	OFF
CHANGE DAY	01/01 00:00:00 - 12/31 23:59:00	01/01 00:00:00
TIMECODE OFFSET	±23:59:59	+00:00:00
RETURN DAY	01/01 00:00:00 - 12/31 23:59:00	01/01 00:00:00
SCHEDULED TIME	00:00:00 - 23:59:00	00:00:00
L-SYNC SETUP	DISABLE / PRIMARY / BACKUP	DISABLE
ANTENNA POWER	OFF / 3.3V / 5V	OFF
CABLE DELAY	±100	0
PTP* IP ADDRESS	000.000.000.000 - 255.255.255.255	192.168.000.001
PTP* SUBNET MASK	000.000.000.000 - 255.255.255.255	255.255.255.000
PTP* GATEWAY	000.000.000.000 - 255.255.255.255	192.168.000.254
PTP* SFP/SFP+	SFP / SFP+	SFP+

20 APPENDIX

Setting	Value	Initial Value
PTP PORT MIRRORING	OFF / PTP1 to PTP2 / PTP2 to PTP1	OFF
IP* IP ADDRESS	000.000.000.000 - 255.255.255.255	192.168.000.001
IP* SUBNET MASK	000.000.000.000 - 255.255.255.255	255.255.255.000
IP* DEFAULT GATEWAY	000.000.000.000 - 255.255.255.255	192.168.000.254
IP* 10G/25G	10G / 25G	25G
IP* RS-FEC	OFF / ON	ON
IP* IGMP	V2 / V3 / AUTO	AUTO
ALARM POLARITY	POSITIVE / NEGATIVE	POSITIVE
UNIT POWER*	ENABLE / DISABLE	DISABLE
FAN POWER*	ENABLE / DISABLE	DISABLE
FAN FRONT	ENABLE / DISABLE	DISABLE
FAN REAR	ENABLE / DISABLE	DISABLE
INT PLL	ENABLE / DISABLE	DISABLE
TIME LAG	ENABLE / DISABLE	DISABLE
REFERENCE NO SIGNAL	ENABLE / DISABLE	DISABLE
REFERENCE STAY	ENABLE / DISABLE	DISABLE
GNSS ANTENNA	ENABLE / DISABLE	DISABLE
FORMAT SETTING	NTSC / PAL	NTSC
USB DEVICE	ENABLE / DISABLE	ENABLE
FAN MAINTENANCE FRONT	ON / OFF	ON
FAN MAINTENANCE REAR	ON / OFF	ON

20.2 Release Notes

This manual is written for firmware version 2.2.

To view the firmware version, select "STATUS > CONFIG > SYSTEM > FIRMWARE VERSION".

Ver. 2.2

- [SER04] Supports IP 4 stream output.
- [SER04] All functions are supported in the browser.

Ver. 2.1

Minor changes

Ver. 2.0

- [SER04] Browsers support SDI only.

Ver. 1.9

- [LT4670] Fixed so that an alarm can be obtained via SNMP when the time source and local time are out of sync.
- [SER02] Added a feature to make the background of the text display transparent for the ID character and time code display.
- [SER02] Changed the initial value of 0H TIMING from LEGACY to SERIAL.
- [SER04] 25G-IP/12G-SDI TSG option support.

Ver. 1.8

- [LT4670] Added a function to automatically detect the VITC superimposed line and display the line number when REFERENCE SOURCE is BB genlock.
- [LT4670] Added a function that allows you to optionally set the VITC superimposition line on the BLACK output.
- [LT4670] Improved the browser's SET button to be displayed in 3D to show when it has been operated.
- [LT4670] Added LOG function to browser.
- [LT4670] Added ETHERNET MAC address display to the browser's SYSTEM CONFIG screen.
- [LT4670] Supports SNMP V3 in browser.
- [LT4670] Modified to blink the TIME LED to orange if the time obtained from TIME SOURCE and the internal time differ by more than 1 second.
- [LT4670] Modified to display the INTERNAL CLOCK ADJUST menu when TIME SOURCE is set to INTERNAL.
- [SER01] Added LEAP-SECOND display to the browser STATUS screen.
- [SER02] Added support for user patterns and color logos in the browser.
- [SER03] Added display of LEADER ID, PHASE LAG, and STEP settings to the browser STATUS screen.
- [SER03] PTP MAC address display to the browser's PTP CONFIG screen.

Ver. 1.7

Minor changes

Ver. 1.6

Minor changes

Ver. 1.5

- | | |
|----------|-----------------------|
| [LT4670] | SNMP (v3) support. |
| [SER02] | User pattern support. |
| [SER02] | Color logo support. |

Ver. 1.4

- | | |
|----------|---------------------|
| [LT4670] | SNMP (v2c) support. |
|----------|---------------------|

Ver. 1.3

- | | |
|---------------|---|
| [LT4670] | Web Browser support. |
| [SER02/SER03] | Added a mode to stop BLACK and SDI output in conjunction with BMCA auto switching. |
| [SER03] | Added dual follower mode. |
| [SER03] | Added Added manual recovery mode after BMCA auto switching. |
| [SER03] | Improved to shorten the time until PTP packets are output when PTP mode is ENABLE MASTER. |
| [SER03] | Added logging of BMCA switching operations. |

Ver. 1.2

- | | |
|----------|-------------|
| [LT4670] | New release |
|----------|-------------|

Leader Electronics Corporation

Aug. 20, 2024 Ver. 7 (Firmware Ver. 2.2)