

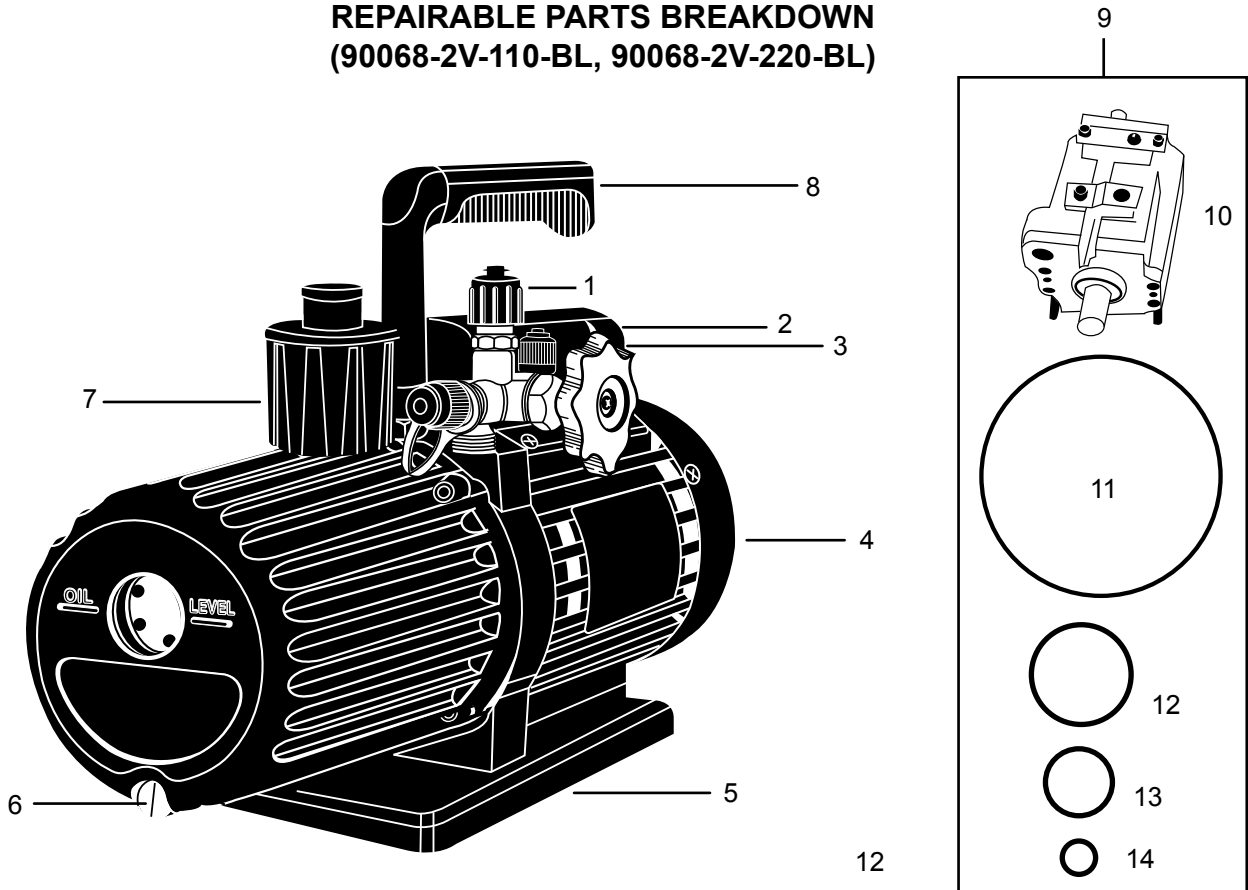

Mastercool[®]
"World Class Quality"

**8 CFM, TWO STAGE
 VACUUM PUMP**

**REPAIRABLE PARTS BREAKDOWN
 (90068-2V-110-BL, 90068-2V-220-BL)**



REF. #	DESCRIPTION	PART #
1.	T-FITTING	90056-18-R
2.	110V POWER CORD 220V POWER CORD	6535-110 6535-220
3.	ON/OFF SWITCH	90066-B-SW
4.	FAN COVER	90068-B-FC
5.	BASE PLATE	90068-B-BP
6.	OIL DRAIN FITTING WITH O-RINGS	90062-B-28
7.	EXHAUST FITTING	90068-10-B
8.	HANDLE	90068-B-H
9.	CARTRIDGE KIT	90168-B
10.	CARTRIDGE	90068B-03
11.	SHAFT SEAL	90068B-06
12.	PUMP COVER GASKET	90068B-13
13.	O-RING ON HOUSING	90066B-22
14.	SMALL O-RING ON HOUSING	90066B-23