



# Operating Instructions

**Easyloc RxTx**  
**Easyloc RxTx +**  
**Easyloc Basic**  
**Easyloc CAM**





## **Consultation with Megger**

The present system manual has been designed as an operating guide and for reference. It is meant to answer your questions and solve your problems in as fast and easy a way as possible. Please start with referring to this manual should any trouble occur.

In doing so, make use of the table of contents and read the relevant paragraph with great attention. Furthermore, check all terminals and connections of the instruments involved.

Should any question remain unanswered or should you need the help of an authorized service station, please contact:

Megger Limited

© Megger

All rights reserved. No part of this handbook may be copied by photographic or other means unless Megger have before-hand declared their consent in writing. The content of this handbook is subject to change without notice. Megger cannot be made liable for technical or printing errors or shortcomings of this handbook. Megger also disclaims all responsibility for damage resulting directly or indirectly from the delivery, supply, or use of this matter.

## Terms of Warranty

Megger accept responsibility for a claim under warranty brought forward by a customer for a product sold by Megger under the terms stated below.

Megger warrant that at the time of delivery Megger products are free from manufacturing or material defects which might considerably reduce their value or usability. This warranty does not apply to faults in the software supplied. During the period of warranty, Megger agree to repair faulty parts or replace them with new parts or parts as new (with the same usability and life as new parts) according to their choice.

This warranty does not cover wear parts, lamps, fuses, batteries and accumulators.

Megger reject all further claims under warranty, in particular those from consequential damage. Each component and product replaced in accordance with this warranty becomes the property of Megger.

All warranty claims versus Megger are hereby limited to a period of 12 months from the date of delivery. Each component supplied by Megger within the context of warranty will also be covered by this warranty for the remaining period of time but for 90 days at least.

Each measure to remedy a claim under warranty shall exclusively be carried out by Megger or an authorized service station.

This warranty does not apply to any fault or damage caused by exposing a product to conditions not in accordance with this specification, by storing, transporting, or using it improperly, or having it serviced or installed by a workshop not authorized by Megger. All responsibility is disclaimed for damage due to wear, will of God, or connection to foreign components.

For damage resulting from a violation of their duty to repair or re-supply items, Megger can be made liable only in case of severe negligence or intention. Any liability for slight negligence is disclaimed.

Since some states do not allow the exclusion or limitation of an implied warranty or of consequential damage, the limitations of liability described above perhaps may not apply to you.

## Table of contents

<b>1</b>	<b>Notes on safety</b> .....	<b>1-6</b>
<b>2</b>	<b>Technical data</b> .....	<b>2-7</b>
<b>3</b>	<b>System overview</b> .....	<b>3-10</b>
3.1	<i>Easyloc Rx</i> receiver .....	3-11
3.2	<i>Easyloc Tx</i> transmitter .....	3-13
<b>4</b>	<b>Using the location system</b> .....	<b>4-14</b>
4.1	Connection and initial use of the <i>Easyloc Tx</i> transmitter .....	4-14
4.1.1	Transmitter signals and modes of operation .....	4-14
4.1.2	Options for direct and inductive signal coupling .....	4-15
4.1.2.1	Direct coupling on cables and pipes .....	4-15
4.1.2.2	Coupling using special connection accessories.....	4-17
4.1.2.3	Inductive signal coupling .....	4-18
4.1.2.4	Signal coupling in non-metallic pipes .....	4-19
4.1.3	Initial use of the transmitter.....	4-20
4.2	Locating lines with the <i>Easyloc Rx</i> receiver .....	4-21
4.2.1	Changing the system settings.....	4-21
4.2.1.1	Depth measurement settings (not available for <i>Easyloc Basic</i> ).....	4-21
4.2.1.2	Changing the receiving frequency.....	4-22
4.2.2	The basics of locating lines with the receiver .....	4-23
4.2.2.1	Modes of operation for the receiver .....	4-23
4.2.2.2	Regulating the sensitivity level to match the reception signal strength .....	4-24
4.2.2.3	Handling the receiver and locating the line .....	4-25
4.2.3	General site surveying .....	4-26
4.2.4	Determining the direction of a line.....	4-27
4.2.5	Determining the depth of a line (not available for <i>Easyloc Basic</i> ).....	4-28
4.2.6	Masking-Out Lines .....	4-31
4.2.7	Functional test of the receiver.....	4-32
<b>5</b>	<b>Maintenance</b> .....	<b>5-34</b>

## 1 Notes on safety

Safety precautions	<p>This handbook contains basic instructions for the initial use and operation of the <i>Easyloc RxTx</i>. For this reason, it is important to ensure that the handbook is available to personnel authorised and trained to use the device at all times. Any personnel who will be using the devices should read the handbook thoroughly. The manufacturer shall not be liable for any injury or damage to personnel or property, which arise due to non-observance of the safety precautions contained in this handbook.</p> <p>Country specific standards and regulations should also be observed!</p>
Working with products from Megger	<p>It is important to observe the general electric regulations of the particular country in which the device will be setup and used, as well as current national regulations for accident prevention and current company internal regulations (work, operating and safety regulations).</p> <p>The use of original accessories ensures system safety and reliable operation. The use of other parts is not permitted and shall result in termination of the warranty.</p>
Repair and maintenance	<p>Repair and maintenance work may only be performed by Megger or authorised service partners. Megger recommends having the system inspected and maintained at a Megger service centre once a year.</p> <p>Megger also offers its customers on-site service. Please contact your respective service centre as needed.</p>
Lines without a signal	<p>The <i>Easylox Rx</i> can only locate lines which emit a signal. Therefore it is important to always exercise extreme caution when digging, even if no lines have been found.</p>
Electromagnetic interference	<p>Please note that electromagnetic fields in the vicinity of the receiver may negatively affect the sensitivity of the device.</p>

## 2 Technical data

Receiver (all versions) The following parameters are specified for all Versions of the receiver:

Parameter	Value
<b>Power supply</b>	10 x IEC R6 / AA cell / Mignon
<b>Operating time</b>	40 hours (for intermittent use with alkaline batteries, 20 °C)
<b>Temperature range</b>	in accordance with IEC / EN 60068-1
<ul style="list-style-type: none"> <li>• Operation</li> <li>• Storage</li> </ul>	-20 °C bis +55 °C -30 °C bis +70 °C
<b>Weight</b>	2.5 kg
<b>Dimensions (W x H x D)</b>	99 x 660 x 252 mm
<b>Type of protection</b>	in accordance with IEC / EN 60529
Dust and water protected	IP 67 from the lower edge of the receiver up to the lower edge of the battery compartment, and IP 56 for all parts above this delineation

Receiver (Rx, Rx+ and Basic) The following parameters are specified for the Rx, Rx+ and the Basic version of the receiver:

Parameter	Value	
<b>Frequency ranges</b>		
<ul style="list-style-type: none"> <li>• Range 1: <b>radio</b></li> <li>• Range 2: <b>power network</b></li> <li>• Range 3: <b>transmitter</b></li> </ul>	15 kHz to 23 kHz 50 Hz / 60 Hz 100 Hz / 120 Hz (only Rx +) 32.768 kHz 8.44 kHz (only Rx +)	
<b>Sensitivity</b>	at a depth of 1 m	
<ul style="list-style-type: none"> <li>• Range 1: <b>radio</b></li> <li>• Range 2: <b>power network</b></li> <li>• Range 3: <b>transmitter</b></li> </ul>	>20 µA >7 mA >5 µA (at 32.768 kHz) >40 µA (bei 8.44 kHz)	
<b>Depth determination</b> (not available for <i>Easyloc Basic</i> )	<b>... of a conductor</b>	<b>... of a probe</b>
<ul style="list-style-type: none"> <li>• Depth range</li> <li>• Resolution</li> <li>• Accuracy (assuming interference-free signal transmission)               <ul style="list-style-type: none"> <li>- Range 1: <b>radio</b></li> <li>- Range 2: <b>power network</b></li> <li>- Range 3: <b>transmitter</b></li> </ul> </li> </ul>	0.3 m ... 5 m (12 in ... 16 ft) 0.1 m ±20 % ±20 % ±5 % (up to 2 m), ±20 % (2 m ... 5 m)	0.3 m ... 7 m (12 in ... 23 ft) 0.1 m ±10 % (up to 2 m) ±20 % (2 m ... 7 m)

Receiver (CAM) The following parameters are specified for the CAM version of the receiver:

Parameter	Value	
<b>Frequency ranges</b> <ul style="list-style-type: none"> <li>• Range 1: <b>power network</b></li> <li>• Range 2: <b>transmitter</b></li> <li>• Range 3: <b>transmitter</b></li> </ul>	50 Hz / 60 Hz 512 Hz / 640 Hz 32.768 kHz	
<b>Sensitivity</b> 50 Hz / 60 Hz 32.768 kHz 512 Hz, 640 Hz	at a depth of 1 m >7 mA >5 µA >100 µA	
<b>Depth determination</b> (not available for <i>Easyloc Basic</i> )  <ul style="list-style-type: none"> <li>• Depth range</li> <li>• Resolution</li> <li>• Accuracy (assuming interference-free signal transmission) <ul style="list-style-type: none"> <li>- Range 1: <b>power network</b></li> <li>- Ranges 2 and 3: <b>transmitter</b></li> </ul> </li> </ul>	<b>... of a conductor</b>	<b>... of a probe</b>
	0.3 m ... 5 m (12 in ... 16 ft)  0.1 m  ±20 % ±5 % (up to 2 m), ±20 % (2 m ... 5 m)	0.3 m ... 7 m (12 in ... 23 ft)  0.1 m  ±10 % (up to 2 m) ±20 % (2 m ... 7 m)

Transmitter *Easyloc Tx* The following parameters are specified for the *Easyloc Tx* transmitter:

Parameter	Value
<b>Transmitted power</b> (switchable) 32.768 kHz 8.44 kHz (only Tx+)	0.1 W / 0.5 W 0.5 W / 2 W
<b>Frequency</b>	32.768 kHz
<b>Power supply</b>	6 x IEC R20 / D cell / Mono
<b>Operating time</b>	40 hours (for intermittent use with alkaline batteries, 20 °C)
<b>Temperature range</b> <ul style="list-style-type: none"> <li>• Operation</li> <li>• Storage</li> </ul>	in accordance with DIN EN 60068-1 -20 °C bis +55 °C -30 °C bis +70 °C
<b>Weight</b>	1.7 kg
<b>Dimensions (W x H x D)</b>	260 x 255 x 140 mm
<b>Type of protection</b> Dust and water protected	in accordance with IEC / EN 60529 IP 54
<b>Measurement category</b>	in accordance with IEC / EN 61010-1 CAT II / CAT III 440 V CAT IV 300 V



Limit values and standards

The following limit values and standards are applicable for the *Easyloc RxTx* location system:

<b>Parameter</b>	<b>Value</b>
<b>Sinusoidal vibrations</b> Peak acceleration Frequency	in accordance with IEC / EN 60068-2-6 20 m/s <sup>2</sup> 10 Hz ... 150 Hz
<b>Free fall</b> Max. height (packaged)	in accordance with IEC / EN 60068-2-32 80 cm (weight up to 10 kg)
<b>Relative humidity</b>	max. 93 % at 30 °C
<b>Atmospheric pressure</b>	max. 4 kPa
<b>Protection class</b> (meets IEC / EN 61140)	III

### 3 System overview

**Intended use** The *Easyloc RxTx* location system is designed for the uncomplicated and user-friendly determination of the location, orientation and depth of metallic lines (e.g. cable and pipe lines).

It can be used to probe areas for unknown lines or for locating specific lines.

**Versions of the receiver** In addition to the standard version *Easyloc Rx*, there are three more versions of the receiver with the following features:

- **Easyloc Rx +** - with an extended frequency selection
- **Easyloc CAM** - exclusively used for location of probes (e.g. camera probes) in specific frequency ranges (32.768 kHz, 512 Hz, 640 Hz)
- **Easyloc Basic** - version without depth measurement

Whenever the term *Easyloc RX* is used without further qualification in the course of this document, the described functionality applies for all versions of the receiver.

**Features** The *Easyloc RxTx* is distinguished by the following features:

- Robust construction for use in poor weather and in harsh environments
- Simple, user-friendly operation concept with a minimum number of controls
- Reliable battery status indicator

**Scope of delivery** The *Easyloc RxTx* location system is supplied in three different configurations. The following table shows the scope of delivery for the various configurations:

Configuration	<i>Easyloc RxTx</i> system (incl. transmitter and receiver)	<i>Easyloc Rx</i> receiver set	<i>Easyloc Tx</i> transmitter set
<b>Equipment</b>			
<i>Easyloc Rx</i> receiver	1	1	-
<i>Easyloc Tx</i> transmitter	1	-	1
Measurement cable (2 m)	2	-	2
Alligator clip	2	-	2
Earthing spike	1		1
IEC R6 / AA cell / Mignon	10	10	-
IEC R20 / D cell / Mono	6	-	6
Nylon bag	1	-	-

**Accessories** Megger offers a wide range of accessories for the *Easyloc RxTx* system which can be ordered through your distributor:

- **Transmitter clamp** (100 mm) for the inductive coupling of a signal into exposed lines
- **House connection set** for transmission of the house connection lines through the mains power supply, telephone or cable TV connection
- **FlexiSonde**, emitting fibreglass cable for locating non-metallic pipes
- **Probe**, battery powered mini-transmitter for locating non-metallic pipes
- **Nylon bag**, exclusively for the receiver

### 3.1 Easyloc Rx receiver

Features The *Easyloc Rx* receiver is distinguished by the following features:

- **passive** signal modes for locating lines without the *Easyloc Tx* transmitter
- **active** signal modes for locating lines / probes when used together with a transmitter
- Automatic depth determination when used together with a transmitter (not available for *Easyloc Basic*)
- Semi-automatic depth estimation in passive signal modes (not available for *Easyloc Basic*)
- Sensitivity level can be adjusted automatically or manually
- Lighted display for use in dim environments

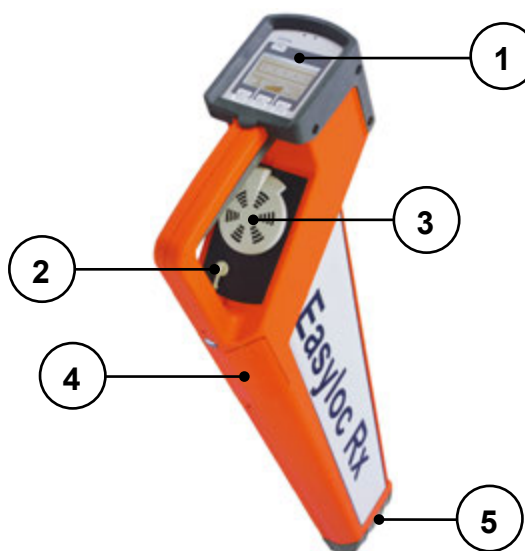

Components of the receiver The following illustration shows the components of the *Easyloc Rx* receiver:

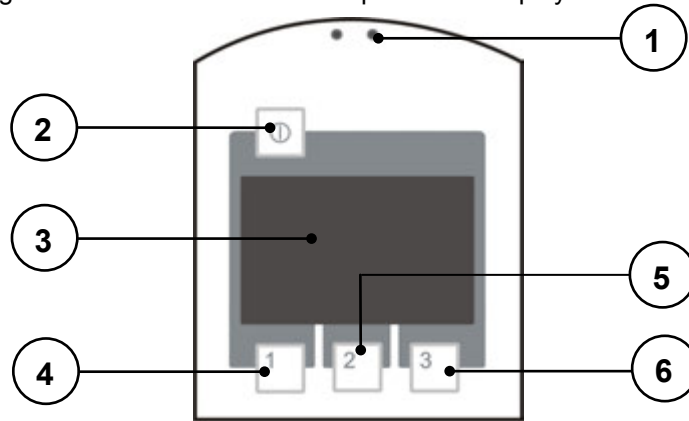

Item	Description
1	<b>Control panel with display</b> (see page 3-12)
2	<p><b>Speaker with volume control</b> The speaker plays back various acoustic signals (e.g. beeps with modulating pitch relative to the signal strength).</p>  <p>When the receiver is switched on, the volume is set at a standard level. The receiver will only start with the volume at a different level if the volume has been manually increased before switching off the receiver.</p>
3	<p><b>Headphone jack</b> To connect headphones with a 3.5 mm plug connector.</p>
4	<b>Battery compartment</b>
5	<p><b>Floor cap</b> This replaceable floor cap serves to protect the housing.</p>

Display and controls The following illustration shows the control panel and display for the *Easyloc Rx*:



Control element	Description
1	<p><b>Light sensor</b> Light sensitive photo cells to automatically regulate the display lighting.</p> <p> The display lighting can be manually activated for one minute by briefly covering the light sensor.</p>
2	<p><b>On/Off switch</b> By quickly pressing this button the <i>Easyloc Rx</i> can be switched on or off.</p> <p> The <i>Easyloc Rx</i> will switch off automatically if no functions are carried out within 7 minutes of being switched on.</p>
3	<p><b>Display</b> Provides a visual indication of reception strength, line depth, mode of operation, battery status and menu items.</p>
4	<p><b>Button 1</b> Depending on the status of the system, this button is used to:</p> <ul style="list-style-type: none"> <li>Manually decrease reception sensitivity</li> <li>Start measuring depth (not available for <i>Easyloc Basic</i>)</li> </ul>
5	<p><b>Button 2</b> Depending on the status of the system, this button is used to:</p> <ul style="list-style-type: none"> <li>Adjust reception sensitivity</li> <li>Start measuring depth (not available for <i>Easyloc Basic</i>)</li> </ul>
6	<p><b>Button 3</b> Depending on the status of the system, this button is used to:</p> <ul style="list-style-type: none"> <li>Select the mode of operation / receiving frequency</li> <li>Manually increase reception sensitivity</li> </ul>

### 3.2 Easyloc Tx transmitter

Features The *Easyloc Tx* transmitter is distinguished by the following features:

- **Inductive coupling** of the signal using the integrated antenna or transmitter clamp
- **Direct (galvanic) coupling** of the signal using connected equipment (such as the measurement cable and power socket adapter)
- Two-step adjustable transmission power
- Selectable signal output – continuous or pulsed

Transmitter control panel The following illustration shows the control panel of the *Easyloc Tx*:



Control element	Description
1	<b>Battery status indicator</b> When the battery status LED blinks in red, the batteries need to be replaced.
2	<b>On/Off switch</b> By quickly pressing this button the <i>Easyloc Tx</i> can be switched on or off. All appropriate LED's blink when the <i>Easyloc Tx</i> is on, depending on operating function.
3	<b>“Signal type” button</b> This button is used to switch between continuous and pulsed signal output.
4	<b>Jacks for connecting accessories</b> These jacks are used to create a direct galvanic connection with the target line or to create a connection using a special connection set (e.g. <i>EasyClamp</i> transmitter clamp or house connection set).
5	<b>“Mode” button</b> This button is used to switch between <b>inductive</b> and <b>direct</b> signal coupling (galvanically or via transmitter clamp).
6	<b>“Signal strength” button</b> This button is used to select one of two signal strength levels (see Technical Data).



## 4 Using the location system

### 4.1 Connection and initial use of the *Easyloc Tx* transmitter

#### 4.1.1 Transmitter signals and modes of operation

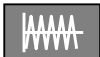

Signal characteristics

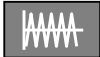
The type and strength of the output signal can be configured by the user as follows to meet the specific requirements of either the line to be located or the site to be surveyed:

Symbol	Signal type
	<p><b>Pulsed signal</b> As it is more easily distinguished from other signals, the pulsed signal is helpful for locating when there is interference within the frequency range of the transmitter. This also helps to conserve the batteries.</p> <p>Depth measurements cannot be made using a pulsating signal!</p>
	<p><b>Continuous signal</b> This signal type has to be activated before a taking a depth measurement.</p>
<b>Signal strength</b>	
	<p><b>Low output signal strength</b> Low signal strength conserves the batteries.</p>
	<p><b>High output signal strength</b></p>



Mode of operation

The *Easyloc Tx* can be used in the following modes:

Symbol	Mode of operation
	<p><b>Induction</b> In this mode of operation the transmitter's signal is emitted through the integrated antenna and is thereby inductively coupled with any metallic lines located within a certain radius.</p>
	<p><b>Direct connection</b> In this mode of operation the signal is directly coupled with a metallic line via the measurement cable which is connected to the jacks on the front panel of the transmitter. Transmitter clamps, alligator clips or power socket adapters (for example) may be used to connect the measurement cable to the lines.</p>

Frequency selection  
(only Tx +)

The Tx + version does have two additional buttons for frequency selection:

Symbol	Frequency
	<b>32.768 kHz</b>
	<b>8.44 kHz</b>

## 4.1.2 Options for direct and inductive signal coupling

### 4.1.2.1 Direct coupling on cables and pipes

**Introduction** Direct galvanic coupling is practical for cables which are easily accessible and free of current. The method of connection is dependent upon the position and nature of the lines (e.g. insulation, cable conduit, accessibility of the cable ends).

Direct coupling presents a reliable option for selective cable location, as the signal can be coupled onto a specific cable with virtually no loss.

The following illustration shows an example of direct coupling:

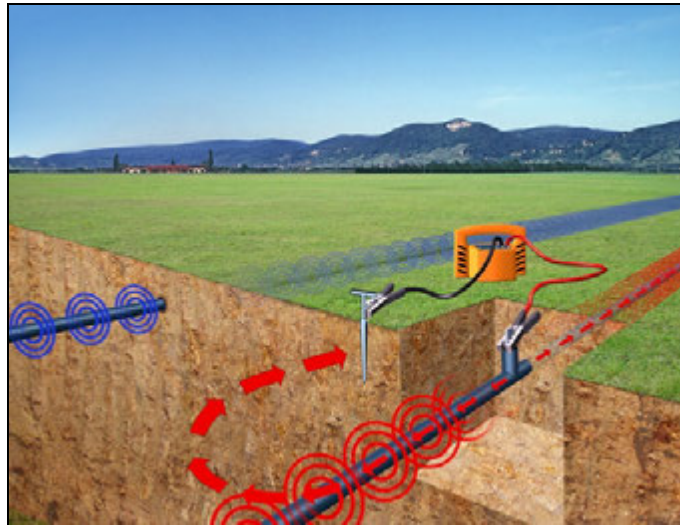









**WARNING**

If the lines being located are energised, the following five safety precautions should be taken before connecting the transmitter:

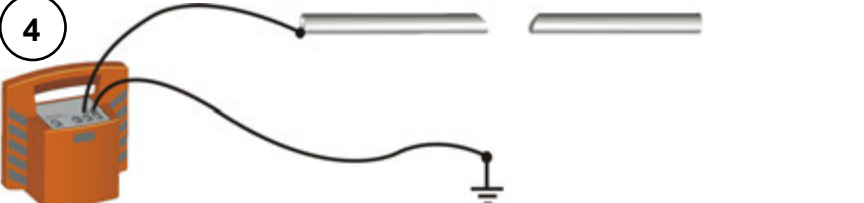
#### Five safety precautions

1. Disconnect power
2. Secure against reconnection
3. Check for presence of current
4. Make earth connection and short circuit
5. Cover or block access to adjacent components which are energised

Application	Principle of coupling
<p><b>Single-wire lines or pipes (with or without insulation against earthing)</b> The distance between the earth spike and the ends of the connected lines should be as great as possible.</p> <p> There is a danger of the return current flowing through the earth into adjacent lines, which could result in their path being followed.</p>	<p><b>1</b></p> 
<p><b>Single-wire cable with metallic screen and earthing insulation</b> Short circuit between internal conductor and screen at the end of the cable with earthing at the beginning and end of the cable as well.</p> <p> If the earth connections made are unfavourable, the current in the internal conductor and the return current in the screen will cancel each other out. Under certain circumstances this can prevent the cable from being detected. Alternatively, a connection without an earth connection can also be made.</p>	<p><b>2</b></p> 
<p><b>Multiple-wire cable (internal conductor connected or disconnected) with metallic screen and earthing insulation</b> Same application as in example 1.</p>	<p><b>3</b></p> 
<p><b>Metallic conduit (with or without insulation against earthing)</b> The earth spike and the conduit should be spaced as far apart as possible. Under certain circumstances, optimum positioning of the earth spike may require several attempts.</p>	<p><b>4</b></p> 
<p><b>If a return wire is available</b> The spacing of the return wire should correspond to at least 10 times the depth of the line being located.</p>	<p><b>5</b></p> 
<p><b>Pair of wires (with or without screen) with short circuit at the end of the cable</b></p> <p> For twisted pairs of wires (with a length of lay of the twist greater or equal to the laying depth), the orientation of the cable can be easily determined.</p> <p>Adjacent lines which are <b>horizontal</b> to each other ⇒ Minimum of the reception signal</p> <p>Lines situated on top of each other <b>vertically</b> ⇒ Maximum of the reception signal</p>	<p><b>6</b></p> 



### 4.1.2.2 Coupling using special connection accessories

**Coupling via adapter cable** The signal from the transmitter can be directly coupled into plug sockets, antenna connections and telephone jacks with the aid of a suitable adapter cable. In doing so, it is not necessary to disconnect the lines.

Megger offers a ready made house connection set for this type of coupling (also see section 3 *System overview*, page 3-10).



**Coupling via transmitter clamp** The transmitter signal can be coupled onto easily accessible cables with the aid of a transmitter clamp. In doing so, it is **not** necessary to disconnect the cables.

By ensuring that the transmitter clamp is completely closed around the cable, only a small leakage field will be generated. This can significantly reduce the unwanted coupling of the signal onto neighbouring lines.

Ideally the cables will be grounded at both ends; but even if they are not grounded at one end, selecting high power transmitter output will assist easy location.



## 4.1.2.3 Inductive signal coupling

Inductive signal coupling For lines which are not easily accessible, the signal from the transmitter has to be inductively coupled via the integrated antenna.

The inductive coupling of the signal is highly recommended if unknown lines are to be located (e.g. at a construction site).

To determine the orientation of a specific line, the transmitter has to be positioned directly above the presumed line as shown in the following illustration. In doing so, the best signal coupling is achieved when the handle of the transmitter housing is aligned with the presumed lay of the line.

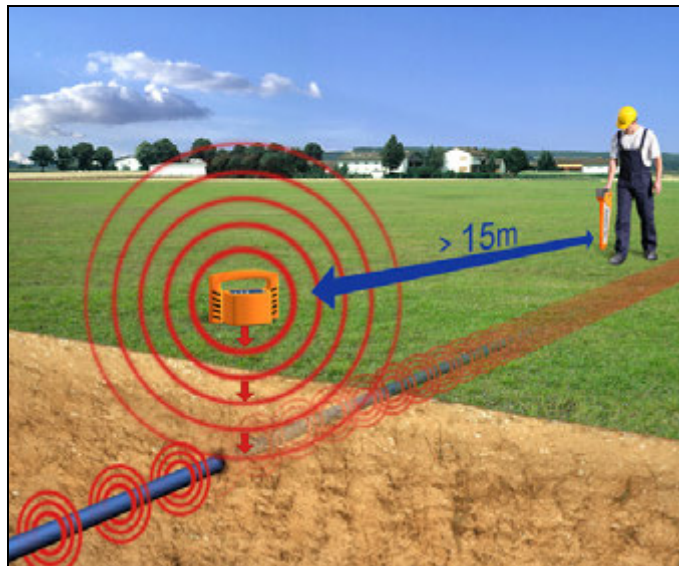

When locating lines using inductive signal coupling, the following guidelines should be observed:

- As the signal can be coupled onto other conductors when using inductive coupling, direct coupling of the transmitter is always preferable when locating lines selectively. Inductive signal coupling should only be opted for in cases where the line being located is not easily accessible (see section 4.1.2.1 *Direct coupling on cables and pipes* and section 4.1.2.2 *Coupling using special connection accessories*).
- While taking measurements, make sure that a distance of at least 15 m is always maintained between the receiver and transmitter in order to prevent the coupling of the transmitter's signal through the air.
- When searching for unknown lines at a site, the position of the transmitter has to be changed at least once by one metre and 90°.
- It is also a good idea to position the transmitter at visible cable ends such as at distribution boxes or light poles.

#### 4.1.2.4 Signal coupling in non-metallic pipes

Signal coupling in non-metallic pipes

With the aid of the *FlexSonde GOK50-R* the transmitter's signal can be transmitted through non-metallic pipes, as shown in the picture below:



Alternatively, any other active probe (e.g. a camera probe) with adequate transmitting frequency (see Technical Data) can be located using the receiver. For a detailed description, please refer to the manual of the respective product.

Both the *FlexSonde GOK50-R* and an active probe are available as accessories for the *Easyloc RxTx* location system (see section *System overview*, page 3-10).

When locating non-metallic pipes, the following guidelines should be observed:

- Contrary to the line location, a probe location has to be performed in perpendicular position to the probe, i.e., the handle of the receiver has to be hold at right angle to the probe.
- Practice locating the probe or *FlexSonde* head before pushing it into the drain or duct.
- Strongest signal will be detected when the receiver is above and perpendicular to the probe (as shown in the picture).

Specifics of probe location





The signal transmitted by the probe results in three signal maxima on the ground surface level. Typically, there is a smaller maximum in front of the actual signal maximum and one behind it.

For this reason, it should be always evaluated whether there are further signal maxima in front of or behind the detected signal maximum. An accurate depth determination can only be performed directly above the actual (highest) signal maximum.

If the receiver is operated in automatic sensitivity level adjustment mode, these lower signal maxima are usually masked-out.

## 4.1.3 Initial use of the transmitter

How to proceed Follow the steps listed below in order to prepare the transmitter to search for lines in conjunction with the receiver:

Step	Action
1	Connect the transmitter to the line to be located using the most suitable method, or place the transmitter on the site to be searched (see section 4.1.2 <i>Options for direct and inductive signal coupling</i> ).
2	Press  to switch on the transmitter.
3	Select the desired output signal using the  and  buttons (see section 4.1 <i>Connection and initial use of the Easyloc Tx transmitter</i> , page 4-14).  A green LED indicates that the respective setting is active.
4	Select the desired mode of operation using the  button (see section 4.1 <i>Connection and initial use of the Easyloc Tx transmitter</i> , page 4-14).  <b>Result:</b> In <b>Direct</b> mode, an LED next to the  symbol indicates how good the connection is to the connected line: <ul style="list-style-type: none"> <li>• <b>Green blinking:</b> good (low-resistance) connection</li> <li>• <b>Alternating red and green:</b> sufficient connection</li> <li>• <b>Red blinking:</b> poor/no (high-resistance) connection</li> </ul>
5	As described in chapter 4.2 <i>Locating lines with the Easyloc Rx receiver</i> use the <i>Easyloc Rx</i> to locate metallic conductors.

## 4.2 Locating lines with the *Easyloc Rx* receiver

### 4.2.1 Changing the system settings

#### 4.2.1.1 Depth measurement settings (not available for *Easyloc Basic*)

Proceed as follows to change the settings:

Step	Action
1	Press and hold the <input type="button" value="1"/> button.
2	Briefly press the <input type="button" value="0"/> button while continuing to hold down the <input type="button" value="1"/> button until an audible signal is heard. The following image is display: <div style="text-align: center; margin: 10px 0;">  </div>
3	Now one of the following depth measurement processes may be selected by pressing the <input type="button" value="1"/> button: <ul style="list-style-type: none"> <li data-bbox="651 976 1497 1037"> <input type="button" value="Pipe icon"/> Select this symbol if you want to determine the depth of a probe which has been pushed into a non-metallic pipe.             </li> <li data-bbox="651 1048 1497 1108"> <input type="button" value="Line icon"/> Select this symbol if you want to determine the depth of a line, the signal of an active transmitter is coupled onto.             </li> </ul> Now a unit of length used by the system may be selected by pressing the <input type="button" value="3"/> button: <ul style="list-style-type: none"> <li data-bbox="655 1223 1262 1272"> <input type="button" value="??'"/> <b>Foot (ft)</b> will be used as the unit for length.             </li> <li data-bbox="655 1294 1283 1344"> <input type="button" value="?.?m"/> <b>Metre (m)</b> will be used as the unit for length.             </li> </ul>
4	Press the <input type="button" value="2"/> button to save the settings. The changes will remain in effect even after the receiver is switched off and back on again.

## 4.2.1.2 Changing the receiving frequency

Proceed as follows to change the receiving frequency of operation modes with more than one possible frequency:

Step	Action																
1	Select the operation mode in which you want to change the frequency by pressing the <b>3</b> button while the receiver is switched on.																
2	Switch the receiver off.																
3	Press and hold the <b>3</b> button.																
4	<p>Briefly press the <b>1</b> button while continuing to hold down the <b>3</b> button until an audible signal is heard. The selectable frequencies are now visible in the display.</p> <table border="1"> <thead> <tr> <th></th> <th>Range 1</th> <th>Range 2</th> <th>Range 3</th> </tr> </thead> <tbody> <tr> <td><i>Rx / Basic</i></td> <td></td> <td></td> <td></td> </tr> <tr> <td><i>Rx +</i></td> <td></td> <td></td> <td></td> </tr> <tr> <td><i>CAM</i></td> <td></td> <td></td> <td></td> </tr> </tbody> </table>		Range 1	Range 2	Range 3	<i>Rx / Basic</i>				<i>Rx +</i>				<i>CAM</i>			
	Range 1	Range 2	Range 3														
<i>Rx / Basic</i>																	
<i>Rx +</i>																	
<i>CAM</i>																	
5	Use the <b>1</b> and <b>3</b> buttons to switch between the frequencies. The active setting is marked with a black background.																
6	Press the <b>2</b> button to save the settings. The changes will remain in effect even after the receiver is switched off and back on again.																



## 4.2.2 The basics of locating lines with the receiver

### 4.2.2.1 Modes of operation for the receiver

Basics of passive line location

If a *Easyloc Tx* transmitter is not available, a site can also be probed by means of passive line location.

The *Easyloc Rx* receiver is capable of detecting radio signals in the frequency range between 15 kHz to 23 kHz as well as power signals in the frequency range between 50 / 60 Hz.

The following pictures illustrate how each of the signals couple onto conductors buried in the ground:



Modes of operation for the receiver

The two options explained above for passive location together with the options of active location with a transmitter or a probe transmitting a signal with an appropriate frequency result in the following modes of operation:

Symbol	Mode of operation
	<b>RADIO</b> For locating cables which are carrying VLF reradiated radio signals. (not available for <i>Easyloc CAM</i> )
	<b>POWER GRID</b> For locating mains power supply cables, through which current with a grid frequency is flowing.
	<b>TRANSMITTER</b> For locating cables or pipes, onto which the signal from an active transmitter is coupled. The figure indicates the currently selected frequency which has to correspond to the frequency of the transmitter.
	<b>PROBE</b> For locating a probe, pig transmitter or camera probe. The figure indicates the currently selected frequency which has to correspond to the frequency of the probe.

## 4.2.2.2 Regulating the sensitivity level to match the reception signal strength

Display of reception signal strength and sensitivity

Reception signal strength and sensitivity are shown in the following segments of the display:

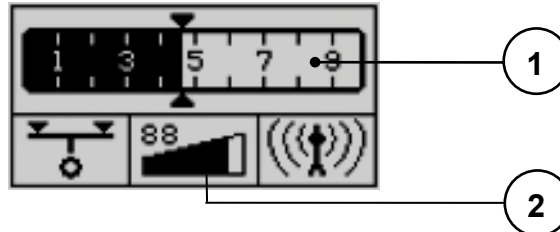

Segment	Mode of operation
1	<p><b>Reception signal display bargraph</b></p> <p>The strength of the reception signal is represented by this bargraph scale. These are relative values which are based on the sensitivity level set in the receiver.</p> <p>The triangles (▲▼) above and below the scale are a visual marker for maximum values. They move towards the right as long as the signal strength increases and continue in this direction until it either levels off or decreases. The maximum marker remains in this position for 3 seconds and thus provides the user with a helpful visual aid for determining the maximum signal strength.</p>
2	<p><b>Sensitivity display (gain level in %)</b></p> <p>The sensitivity level set in the receiver (which coincides with the total spectrum which the receiver is capable of processing) is represented by this scale. The higher the level of sensitivity is set, the more capable the receiver is of detecting weaker signals.</p> <p>The numeric display above the bars shows the utilisation factor as a percent.</p>

Regulating the sensitivity level

Should the scale for reception signal strength bargraph provide virtually no indication, or the display is completely utilised, either a manual or automatic adjustment of the sensitivity level has to be made.

To start an **automatic** sensitivity level adjustment, the [2] button has to be pressed once. The sensitivity level of the receiver will be automatically adjusted so that the strength of the signal currently being received will be optimally displayed (fill half of the scale).

To start a **manual** sensitivity level adjustment, the [2] button has to be pressed for about 2 seconds. The following indicator will appear in the display:

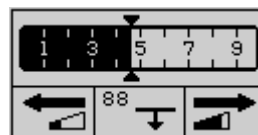

Now the sensitivity of the receiver can be decreased by one percent by pressing the [1] button, or increased by one percent by pressing the [3] button. This process can be accelerated by holding down the respective button.

To exit the manual sensitivity level adjustment menu, the [2] button has to be pressed for two seconds. By pressing the button only short, the depth measurement process will begin (see section 4.2.5 *Determining the depth of a line*).



### 4.2.2.3 Handling the receiver and locating the line

Basics for handling the receiver

In order to be able to determine the position and orientation of a metallic conductor, the following rules should be internalised and applied when locating lines.

As shown in the following illustration, the receiver should always be held **in front of the body** in an upright position and as close to the ground as possible. When the transmitter is brought directly over a metallic conductor, the maximum signal strength will be measured. If the receiver is moved away from the conductor towards the side and is not rotated while doing so, the signal will drop off proportionately.



The alignment of the receiver in relation to the orientation of the conductor (the antenna being the starting point of alignment) has the following effects on the reception signal strength:

- Receiver **in line** with the conductor ⇒ **maximum signal strength**
- Receiver **perpendicular** to the conductor ⇒ **minimum signal strength**



## 4.2.3 General site surveying

**Requirement** A general site probing urgently needs to be conducted and there is inaccurate or no information available as to the location and orientation of metallic conductors on a site planned for construction (e.g. excavation work).

**Basics of site surveying** When a site is to be searched for unknown conductors, a systematic approach should be taken. The following picture illustrates how to proceed:

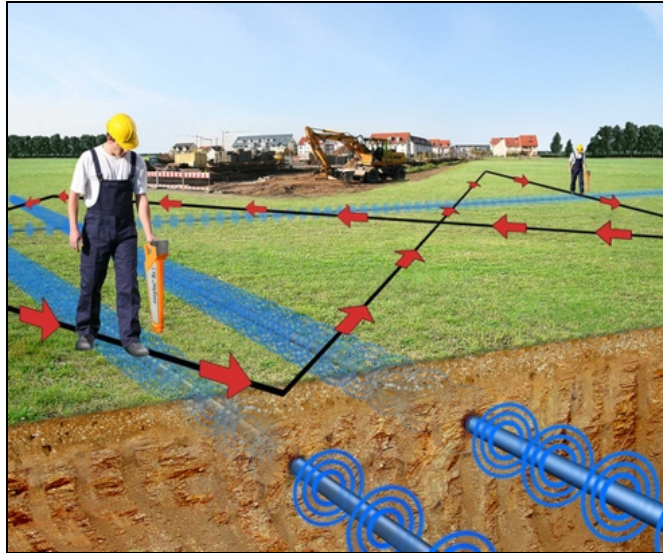

Carry out a passive survey in **POWER GRID** and **RADIO** modes using a grid search pattern to cover the site and locate conductors in all directions.

If the site will be surveyed with the aid of the *Easyloc Tx* transmitter used on induction, the position of the transmitter should be changed by at least one metre and 90° after the first sweep of the site and the site should be probed again in the same manner.



The minimum spacing of 15 m between the transmitter and receiver must always be maintained.

**How to proceed** Follow the steps below when probing a site for unknown metallic conductors:

Step	Action
1	If the site will be searched with the aid of the <i>Easyloc Tx</i> transmitter, the transmitter needs to be configured as described in section 4.1.3 <i>Initial use of the transmitter</i> before proceeding.
2	Press <input type="button" value="ⓐ"/> to switch on the receiver.
3	Select the desired mode of operation (see section 4.2.2.1 <i>Modes of operation for the receiver</i> ) by pressing the <input type="button" value="3"/> button. The symbol for the currently selected mode of operation is shown in the lower right-hand corner of the display.
4	Pace off the site as previously described and make a grid search of the site. Adjust the sensitivity of the receiver as needed if the signal level is too strong / weak (see section 4.2.2.2 <i>Regulating the sensitivity level to match the reception signal strength</i> ).
5	When a conductor is located, pinpoint the strongest signal (see section 4.2.2.3 <i>Handling the receiver</i> ) and mark the location.

## 4.2.4 Determining the direction of a line

How to proceed Follow the steps below to determine the orientation of a metallic conductor:

Step	Action
1	If the direction of the conductor will be determined with the aid of the <i>Easyloc Tx</i> transmitter, couple the transmitter's signal onto the metallic conductor in such a way that there is as little signal loss as possible (see section 4.1.2 <i>Options for direct and inductive signal coupling</i> ) and switch on the transmitter (see section 4.1.3 <i>Initial use of the transmitter</i> ).
2	Press  to switch on the receiver.
3	Select the desired mode of operation (see section 4.2.2.1 <i>Modes of operation for the receiver</i> ) by pressing the  button. The symbol for the currently selected mode of operation is shown in the lower right-hand corner of the display.
4	Hold the receiver perpendicular to the position of a known metallic conductor, e.g. above a location which was marked during the probing of the site (see section 4.2.3 <i>General site surveying</i> ).
5	Rotate the receiver (through its own axis) over this location until the maximum signal strength is indicated (see section 4.2.2.3 <i>Handling the receiver</i> ).  <b>Result:</b> The receiver is in line with the conductor when it is positioned where the signal is strongest, which is prerequisite for determining the direction of the line.
6	To determine the path over an extended distance, proceed by moving forward while maintaining the maximum signal strength. If the signal becomes weaker, check that the conductor has not changed direction or become deeper, move and/or rotate the receiver to the left and right until the maximum signal strength is detected again.  The path of the metallic conductor should always be followed until it exits the site being searched, and its path should be clearly marked along the way with paint/chalk or marker flags.  Adjust the sensitivity of the receiver as needed if the signal level is too strong / weak (see section 4.2.2.2 <i>Regulating the sensitivity level to match the reception signal strength</i> ). It is advisable to manually adjust the sensitivity level.

## 4.2.5 Determining the depth of a line (not available for *Easyloc Basic*)

Preconditions for automatic depth measurement

The *Easyloc Rx* receiver has an **automatic** pushbutton depth measurement feature. One precondition is that a clear signal from the *Easyloc Tx* transmitter is coupled onto the conductor to be measured. For this procedure, the transmitter's signal has to be continuous (not pulsed) (see section 4.1.1 *Transmitter signals and modes of operation*).



In addition to this precondition, **automatic** depth measurement will only function when the mode of operation of the receiver is set to **TRANSMITTER**. It will not function if set to **POWER GRID** or **RADIO**.

If these preconditions are not met, a **rough estimate** of the depth may be made using the manual method.

Measuring depth with the aid of a probe

If the depth of a non-metallic pipe needs to be determined, the measurement has to be made with aid of a probe, e.g. *FlexSonde* (see section 4.1.2.4 *Signal coupling in non-metallic pipes*). In order to accommodate the transmission characteristics of a probe, the *Easyloc Rx* receiver has a special depth measurement mode which has to be activated through the system settings (see section 4.2.1 *Changing the system settings*).

As a result, the way a depth measurement can be performed depends not only on the active operation mode but also on how the depth measurement mode is set (Transmitter or Probe). A symbol in the lower left of the display indicates which mode is currently accessible:







Symbol	Description
	For determining the depth of a probe which has been pushed into a non-metallic pipe.
	For determining the depth of a line, the signal of an active transmitter is coupled onto.
	For determining the depth of a line which carries radio signals or grid frequency signals.



**WARNING**

Even after the depth has been successfully determined, all excavation work should be done with caution. This is particularly important if a **rough estimate** of the depth was made, as this can result in even greater deviations.

How to proceed Follow the steps below to determine the depth of a metallic conductor:

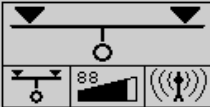

Step	Action	
1	<p>If the depth of the conductor will be determined with the aid of the <i>Easyloc Tx</i> transmitter, couple the transmitter's signal onto the metallic conductor in such a way that there is as little signal loss as possible (see section 4.1.2 <i>Options for direct and inductive signal coupling</i>) and switch on the transmitter (see section 4.1.3 <i>Initial use of the transmitter</i>).</p> <p> Do not forget to set the transmitter to continuous signal, not a pulsed signal when measuring depth.</p>	
2	Press  to switch on the receiver.	
3	<p>Select the desired mode of operation (see section 4.2.2.1 <i>Modes of operation for the receiver</i>) by pressing the  button.</p> <p>The symbol for the currently selected mode of operation is shown in the lower right-hand corner of the display.</p>	
4	<p>With a steady grip, hold the receiver perpendicular to the position of a known metallic conductor, e.g. above a location which was marked during the site survey. The signal strength bargraph should show zero (see section 4.2.3 <i>General site surveying</i>).</p> <p>In doing so, the tip of the receiver should touch the ground.</p>	
5	Rotate the receiver (through its own axis) over this location until the maximum signal strength is indicated (see section 4.2.2.3 <i>Handling the receiver</i> ).	
6	<p>Press the  button to begin measuring the depth.</p> <p>For <b>automatic</b> depth measurement (while working in <b>TRANSMITTER</b> or <b>PROBE</b> mode)...</p> <p>... the measured depth will be shown in the display:</p>  <p>The following steps can be skipped.</p>	<p>For making a <b>rough estimate</b> of the depth (while working in <b>RADIO</b> or <b>POWER GRID</b> mode)...</p> <p>... the following symbol will appear in the display:</p>  <p>The measurement has to be continued from <b>step 7</b>.</p>
7	<p>Move slowly to one side until the following symbol appears in the display and an acoustic signal sounds:</p> 	

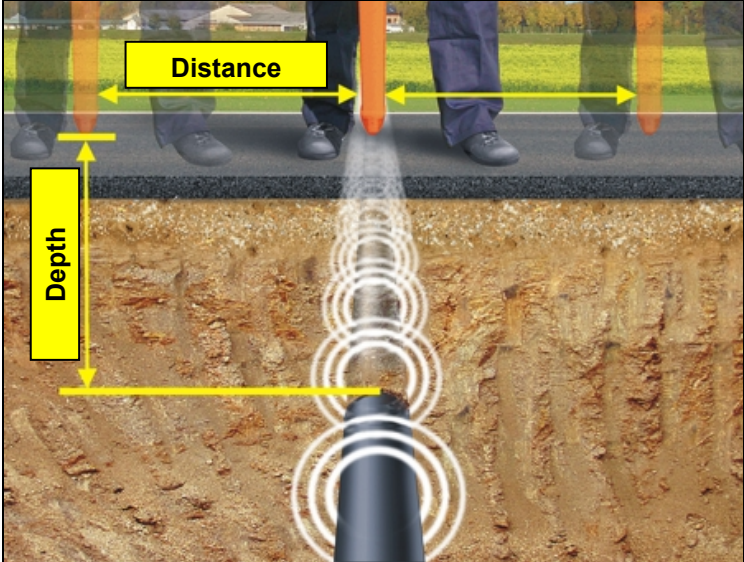

Step	Action
8	Mark this spot, then move in the opposite direction to the other side of the line until the symbol appears in the display again.
9	<p>Mark this spot as well, then measure the distance between the two spots.</p> <p><b>Result:</b> Half the distance between the two spots corresponds approximately to the depth of the line.</p> 

Indications and error messages

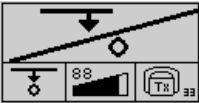
During the depth measuring process, the following symbols are used to notify the user about certain characteristics and errors:

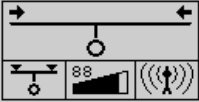
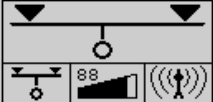
Symbol	Meaning
	<p>For one of the following reasons, the depth could not be measured:</p> <ul style="list-style-type: none"> <li>• The signal received was too weak or too irregular.</li> <li>• The receiver was not held steady enough during the measuring process.</li> <li>• The receiver was not positioned directly above the line at the beginning of the process.</li> </ul>
	<p>The depth of the metallic conductor / probe exceeds the measuring range (5 m / 7 m). Depth measurement cannot be performed.</p>
	<p>The depth of the metallic conductor amounts to less than 30 cm (1 ft). Such conductors must be specially marked in order to prevent damage during construction.</p>
	<p>The receiver was moved too far to the left or right while making a <b>rough estimate</b>. Move in the opposite direction until the following symbol appears:</p>  <p>Proceed as described in <b>step 8</b> on the previous page.</p>

### 4.2.6 Masking-Out Lines

Masking-out lines Under certain circumstances lines at lower depths can 'hide' deeper, adjacent lines, thus making it more difficult to locate them.

In such cases, the transmission characteristics of the *Easyloc Tx* transmitter can be fully utilised and the lines which have already been located can be masked out.

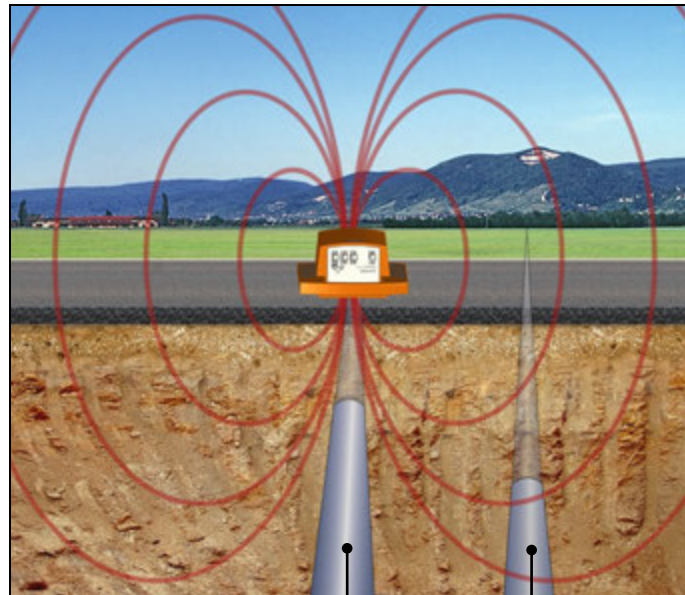

Line with weaker inductive coupling

Line with good inductive coupling

How to proceed Follow the steps listed below in order to locate lines by masking-out adjacent lines:



Step	Action
1	Use the <i>Easyloc Rx</i> and <i>Easyloc Tx</i> to locate and pinpoint a buried line (see section 4.2.3 <i>General site surveying</i> ).
2	With the <i>Easyloc Rx</i> rested on the ground straight above the located line, ask a colleague to place the <i>Easyloc Tx</i> on its back (see picture) nearby the line path (at least 15 m away from the receiver).
3	Slide the <i>Easyloc Tx</i> across the line until the signal strength bargraph is lowest, indicating that the transmitter is directly above the line which, thus, is masked-out.   Note that adjacent lines may not be parallel with the first cable route, so sweep the receiver around in a circle about 10 m - 15 m radius from the transmitter, with the handle pointing towards the transmitter. Any metallic lines within 2.5 m of the transmitter will be coupled with the transmitted signal
4	Pinpoint and determine the direction of any buried lines (see section 4.2.2.3 <i>Handling the receiver</i> ).

## 4.2.7 Functional test of the receiver

**Introduction** If problems or strange measuring results occur during a line location procedure, it may be helpful to check the functionality of the receiver using the integrated self-test. This test may provide information about possible malfunctions of the instrument.

Preferably, the self-test should be performed in an interference-free environment without live cables.

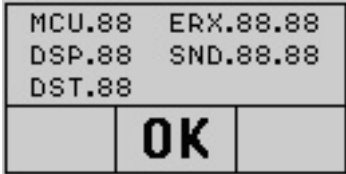
**How to proceed** Proceed as follows to perform a self-test:

Step	Action
1	<p>In order to access the self-test, the receiver must be in off-state. The test can be started by pressing and holding <b>2</b> followed by <b>0</b> for at least 3 seconds.</p> <p>If the self-test is successfully accessed, the display should show the software and hardware versions of the receiver components:</p> 
2	<p>Press the <b>2</b> button to start the self-test.</p>
3	<p>If the test is successfully passed without any problems, the display shows the following information:</p>  <p>If a fault is recognized during the test, the self-test procedure is terminated and the display indicates the respective error code (see next page):</p>  <p>If this is the case, the error code should be forwarded to the responsible service centre.</p>
4	<p>Press the <b>2</b> button to exit the self-test.</p>



Error codes	Error code	Description
	000	Unimplemented frequency
	201	Not enough battery power for the self-test procedure
	210 (operation mode <b>POWER GRID</b> ) 211 (operation mode <b>2</b> ) 212 (operation mode <b>3</b> ) 213 (operation mode <b>4</b> )	Interferences too strong for the self-test procedure  In this case, the self-test should be repeated in an environment with less interferences.
	220 (operation mode <b>POWER GRID</b> ) 221 (operation mode <b>2</b> ) 222 (operation mode <b>3</b> ) 223 (operation mode <b>4</b> )	Fault L1
	230 (operation mode <b>POWER GRID</b> ) 231 (operation mode <b>2</b> ) 232 (operation mode <b>3</b> ) 233 (operation mode <b>4</b> )	Fault L2
	240 (operation mode <b>POWER GRID</b> ) 241 (operation mode <b>2</b> ) 242 (operation mode <b>3</b> ) 243 (operation mode <b>4</b> )	Fault L1L2
	250 (operation mode <b>POWER GRID</b> ) 251 (operation mode <b>2</b> ) 252 (operation mode <b>3</b> ) 253 (operation mode <b>4</b> )	General fault

## 5 Maintenance

Changing the batteries in the receiver

The status of the receiver's batteries is checked upon start-up and indicated in the display.

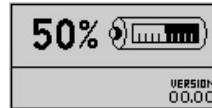

The system regularly checks the battery strength as well. If battery capacity falls below 10 % of the threshold value, an audible warning signal is given and the current status of the batteries is shown in the upper part of the display.

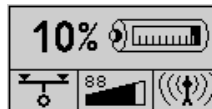

In order to replace the ten 1.5 V mignon (AA) batteries, the battery housing must be removed (e.g. using a coin) as described in the following illustrations:

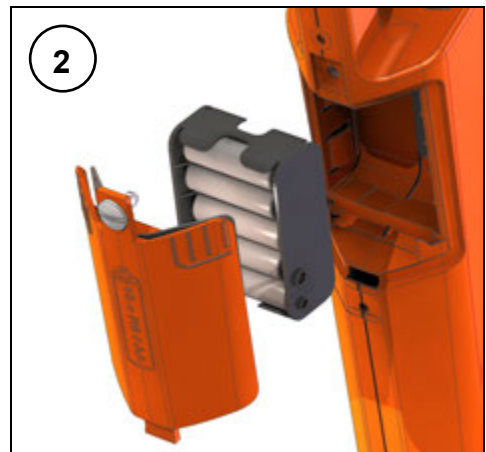
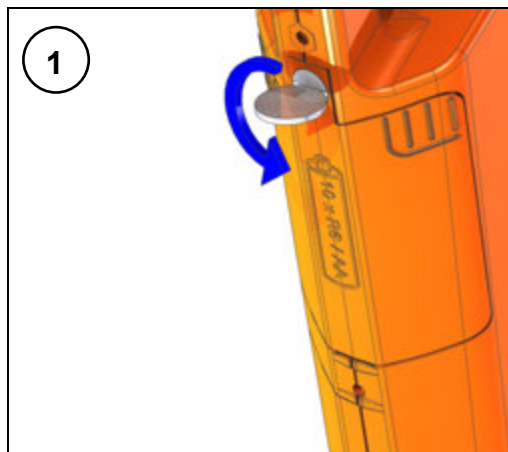

Changing the batteries in the transmitter

The batteries in the transmitter have to be replaced as soon as the red LED battery indicator starts to blink.

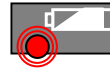

Should this occur while the user is busy locating a line with the receiver, he/she will be informed of the weak batteries via the reception signal:

Type of signal	Normal signal	Signal when batteries are weak



Before changing the batteries, any connection leads have to be disconnected from the transmitter. Only batteries of the same type and size as recommended (see Technical Data) are to be used. There is danger of explosion if batteries are mishandled or incorrectly replaced.

In order to change the six batteries, both screws on the back of the transmitter must be (e.g. with the aid of a coin) turned through 1/4 turn (1) and the battery tray must be pulled (2). Please note that all the batteries are fitted in the same direction.

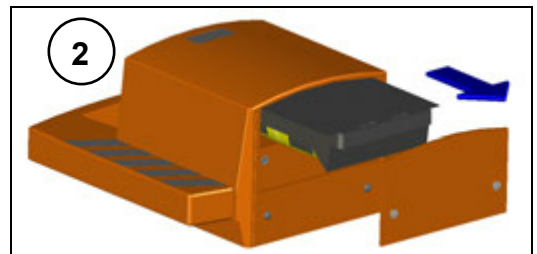
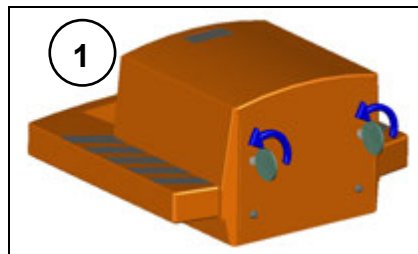

Changing the floor cap on the receiver

The plastic floor cap, which prevents the tip of the receiver from being damaged, can be easily replaced with the aid of a pointed object (e.g. screw driver). Replacements can be ordered through the Megger sales team.

