

Insulation Tester + DMM

Model MG320

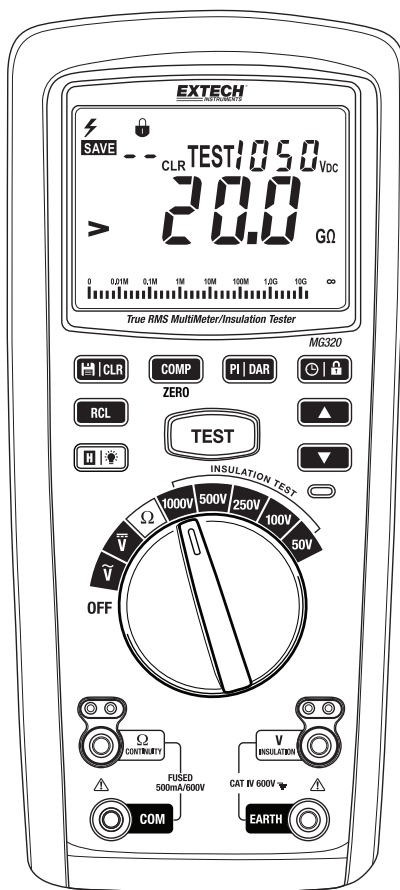

Table of Contents

1.	INTRODUCTION	3
2.	SAFETY	3
3.	METER DESCRIPTION	5
4.	CONTROL BUTTONS	6
5.	SYMBOLS AND ANNUNCIATORS	6
6.	OPERATING INSTRUCTIONS	7
	6.1 Display Backlight	7
	6.2 Data Hold	7
	6.3 Low Battery Indication	7
	6.4 DC VOLTAGE MEASUREMENTS	7
	6.5 AC VOLTAGE MEASUREMENTS	8
	6.6 LOW RESISTANCE / CONTINUITY MEASUREMENTS	9
	6.7 INSULATION RESISTANCE MEASUREMENTS	10
	6.7.1 Disable Insulation Test Lock Mode	10
	6.7.2 Insulation Resistance Test Time Setup	11
	6.7.3 Dielectric Absorption Ratio [DAR] Insulation Testing	11
	6.7.4 Polarization Index [PI] Insulation Testing	11
	6.7.5 Comparator Utility	12
7.	DATA RECORDING	12
8.	MAINTENANCE	13
	8.1 BATTERY INSTALLATION	13
	8.2 REPLACING THE FUSE	13
9.	SPECIFICATIONS	14

1. Introduction

Congratulations on your purchase of the MG320 True RMS Insulation Resistance CAT IV 600V DMM. The MG320 features a rugged design for heavy duty use. The MG320 measures Insulation Resistance, AC/DC Voltage, and Resistance.

Insulation Resistance tests are automatic ranging with 5 test voltages from 50V to 1000V. The MG320 can store and recall up to 99 measurements.











The MG320 is suitable for measuring the insulation resistance on electrical equipment such as transformers, motors, cables, switches, and appliances.

Proper use and care of this meter will provide years of reliable service.

Features

- True RMS AC/DC Voltage Measurements to 600V
- Insulation Resistance Measurements up to 20G
- Low Resistance/Continuity Measurements to 20k Ω
- Auto Ranging measurements
- Polarization Index (PI) and Dielectric Absorption Ratio (DAR) tests
- Five (5) Insulation Resistance test voltages (50, 100, 250, 500, and 1000V)
- Insulation Resistance tests in 10% voltage steps (from 50% to 120% of range)
- Front panel LED test voltage alert lamp
- Eight (8) Insulation Resistance measurement ranges (automatic ranging)
- Pass/Fail Comparator function
- Auto-discharge at end of test
- High voltage display symbols
- Hand's free test lock feature
- Manually store and recall up to 99 readings
- Overload indication
- Optional remote test probe for controlling the TEST button remotely
- Test leads, alligator clips, batteries, user manual, and case included

2. Safety

	Warning and Caution safety label
	Double Insulation
	DC Direct Current
	AC Alternating Current
	Low Battery
	Fuse symbol
	High Voltage Alert
	Audible beeper
	Earth ground
	Complies with EC standard

PER IEC1010 OVERVOLTAGE INSTALLATION CATEGORY

OVERVOLTAGE CATEGORY I

Equipment of OVERVOLTAGE CATEGORY I is equipment for connection to circuits in which measures are taken to limit the transient over-voltages to an appropriate low level.

Note – Examples include protected electronic circuits.

OVERVOLTAGE CATEGORY II

Equipment of OVERVOLTAGE CATEGORY II is energy-consuming equipment to be supplied from the fixed installation.

Note – Examples include household, office, and laboratory appliances.

OVERVOLTAGE CATEGORY III

Equipment of OVERVOLTAGE CATEGORY III is equipment in fixed installations.

Note – Examples include switches in the fixed installation and some equipment for industrial use with permanent connection to the fixed installation.

OVERVOLTAGE CATEGORY IV

Equipment of OVERVOLTAGE CATEGORY IV is for use at the origin of the installation.

Note – Examples include electricity meters and primary over-current protection equipment

SAFETY INSTRUCTIONS

This meter has been designed for safe use, but must be operated with caution. The rules listed below must be carefully followed for safe operation.

1. **NEVER** apply voltage to the meter that exceeds the specified maximum:

Input Protection Limits	
Function	Maximum Input
V DC or V AC	600VDC/AC rms
Resistance/Continuity	500mA/600V fuse protected input
Insulation Resistance	250VDC/AC rms
Surge Protection: 8kV peak per IEC 61010	

2. **USE EXTREME CAUTION** when working with high voltages.
3. **DO NOT** measure voltage if the voltage on the "COM" input jack exceeds 600V above earth ground.
4. **NEVER** connect the meter leads across a voltage source while the function switch is in the resistance mode. Doing so can damage the meter.
5. **ALWAYS** discharge filter capacitors in power supplies and disconnect the power when making resistance tests.
6. **ALWAYS** turn off the power and disconnect the test leads before opening the covers to replace the fuse or batteries.
7. **NEVER** operate the meter unless the battery/fuse cover is in place and fastened securely.
8. If the equipment is used in a manner not specified by the manufacturer, the protection provided by the equipment may be impaired.

SAFETY STANDARDS

This instrument is designed and produced strictly in accordance with the safety requirements for GB4793 electronic measuring instruments and IEC61010-1 safety standards. This instrument meets the double insulation over-voltage standard CAT IV 600V and pollution degree II. Failure to use the instrument as described in this user manual can weaken or negate the protections provided.

- Check the instrument, test leads, and test pen before use. Check for any abnormal conditions such as exposed test lead wire, damaged meter housing, no display or random display errors.
- Do not use this instrument with an open battery compartment.
- Damaged test leads must be replaced with those of the same type or specifications.
- Do not touch bare wires or conductors, unused input terminals, or the circuit being measured when the instrument is in operation.
- Use caution when measuring voltages greater than 42V DC or 30V AC. Keep fingers behind the finger guard on the test leads to avoid electrical shocks when measuring.
- Do not apply signals greater than those specified between any two terminals or any terminal and ground.
- Set the function switch to the correct position before beginning a test. Never move the function switch during a test. Please stop testing and remove connections to the circuit under test before moving the function switch to a new position.
- Do not store or use the instrument in an explosive or flammable environment or an environment characterized by high temperature, high humidity, or strong electromagnetic fields.
- There are no user-serviceable parts in this instrument. Please refer all service and repairs to Extech Instruments.
- Replace the batteries as soon as the low battery icon appears in order to ensure the highest measurement accuracy.

3. Meter Description

1. 5999 count backlit LCD display with bargraph
2. Control buttons; detailed in next section
3. Rotary function switch
4. Low Resistance/Continuity (+) positive input jack
5. Low Resistance/Continuity (-) COM input jack
6. Insulation and Voltage (-) COM input jack
7. Insulation and Voltage (+) positive input jack
8. Test Voltage alert LED indicator

Note: Tilt stand and battery compartment on back

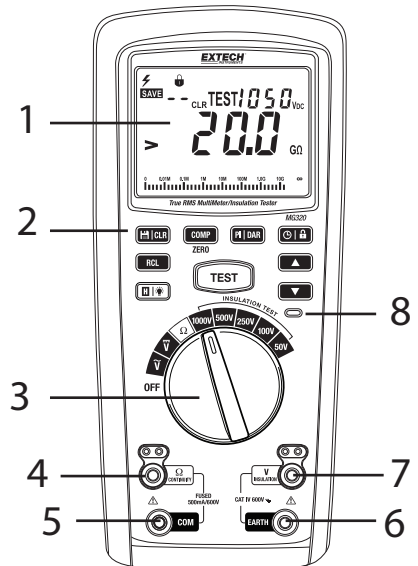

4. Control buttons

1. Data Hold on/off (short press) for AC/DC Voltage and Resistance modes only. Also for display Backlight on/off (long press)
2. Short press to Recall stored readings. Another short press to exit this mode.
3. Save reading (short press) and Clear all stored readings (long press)
4. Comparator (short press) and Zero (long press)
5. PI and DAR test mode selection (short presses)
6. Insulation Test Lock button (long press to activate/deactivate lock mode)
7. Up arrow for adjusting test voltage output and scrolling through recalled readings
8. Down arrow for adjusting test voltage output and scrolling through recalled readings
9. Press to start Insulation or Low Resistance tests. Insulation tests output high voltages and measure insulation resistance. Low Resistance tests can be made up to 20kΩ.

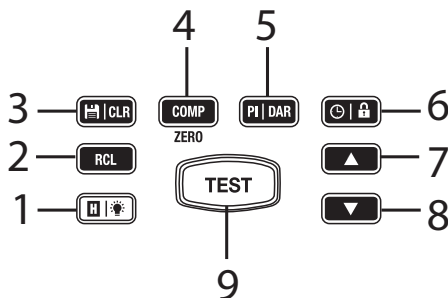

5. Symbols and Annunciators

1. Test Voltage alert
2. Insulation Test Lock icon
3. Audible beeper symbol
4. PI/DAR test modes
5. True RMS voltage measurement
6. ZERO function icon
7. Battery status
8. Test voltage value
9. Measurement type and units
10. PI/DAR timer information
11. Bargraph measurement representation
12. Comparator area: Test pass [PASS], test fail [NG], units [K, M, GΩ], and reference value.
13. Main measurement display digits
14. Display Hold Icon (freeze/unfreeze display)
15. Save/Recall readings (01-99)

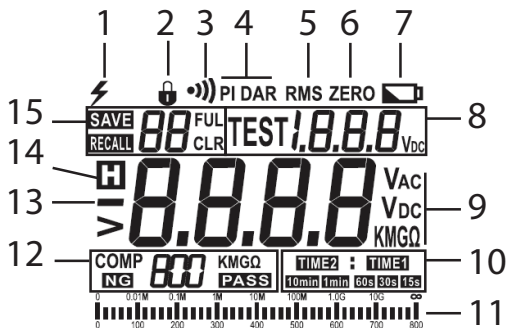

6. Operating Instructions

WARNING: Risk of electrocution. High-voltage circuits, both AC and DC, are very dangerous and should be measured with great care.

1. ALWAYS turn the function switch to the **OFF** position when the meter is not in use.
2. If “>” appears in the display during a measurement, the value exceeds the maximum range of the meter.

6.1 Display Backlight

Press and hold the  button to switch the backlight on or off. Excessive use of the backlight will cause the batteries to drain quicker.

6.2 Data Hold

The Data Hold function freezes the reading in the display. To freeze or unfreeze the reading, press **H** (Data Hold) key. The **H** icon is shown when data hold is active. This mode is available for Voltage and Resistance modes only.

6.3 Low Battery Indication

When the  icon appears in the display, the battery must be replaced. See the Maintenance section for details on battery and fuse replacement.

6.4 DC VOLTAGE MEASUREMENTS

CAUTION:

When the measured voltage is > 42VDC or 600VAC the meter flashes the warning icon on the upper left. Do not measure DC voltages if a motor on the circuit is being switched ON or OFF. Large voltage surges may occur that can damage the meter.

1. Set the function switch to the $\overline{\text{V}}$ position.
2. Insert the black test lead banana plug into the negative **COM** jack (6). Insert the red test lead banana plug into the positive **V** jack (7).
3. Touch the black test probe tip to the negative side of the circuit. Touch the red test probe tip to the positive side of the circuit.
4. Read the voltage in the main display and in the lower bargraph.
5. Press the  button to store the reading.
6. Short press the **H** (Hold) button to freeze (**H** icon displayed) or unfreeze (no **H** icon displayed) the displayed reading.
7. Note that the Auto Power OFF function activates after 3 minutes of inactivity. The meter will audibly beep just prior to shutting off.

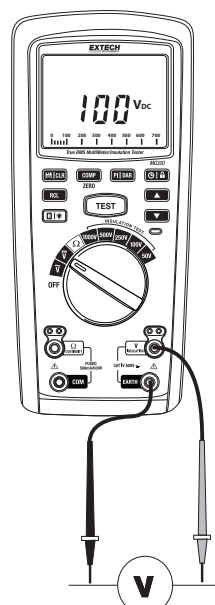

6.5 AC VOLTAGE MEASUREMENTS



WARNING: Risk of Electrocution. The probe tips may not be long enough to contact the live parts inside some 240V outlets for appliances because the contacts are recessed deep in the outlets. As a result, the reading may show 0 volts when the outlet actually has voltage on it. Make sure the probe tips are touching the metal contacts inside the outlet before assuming that no voltage is present.



CAUTION

Do not measure AC voltages if a motor on the circuit is being switched ON or OFF. Large voltage surges may occur that can damage the meter.

Do not measure voltages higher than 600V

When the measured voltage is > 60VDC or 600VAC the meter flashes the warning icon on the upper left.

Do not measure AC voltages if a motor on the circuit is being switched ON or OFF. Large voltage surges may occur that can damage the meter.

1. Set the function switch to the \tilde{V} position.
2. Insert the black test lead banana plug into the negative **COM** jack (6).
Insert red test lead banana plug into the positive **V** jack (7).
3. Touch the black test probe tip to the neutral side of the circuit.
Touch the red test probe tip to the “hot” side of the circuit.
4. Read the voltage in the main display and in the lower bargraph.
5. Short press the **H** (Hold) button to freeze (**H** icon displayed) or unfreeze (no **H** icon displayed) the displayed reading.
6. Press  to store the reading
7. Note that the Auto Power OFF function activates after 3 minutes of inactivity. The meter will audibly beep just prior to shutting off.
8. Note that the Auto Power OFF function activates after 3 minutes of inactivity. The meter will audibly beep just prior to shutting off.

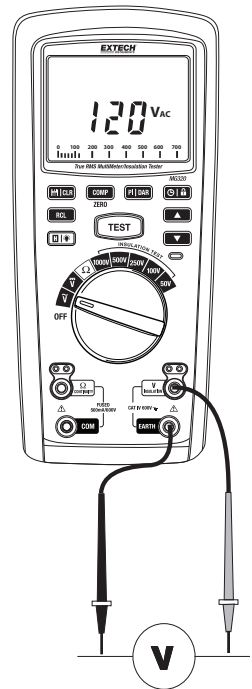

6.6 LOW RESISTANCE/CONTINUITY MEASUREMENTS



WARNING: To avoid electric shock, disconnect power to the unit under test and discharge all capacitors before taking any resistance measurements. Remove the batteries and unplug the line cords.



WARNING: To avoid electric shock, never measure resistance on circuits or wires that have a voltage.

1. Set the function switch to the Ω position.
2. Insert the black test lead banana plug into the negative **COM** jack (5).
Insert the red test lead banana plug into the positive **Ω CONTINUITY** jack (4).
3. Press the **TEST** button on the meter (or on the optional remote test leads) to put the meter in test mode. The display will show **TEST** and the front panel alert LED will light.
4. Reset the display to zero before testing: Short the test probes and note the value. Short the test probes again and press and hold **ZERO** until **ZERO** is displayed (0.00Ω reading when successful). Press and hold **ZERO** again to exit.
5. Before testing, it is best to disconnect one side of the part under test so that other circuits do not interfere with the resistance reading.
6. Touch the test probe tips across the circuit or part under test.
7. Read the resistance in the main display.
8. If the circuit is open, the display will indicate ">". If 2V or more are sensed on the device under test, the meter will stop the test.
9. Short press the **H** (Hold) button to freeze (**H** icon displayed) or unfreeze (no **H** icon displayed) the displayed reading.
10. Press  to store the reading
11. Note that the Auto Power OFF function activates after 3 minutes of inactivity. The meter will audibly beep just prior to shutting off.

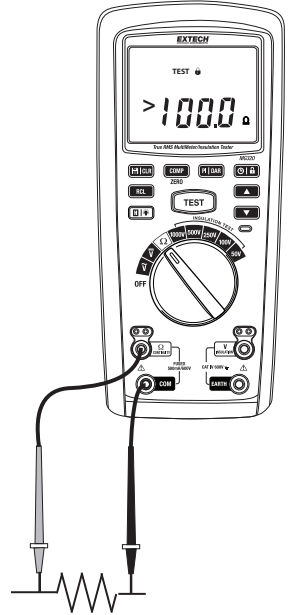

**Test Equipment
Depot**

1-800-517-8431

99 Washington Street
Melrose, MA 02176
Phone 781-665-1400
Toll Free 1-800-517-8431



Visit us at www.TestEquipmentDepot.com

6.7 INSULATION RESISTANCE MEASUREMENTS

Note: Disconnect the unit under test from all power sources and isolate it from any stray resistance.

1. Connect the red test lead to the meter's **INSULATION (+)** jack (7) and the black test lead to the **EARTH (-)** jack (6). Connect the probe end of the test leads to the circuit under test.
2. Set the rotary function switch to one of the Insulation Resistance test positions (50V, 100V, 250V, 500V, or 1000V); the selected test voltage is indicated on the top right of the display.
3. Press the **TEST** button on the meter (or on the optional remote test lead) to start testing (**TEST** will display).
4. The primary display and the analog bargraph will show the insulation resistance in Ω .
5. The test voltage (VDC) value will be indicated in the top right display, the ⚡ symbol will flash and the front panel red LED will light.
6. The meter defaults to test lock mode (lock icon displayed) so the test will run without having to hold the **TEST** button.
7. Press the **TEST** button to stop the test.
8. At the end of each test the high voltage switches off (alert symbol ⚡ and LED light switch off), the measured resistance value is held in the primary display, and the meter internally discharges the balance of the test voltage.
9. Short press the **H** (Hold) button to freeze (**H** icon) or unfreeze (no **H** icon) the displayed reading.
10. Press **MEM CLR** to store the reading

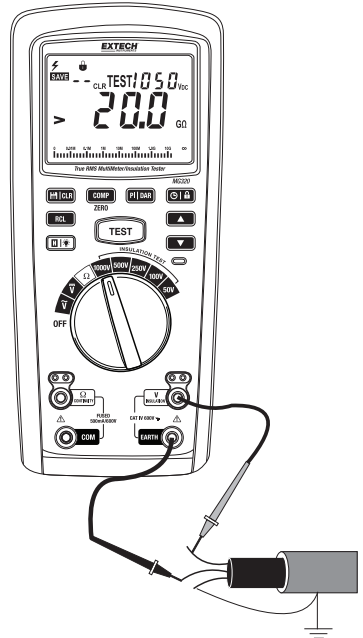

Note: If the circuit under test is live and has a voltage potential (AC/DC) over 25V, the meter will not test (the display will show "EXT" and the ⚡ symbol will flash). If the circuit under test is not live or if its voltage is less than 25V, the meter will begin applying voltage to the circuit under test.

Note: Do not turn the function switch to another test position during a test. Please wait until a test is completed and test leads are removed from the device under test before moving the function switch.

6.7.1 Disable Insulation Test Lock Mode

To disable test lock mode, press and hold the **MEM CLR** button until the lock icon switches off and then press and hold the **TEST** button for the duration of the test (**TEST** will be displayed). Release the button to stop the test.

6.7.2 Insulation Resistance Test Time Setup

1. Press the  button to select the desired test time. Select from 15s, 30s, 1m, 15s/1m, 1m/30s, 10m, 15s/10m, and 30s/10m. Connect the meter to the device under test as shown in the Insulation Resistance test section above.
2. Press **TEST** to start the test. The test will end automatically after the time period has elapsed.

NOTE: Combination test times (15s/1m, for example) provide an audible beep at the first test time value and then continue testing until the test automatically stops at the second test time value.

6.7.3 Dielectric Absorption Ratio [DAR] Insulation Testing

Read and understand all operations and safety information in the Insulation Resistance measurement section above and in the Safety section before continuing.

1. Connect the meter to the device under test as shown in the Insulation test section above.
2. Select the desired output test voltage using the rotary function switch.
3. Use the **PI/DAR** button to step to the first DAR test mode (60 seconds : 15 seconds ratio test) or to the second DAR test mode (60 seconds : 30 seconds ratio test).
4. The display will show the DAR icon when the DAR mode is successfully accessed.
5. The test times will show on the lower right.
6. Press the **TEST** button to start the test. When Time1 is reached the meter beeps and then beeps again when Time2 is reached at which time the test automatically stops.
7. During the test the main display digits show the test elapsed timer, the voltage alert flashes on the upper left, and the 'test voltage alert' LED will light.
8. If the insulation breaks down during the test, the meter emits an audible tone and buzzer.
9. Press the **TEST** button to stop the test and activate the discharging circuit.

6.7.4 Polarization Index [PI] Insulation Testing

Read and understand all operations and safety information contained in the Insulation Resistance measurement section above and the Safety section before continuing.

1. Connect the meter to the device under test as shown in the test section above.
2. Select the desired output test voltage using the rotary function switch.
3. Use the **PI/DAR** button to access the PI test mode.
4. The display will show the **PI** icon when the PI mode is successfully accessed.
5. The timers (Time1: 60 seconds and Time2: 10 minutes) will show on the lower right.
6. Press the **TEST** button to start the test.
7. After 60 seconds (Time1) the meter beeps. The meter beeps again at the 10 minute mark (Time2) after which the test automatically stops.
8. During the test the main display digits show the test elapsed timer, the voltage alert flashes on the upper left, and the 'test voltage alert' LED illuminates.
9. If the insulation breaks down during the test, the meter emits audible tone and buzzer.
10. Press the **TEST** button to stop the test and activate the discharging circuit.

6.7.5 Comparator Utility





Read and understand all operations and safety information contained in the Insulation Resistance and Continuity measurement sections and the Safety section before continuing.

In Comparator mode the meter compares measurement to a preset reference values and displays **PASS** (measured value greater than reference value) or **NG** (measured value lower than reference value).

1. Connect the meter to the device under test as shown in the test section above.
2. Press the **COMP** button momentarily and the **COMP** icon will appear on the lower left, next to the comparison resistance value. Use the **COMP** button to step to the desired reference value.
3. Press the **TEST** button to start the test. If the measurement is greater than the reference, then the test passes and **PASS** will be displayed; if the measured value is lower than the reference then the test fails and **NG** is displayed.
4. The Resistance comparator preset options are: 100k, 200k, 300k, 400k, 500k, 1M, 2M, 3M, 4M, 5M, 10M, 20M, 30M, 40M, and 50M.
5. The Continuity comparator preset options are: 1, 2, 5, 10, and 20Ω.

7. Data Recording

The MG320 can store, recall, and clear up to 99 readings (01-99).

1. Press the  **CLR** button to save a displayed reading.
2. The displayed counter increments to the next available memory location.
3. To recall a reading, press the  button (**RECALL** will be displayed). Use the arrow buttons to scroll through the stored readings. The stored reading counter keeps track of the memory location (01-99). Press  again to return to the normal mode.
4. Press and hold the  **CLR** button for 2 seconds to erase all memory data.



99 Washington Street
Melrose, MA 02176
Phone 781-665-1400
Toll Free 1-800-517-8431



8. Maintenance

WARNING: To avoid electric shock, disconnect the test leads from any source of voltage before removing the back cover, the battery, or fuse covers.

WARNING: To avoid electric shock, do not operate your meter until the battery and fuse covers are in place and fastened securely.

This Instrument is designed to provide years of dependable service, if the following care instructions are performed:

1. **KEEP THE METER DRY.** If it gets wet, wipe it off.
2. **USE AND STORE THE METER IN NORMAL TEMPERATURES.** Temperature extremes can shorten the life of the electronic parts and distort or melt plastic parts.
3. **HANDLE THE METER GENTLY AND CAREFULLY.** Dropping it can damage the electronic parts or the case.
4. **KEEP THE METER CLEAN.** Occasionally wipe the case with a damp cloth. **DO NOT** use chemicals, cleaning solvents, or detergents.
5. **USE ONLY FRESH BATTERIES OF THE RECOMMENDED SIZE AND TYPE.** Remove old or weak batteries so they do not leak and damage the unit.
6. **IF THE METER IS TO BE STORED FOR A LONG PERIOD OF TIME,** the batteries should be removed to prevent damage to the unit.

8.1 BATTERY INSTALLATION

WARNING: To avoid electric shock, disconnect the test leads from any source of voltage before removing the battery cover.

1. Turn power off and disconnect the test leads from the meter.
2. Open the rear battery cover by removing three screws using a Phillips screwdriver.
3. Insert the six (6) 1.5V AA batteries into battery holder, observing the correct polarity.
4. Put the battery cover back in place. Secure with the screws.

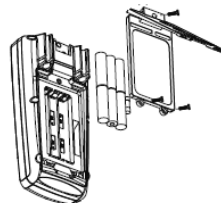

You, as the end user, are legally bound (**EU Battery ordinance**) to return all used batteries, **disposal in the household garbage is prohibited!** You can hand over your used batteries / accumulators at collection points in your community or wherever batteries / accumulators are sold!

Disposal: Follow the valid legal stipulations in respect of the disposal of the device at the end of its lifecycle

WARNING: To avoid electric shock, do not operate meter until the battery cover is in place and fastened securely.

8.2 REPLACING THE FUSE

WARNING: To avoid electric shock, disconnect the test leads from any source of voltage before removing the meter cover.

1. Disconnect the test leads from the meter.
2. To replace the 500mA/600V fuse, remove the battery cover (three Phillips screws); the fuse will be visible to the right of the batteries (recessed).
3. Gently remove the old fuse and install the new fuse into the holder.
4. Always use a fuse of the proper size and value (500mA/600V fast blow).
5. Replace and secure the rear battery cover.

WARNING: To avoid electric shock, do not operate meter until the fuse cover is in place and fastened securely.

9. Specifications

Function	Range	Resolution	Accuracy
DC Voltage	600V	0.1V	±(2.0% reading + 3 digits)
AC Voltage	600V	0.1V	±(2.0% reading + 3 digits)
	Specified from 5% of range to 100% of range		
	Input impedance: 10MΩ		
	Min. Measured Voltage: 0.1V Frequency 50~400Hz Input protection: 600V DC and AC rms		
Low Resistance & Continuity	20.00kΩ	0.01Ω	±(1.5% reading + 3 digits)
	Open-circuit voltage is 5.0V approx.		
	Short-circuit current > 200mA 500mA/600V fuse protected input terminals		
Insulation Resistance Measurements			
50V test voltage	0.01M~19.99MΩ	0.01MΩ	0.01M~50.0MΩ: ±(3% + 5 digits)
	20.0M~50.0MΩ	0.1MΩ	
100V test voltage	0.01M~19.99MΩ	1MΩ	0.01M~100.0MΩ: ±(3% + 5 digits)
	20.0M~100.0MΩ	0.01GΩ	
250V test voltage	0.01M~19.99MΩ	0.01MΩ	0.01M~200.0MΩ: ±(1.5% + 5 digits)
	20.0M~200.0MΩ	0.1MΩ	
500V test voltage	0.01M~19.99MΩ	0.01MΩ	0.01M~500MΩ: ±(1.5% + 5 digits)
	20.0M~199.9MΩ	0.1MΩ	
	200M~500MΩ	1Mv	
1000V test voltage	0.01M~19.99MΩ	0.01MΩ	0.01M~200.0MΩ: ±(1.5% + 5 digits)
	20.0M~199.9MΩ	1MΩ	200M~2000MΩ: ±(1.5% + 5 digits)
	200M~2000MΩ	1MΩ	2.0G~10.0GΩ: ±(10% + 3 digits)
	2.0G~20.0GΩ	0.1GΩ	10.0G~20.0GΩ: ±(20% + 10 digits)
Short-circuit current < 2mA			
Insulation Resistance Alerts			
50V: 0.01M~50.0MΩ (alert buzzer sounds when resistance is <1M)			
100V: 0.01M~100.0MΩ (alert buzzer sounds when resistance is <1M)			
250V: 0.01M~200.0MΩ (alert buzzer sounds when resistance is <4M)			
500V: 0.01M~500MΩ (alert buzzer sounds when resistance is <4M)			
1000V: 0.01M~10.0GΩ (alert buzzer sounds when resistance is <4M)			

Insulation Resistance Test Voltage Outputs					
Output Voltage	Test Steps (50~120%)	Load	Overload	Test current	Short-circuit current
50V (0%~+10%)	10% steps (25~60V)	50kΩ	250VAC/DC	1mA	≤2mA
100V (0%~+10%)	10% steps (50~120V)	100kΩ	250VAC/DC	1mA	≤2mA
250V (0%~+10%)	10% steps (125~300V)	250kΩ	250VAC/DC	1mA	≤2mA
500V (0%~+10%)	10% steps (250~600V)	500kΩ	250VAC/DC	1mA	≤2mA
1000V (0%~+10%)	10% steps (500~1200V)	1MΩ	250VAC/DC	1mA	≤2mA

Note: Accuracy is stated at 23°C (75°F) and 45~75% RH.

Note: Calibration interval: 1-year maximum

Note: Temperature coefficient: 0.1 x stated accuracy/C

Note: Accuracy specifications consist of two elements: (% reading) this is the accuracy of the measurement circuit; (+digits) this is the accuracy of the analog to digital converter.

General Specifications

Display	5999 count, backlit, LCD with bargraph
Ranging	Automatic
Storage capacity	99 records (01-99)
Input Impedance	>10MΩ
AC Response	True rms
ACV Bandwidth	50Hz to 400Hz
Over range indication	">" is displayed
Auto Power Off	After 3 minutes of inactivity
Polarity	Automatic (no indication for positive); Minus (-) sign for negative
Measurement Rate	2 times per second, nominal
Low Battery Indication	"  " is displayed if battery drops below operating voltage
Battery	Six (6) 1.5V 'AA' batteries
Consumption	500mA (at a 1000V test voltage); 10mA in nominal conditions
Fuse	500mA/600V fast blow
Enclosure	Double molded, IP 40
Operating Temperature	0°C~40°C (32°F~104°F)
Storage Temperature	-20°C~60°C (-4°F~140°F)
Operating Humidity	<85%
Storage Humidity	<90%
Operating Altitude	2000m (7000ft.) maximum
Weight	0.7kg (1.5 lbs.) with batteries
Size	225[L] x 103[W] x 59[D] mm (8.8[L] x 4.1[W] x 2.3[D] in.)
Safety	This instrument is designed in strict compliance with safety standard IEC61010, overvoltage standard (CAT IV 600V) and pollution degree II.

Copyright © 2017 FLIR Systems, Inc.