

High Voltage Multi-Range DC Power Supplies

MR Series



The MR Series high voltage multi-range DC power supplies deliver up to 5 kW of clean output power in a compact 2U form factor. These power supplies are suited for both bench use and automated test system applications requiring a wide range of voltage and current. For benchtop applications, this series offers an intuitive user interface for list mode programming and slew rate adjustments directly from the front panel. Operating software is provided for test sequence generation and data logging without the need to write source code.

Integrators will benefit from fast command response times, excellent regulation, and low noise characteristics. In addition, this series supports USB, GPIB, LXI compliant LAN, and analog interfaces for remote control and programming. Up to 50 power supplies can be daisy-chained and controlled from one PC, or connect multiple power supplies in parallel for increased output power.

The MR Series includes a built-in SAS (solar array simulator) function to generate I-V curves from the front panel. The optional SAS software allows users to simulate various weather conditions and consistently reproduce I-V curves while monitoring MPPT efficiency data.

System Integration

The MR Series offers many features for ATE system and integration applications.

Automation:

- LXI simplifies integration and system development
- Fast command response time (10 ms)
- LabVIEW™, IVI-C, and IVI.NET drivers included
- List mode programming
- Built-in web server

Integration:

- 2U form factor saves rack space
- Simple single-phase AC input
- Parallel operation
- Standard USB (USBTMC-compliant), RS232, GPIB and LXI compliant LAN interfaces
- Galvanically isolated analog control and monitoring interface
- cTUVus certification mark
- Comprehensive protection features for the power supply and DUT
- Thermostatically-controlled fans help minimize noise
- Optional rack-mount kit available

Features and benefits

- Output up to 1000 V or 120 A
- Multi-ranging operation, capable of replacing multiple fixed range power supplies
- Compact 2U form factor
- Standard USB (USBTMC-compliant), RS232, GPIB and LXI compliant LAN interfaces
- Galvanically isolated analog control and monitoring interface
- Protection features: OVP, OCP, OPP, OTP, foldback protection mode, and key-lock function
- Adjustable voltage and current slope (rise and fall time)
- List mode: 10 user-defined setups with up to 100 programmable steps each
- LED mode to minimize inrush current and protect LED panels
- Built-in SAS function for storage of up to 101 I-V curves with Voc, Isc, Vmp, Imp, parameters and 4096-point table
- Remote Sense to compensate for voltage drop
- Master/Slave mode operation provides up to 50 kW with 10 units connected in parallel
- Control up to 50 power supplies from one PC
- Soft panel software for remote control, test sequence generation, and data logging included
- cTUVus certification mark fulfills CSA and UL safety standards

Model	MR3K160120	MR160120	MR25080	MR50040	MR100020
Max. Output Voltage	160 V	160 V	250 V	500 V	1000 V
Max. Output Current	120 A	120 A	80 A	40 A	20 A
Max. Output Power	3000 W	5000 W			

Front panel

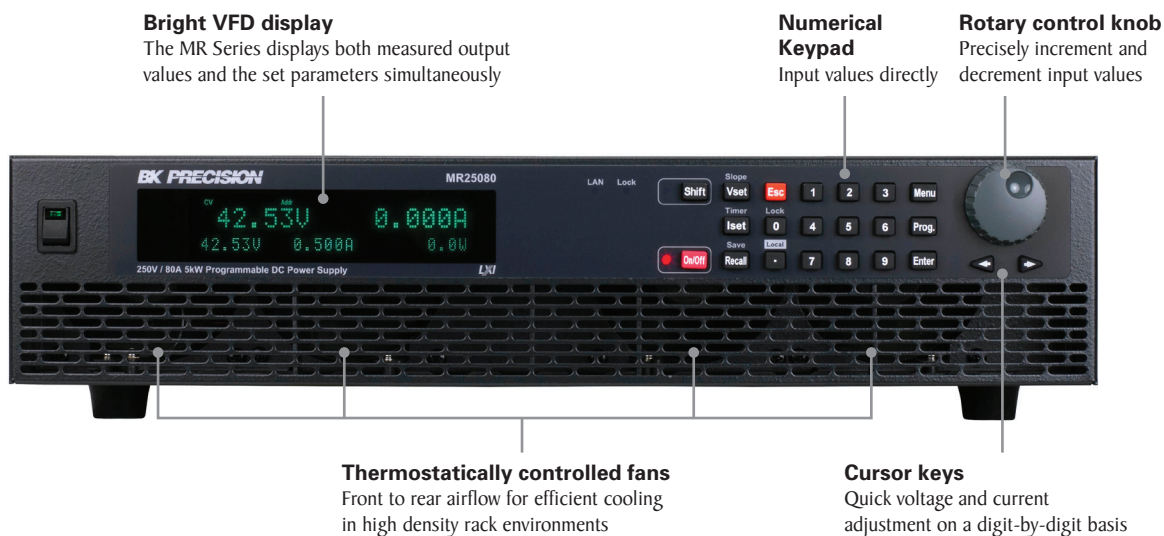

Rear panel

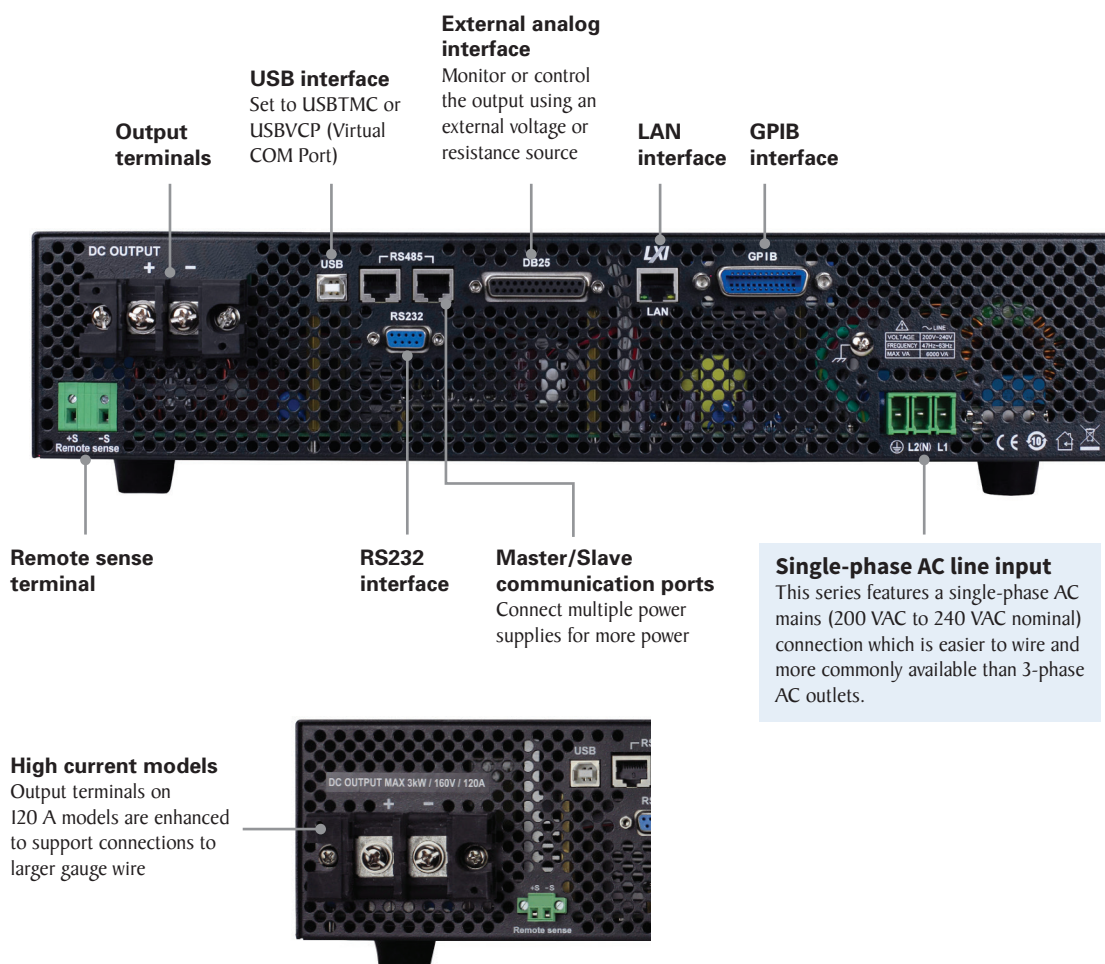

Models MR3K160I20 and MRI60I20

Flexible configuration and performance

Multi-range operation

Traditional power supplies with rectangular output characteristics only deliver maximum output power at one voltage/current point. Multi-range functionality broadens the maximum power output from one point to a range illustrated by the curves shown in the figure below. This flexibility means multi-range power supplies are capable of replacing multiple fixed range power supplies.

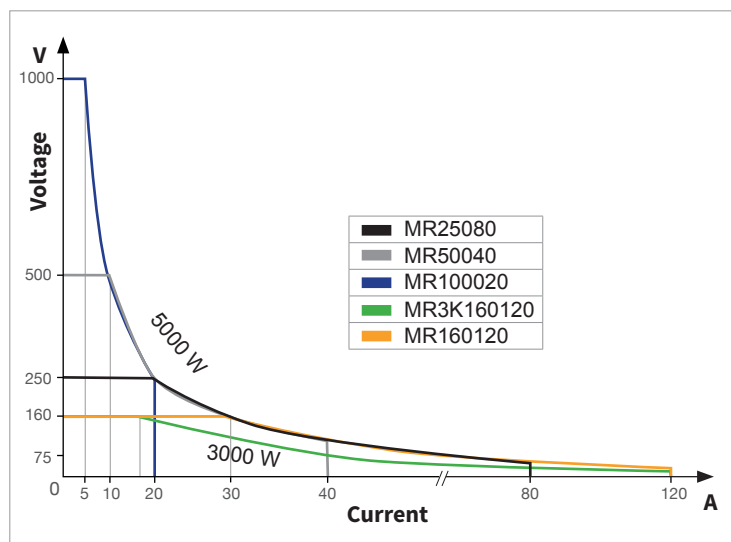

List mode

This feature allows users to program a list of steps to the power supply's internal memory and execute them directly from the front panel. A total of 100 steps can be allocated to each internal memory location, for up to 10 locations. Each step setting includes voltage, current, duration and output status. List mode sequences can also be programmed remotely through the USB, RS232, GPIB, or LAN interfaces using SCPI commands or with the included application software.

Accessories



AC input power cord (standard)



Rack mount kit model RKPVS (optional)

Device protection

To protect your DUT, the MR Series provides overvoltage (OVP), overcurrent (OCP), overpower (OPP), and overtemperature (OTP) protection. A fault will trigger an alarm and disable the output. Similarly, with constant voltage-to-constant current (CV-to-CC) or constant current-to-constant voltage (CC-to-CV) foldback protection mode activated, the output will be disabled if load changes force the supply to transition between the two operating modes.

Master/Slave operation

For more power, models with the same rating can be connected in parallel and operate in master/slave mode. The RJ45 ports are used for communication between the master and slave(s). Once configured, the master will automatically search for and detect slave units and display the voltage and current of the complete system.

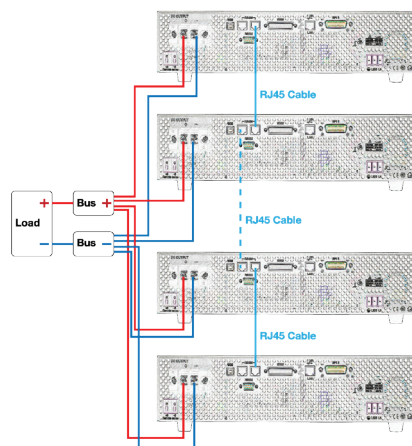

Multi-unit control

Up to 50 units can be daisy chained and controlled from one master unit through the USB, GPIB, or LAN interface.

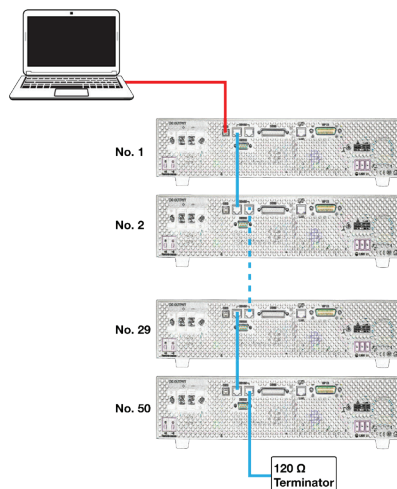

Remote control and programming

Adjustable slew rate and output timer

Slew rate setting allows users to control the voltage and current slope (rise and fall times). The timer-controlled output can be set from 1 second to 255 hours.

Analog programming and monitoring

The galvanically isolated analog interface can be used to monitor voltage, current, regulation mode (CV or CC), or to indicate fault conditions. In addition to front panel and PC interface control, the MR Series can be controlled from zero to full scale by an external voltage signal or resistor (0 to 5 V / 5 k Ω or 0 to 10 V / 10 k Ω selectable).

Web server interface

The MR Series provides a built-in web server that allows users to configure, control, and monitor the basic settings of the power supply, using a web browser on a computer connected to the same local area network.

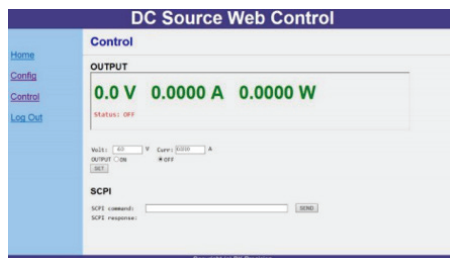

Socket and Telnet interface

The power supply can be configured for Socket or Telnet connections through the LAN (Ethernet) and controlled using SCPI commands.

Convenient front panel guided calibration

Using a 5 1/2 digit multimeter, voltage and current parameters can be conveniently calibrated from the front panel via the calibration menu.

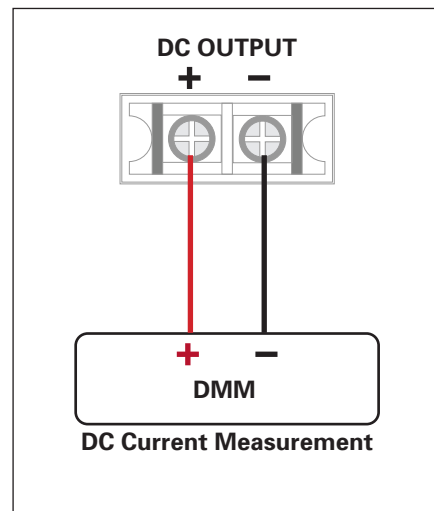

Application software and integration

PC software is provided for front panel emulation, generating and executing test sequences, or logging measurement data without the need to write source code.

- Log voltage, current, and power values as well as time stamp, CV/CC, and output status.
- Save and load list files to/from the power supply's internal memory.
- Create an unlimited number of external list files to be executed from PC memory. Save and recall list files to/from the PC.



Solar Array Simulation (SAS) Software Option

Solar inverter designers need to verify their inverter is capable of delivering the maximum power available from solar modules. The I-V curve of solar cells can be influenced by various weather conditions such as a cloudy day. Combined with the SAS application software, MR users can easily simulate the I-V curve of different arrays under various irradiance conditions while measuring and validating the effectiveness of the inverter's MPPT algorithm.

Features

- Variety of input parameters (Voc, Isc, Vmp, Imp, and temperature coefficient)
- Monitors and logs real-time voltage, current, power, MPPT efficiency, and average MPPT efficiency
- Simulate I-V curve under different weather conditions during a day
- User-definable irradiance profile
- Generate a custom I-V curve with up to 4,096 data points
- Test to EN50530, NB/T32004, Sandia lab standards

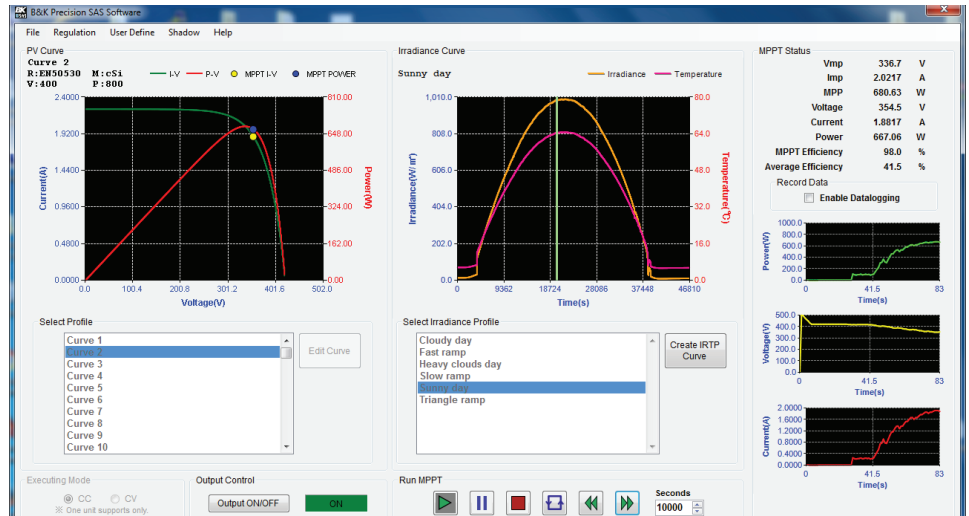

PV Simulation

Solar arrays consist of multiple solar cells characterized by a complex voltage and current profile that is represented in an I-V curve.

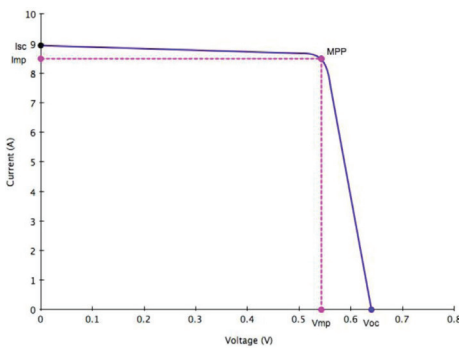

PV simulation curve

The MR power supply outputs points on the I-V curve in 1 ms intervals to test the inverter's MPPT efficiency.

A1		
	A	B
1	1000	0
2	999.873	0.0049
3	999.746	0.0098
4	999.619	0.0147
5	999.492	0.0196
6	999.365	0.0244
7	999.238	0.0293

Generate custom I-V curves using Excel or Notepad to create a 4,096 point voltage and current table. Use the SAS software to download the I-V curve table to the power supply's internal memory for output.

Voc 21.40 V Isc 0.6100 A Add
 Vmp 17.50 V Imp 0.5700 A Update
 β -0.330 % Delete
 * Ref Value => Irradiance = 1000 W/m², Temperature = 25°C

Automatically generate PV and I-V curves by specifying open circuit voltage (Voc), short circuit current (Isc), maximum power voltage (Vmp), and maximum power current (Imp) along with temperature coefficient (β).

Shadow Setting
 Data Number 128 Cloud Moving
 Shadow Color Initializing Time 10 Sec
 Irradiance 499 W/m² Executing Time 3000 Sec
 Temperature 25.0 °C Changing Time 20 Sec
 Initial Run

Shadow Simulation

Use the shadow simulation mode to test solar arrays under different weather conditions. Adjust cloud intensity, cloud direction, and timing parameters. Resulting PV and I-V curves are automatically generated along with MPPT efficiency data.

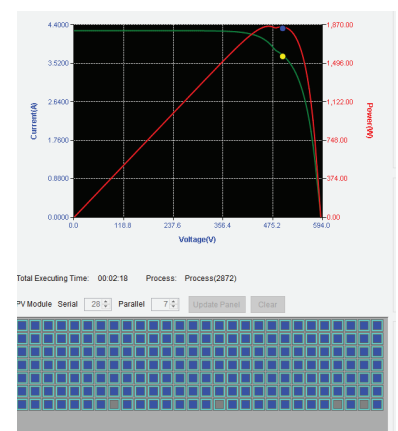

Free Trial
 Try SAS software free for 30 days.
 Visit bkprecision.com to learn more.

High Voltage Multi-Range DC Power Supplies

MR Series

Specifications

Note: All specifications apply to the unit after a temperature stabilization time of 15 minutes over an ambient temperature range of 23 °C ± 5 °C. Specifications are valid for single unit operation only.

Model		MR3K160120	MR160120	MR25080	MR50040	MR100020
Output Rating						
Output Voltage	0 to 160 V		0 to 250 V		0 to 500 V	0 to 1000 V
Output Current	0 to 120 A		0 to 80 A		0 to 40 A	0 to 20 A
Output Power	3000 W	5000 W				
Line Regulation						
Voltage	32 mV		15 mV		55 mV	80 mV
Current	60 mA		20 mA		12 mA	10 mA
Load Regulation						
Voltage	80 mV		120 mV		200 mV	250 mV
Current	180 mA		50 mA		40 mA	25 mA
Ripple and Noise (20 Hz to 20 MHz)						
Voltage p-p	120 mV	160 mV		500 mV	600 mV	700 mV
Voltage rms	48 mV		85 mV		75 mV	120 mV
Current rms ⁽¹⁾	120 mA	160 mA		20 mA	10 mA	5 mA
Resolution						
Programming	10 mV / 7.5 mA		10 mV / 5 mA		20 mV / 2 mA	100 mV / 1 mA
Readback	10 mV / 7.5 mA		10 mV / 5 mA		20 mV / 2 mA	100 mV / 1 mA
Programming Accuracy						
Voltage	160 mV		100 mV		300 mV	500 mV
Current	360 mA		60 mA		50 mA	25 mA
Readback Accuracy						
Voltage	160 mV		250 mV		300 mV	500 mV
Current	240 mA		60 mA		50 mA	25 mA
Output Response Time⁽²⁾						
Rise Time	Full Load	≤ 30 ms		≤ 30 ms		
	No Load	≤ 30 ms		≤ 30 ms		
Fall Time	Full Load	≤ 80 ms	≤ 50 ms	≤ 55 ms	≤ 40 ms	≤ 50 ms
	No Load	≤ 10 s		≤ 8 s	≤ 10 s	≤ 10 s
Protection						
OVP	Range	0 to 176 V		0 to 275 V	0 to 550 V	0 to 1100 V
	Accuracy	1.6 V		2.5 V	5 V	10 V
OCP	Range	0 to 132 A		0 to 96 A	0 to 48 A	0 to 24 A
	Accuracy	1.2 A		0.8 A	0.4 A	0.2 A

(1) Current ripple is applied when output power > 1.0% of full power.

(2) From 10% to 90% or from 90% to 10% of total voltage excursion.

High Voltage Multi-Range DC Power Supplies

MR Series

Model	MR3K160120	MR160120	MR25080	MR50040	MR100020
General					
Remote Sense Compensation	3.2 V		5 V	10 V	20 V
Transient Response Time ⁽³⁾	≤ 1.5 ms				
Command Response Time ⁽⁴⁾	10 ms				
Efficiency ⁽⁵⁾	≥ 80%	≥ 85%			
Power Factor	0.99				
I/O Interfaces	Analog (Galvanically isolated DB25), USB (USBTMC-compliant and virtual COM), RS232, GPIB, LAN (1.5 LXI device specification 2016)				
AC Line Input	200 to 240 VAC ± 10%, 47 Hz to 63 Hz				
AC Line Phase	Single phase				
Maximum Rated Input Power	4000 VA	6000 VA			
Temperature Ratings	Operation	32 °F to 104 °F (0 °C to 40 °C)			
	Storage	14 °F to 158 °F (-10 °C to 70 °C)			
Temperature Coefficient	Voltage	32 mV / °C	50 mV / °C	100 mV / °C	200 mV / °C
	Current	48 mA / °C	32 mA / °C	16 mA / °C	8 mA / °C
Dimensions (W×H×D)	16.5" x 3.5" x 21" (420 x 88 x 532 mm)				
Weight	38.6 lbs (17.5 kg)				
Warranty	3 Years				
Standard Accessories	Power cord, test report & certificate of calibration				
Optional Accessories	Rack mount kit (RKPVS)				

Regulatory Compliance	
Safety	Low Voltage Directive (LVD) 2014/35/EU, EN61010-1:2010, cTUVus certification mark ⁽⁶⁾ fulfills US (UL 61010-1:2012) and Canadian (CAN/CSA-C22.2 NO. 61010-1-12) safety standards
Electromagnetic Compatibility	EMC Directive 2014/30/EU, EN61326-1:2013

(3) Time for output voltage to recover within 1% of its rated output voltage for a load change 50-100% of rated output current.

(4) Typical time required for output to begin to change following receipt of command data.

(5) At nominal line and maximum load.

(6) Tested and certified by a Nationally Recognized Testing Laboratory (NRTL), accredited by OSHA.

Ordering Information

MR Series Power Supplies

Model	Description
MR3K160120	160 V / 120 A, 3000 W
MR160120	160 V / 120 A, 5000 W
MR25080	250 V / 80 A, 5000 W
MR50040	500 V / 40 A, 5000 W
MR100020	1000 V / 20 A, 5000 W