

# Keysight InfiniiVision 3000T X-Series Oscilloscopes

User's Guide

# Notices

© Keysight Technologies, Inc. 2005-2017

No part of this manual may be reproduced in any form or by any means (including electronic storage and retrieval or translation into a foreign language) without prior agreement and written consent from Keysight Technologies, Inc. as governed by United States and international copyright laws.

## Manual Part Number

75037-97038

## Edition

Fourth edition, April 2017

Available in electronic format only

Published by:

Keysight Technologies, Inc.  
1900 Garden of the Gods Road  
Colorado Springs, CO 80907 USA

## Print History

75037-97000, November 2014

75037-97013, August 2015

75037-97025, July 2016

75037-97038, April 2017

## Warranty

**The material contained in this document is provided "as is," and is subject to being changed, without notice, in future editions. Further, to the maximum extent permitted by applicable law, Keysight disclaims all warranties, either express or implied, with regard to this manual and any information contained herein, including but not limited to the implied warranties of merchantability and fitness for a particular purpose. Keysight shall not be liable for errors or for incidental or consequential damages in connection with the furnishing, use, or performance of this document or of any information contained herein. Should Keysight and the user have a separate**

**written agreement with warranty terms covering the material in this document that conflict with these terms, the warranty terms in the separate agreement shall control.**

## Technology License

The hardware and/or software described in this document are furnished under a license and may be used or copied only in accordance with the terms of such license.

## U.S. Government Rights

The Software is "commercial computer software," as defined by Federal Acquisition Regulation ("FAR") 2.101. Pursuant to FAR 12.212 and 27.405-3 and Department of Defense FAR Supplement ("DFARS") 227.7202, the U.S. government acquires commercial computer software under the same terms by which the software is customarily provided to the public. Accordingly, Keysight provides the Software to U.S. government customers under its standard commercial license, which is embodied in its End User License Agreement (EULA), a copy of which can be found at [www.keysight.com/find/sweula](http://www.keysight.com/find/sweula). The license set forth in the EULA represents the exclusive authority by which the U.S. government may use, modify, distribute, or disclose the Software. The EULA and the license set forth therein, does not require or permit, among other things, that Keysight: (1) Furnish technical information related to commercial computer software or commercial computer software documentation that is not customarily provided to the public; or (2) Relinquish to, or otherwise provide, the government rights in excess of these rights customarily provided to the public to use, modify, reproduce, release, perform, display, or disclose commercial computer software or commercial computer software documentation. No additional government requirements beyond those set forth in the EULA shall apply, except to the extent that

those terms, rights, or licenses are explicitly required from all providers of commercial computer software pursuant to the FAR and the DFARS and are set forth specifically in writing elsewhere in the EULA. Keysight shall be under no obligation to update, revise or otherwise modify the Software. With respect to any technical data as defined by FAR 2.101, pursuant to FAR 12.211 and 27.404.2 and DFARS 227.7102, the U.S. government acquires no greater than Limited Rights as defined in FAR 27.401 or DFAR 227.7103-5 (c), as applicable in any technical data.

## Safety Notices

This product has been designed and tested in accordance with accepted industry standards, and has been supplied in a safe condition. The documentation contains information and warnings that must be followed by the user to ensure safe operation and to maintain the product in a safe condition.

### CAUTION

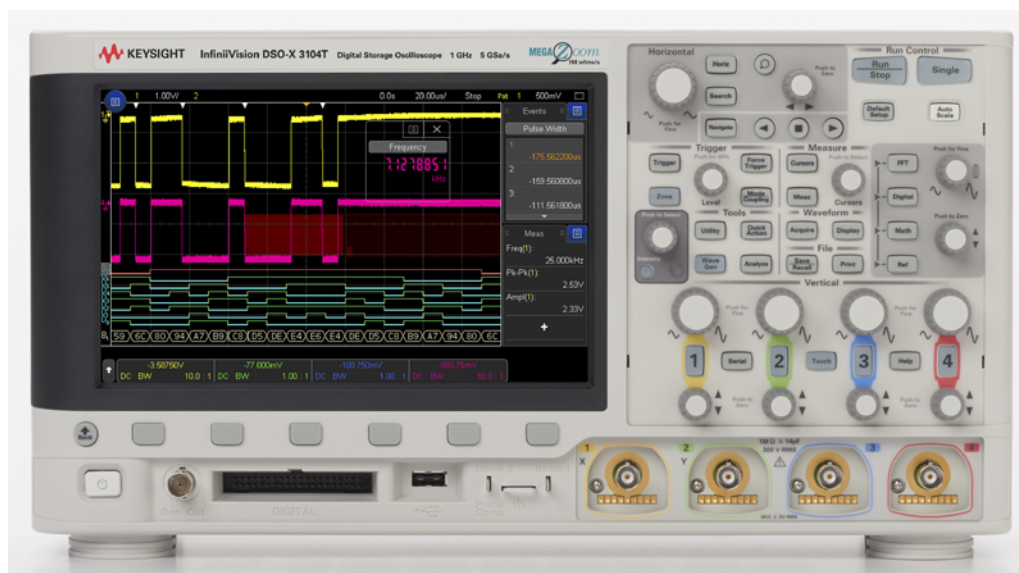
A **CAUTION** notice denotes a hazard. It calls attention to an operating procedure, practice, or the like that, if not correctly performed or adhered to, could result in damage to the product or loss of important data. Do not proceed beyond a **CAUTION** notice until the indicated conditions are fully understood and met.

## **WARNING**

**A WARNING notice denotes a hazard. It calls attention to an operating procedure, practice, or the like that, if not correctly performed or adhered to, could result in personal injury or death. Do not proceed beyond a WARNING notice until the indicated conditions are fully understood and met.**

---

# InfiniiVision 3000T X-Series Oscilloscopes—At a Glance




**Table 1** InfiniiVision 3000T X-Series Oscilloscope Models, Band widths, Sample Rates

Band width	100 MHz	200 MHz	350 MHz	500 MHz	1 GHz
Sample Rate (interleaved, non-interleaved)	5 GSa/s, 2.5 GSa/s	5 GSa/s, 2.5 GSa/s	5 GSa/s, 2.5 GSa/s	5 GSa/s, 2.5 GSa/s	5 GSa/s, 2.5 GSa/s
2-Channel + 16 Logic Channels MSO	MSO-X 3012T	MSO-X 3022T	MSO-X 3032T	MSO-X 3052T	MSO-X 3102T
4-Channel + 16 Logic Channels MSO	MSO-X 3014T	MSO-X 3024T	MSO-X 3034T	MSO-X 3054T	MSO-X 3104T
2-Channel DSO	DSO-X 3012T	DSO-X 3022T	DSO-X 3032T	DSO-X 3052T	DSO-X 3102T
4-Channel DSO	DSO-X 3014T	DSO-X 3024T	DSO-X 3034T	DSO-X 3054T	DSO-X 3104T

The Keysight InfiniiVision 3000T X-Series oscilloscopes deliver these features:

- 100 MHz, 200 MHz, 350 MHz, 500 MHz, and 1 GHz bandwidth models.

- 2- and 4-channel digital storage oscilloscope (DSO) models.
- 2+16-channel and 4+16-channel mixed-signal oscilloscope (MSO) models.  
An MSO lets you debug your mixed-signal designs using analog signals and tightly correlated digital signals simultaneously. The 16 digital channels have a 1.25 GSa/s sample rate, with a 200 MHz toggle rate.
- 8.5 inch WVGA touchscreen display. The touchscreen makes the oscilloscope easier to use:
  - You can "touch" inside alpha-numeric keypad dialogs to enter file, label, network, and printer names, etc., instead of using softkeys and the  Entry knob.
  - You can drag a finger across the screen to draw rectangular boxes for zooming in on waveforms or setting up Zone triggers.
  - You can touch the blue menu icon in the sidebar to display information or control dialogs. You can drag (undock) these dialogs out of the sidebar, for example, to view cursor values and measurements at the same time.
  - You can touch other areas of the screen as substitutes for using front panel keys, softkeys, and knobs.
- Interleaved 4 Mpts or non-interleaved 2 Mpts MegaZoom IV memory for the fastest waveform update rates, uncompromised.
- All knobs are pushable for making quick selections.
- Trigger types: edge, edge then edge, pulse width, pattern, OR, rise/fall time, Nth edge burst, runt, setup & hold, video, NFC, and zone.
- Serial decode/trigger options for: CAN/CAN FD/LIN, CXPI, FlexRay, I<sup>2</sup>C/SPI, I<sup>2</sup>S, Manchester/NRZ, MIL-STD-1553/ARINC 429, SENT, and UART/RS232. There is a Lister for displaying serial decode packets.
- Dedicated **[FFT]** key and FFT waveform math function.
- Two additional math waveforms: add, subtract, multiply, divide, d/dt, integrate, FFT (Magnitude), FFT (Phase), Ax+B, square, square root, absolute value, common logarithm, natural logarithm, exponential, base 10 exponential, low pass filter, high pass filter, averaged value, smoothing, envelope, magnify, maximum, minimum, peak-peak, max hold, min hold, measurement trend, chart logic bus timing, and chart logic bus state.
- Reference waveform locations (2) for comparing with other channel or math waveforms.
- Many built-in measurements and a measurement statistics display.

- Built-in, license-enabled 1-channel waveform generator with: arbitrary, sine, square, ramp, pulse, DC, noise, sine cardinal, exponential rise, exponential fall, cardiac, and Gaussian pulse. Modulated waveforms on WaveGen except for arbitrary, pulse, DC, and noise waveforms.
- USB ports make printing, saving and sharing data easy.
- Optional LAN/VGA module for connecting to a network and displaying the screen on a different monitor.
- Optional GPIB module.
- A Quick Help system is built into the oscilloscope. Press and hold any key to display Quick Help. Complete instructions for using the quick help system are given in **"Access the Built-In Quick Help"** on page 61.

For more information about InfiniiVision oscilloscopes, see:

[www.keysight.com/find/scope](http://www.keysight.com/find/scope)

# In This Guide

This guide shows how to use the InfiniiVision 3000T X-Series oscilloscopes.

When unpacking and using the oscilloscope for the first time, see:	<ul style="list-style-type: none"><li>▪ <b>Chapter 1</b>, “Getting Started,” starting on page 27</li></ul>
When displaying waveforms and acquired data, see:	<ul style="list-style-type: none"><li>▪ <b>Chapter 2</b>, “Horizontal Controls,” starting on page 63</li><li>▪ <b>Chapter 3</b>, “Vertical Controls,” starting on page 79</li><li>▪ <b>Chapter 4</b>, “FFT Spectral Analysis,” starting on page 89</li><li>▪ <b>Chapter 5</b>, “Math Waveforms,” starting on page 99</li><li>▪ <b>Chapter 6</b>, “Reference Waveforms,” starting on page 127</li><li>▪ <b>Chapter 7</b>, “Digital Channels,” starting on page 131</li><li>▪ <b>Chapter 8</b>, “Serial Decode,” starting on page 149</li><li>▪ <b>Chapter 9</b>, “Display Settings,” starting on page 155</li><li>▪ <b>Chapter 10</b>, “Labels,” starting on page 161</li></ul>
When setting up triggers or changing how data is acquired, see:	<ul style="list-style-type: none"><li>▪ <b>Chapter 11</b>, “Triggers,” starting on page 169</li><li>▪ <b>Chapter 12</b>, “Trigger Mode/Coupling,” starting on page 207</li><li>▪ <b>Chapter 13</b>, “Acquisition Control,” starting on page 215</li></ul>
Making measurements and analyzing data:	<ul style="list-style-type: none"><li>▪ <b>Chapter 14</b>, “Cursors,” starting on page 233</li><li>▪ <b>Chapter 15</b>, “Measurements,” starting on page 243</li><li>▪ <b>Chapter 16</b>, “Mask Testing,” starting on page 275</li><li>▪ <b>Chapter 17</b>, “Digital Voltmeter and Counter,” starting on page 289</li><li>▪ <b>Chapter 18</b>, “Frequency Response Analysis,” starting on page 295</li></ul>
When using the built-in license enabled waveform generator, see:	<ul style="list-style-type: none"><li>▪ <b>Chapter 19</b>, “Waveform Generator,” starting on page 301</li></ul>
When saving, recalling, or printing, see:	<ul style="list-style-type: none"><li>▪ <b>Chapter 20</b>, “Save/Email/Recall (Setups, Screens, Data),” starting on page 321</li><li>▪ <b>Chapter 21</b>, “Print (Screens),” starting on page 335</li></ul>

When using the oscilloscope's utility functions or web interface, see:	<ul style="list-style-type: none"> <li>▪ <a href="#">Chapter 22</a>, “Utility Settings,” starting on page 341</li> <li>▪ <a href="#">Chapter 23</a>, “Web Interface,” starting on page 359</li> </ul>
For reference information, see:	<ul style="list-style-type: none"> <li>▪ <a href="#">Chapter 24</a>, “Reference,” starting on page 375</li> </ul>
When using licensed serial bus triggering and decode features, see:	<ul style="list-style-type: none"> <li>▪ <a href="#">Chapter 25</a>, “CAN/LIN Triggering and Serial Decode,” starting on page 395</li> <li>▪ <a href="#">Chapter 26</a>, “CXPI Triggering and Serial Decode,” starting on page 417</li> <li>▪ <a href="#">Chapter 27</a>, “FlexRay Triggering and Serial Decode,” starting on page 427</li> <li>▪ <a href="#">Chapter 28</a>, “I2C/SPI Triggering and Serial Decode,” starting on page 437</li> <li>▪ <a href="#">Chapter 29</a>, “I2S Triggering and Serial Decode,” starting on page 455</li> <li>▪ <a href="#">Chapter 30</a>, “Manchester/NRZ Triggering and Serial Decode,” starting on page 465</li> <li>▪ <a href="#">Chapter 31</a>, “MIL-STD-1553/ARINC 429 Triggering and Serial Decode,” starting on page 481</li> <li>▪ <a href="#">Chapter 32</a>, “SENT Triggering and Serial Decode,” starting on page 497</li> <li>▪ <a href="#">Chapter 33</a>, “UART/RS232 Triggering and Serial Decode,” starting on page 511</li> </ul>

## NOTE

### Abbreviated instructions for pressing a series of keys and softkeys

Instructions for pressing a series of keys are written in an abbreviated manner. Instructions for pressing **[Key1]**, then pressing **Softkey2**, then pressing **Softkey3** are abbreviated as follows:

Press **[Key1]** > **Softkey2** > **Softkey3**.

The keys may be a front panel **[Key]** or a **Softkey**. Softkeys are the six keys located directly below the oscilloscope display.



# Contents

InfiniiVision 3000T X-Series Oscilloscopes—At a Glance / 4

In This Guide / 7

## 1 Getting Started

Inspect the Package Contents / 27

Install the Optional LAN/VGA or GPIB Module / 30

Tilt the Oscilloscope for Easy Viewing / 30

Power-On the Oscilloscope / 31

Connect Probes to the Oscilloscope / 32



Maximum input voltage at analog inputs / 32



Do not float the oscilloscope chassis / 33

Input a Waveform / 33

Recall the Default Oscilloscope Setup / 33

Use Autoscale / 34

Compensate Passive Probes / 36

Learn the Front Panel Controls and Connectors / 37

Front Panel Overlays for Different Languages / 44

Learn the Touchscreen Controls / 45

Draw Rectangles for Waveform Zoom or Zone Trigger Set  
Up / 46

Flick or Drag to Scale, Position, and Change Offset / 47

Select Sidebar Information or Controls / 49

Undock Sidebar Dialogs by Dragging	/ 49
Re-dock Sidebar Dialogs to Split Sidebar	/ 50
Select Dialog Menus and Close Dialogs	/ 51
Drag Cursors	/ 51
Touch Softkeys and Menus On the Screen	/ 51
Enter Names Using Alpha-Numeric Keypad Dialogs	/ 52
Change Waveform Offsets By Dragging Ground Reference Icons	/ 53
Access Controls and Menus Via the Menu Icon	/ 54
Turn Channels On/Off and Open Scale/Offset Dialogs	/ 55
Access the Horizontal Menu and Open the Scale/Delay Dialog	/ 56
Access the Trigger Menu, Change the Trigger Mode, and Open the Trigger Level Dialog	/ 57
Use a USB Mouse and/or Keyboard for Touchscreen Controls	/ 58
Learn the Rear Panel Connectors	/ 58
Learn the Oscilloscope Display	/ 59
Access the Built-In Quick Help	/ 61

## 2 Horizontal Controls

To adjust the horizontal (time/div) scale	/ 64
To adjust the horizontal delay (position)	/ 65
Panning and Zooming Single or Stopped Acquisitions	/ 66
To change the horizontal time mode (Normal, XY, or Roll)	/ 67
XY Time Mode	/ 68
To display the zoomed time base	/ 71
To change the horizontal scale knob's coarse/fine adjustment setting	/ 72
To position the time reference (left, center, right, custom)	/ 72

- Searching for Events / 73
  - To set up searches / 74
  - To copy search setups / 74
- Navigating the Time Base / 75
  - To navigate time / 75
  - To navigate search events / 75
  - To navigate segments / 76

### 3 Vertical Controls

- To turn waveforms on or off (channel or math) / 80
- To adjust the vertical scale / 81
- To adjust the vertical position / 81
- To specify channel coupling / 81
- To specify channel input impedance / 82
- To specify bandwidth limiting / 83
- To change the vertical scale knob's coarse/fine adjustment setting / 83
- To invert a waveform / 84
- Setting Analog Channel Probe Options / 84
  - To specify the channel units / 85
  - To specify the probe attenuation / 85
  - To specify the probe skew / 86
  - To calibrate a probe / 86

### 4 FFT Spectral Analysis

- Searching for FFT Peaks / 93
- FFT Measurement Hints / 93
- FFT Units / 95
- FFT DC Value / 95

FFT Aliasing / 95

FFT Spectral Leakage / 97

## 5 Math Waveforms

To display math waveforms / 99

To adjust the math waveform scale and offset / 101

Units for Math Waveforms / 101

Math Operators / 102

Add or Subtract / 102

Multiply or Divide / 103

Math Transforms / 104

Differentiate / 105

Integrate / 106

FFT Magnitude, FFT Phase / 108

Square Root / 113

$Ax + B$  / 114

Square / 115

Absolute Value / 115

Common Logarithm / 116

Natural Logarithm / 116

Exponential / 117

Base 10 Exponential / 117

Math Filters / 118

High Pass and Low Pass Filter / 118

Averaged Value / 119

Smoothing / 120

Envelope / 120

Math Visualizations / 121

Magnify / 121

Maximum/Minimum / 122


Peak-Peak / 122  
Max/Min Hold / 122  
Measurement Trend / 122  
Chart Logic Bus Timing / 124  
Chart Logic Bus State / 125

## 6 Reference Waveforms

To save a waveform to a reference waveform location / 127  
To display a reference waveform / 128  
To scale and position reference waveforms / 129  
To adjust reference waveform skew / 129  
To display reference waveform information / 130  
To save/recall reference waveform files to/from a USB storage device / 130

## 7 Digital Channels

To connect the digital probes to the device under test / 131

  
Probe cable for digital channels / 132

Acquiring waveforms using the digital channels / 135  
To display digital channels using Autoscale / 135  
Interpreting the digital waveform display / 136  
To change the displayed size of the digital channels / 137  
To switch a single channel on or off / 138  
To switch all digital channels on or off / 138  
To switch groups of channels on or off / 138  
To change the logic threshold for digital channels / 138  
To reposition a digital channel / 139

To display digital channels as a bus / 140

Digital channel signal fidelity: Probe impedance and grounding / 143

Input Impedance / 143

Probe Grounding / 145

Best Probing Practices / 147

## 8 Serial Decode

Serial Decode Options / 149

Lister / 151

Searching Lister Data / 152

## 9 Display Settings

To adjust waveform intensity / 155

To set or clear persistence / 157

To clear the display / 158

To select the grid type / 158

To adjust the grid intensity / 159

To freeze the display / 159

## 10 Labels

To turn the label display on or off / 161

To assign a predefined label to a channel / 162

To define a new label / 163

To load a list of labels from a text file you create / 164

To reset the label library to the factory default / 165

To add an annotation / 166

## 11 Triggers

- Adjusting the Trigger Level / 170
- Forcing a Trigger / 171
- Edge Trigger / 172
- Edge then Edge Trigger / 174
- Pulse Width Trigger / 175
- Pattern Trigger / 178
  - Hex Bus Pattern Trigger / 180
- OR Trigger / 181
- Rise/Fall Time Trigger / 182
- Near Field Communication (NFC) Trigger / 183
- Nth Edge Burst Trigger / 186
- Runt Trigger / 188
- Setup and Hold Trigger / 190
- Video Trigger / 191
  - To set up Generic video triggers / 195
  - To trigger on a specific line of video / 196
  - To trigger on all sync pulses / 197
  - To trigger on a specific field of the video signal / 198
  - To trigger on all fields of the video signal / 199
  - To trigger on odd or even fields / 200
- Serial Trigger / 203
- Zone Qualified Trigger / 204

## 12 Trigger Mode/Coupling

- To select the Auto or Normal trigger mode / 208
- To select the trigger coupling / 209

To enable or disable trigger noise rejection / 211

To enable or disable trigger HF Reject / 211

To set the trigger holdoff / 212

External Trigger Input / 213



Maximum voltage at oscilloscope external trigger input / 213

## 13 Acquisition Control

Running, Stopping, and Making Single Acquisitions (Run Control) / 215

Overview of Sampling / 217

Sampling Theory / 217

Aliasing / 217

Oscilloscope Bandwidth and Sample Rate / 218

Oscilloscope Rise Time / 219

Oscilloscope Bandwidth Required / 220

Memory Depth and Sample Rate / 221

Selecting the Acquisition Mode / 221

Normal Acquisition Mode / 222

Peak Detect Acquisition Mode / 222

Averaging Acquisition Mode / 225

High Resolution Acquisition Mode / 227

Realtime Sampling Option / 227

Realtime Sampling and Oscilloscope Bandwidth / 228

Acquiring to Segmented Memory / 229

Navigating Segments / 230

Measurements, Statistics, and Infinite Persistence with Segmented Memory / 231

Segmented Memory Re-Arm Time / 231

Saving Data from Segmented Memory / 231



## 14 Cursors

To make cursor measurements / 234

Cursor Examples / 237

## 15 Measurements

To make automatic measurements / 244

To edit measurements / 246

Measurements Summary / 246

Snapshot All / 249

Voltage Measurements / 250

Peak-Peak / 251

Maximum / 251

Minimum / 251

Amplitude / 251

Top / 251

Base / 252

Overshoot / 252

Preshoot / 254

Average / 254

DC RMS / 255

AC RMS / 255

Ratio / 257

Time Measurements / 257

Period / 258

Frequency / 258

Counter / 259

+ Width / 260

- Width / 260

Burst Width / 260

Duty Cycle / 260

Bit Rate / 261

Rise Time	/ 261
Fall Time	/ 261
Delay	/ 261
Phase	/ 262
X at Min Y	/ 264
X at Max Y	/ 264
Count Measurements	/ 265
Positive Pulse Count	/ 265
Negative Pulse Count	/ 265
Rising Edge Count	/ 266
Falling Edges Count	/ 266
Mixed Measurements	/ 266
Area	/ 266
FFT Analysis Measurements	/ 267
Channel Power	/ 267
Occupied Bandwidth	/ 268
Adjacent Channel Power Ratio (ACPR)	/ 268
Total Harmonic Distortion (THD)	/ 269
Measurement Thresholds	/ 270
Measurement Window	/ 272
Measurement Statistics	/ 272

## 16 Mask Testing

To create a mask from a "golden" waveform (Automask)	/ 275
Mask Test Setup Options	/ 277
Mask Statistics	/ 280
To manually modify a mask file	/ 281
Building a Mask File	/ 284
How is mask testing done?	/ 287

## 17 Digital Voltmeter and Counter

Digital Voltmeter / 290

Counter / 291

## 18 Frequency Response Analysis

To make connections / 295

To set up and run the analysis / 296

To view and save the analysis results / 298

## 19 Waveform Generator

To select generated waveform types and settings / 301

To edit arbitrary waveforms / 305

    Creating New Arbitrary Waveforms / 306

    Editing Existing Arbitrary Waveforms / 307

    Capturing Other Waveforms to the Arbitrary Waveform / 311

To output the waveform generator sync pulse / 312

To specify the expected output load / 312

To use waveform generator logic presets / 313

To add noise to the waveform generator output / 313

To add modulation to the waveform generator output / 314

    To set up Amplitude Modulation (AM) / 315

    To set up Frequency Modulation (FM) / 316

    To set up Frequency-Shift Keying Modulation (FSK) / 317

To restore waveform generator defaults / 318

## 20 Save/Email/Recall (Setups, Screens, Data)

Saving Setups, Screen Images, or Data / 321

    To save setup files / 323

    To save BMP or PNG image files / 324

- To save CSV, ASCII XY, or BIN data files / 324
- Length Control / 326
- To save Lister data files / 327
- To save reference waveform files to a USB storage device / 327
- To save masks / 328
- To save arbitrary waveforms / 328
- To navigate storage locations / 329
- To enter file names / 329

Emailing Setups, Screen Images, or Data / 330

Recalling Setups, Masks, or Data / 331

- To recall setup files / 332
- To recall mask files / 332
- To recall reference waveform files from a USB storage device / 332
- To recall arbitrary waveforms / 333

Recalling Default Setups / 333

Performing a Secure Erase / 334

## 21 Print (Screens)

- To print the oscilloscope's display / 335
- To set up network printer connections / 337
- To specify the print options / 338
- To specify the palette option / 339

## 22 Utility Settings

- I/O Interface Settings / 341
- Setting up the Oscilloscope's LAN Connection / 342
  - To establish a LAN connection / 343
  - Stand-alone (Point-to-Point) Connection to a PC / 344
- File Explorer / 344

Setting Oscilloscope Preferences /	346
To choose "expand about" center or ground /	347
To disable/enable transparent backgrounds /	347
To load the default label library /	347
To set up the screen saver /	348
To set Autoscale preferences /	349
Setting the Oscilloscope's Clock /	349
Setting the Rear Panel TRIG OUT Source /	350
Enabling Remote Command Logging /	351
Performing Service Tasks /	352
To perform user calibration /	352
To perform hardware self test /	355
To perform front panel self test /	356
To display oscilloscope information /	356
To display the user calibration status /	356
To clean the oscilloscope /	356
To check warranty and extended services status /	356
To contact Keysight /	357
To return the instrument /	357
Configuring the [Quick Action] Key /	357

## 23 Web Interface

Accessing the Web Interface /	360
Browser Web Control /	361
Full Scope Remote Front Panel /	362
Screen Only Remote Front Panel /	363
Tablet Remote Front Panel /	364
Remote Programming via the Web Interface /	365
Remote Programming with Keysight IO Libraries /	366
Save/Recall /	367

Saving Files via the Web Interface / 367  
Recalling Files via the Web Interface / 368

Get Image / 369

Identification Function / 370

Instrument Utilities / 370

Setting a Password / 372

## 24 Reference

Specifications and Characteristics / 375

Measurement Category / 375

Oscilloscope Measurement Category / 375

Measurement Category Definitions / 376

Maximum Input Voltages / 376



Maximum input voltage at analog inputs / 376



Maximum input voltage at digital channels / 377

Environmental Conditions / 377

Probes and Accessories / 378

Loading Licenses and Displaying License Information / 378

Licensed Options Available / 379

Other Options Available / 380

Upgrading to an MSO / 380

Software and Firmware Updates / 380

Binary Data (.bin) Format / 381

Binary Data in MATLAB / 382

Binary Header Format / 382

Example Program for Reading Binary Data / 385

Examples of Binary Files / 385

CSV and ASCII XY files /	388
CSV and ASCII XY file structure /	389
Minimum and Maximum Values in CSV Files /	389
Frequency Data in CSV Files /	390
Acknowledgements /	390
Product Markings and Regulatory Information /	392

## 25 CAN/LIN Triggering and Serial Decode

Setup for CAN/CAN FD Signals /	395
Loading and Displaying CAN Symbolic Data /	398
CAN/CAN FD Triggering /	399
CAN/CAN FD Serial Decode /	402
Interpreting CAN/CAN FD Decode /	403
CAN Totalizer /	404
Interpreting CAN Lister Data /	405
Searching for CAN Data in the Lister /	406
Setup for LIN Signals /	407
Loading and Displaying LIN Symbolic Data /	409
LIN Triggering /	409
LIN Serial Decode /	411
Interpreting LIN Decode /	413
Interpreting LIN Lister Data /	414
Searching for LIN Data in the Lister /	414

## 26 CXPI Triggering and Serial Decode

Setup for CXPI Signals /	417
CXPI Triggering /	418
CXPI Serial Decode /	421
Interpreting CXPI Decode /	423

Interpreting CXPI Lister Data / 425

## 27 FlexRay Triggering and Serial Decode

Setup for FlexRay Signals / 427

FlexRay Triggering / 428

Triggering on FlexRay Frames / 429

Triggering on FlexRay Errors / 430

Triggering on FlexRay Events / 430

FlexRay Serial Decode / 431

Interpreting FlexRay Decode / 432

FlexRay Totalizer / 433

Interpreting FlexRay Lister Data / 434

Searching for FlexRay Data in the Lister / 434

## 28 I2C/SPI Triggering and Serial Decode

Setup for I2C Signals / 437

I2C Triggering / 438

I2C Serial Decode / 442

Interpreting I2C Decode / 443

Interpreting I2C Lister Data / 444

Searching for I2C Data in the Lister / 444

Setup for SPI Signals / 445

SPI Triggering / 449

SPI Serial Decode / 451

Interpreting SPI Decode / 452

Interpreting SPI Lister Data / 453

Searching for SPI Data in the Lister / 453

## 29 I2S Triggering and Serial Decode

Setup for I2S Signals / 455



- I2S Triggering / 458
- I2S Serial Decode / 461
  - Interpreting I2S Decode / 462
  - Interpreting I2S Lister Data / 463
  - Searching for I2S Data in the Lister / 463

### **30 Manchester/NRZ Triggering and Serial Decode**

- Setup for Manchester Signals / 465
- Manchester Triggering / 468
- Manchester Serial Decode / 470
  - Interpreting Manchester Decode / 470
  - Interpreting Manchester Lister Data / 472
- Setup for NRZ Signals / 473
- NRZ Triggering / 475
- NRZ Serial Decode / 477
  - Interpreting NRZ Decode / 478
  - Interpreting NRZ Lister Data / 479

### **31 MIL-STD-1553/ARINC 429 Triggering and Serial Decode**

- Setup for MIL-STD-1553 Signals / 481
- MIL-STD-1553 Triggering / 483
- MIL-STD-1553 Serial Decode / 484
  - Interpreting MIL-STD-1553 Decode / 485
  - Interpreting MIL-STD-1553 Lister Data / 486
  - Searching for MIL-STD-1553 Data in the Lister / 487
- Setup for ARINC 429 Signals / 488
- ARINC 429 Triggering / 489
- ARINC 429 Serial Decode / 491
  - Interpreting ARINC 429 Decode / 493

ARINC 429 Totalizer / 494  
Interpreting ARINC 429 Lister Data / 495  
Searching for ARINC 429 Data in the Lister / 495

## 32 SENT Triggering and Serial Decode

Setup for SENT Signals / 497  
SENT Triggering / 502  
SENT Serial Decode / 504  
    Interpreting SENT Decode / 505  
    Interpreting SENT Lister Data / 507  
    Searching for SENT Data in the Lister / 508

## 33 UART/RS232 Triggering and Serial Decode

Setup for UART/RS232 Signals / 511  
UART/RS232 Triggering / 513  
UART/RS232 Serial Decode / 515  
    Interpreting UART/RS232 Decode / 516  
    UART/RS232 Totalizer / 517  
    Interpreting UART/RS232 Lister Data / 518  
    Searching for UART/RS232 Data in the Lister / 518

## Index

# 1 Getting Started

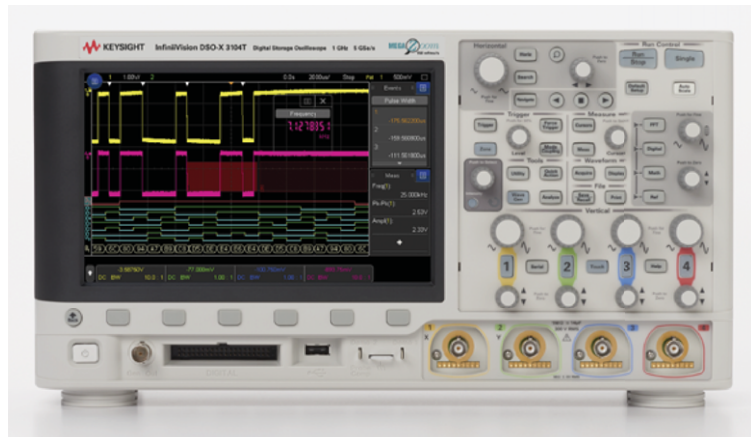
Inspect the Package Contents /	27
Tilt the Oscilloscope for Easy Viewing /	30
Power-On the Oscilloscope /	31
Connect Probes to the Oscilloscope /	32
Input a Waveform /	33
Recall the Default Oscilloscope Setup /	33
Use Autoscale /	34
Compensate Passive Probes /	36
Learn the Front Panel Controls and Connectors /	37
Learn the Touchscreen Controls /	45
Learn the Rear Panel Connectors /	58
Learn the Oscilloscope Display /	59
Access the Built-In Quick Help /	61

This chapter describes the steps you take when using the oscilloscope for the first time.

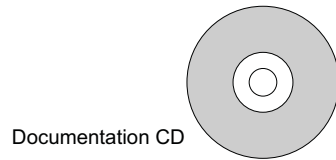
## Inspect the Package Contents

- Inspect the shipping container for damage.  
If your shipping container appears to be damaged, keep the shipping container or cushioning material until you have inspected the contents of the shipment for completeness and have checked the oscilloscope mechanically and electrically.

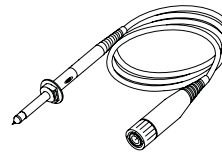
- Verify that you received the following items and any optional accessories you may have ordered:
  - InfiniiVision 3000T X-Series oscilloscope.
  - Power cord (country of origin determines specific type).
  - Oscilloscope probes:
    - Two probes for 2-channel models.
    - Four probes for 4-channel models.
  - Digital probe kit (MSO models only).
  - Documentation CD-ROM.



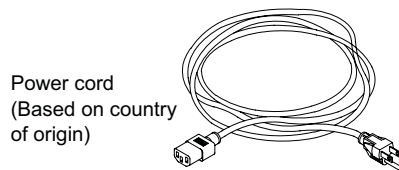
InfiniiVision 3000T X-Series oscilloscope



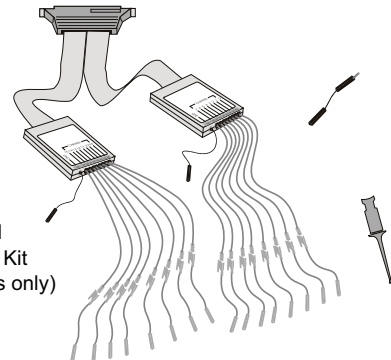
Documentation CD



N2843A probes  
(Qty 2 or 4)



Power cord  
(Based on country  
of origin)



N2756-60001  
Digital Probe Kit  
(MSO models only)

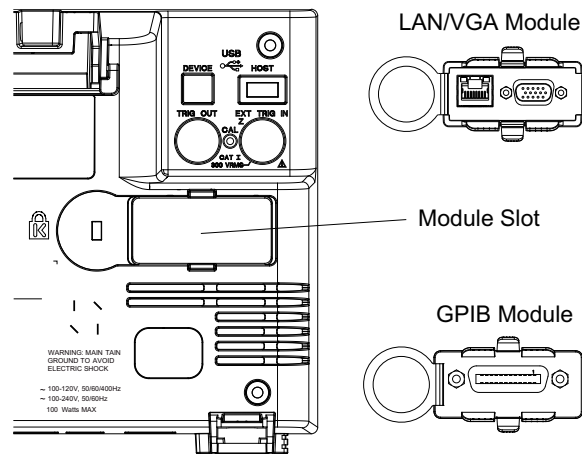
See Also · [“Probes and Accessories”](#) on page 378

## Install the Optional LAN/VGA or GPIB Module

If you need to install a DSOXLAN LAN/VGA module or a DSOXGPIB GPIB module, perform this installation before you power on the oscilloscope.

- 1 If you need to remove a module before installing a different module, pinch the module's spring tabs, and gently remove the module from the slot.
- 2 To install a module, slide the module into the slot on the back until it is fully seated.

The module's spring tabs will latch into the slot, keeping the module in place.

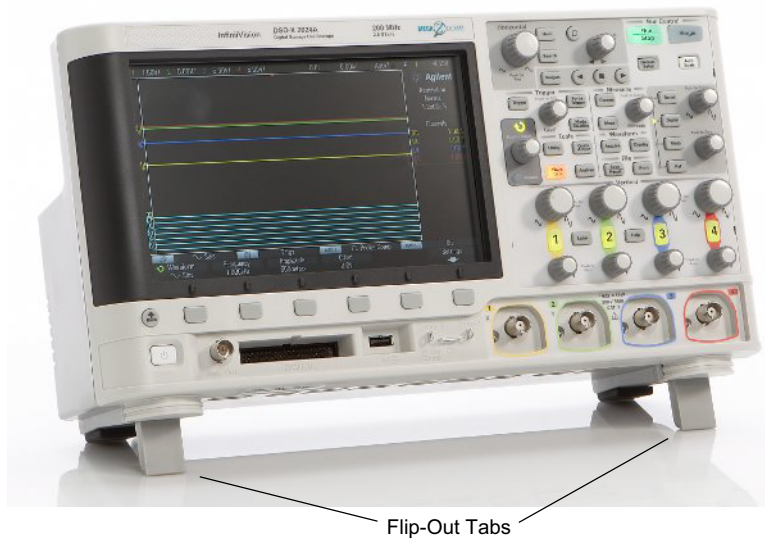


### NOTE

The LAN/VGA or GPIB module must be installed before powering on the oscilloscope.

## Tilt the Oscilloscope for Easy Viewing

There are tabs under the oscilloscope's front feet that can be flipped out to tilt the oscilloscope.



Flip-Out Tabs

## Power-On the Oscilloscope

- Power Requirements** Line voltage, frequency, and power:
- ~Line 100-120 Vac, 50/60/400 Hz
  - 100-240 Vac, 50/60 Hz
  - 100 W max

**Ventilation Requirements** The air intake and exhaust areas must be free from obstructions. Unrestricted air flow is required for proper cooling. Always ensure that the air intake and exhaust areas are free from obstructions.

The fan draws air in from the left side and bottom of the oscilloscope and pushes it out behind the oscilloscope.

When using the oscilloscope in a bench-top setting, provide at least 2" clearance at the sides and 4" (100 mm) clearance above and behind the oscilloscope for proper cooling.

**To power-on the oscilloscope**

- 1 Connect the power cord to the rear of the oscilloscope, then to a suitable AC voltage source. Route the power cord so the oscilloscope's feet and legs do not pinch the cord.
- 2 The oscilloscope automatically adjusts for input line voltages in the range 100 to 240 VAC. The line cord provided is matched to the country of origin.

**WARNING**

**Always use a grounded power cord. Do not defeat the power cord ground.**

---


- 3 Press the power switch.

The power switch is located on the lower left corner of the front panel. The oscilloscope will perform a self-test and will be operational in a few seconds.

## Connect Probes to the Oscilloscope

- 1 Connect the oscilloscope probe to an oscilloscope channel BNC connector.
- 2 Connect the probe's retractable hook tip to the point of interest on the circuit or device under test. Be sure to connect the probe ground lead to a ground point on the circuit.

**CAUTION**

 **Maximum input voltage at analog inputs**

135 Vrms

50Ω input: 5 Vrms Input protection is enabled in 50 Ω mode and the 50 Ω load will disconnect if greater than 5 Vrms is detected. However the inputs could still be damaged, depending on the time constant of the signal. The 50 Ω input protection only functions when the oscilloscope is powered on.

---


**CAUTION**

When measuring voltages over 30 V, use a 10:1 probe.

---



**CAUTION**

 Do not float the oscilloscope chassis

Defeating the ground connection and "floating" the oscilloscope chassis will probably result in inaccurate measurements and may also cause equipment damage. The probe ground lead is connected to the oscilloscope chassis and the ground wire in the power cord. If you need to measure between two live points, use a differential probe with sufficient dynamic range.

---

**WARNING**

**Do not negate the protective action of the ground connection to the oscilloscope. The oscilloscope must remain grounded through its power cord. Defeating the ground creates an electric shock hazard.**

---

## Input a Waveform

The first signal to input to the oscilloscope is the Demo 2, Probe Comp signal. This signal is used for compensating probes.

- 1 Connect an oscilloscope probe from channel 1 to the **Demo 2** (Probe Comp) terminal on the front panel.
- 2 Connect the probe's ground lead to the ground terminal (next to the **Demo 2** terminal).

## Recall the Default Oscilloscope Setup

To recall the default oscilloscope setup:

- 1 Press **[Default Setup]**.

The default setup restores the oscilloscope's default settings. This places the oscilloscope in a known operating condition. The major default settings are:

**Table 2** Default Configuration Settings

Horizontal	Normal mode, 100 $\mu$ s/div scale, 0 s delay, center time reference.
Vertical (Analog)	Channel 1 on, 5 V/div scale, DC coupling, 0 V position, 1 M $\Omega$ impedance.
Trigger	Edge trigger, Auto trigger mode, 0 V level, channel 1 source, DC coupling, rising edge slope, 40 ns holdoff time.
Display	Persistence off, 20% grid intensity, 50% waveform intensity.
Other	Acquire mode normal, <b>[Run/Stop]</b> to Run, cursors and measurements off.
Labels	All custom labels that you have created in the Label Library are preserved (not erased), but all channel labels will be set to their original names.

In the Save/Recall Menu, there are also options for restoring the complete factory settings (see **“Recalling Default Setups”** on page 333) or performing a secure erase (see **“Performing a Secure Erase”** on page 334).

## Use Autoscale

Use **[Auto Scale]** to automatically configure the oscilloscope to best display the input signals.

- 1 Press **[Auto Scale]**.

You should see a waveform on the oscilloscope's display similar to this:



- 2 If you want to return to the oscilloscope settings that existed before, press **Undo Autoscale**.
- 3 If you want to enable "fast debug" autoscaling, change the channels autoscaled, or preserve the acquisition mode during autoscale, press **Fast Debug**, **Channels**, or **Acq Mode**.

These are the same softkeys that appear in the Autoscale Preferences Menu. See ["To set Autoscale preferences"](#) on page 349.

If you see the waveform, but the square wave is not shaped correctly as shown above, perform the procedure ["Compensate Passive Probes"](#) on page 36.

If you do not see the waveform, make sure the probe is connected securely to the front panel channel input BNC and to the left side, Demo 2, Probe Comp terminal.

#### How Autoscale Works

Autoscale analyzes any waveforms present at each channel and at the external trigger input. This includes the digital channels, if connected.

Autoscale finds, turns on, and scales any channel with a repetitive waveform that has a frequency of at least 25 Hz, a duty cycle greater than 0.5%, and an amplitude of at least 10 mV peak-to-peak. Any channels where no signal is found are turned off.

The trigger source is selected by looking for the first valid waveform starting with external trigger, then continuing with the lowest number analog channel up to the highest number analog channel, and finally (if digital probes are connected) the highest number digital channel.

During Autoscale, the delay is set to 0.0 seconds, the horizontal time/div (sweep speed) setting is a function of the input signal (about 2 periods of the triggered signal on the screen), and the triggering mode is set to Edge.

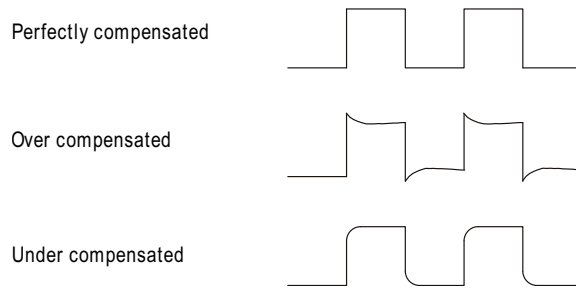
## Compensate Passive Probes

Each oscilloscope passive probe must be compensated to match the input characteristics of the oscilloscope channel to which it is connected. A poorly compensated probe can introduce significant measurement errors.

- 1 Input the Probe Comp signal (see **"Input a Waveform"** on page 33).
- 2 Press **[Default Setup]** to recall the default oscilloscope setup (see **"Recall the Default Oscilloscope Setup"** on page 33).
- 3 Press **[Auto Scale]** to automatically configure the oscilloscope for the Probe Comp signal (see **"Use Autoscale"** on page 34).
- 4 Press the channel key to which the probe is connected (**[1]**, **[2]**, etc.).
- 5 In the Channel Menu, press **Probe**.
- 6 In the Channel Probe Menu, press **Probe Check**; then, follow the instructions on-screen.

If necessary, use a nonmetallic tool (supplied with the probe) to adjust the trimmer capacitor on the probe for the flattest pulse possible.

On N2894A probes, the trimmer capacitor is located on the probe BNC connector.



- 7** Connect probes to all other oscilloscope channels (channel 2 of a 2-channel oscilloscope, or channels 2, 3, and 4 of a 4-channel oscilloscope).
- 8** Repeat the procedure for each channel.

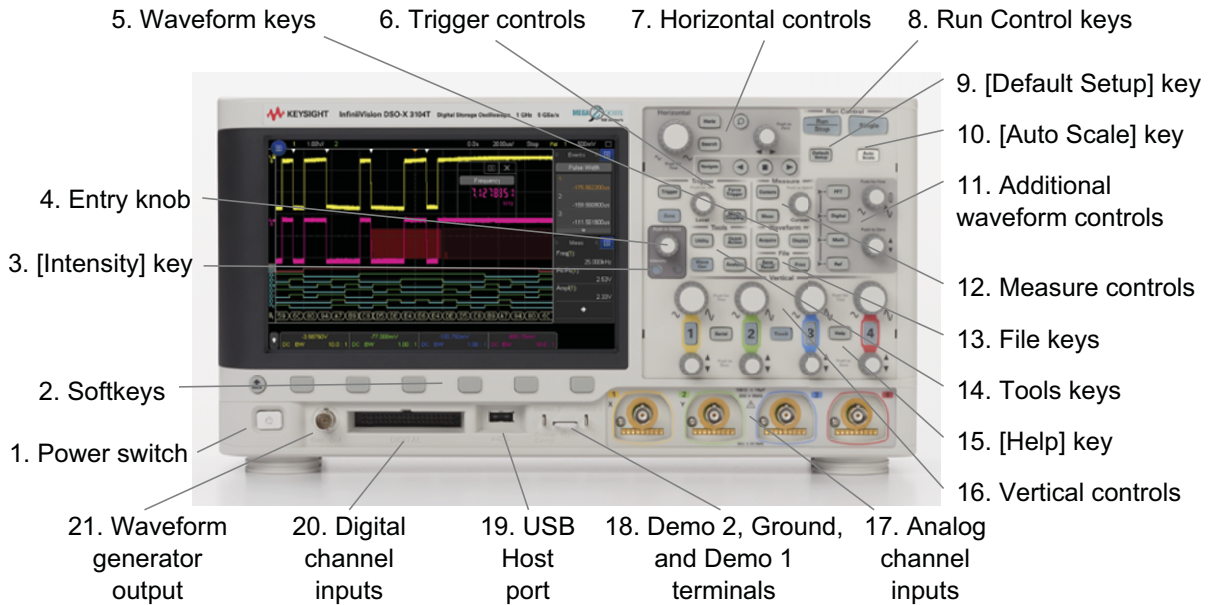
## Learn the Front Panel Controls and Connectors



On the front panel, *key* refers to any key (button) you can press.



*Softkey* specifically refers to the six keys that are directly below the display. The legend for these keys is directly above them, on the display. Their functions change as you navigate through the oscilloscope's menus.




For the following figure, refer to the numbered descriptions in the table that follows.

# 1 Getting Started




1.	Power switch	Press once to switch power on; press again to switch power off. See <b>“Power-On the Oscilloscope”</b> on page 31.
2.	Softkeys	The functions of these keys change based upon the menus shown on the display directly above the keys.  The  Back/Up key moves up in the softkey menu hierarchy. At the top of the hierarchy, the  Back/Up key turns the menus off, and oscilloscope information is shown instead.
3.	[Intensity] key	Press the key to illuminate it. When illuminated, turn the Entry knob to adjust waveform intensity.  You can vary the intensity control to bring out signal detail, much like an analog oscilloscope. Digital channel waveform intensity is not adjustable.  More details about using the Intensity control to view signal detail are on <b>“To adjust waveform intensity”</b> on page 155.


4.	Entry knob	<p>The Entry knob is used to select items from menus and to change values. The function of the Entry knob changes based upon the current menu and softkey selections.</p> <p>Note that the curved arrow symbol  above the entry knob illuminates whenever the entry knob can be used to select a value. Also, note that when the Entry knob  symbol appears on a softkey, you can use the Entry knob, to select values.</p> <p>Often, rotating the Entry knob is enough to make a selection. Sometimes, you can push the Entry knob to enable or disable a selection. Pushing the Entry knob also makes popup menus disappear.</p>
5.	Waveform keys	<p>The <b>[Acquire]</b> key lets you select Normal, Peak Detect, Averaging, or High Resolution acquisition modes (see <b>“Selecting the Acquisition Mode”</b> on page 221) and use segmented memory (see <b>“Acquiring to Segmented Memory”</b> on page 229).</p> <p>The <b>[Display]</b> key lets you access the menu where you can enable persistence (see <b>“To set or clear persistence”</b> on page 157), clear the display, and adjust the display grid (graticule) intensity (see <b>“To adjust the grid intensity”</b> on page 159).</p> <p><b>[Touch]</b> key (to right of channel 2 key) – Press this key to disable/enable the touchscreen.</p>
6.	Trigger controls	<p>These controls determine how the oscilloscope triggers to capture data. See <b>Chapter 11</b>, “Triggers,” starting on page 169 and <b>Chapter 12</b>, “Trigger Mode/Coupling,” starting on page 207.</p>

7.	Horizontal controls	<p>The Horizontal controls consist of:</p> <ul style="list-style-type: none"> <li>▪ Horizontal scale knob – Turn the knob in the Horizontal section that is marked  to adjust the time/div (sweep speed) setting. The symbols under the knob indicate that this control has the effect of spreading out or zooming in on the waveform using the horizontal scale.</li> <li>▪ Horizontal position knob – Turn the knob marked ◀▶ to pan through the waveform data horizontally. You can see the captured waveform before the trigger (turn the knob clockwise) or after the trigger (turn the knob counterclockwise). If you pan through the waveform when the oscilloscope is stopped (not in Run mode) then you are looking at the waveform data from the last acquisition taken.</li> <li>▪ <b>[Horiz]</b> key – Press this key to open the Horizontal Menu where you can select XY and Roll modes, enable or disable Zoom, enable or disable horizontal time/division fine adjustment, and select the trigger time reference point.</li> <li>▪ Zoom  key – Press the  zoom key to split the oscilloscope display into Normal and Zoom sections without opening the Horizontal Menu.</li> <li>▪ <b>[Search]</b> key – Lets you search for events in the acquired data.</li> <li>▪ <b>[Navigate]</b> keys – Press these keys to navigate through captured data via time, search events, or segmented memory acquisition. See <b>“Navigating the Time Base”</b> on page 75.</li> </ul> <p>For more information see <b>Chapter 2</b>, “Horizontal Controls,” starting on page 63.</p>
8.	Run Control keys	<p>When the <b>[Run/Stop]</b> key is green, the oscilloscope is running, that is, acquiring data when trigger conditions are met. To stop acquiring data, press <b>[Run/Stop]</b>.</p> <p>When the <b>[Run/Stop]</b> key is red, data acquisition is stopped. To start acquiring data, press <b>[Run/Stop]</b>.</p> <p>To capture and display a single acquisition (whether the oscilloscope is running or stopped), press <b>[Single]</b>. The <b>[Single]</b> key is yellow until the oscilloscope triggers.</p> <p>For more information, see <b>“Running, Stopping, and Making Single Acquisitions (Run Control)”</b> on page 215.</p>
9.	<b>[Default Setup]</b> key	<p>Press this key to restore the oscilloscope's default settings (details on <b>“Recall the Default Oscilloscope Setup”</b> on page 33).</p>
10.	<b>[Auto Scale]</b> key	<p>When you press the <b>[Auto Scale]</b> key, the oscilloscope will quickly determine which channels have activity, and it will turn these channels on and scale them to display the input signals. See <b>“Use Autoscale”</b> on page 34.</p>



11.	Additional waveform controls	<p>The additional waveform controls consist of:</p> <ul style="list-style-type: none"> <li>▪ <b>[FFT]</b> key – provides access to FFT spectrum analysis function. See <b>Chapter 4</b>, “FFT Spectral Analysis,” starting on page 89.</li> <li>▪ <b>[Math]</b> key – provides access to math (add, subtract, etc.) waveform functions. See <b>Chapter 5</b>, “Math Waveforms,” starting on page 99.</li> <li>▪ <b>[Ref]</b> key – provides access to reference waveform functions. Reference waveforms are saved waveforms that can be displayed and compared against other analog channel or math waveforms. Also, measurements can be made on reference waveforms. See <b>Chapter 6</b>, “Reference Waveforms,” starting on page 127.</li> <li>▪ <b>[Digital]</b> key – Press this key to turn the digital channels on or off (the arrow to the left will illuminate).</li> </ul> <p>When the arrow to the left of the <b>[Digital]</b> key is illuminated, the upper multiplexed knob selects (and highlights in red) individual digital channels, and the lower multiplexed knob positions the selected digital channel.</p> <p>If a trace is repositioned over an existing trace the indicator at the left edge of the trace will change from <b>Dnn</b> designation (where nn is a one or two digit channel number from 0 to 15) to <b>D*</b>. The “*” indicates that two or more channels are overlaid.</p> <p>You can rotate the upper knob to select an overlaid channel, then rotate the lower knob to position it just as you would any other channel.</p> <p>For more information on digital channels see <b>Chapter 7</b>, “Digital Channels,” starting on page 131.</p> <ul style="list-style-type: none"> <li>▪ Multiplexed scale knob – This scale knob is used with Math, Ref, or Digital waveforms, whichever has the illuminated arrow to the left. For math and reference waveforms, the scale knob acts like an analog channel vertical scale knob.</li> <li>▪ Multiplexed position knob – This position knob is used with Math, Ref, or Digital waveforms, whichever has the illuminated arrow to the left. For math and reference waveforms, the position knob acts like an analog channel vertical position knob.</li> <li>▪ <b>[Serial]</b> key (between channel 1 and 2 keys) – This key is used to enable serial decode. The multiplexed scale and position knobs are not used with serial decode. For more information on serial decode, see <b>Chapter 8</b>, “Serial Decode,” starting on page 149.</li> </ul>
12.	Measure controls	<p>The measure controls consist of:</p> <ul style="list-style-type: none"> <li>▪ Cursors knob – Push this knob to select cursors from a popup menu. Then, after the popup menu closes (either by timeout or by pushing the knob again), rotate the knob to adjust the selected cursor position.</li> <li>▪ <b>[Cursors]</b> key – Press this key to open a menu that lets you select the cursors mode and source.</li> <li>▪ <b>[Meas]</b> key – Press this key to access a set of predefined measurements. See <b>Chapter 15</b>, “Measurements,” starting on page 243.</li> </ul>

13.	File keys	<p>Press the <b>[Save/Recall]</b> key to save or recall a waveform or setup. See <a href="#">Chapter 20</a>, “Save/Email/Recall (Setups, Screens, Data),” starting on page 321.</p> <p>The <b>[Print]</b> key opens the Print Configuration Menu so you can print the displayed waveforms. See <a href="#">Chapter 21</a>, “Print (Screens),” starting on page 335.</p>
14.	Tools keys	<p>The Tools keys consist of:</p> <ul style="list-style-type: none"> <li>▪ <b>[Utility]</b> key – Press this key to access the Utility Menu, which lets you configure the oscilloscope's I/O settings, use the file explorer, set preferences, access the service menu, and choose other options. See <a href="#">Chapter 22</a>, “Utility Settings,” starting on page 341.</li> <li>▪ <b>[Quick Action]</b> key – Press this key to perform the selected quick action: measure all snapshot, print, save, recall, freeze display, and more. See “<a href="#">Configuring the [Quick Action] Key</a>” on page 357.</li> <li>▪ <b>[Wave Gen]</b> key – Press this key to access waveform generator functions. See <a href="#">Chapter 19</a>, “Waveform Generator,” starting on page 301.</li> <li>▪ <b>[Analyze]</b> key – Press this key to access analysis features like: <ul style="list-style-type: none"> <li>▪ Measurement threshold setting.</li> <li>▪ Trigger level setting.</li> <li>▪ Video trigger automatic set up and display.</li> <li>▪ Counter (DVMCTR) (see “<a href="#">Counter</a>” on page 291).</li> <li>▪ Digital voltmeter (DVMCTR) (see “<a href="#">Digital Voltmeter</a>” on page 290).</li> <li>▪ Mask testing (see <a href="#">Chapter 16</a>, “Mask Testing,” starting on page 275).</li> <li>▪ The DSOX3PWR power measurement and analysis application.</li> </ul> </li> </ul>
15.	<b>[Help]</b> key	<p>Opens the Help Menu where you can display overview help topics and select the Language. See also “<a href="#">Access the Built-In Quick Help</a>” on page 61.</p>
16.	Vertical controls	<p>The Vertical controls consist of:</p> <ul style="list-style-type: none"> <li>▪ Analog channel on/off keys – Use these keys to switch a channel on or off, or to access a channel's menu in the softkeys. There is one channel on/off key for each analog channel.</li> <li>▪ Vertical scale knob – There are knobs marked  for each channel. Use these knobs to change the vertical sensitivity (gain) of each analog channel.</li> <li>▪ Vertical position knobs – Use these knobs to change a channel's vertical position on the display. There is one Vertical Position control for each analog channel.</li> </ul> <p>For more information, see <a href="#">Chapter 3</a>, “Vertical Controls,” starting on page 79.</p>

17.	Analog channel inputs	<p>Attach oscilloscope probes or BNC cables to these BNC connectors.</p> <p>With the InfiniiVision 3000T X-Series oscilloscopes, you can set the input impedance of the analog channels to either 50 <math>\Omega</math> or 1 M<math>\Omega</math>. See <b>"To specify channel input impedance"</b> on page 82.</p> <p>The InfiniiVision 3000T X-Series oscilloscopes also provide the AutoProbe interface. The AutoProbe interface uses a series of contacts directly below the channel's BNC connector to transfer information between the oscilloscope and the probe. When you connect a compatible probe to the oscilloscope, the AutoProbe interface determines the type of probe and sets the oscilloscope's parameters (units, offset, attenuation, coupling, and impedance) accordingly.</p>
18.	Demo 2, Ground, and Demo 1 terminals	<ul style="list-style-type: none"> <li>▪ Demo 2 terminal – After a <b>[Default Setup]</b>, this terminal outputs the Probe Comp signal which helps you match a probe's input capacitance to the oscilloscope channel to which it is connected. See <b>"Compensate Passive Probes"</b> on page 36. With certain licensed features, the oscilloscope can also output demo or training signals on this terminal.</li> <li>▪ Ground terminal – Use the ground terminal for oscilloscope probes connected to the Demo 1 or Demo 2 terminals.</li> <li>▪ Demo 1 terminal – The oscilloscope can output training signals on this and the Demo 2 terminal. See: <b>[Help] &gt; Training Signals &gt; Training Signals</b>.</li> </ul>
19.	USB Host port	<p>This port is for connecting a USB mass storage device, printer, mouse, or keyboard to the oscilloscope.</p> <p>Connect a USB compliant mass storage device (flash drive, disk drive, etc.) to save or recall oscilloscope setup files and reference waveforms or to save data and screen images. See <b>Chapter 20</b>, "Save/Email/Recall (Setups, Screens, Data)," starting on page 321.</p> <p>To print, connect a USB compliant printer. For more information about printing see <b>Chapter 21</b>, "Print (Screens)," starting on page 335.</p> <p>You can also use the USB port to update the oscilloscope's system software when updates are available.</p> <p>You do not need to take special precautions before removing the USB mass storage device from the oscilloscope (you do not need to "eject" it). Simply unplug the USB mass storage device from the oscilloscope when the file operation is complete.</p> <p><b>CAUTION:</b>  <b>Do not connect a host computer to the oscilloscope's USB host port.</b> Use the device port. A host computer sees the oscilloscope as a device, so connect the host computer to the oscilloscope's device port (on the rear panel). See <b>"I/O Interface Settings"</b> on page 341.</p> <p>There is a second USB host port on the back panel.</p>
20.	Digital channel inputs	<p>Connect the digital probe cable to this connector (MSO models only). See <b>Chapter 7</b>, "Digital Channels," starting on page 131.</p>

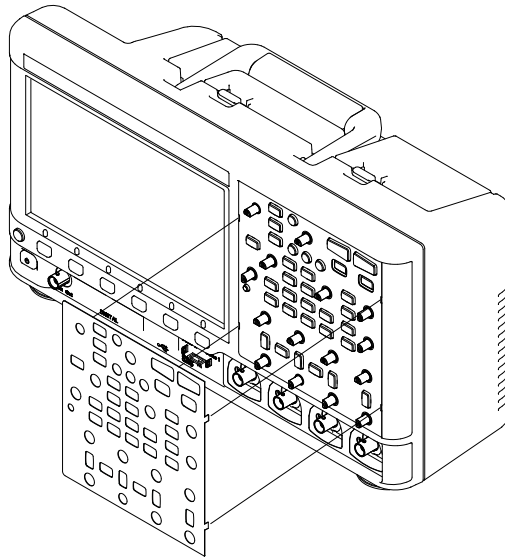
21.	Waveform generator outputs	Built-in, license-enabled waveform generator can output arbitrary, sine, square, ramp, pulse, DC, noise, sine cardinal, exponential rise, exponential fall, cardiac, or Gaussian pulse waveforms on the Gen Out BNC connectors. Modulated waveforms are available on Wave Gen except for arbitrary, pulse, DC, and noise waveforms. Press the <b>[Wave Gen]</b> key to set up the waveform generator. See <b>Chapter 19</b> , “Waveform Generator,” starting on page 301.
-----	----------------------------	---

## Front Panel Overlays for Different Languages

Front panel overlays, which have translations for the English front panel keys and label text, are available in several languages. The appropriate overlay is included when the localization option is chosen at time of purchase.

To install a front panel overlay:

- 1 Gently pull on the front panel knobs to remove them.
- 2 Insert the overlay's side tabs into the slots on the front panel.



- 3 Reinstall the front panel knobs.

Front panel overlays may be ordered from [www.keysight.com/find/parts](http://www.keysight.com/find/parts) using the following part numbers:

Language	2 Channel Overlay	4 Channel Overlay
Czech	75037-94327	75037-94328
French	75037-94321	75037-94322
German	75037-94317	75037-94318
Italian	75037-94325	75037-94326
Japanese	75037-94323	75037-94324
Korean	75037-94307	75037-94308
Polish	75037-94329	75037-94330
Portuguese	75037-94315	75037-94316
Russian	75037-94331	75037-94332
Simplified Chinese	75037-94309	75037-94310
Spanish	75037-94319	75037-94320
Thai	75037-94312	75037-94311
Traditional Chinese	75037-94305	75037-94306
Turkish	75037-94313	75037-94314

## Learn the Touchscreen Controls

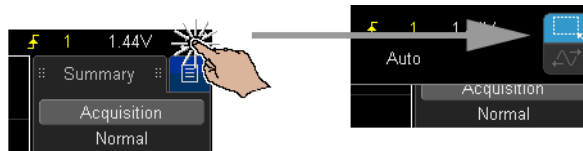
When the **[Touch]** key is lit, you can control the oscilloscope by touching different areas of the screen. You can:

- **"Draw Rectangles for Waveform Zoom or Zone Trigger Set Up"** on page 46
- **"Flick or Drag to Scale, Position, and Change Offset"** on page 47
- **"Select Sidebar Information or Controls"** on page 49
- **"Undock Sidebar Dialogs by Dragging"** on page 49
- **"Re-dock Sidebar Dialogs to Split Sidebar"** on page 50
- **"Select Dialog Menus and Close Dialogs"** on page 51
- **"Drag Cursors"** on page 51
- **"Touch Softkeys and Menus On the Screen"** on page 51

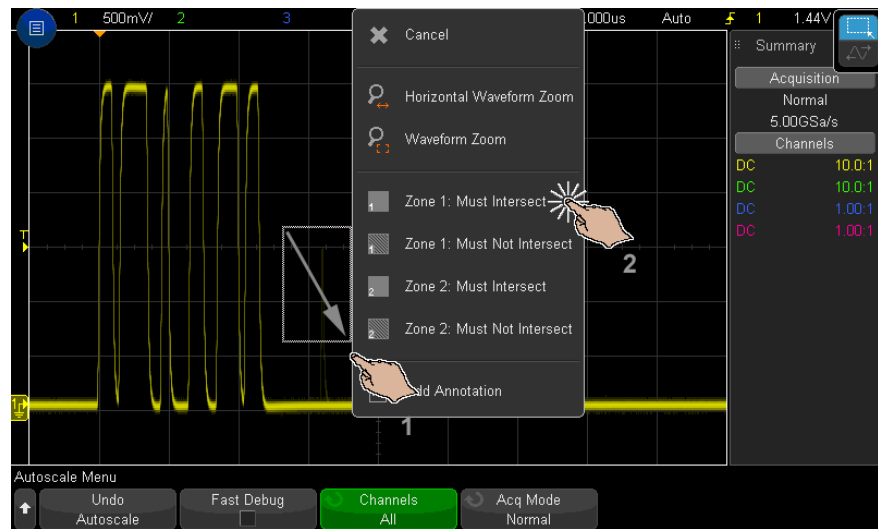
- “Enter Names Using Alpha-Numeric Keypad Dialogs” on page 52
- “Change Waveform Offsets By Dragging Ground Reference Icons” on page 53
- “Access Controls and Menu Via the Menu Icon” on page 54
- “Turn Channels On/Off and Open Scale/Offset Dialogs” on page 55
- “Access the Horizontal Menu and Open the Scale/Delay Dialog” on page 56
- “Access the Trigger Menu, Change the Trigger Mode, and Open the Trigger Level Dialog” on page 57
- “Use a USB Mouse and/or Keyboard for Touchscreen Controls” on page 58

## Draw Rectangles for Waveform Zoom or Zone Trigger Set Up

- 1 Touch the upper-right corner to select the rectangle draw mode.

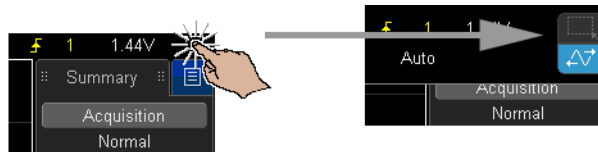


- 2 Drag your finger across the screen to draw a rectangle.
- 3 Take your finger off the screen.
- 4 Touch the desired option from the popup menu.



## Flick or Drag to Scale, Position, and Change Offset

- 1 Touch the upper-right corner to select the horizontal drag mode.



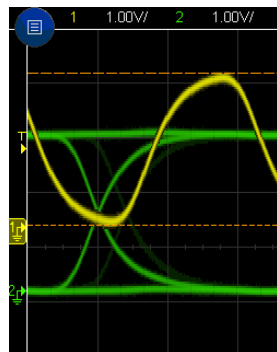
- 2 When the waveform drag mode is selected, you can use these touch gestures:

# 1 Getting Started



- Flick – allows very fast browsing of waveforms. It is similar to browsing on tablets and smartphones. It is much easier to flick than to continually turn a knob.
- Drag – drag your finger across the screen to change the horizontal delay. Drag your finger up or down to change the vertical offset.

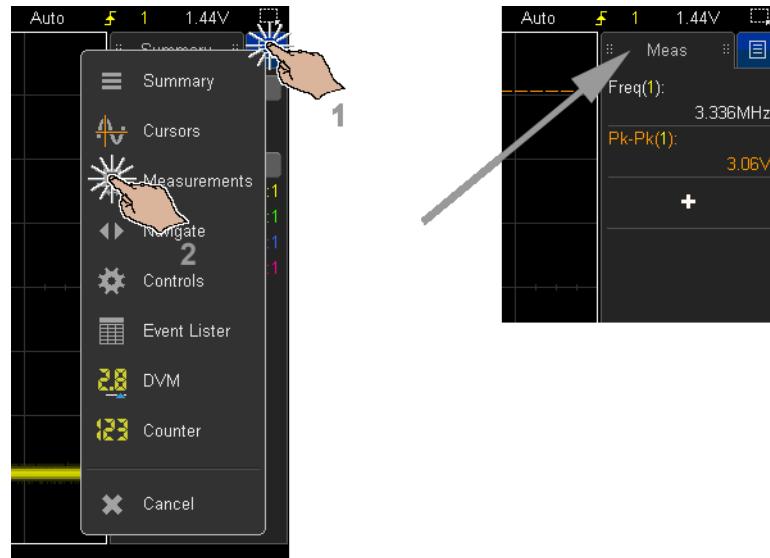
To select waveforms, tap them. The waveform closest horizontally to the tap location is selected. The selected waveform is indicated by the ground marker with the filled background (channel 1 in the following example).





## Select Sidebar Information or Controls

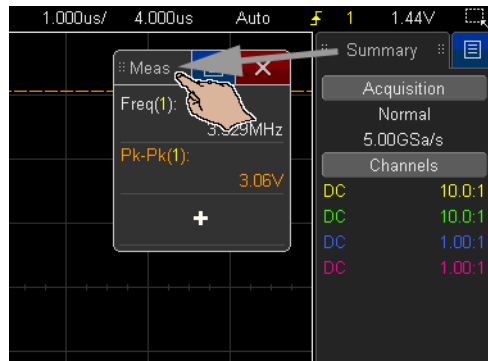
- 1 Touch the blue menu icon in the sidebar.
- 2 In the popup menu, touch the type of information or controls you want to see in the sidebar.



## Undock Sidebar Dialogs by Dragging

Sidebar dialogs can be undocked and placed anywhere on the screen.

- 1 Drag the sidebar dialog title wherever you like.

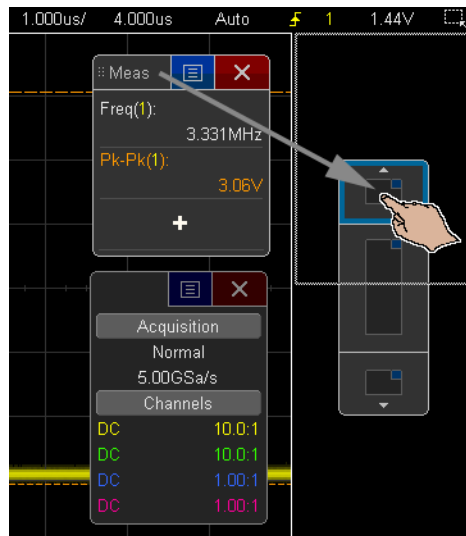


This lets you view multiple types of information or controls at the same time.

## Re-dock Sidebar Dialogs to Split Sidebar

Sidebar dialogs can be re-docked to either half or full height of the sidebar.

- 1 Drag the dialog title back to the desired sidebar target.



You can display two dialogs in the sidebar at the same time.

## Select Dialog Menus and Close Dialogs

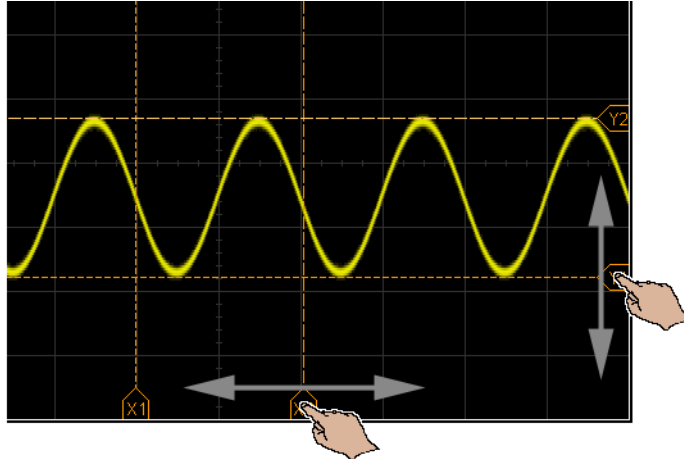
- Touch the blue menu icon in the dialog for options.



- Touch the red "X" icon to close a dialog.

## Drag Cursors

When cursors are displayed, you can drag the name handles to position them.

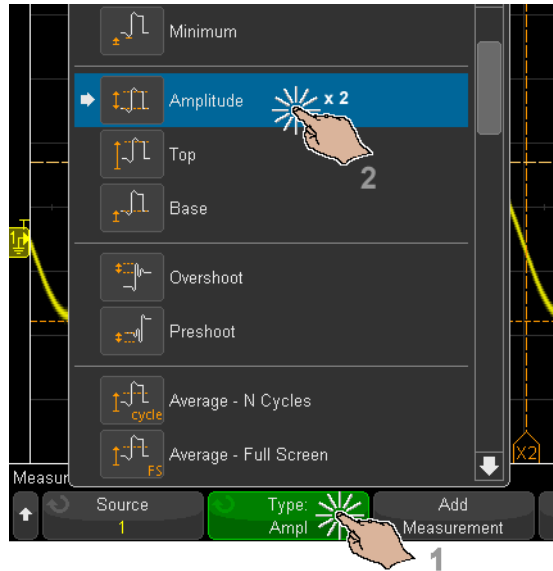



## Touch Softkeys and Menus On the Screen

- Touch onscreen softkey labels to select them.

This is the same as pressing the softkey keys.

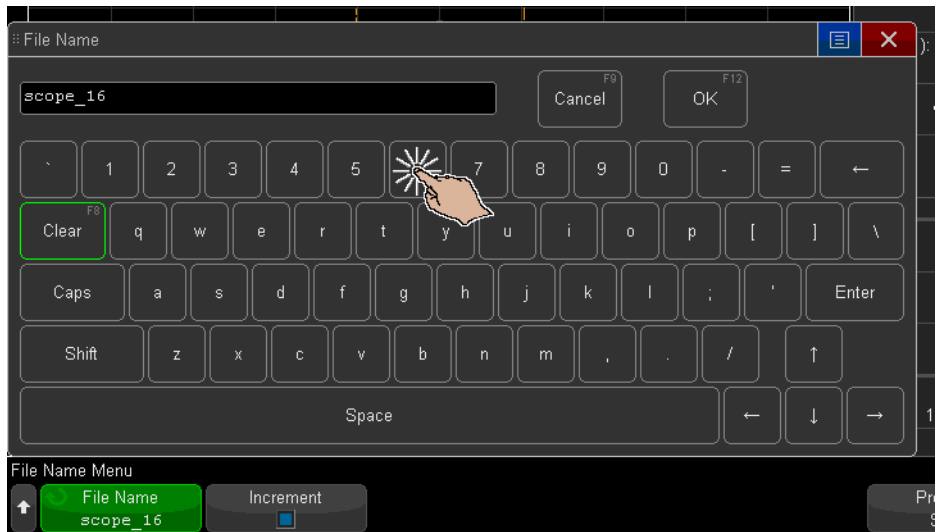
- When softkeys provide menus, double-touch to select a menu item.



This may be an easier than selecting a menu item via the  Entry knob.

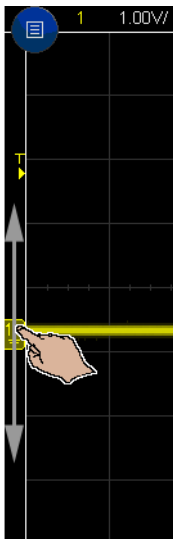
## Enter Names Using Alpha-Numeric Keypad Dialogs

Some softkeys open alpha-numeric dialogs that let you touch to enter names.



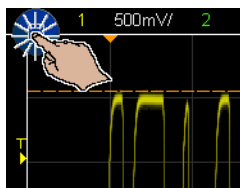
## Change Waveform Offsets By Dragging Ground Reference Icons

You can drag ground icons to change a waveform's vertical offset.

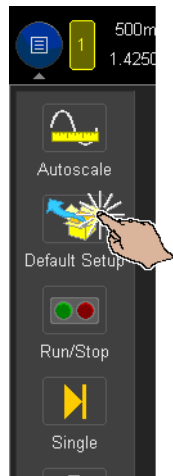


## Access Controls and Menus Via the Menu Icon

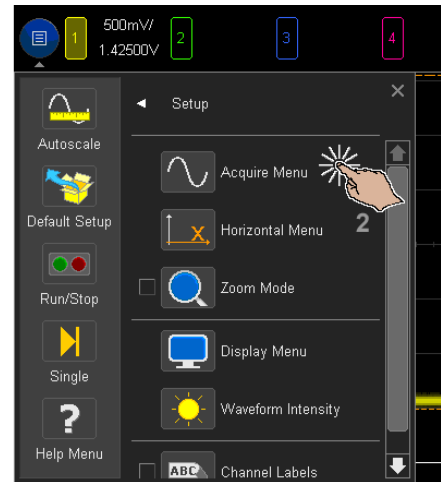
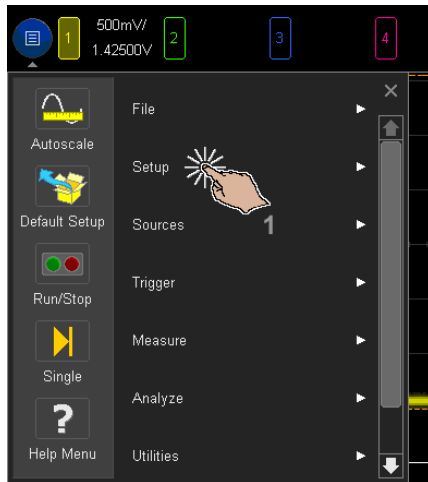
- 1 Touch the upper-left menu icon to open the main menu.



- 2 Touch left side controls to perform oscilloscope operations.

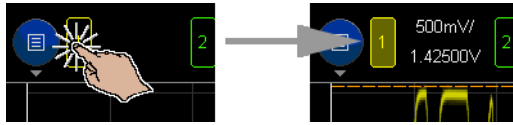


- 3 Touch menu items and submenu items to access menus and additional controls.

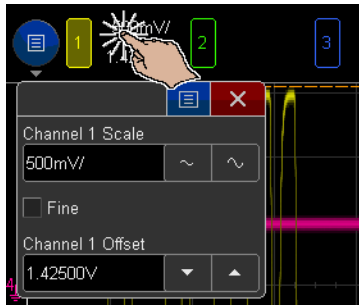


## Turn Channels On/Off and Open Scale/Offset Dialogs

- Touch channel numbers to turn them on or off.

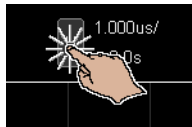


- When channels are on, touch the scale and offset values to access a dialog for changing them.



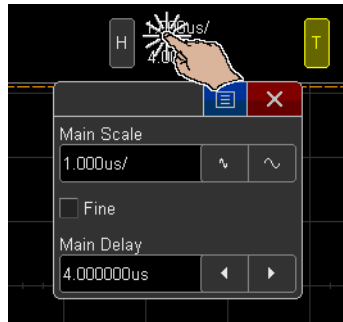
## Access the Horizontal Menu and Open the Scale/Delay Dialog

- Touch "H" to access the Horizontal Menu.



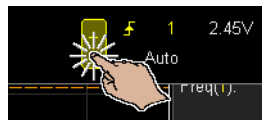
- Touch the horizontal scale and delay values to access a dialog for changing them.



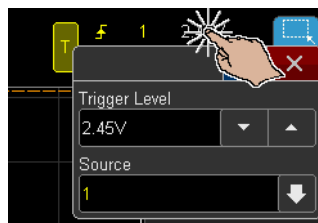


## Access the Trigger Menu, Change the Trigger Mode, and Open the Trigger Level Dialog

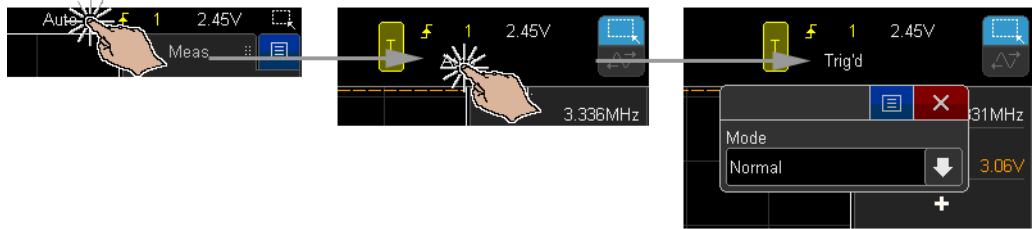
- Touch "T" to access the Trigger Menu.



- Touch the trigger level value(s) to access a dialog for changing the level(s).



- Touch "Auto" or "Trig'd" to quickly toggle the trigger mode.



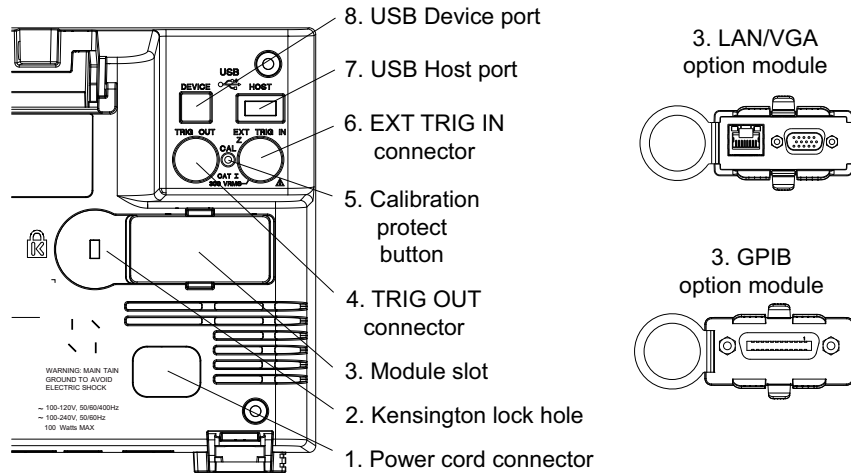
### Use a USB Mouse and/or Keyboard for Touchscreen Controls

Connecting a USB mouse gives you a mouse pointer on the display. Mouse clicks and drags behave the same as screen touches and finger drags.

If you connect a USB keyboard, you can use it to enter values in alpha-numeric keypad dialogs.

### Learn the Rear Panel Connectors

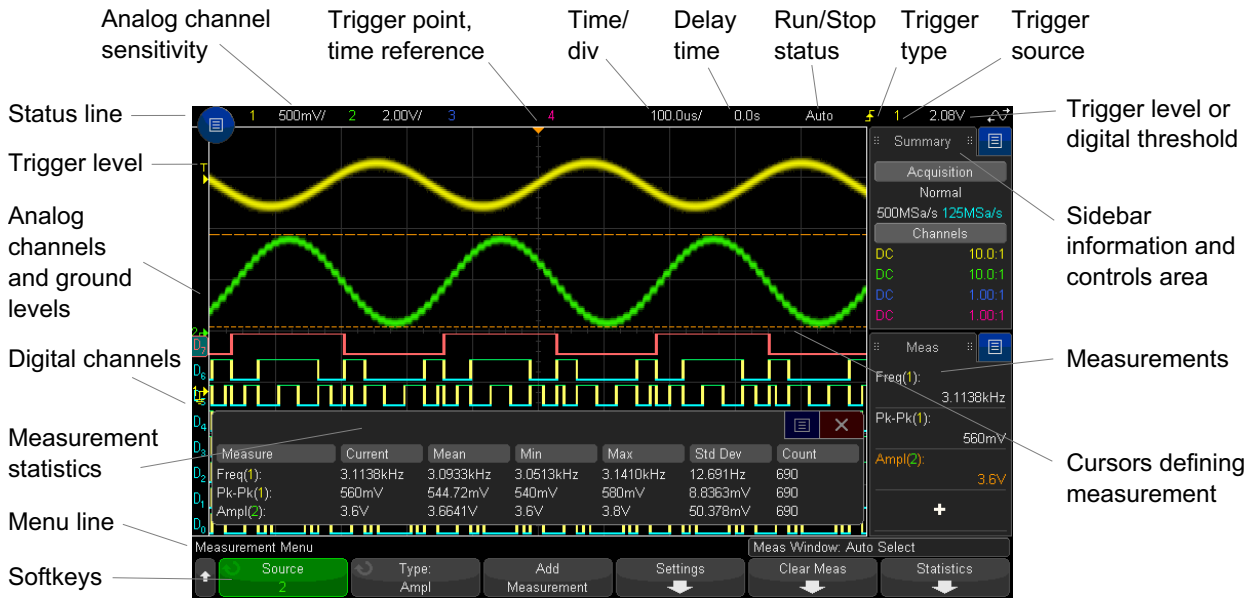
For the following figure, refer to the numbered descriptions in the table that follows.



1.	Power cord connector	Attach the power cord here.
2.	Kensington lock hole	This is where you can attach a Kensington lock for securing the instrument.
3.	Module slot	<p>A DSOXLAN LAN/VGA module may be ordered and installed separately.</p> <ul style="list-style-type: none"> <li>▪ LAN port – lets you communicate with the oscilloscope and use the Remote Front Panel feature using the LAN port. See <a href="#">Chapter 23</a>, “Web Interface,” starting on page 359 and <a href="#">“Accessing the Web Interface”</a> on page 360.</li> <li>▪ VGA video output – lets you connect an external monitor or projector to provide a larger display or to provide a display at a viewing position away from the oscilloscope.</li> </ul> <p>The oscilloscope's built-in display remains on even when an external display is connected. The video output connector is always active.</p> <p>For optimal video quality and performance, we recommend you use a shielded video cable with ferrite cores.</p> <p>A DSOXGPIB GPIB module may be ordered and installed separately.</p>
4.	TRIG OUT connector	Trigger output BNC connector. See <a href="#">“Setting the Rear Panel TRIG OUT Source”</a> on page 350.
5.	Calibration protect button	See <a href="#">“To perform user calibration”</a> on page 352.
6.	EXT TRIG IN connector	External trigger input BNC connector. See <a href="#">“External Trigger Input”</a> on page 213 for an explanation of this feature.
7.	USB Host port	This port functions identically to the USB host port on the front panel. USB Host Port is used for saving data from the oscilloscope and loading software updates. See also USB Host port (see <a href="#">page 43</a> ).
8.	USB Device port	This port is for connecting the oscilloscope to a host PC. You can issue remote commands from a host PC to the oscilloscope via the USB device port. See <a href="#">“Remote Programming with Keysight IO Libraries”</a> on page 366.


## Learn the Oscilloscope Display

The oscilloscope display contains acquired waveforms, setup information, measurement results, and the softkey definitions.



**Figure 1** Interpreting the oscilloscope display

Status line	The top line of the display contains vertical, horizontal, and trigger setup information.
Display area	The display area contains the waveform acquisitions, channel identifiers, and analog trigger, and ground level indicators. Each analog channel's information appears in a different color.  Signal detail is displayed using 256 levels of intensity. For more information about viewing signal detail see <b>"To adjust waveform intensity"</b> on page 155.  For more information about display modes see <b>Chapter 9</b> , "Display Settings," starting on page 155.

Sidebar information and controls area	<p>The sidebar information area can contain summary, cursors, measurements, or digital voltmeter information dialogs or it can contain navigation and other control dialogs.</p> <p>For more information, see:</p> <ul style="list-style-type: none"> <li>▪ "Select Sidebar Information or Controls" on page 49</li> <li>▪ "Undock Sidebar Dialogs by Dragging" on page 49</li> </ul>
Menu line	<p>This line normally contains menu name or other information associated with the selected menu.</p>
Softkey labels	<p>These labels describe softkey functions. Typically, softkeys let you set up additional parameters for the selected mode or menu.</p> <p>Pressing the  Back/Up key at the top of the menu hierarchy turns off softkey labels and displays additional status information describing channel offset and other configuration parameters.</p>

## Access the Built-In Quick Help

To view Quick Help **1** Press and hold the key or softkey for which you would like to view help.

# 1 Getting Started



Press and hold front panel key or softkey  
(or right-click softkey when using web browser remote front panel).

Quick Help remains on the screen until another key is pressed or a knob is turned.

To select the user interface language

To select the user interface language:


- 1 Press **[Help]**, then press the **Language** softkey.
- 2 Repeatedly press and release the **Language** softkey or rotate the Entry knob until the desired language is selected.

The following languages are available: Czech, English, French, German, Italian, Japanese, Korean, Polish, Portuguese, Russian, Simplified Chinese, Spanish, Thai, Traditional Chinese, and Turkish.

## 2 Horizontal Controls

- To adjust the horizontal (time/div) scale / 64
- To adjust the horizontal delay (position) / 65
- Panning and Zooming Single or Stopped Acquisitions / 66
- To change the horizontal time mode (Normal, XY, or Roll) / 67
- To display the zoomed time base / 71
- To change the horizontal scale knob's coarse/fine adjustment setting / 72
- To position the time reference (left, center, right, custom) / 72
- Searching for Events / 73
- Navigating the Time Base / 75

The horizontal controls include:

- The horizontal scale and position knobs.
- The **[Horiz]** key for accessing the Horizontal Menu.
- The  zoom key for quickly enabling/disabling the split-screen zoom display.
- The **[Search]** key for finding events on analog channels or in serial decode.
- The **[Navigate]** keys for navigating time, search events, or segmented memory acquisitions.
- Touchscreen controls for setting the horizontal scale and position (delay), accessing the Horizontal Menu, and navigating.

The following figure shows the Horizontal Menu which appears after pressing the **[Horiz]** key.

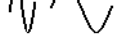


**Figure 2** Horizontal Menu

The Horizontal Menu lets you select the time mode (Normal, XY, or Roll), enable Zoom, set the time base fine control (vernier), and specify the time reference.

The current sample rate is displayed in the Summary box in the right-side information area.

## To adjust the horizontal (time/div) scale

- 1 Turn the large horizontal scale (sweep speed) knob marked  to change the horizontal time/div setting.



You can also make this adjustment using the touchscreen. See **“Access the Horizontal Menu and Open the Scale/Delay Dialog”** on page 56.

Notice how the time/div information in the status line changes.

The ▽ symbol at the top of the display indicates the time reference point.

The horizontal scale knob works (in the Normal time mode) while acquisitions are running or when they are stopped. When running, adjusting the horizontal scale knob changes the sample rate. When stopped, adjusting the horizontal scale knob lets you zoom into acquired data. See **“Panning and Zooming Single or Stopped Acquisitions”** on page 66.

Note that the horizontal scale knob has a different purpose in the Zoom display. See **“To display the zoomed time base”** on page 71.

## To adjust the horizontal delay (position)

- 1 Turn the horizontal delay (position) knob (◀▶).

The trigger point moves horizontally, pausing at 0.00 s (mimicking a mechanical detent), and the delay value is displayed in the status line.

You can also make this adjustment using the touchscreen. See **“Flick or Drag to Scale, Position, and Change Offset”** on page 47 and **“Access the Horizontal Menu and Open the Scale/Delay Dialog”** on page 56.

Changing the delay time moves the trigger point (solid inverted triangle) horizontally and indicates how far it is from the time reference point (hollow inverted triangle ▽). These reference points are indicated along the top of the display grid.

**Figure 2** shows the trigger point with the delay time set to 200  $\mu$ s. The delay time number tells you how far the time reference point is located from the trigger point. When delay time is set to zero, the delay time indicator overlays the time reference indicator.

All events displayed left of the trigger point happened before the trigger occurred. These events are called pre-trigger information, and they show events that led up to the trigger point.

Everything to the right of the trigger point is called post-trigger information. The amount of delay range (pre-trigger and post-trigger information) available depends on the time/div selected and memory depth.

The horizontal position knob works (in the Normal time mode) while acquisitions are running or when they are stopped. When running, adjusting the horizontal scale knob changes the sample rate. When stopped, adjusting the horizontal scale knob lets you zoom into acquired data. See **“Panning and Zooming Single or Stopped Acquisitions”** on page 66.

Note that the horizontal position knob has a different purpose in the Zoom display. See **“To display the zoomed time base”** on page 71.

## Panning and Zooming Single or Stopped Acquisitions

When the oscilloscope is stopped, use the horizontal scale and position knobs to pan and zoom your waveform. The stopped display may contain several acquisitions worth of information, but only the last acquisition is available for pan and zoom.

The ability to pan (move horizontally) and scale (expand or compress horizontally) an acquired waveform is important because of the additional insight it can reveal about the captured waveform. This additional insight is often gained from seeing the waveform at different levels of abstraction. You may want to view both the big picture and the specific little picture details.

The ability to examine waveform detail after the waveform has been acquired is a benefit generally associated with digital oscilloscopes. Often this is simply the ability to freeze the display for the purpose of measuring with cursors or printing the screen. Some digital oscilloscopes go one step further by including the ability to further examine the signal details after acquiring them by panning through the waveform and changing the horizontal scale.

There is no limit imposed on the scaling ratio between the time/div used to acquire the data and the time/div used to view the data. There is, however, a useful limit. This useful limit is somewhat a function of the signal you are analyzing.

**NOTE****Zooming into stopped acquisitions**

The screen will still contain a relatively good display if you zoom-in horizontally by a factor of 1000 and zoom-in vertically by a factor of 10 to display the information from where it was acquired. Remember that you can only make automatic measurements on displayed data.

## To change the horizontal time mode (Normal, XY, or Roll)

1 Press **[Horiz]**.

2 In the Horizontal Menu, press **Time Mode**; then, select:

- **Normal** – the normal viewing mode for the oscilloscope.

In the Normal time mode, signal events occurring before the trigger are plotted to the left of the trigger point (▼) and signal events after the trigger plotted to the right of the trigger point.

- **XY** – XY mode changes the display from a volts-versus-time display to a volts-versus-volts display. The time base is turned off. Channel 1 amplitude is plotted on the X-axis and Channel 2 amplitude is plotted on the Y-axis.

You can use XY mode to compare frequency and phase relationships between two signals. XY mode can also be used with transducers to display strain versus displacement, flow versus pressure, volts versus current, or voltage versus frequency.

Use the cursors to make measurements on XY mode waveforms.

For more information about using XY mode for measurements, refer to **"XY Time Mode"** on page 68.

- **Roll** – causes the waveform to move slowly across the screen from right to left. It only operates on time base settings of 50 ms/div and slower. If the current time base setting is faster than the 50 ms/div limit, it will be set to 50 ms/div when Roll mode is entered.

In Roll mode there is no trigger. The fixed reference point on the screen is the right edge of the screen and refers to the current moment in time. Events that have occurred are scrolled to the left of the reference point. Since there is no trigger, no pre-trigger information is available.

If you would like to pause the display in Roll mode press the **[Single]** key. To clear the display and restart an acquisition in Roll mode, press the **[Single]** key again.

Use Roll mode on low-frequency waveforms to yield a display much like a strip chart recorder. It allows the waveform to roll across the display.

## XY Time Mode

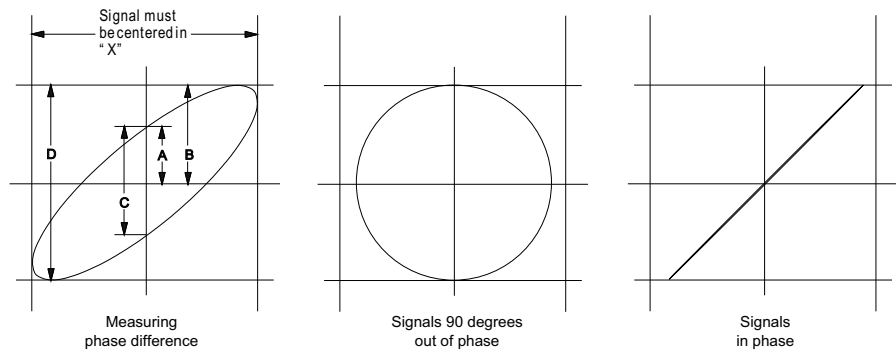
The XY time mode converts the oscilloscope from a volts-versus-time display to a volts-versus-volts display using two input channels. Channel 1 is the X-axis input, channel 2 is the Y-axis input. You can use various transducers so the display could show strain versus displacement, flow versus pressure, volts versus current, or voltage versus frequency.

**Example** This exercise shows a common use of the XY display mode by measuring the phase difference between two signals of the same frequency with the Lissajous method.

- 1** Connect a sine wave signal to channel 1, and a sine wave signal of the same frequency but out of phase to channel 2.
- 2** Press the **[Auto Scale]** key, press the **[Horiz]** key; then, press **Time Mode** and select "XY".
- 3** Center the signal on the display with the channel 1 and 2 position (◆) knobs. Use the channel 1 and 2 volts/div knobs and the channel 1 and 2 **Fine** softkeys to expand the signal for convenient viewing.

The phase difference angle ( $\theta$ ) can be calculated using the following formula (assuming the amplitude is the same on both channels):

$$\sin\theta = \frac{A}{B} \text{ or } \frac{C}{D}$$

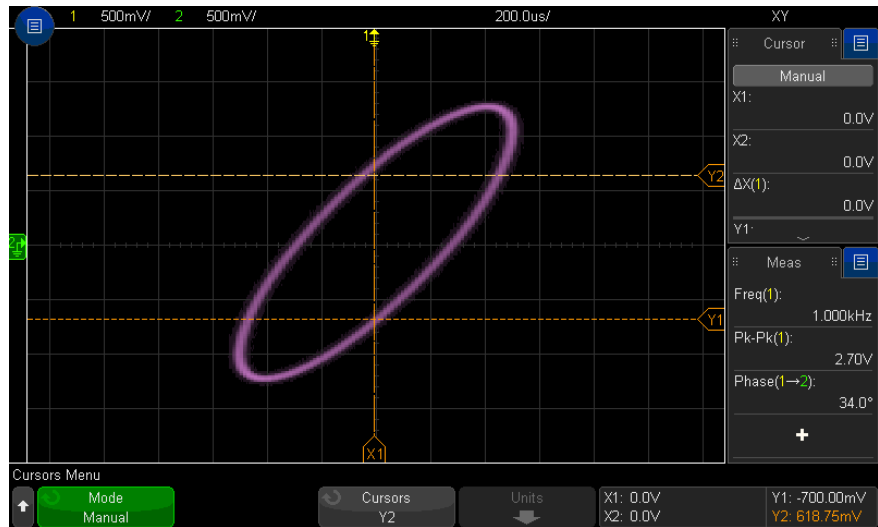


**Figure 3** XY time mode signals, centered on display

- 4 Press the **[Cursors]** key.
- 5 Set the Y2 cursor to the top of the signal, and set Y1 to the bottom of the signal.

Note the  $\Delta Y$  value at the bottom of the display. In this example, we are using the Y cursors, but you could have used the X cursors instead.

- 6 Move the Y1 and Y2 cursors to the intersection of the signal and the Y axis. Again, note the  $\Delta Y$  value.



**Figure 4** Phase difference measurements, automatic and using cursors

7 Calculate the phase difference using the formula below.

For example, if the first  $\Delta Y$  value is 2.297 and the second  $\Delta Y$  value is 1.319:

$$\sin\theta = \frac{\text{second } \Delta Y}{\text{first } \Delta Y} = \frac{1.319}{2.297}; \theta = 35.05 \text{ degrees of phase shift}$$

#### NOTE

#### Z-Axis Input in XY Display Mode (Blanking)

When you select the XY display mode, the time base is turned off. Channel 1 is the X-axis input, channel 2 is the Y-axis input, and the EXT TRIG IN is the Z-axis input. If you only want to see portions of the Y versus X display, use the Z-axis input. Z-axis turns the trace on and off (analog oscilloscopes called this Z-axis blanking because it turned the beam on and off). When Z is low (<1.4 V), Y versus X is displayed; when Z is high (>1.4 V), the trace is turned off.

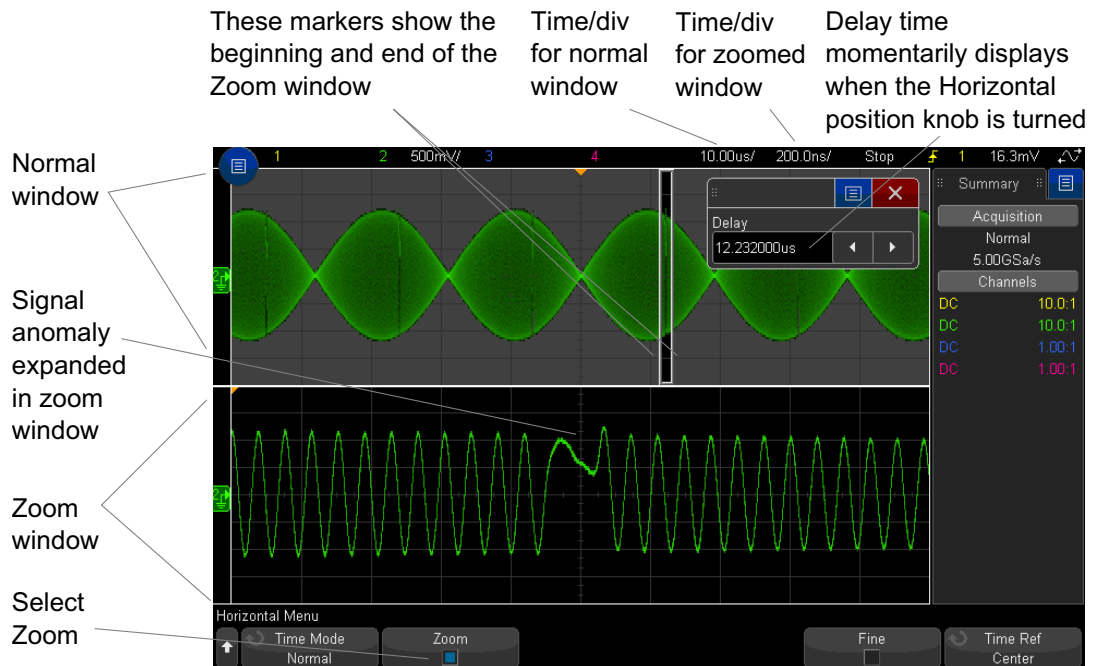
## To display the zoomed time base

Zoom, formerly called Delayed sweep mode, is a horizontally expanded version of the normal display. When Zoom is selected, the display divides in half. The top half of the display shows the normal time/div window and the bottom half displays a faster Zoom time/div window.

The Zoom window is a magnified portion of the normal time/div window. You can use Zoom to locate and horizontally expand part of the normal window for a more detailed (higher-resolution) analysis of signals.

To turn on (or off) Zoom:

- 1 Press the  zoom key (or press the **[Horiz]** key and then the **Zoom** softkey).



The area of the normal display that is expanded is outlined with a box and the rest of the normal display is ghosted. The box shows the portion of the normal sweep that is expanded in the lower half.

To change the time/div for the Zoom window, turn the horizontal scale (sweep speed) knob. As you turn the knob, the zoomed window time/div is highlighted in the status line above the waveform display area. The Horizontal scale (sweep speed) knob controls the size of the box.

The Horizontal position (delay time) knob sets the left-to-right position of the zoom window. The delay value, which is the time displayed relative to the trigger point) is momentarily displayed in the upper-right portion of the display when the delay time (◀▶) knob is turned.

Negative delay values indicate you're looking at a portion of the waveform before the trigger event, and positive values indicate you're looking at the waveform after the trigger event.

To change the time/div of the normal window, turn off Zoom; then, turn the horizontal scale (sweep speed) knob.

For information about using zoom mode for measurements, refer to **"To isolate a pulse for Top measurement"** on page 252 and **"To isolate an event for frequency measurement"** on page 258.

### To change the horizontal scale knob's coarse/fine adjustment setting

- 1 Push the horizontal scale knob (or press **[Horiz] > Fine**) to toggle between fine and coarse adjustment of the horizontal scale.

When **Fine** is enabled, turning the horizontal scale knob changes the time/div (displayed in the status line at the top of the display) in smaller increments. The time/div remains fully calibrated when **Fine** is on.

When **Fine** is turned off, the Horizontal scale knob changes the time/div setting in a 1-2-5 step sequence.

### To position the time reference (left, center, right, custom)

Time reference is the reference point on the display for delay time (horizontal position).

- 1 Press **[Horiz]**.



2 In the Horizontal Menu, press **Time Ref**; then, select:

- **Left** – the time reference is set to one major division from the left edge of the display.
- **Center** – the time reference is set to the center of the display.
- **Right** – the time reference is set to one major division from the right edge of the display.
- **Custom Location** – lets you place the time reference location at a percent of the graticule width (where 0% is the left edge and 100% is the right edge).

A small hollow triangle (▽) at the top of the display grid marks the position of the time reference. When delay time is set to zero, the trigger point indicator (▼) overlays the time reference indicator.

The time reference position sets the initial position of the trigger event within acquisition memory and on the display, with delay set to 0.

Turning the Horizontal scale (sweep speed) knob expands or contracts the waveform about the time reference point (▽). See **"To adjust the horizontal (time/div) scale"** on page 64.

Turning the Horizontal position (◀▶) knob in Normal mode (not Zoom) moves the trigger point indicator (▼) to the left or right of the time reference point (▽). See **"To adjust the horizontal delay (position)"** on page 65.

## Searching for Events

You can use the **[Search]** key and menu to search for Edge, Pulse Width, Rise/Fall Time, Runt, Frequency Peaks, and Serial events on the analog channels.

Setting up searches (see **"To set up searches"** on page 74) is similar to setting up triggers. In fact, except for Frequency Peaks and Serial events, you can copy search setups to trigger setups and vice-versa (see **"To copy search setups"** on page 74).

Searches are different than triggers in that they use the measurement threshold settings instead of trigger levels.

Found search events are marked with white triangles at the top of the graticule, and the number of events found is displayed in the menu line just above the softkey labels.

## To set up searches

- 1 Press **[Search]**.
- 2 In the Search Menu, press **Search**; then, turn the Entry knob to select the search type.
- 3 Use the remaining softkeys to set up the selected search type.

In most cases, setting up searches is similar to setting up triggers:

- For setting up Edge searches, see **"Edge Trigger"** on page 172.
- For setting up Pulse Width searches, see **"Pulse Width Trigger"** on page 175.
- For setting up Rise/Fall Time searches, see **"Rise/Fall Time Trigger"** on page 182.
- For setting up Runt searches, see **"Runt Trigger"** on page 188.
- For setting up Frequency Peak searches, see **"Searching for FFT Peaks"** on page 93.
- For setting up Serial searches, see **"Serial Trigger"** on page 203 and **"Searching Lister Data"** on page 152.

Remember that searches use the measurement threshold settings instead of trigger levels. Use the **Thresholds** softkey in the Search Menu to access the Measurement Threshold Menu. See **"Measurement Thresholds"** on page 270.

## To copy search setups

Except for Frequency Peak and Serial event search setups, you can copy search setups to trigger setups and vice-versa.

- 1 Press **[Search]**.
- 2 In the Search Menu, press **Search**; then, turn the Entry knob to select the search type.
- 3 Press **Copy**.
- 4 In the Search Copy Menu:
  - Press **Copy to Trigger** to copy the setup for the selected search type to the same trigger type. For example, if the current search type is Pulse Width, pressing **Copy to Trigger** copies the search settings to the Pulse Width trigger settings and selects the Pulse Width trigger.

- Press **Copy from Trigger** to copy the trigger setup for the selected search type to the search setup.
- To undo a copy, press **Undo Copy**.

The softkeys in the Search Copy Menu may not be available when one of the settings cannot be copied or there is no trigger type that corresponds to the search type.

## Navigating the Time Base




You can use the **[Navigate]** key and controls to navigate through:

- Captured data (see ["To navigate time"](#) on page 75).
- Search events (see ["To navigate search events"](#) on page 75).
- Segments, when segmented memory acquisitions are turned on (see ["To navigate segments"](#) on page 76).

You can also access navigation controls on the touchscreen. See ["Select Sidebar Information or Controls"](#) on page 49.

### To navigate time



When acquisitions are stopped, you can use the navigation controls to play through the captured data.

- 1 Press **[Navigate]**.
- 2 In the Navigate Menu, press **Navigate**; then, select **Time**.
- 3 Press the  navigation keys to play backward, stop, or play forward in time. You can press the  or  keys multiple times to speed up the playback. There are three speed levels.


You can also access navigation controls on the touchscreen. See ["Select Sidebar Information or Controls"](#) on page 49.

### To navigate search events

When acquisitions are stopped, you can use the navigation controls to go to found search events (set using the **[Search]** key and menu, see ["Searching for Events"](#) on page 73).

- 1 Press **[Navigate]**.
- 2 In the Navigate Menu, press **Navigate**; then, select **Search**.
- 3 Press the   back and forward keys to go to the previous or next search event.

When searching Serial decode:

- You can press the  stop key to set or clear a mark.
- The **Auto zoom** softkey specifies whether the waveform display is automatically zoomed to fit the marked row as you navigate.
- Pressing the **Scroll Lister** softkey lets you use the Entry knob to scroll through data rows in the Lister display.





You can also access navigation controls on the touchscreen. See **"Select Sidebar Information or Controls"** on page 49.

## To navigate segments

When the segmented memory acquisition is enabled and acquisitions are stopped, you can use the navigation controls to play through the acquired segments.

- 1 Press **[Navigate]**.
- 2 In the Navigate Menu, press **Navigate**; then, select **Segments**.
- 3 Press **Play Mode**; then, select:
  - **Manual** – to play through segments manually.

In the Manual play mode:

- Press the   back and forward keys to go to the previous or next segment.
- Press the  softkey to go to the first segment.
- Press the  softkey to go to the last segment.
- **Auto** – to play through segments in an automated fashion.

In the Auto play mode:

- Press the ◀ ▶ navigation keys to play backward, stop, or play forward in time. You can press the ◀ or ▶ keys multiple times to speed up the playback. There are three speed levels.

You can also access navigation controls on the touchscreen. See **“Select Sidebar Information or Controls”** on page 49.



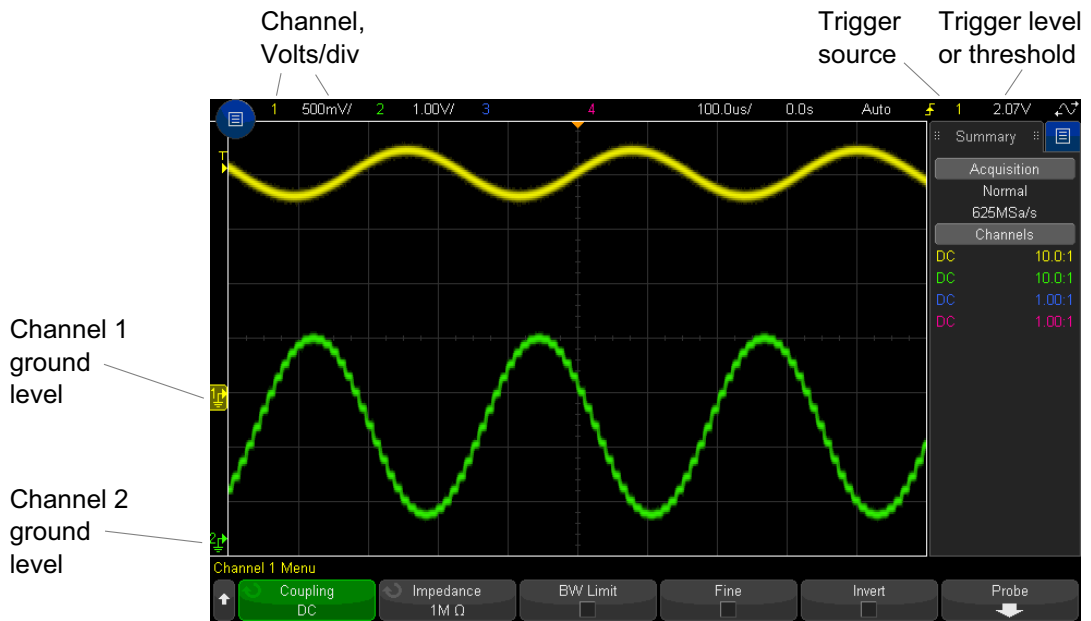
## 3 Vertical Controls


- To turn waveforms on or off (channel or math) / 80
- To adjust the vertical scale / 81
- To adjust the vertical position / 81
- To specify channel coupling / 81
- To specify channel input impedance / 82
- To specify bandwidth limiting / 83
- To change the vertical scale knob's coarse/fine adjustment setting / 83
- To invert a waveform / 84
- Setting Analog Channel Probe Options / 84

The vertical controls include:

- The vertical scale and position knobs for each analog channel.
- The channel keys for turning a channel on or off and accessing the channel's softkey menu.
- Touchscreen controls for setting the vertical scale and position (offset) and accessing the Channel menus.

The following figure shows the Channel 1 Menu that appears after pressing the **[1]** channel key.



The ground level of the signal for each displayed analog channel is identified by the position of the  icon at the far-left side of the display.

To turn waveforms on or off (channel or math)

- 1 Press an analog channel key turn the channel on or off (and to display the channel's menu).

When a channel is on, its key is illuminated.

You can also do this using the touchscreen. See ["Turn Channels On/Off and Open Scale/Offset Dialogs"](#) on page 55.


## NOTE

### Turning channels off

You must be viewing the menu for a channel before you can turn it off. For example, if channel 1 and channel 2 are turned on and the menu for channel 2 is being displayed, to turn channel 1 off, press [1] to display the channel 1 menu; then, press [1] again to turn channel 1 off.



## To adjust the vertical scale

- 1 Turn the large knob above the channel key marked  to set the vertical scale (volts/division) for the channel.


You can also do this using the touchscreen. See [“Turn Channels On/Off and Open Scale/Offset Dialogs”](#) on page 55.

The vertical scale knob changes the analog channel scale in a 1-2-5 step sequence (with a 1:1 probe attached) unless fine adjustment is enabled (see [“To change the vertical scale knob's coarse/fine adjustment setting”](#) on page 83).


The analog channel Volts/Div value is displayed in the status line.

The default mode for expanding the signal when you turn the volts/division knob is vertical expansion about the ground level of the channel; however, you can change this to expand about the center of the display. See [“To choose “expand about” center or ground”](#) on page 347.

## To adjust the vertical position

- 1 Turn the small vertical position knob () to move the channel's waveform up or down on the display.

You can also make this adjustment using the touchscreen. See [“Change Waveform Offsets By Dragging Ground Reference Icons”](#) on page 53 and [“Turn Channels On/Off and Open Scale/Offset Dialogs”](#) on page 55.

The offset voltage value represents the voltage difference between the vertical center of the display and the ground level () icon. It also represents the voltage at the vertical center of the display if vertical expansion is set to expand about ground (see [“To choose “expand about” center or ground”](#) on page 347).

## To specify channel coupling

Coupling changes the channel's input coupling to either **AC** (alternating current) or **DC** (direct current).

**TIP**

If the channel is DC coupled, you can quickly measure the DC component of the signal by simply noting its distance from the ground symbol.

If the channel is AC coupled, the DC component of the signal is removed, allowing you to use greater sensitivity to display the AC component of the signal.

- 1 Press the desired channel key.
- 2 In the Channel Menu, press the **Coupling** softkey to select the input channel coupling:
  - **DC** – DC coupling is useful for viewing waveforms as low as 0 Hz that do not have large DC offsets.
  - **AC** – AC coupling is useful for viewing waveforms with large DC offsets.

When AC coupling is chosen, you cannot select 50 $\Omega$  mode. This is done to prevent damage to the oscilloscope.

AC coupling places a 10 Hz high-pass filter in series with the input waveform that removes any DC offset voltage from the waveform.

Note that Channel Coupling is independent of Trigger Coupling. To change trigger coupling see **"To select the trigger coupling"** on page 209.

## To specify channel input impedance

**NOTE**

When you connect an AutoProbe, self-sensing probe, or a compatible InfiniiMax probe, the oscilloscope automatically configures the analog input channels to the correct impedance.

- 1 Press the desired channel key.
- 2 In the Channel Menu, press **Imped** (impedance); then, select either:
  - **50 Ohm** – matches 50 ohm cables commonly used in making high frequency measurements, and 50 ohm active probes.

When **50 Ohm** input impedance is selected, it is displayed with the channel information on-screen.

When AC coupling is selected (see **"To specify channel coupling"** on page 81) or excessive voltage is applied to the input, the oscilloscope automatically switches to **1M Ohm** mode to prevent possible damage.

- **1M Ohm** – is for use with many passive probes and for general-purpose measurements. The higher impedance minimizes the loading effect of the oscilloscope on the device under test.

This impedance matching gives you the most accurate measurements because reflections are minimized along the signal path.

- See Also**
- For more information on probing, visit: [www.keysight.com/find/scope\\_probes](http://www.keysight.com/find/scope_probes)
  - Information about selecting a probe can be found in document number *Keysight Oscilloscope Probes and Accessories Selection Guide* (part number 5989-6162EN), available at [www.keysight.com](http://www.keysight.com).

## To specify bandwidth limiting

- 1 Press the desired channel key.
- 2 In the Channel Menu, press the **BW Limit** softkey to enable or disable bandwidth limiting.

When bandwidth limit is on, the maximum bandwidth for the channel is approximately 20 MHz. For waveforms with frequencies below this, turning bandwidth limit on removes unwanted high frequency noise from the waveform. The bandwidth limit also limits the trigger signal path of any channel that has **BW Limit** turned on.

## To change the vertical scale knob's coarse/fine adjustment setting

- 1 Push the channel's vertical scale knob (or press the channel key and then the **Fine** softkey in the Channel Menu) to toggle between fine and coarse adjustment of the vertical scale.

You can also do this using the touchscreen. See **"Turn Channels On/Off and Open Scale/Offset Dialogs"** on page 55.

When **Fine** adjustment is selected, you can change the channel's vertical sensitivity in smaller increments. The channel sensitivity remains fully calibrated when **Fine** is on.

The vertical scale value is displayed in the status line at the top of the display.

When **Fine** is turned off, turning the volts/division knob changes the channel sensitivity in a 1-2-5 step sequence.

## To invert a waveform

- 1 Press the desired channel key.
- 2 In the Channel Menu, press the **Invert** softkey to invert the selected channel.

When **Invert** is selected, the voltage values of the displayed waveform are inverted.

Invert affects how a channel is displayed. However, when using basic triggers, the oscilloscope attempts to maintain the same trigger point by changing trigger settings.

Inverting a channel also changes the result of any math function selected in the Waveform Math Menu or any measurement.

## Setting Analog Channel Probe Options

- 1 Press the probe's associated channel key.
- 2 In the Channel Menu, press the **Probe** softkey to display the Channel Probe Menu.

This menu lets you select additional probe parameters such as attenuation factor and units of measurement for the connected probe.



The Channel Probe Menu changes depending on the type of probe connected.

For passive probes (such as the N2862A/B, N2863A/B, N2889A, N2890A, 10073C, 10074C, or 1165A probes), the **Probe Check** softkey appears; it guides you through the process of compensating probes.

For some active probes (such as InfiniiMax probes), the oscilloscope can accurately calibrate its analog channels for the probe. When you connect a probe that can be calibrated, the **Calibrate Probe** softkey appears (and the probe attenuation softkey may change). See [“To calibrate a probe”](#) on page 86.

- See Also
- [“To specify the channel units”](#) on page 85
  - [“To specify the probe attenuation”](#) on page 85
  - [“To specify the probe skew”](#) on page 86

## To specify the channel units

- 1 Press the probe's associated channel key.
- 2 In the Channel Menu, press **Probe**.
- 3 In the Channel Probe Menu, press **Units**; then, select:
  - **Volts** – for a voltage probe.
  - **Amps** – for a current probe.


Channel sensitivity, trigger level, measurement results, and math functions will reflect the measurement units you have selected.

## To specify the probe attenuation

This is set automatically if the oscilloscope can identify the connected probe. See Analog channel inputs (see [page 43](#)).

The probe attenuation factor must be set properly for accurate measurement results.

If you connect a probe that is not automatically identified by the oscilloscope, you can manually set the attenuation factor as follows:

- 1 Press the channel key.
- 2 Press the **Probe** softkey until you have selected how you want to specify the attenuation factor, choosing either **Ratio** or **Decibels**.
- 3 Turn the Entry knob  to set the attenuation factor for the connected probe.

When measuring voltage values, the attenuation factor can be set from 0.001:1 to 10000:1 in a 1-2-5 sequence.

When measuring current values with a current probe, the attenuation factor can be set from 10 V/A to 0.0001 V/A.

When specifying the attenuation factor in decibels, you can select values from -20 dB to 80 dB.

If Amps is chosen as the units and a manual attenuation factor is chosen, then the units as well as the attenuation factor are displayed above the **Probe** softkey.



### To specify the probe skew

When measuring time intervals in the nanoseconds (ns) range, small differences in cable length can affect the measurement. Use **Skew** to remove cable-delay errors between any two channels.

- 1 Probe the same point with both probes.
- 2 Press one of the probes associated channel key.
- 3 In the Channel Menu, press **Probe**.
- 4 In the Channel Probe Menu, press **Skew**; then, select the desired skew value.

Each analog channel can be adjusted  $\pm 100$  ns in 10 ps increments for a total of 200 ns difference.

The skew setting is not affected by pressing [**Default Setup**] or [**Auto Scale**].

### To calibrate a probe

The **Calibrate Probe** softkey guides you through the process of calibrating probes.

For certain active probes, such as InfiniiMax probes, the oscilloscope can accurately calibrate its analog channels for the probe. When you connect a probe that can be calibrated, the **Calibrate Probe** softkey in the Channel Probe Menu becomes active.

To calibrate one of these probes:

- 1 First, plug your probe into one of the oscilloscope channels.  
This could be, for example, an InfiniiMax probe amplifier/probe head with attenuators attached.
- 2 Connect the probe to the left side, Demo 2, Probe Comp terminal, and the probe ground to the ground terminal.

**NOTE**

When calibrating a differential probe, connect the positive lead to the Probe Comp terminal and the negative lead to the ground terminal. You may need to connect an alligator clip to the ground lug to allow a differential probe to span between the Probe Comp test point and ground. A good ground connection ensures the most accurate probe calibration.

---

- 3 Press the Channel on/off key to turn the channel on (if the channel is off).
- 4 In the Channel Menu, press the **Probe** softkey.
- 5 In the Channel Probe Menu, the second softkey from the left is for specifying your probe head (and attenuation). Repeatedly press this softkey until the probe head selection matches the attenuator you are using.

The choices are:

- 10:1 single-ended browser (no attenuator).
- 10:1 differential browser (no attenuator).
- 10:1 (+6 dB Atten) single-ended browser.
- 10:1 (+6 dB Atten) differential browser.
- 10:1 (+12 dB Atten) single-ended browser.
- 10:1 (+12 dB Atten) differential browser.
- 10:1 (+20 dB Atten) single-ended browser.
- 10:1 (+20 dB Atten) differential browser.

- 6 Press the **Calibrate Probe** softkey and follow the instructions on the display.

For more information on InfiniiMax probes and accessories, see the probe's *User's Guide*.





## 4 FFT Spectral Analysis

FFT is used to compute the fast Fourier transform using analog input channels or a lower math function. FFT takes the digitized time record of the specified source and transforms it to the frequency domain. When the FFT function is selected, the FFT spectrum is plotted on the oscilloscope display as magnitude in dBV versus frequency. The readout for the horizontal axis changes from time to frequency (Hertz) and the vertical readout changes from volts to dB.

Use the FFT function to find crosstalk problems, to find distortion problems in analog waveforms caused by amplifier non-linearity, or for adjusting analog filters.

To display a FFT waveform:

- 1 Press the **[FFT]** key.



- **Source 1** – selects the source for the FFT.
- **Display** – selects one of these FFT waveform display modes:
  - **Normal** – this is the FFT waveform without any averaging or hold functions applied. This is how FFT math function waveforms are displayed.
  - **Averaged Value** – the FFT waveform is averaged the selected number of times. Averages are calculated using a "decaying average" approximation, where:

$$\text{next\_average} = \text{current\_average} + (\text{new\_data} - \text{current\_average})/N$$

Where N starts at 1 for the first acquisition and increments for each following acquisition until it reaches the selected number of averages, where it holds.

- **Max Hold** – records the maximum vertical values found at each horizontal bucket across multiple analysis cycles and uses those values to build a waveform. This display mode is often referred to as Max Envelope.
- **Min Hold** – records the minimum vertical values found at each horizontal bucket across multiple analysis cycles and uses those values to build a waveform. This display mode is often referred to as Min Envelope.
- **Span/Center** or **Start Freq/Stop Freq** – this pair of softkeys let you define the displayed frequency range. Press the softkeys to toggle between:
  - **Span/Center** – **Span** specifies the frequency range represented by the width of the display. Divide span by 10 to calculate the frequency scale per division. **Center** specifies the frequency at the center vertical grid line of the display.
  - **Start Freq/Stop Freq** – **Start Freq** specifies the frequency at the left side of the display. **Stop Freq** specifies the frequency at the right side of the display.

To set desired values, tap the softkey label on screen for a keypad entry dialog or turn the Entry knob.

- **More FFT** – displays the More FFT Settings Menu.

## 2 Press the **More FFT** softkey to display additional FFT settings.



- **Window**– selects a window to apply to your FFT input signal:
  - **Hanning** – window for making accurate frequency measurements or for resolving two frequencies that are close together.
  - **Flat Top** – window for making accurate amplitude measurements of frequency peaks.
  - **Rectangular** – good frequency resolution and amplitude accuracy, but use only where there will be no leakage effects. Use on self-windowing waveforms such as pseudo-random noise, impulses, sine bursts, and decaying sinusoids.
  - **Blackman Harris** – window reduces time resolution compared to a rectangular window, but improves the capacity to detect smaller impulses due to lower secondary lobes.

- **Bartlett** – (triangular, with end points at zero) window is similar to the Hanning window in that it is good for making accurate frequency measurements, but its higher and wider secondary lobes make it not quite as good for resolving frequencies that are close together.
- **Vertical Units** – lets you select Decibels or V RMS as the units for the FFT vertical scale.
- **FFT Gating** – when the zoomed time base is displayed, press this softkey to select:
  - **No Gating** – the FFT is performed on the source waveform in the upper Main time base window.
  - **Gate By Zoom** – the FFT is performed on the source waveform in the lower Zoom window.
- **Auto Setup** – sets the frequency Span and Center to values that will cause the entire available spectrum to be displayed. The maximum available frequency is half the FFT sample rate, which is a function of the time per division setting. The FFT resolution is the quotient of the sampling rate and the number of FFT points ( $f_s/N$ ). The current FFT Resolution is displayed above the softkeys.

**NOTE****Scale and offset considerations**

If you do not manually change the FFT scale or offset settings, when you turn the horizontal scale knob, the span and center frequency settings will automatically change to allow optimum viewing of the full spectrum.

If you do manually set scale or offset, turning the horizontal scale knob will not change the span or center frequency settings, allowing you see better detail around a specific frequency.

Pressing the FFT **Auto Setup** softkey will automatically rescale the waveform and span and center will again automatically track the horizontal scale setting.

- 3 To make cursor measurements, press the **[Cursors]** key and set the **Source** softkey to **Math N**.

Use the X1 and X2 cursors to measure frequency values and difference between two frequency values ( $\Delta X$ ). Use the Y1 and Y2 cursors to measure amplitude in dB and difference in amplitude ( $\Delta Y$ ).

- 4 To make other measurements, press the **[Meas]** key and set the **Source** softkey to **Math N**.

You can make peak-to-peak, maximum, minimum, and average dB measurements on the FFT waveform. You can also find the frequency value at the first occurrence of the waveform maximum by using the X at Max Y measurement.

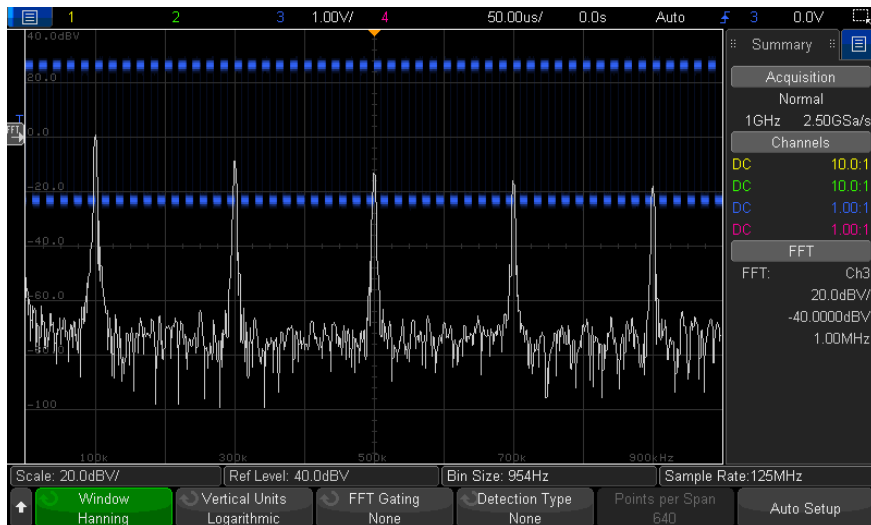
To adjust the FFT waveform scale and offset

- 1 Make sure the multiplexed scale and position knobs above and below the **[FFT]** key are selected for the FFT waveform.

If the arrow to the left of the **[FFT]** key is not illuminated, press the key.

- 2 Use the multiplexed scale and position knobs next to the **[Math]** key to re-size and re-position the math waveform.

The following FFT spectrum was obtained by connecting a 2.5 V, 100 kHz square wave to channel 4. Set the horizontal scale to 50  $\mu$ s/div, vertical sensitivity to 1 V/div, Units/div to 20 dBV, Offset to -40.0 dBV, Center frequency to 500 kHz, frequency Span to 1 MHz, and window to Hanning.



- See Also
- ["Searching for FFT Peaks"](#) on page 93
  - ["FFT Measurement Hints"](#) on page 93
  - ["FFT Units"](#) on page 95
  - ["FFT DC Value"](#) on page 95

- "FFT Aliasing" on page 95
- "FFT Spectral Leakage" on page 97
- "Units for Math Waveforms" on page 101

## Searching for FFT Peaks

To search for FFT math function frequency peaks:

- 1 Press **[Search]**.
- 2 In the Search Menu, press **Search**; then, turn the Entry knob to select **Frequency Peaks**.
- 3 Press **Source** and select the FFT math function waveform to search.
- 4 Press **Max # Peaks** and specify the maximum number of FFT peaks to find.
- 5 Press **Threshold** and turn the Entry knob to specify the threshold level necessary to be considered a peak.
- 6 Press **Excursion** to specify the amplitude above the FFT waveform's noise floor necessary to be recognized as a peak.

Note that the FFT waveform's noise floor level differs when additional math functions are applied to the FFT:

- When **Averaged Value**, **Max Hold**, or **Min Hold** are applied, the FFT waveform's noise floor is more stable, and excursion level settings are more accurate.
- When no additional math functions are applied (normal), the FFT waveform's noise floor is less stable and excursion level settings are less accurate.

White arrowheads at the top of the graticule show where FFT peaks are found.

When acquisitions are stopped, you can use the **[Navigate]** keys and cursors to look at the search events found.

## FFT Measurement Hints

The number of points acquired for the FFT record can be up to 65,536, and when frequency span is at maximum, all points are displayed. Once the FFT spectrum is displayed, the frequency span and center frequency controls are used much like the controls of a spectrum analyzer to examine the frequency of interest in greater

detail. Place the desired part of the waveform at the center of the screen and decrease frequency span to increase the display resolution. As frequency span is decreased, the number of points shown is reduced, and the display is magnified.

While the FFT spectrum is displayed, use the **[Math]** and **[Cursors]** keys to switch between measurement functions and frequency domain controls in FFT Menu.

**NOTE****FFT Resolution**

The FFT resolution is the quotient of the sampling rate and the number of FFT points ( $f_s/N$ ). With a fixed number of FFT points (up to 65,536), the lower the sampling rate, the better the resolution.

Decreasing the effective sampling rate by selecting a greater time/div setting will increase the low frequency resolution of the FFT display and also increase the chance that an alias will be displayed. The resolution of the FFT is the effective sample rate divided by the number of points in the FFT. The actual resolution of the display will not be this fine as the shape of the window will be the actual limiting factor in the FFTs ability to resolve two closely spaced frequencies. A good way to test the ability of the FFT to resolve two closely spaced frequencies is to examine the sidebands of an amplitude modulated sine wave.

For the best vertical accuracy on peak measurements:

- Make sure the probe attenuation is set correctly. The probe attenuation is set from the Channel Menu if the operand is a channel.
- Set the source sensitivity so that the input signal is near full screen, but not clipped.
- Use the Flat Top window.
- Set the FFT sensitivity to a sensitive range, such as 2 dB/division.

For best frequency accuracy on peaks:

- Use the Hanning window.
- Use Cursors to place an X cursor on the frequency of interest.
- Adjust frequency span for better cursor placement.
- Return to the Cursors Menu to fine tune the X cursor.

For more information on the use of FFTs please refer to Keysight Application Note 243, *The Fundamentals of Signal Analysis* at <http://literature.cdn.keysight.com/litweb/pdf/5952-8898E.pdf>. Additional information can be obtained from Chapter 4 of the book *Spectrum and Network Measurements* by Robert A. Witte.

## FFT Units

**FFT (Magnitude) Units**    FFT units are displayed as dB.

**FFT (Phase) Units**    In this case, the vertical units are degrees or radians.

## FFT DC Value

The FFT computation produces a DC value that is incorrect. It does not take the offset at center screen into account. The DC value is not corrected in order to accurately represent frequency components near DC.

## FFT Aliasing

When using FFTs, it is important to be aware of frequency aliasing. This requires that the operator have some knowledge as to what the frequency domain should contain, and also consider the sampling rate, frequency span, and oscilloscope vertical bandwidth when making FFT measurements. The FFT resolution (the quotient of the sampling rate and the number of FFT points) is displayed directly above the softkeys when the FFT Menu is displayed.

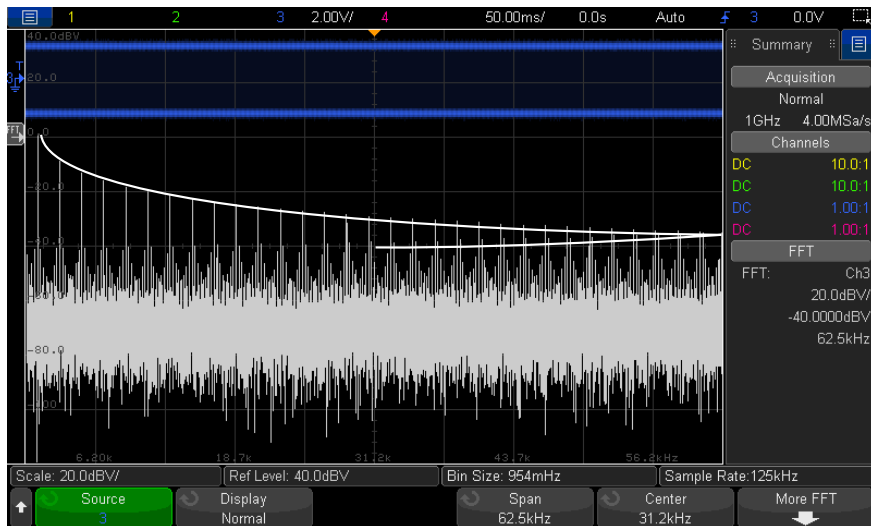
### NOTE

#### **Nyquist Frequency and Aliasing in the Frequency Domain**

The Nyquist frequency is the highest frequency that any real-time digitizing oscilloscope can acquire without aliasing. This frequency is half of the sample rate. Frequencies above the Nyquist frequency will be under sampled, which causes aliasing. The Nyquist frequency is also called the folding frequency because aliased frequency components fold back from that frequency when viewing the frequency domain.

Aliasing happens when there are frequency components in the signal higher than half the sample rate. Because the FFT spectrum is limited by this frequency, any higher components are displayed at a lower (aliased) frequency.

The following figure illustrates aliasing. This is the spectrum of a 990 Hz square wave, which has many harmonics. The horizontal time/div setting for the square wave sets the sample rate and results in a FFT resolution of 1.91 Hz. The displayed FFT spectrum waveform shows the components of the input signal above the Nyquist frequency to be mirrored (aliased) on the display and reflected off the right edge.



**Figure 5** Aliasing

Because the frequency span goes from  $\approx 0$  to the Nyquist frequency, the best way to prevent aliasing is to make sure that the frequency span is greater than the frequencies of significant energy present in the input signal.



## FFT Spectral Leakage

The FFT operation assumes that the time record repeats. Unless there is an integral number of cycles of the sampled waveform in the record, a discontinuity is created at the end of the record. This is referred to as leakage. In order to minimize spectral leakage, windows that approach zero smoothly at the beginning and end of the signal are employed as filters to the FFT. The FFT Menu provides these windows: Hanning, Flat Top, Rectangular, Blackman-Harris, and Bartlett. For more information on leakage, see Keysight Application Note 243, *The Fundamentals of Signal Analysis* at <http://literature.cdn.keysight.com/litweb/pdf/5952-8898E.pdf>.



## 5 Math Waveforms

- To display math waveforms / 99
- To adjust the math waveform scale and offset / 101
- Units for Math Waveforms / 101
- Math Operators / 102
- Math Transforms / 104
- Math Filters / 118
- Math Visualizations / 121

In addition to the dedicated FFT function (see [Chapter 4](#), “FFT Spectral Analysis,” starting on page 89), you can define two other math functions. One math function waveform can be displayed at a time. The math function waveform is displayed in light purple.

Math functions can be performed on analog channels or they can be performed on lower math functions when using operators other than add, subtract, multiply, or divide.

### To display math waveforms

- 1 Press the **[Math]** key on the front panel to display the Waveform Math Menu.



- 2 Press the **Display Math** softkey and turn the Entry knob to select the math function you want to display. Then, either push the Entry knob or press the **Display Math** softkey again to display the selected math function.

- 3 Use the **Operator** softkey to select an operator, transform, filter, or visualization.

For more information on the operators, see:

- “**Math Operators**” on page 102
  - “**Math Transforms**” on page 104
  - “**Math Filters**” on page 118
  - “**Math Visualizations**” on page 121
- 4 Use the **Source 1** softkey to select the analog channel, lower math function, or reference waveform on which to perform math. You can rotate the Entry knob or repetitively press the **Source 1** softkey to make your selection.

Higher math functions can operate on lower math functions when using operators other than the simple arithmetic operations (+, -, \*, /). For example, if **Math 1** is set up as a subtract operation between channels 1 and 2, the **Math 2** function could be set up as a FFT operation on the Math 1 function. These are called cascaded math functions.

To cascade math functions, select the lower math function using the **Source 1** softkey.

**TIP**

When cascading math functions, to get the most accurate results, be sure to vertically scale lower math functions so that their waveforms take up the full screen without being clipped.

- 
- 5 If you selected an arithmetic operator for the math function, use the **Source 2** softkey to select the second source for the arithmetic operation.
  - 6 To re-size and re-position the math waveform, see “**To adjust the math waveform scale and offset**” on page 101.

**TIP****Math Operating Hints**

If the analog channel or math function is clipped (not fully displayed on screen) the resulting displayed math function will also be clipped.

Once the function is displayed, the analog channel(s) may be turned off for better viewing of the math waveform.

The vertical scaling and offset of each math function can be adjusted for ease of viewing and measurement considerations.

The math function waveform can be measured using **[Cursors]** and/or **[Meas]**.

## To adjust the math waveform scale and offset

- 1 Make sure the multiplexed scale and position knobs above and below the **[Math]** key are selected for the math waveform.  
If the arrow to the left of the **[Math]** key is not illuminated, press the key.
- 2 Use the multiplexed scale and position knobs above and below the **[Math]** key to re-size and re-position the math waveform.

**NOTE****Math Scale and Offset are Set Automatically**

Any time the currently displayed math function definition is changed, the function is automatically scaled for optimum vertical scale and offset. If you manually set scale and offset for a function, select a new function, then select the original function, the original function will be automatically rescaled.

See Also · ["Units for Math Waveforms"](#) on page 101

## Units for Math Waveforms

Units for each input channel can be set to Volts or Amps using the **Units** softkey in the channel's Probe Menu. Units for math function waveforms are:

Math function	Units
add or subtract	V or A
multiply	$V^2$ , $A^2$ , or W (Volt-Amp)
d/dt	V/s or A/s (V/second or A/second)
$\int dt$	Vs or As (V-seconds or A-seconds)
FFT	See "FFT Units" on page 95.
$\sqrt{\text{(square root)}}$	$V^{1/2}$ , $A^{1/2}$ , or $W^{1/2}$ (Volt-Amp)

A scale unit of **U** (undefined) will be displayed for math functions when two source channels are used and they are set to dissimilar units and the combination of units cannot be resolved.

## Math Operators

Math operators perform arithmetic operations (like add, subtract, or multiply) on analog input channels.

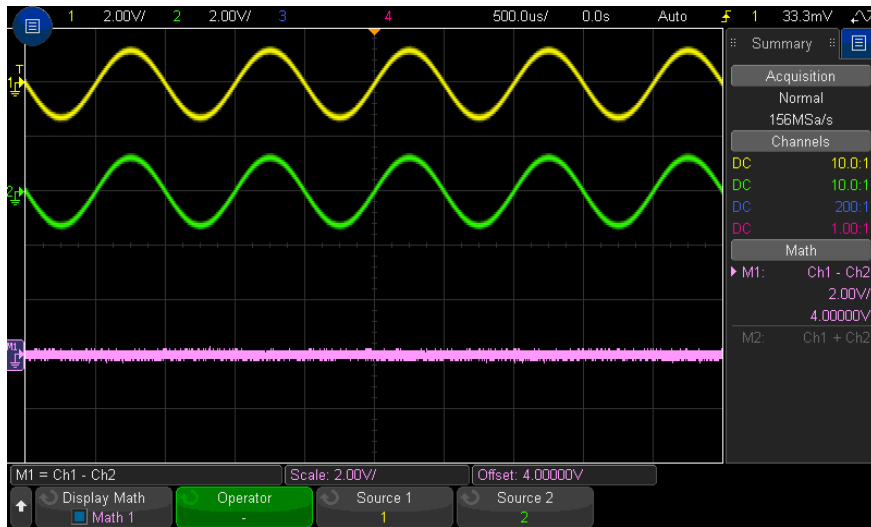
- "Add or Subtract" on page 102
- "Multiply or Divide" on page 103

### Add or Subtract

When you select add or subtract, the **Source 1** and **Source 2** values are added or subtracted point by point, and the result is displayed.

You can use subtract to make a differential measurement or to compare two waveforms.

If your waveforms' DC offsets are larger than the dynamic range of the oscilloscope's input channels you will need to use a differential probe instead.



**Figure 6** Example of Subtract Channel 2 from Channel 1

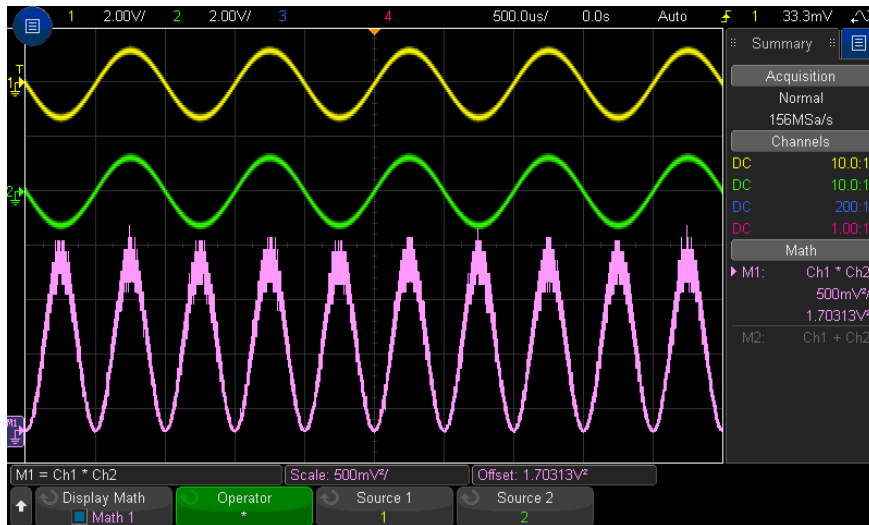
See Also · [“Units for Math Waveforms”](#) on page 101

## Multiply or Divide

When you select the multiply or divide math function, the **Source 1** and **Source 2** values are multiplied or divided point by point, and the result is displayed.

The divide by zero case places holes (that is, zero values) in the output waveform.

Multiply is useful for seeing power relationships when one of the channels is proportional to the current.



**Figure 7** Example of Multiply Channel 1 by Channel 2

See Also · [“Units for Math Waveforms”](#) on page 101

## Math Transforms

Math transforms perform a transform function (like differentiate, integrate, FFT, or square root) on an analog input channel or on the result of an arithmetic operation.

- [“Differentiate”](#) on page 105
- [“Integrate”](#) on page 106
- [“FFT Magnitude, FFT Phase”](#) on page 108
- [“Square Root”](#) on page 113
- [“Ax + B”](#) on page 114
- [“Square”](#) on page 115
- [“Absolute Value”](#) on page 115
- [“Common Logarithm”](#) on page 116



- "Natural Logarithm" on page 116
- "Exponential" on page 117
- "Base 10 Exponential" on page 117

## Differentiate

**d/dt** (differentiate) calculates the discrete time derivative of the selected source.

You can use differentiate to measure the instantaneous slope of a waveform. For example, the slew rate of an operational amplifier may be measured using the differentiate function.

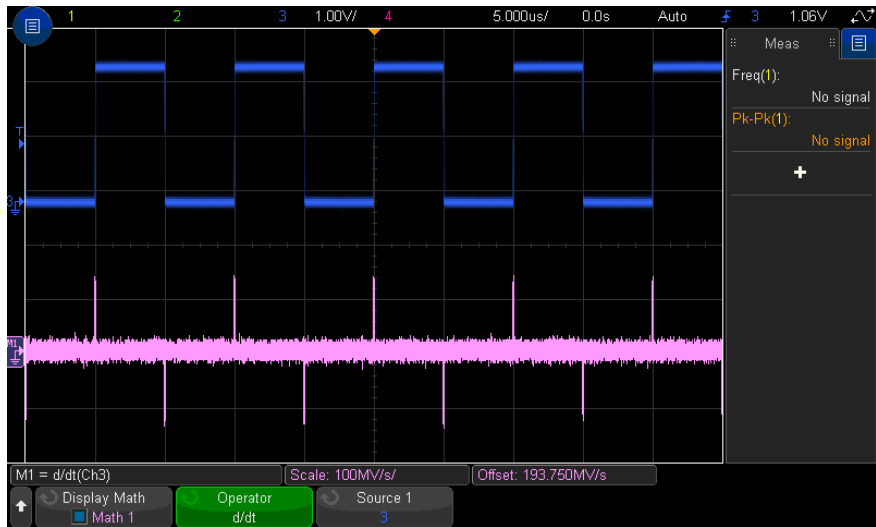
Because differentiation is very sensitive to noise, it is helpful to set acquisition mode to **Averaging** (see "Selecting the Acquisition Mode" on page 221).

**d/dt** plots the derivative of the selected source using the "average slope estimate at 4 points" formula. The equation is:

$$d_i = \frac{y_{i+4} + 2y_{i+2} - 2y_{i-2} - y_{i-4}}{8 \Delta t}$$

Where:

- d = differential waveform.
- y = channel 1, 2, 3, 4, or Math 1, Math 2, Math 3 (lower math function) data points.
- i = data point index.
- $\Delta t$  = point-to-point time difference.



**Figure 8** Example of Differentiate Function

See Also · [“Units for Math Waveforms”](#) on page 101

## Integrate

$\int dt$  (integrate) calculates the integral of the selected source. It shows the accumulated amount of change.

You can use integrate to calculate the energy of a pulse in volt-seconds or measure the area under a waveform by measuring the difference in the integrate function value across the pulse or waveform.

$\int dt$  plots the integral of the source using the "Trapezoidal Rule". The equation is:

$$I_n = c_o + \Delta t \sum_{i=0}^n y_i$$

Where:

- I = integrated waveform.

- $\Delta t$  = point-to-point time difference.
- $y$  = channel 1, 2, 3, 4, or Math 1, Math 2, Math 3 (lower math function) data points.
- $c_0$  = arbitrary constant.
- $i$  = data point index.

The integrate operator provides an **Offset** softkey that lets you enter a DC offset correction factor for the input signal. Small DC offset in the integrate function input (or even small oscilloscope calibration errors) can cause the integrate function output to "ramp" up or down. This DC offset correction lets you level the integrate waveform.



**Figure 9** Integrate Without Signal Offset



**Figure 10** Integrate With Signal Offset

See Also · ["Units for Math Waveforms"](#) on page 101

## FFT Magnitude, FFT Phase

Using the Fast Fourier Transform (FFT), the FFT (Magnitude) math function displays the magnitudes of the frequency content that makes up the source waveform, and the FFT (Phase) math function shows the phase relationships of the frequency content. The FFT takes the digitized time record of the specified source and transforms it to the frequency domain.

The source of the FFT math functions can be analog input channels or a lower math function.

The horizontal axis of FFT math functions is frequency (Hertz). For the FFT (Magnitude) math function, the vertical axis is in decibels when Logarithmic vertical units are selected or V RMS when Linear vertical units are selected. For the FFT (Phase) math function, the vertical axis is in degrees or radians.

Use the FFT (Magnitude) function to find crosstalk problems, to find distortion problems in analog waveforms caused by amplifier non-linearity, or for adjusting analog filters.

To display a FFT waveform:

- 1 Press the **Display Math** softkey and turn the Entry knob to select the math function you want to display. Then, either push the Entry knob or press the **Display Math** softkey again to display the selected math function.
- 2 Press the **[Math]** key. Then, press the **Display Math** softkey and select the math function you want to use. Then, press the **Operator** softkey and select **FFT (Magnitude)** or **FFT (Phase)**.



- **Source 1** – selects the source for the FFT.
- **Span/Center** or **Start Freq/Stop Freq** – this pair of softkeys let you define the displayed frequency range. Press the softkeys to toggle between:
  - **Span/Center** – **Span** specifies the frequency range represented by the width of the display. Divide span by 10 to calculate the frequency scale per division. **Center** specifies the frequency at the center vertical grid line of the display.
  - **Start Freq/Stop Freq** – **Start Freq** specifies the frequency at the left side of the display. **Stop Freq** specifies the frequency at the right side of the display.

To set desired values, tap the softkey label on screen for a keypad entry dialog or turn the Entry knob.

- **Scale** – opens a dialog box for adjusting the math waveform's vertical scale.
  - **Offset** – opens a dialog box for adjusting the math waveform's vertical offset.
  - **Bin Size, RBW** (Resolution Bandwidth), **Sample Rate** – displays the FFT resolution in one of three different ways.
  - **More FFT** – displays the More FFT Settings Menu.
- 3 Press the **More FFT** softkey to display additional FFT settings.



- **Window**— selects a window to apply to your FFT input signal:
  - **Hanning** — window for making accurate frequency measurements or for resolving two frequencies that are close together.
  - **Flat Top** — window for making accurate amplitude measurements of frequency peaks.
  - **Rectangular** — good frequency resolution and amplitude accuracy, but use only where there will be no leakage effects. Use on self-windowing waveforms such as pseudo-random noise, impulses, sine bursts, and decaying sinusoids.
  - **Blackman Harris** — window reduces time resolution compared to a rectangular window, but improves the capacity to detect smaller impulses due to lower secondary lobes.
  - **Bartlett** — (triangular, with end points at zero) window is similar to the Hanning window in that it is good for making accurate frequency measurements, but its higher and wider secondary lobes make it not quite as good for resolving frequencies that are close together.
- **Vertical Units** — For FFT (Magnitude), you can select **Logarithmic** (decibels) or **Linear** (V RMS). For FFT (Phase), you can select **Degrees** or **Radians**.

Use the multiplexed knobs for the **[Math]** key to adjust the FFT waveform vertical scale and offset.

- **FFT Gating**— When the zoomed time base is displayed, press this softkey to select:
  - **No Gating** — the FFT is performed on the source waveform in the upper Main time base window.
  - **Gate By Zoom** — the FFT is performed on the source waveform in the lower Zoom window.
- **Detection Type**— When the FFT (Magnitude) operator is selected, this softkey lets you set the FFT detector decimation type.

Detectors give you a way of manipulating the acquired data to emphasize different features of the data. Detectors reduce (decimate) the number of FFT points to at most the number of specified detector points. In this reduction, sampled FFT points are bucketized, that is, split into a number of

groups that equals the specified number of detector points. Then, the points in each bucket are reduced to a single point according to the selected detection type. The detector types are:

- **None** – No detector is used.
- **Sample** – Takes the point nearest to the center of every bucket.
- **+ Peak** – Takes the most positive point in every bucket.
- **- Peak** – Takes the most negative point in every bucket.
- **Average** – Takes the average of all points in every bucket.
- **Normal** – Implements a rosenfell algorithm. This method to picks either the minimum or maximum sample in every bucket depending on whether the data is monotonically increasing, decreasing, or varying. For details, see the [Spectrum Analysis Basics application note](http://www.keysight.com) at [www.keysight.com](http://www.keysight.com).

When detectors are used, the FFT's output is decimated, and any analysis is performed on the reduced or detected data set.

- **Points per Span** – When the FFT (Magnitude) operator is selected and a detector is used, this softkey specifies the maximum number of points that detectors should decimate to. This is also the number of buckets that sampled FFT points are grouped into before the selected detection type reduction (decimation) is applied.

The minimum number of points is 640.

The maximum number of points, 64K, is the measurement record limit.

- **Auto Setup** – sets the frequency Span and Center to values that will cause the entire available spectrum to be displayed. The maximum available frequency is half the FFT sample rate, which is a function of the time per division setting. The FFT resolution is the quotient of the sampling rate and the number of FFT points ( $f_s/N$ ). The current FFT Resolution is displayed above the softkeys.
- **Zero Phase Ref** – When the FFT (Phase) operator is selected, this softkey sets the reference point for calculating the FFT Phase function:
  - **Trigger** – the FFT phase is measured from the trigger (time=0) point of the waveform.
  - **Entire Display** – the FFT phase is measured from the beginning of the displayed waveform.

**NOTE****Scale and offset considerations**

If you do not manually change the FFT scale or offset settings, when you turn the horizontal scale knob, the span and center frequency settings will automatically change to allow optimum viewing of the full spectrum.

If you do manually set scale or offset, turning the horizontal scale knob will not change the span or center frequency settings, allowing you see better detail around a specific frequency.

Pressing the FFT **Auto Setup** softkey will automatically rescale the waveform and span and center will again automatically track the horizontal scale setting.

---

- 4** To make cursor measurements, press the **[Cursors]** key and set the **Source** softkey to **Math N**.

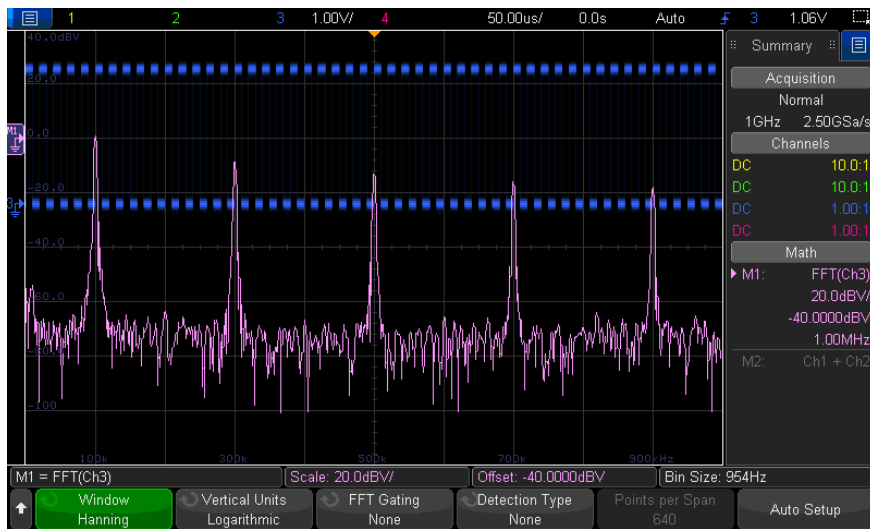
Use the X1 and X2 cursors to measure frequency values and difference between two frequency values ( $\Delta X$ ). Use the Y1 and Y2 cursors to measure amplitude in dB and difference in amplitude ( $\Delta Y$ ).

- 5** To make other measurements, press the **[Meas]** key and set the **Source** softkey to **Math N**.

You can make peak-to-peak, maximum, minimum, and average dB measurements on the FFT waveform. You can also find the frequency value at the first occurrence of the waveform maximum by using the X at Max Y measurement.

The following FFT (Magnitude) spectrum was obtained by connecting a 2.5 V, 100 kHz square wave to channel 1. Set the horizontal scale to 50  $\mu\text{s}/\text{div}$ , vertical sensitivity to 1 V/div, Units/div to 20 dBV, Offset to -40.0 dBV, Center frequency to 500 kHz, frequency Span to 1 MHz, and window to Hanning.



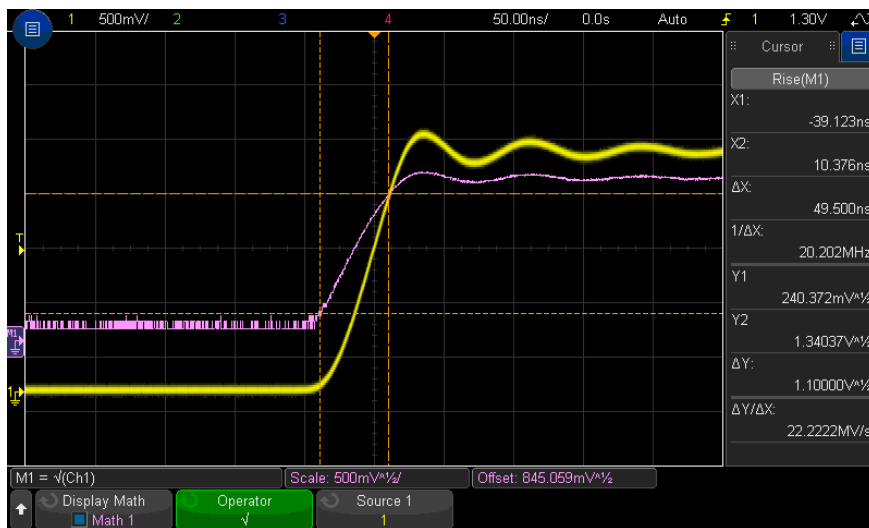


- See Also
- [“Searching for FFT Peaks”](#) on page 93
  - [“FFT Measurement Hints”](#) on page 93
  - [“FFT Units”](#) on page 95
  - [“FFT DC Value”](#) on page 95
  - [“FFT Aliasing”](#) on page 95
  - [“FFT Spectral Leakage”](#) on page 97
  - [“Units for Math Waveforms”](#) on page 101

## Square Root

Square root ( $\sqrt{\quad}$ ) calculates the square root of the selected source.

Where the transform is undefined for a particular input, holes (zero values) appear in the function output.

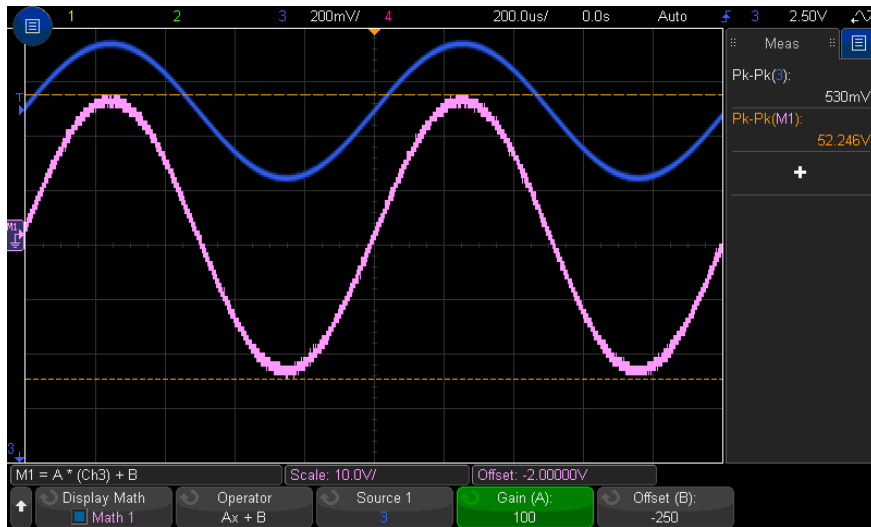


**Figure 11** Example of  $\sqrt{\quad}$  (Square Root)

See Also · [“Units for Math Waveforms”](#) on page 101

$Ax + B$

The  $Ax + B$  function lets you apply a gain and offset to an existing input source.



**Figure 12** Example of  $Ax + B$

Use the **Gain (A)** softkey to specify the gain.

Use the **Offset (B)** softkey to specify the offset.

The  $Ax + B$  function differs from the Magnify math visualization function in that the output is likely different than the input.

See Also · **"Magnify"** on page 121

## Square

The square function calculates the square of the selected source, point by point, and displays the result.

Press the **Source** softkey to select the signal source.

See Also · **"Square Root"** on page 113

## Absolute Value

The absolute value function changes negative values in the input to positive values and displays the resulting waveform.



**Figure 13** Example of Absolute Value

See Also · ["Square"](#) on page 115

## Common Logarithm

The Common Logarithm (log) function performs a transform of the input source. Where the transform is undefined for a particular input, holes (zero values) appear in the function output.

See Also · ["Natural Logarithm"](#) on page 116

## Natural Logarithm

The Natural Logarithm (ln) function performs a transform of the input source. Where the transform is undefined for a particular input, holes (zero values) appear in the function output.



**Figure 14** Example of Natural Logarithm

See Also · ["Common Logarithm"](#) on page 116

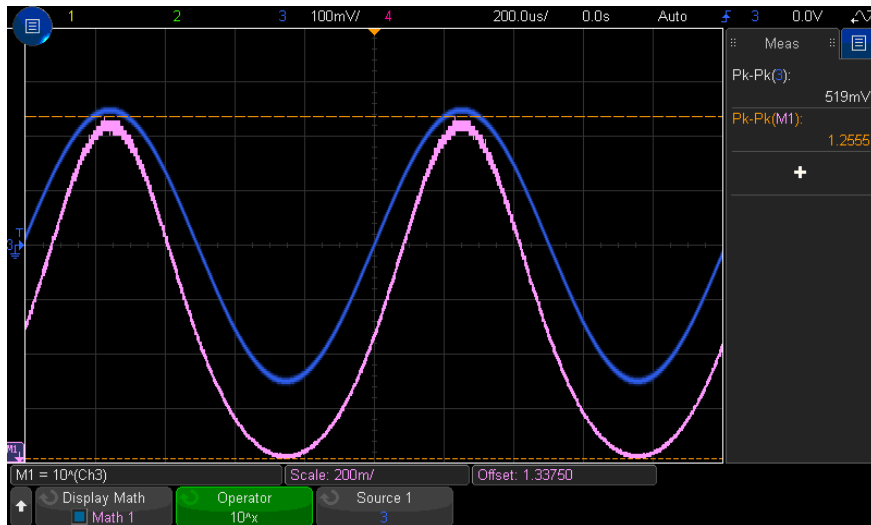
## Exponential

The Exponential ( $e^x$ ) function performs a transform of the input source.

See Also · ["Base 10 Exponential"](#) on page 117

## Base 10 Exponential

The Base 10 Exponential ( $10^x$ ) function performs a transform of the input source.



**Figure 15** Example of Base 10 Exponential

See Also · ["Exponential"](#) on page 117

## Math Filters

You can use math filters to create a waveform that is the result of a the filter on an analog input channel or on the result of an arithmetic operation.

- ["High Pass and Low Pass Filter"](#) on page 118
- ["Averaged Value"](#) on page 119
- ["Smoothing"](#) on page 120
- ["Envelope"](#) on page 120

### High Pass and Low Pass Filter

The high-pass or low-pass filter functions apply the filter to the selected source waveform and display the result in the math waveform.

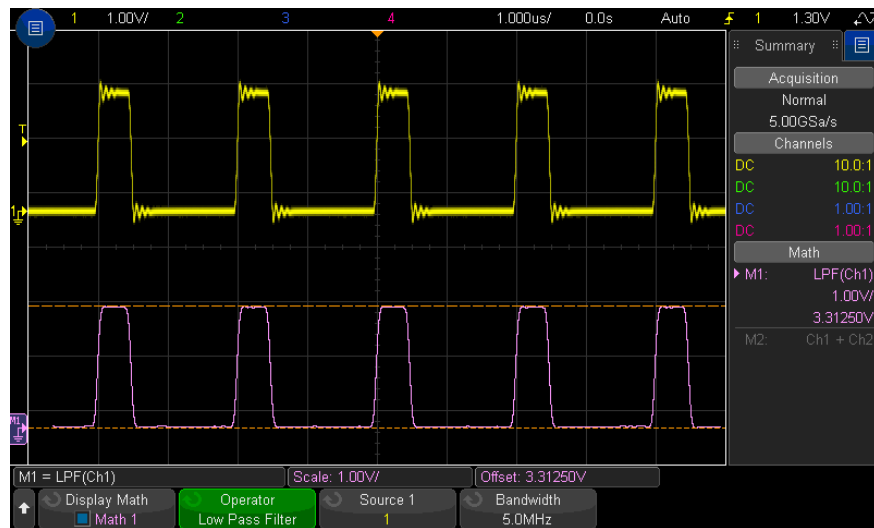
The high-pass filter is a single-pole high-pass filter.

The low-pass filter is a 4th order Bessel-Thompson filter.

Use the **Bandwidth** softkey to select the filter's -3 dB cutoff frequency.

## NOTE

The ratio of the input signal's Nyquist frequency and the selected -3 dB cutoff frequency affects how many points are available in the output, and under some circumstances, there are no points in the output waveform.



**Figure 16** Example of Low Pass Filter

## Averaged Value

When the Averaged Value operator is selected, the math waveform becomes the selected source waveform, averaged the selected number of times.

The source waveform can be one of the analog input channels or one of the previous math function waveforms.

Unlike acquisition averaging, the math averaging operator can be used to average the data on a single analog input channel or math function.

If acquisition averaging is also used, the analog input channel data is averaged and the math function averages it again. You can use both types of averaging to get a certain number of averages on all waveforms and an increased number of averages on a particular waveform.

As with acquisition averaging, averages are calculated using a "decaying average" approximation, where:

$$\text{next\_average} = \text{current\_average} + (\text{new\_data} - \text{current\_average})/N$$

Where N starts at 1 for the first acquisition and increments for each following acquisition until it reaches the selected number of averages, where it holds.

Press the **Reset Count** softkey to clear the number of waveforms evaluated.

**See Also** · **"Averaging Acquisition Mode"** on page 225

## Smoothing

The resulting math waveform is the selected source with a normalized rectangular (boxcar) FIR filter applied.

The boxcar filter is a moving average of adjacent waveform points, where the number of adjacent points is specified by the **Smoothing Points** softkey. You can choose an odd number of points, from 3 up to half of the measurement record or precision analysis record.

The smoothing operator limits the bandwidth of the source waveform. The smoothing operator can be used, for example, to smooth measurement trend waveforms.

## Envelope

The resulting math waveform shows the amplitude envelope for an amplitude modulated (AM) input signal.

This function uses a Hilbert transform to get the real (in-phase, I) and imaginary (quadrature, Q) parts of the input signal and then performs a square root of the sum of the real and imaginary parts to get the demodulated amplitude envelope waveform.



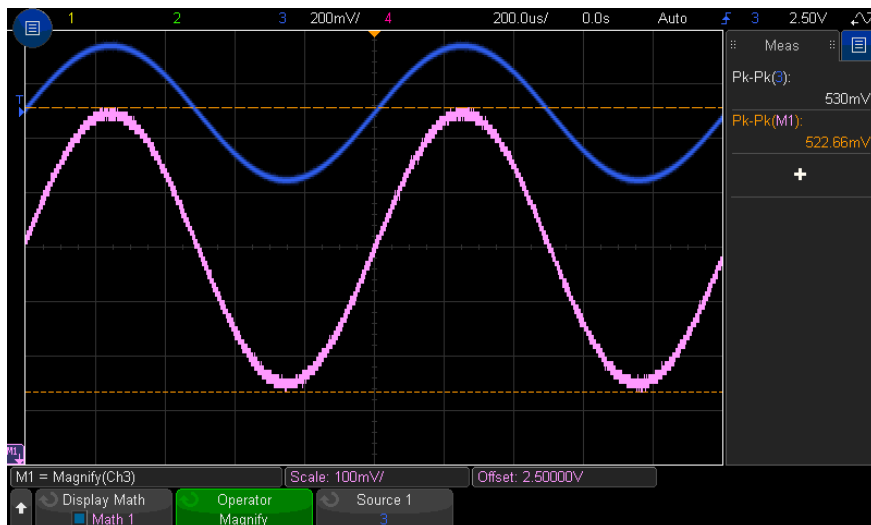
## Math Visualizations

You can apply visualization math functions that give you different ways of viewing captured data and measurement values.

- “Magnify” on page 121
- “Maximum/Minimum” on page 122
- “Peak-Peak” on page 122
- “Max/Min Hold” on page 122
- “Measurement Trend” on page 122
- “Chart Logic Bus Timing” on page 124
- “Chart Logic Bus State” on page 125

### Magnify

The magnify math function lets you display an existing input source at different vertical settings to provide more vertical detail.



**Figure 17** Example of Magnify

**See Also** · **"Ax + B"** on page 114

## Maximum/Minimum

The Maximum operator is like the Max Hold operator without the hold. The maximum vertical values found at each horizontal bucket are used to build a waveform.

The Minimum operator is like the Min Hold operator without the hold. The minimum vertical values found at each horizontal bucket are used to build a waveform.

## Peak-Peak

The Peak-Peak operator is like the Maximum operator minus the Minimum operator. At each horizontal bucket, the minimum vertical values found are subtracted from the maximum vertical values found to build a waveform.

## Max/Min Hold

The Max Hold operator records the maximum vertical values found at each horizontal bucket across multiple analysis cycles and uses those values to build a waveform.

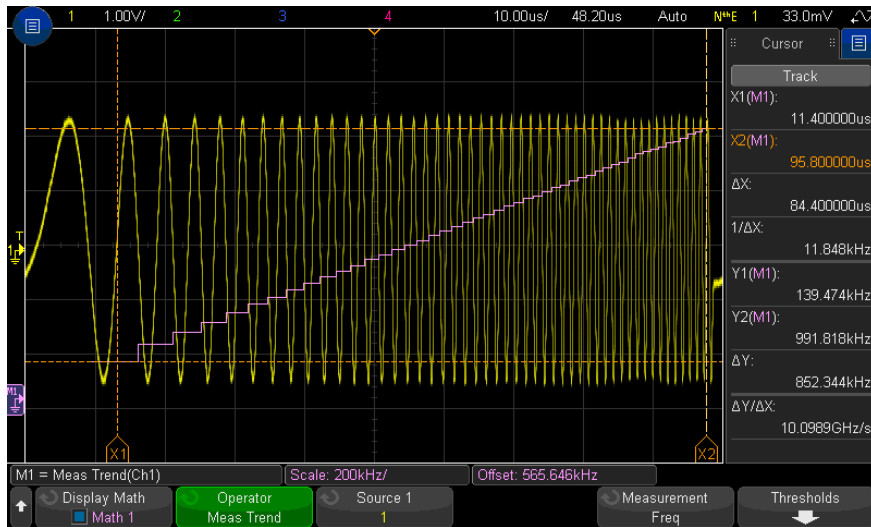
The Min Hold operator is the same, except it records the minimum vertical values.

When not used in a frequency analysis domain, these functions are often referred to as Max Envelope and Min Envelope.

Press the **Reset Count** softkey to clear the number of waveforms evaluated.

## Measurement Trend

The measurement trend math function shows measurement values for a waveform (based on measurement threshold settings) as the waveform progresses across the screen. For every cycle, a measurement is made, and the value is displayed on the screen for the cycle.



**Figure 18** Example of Measurement Trend

Press the **Measurement** softkey to select the previously added measurement whose trend you want to look at. You can display trend values for these measurements:

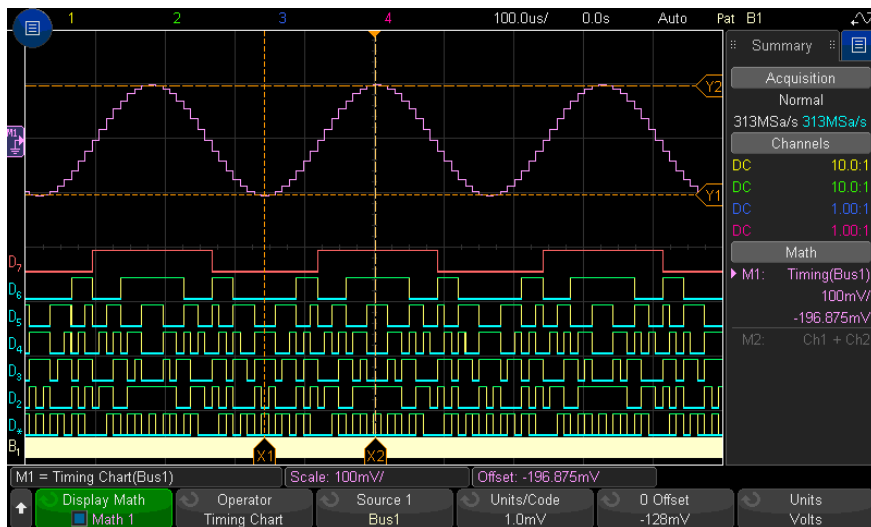
- Average
- RMS - AC
- Ratio
- Period
- Frequency
- +Width
- -Width
- Duty Cycle
- Rise Time
- Fall Time

Use the **Thresholds** softkey to access the Measurement Threshold Menu. See **“Measurement Thresholds”** on page 270.

If a measurement cannot be made for part of a waveform, the trend function output is a hole (that is, no value) until a measurement can be made.

## Chart Logic Bus Timing

The Chart Logic Bus Timing function displays bus data values as an analog waveform (like a D/A conversion). When the bus value is transitioning, the function output is the bus's last stable state.



**Figure 19** Example of Chart Logic Bus Timing

Use the **Units/Code** softkey to specify the analog value equivalent of each increment in the bus data value.

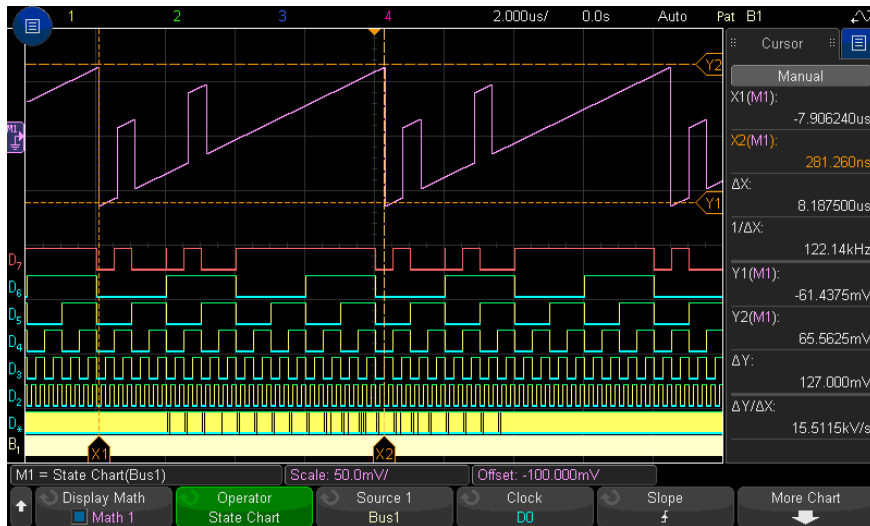
Use the **0 Offset** softkey to specify the analog value equivalent of a bus data value of zero.

Use the **Units** softkey to specify the type of values the bus data represents (volts, amps, etc.).

See Also · ["Chart Logic Bus State"](#) on page 125

## Chart Logic Bus State

The Chart Logic Bus State function displays bus data values, sampled on a clock signal's edge, as an analog waveform (like a D/A conversion).



**Figure 20** Example of Chart Logic Bus State

Use the **Clock** softkey to select the clock signal.

Use the **Slope** softkey to select the edge of the clock signal to be used.

Use the **More Chart** softkey to open a submenu for specifying the analog value equivalent of each bus value increment, the analog equivalent of a zero bus value, and the type of values the charted bus data represents (volts, amps, etc.).



Use the **Units/Code** softkey to specify the analog value equivalent of each increment in the bus data value.

Use the **0 Offset** softkey to specify the analog value equivalent of a bus data value of zero.

Use the **Units** softkey to specify the type of values the bus data represents (volts, amps, etc.).

**See Also** · [“Chart Logic Bus Timing”](#) on page 124

## 6 Reference Waveforms

To save a waveform to a reference waveform location / 127

To display a reference waveform / 128

To scale and position reference waveforms / 129

To adjust reference waveform skew / 129

To display reference waveform information / 130

To save/recall reference waveform files to/from a USB storage device / 130

Analog channel or math waveforms can be saved to one of two reference waveform locations in the oscilloscope. Then, a reference waveform can be displayed and compared against other waveforms. One reference waveform can be displayed at a time.

When the multiplexed knobs are assigned to reference waveforms (this happens when you press the **[Ref]** key and the LED to the left of it is lit), you can use the knobs to scale and position reference waveforms. There is also a skew adjustment for reference waveforms. Reference waveform scale, offset, and skew information can optionally be included on the oscilloscope display.

Analog channel, math, or reference waveforms can be saved to a reference waveform file on a USB storage device. You can recall a reference waveform file from a USB storage device into one of the reference waveform locations.

### To save a waveform to a reference waveform location

- 1 Press the **[Ref]** key to turn on reference waveforms.
- 2 In the Reference Waveform Menu, press the **Display Ref** softkey and turn the Entry knob to select the desired reference waveform location you want to

display. Then, either push the Entry knob or press the **Display Ref** softkey again to display the selected reference waveform location.

- 3 Press the **Source** softkey and turn the Entry knob to select the source waveform.
- 4 Press the **Save to R1/R2** softkey to save the waveform to the reference waveform location.

#### NOTE

Reference waveforms are non-volatile – they remain after power cycling or performing a default setup.

#### To clear a reference waveform location

- 1 Press the **[Ref]** key to turn on reference waveforms.
- 2 In the Reference Waveform Menu, press the **Ref** softkey and turn the Entry knob to select the desired reference waveform location.
- 3 Press the **Clear R1/R2** softkey to clear the reference waveform location.

Reference waveforms are also cleared by a Factory Default or Secure Erase (see [Chapter 20](#), “Save/Email/Recall (Setups, Screens, Data),” starting on page 321).

## To display a reference waveform

- 1 Press the **[Ref]** key to turn on reference waveforms.
- 2 In the Reference Waveform Menu, press the **Ref** softkey and turn the Entry knob to select the desired reference waveform location.
- 3 Then, press the **Ref** softkey again to enable/disable the reference waveform display.





One reference waveform can be displayed at a time.

Reference waveforms are always drawn as vectors (that is, lines between waveform data points) and may look different than waveforms drawn as dots (if that option is available in your oscilloscope).

See Also · ["To display reference waveform information"](#) on page 130

## To scale and position reference waveforms

- 1 Make sure the multiplexed scale and position knobs above and below the **[Ref]** key are selected for the reference waveform.

If the arrow to the left of the **[Ref]** key is not illuminated, press the key.

- 2 Turn the upper multiplexed knob to adjust the reference waveform scale.
- 3 Turn the lower multiplexed knob to adjust the reference waveform position.

## To adjust reference waveform skew

Once reference waveforms are displayed, you can adjust their skew.

- 1 Display the desired reference waveform (see **"To display a reference waveform"** on page 128).
- 2 Press the **Skew** softkey and turn the Entry knob to adjust the reference waveform skew.

## To display reference waveform information

- 1 Press the **[Ref]** key to turn on reference waveforms.
- 2 In the Reference Waveform Menu, press the **Options** softkey.
- 3 In the Reference Waveform Options Menu, press the **Display Info** softkey to enable or disable reference waveform information on the oscilloscope display.

## To save/recall reference waveform files to/from a USB storage device

Analog channel, math, or reference waveforms can be saved to a reference waveform file on a USB storage device. See **"To save reference waveform files to a USB storage device"** on page 327.

You can recall a reference waveform file from a USB storage device into one of the reference waveform locations. See **"To recall reference waveform files from a USB storage device"** on page 332.

# 7 Digital Channels

- To connect the digital probes to the device under test / 131
- Acquiring waveforms using the digital channels / 135
- To display digital channels using Autoscale / 135
- Interpreting the digital waveform display / 136
- To switch all digital channels on or off / 138
- To switch groups of channels on or off / 138
- To switch a single channel on or off / 138
- To change the displayed size of the digital channels / 137
- To reposition a digital channel / 139
- To change the logic threshold for digital channels / 138
- To display digital channels as a bus / 140
- Digital channel signal fidelity: Probe impedance and grounding / 143

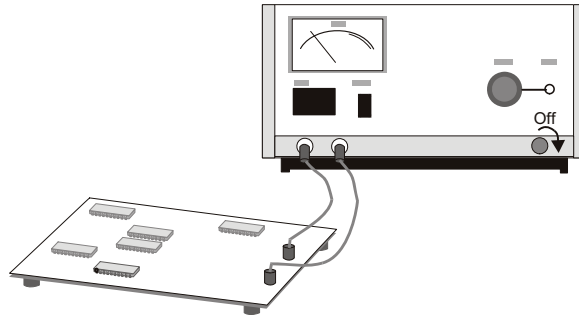
This chapter describes how to use the digital channels of a Mixed-Signal Oscilloscope (MSO).

The digital channels are enabled on MSOX3000T X-Series models and DSOX3000T X-Series models that have the MSO upgrade license installed.

## To connect the digital probes to the device under test

- 1** If necessary, turn off the power supply to the device under test.

Turning off power to the device under test would only prevent damage that might occur if you accidentally short two lines together while connecting probes. You can leave the oscilloscope powered on because no voltage appears at the probes.



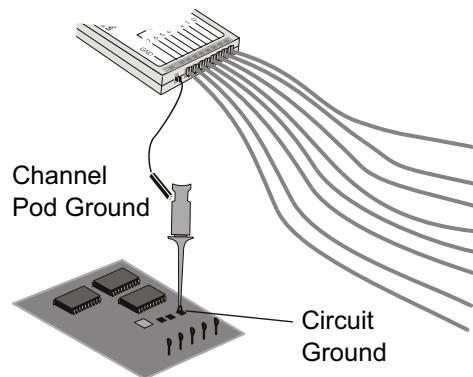
- 2 Connect the digital probe cable to the DIGITAL Dn - D0 connector on the mixed-signal oscilloscope. The digital probe cable is keyed so you can connect it only one way. You do not need to power-off the oscilloscope.

**CAUTION**

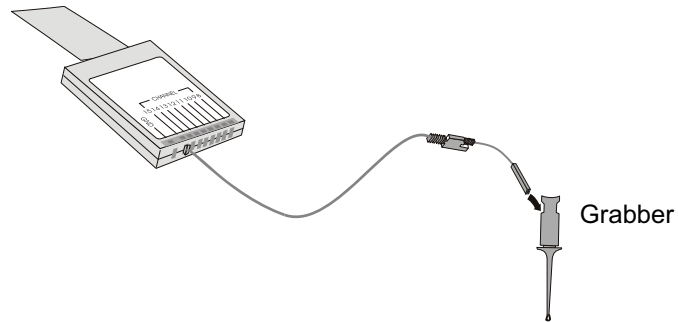
**⚠ Probe cable for digital channels**

Use only the Keysight logic probe and accessory kit supplied with the mixed-signal oscilloscope (see **"Probes and Accessories"** on page 378).

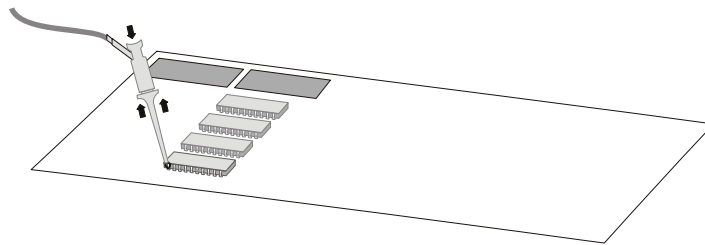
- 3 Connect the ground lead on each set of channels (each pod), using a probe grabber. The ground lead improves signal fidelity to the oscilloscope, ensuring accurate measurements.



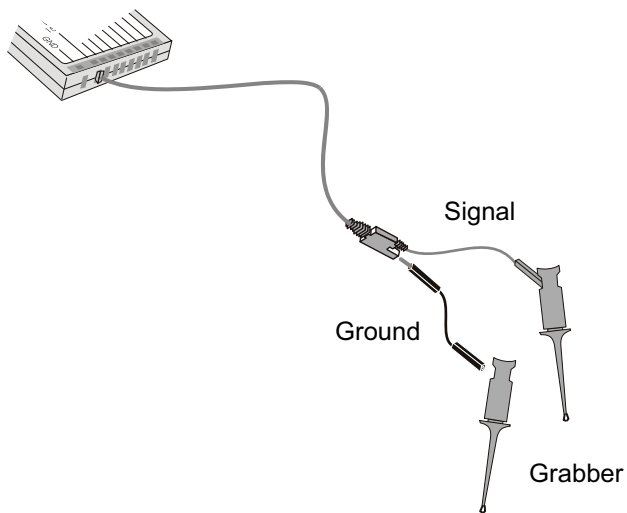
- 4 Connect a grabber to one of the probe leads. (Other probe leads are omitted from the figure for clarity.)



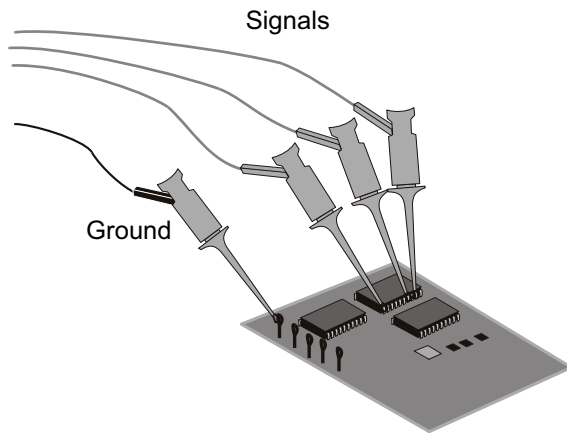
- 5 Connect the grabber to a node in the circuit you want to test.



- 6 For high-speed signals, connect a ground lead to the probe lead, connect a grabber to the ground lead, and attach the grabber to ground in the device under test.



7 Repeat these steps until you have connected all points of interest.



## Acquiring waveforms using the digital channels

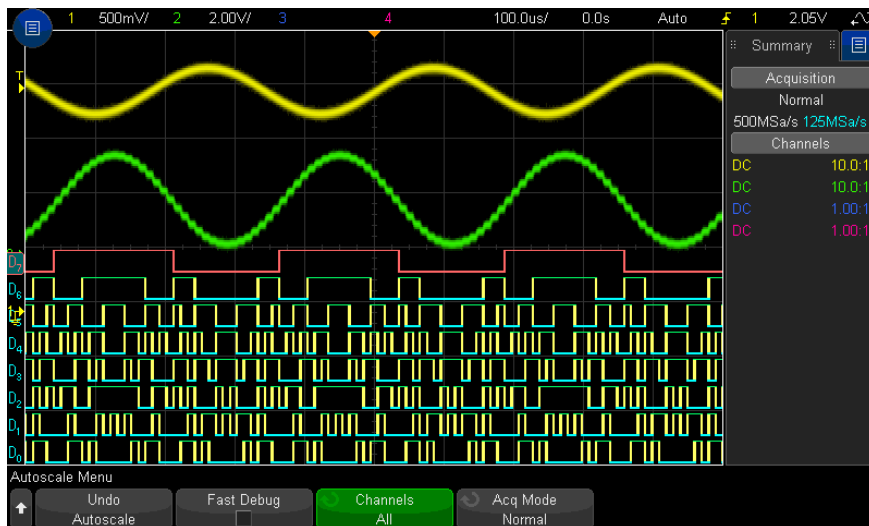
When you press **[Run/Stop]** or **[Single]** to run the oscilloscope, the oscilloscope examines the input voltage at each input probe. When the trigger conditions are met the oscilloscope triggers and displays the acquisition.

For digital channels, each time the oscilloscope takes a sample it compares the input voltage to the logic threshold. If the voltage is above the threshold, the oscilloscope stores a 1 in sample memory; otherwise, it stores a 0.

## To display digital channels using Autoscale

When signals are connected to the digital channels – be sure to connect the ground leads – Autoscale quickly configures and displays the digital channels.

- To configure the instrument quickly, press the **[Auto Scale]** key.



**Figure 21** Example: Autoscale of digital channels (MSO models only)

Any digital channel with an active signal will be displayed. Any digital channels without active signals will be turned off.

- To undo the effects of Autoscale, press the **Undo Autoscale** softkey before pressing any other key.

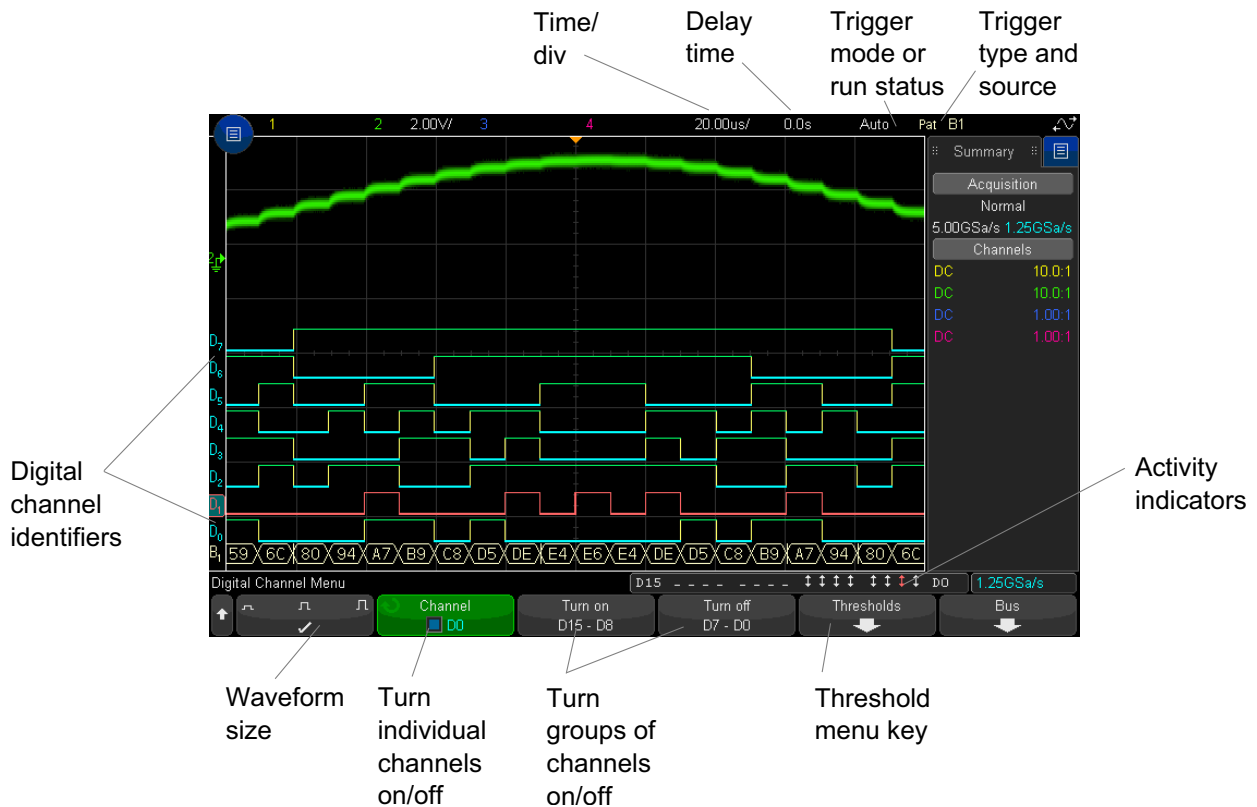
This is useful if you have unintentionally pressed the **[Auto Scale]** key or do not like the settings Autoscale has selected. This will return the oscilloscope to its previous settings. See also: **"How Autoscale Works"** on page 35.

To set the instrument to the factory-default configuration, press the **[Default Setup]** key.

## Interpreting the digital waveform display

The following figure shows a typical display with digital channels.





**Activity indicator** When any digital channels are turned on, an activity indicator is displayed in the status line at the bottom of the display. A digital channel can be always high (■), always low (■), or actively toggling logic states (⬆).

To change the displayed size of the digital channels

- 1 Press the **[Digital]** key.
- 2 Press the size (■ ■ ■) softkey to select how the digital channels are displayed.

The sizing control lets you spread out or compress the digital traces vertically on the display for more convenient viewing.

## To switch a single channel on or off

- 1 With the Digital Channel Menu displayed, rotate the Entry knob to select the desired channel from the popup menu.
- 2 Push the Entry knob or press the softkey that is directly below the popup menu to switch the selected channel on or off.

## To switch all digital channels on or off

- 1 Press the **[Digital]** key to toggle the display of digital channels. The Digital Channel Menu is displayed above the softkeys.

If you want to switch the digital channels off, and the Digital Channel Menu is not already displayed, you must push the **[Digital]** key twice to switch the digital channels off. The first push displays the Digital Channel Menu, and the second push switches the channels off.

## To switch groups of channels on or off

- 1 Press the **[Digital]** key on the front panel if the Digital Channel Menu is not already displayed.
- 2 Press the **Turn off** (or **Turn on**) softkey for the **D15 - D8** group or the **D7 - D0** group. Each time you press the softkey, the softkey's mode toggles between **Turn on** and **Turn off**.

## To change the logic threshold for digital channels

- 1 Press the **[Digital]** key so that the Digital Channel Menu is displayed.
- 2 Press the **Thresholds** softkey

- 3 Press the **D15 - D8** or **D7 - D0** softkey, then select a logic family preset or select **User** to define your own threshold.

Logic family	Threshold Voltage
TTL	+1.4 V
CMOS	+2.5 V
ECL	-1.3 V
User	Variable from -8 V to +8 V

The threshold you set applies to all channels within the selected D15 - D8 or D7 - D0 group. Each of the two channel groups can be set to a different threshold if desired.

Values greater than the set threshold are high (1) and values less than the set threshold are low (0).

If the **Thresholds** softkey is set to **User**, press the **User** softkey for the channel group, then turn the Entry knob to set the logic threshold. There is one **User** softkey for each group of channels.

## To reposition a digital channel

- 1 Make sure the multiplexed scale and position knobs above and below the key are selected for digital channels.

If the arrow to the left of the **[Digital]** key is not illuminated, press the key.

- 2 Use the multiplexed Select knob to select the channel.

The selected waveform is highlighted in red.

- 3 Use the multiplexed Position knob to move the selected channel waveform.

If a channel waveform is repositioned over another channel waveform, the indicator at the left edge of the trace will change from **Dnn** designation (where nn is a one or two digit channel number) to **D\***. The "\*" indicates that multiple channels are overlaid.

## To display digital channels as a bus

Digital channels may be grouped and displayed as a bus, with each bus value displayed at the bottom of the display in hex or binary. You can create up to two buses. To configure and display each bus, press the **[Digital]** key on the front panel. Then press the **Bus** softkey.



Next, select a bus. Rotate the Entry knob, then press the Entry knob or the **Bus1/Bus2** softkey to switch it on.

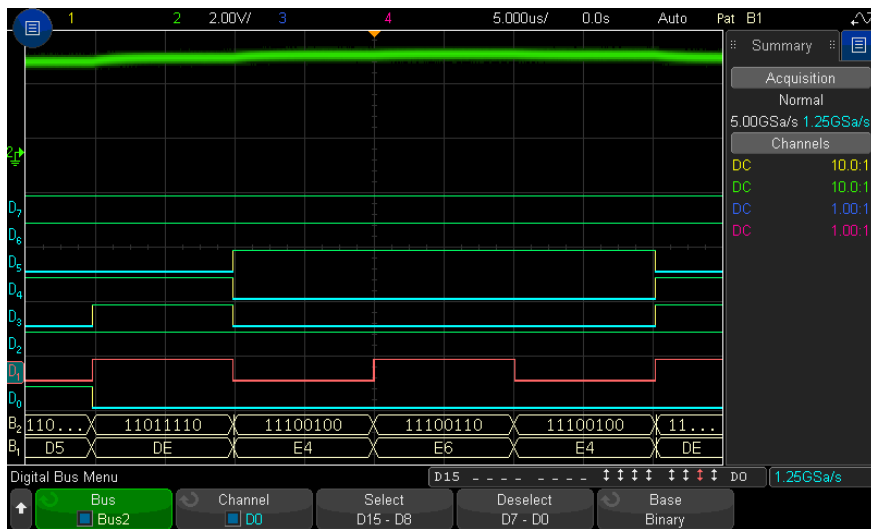
Use the **Channel** softkey and the Entry knob to select individual channels to be included in the bus. You can rotate the Entry knob and push it or push the softkey to select channels. You can also press the **Select/Deselect D15-D8** and **Select/Deselect D7-D0** softkeys to include or exclude groups of eight channels in each bus.



If the bus display is blank, completely white, or if the display includes "...", you need to expand the horizontal scale to allow space for the data to be shown, or use the cursors to display the values (see **"Using cursors to read bus values"** on page 141).

The **Base** softkey lets you choose to display the bus values in hex or binary.

The buses are shown at the bottom of the display.

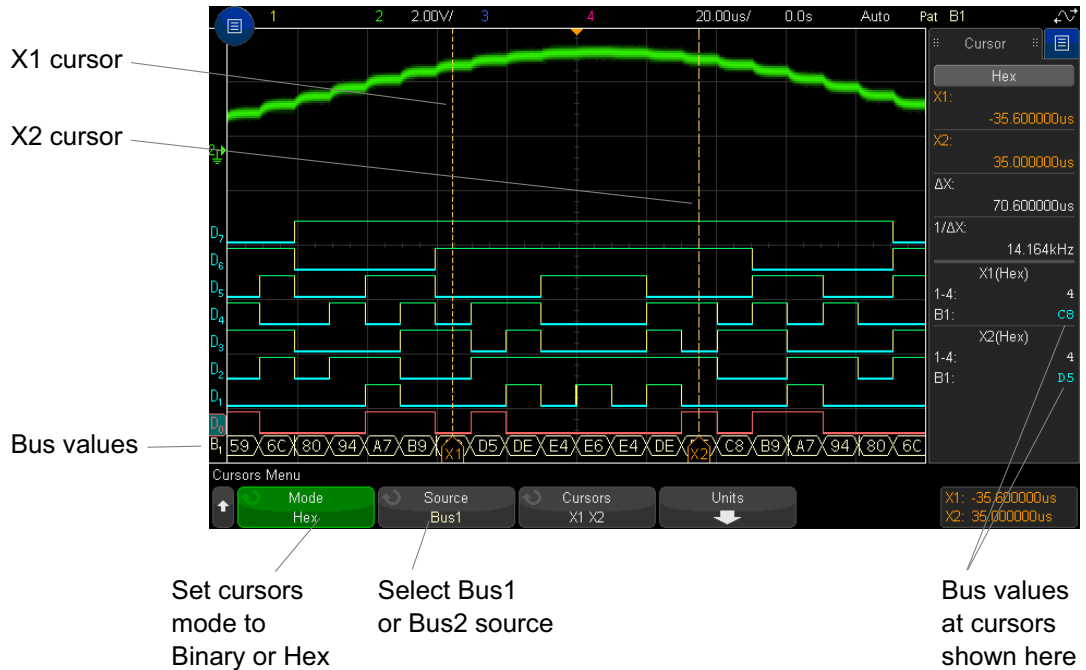


Bus values can be shown in hex or binary.

#### Using cursors to read bus values

To read the digital bus value at any point using the cursors:

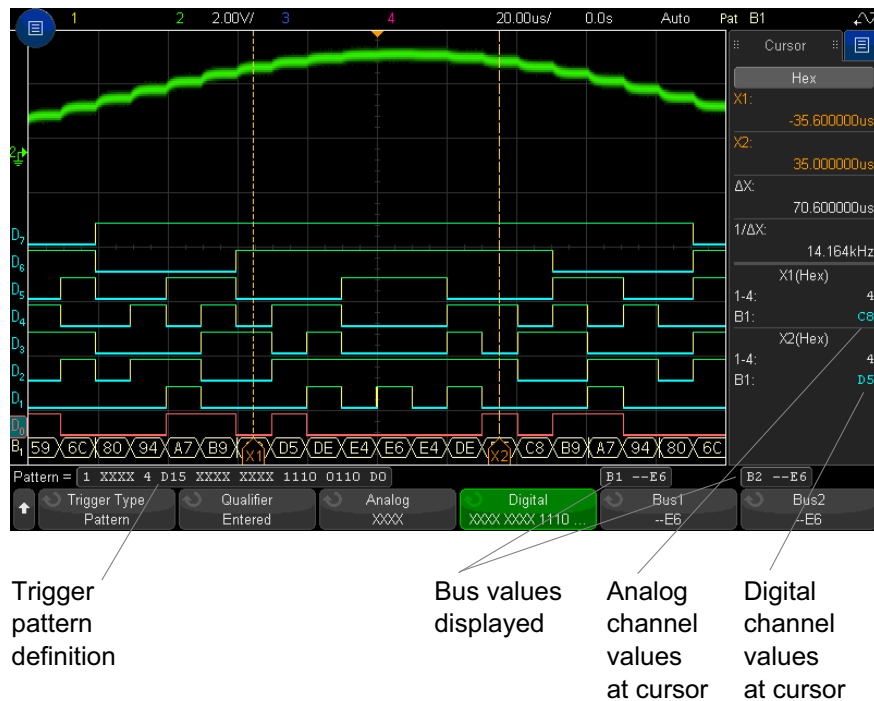
- 1 Turn on Cursors (by pressing the **[Cursors]** key on the front panel)
- 2 Press the cursor **Mode** softkey and change the mode to **Hex** or **Binary**.
- 3 Press the **Source** softkey and select **Bus1** or **Bus2**.
- 4 Use the Entry knob and the **X1** and **X2** softkeys to position the cursors where you want to read the bus values.



**Bus values are displayed when using Pattern trigger**

The bus values are also displayed when using the Pattern trigger function. Press the **[Pattern]** key on the front panel to display the Pattern Trigger Menu and the bus values will be displayed on the right, above the softkeys.

The dollar sign (\$) will be displayed in the bus value when the bus value cannot be displayed as a hex value. This occurs when one or more "don't cares" (X) are combined with low (0) and high (1) logic levels in the pattern specification, or when a transition indicator – rising edge (⤴) or falling edge (⤵) – are included in the pattern specification. A byte that consists of all don't cares (X) will be displayed in the bus as a don't care (X).



See **“Pattern Trigger”** on page 178 for more information on Pattern triggering.

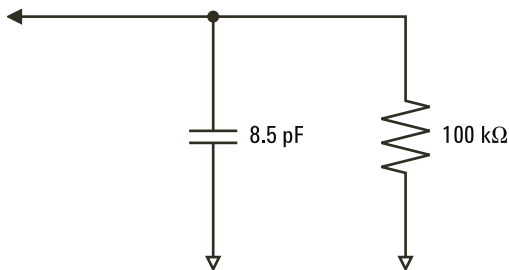
## Digital channel signal fidelity: Probe impedance and grounding

When using the mixed-signal oscilloscope you may encounter problems that are related to probing. These problems fall into two categories: probe loading and probe grounding. Probe loading problems generally affect the device under test, while probe grounding problems affect the accuracy of the data to the measurement instrument. The design of the probes minimizes the first problem, while the second is easily addressed by good probing practices.

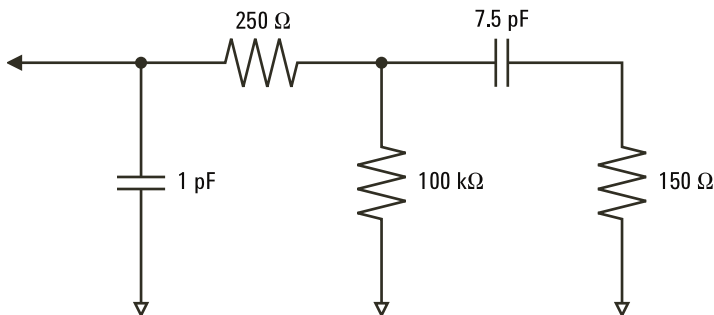
### Input Impedance

The logic probes are passive probes, which offer high input impedance and high bandwidths. They usually provide some attenuation of the signal to the oscilloscope, typically 20 dB.

Passive probe input impedance is generally specified in terms of a parallel capacitance and resistance. The resistance is the sum of the tip resistor value and the input resistance of the test instrument (see the following figure). The capacitance is the series combination of the tip compensating capacitor and the cable, plus instrument capacitance in parallel with the stray tip capacitance to ground. While this results in an input impedance specification that is an accurate model for DC and low frequencies, the high-frequency model of the probe input is more useful (see the following figure). This high-frequency model takes into account pure tip capacitance to ground as well as series tip resistance, and the cable's characteristic impedance ( $Z_0$ ).



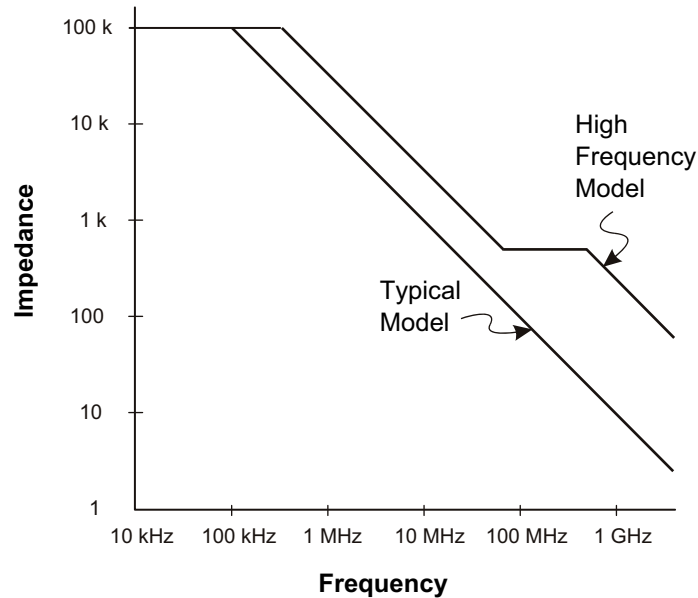
**Figure 22** DC and Low-Frequency Probe Equivalent Circuit



**Figure 23** High-Frequency Probe Equivalent Circuit



The impedance plots for the two models are shown in these figures. By comparing the two plots, you can see that both the series tip resistor and the cable's characteristic impedance extend the input impedance significantly. The stray tip capacitance, which is generally small (1 pF), sets the final break point on the impedance chart.



**Figure 24** Impedance versus Frequency for Both Probe Circuit Models

The logic probes are represented by the high-frequency circuit model shown above. They are designed to provide as much series tip resistance as possible. Stray tip capacitance to ground is minimized by the proper mechanical design of the probe tip assembly. This provides the maximum input impedance at high frequencies.

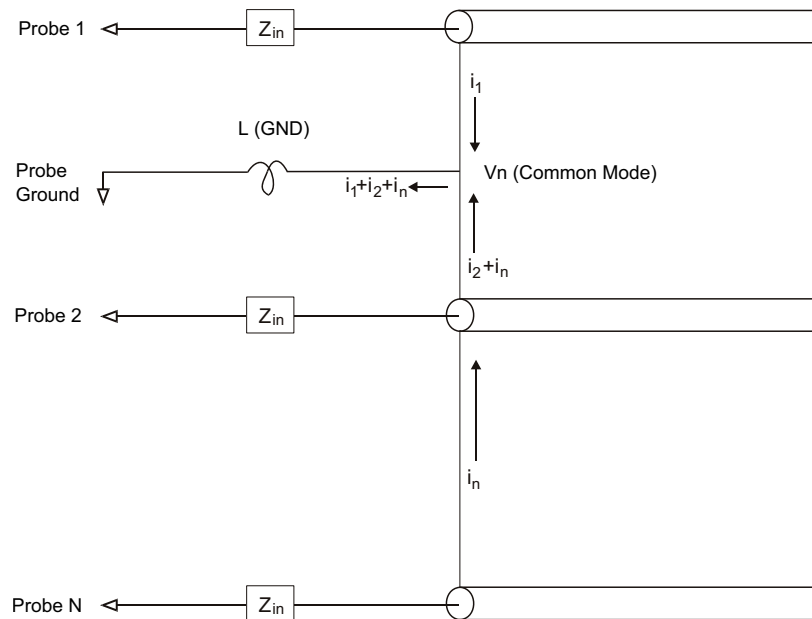
## Probe Grounding

A probe ground is the low-impedance path for current to return to the source from the probe. Increased length in this path will, at high frequencies, create large common mode voltages at the probe input. The voltage generated behaves as if this path were an inductor according to the equation:

$$V = L \frac{di}{dt}$$

Increasing the ground inductance (L), increasing the current (di) or decreasing the transition time (dt), will all result in increasing the voltage (V). When this voltage exceeds the threshold voltage defined in the oscilloscope, a false data measurement will occur.

Sharing one probe ground with many probes forces all the current that flows into each probe to return through the same common ground inductance of the probe whose ground return is used. The result is increased current (di) in the above equation, and, depending on the transition time (dt), the common mode voltage may increase to a level that causes false data generation.



**Figure 25** Common Mode Input Voltage Model

In addition to the common mode voltage, longer ground returns also degrade the pulse fidelity of the probe system. Rise time is increased, and ringing, due to the undamped LC circuit at the input of the probe, is also increased. Because the digital channels display reconstructed waveforms, they do not show ringing and perturbations. You will not find ground problems through examination of the waveform display. In fact, it is likely you will discover the problem through random glitches or inconsistent data measurements. Use the analog channels to view ringing and perturbations.

## Best Probing Practices

Because of the variables  $L$ ,  $d_i$ , and  $dt$ , you may be unsure how much margin is available in your measurement setup. The following are guidelines for good probing practices:

- The ground lead from each digital channel group (D15–D8 and D7–D0) should be attached to the ground of the device under test if any channel within the group is being used for data capture.
- When capturing data in a noisy environment, every third digital channel probe's ground should be used in addition to the channel group's ground.
- High-speed timing measurements (rise time  $< 3$  ns) should make use of each digital channel probe's own ground.

When designing a high-speed digital system, you should consider designing dedicated test ports that interface directly to the instrument's probe system. This will ease measurement setup and ensure a repeatable method for obtaining test data. The 01650-61607 16-channel logic probe cable and the 01650-63203 termination adapter are designed to make it easy to connect to industry-standard, 20-pin board connectors. The cable is a 2 m logic analyzer probe cable, and the termination adapter provides the proper RC networks in a very convenient package. These parts, as well as the 1251-8106 20-pin, low-profile, straight board connector, can be ordered from Keysight Technologies.



# 8 Serial Decode

Serial Decode Options / 149

Lister / 151

Searching Lister Data / 152

## Triggering on Serial Data

In some cases, such as when triggering on a slow serial signal (for example, I2C, SPI, CAN, LIN, etc.) it may be necessary to switch from the Auto trigger mode to the Normal trigger mode to prevent the oscilloscope from Auto-triggering and stabilize the display. You can select the trigger mode by pressing the **[Mode/Coupling]** key, then the **Mode** softkey.

Also, the threshold voltage level must be set appropriately for each source channel. The threshold level for each serial signal can be set in the Signals Menu. Press the **[Serial]** key, then the **Signals** softkey.

## Serial Decode Options

Keysight's hardware-accelerated serial decode options can be installed when the oscilloscope is manufactured, or added later. The following serial decode licenses are available:

Serial Decode License	See:
DSOXT3AUTO – you can decode CAN (Controller Area Network) and LIN (Local Interconnect Network) serial buses.	<ul style="list-style-type: none"><li>▪ <b>“CAN/CAN FD Serial Decode”</b> on page 402.</li><li>▪ <b>“LIN Serial Decode”</b> on page 411.</li></ul>

Serial Decode License	See:
DSOXT3CXPI – you can decode CXPI (Clock Extension Peripheral Interface) serial buses.	<ul style="list-style-type: none"> <li>▪ <a href="#">“CXPI Serial Decode”</a> on page 421.</li> </ul>
DSOX3FLEX – you can decode FlexRay serial buses.	<ul style="list-style-type: none"> <li>▪ <a href="#">“FlexRay Serial Decode”</a> on page 431.</li> </ul>
DSOX3EMBD – you can decode I2C (Inter-IC) and SPI (Serial Peripheral Interface) serial buses.	<ul style="list-style-type: none"> <li>▪ <a href="#">“I2C Serial Decode”</a> on page 442.</li> <li>▪ <a href="#">“SPI Serial Decode”</a> on page 451.</li> </ul>
DSOX3AUDIO – you can decode I2S (Inter-IC Sound or Integrated Interchip Sound) serial buses.	<ul style="list-style-type: none"> <li>▪ <a href="#">“I2S Serial Decode”</a> on page 461.</li> </ul>
DSOX3COMP – you can decode many UART (Universal Asynchronous Receiver/Transmitter) protocols including RS232 (Recommended Standard 232).	<ul style="list-style-type: none"> <li>▪ <a href="#">“UART/RS232 Serial Decode”</a> on page 515.</li> </ul>
DSOXT3NRZ – you can decode Manchester and NRZ serial buses.	<ul style="list-style-type: none"> <li>▪ <a href="#">“Manchester Serial Decode”</a> on page 470.</li> <li>▪ <a href="#">“NRZ Serial Decode”</a> on page 477.</li> </ul>
DSOX3AERO – you can decode MIL-STD-1553 and ARINC 429 serial buses.	<ul style="list-style-type: none"> <li>▪ <a href="#">“MIL-STD-1553 Serial Decode”</a> on page 484.</li> <li>▪ <a href="#">“ARINC 429 Serial Decode”</a> on page 491.</li> </ul>
DSOX3SENSOR – you can decode SENT (Single Edge Nibble Transmission) serial buses.	<ul style="list-style-type: none"> <li>▪ <a href="#">“SENT Serial Decode”</a> on page 504.</li> </ul>

To determine whether these licenses are installed on your oscilloscope, see [“To display oscilloscope information”](#) on page 356.

To order serial decode licenses, go to [www.keysight.com](http://www.keysight.com) and search for the product number (for example, DSOXT3AUTO) or contact your local Keysight Technologies representative (see [www.keysight.com/find/contactus](http://www.keysight.com/find/contactus)).

## Lister

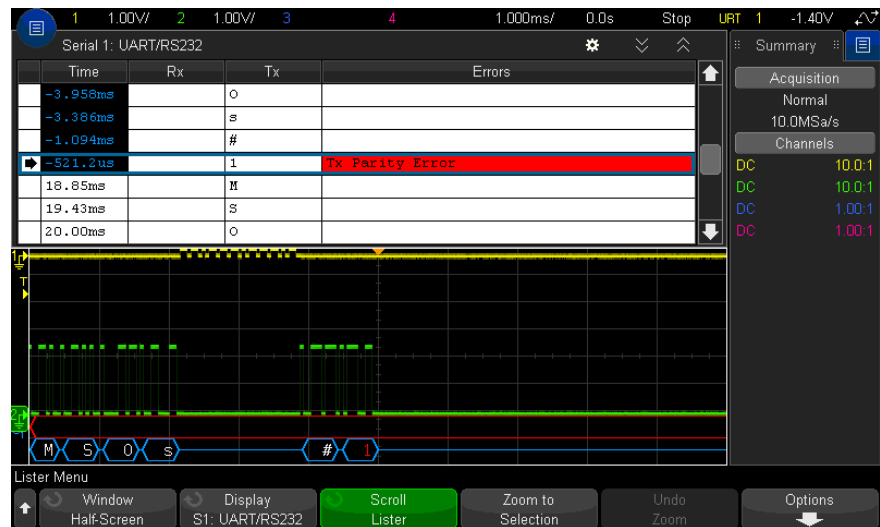
Lister is a powerful tool for investigating protocol failures. You can use Lister to view large amounts of packet level serial data in a tabular format, including time tags and specific decoded values. After pressing the **[Single]** key, you can press the **Scroll Lister** softkey and then rotate the Entry knob to select an event and press the **Zoom to Selection** softkey to jump to the event.

To use the Lister:

- 1 Set up trigger and decode on the serial data signals to be analyzed.
- 2 Press **[Serial]** > **Lister**.
- 3 Press **Window**; then, turn the Entry knob to select the size of the Lister window (**Half-Screen** or **Full-Screen**).

When the touchscreen is enabled, you can touch the Lister down or up chevrons at the top right of the graticule to select the size of the Lister window.

- 4 Press **Display**; then, turn the Entry knob to select the serial slot (**Serial 1** or **Serial 2**) on which the serial bus signals are being decoded. (If you select **All**, the decode information for different buses is interleaved in time.)



Before you can select a row or navigate through the Lister data, oscilloscope acquisitions must be stopped.

- 5 Press the **[Single]** key (in the Run Control group on the front panel) to stop the acquisition.

Pressing **[Single]** instead of **[Stop]** fills the maximum memory depth.

When zoomed out and viewing a large number of packets, the Lister may not be able to display information for all packets. However, when you press the **[Single]** key the Lister will contain all on-screen serial decode information.

- 6 Press the **Scroll Lister** softkey and use the Entry knob to scroll through the data.

Time tags in the Time column indicate the event time relative to the trigger point by default, and can optionally be configured to be relative to the previous row, as described in step 9 that follows. The time tags of events that are shown in the waveform display area are displayed with a dark background.

- 7 Press the **Zoom to Selection** softkey (or push the Entry knob) to center the waveform display at the time associated with the selected Lister row and automatically set the horizontal scale setting.
- 8 Press the **Undo Zoom** softkey to return to the horizontal scale and delay settings before the last **Zoom to Selection**.
- 9 Press the **Options** softkey to open the Lister Options Menu. In this menu, you can:
  - Enable or disable the **Track Time** option. When enabled, as you select different Lister rows (using the Entry knob while acquisitions are stopped), the horizontal delay changes to the Time of the selected row. Also, changing the horizontal delay will scroll the Lister.
  - Press the **Scroll Lister** softkey and use the Entry knob to scroll though data rows in the Lister display.
  - Press the **Time Ref** softkey and use the Entry knob to select whether the Time column in the Lister display shows times relative to the trigger or relative to the previous packet row.

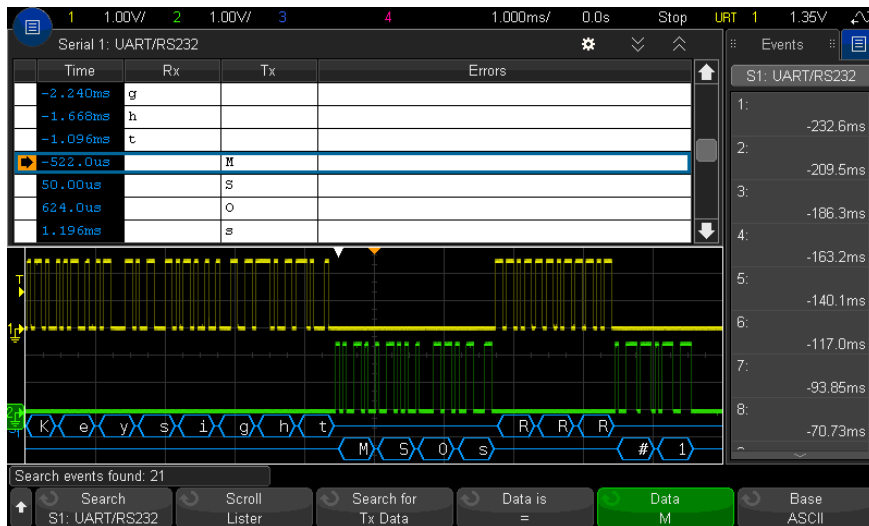
## Searching Lister Data

When serial decode is enabled, you can use the **[Search]** key to find and place marks on rows in the Lister.



The **Search** softkey lets you specify events to find. It is similar to specifying protocol triggers.

Events found are marked in orange in the far left Lister column. The total number of events found is displayed above the softkeys.



Each serial decode option lets you find protocol-specific headers, data, errors, etc. See:

- [“Searching for ARINC 429 Data in the Lister”](#) on page 495
- [“Searching for CAN Data in the Lister”](#) on page 406
- [“Searching for FlexRay Data in the Lister”](#) on page 434
- [“Searching for I2C Data in the Lister”](#) on page 444
- [“Searching for I2S Data in the Lister”](#) on page 463
- [“Searching for LIN Data in the Lister”](#) on page 414
- [“Searching for MIL-STD-1553 Data in the Lister”](#) on page 487
- [“Searching for SENT Data in the Lister”](#) on page 508
- [“Searching for SPI Data in the Lister”](#) on page 453
- [“Searching for UART/RS232 Data in the Lister”](#) on page 518



## 9 Display Settings

To adjust waveform intensity / 155

To set or clear persistence / 157

To clear the display / 158

To select the grid type / 158

To adjust the grid intensity / 159

To freeze the display / 159

### To adjust waveform intensity

You can adjust the intensity of displayed waveforms to account for various signal characteristics, such as fast time/div settings and low trigger rates.

Increasing the intensity lets you see the maximum amount of noise and infrequently occurring events.

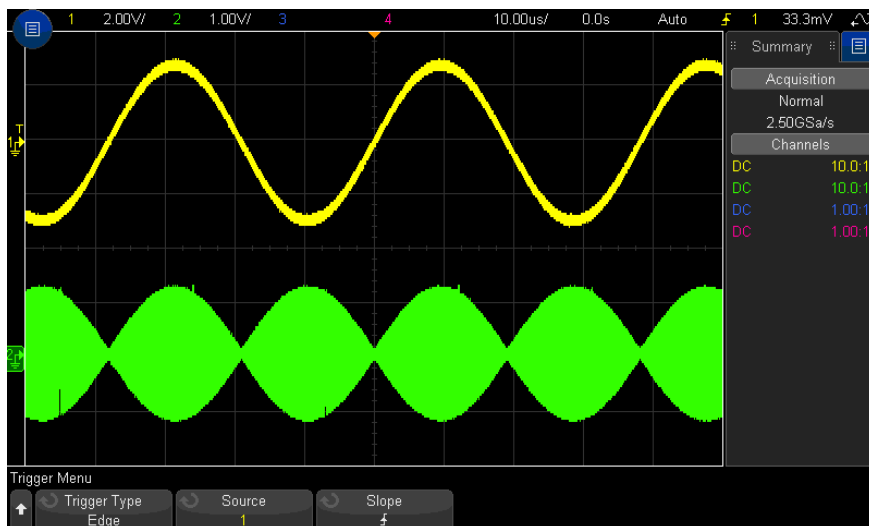
Reducing the intensity can expose more detail in complex signals as shown in the following figures.

**1** Press the **[Intensity]** key to illuminate it.

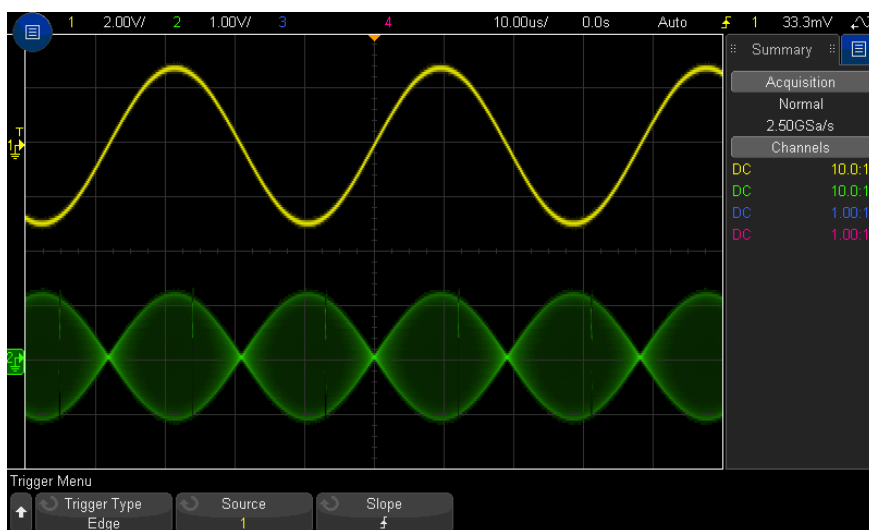
This key is located just below the Entry knob.

**2** Turn the Entry knob to adjust the waveform intensity.

Waveform intensity adjustment affects analog channel waveforms only (not math waveforms, reference waveforms, digital waveforms, etc.).



**Figure 26** Amplitude Modulation Shown at 100% Intensity



**Figure 27** Amplitude Modulation Shown at 40% Intensity

## To set or clear persistence

With persistence, the oscilloscope updates the display with new acquisitions, but does not immediately erase the results of previous acquisitions. All previous acquisitions are displayed with reduced intensity. New acquisitions are shown in their normal color with normal intensity.

Waveform persistence is kept only for the current display area; you cannot pan and zoom the persistence display.

To use persistence:

- 1 Press the **[Display]** key.



- 2 Press **Persistence**; then, turn the Entry knob to select between:

- **Off** – turns off persistence.

When persistence is off, you can press the **Capture Waveforms** softkey to perform a single-shot infinite persistence. A single acquisition's data is displayed with reduced intensity, and it remains on the display until you clear persistence or clear the display.

- **∞ Persistence** – (infinite persistence) Results of previous acquisitions are never erased.

Use infinite persistence to measure noise and jitter, to see the worst-case extremes of varying waveforms, to look for timing violations, or to capture events that occur infrequently.

- **Variable Persistence** – Results of previous acquisitions are erased after a certain amount of time.

Variable persistence gives you a view of acquired data that is similar to analog oscilloscopes.

When variable persistence is selected, press the **Time** softkey and use the Entry knob to specify the amount of time that previous acquisitions are to be displayed.

The display will begin accumulating multiple acquisitions.

- 3 To erase the results of previous acquisitions from the display, press the **Clear Persistence** softkey.

The oscilloscope will start to accumulate acquisitions again.

- 4 To return the oscilloscope to the normal display mode, turn off persistence; then, press the **Clear Persistence** softkey.

Turning off persistence does not clear the display. The display is cleared if you press the **Clear Display** softkey or if you press the **[Auto Scale]** key (which also turns off persistence).

For another method of seeing worst-case extremes of varying waveforms, see **"Glitch or Narrow Pulse Capture"** on page 223.

## To clear the display

- 1 Press **[Clear Display]** (or press **[Display] > Clear Display**).

You can also configure the **[Quick Action]** key to clear the display. See **"Configuring the [Quick Action] Key"** on page 357.


## To select the grid type

When the **Video** trigger type is selected (see **"Video Trigger"** on page 191), and the vertical scaling of at least one displayed channel is 140 mV/div, the **Grid** softkey lets you select from these grid types:

- **Full** – the normal oscilloscope grid.
- **mV** – shows vertical grids, labeled on the left, from -0.3 V to 0.8 V.
- **IRE** – (Institute of Radio Engineers) shows vertical grids in IRE units, labeled on the left, from -40 to 100 IRE. The 0.35 V and 0.7 V levels from the **mV** grid are also shown and labeled at the right. When the **IRE** grid is selected, cursor values are also shown in IRE units. (Cursor values via the remote interface are not in IRE units.)


The **mV** and **IRE** grid values are accurate (and match Y cursor values) when the vertical scaling is 140 mV/division and the vertical offset is 245 mV.

To select the grid type:

- 1 Press **[Display]** (or **[Display] > More** on 1 GHz and 1.5 GHz bandwidth models).
- 2 Press the **Grid** softkey; then, turn the Entry knob  to select the grid type.

## To adjust the grid intensity

To adjust the display grid (graticule) intensity:

- 1 Press **[Display]**.
- 2 Press the **Intensity** softkey; then, turn the Entry knob  to change the intensity of the displayed grid.

The intensity level is shown in the **Intensity** softkey and is adjustable from 0 to 100%.

Each major vertical division in the grid corresponds to the vertical sensitivity shown in the status line at the top of the display.

Each major horizontal division in the grid corresponds to the time/div shown in the status line at the top of the display.

## To freeze the display

To freeze the display without stopping running acquisitions, you must configure the **[Quick Action]** key. See **“Configuring the [Quick Action] Key”** on page 357.

- 1 Once the **[Quick Action]** key has been configured, press it to freeze the display.
- 2 To un-freeze the display, press **[Quick Action]** again.

Manual cursors can be used on the frozen display.

Many activities, such as adjusting the trigger level, adjusting vertical or horizontal settings, or saving data will un-freeze the display.





# 10 Labels

- To turn the label display on or off / 161
- To assign a predefined label to a channel / 162
- To define a new label / 163
- To load a list of labels from a text file you create / 164
- To reset the label library to the factory default / 165
- To add an annotation / 166

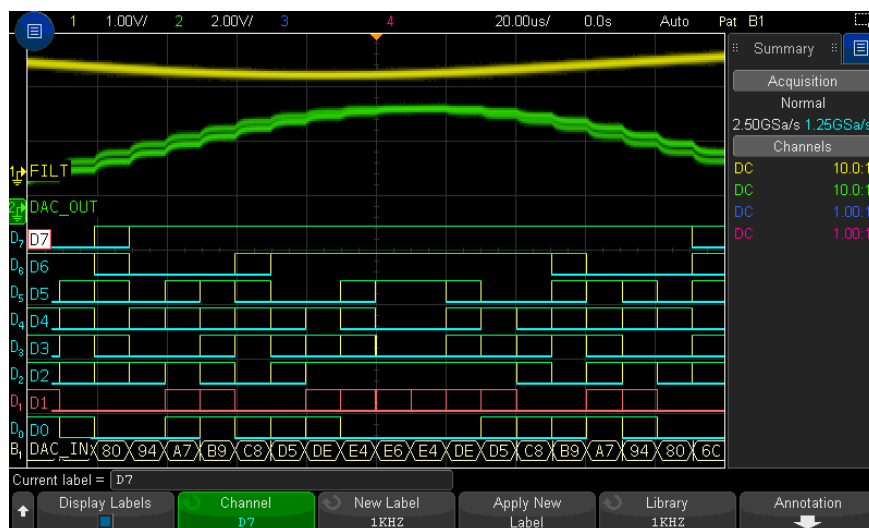
You can define labels and assign them to each analog input channel, or you can turn labels off to increase the waveform display area. Labels can also be applied to digital channels on MSO models.

## To turn the label display on or off

- 1 Press **[Display]** > **Label**.
- 2 Press the **Display Labels** softkey to turn the label display on.

This turns on labels for the displayed waveforms. Labels are displayed at the left edge of the displayed traces.

The figure below shows an example of displayed labels.



- 3 To turn the labels off, press the **Display Labels** softkey again.

To assign a predefined label to a channel

- 1 Press **[Display] > Label**.
- 2 Press the **Channel** softkey, then turn the Entry knob or successively press the **Channel** softkey to select a channel for label assignment.



The figure above shows the list of channels and their default labels. The channel does not have to be turned on to have a label assigned to it.



- 3 Press the **Library** softkey, then turn the Entry knob or successively press the **Library** softkey to select a predefined label from the library.
- 4 Press the **Apply New Label** softkey to assign the label to your selected channel.
- 5 Repeat the above procedure for each predefined label you want to assign to a channel.

## To define a new label

- 1 Press **[Display] > Label**.
- 2 Press the **Channel** softkey; then, turn the Entry knob or successively press the softkey to select a channel for label assignment.

The channel does not have to be turned on to have a label assigned to it. If the channel is turned on, its current label will be highlighted.

- 3 Press the **New Label** softkey.
- 4 In the New Label keypad dialog, you can enter text using:
  - The touch screen (when the front panel **[Touch]** key is lit).

- The  Entry knob. Turn the knob to select a key in the dialog; then, push the  Entry knob to enter it.
  - A connected USB keyboard.
  - A connected USB mouse – you can click anything on the screen that can be touched.
- 5** When you are done entering text, select the dialog's Enter or OK key or press the **New Label** softkey again.
- The new label appears in the softkey.
- 6** Press the **Apply New Label** softkey to assign the new label to the selected channel and to save the new label to the Library.

When you define a new label, it is added to the nonvolatile label list.

#### Label Assignment Auto-Increment

When you assign a label ending in a digit, such as ADDR0 or DATA0, the oscilloscope automatically increments the digit and displays the modified label in the "New label" field after you press the **Apply New Label** softkey. Therefore, you only need to select a new channel and press the **Apply New Label** softkey again to assign the label to the channel. Only the original label is saved in the label list. This feature makes it easier to assign successive labels to numbered control lines and data bus lines.

## To load a list of labels from a text file you create

It may be convenient to create a list of labels using a text editor, then load the label list into the oscilloscope. The list can have up to 75 labels. When loaded, labels are added to the beginning of the oscilloscope's list. If more than 75 labels are loaded, only the first 75 are stored.

To load labels from a text file into the oscilloscope:

- 1** Use a text editor to create each label. Each label can be up to ten characters in length. Separate each label with a line feed.
- 2** Name the file labellist.txt and save it on a USB mass storage device such as a thumb drive.
- 3** Load the list into the oscilloscope using the File Explorer (press **[Utility] > File Explorer**).

**NOTE****Label List Management**

When you press the **Library** softkey, you will see a list of the last 75 labels used. The list does not save duplicate labels. Labels can end in any number of trailing digits. As long as the base string is the same as an existing label in the library, the new label will not be put in the library. For example, if label AO is in the library and you make a new label called A12345, the new label is not added to the library.

When you save a new user-defined label, the new label will replace the oldest label in the list. Oldest is defined as the longest time since the label was last assigned to a channel. Any time you assign any label to a channel, that label will move to the newest in the list. Thus, after you use the label list for a while, your labels will predominate, making it easier to customize the instrument display for your needs.

When you reset the label library list (see next topic), all of your custom labels will be deleted, and the label list will be returned to its factory configuration.

---

## To reset the label library to the factory default

**NOTE**

Pressing the **Reset Library** softkey will remove all user-defined labels from the library and set the labels back to the factory default. Once deleted, these user-defined labels cannot be recovered.

---

- 1 Press **[Utility] > Options > Preferences**.
- 2 Press the **Reset Library** softkey.

This will delete all user-defined labels from the library and set the labels in the library back to the factory default. However, this does not default the labels currently assigned to the channels (those labels that appear in the waveform area).

**NOTE****Defaulting labels without erasing the default library**

Pressing **[Default Setup]** sets all channel labels back to the default labels but does not erase the list of user-defined labels in the library.

---

## To add an annotation

You can add up to four annotations to the oscilloscope's display. Annotations are useful for documentation purposes, to add notes before capturing screens.

To add an annotation:



- 1 Press **[Display]** > **Label**.
- 2 In the label menu, press **Annotation**.
- 3 In the Annotation Menu, press the **Display** softkey and turn the Entry knob to select the desired annotation.
- 4 Then, press the **Display** softkey again to enable/disable the annotation display.

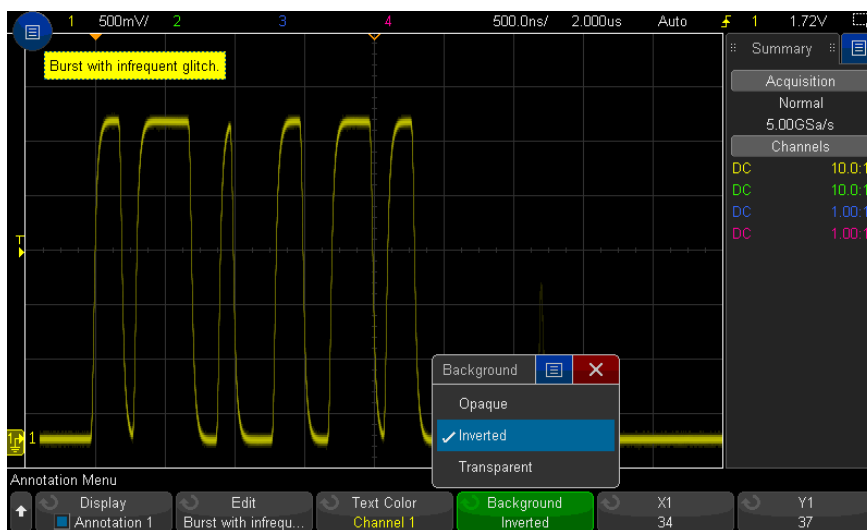
When enabled, you can drag the annotation anywhere in the graticule using the touchscreen, a USB mouse, or the **X1** and **Y1** softkeys.

- 5 Press **Edit**.
- 6 In the Edit keypad dialog, you can enter text using:



- The touch screen (when the front panel **[Touch]** key is lit).

- The  Entry knob. Turn the knob to select a key in the dialog; then, push the  Entry knob to enter it.
  - A connected USB keyboard.
  - A connected USB mouse – you can click anything on the screen that can be touched.
- 7** When you are done entering text, select the dialog's Enter or OK key or press the **Edit** softkey again.
- The annotation text appears in the softkey.
- 8** Press the **Text Color** softkey and turn the Entry knob to select the annotation color.
- You can choose white, red, or colors that match analog channels, digital channels, math waveforms, reference waveforms, or markers.
- 9** Press the **Background** softkey and turn the Entry knob to select the annotation background:
- **Opaque** – the annotation has a solid background.
  - **Inverted** – the annotation's foreground and background colors are switched.
  - **Transparent** – the annotation has a transparent background.



- See Also**
- ["To save BMP or PNG image files"](#) on page 324
  - ["To print the oscilloscope's display"](#) on page 335



# 11 Triggers

Adjusting the Trigger Level /	170
Forcing a Trigger /	171
Edge Trigger /	172
Edge then Edge Trigger /	174
Pulse Width Trigger /	175
Pattern Trigger /	178
OR Trigger /	181
Rise/Fall Time Trigger /	182
Near Field Communication (NFC) Trigger /	183
Nth Edge Burst Trigger /	186
Runt Trigger /	188
Setup and Hold Trigger /	190
Video Trigger /	191
Serial Trigger /	203
Zone Qualified Trigger /	204

A trigger setup tells the oscilloscope when to acquire and display data. For example, you can set up to trigger on the rising edge of the analog channel 1 input signal.

You can adjust the vertical level used for analog channel edge detection by turning the Trigger Level knob.

In addition to the edge trigger type, you can also set up triggers on rise/fall times, Nth edge bursts, patterns, pulse widths, runt pulses, setup and hold violations, TV signals, and serial signals (if option licenses are installed).

You can use any input channel or the **“External Trigger Input”** on page 213 BNC as the source for most trigger types.

Changes to the trigger setup are applied immediately. If the oscilloscope is stopped when you change a trigger setup, the oscilloscope uses the new specification when you press **[Run/Stop]** or **[Single]**. If the oscilloscope is running when you change a trigger setup, it uses the new trigger definition when it starts the next acquisition.

You can use the **[Force Trigger]** key to acquire and display data when triggers are not occurring.

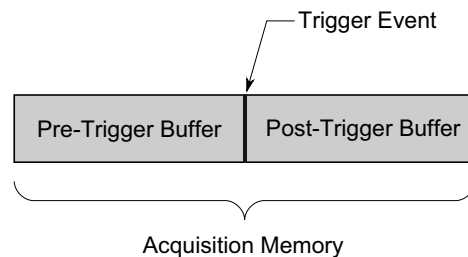
You can use the **[Mode/Coupling]** key to set options that affect all trigger types (see [Chapter 12](#), “Trigger Mode/Coupling,” starting on page 207).

You can save trigger setups along with the oscilloscope setup (see [Chapter 20](#), “Save/Email/Recall (Setups, Screens, Data),” starting on page 321).

#### Triggers - General Information

A triggered waveform is one in which the oscilloscope begins tracing (displaying) the waveform, from the left side of the display to the right, each time a particular trigger condition is met. This provides stable display of periodic signals such as sine waves and square waves, as well as nonperiodic signals such as serial data streams.

The figure below shows the conceptual representation of acquisition memory. You can think of the trigger event as dividing acquisition memory into a pre-trigger and post-trigger buffer. The position of the trigger event in acquisition memory is defined by the time reference point and the delay (horizontal position) setting (see [“To adjust the horizontal delay \(position\)”](#) on page 65).



## Adjusting the Trigger Level

You can adjust the trigger level for a selected analog channel by turning the Trigger Level knob.

You can also adjust the trigger level using the touchscreen. See "[Access the Trigger Menu, Change the Trigger Mode, and Open the Trigger Level Dialog](#)" on page 57.

You can push the Trigger Level knob to set the level of all displayed analog channels to the waveform's 50% value. If AC coupling is used, pushing the Trigger Level knob sets the trigger level to about 0 V.

When High and Low (dual) trigger levels are used (as with the Rise/Fall Time and Runt triggers, for example), pushing the Level knob toggles between high and low level adjustment.

The position of the trigger level for the analog channel is indicated by the trigger level icon **T** (if the analog channel is on) at the far left side of the display. The value of the analog channel trigger level is displayed in the upper-right corner of the display.

The trigger level for a selected digital channel is set using the threshold menu in the Digital Channel Menu. Press the **[Digital]** key on the front panel, then press the **Thresholds** softkey to set the threshold level (TTL, CMOS, ECL, or user defined) for the selected digital channel group. The threshold value is displayed in the upper-right corner of the display.

The line trigger level is not adjustable. This trigger is synchronized with the power line supplied to the oscilloscope.

**NOTE**

You can also change the trigger level of all channels by pressing **[Analyze] > Features** and then selecting **Trigger Levels**.

## Forcing a Trigger

The **[Force Trigger]** key causes a trigger (on anything) and displays the acquisition.

This key is useful in the Normal trigger mode where acquisitions are made only when the trigger condition is met. In this mode, if no triggers are occurring (that is, the "Trig'd?" indicator is displayed), you can press **[Force Trigger]** to force a trigger and see what the input signals look like.

In the Auto trigger mode, when the trigger condition is not met, triggers are forced and the "Auto?" indicator is displayed.

## Edge Trigger

The Edge trigger type identifies a trigger by looking for a specified edge (slope) and voltage level on a waveform. You can define the trigger source and slope in this menu. The trigger type, source, and level are displayed in the upper-right corner of the display.

- 1** On the front panel, in the Trigger section, press the **[Trigger]** key.
- 2** In the Trigger Menu, press the **Trigger** softkey, and use the Entry knob to select **Edge**.
- 3** Select the trigger source:
  - Analog channel, **1** to the number of channels
  - Digital channel (on mixed-signal oscilloscopes), **DO** to the number of digital channels minus one.
  - **External** – triggers on the EXT TRIG IN signal.
  - **Line** – triggers at the 50% level of the rising or falling edge of the AC power source signal.
  - **WaveGen** – triggers at the 50% level of the rising edge of the waveform generator output signal. (Not available when the DC, Noise, or Cardiac waveforms are selected.)
  - **WaveGen Mod (FSK/FM)** – when waveform generator FSK or FM modulation is used, triggers at the 50% level of the rising edge of the modulating signal.

You can choose a channel that is turned off (not displayed) as the source for the edge trigger.

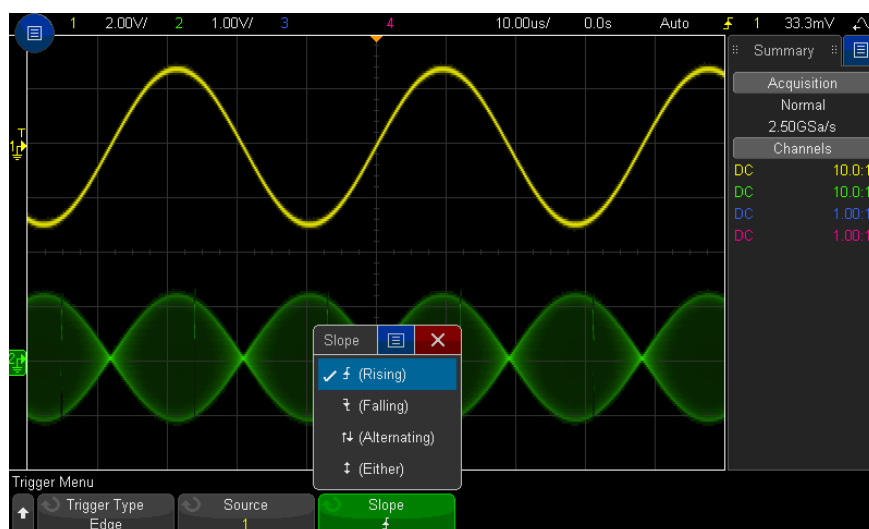
The selected trigger source is indicated in the upper-right corner of the display next to the slope symbol:

- **1** through **4** = analog channels.
  - **DO** through **Dn** = digital channels.
  - **E** = External trigger input.
  - **L** = Line trigger.
  - **W** = Waveform generator.
- 4** Press the **Slope** softkey and select:
    - **Rising** edge.
    - **Falling** edge.

- **Alternating** edges – Useful when you want to trigger on both edges of a clock (for example, DDR signals).
- **Either** edge – Useful when you want to trigger on any activity of a selected source.

Rising and Falling edge modes operate up to the bandwidth of the oscilloscope. Other modes operate up to the bandwidth of the oscilloscope or 1 GHz, whichever is smaller.

The selected slope is displayed in the upper-right corner of the display.



### Using Autoscale to Set Up Edge Triggers

The easiest way to set up an Edge trigger on a waveform is to use Autoscale. Simply press the **[Auto Scale]** key and the oscilloscope will attempt to trigger on the waveform using a simple Edge trigger type. See **“Use Autoscale”** on page 34.

### NOTE

#### MegaZoom Technology Simplifies Triggering

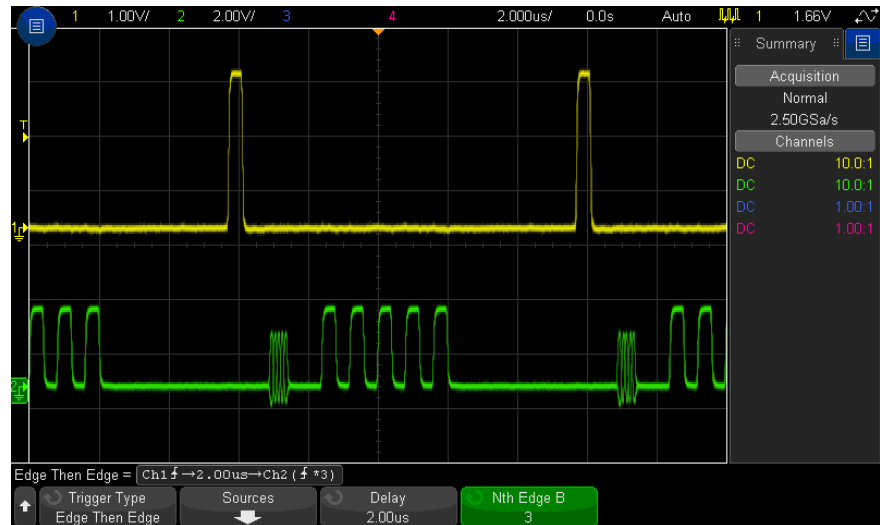
With the built-in MegaZoom technology, you can simply Autoscale the waveforms, then stop the oscilloscope to capture a waveform. You can then pan and zoom through the data using the Horizontal and Vertical knobs to find a stable trigger point. Autoscale often produces a triggered display.

## Edge then Edge Trigger

The Edge then Edge trigger mode triggers when the Nth edge occurs after an arming edge and a delay period.

The arm and trigger edges can be specified as  $\uparrow$  (Rising) or  $\downarrow$  (Falling) edges on analog or digital channels.

- 1 Press the **[Trigger]** key.
- 2 In the Trigger Menu, press the **Trigger** softkey; then, turn the Entry knob to select **Edge then Edge**.




- 3 Press the **Sources** softkey.
- 4 In the Edge then edge Sources Menu:



- a Press the **Arm A** softkey, and turn the Entry knob to select the channel on which the arming edge will occur.
- b Press the **Slope A** softkey to specify which edge of the Arm A signal will arm the oscilloscope.
- c Press the **Trigger B** softkey, and turn the Entry knob to select the channel on which the trigger edge will occur.
- d Press the **Slope B** softkey to specify which edge of the Trigger B signal will trigger the oscilloscope.

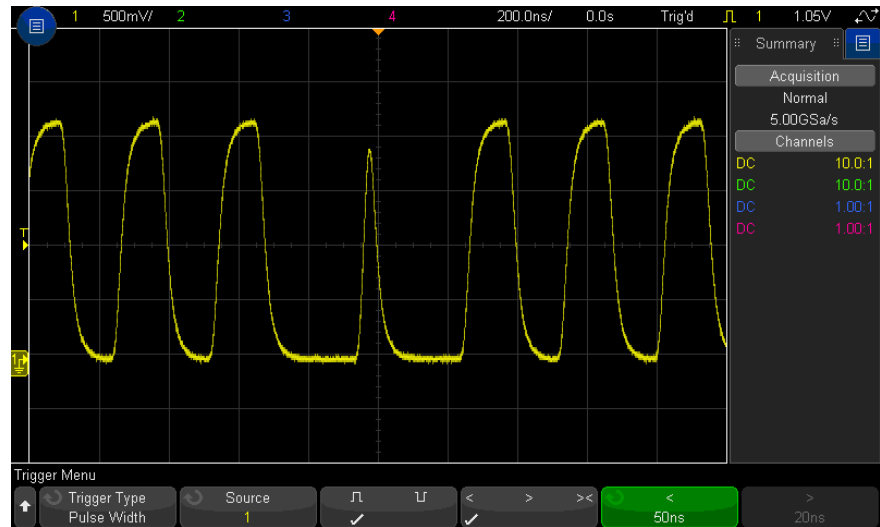
Adjust the trigger level for the selected analog channel by turning the Trigger Level knob. Press the **[Digital]** key and select **Thresholds** to set the threshold level for digital channels. The value of the trigger level or digital threshold is displayed in the upper-right corner of the display.

- 5 Press the  Back/Up key to return to the Trigger Menu.
- 6 Press the **Delay** softkey; then, turn the Entry knob to enter the delay time between the Arm A edge and the Trigger B edge.
- 7 Press the **Nth Edge B** softkey; then, turn the Entry knob to select the Nth edge of the Trigger B signal to trigger on.

## Pulse Width Trigger

Pulse Width (glitch) triggering sets the oscilloscope to trigger on a positive or negative pulse of a specified width. If you want to trigger on a specific timeout value, use **Pattern** trigger in the Trigger Menu (see "**Pattern Trigger**" on page 178).

- 1 Press the **[Trigger]** key.
- 2 In the Trigger Menu, press the **Trigger** softkey; then, turn the Entry knob to select **Pulse Width**.



- 3 Press the **Source** softkey; then, rotate the Entry knob to select a channel source for the trigger.

The channel you select is shown in the upper-right corner of the display next to the polarity symbol.

The source can be any analog or digital channel available on your oscilloscope.

- 4 Adjust the trigger level:
  - For analog channels, turn the Trigger Level knob.
  - For digital channels, press the **[Digital]** key and select **Thresholds** to set the threshold level.

The value of the trigger level or digital threshold is displayed in the upper-right corner of the display.

- 5 Press the pulse polarity softkey to select positive ( $\sqcap$ ) or negative ( $\sqcup$ ) polarity for the pulse width you want to capture.

The selected pulse polarity is displayed in the upper-right corner of the display. A positive pulse is higher than the current trigger level or threshold and a negative pulse is lower than the current trigger level or threshold.



When triggering on a positive pulse, the trigger will occur on the high to low transition of the pulse if the qualifying condition is true. When triggering on a negative pulse, the trigger will occur on the low to high transition of the pulse if the qualifying condition is true.

**6** Press the qualifier softkey (< > ><) to select the time qualifier.

The Qualifier softkey can set the oscilloscope to trigger on a pulse width that is:

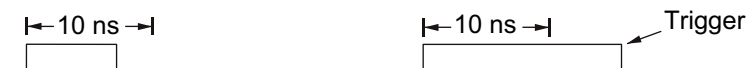
- Less than a time value (<).

For example, for a positive pulse, if you set  $t < 10$  ns:



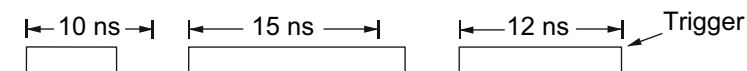
- Greater than a time value (>).

For example, for a positive pulse, if you set  $t > 10$  ns:



- Within a range of time values (><).

For example, for a positive pulse, if you set  $t > 10$  ns and  $t < 15$  ns:



**7** Select the qualifier time set softkey (< or >), then rotate the Entry knob to set the pulse width qualifier time.

The qualifiers can be set as follows:

- 2 ns to 10 s for > or < qualifier (5 ns to 10 s for 350 MHz and lower bandwidth models).
- 10 ns to 10 s for >< qualifier, with minimum difference of 5 ns between upper and lower settings.
- When the less than (<) qualifier is selected, the Entry knob sets the oscilloscope to trigger on a pulse width less than the time value displayed on the softkey.

**Pulse width  
trigger < qualifier  
time set softkey**

Pulse width  
trigger > qualifier  
time set softkey

- When the time range (><) qualifier is selected, the Entry knob sets the upper time range value.
- When the greater than (>) qualifier is selected, the Entry knob sets the oscilloscope to trigger on a pulse width greater than the time value displayed on the softkey.
- When the time range (><) qualifier is selected, the Entry knob sets the lower time range value.

## Pattern Trigger

The Pattern trigger identifies a trigger condition by looking for a specified pattern. This pattern is a logical AND combination of the channels. Each channel can have a value of 0 (low), 1 (high), or don't care (X). A rising or falling edge can be specified for one channel included in the pattern.

- 1 Press the **[Trigger]** key.
- 2 In the Trigger Menu, press the **Trigger** softkey; then, turn the Entry knob to select **Pattern**.
- 3 Press the **Qualifier** softkey; then, turn the Entry knob to select from the pattern duration qualifier options:
  - **Entered** – when the pattern is entered.
  - **<** (Less Than) – when the pattern is present for less than a time value.
  - **>** (Greater Than) – when the pattern is present for greater than a time value. The trigger occurs when the pattern exits (not when the > softkey time value is exceeded).
  - **Timeout** – when the pattern is present for greater than a time value. In this case, the trigger occurs when the > softkey time value is exceeded (not when the pattern exits).
  - **>< (In Range)** – when the pattern is present for a time within a range of values.
  - **<> (Out of Range)** – when the pattern is present for a time outside of range of values.

Pattern durations are evaluated using a timer. The timer starts on the last edge that makes the pattern (logical AND) true. Except when the **Timeout** qualifier is selected, the trigger occurs on the first edge that makes the pattern false, provided the time qualifier criteria has been met.

The time values for the selected qualifier are set using the qualifier time set softkeys (< and >) and the Entry knob.

- 4 To set the analog or digital channel patterns, press the **Analog** softkey or the **Digital** softkey and use the binary keypad dialog to enter:



- **0** sets the pattern to zero (low) on the selected channel. A low is a voltage level that is less than the channel's trigger level or threshold level.
- **1** sets the pattern to 1 (high) on the selected channel. A high is a voltage level that is greater than the channel's trigger level or threshold level.
- **X** sets the pattern to don't care on the selected channel. Any channel set to don't care is ignored and is not used as part of the pattern. However, if all channels in the pattern are set to don't care, the oscilloscope will not trigger.
- The rising edge (↗) or falling edge (↘) softkey sets the pattern to an edge on the selected channel. Only one rising or falling edge can be specified in the pattern. When an edge is specified, the oscilloscope will trigger at the edge specified if the pattern set for the other channels is true.

If no edge is specified, the oscilloscope will trigger on the last edge that makes the pattern true.

**NOTE****Specifying an Edge in a Pattern**

You are allowed to specify only one rising or falling edge term in the pattern. If you define an edge term, then select a different channel in the pattern and define another edge term, the previous edge definition is changed to a don't care.

You can also specify patterns for digital channels using the **Bus1** and **Bus2** softkeys and entering hexadecimal values. See **"Hex Bus Pattern Trigger"** on page 180.

The specified pattern is shown in the "Pattern =" line directly above the softkeys.

- 5 Adjust the trigger levels for analog and digital channels by using the softkeys in the Analyze Menu after pressing **[Analyze]** > **Features** and selecting **Trigger Levels**.

You can also set the threshold levels for digital channels by pressing **[Digital]** > **Thresholds**.

## Hex Bus Pattern Trigger

You can specify a bus value on which to trigger. To do this, first define the bus. See **"To display digital channels as a bus"** on page 140 for details. You can trigger on a bus value whether you are displaying the bus or not.

To trigger on a bus value:

- 1 Select the pattern trigger type and qualifier as described in **"Pattern Trigger"** on page 178.
- 2 Press the **Bus1** or **Bus2** softkey and use the hex keypad dialog to enter nibble (hex character) values.

**NOTE**

If a digit is made up of less than four bits, the value of the digit is limited to the greatest number that can be represented by the number of bits.

When a hex bus digit contains one or more don't care (X) bits and one or more bits with a value of 0 or 1, the "\$" sign will be displayed for the digit.

For information regarding digital bus display when Pattern triggering see **"Bus values are displayed when using Pattern trigger"** on page 142.

## OR Trigger

The OR trigger mode triggers when any one (or more) of the specified edges on analog or digital channels is found.

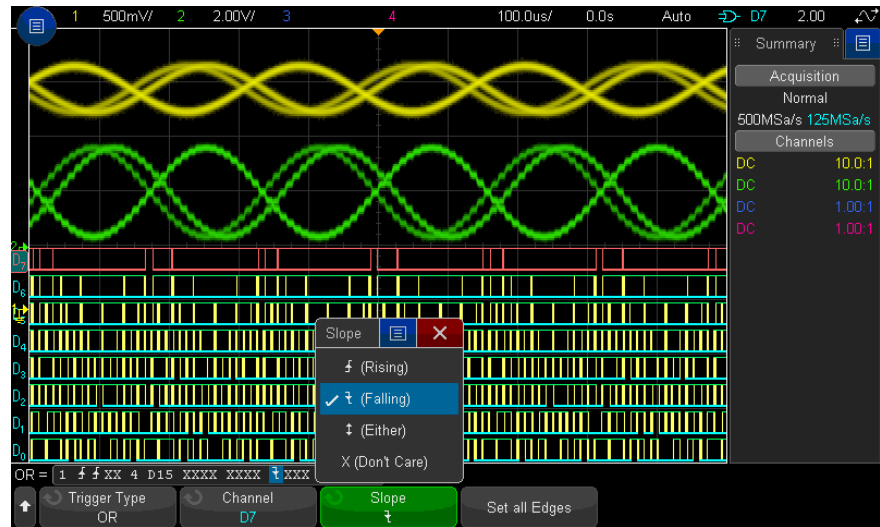
- 1 On the front panel, in the Trigger section, press the **[Trigger]** key.
- 2 In the Trigger Menu, press the **Trigger** softkey, and use the Entry knob to select **OR**.
- 3 Press the **Slope** softkey and select rising edge, falling edge, either edge, or don't care. The selected slope is displayed in the upper-right corner of the display.
- 4 For each analog or digital channel you want to include in the OR trigger, press the **Channel** softkey to select the channel.

As you press the **Channel** softkey (or rotate the Entry knob), the channel you select is highlighted in the OR = line directly above the softkeys and in the upper-right corner of the display next to the OR gate symbol.

Adjust the trigger level for the selected analog channel by turning the Trigger Level knob. Press the **[Digital]** key and select **Thresholds** to set the threshold level for digital channels. The value of the trigger level or digital threshold is displayed in the upper-right corner of the display.

- 5 For each channel you select, press the **Slope** softkey and select **↗** (Rising), **↘** (Falling), **↕** (Either), or **X** (Don't Care). The selected slope is displayed above the softkeys.

## 11 Triggers

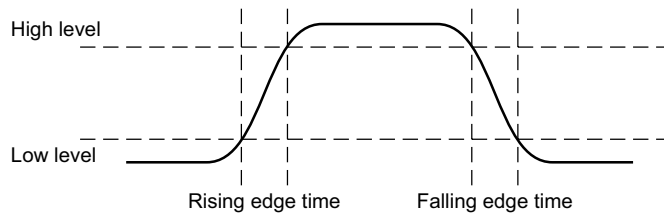


If all channels in the OR trigger are set to don't care, the oscilloscope will not trigger.

- 6 To set all analog and digital channels to the edge selected by the **Slope** softkey, press the **Set all Edges** softkey.

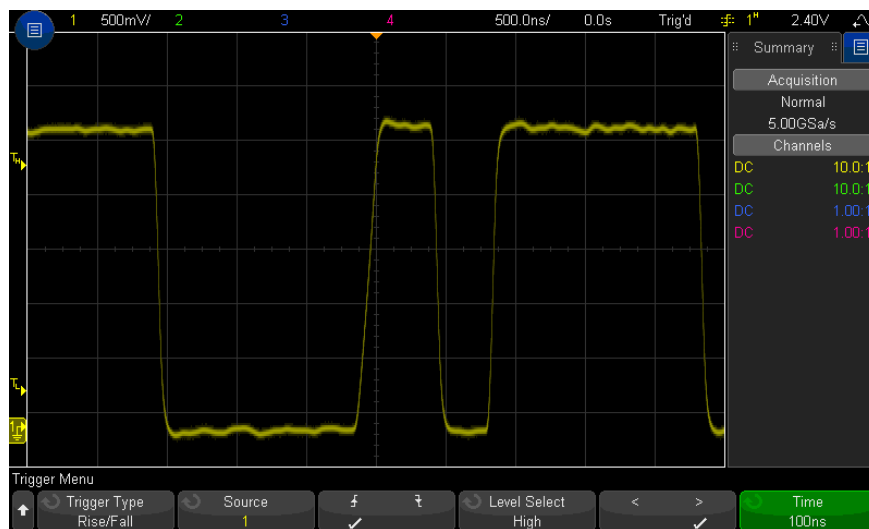
## Rise/Fall Time Trigger

The Rise/Fall Time trigger looks for a rising or falling transition from one level to another level in greater than or less than a certain amount of time.



- 1 Press the **[Trigger]** key.

- In the Trigger Menu, press the **Trigger** softkey; then, turn the Entry knob to select **Rise/Fall Time**.



- Press the **Source** softkey, and turn the Entry knob to select the input channel source.
- Press the **Rising Edge or Falling Edge** softkey to toggle between edge types.
- Press the **Level Select** softkey to select **High**; then, turn the Trigger Level knob to adjust the high level.
- Press the **Level Select** softkey to select **Low**; then, turn the Trigger Level knob to adjust the low level.  
You can also push the Trigger Level knob to toggle between **High** and **Low** selection.
- Press the **Qualifier** softkey to toggle between "greater than" or "less than".
- Press the **Time** softkey, and turn the Entry knob to select the time.

## Near Field Communication (NFC) Trigger

NFC (Near Field Communication) triggering is used to capture waveforms used in NFC testing.

The NFC trigger type is license-enabled. The license also enables companion PC-based automated test software.

**Table 3** NFC Triggering Characteristics

Standard:	Trigger on:	In "Arm & Trigger":	
		Arm on:	Trigger on:
NFC-A	<ul style="list-style-type: none"> <li>▪ SENS_REQ</li> <li>▪ ALL_REQ</li> <li>▪ Either (SENS_REQ or ALL_REQ)</li> <li>▪ SDD_REQ</li> <li>▪ Arm &amp; Trigger</li> </ul>	<ul style="list-style-type: none"> <li>▪ SENS_REQ</li> <li>▪ ALL_REQ</li> <li>▪ Either (SENS_REQ or ALL_REQ)</li> </ul>	<ul style="list-style-type: none"> <li>▪ SDD_REQ or Timeout<sup>1</sup></li> </ul>
NFC-B	<ul style="list-style-type: none"> <li>▪ SENSB_REQ</li> <li>▪ ALLB_REQ</li> <li>▪ Either (SENSB_REQ or ALLB_REQ)</li> <li>▪ ATTRIB</li> <li>▪ Arm &amp; Trigger</li> </ul>	<ul style="list-style-type: none"> <li>▪ SENSB_REQ</li> <li>▪ ALLB_REQ</li> <li>▪ Either (SENB_REQ or ALLB_REQ)</li> </ul>	<ul style="list-style-type: none"> <li>▪ ATTRIB or Timeout<sup>1</sup></li> </ul>
NFC-F <sup>2</sup>	<ul style="list-style-type: none"> <li>▪ SENSF_REQ</li> <li>▪ ATR_REQ</li> <li>▪ Preamble</li> <li>▪ Arm &amp; Trigger</li> </ul>	<ul style="list-style-type: none"> <li>▪ SENSF_REQ</li> </ul>	<ul style="list-style-type: none"> <li>▪ ATR_REQ or Timeout<sup>1</sup></li> </ul>

Notes:

- 1 When using the **Arm & Trigger** selection, the oscilloscope arms on one event and then triggers on a second event or after a specified timeout period if the second event does not occur
- 2 Both NFC-F (212 kbps) and NFC-F (424 kbps) are supported.

When the NFC trigger type is selected, there are softkeys for selecting the source, signaling technology standard, trigger event, and other settings:

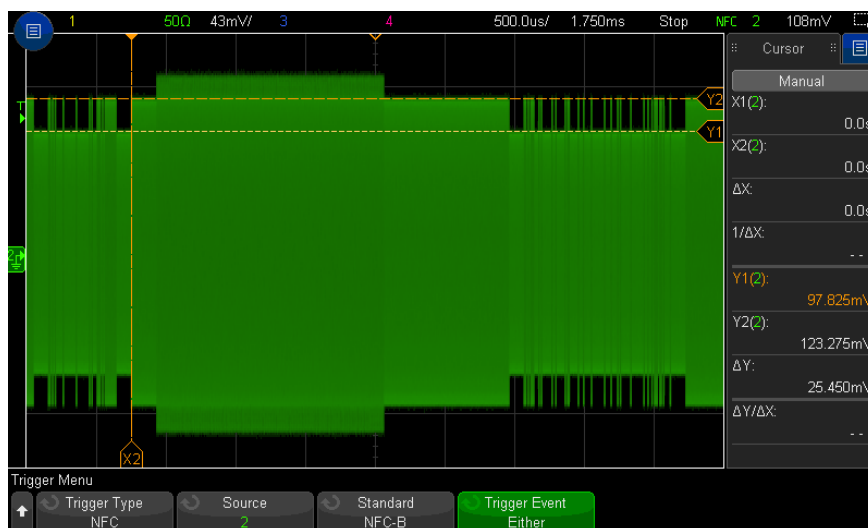
- 1 Press the **[Trigger]** key.
- 2 In the Trigger Menu, press the **Trigger** softkey; then, turn the Entry knob to select **Near Field Communication (NFC)**.





- 3 Press the **Source** softkey, and turn the Entry knob to select an analog input channel source.
- 4 Press the **Standard** softkey to select the signaling technology used by the input signal.
- 5 Set the trigger level to capture transitions in the modulation envelope. Or at approximately 50% of the modulation depth. NFC-A uses 100% modulation, so the trigger level can be set in a wide range of values. NFC-B, NFC-F212, and NFC-F424 use 10% modulation, so the trigger level needs to be set to approximately 95% of the unmodulated carrier amplitude. Usually the actual modulation depth is greater than 10%, so the trigger level can be set accordingly.

The following image shows how the trigger level should be set. The Y2 marker is set for the unmodulated carrier amplitude or 123.3 mV. The Y1 marker is set for the maximum modulated amplitude or 97.8 mV. (Note that the actual modulation depth is close to 20%.) The midpoint of the modulation would be  $(123.3 \text{ mV} + 97.8 \text{ mV}) / 2.0 = 110.6 \text{ mV}$ . The trigger level is set to 108 mV; slightly below the mid modulation level to account for trigger hysteresis.



- 6** Press the **Trigger Event** softkey; then, turn the Entry knob to select the event to trigger on. Some of the events you can select are defined in the standards; other event options include:
- **Either** – With the NFC-A signaling technology, this option means either the SENS\_REQ or ALL\_REQ events will cause a trigger. With the NFC-B signaling technology, this option means either the SENSB\_REQ or ALLB\_REQ events will cause a trigger.
  - **Preamble** – With the NFC-F signaling technologies, this option specifies the preamble sequence that begins a data frame.
  - **Arm & Trigger** – This selection lets you arm the oscilloscope on one event and then trigger on a second event or after a specified timeout period if the second event does not occur.
- 7** With the NFC-F standards, there is a **Reverse Polarity** softkey that enables the oscilloscope to trigger on "reverse" polarity signals. When disabled, the oscilloscope triggers on "obverse" polarity signals.
- 8** When the **Arm & Trigger** event is selected:
- a** Press the **Arm Event** softkey to select the event to arm on.
- When the specified event arms, the *TRIG OUTBNC* goes high. The oscilloscope waits until a second event is found or until the specified timeout period expires and then triggers.
- For NFC-A, the second event is SDD\_REQ.
  - For NFC-B, the second event is ATTRIB.
  - For NFC-F, the second event is ATR\_REQ.
- When the oscilloscope triggers, the *TRIG OUTBNC* line goes low.
- b** Press the **Timeout** softkey; then, turn the Entry knob (or press the softkey again and use the keypad dialog) to enter the timeout period.

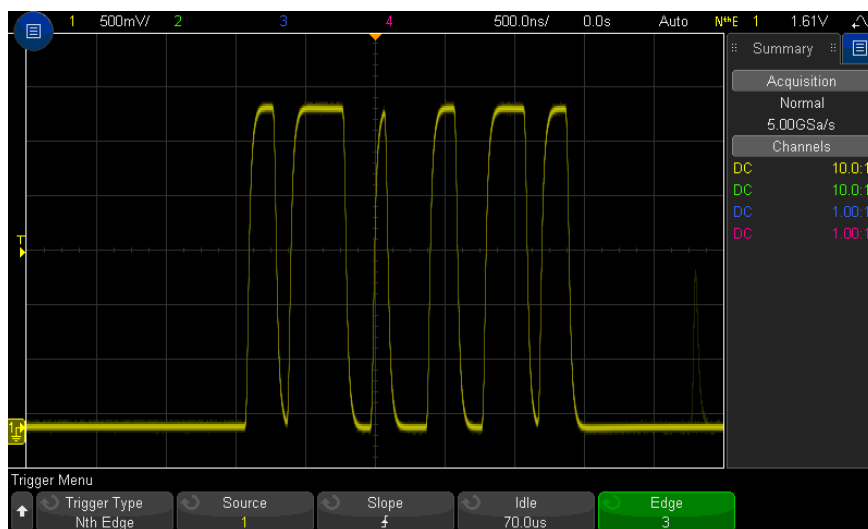
## Nth Edge Burst Trigger

The Nth Edge Burst trigger lets you trigger on the Nth edge of a burst that occurs after an idle time.



Nth Edge Burst trigger set up consists of selecting the source, the slope of the edge, the idle time, and the number of the edge:

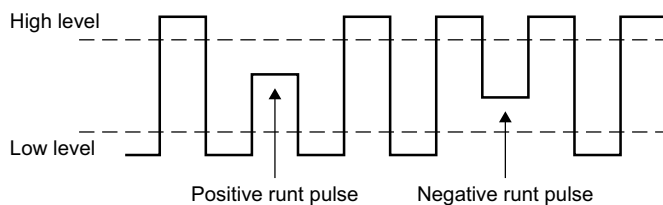
- 1 Press the **[Trigger]** key.
- 2 In the Trigger Menu, press the **Trigger** softkey; then, turn the Entry knob to select **Nth Edge Burst**.



- 3 Press the **Source** softkey, and turn the Entry knob to select the input channel source.
- 4 Press the **Slope** softkey to specify the slope of the edge.
- 5 Press the **Idle** softkey; then, turn the Entry knob to specify the idle time.
- 6 Press the **Edge** softkey; then, turn the Entry knob to which edge number to trigger on.

## Runt Trigger

The Runt trigger looks for pulses that cross one threshold but not another.



- A positive runt pulse crosses through a lower threshold but not an upper threshold.
- A negative runt pulse crosses through an upper threshold but not a lower threshold.

To trigger on runt pulses:

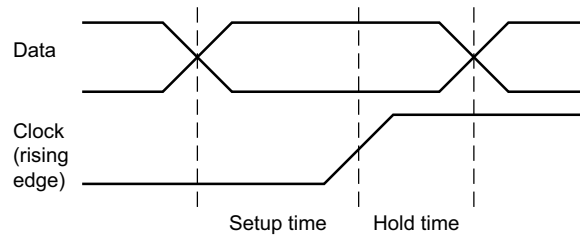
- 1** Press the **[Trigger]** key.
- 2** In the Trigger Menu, press the **Trigger** softkey; then, turn the Entry knob to select **Runt**.



- 3 Press the **Source** softkey, and turn the Entry knob to select the input channel source.
- 4 Press the **Positive, Negative, or Either Runt Pulse** softkey to toggle between pulse types.
- 5 Press the **Level Select** softkey to select **High**; then, turn the Trigger Level knob to adjust the high level.
- 6 Press the **Level Select** softkey to select **Low**; then, turn the Trigger Level knob to adjust the low level.  
 You can also push the Trigger Level knob to toggle between **High** and **Low** selection.
- 7 Press the **Qualifier** softkey to toggle between "less than", "greater than", or **None**.  
 This lets you specify that a runt pulse be less than or greater than a certain width.
- 8 If you selected the "less than" or "greater than" **Qualifier**, press the **Time** softkey; then, turn the Entry knob to select the time.

## Setup and Hold Trigger

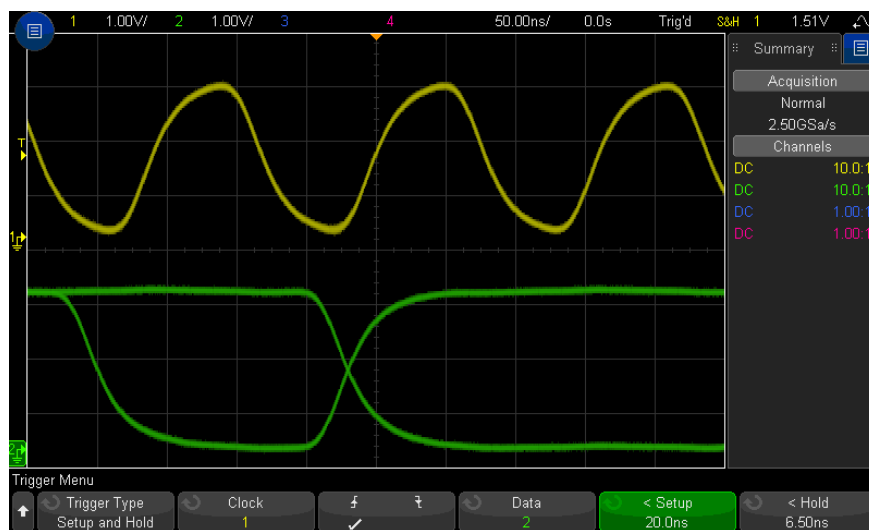
The Setup and Hold trigger looks for setup and hold violations.



One oscilloscope channel probes the clock signal and another channel probes the data signal.

To trigger on setup and hold violations:

- 1 Press the **[Trigger]** key.
- 2 In the Trigger Menu, press the **Trigger** softkey; then, turn the Entry knob to select **Setup and Hold**.
- 3 Press the **Clock** softkey; then, turn the Entry knob to select the input channel with the clock signal.
- 4 Set the appropriate trigger level for the clock signal using the Trigger Level knob.
- 5 Press the **Rising Edge or Falling Edge** softkey to specify the clock edge being used.
- 6 Press the **Data** softkey; then, turn the Entry knob to select the input channel with the data signal.
- 7 Set the appropriate trigger level for the data signal using the Trigger Level knob.
- 8 Press the **< Setup** softkey, and turn the Entry knob to select the setup time.



- 9 Press the **< Hold** softkey, and turn the Entry knob to select the hold time.

## Video Trigger

Video triggering can be used to capture the complicated waveforms of most standard analog video signals. The trigger circuitry detects the vertical and horizontal interval of the waveform and produces triggers based on the video trigger settings you have selected.

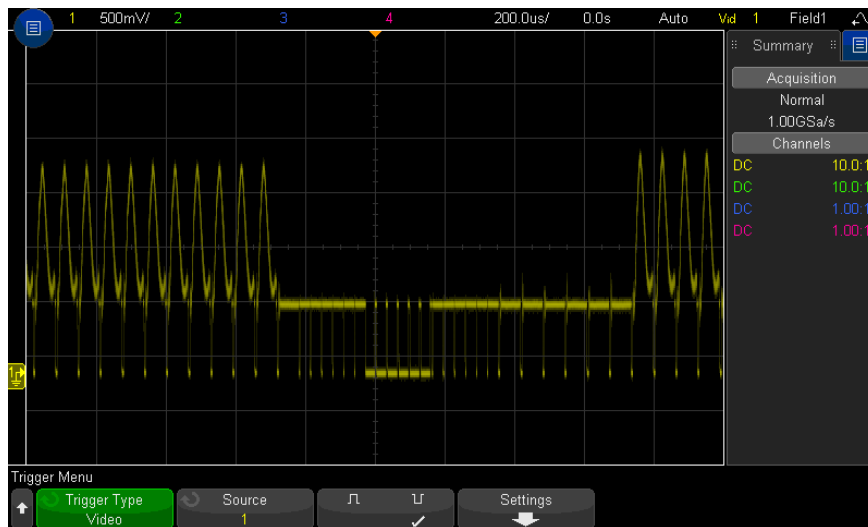
The oscilloscope's MegaZoom IV technology gives you bright, easily viewed displays of any part of the video waveform. Analysis of video waveforms is simplified by the oscilloscope's ability to trigger on any selected line of the video signal.

### NOTE

It is important, when using a 10:1 passive probe, that the probe is correctly compensated. The oscilloscope is sensitive to this and will not trigger if the probe is not properly compensated, especially for progressive formats.

- 1 Press the **[Trigger]** key.

- In the Trigger Menu, press the **Trigger** softkey; then, turn the Entry knob to select **Video**.



- Press the **Source** softkey and select any analog channel as the video trigger source.

The selected trigger source is displayed in the upper-right corner of the display. Turning the Trigger **Level** knob does not change the trigger level because the trigger level is automatically set to the sync pulse. Trigger coupling is automatically set to **TV** in the Trigger Mode and Coupling Menu.

## NOTE

### Provide Correct Matching

Many video signals are produced from  $75\ \Omega$  sources. To provide correct matching to these sources, a  $75\ \Omega$  terminator (such as a Keysight 11094B) should be connected to the oscilloscope input.

- Press the sync polarity softkey to set the Video trigger to either positive ( $\square$ ) or negative ( $\sqcup$ ) sync polarity.
- Press the **Settings** softkey.





- 6 In the Video Trigger Menu, press the **Standard** softkey to set the video standard. The oscilloscope supports triggering on the following television (TV) and video standards.

Standard	Type	Sync Pulse
NTSC	Interlaced	Bi-level
PAL	Interlaced	Bi-level
PAL-M	Interlaced	Bi-level
SECAM	Interlaced	Bi-level

With the DSOX3VID extended video triggering license, the oscilloscope additionally supports these standards:

Standard	Type	Sync Pulse
Generic	Interlaced/Progressive	Bi-level/Tri-level
EDTV 480p/60	Progressive	Bi-level
EDTV 567p/50	Progressive	Bi-level
HDTV 720p/50	Progressive	Tri-level
HDTV 720p/60	Progressive	Tri-level
HDTV 1080p/24	Progressive	Tri-level
HDTV 1080p/25	Progressive	Tri-level
HDTV 1080p/30	Progressive	Tri-level
HDTV 1080p/50	Progressive	Tri-level
HDTV 1080p/60	Progressive	Tri-level
HDTV 1080i/50	Interlaced	Tri-level
HDTV 1080i/60	Interlaced	Tri-level

The **Generic** selection lets you trigger on custom bi-level and tri-level sync video standards. See [“To set up Generic video triggers”](#) on page 195.

- 7 Press the **Auto Setup** softkey to automatically set up the oscilloscope for the selected **Source** and **Standard**:
  - Source channel vertical scaling is set to 140 mV/div.
  - Source channel offset is set to 245 mV.
  - Source channel is turned on.
  - Trigger type is set to **Video**.
  - Video trigger mode is set to **All Lines** (but left unchanged if **Standard** is **Generic**).
  - Display **Grid** type is set to **IRE** (when **Standard** is **NTSC**) or **mV** (see [“To select the grid type”](#) on page 158).
  - Horizontal time/division is set to 10  $\mu$ s/div for NTSC/PAL/SECAM standards or 4  $\mu$ s/div for EDTV or HDTV standards (unchanged for **Generic**).
  - Horizontal delay is set so that trigger is at first horizontal division from the left (unchanged for **Generic**).

You can also press **[Analyze]> Features** and then select **Video** to quickly access the video triggering automatic set up and display options.

- 8 Press the **Mode** softkey to select the portion of the video signal that you would like to trigger on.

The Video trigger modes available are:

- **Field1** and **Field2** – Trigger on the rising edge of the first serration pulse of field 1 or field 2 (interlaced standards only).
  - **All Fields** – Trigger on the rising edge of the first pulse in the vertical sync interval.
  - **All Lines** – Trigger on all horizontal sync pulses.
  - **Line** – Trigger on the selected line number (EDTV and HDTV standards only).
  - **Line: Field1** and **Line:Field2** – Trigger on the selected line # in field 1 or field 2 (interlaced standards only).
  - **Line: Alternate** – Alternately trigger on the selected line # in field 1 and field 2 (NTSC, PAL, PAL-M, and SECAM only).
- 9 If you select a line # mode, press the **Line #** softkey, then rotate the Entry knob to select the line number on which you want to trigger.

The following table lists the line (or count) numbers per field for each video standard.

Video standard	Field 1	Field 2	Alt Field
NTSC	1 to 263	1 to 262	1 to 262
PAL	1 to 313	314 to 625	1 to 312
PAL-M	1 to 263	264 to 525	1 to 262
SECAM	1 to 313	314 to 625	1 to 312

The following table lists the line numbers for each EDTV/HDTV video standard (available with the DSOX3VID extended video triggering license).

EDTV 480p/60	1 to 525
EDTV 567p/50	1 to 625
HDTV 720p/50, 720p/60	1 to 750
HDTV 1080p/24, 1080p/25, 1080p/30, 1080p/50, 1080p/60	1 to 1125
HDTV 1080i/50, 1080i/60	1 to 1125

### Video Triggering Examples

The following are exercises to familiarize you with video triggering. These exercises use the NTSC video standard.

- **"To trigger on a specific line of video"** on page 196
- **"To trigger on all sync pulses"** on page 197
- **"To trigger on a specific field of the video signal"** on page 198
- **"To trigger on all fields of the video signal"** on page 199
- **"To trigger on odd or even fields"** on page 200

### To set up Generic video triggers

When **Generic** (available with the DSOX3VID extended video triggering license) is selected as the Video trigger **Standard**, you can trigger on custom bi-level and tri-level sync video standards. The Video Trigger Menu changes as follows.



- 1 Press the **Time >** softkey; then, turn the Entry knob to set the time to greater-than the sync-pulse width so that the oscilloscope synchronizes to the vertical sync.
- 2 Press the **Edge #** softkey; then, turn the Entry knob to select the Nth edge after after vertical sync to trigger on.
- 3 To enable or disable the horizontal sync control, press the first **Horiz Sync** softkey.
  - For interleaved video, enabling the **Horiz Sync** control and setting the **Horiz Sync** adjustment to the sync time of the probed video signal allows the **Edge #** function to count only lines and not double count during equalization. Additionally, the **Field Holdoff** can be adjusted so that the oscilloscope triggers once per frame.
  - Similarly, for progressive video with a tri-level sync, enabling the **Horiz Sync** control and setting the **Horiz Sync** adjustment to the sync time of the probed video signal allows the **Edge #** function to count only lines and not double count during vertical sync.

When the horizontal sync control is enabled, press the second **Horiz Sync** softkey; then, turn the Entry knob to set the minimum time the horizontal sync pulse must be present to be considered valid.

## To trigger on a specific line of video

Video triggering requires greater than 1/2 division of sync amplitude with any analog channel as the trigger source. Turning the trigger **Level** knob in Video trigger does not change the trigger level because the trigger level is automatically set to the sync pulse tips.

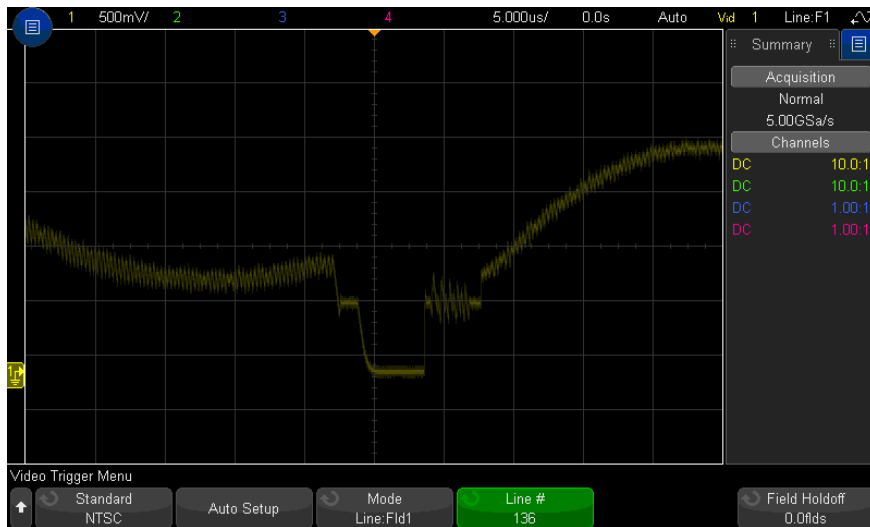
One example of triggering on a specific line of video is looking at the vertical interval test signals (VITS), which are typically in line 18. Another example is closed captioning, which is typically in line 21.

- 1 Press the **[Trigger]** key.
- 2 In the Trigger Menu, press the **Trigger** softkey; then, turn the Entry knob to select **Video**.
- 3 Press the **Settings** softkey, then press the **Standard** softkey to select the appropriate TV standard (NTSC).

- 4 Press the **Mode** softkey and select the TV field of the line you want to trigger on. You can choose **Line:Field1**, **Line:Field2**, or **Line:Alternate**.
- 5 Press the **Line #** softkey and select the number of the line you want to examine.

**NOTE****Alternate Triggering**

If **Line:Alternate** is selected, the oscilloscope will alternately trigger on the selected line number in Field 1 and Field 2. This is a quick way to compare the Field 1 VITS and Field 2 VITS or to check for the correct insertion of the half line at the end of Field 1.



**Figure 28** Example: Triggering on Line 136

## To trigger on all sync pulses

To quickly find maximum video levels, you could trigger on all sync pulses. When **All Lines** is selected as the Video trigger mode, the oscilloscope will trigger on all horizontal sync pulses.

- 1 Press the **[Trigger]** key.
- 2 In the Trigger Menu, press the **Trigger** softkey; then, turn the Entry knob to select **Video**.

- 3 Press the **Settings** softkey, then press the **Standard** softkey to select the appropriate TV standard.
- 4 Press the **Mode** softkey and select **All Lines**.

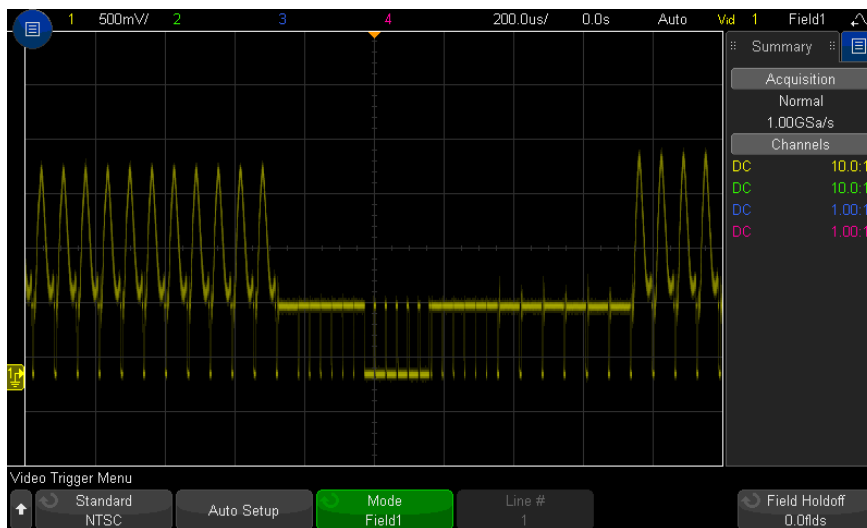


**Figure 29** Triggering on All Lines

To trigger on a specific field of the video signal

To examine the components of a video signal, trigger on either Field 1 or Field 2 (available for interleaved standards). When a specific field is selected, the oscilloscope triggers on the rising edge of the first serration pulse in the vertical sync interval in the specified field (1 or 2).

- 1 Press the **[Trigger]** key.
- 2 In the Trigger Menu, press the **Trigger** softkey; then, turn the Entry knob to select **Video**.
- 3 Press the **Settings** softkey, then press the **Standard** softkey to select the appropriate TV standard.
- 4 Press the **Mode** softkey and select **Field1** or **Field2**.

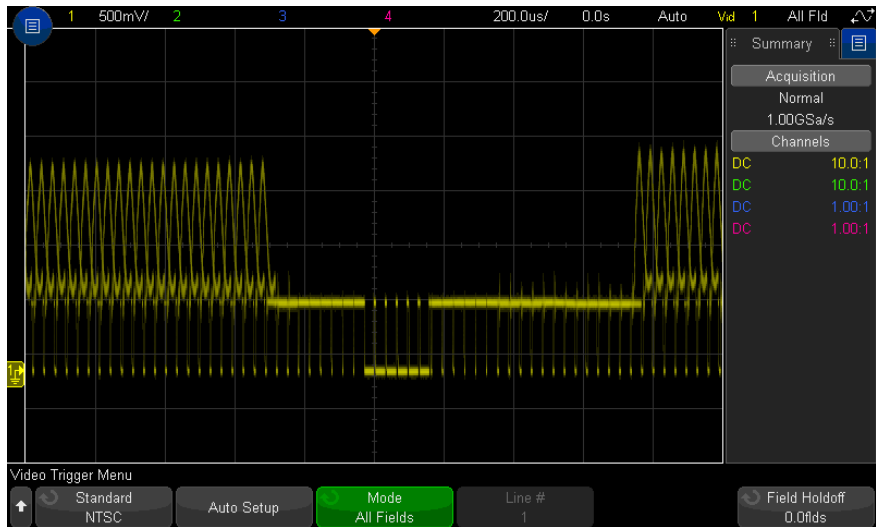


**Figure 30** Triggering on Field 1

To trigger on all fields of the video signal

To quickly and easily view transitions between fields, or to find the amplitude differences between the fields, use the All Fields trigger mode.

- 1 Press the **[Trigger]** key.
- 2 In the Trigger Menu, press the **Trigger** softkey; then, turn the Entry knob to select **Video**.
- 3 Press the **Settings** softkey, then press the **Standard** softkey to select the appropriate TV standard.
- 4 Press the **Mode** softkey and select **All Fields**.



**Figure 31** Triggering on All Fields

## To trigger on odd or even fields

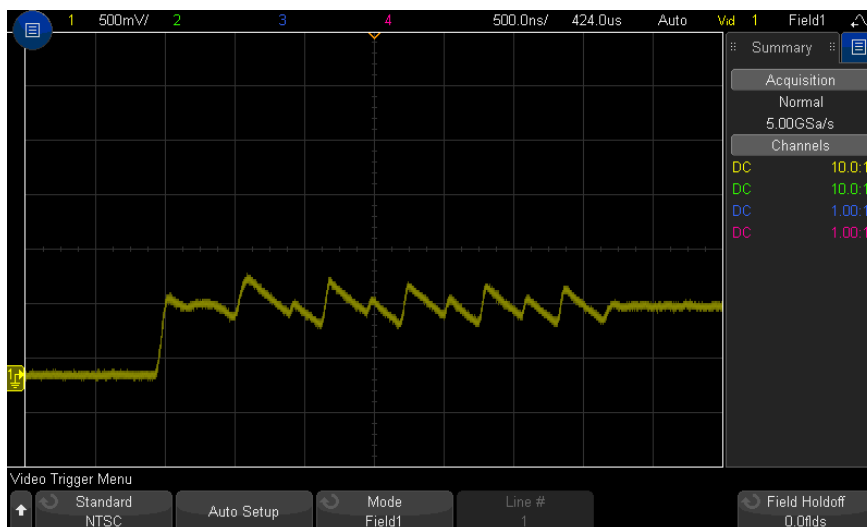
To check the envelope of your video signals, or to measure worst case distortion, trigger on the odd or even fields. When Field 1 is selected, the oscilloscope triggers on color fields 1 or 3. When Field 2 is selected, the oscilloscope triggers on color fields 2 or 4.

- 1 Press the **[Trigger]** key.
- 2 In the Trigger Menu, press the **Trigger** softkey; then, turn the Entry knob to select **Video**.
- 3 Press the **Settings** softkey, then press the **Standard** softkey to select the appropriate TV standard.
- 4 Press the **Mode** softkey and select **Field1** or **Field2**.

The trigger circuits look for the position of the start of Vertical Sync to determine the field. But this definition of field does not take into consideration the phase of the reference subcarrier. When Field 1 is selected, the trigger system will find any field where the vertical sync starts on Line 4. In the case of NTSC video, the



oscilloscope will trigger on color field 1 alternating with color field 3 (see the following figure). This setup can be used to measure the envelope of the reference burst.



**Figure 32** Triggering on Color Field 1 Alternating with Color Field 3

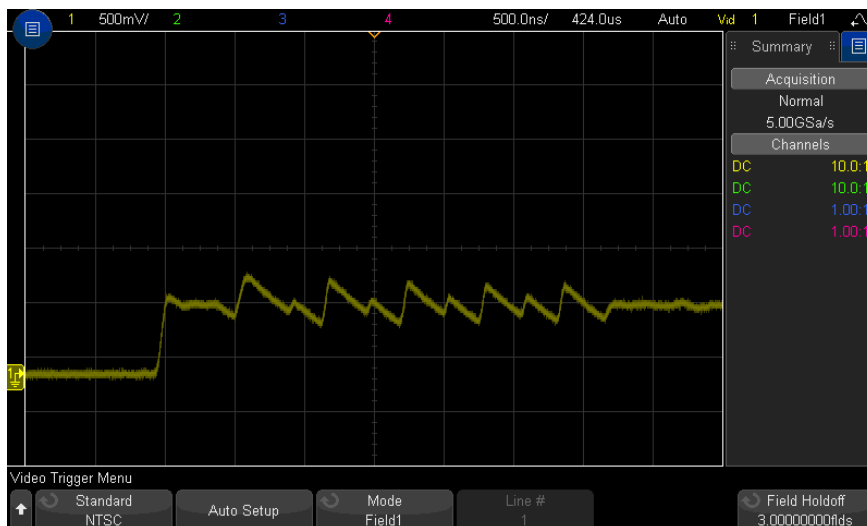
If a more detailed analysis is required, then only one color field should be selected to be the trigger. You can do this by using the **Field Holdoff** softkey in the Video Trigger Menu. Press the **Field Holdoff** softkey and use the Entry knob to adjust the holdoff in half-field increments until the oscilloscope triggers on only one phase of the color burst.

A quick way to synchronize to the other phase is to briefly disconnect the signal and then reconnect it. Repeat until the correct phase is displayed.

When holdoff is adjusted using the **Field Holdoff** softkey and the Entry knob, the corresponding holdoff time will be displayed in the Trigger Mode and Coupling Menu.

**Table 4** Half-field holdoff time

Standard	Time
NTSC	8.35 ms
PAL	10 ms
PAL-M	10 ms
SECAM	10 ms
Generic	8.35 ms
EDTV 480p/60	8.35 ms
EDTV 567p/50	10 ms
HDTV 720p/50	10 ms
HDTV 720p/60	8.35 ms
HDTV 1080p/24	20.835 ms
HDTV 1080p/25	20 ms
HDTV 1080p/30	20 ms
HDTV 1080p/50	16.67 ms
HDTV 1080p/60	8.36 ms
HDTV 1080i/50	10 ms
HDTV 1080i/60	8.35 ms



**Figure 33** Using Field Holdoff to Synchronize to Color Field 1 or 3 (Field 1 mode)

## Serial Trigger

With serial decode option licenses (see **“Serial Decode Options”** on page 149), you can enable serial trigger types. To set up these triggers, see:

- **“ARINC 429 Triggering”** on page 489
- **“CAN/CAN FD Triggering”** on page 399
- **“CXPI Triggering”** on page 418
- **“FlexRay Triggering”** on page 428
- **“I2C Triggering”** on page 438
- **“I2S Triggering”** on page 458
- **“LIN Triggering”** on page 409
- **“Manchester Triggering”** on page 468
- **“MIL-STD-1553 Triggering”** on page 483
- **“NRZ Triggering”** on page 475
- **“SENT Triggering”** on page 502

- **"SPI Triggering"** on page 449
- **"UART/RS232 Triggering"** on page 513

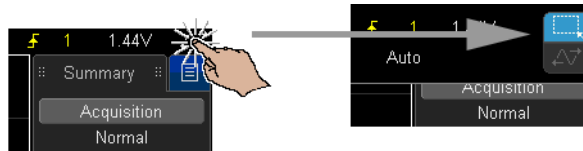
## Zone Qualified Trigger

The zone qualified trigger feature gives you one or two rectangular areas, Zone 1 and Zone 2, that a waveform must either intersect or not intersect in order for an acquisition to be displayed and stored in memory.

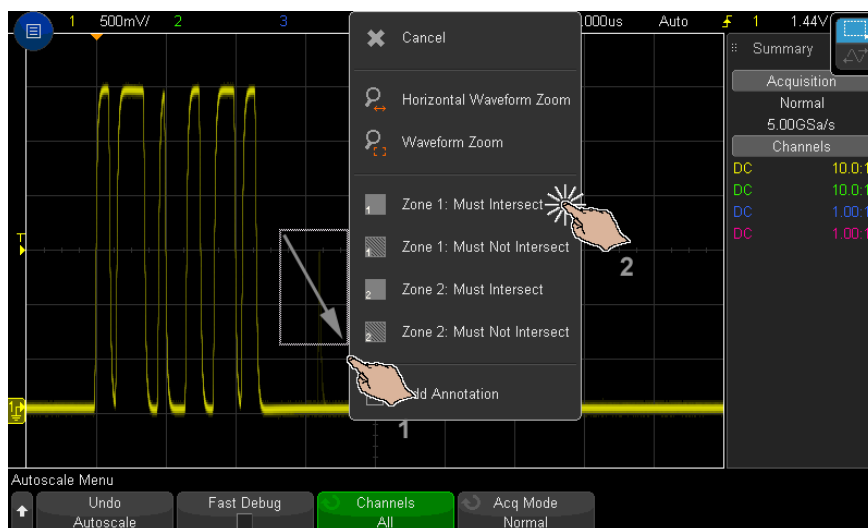
The zone qualified trigger feature works on top of the oscilloscope's hardware trigger, which determines the acquisitions whose waveforms are evaluated for zone intersection.

To set up a zone qualified trigger:

- 1 Touch the upper-right corner to select the rectangle draw mode.



- 2 Drag your finger (or connected USB mouse pointer) across the screen to draw a rectangular zone that the waveform must either intersect or not intersect.
- 3 Take your finger off the screen (or release the mouse button).
- 4 In the popup menu, select whether the rectangle is Zone 1 or Zone 2 and whether it is a "Must Intersect" or "Must Not Intersect" zone.



The **[Zone]** key becomes lit to show the zone qualified trigger feature is enabled.

- 5 In the Zone Qualified Trigger Menu, press the **Source** softkey and select the analog channel input source that both zones are associated with.



Zone colors match the selected analog input channel. "Must Not Intersect" zones are shaded differently than the solid "Must Intersect" zones.

The zone qualified trigger source does not have to be the same as the hardware trigger source.

- 6 You can use the **Zone 1 On** and **Zone 2 On** softkeys to disable or enable zones, and you can use the **Zone 1** and **Zone 2** softkeys to toggle between the "Must Intersect" and "Must Not Intersect" conditions.

Disabling both zones disables the zone qualified trigger feature. When the zone qualified trigger feature is enabled, at least one zone must be enabled.

You can press the **[Zone]** key to disable or re-enable the zone qualified trigger.

When two non-overlapping zones are used, their conditions are ANDed to become the final qualifying condition.

When two overlapping zones have the must intersect condition, the zones are ORed. When two overlapping zones have different conditions, Zone 1 takes precedence and Zone 2 is not used. In this case, Zone 2 will have no fill (that is, neither solid nor shaded) to indicate that it is not being used.

The zone qualified trigger feature is incompatible with, and will disable, the XY and Roll horizontal time modes and the Averaging acquisition mode.

### NOTE

Keep in mind that the TRIG OUT signal comes from the oscilloscope's hardware trigger. The TRIG OUT signal indicates when there is a trigger (acquisition) that is evaluated for zone intersection, not when an acquisition meets the zone qualification and is plotted on the oscilloscope's display.

---

# 12 Trigger Mode/Coupling

To select the Auto or Normal trigger mode / 208

To select the trigger coupling / 209

To enable or disable trigger noise rejection / 211

To enable or disable trigger HF Reject / 211

To set the trigger holdoff / 212

External Trigger Input / 213

To access the Trigger Mode and Coupling Menu:

- In the Trigger section of the front panel, press the **[Mode/Coupling]** key.



## Noisy Signals

If the signal you are probing is noisy, you can set up the oscilloscope to reduce the noise in the trigger path and on the displayed waveform. First, stabilize the displayed waveform by removing the noise from the trigger path. Second, reduce the noise on the displayed waveform.

- 1 Connect a signal to the oscilloscope and obtain a stable display.
- 2 Remove the noise from the trigger path by turning on high-frequency rejection ("**To enable or disable trigger HF Reject**" on page 211), low-frequency rejection ("**To select the trigger coupling**" on page 209), or "**To enable or disable trigger noise rejection**" on page 211.
- 3 Use "**Averaging Acquisition Mode**" on page 225 to reduce noise on the displayed waveform.

## To select the Auto or Normal trigger mode

When the oscilloscope is running, the trigger mode tells the oscilloscope what to do when triggers are not occurring.

In the **Auto** trigger mode (the default setting), if the specified trigger conditions are not found, triggers are forced and acquisitions are made so that signal activity is displayed on the oscilloscope.

In the **Normal** trigger mode, triggers and acquisitions only occur when the specified trigger conditions are found.

To select the trigger mode:

- 1 Press the **[Mode/Coupling]** key.
- 2 In the Trigger Mode and Coupling Menu, press the **Mode** softkey; then select either **Auto** or **Normal**.

You can also make this selection using the touchscreen. See **“Access the Trigger Menu, Change the Trigger Mode, and Open the Trigger Level Dialog”** on page 57.

See the following **“When to Use Auto Trigger Mode”** on page 209 and **“When to Use Normal Trigger Mode”** on page 209 descriptions.

You can also configure the **[Quick Action]** key to toggle between the Auto and Normal trigger modes. See **“Configuring the [Quick Action] Key”** on page 357.

### Triggering and the Pre- and Post-Trigger Buffers

After the oscilloscope starts running (after pressing **[Run]** or **[Single]** or changing the trigger condition), the oscilloscope first fills the pre-trigger buffer. Then, after the pre-trigger buffer is filled, the oscilloscope starts searching for a trigger, and sampled data continues to flow data through the pre-trigger buffer in a first-in first-out (FIFO) manner.

When a trigger is found, the pre-trigger buffer contains the events that occurred just before the trigger. Then, the oscilloscope fills the post-trigger buffer and displays the acquisition memory. If the acquisition was initiated by **[Run/Stop]**, the process repeats. If the acquisition was initiated by pressing **[Single]**, the acquisition stops (and you can Pan and Zoom the waveform).

In either Auto or Normal trigger mode, a trigger may be missed if the event occurs while the pre-trigger buffer is being filled. This may be more likely, for example, when the horizontal scale knob is set to a slow time/div setting, such as 500 ms/div.



**Trigger Indicator** The trigger indicator at the top right of the display shows whether triggers are occurring.

In the **Auto** trigger mode, the trigger indicator can show:

- **Auto?**— the trigger condition is not found (after the pre-trigger buffer has filled), and forced triggers and acquisitions are occurring.
- **Auto** — the trigger condition is found (or the pre-trigger buffer is being filled).

In the **Normal** trigger mode, the trigger indicator can show:

- **Trig'd?**— the trigger condition is not found (after the pre-trigger buffer has filled), and no acquisitions are occurring.
- **Trig'd**— trigger condition is found (or pre-trigger buffer is being filled).

When the oscilloscope is not running, the trigger indicator area shows **Stop**.

#### When to Use Auto Trigger Mode

The **Auto** trigger mode is appropriate when:

- Checking DC signals or signals with unknown levels or activity.
- When trigger conditions occur often enough that forced triggers are unnecessary.

#### When to Use Normal Trigger Mode

The **Normal** trigger mode is appropriate when:

- You only want to acquire specific events specified by the trigger settings.
- Triggering on an infrequent signal from a serial bus (for example, I2C, SPI, CAN, LIN, etc.) or another signal that arrives in bursts. The **Normal** trigger mode lets you stabilize the display by preventing the oscilloscope from auto-triggering.
- Making single-shot acquisitions with the **[Single]** key.

Often with single-shot acquisitions, you must initiate some action in the device under test, and you don't want the oscilloscope to auto-trigger before that happens. Before initiating the action in the circuit, wait for the trigger condition indicator **Trig'd?** to display (this tells you the pre-trigger buffer is filled).

#### See Also

- **"Forcing a Trigger"** on page 171
- **"To set the trigger holdoff"** on page 212
- **"To position the time reference (left, center, right, custom)"** on page 72

## To select the trigger coupling

- 1 Press the **[Mode/Coupling]** key.

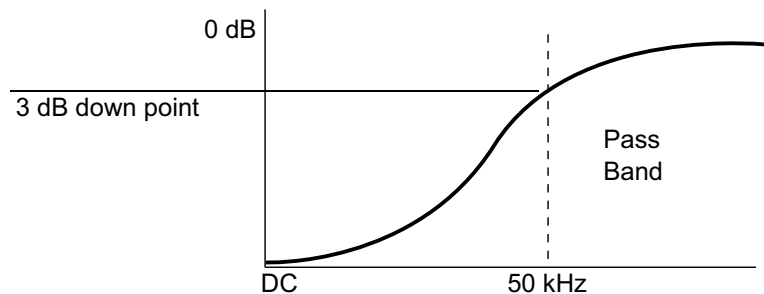
2 In the Trigger Mode and Coupling Menu, press the **Coupling** softkey; then, turn the Entry knob to select:

- **DC** coupling – allows DC and AC signals into the trigger path.
- **AC** coupling – places a 10 Hz high-pass filter in the trigger path removing any DC offset voltage from the trigger waveform.

The high-pass filter in the External Trigger input path is 50 Hz for all models.

Use AC coupling to get a stable edge trigger when your waveform has a large DC offset.

- **LF (low frequency) Reject** coupling – adds a high-pass filter with the 3-dB point at 50 kHz in series with the trigger waveform.



Low frequency reject removes any unwanted low frequency components from a trigger waveform, such as power line frequencies, etc., that can interfere with proper triggering.

Use **LF Reject** coupling to get a stable edge trigger when your waveform has low frequency noise.

- **Video** coupling – is normally grayed-out, but is automatically selected when Video trigger is enabled in the Trigger Menu.

Note that Trigger Coupling is independent of Channel Coupling (see **"To specify channel coupling"** on page 81).

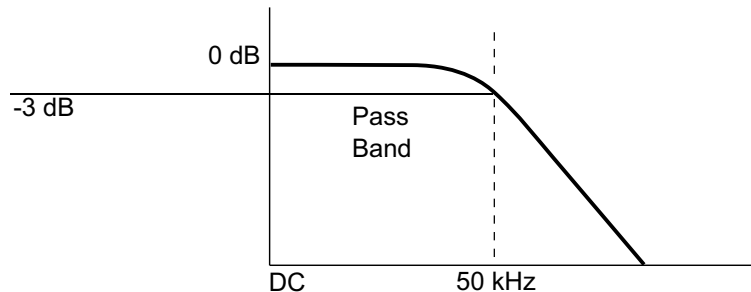
## To enable or disable trigger noise rejection

Noise Rej adds additional hysteresis to the trigger circuitry. By increasing the trigger hysteresis band, you reduce the possibility of triggering on noise. However, this also decreases the trigger sensitivity so that a slightly larger signal is required to trigger the oscilloscope.

- 1 Press the **[Mode/Coupling]** key.
- 2 In the Trigger Mode and Coupling Menu, press the **Noise Rej** softkey to enable or disable.

## To enable or disable trigger HF Reject

HF Reject adds a 50 kHz low-pass filter in the trigger path to remove high frequency components from the trigger waveform.



You can use HF Reject to remove high-frequency noise, such as AM or FM broadcast stations or noise from fast system clocks, from the trigger path.

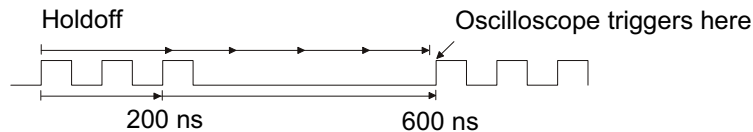
- 1 Press the **[Mode/Coupling]** key.
- 2 In the Trigger Mode and Coupling Menu, press the **HF Reject** softkey to enable or disable.

## To set the trigger holdoff

Trigger holdoff sets the amount of time the oscilloscope waits after a trigger before re-arming the trigger circuitry.

Use the holdoff to trigger on repetitive waveforms that have multiple edges (or other events) between waveform repetitions. You can also use holdoff to trigger on the first edge of a burst when you know the minimum time between bursts.

For example, to get a stable trigger on the repetitive pulse burst shown below, set the holdoff time to be  $>200$  ns but  $<600$  ns.



To set the trigger holdoff:

- 1 Press the **[Mode/Coupling]** key.
- 2 In the Trigger Mode and Coupling Menu, press **Holdoff**.
- 3 In the Trigger Holdoff Menu, press the **Random** softkey to enable or disable the random trigger holdoff mode.

The random trigger holdoff mode ensures that the oscilloscope re-arms after each acquisition in a manner that minimizes or eliminates the likelihood of triggering at the beginning of a DDR burst. Randomizing the holdoff time increases the likelihood that the oscilloscope will trigger on different data phases of a multi-phase (8 data transfer) burst. This mode mixes up the traffic pattern the oscilloscope triggers on and is very effective when used on repeating patterns.

- 4 If random trigger holdoff is disabled, use the **Holdoff** softkey to enter the trigger holdoff time.

If random trigger holdoff is enabled, use the **Min** and **Max** softkeys to enter the minimum and maximum trigger holdoff times.

### Trigger Holdoff Operating Hints

The correct holdoff setting is typically slightly less than one repetition of the waveform. Set the holdoff to this time to generate a unique trigger point for a repetitive waveform.


Changing the time base settings does not affect the trigger holdoff time.

With Keysight's MegaZoom technology, you can press **[Stop]**, then pan and zoom through the data to find where the waveform repeats. Measure this time using cursors; then, set the holdoff.

## External Trigger Input

The external trigger input can be used as a source in several of the trigger types. The external trigger BNC input is labeled **EXT TRIG IN**.

### CAUTION

 Maximum voltage at oscilloscope external trigger input

300 Vrms, 400 Vpk

1M ohm input: For steady-state sinusoidal waveforms derate at 20 dB/decade above 100 kHz to a minimum of 5 Vpk

The external trigger input impedance is 1M Ohm. This lets you use passive probes for general-purpose measurements. The higher impedance minimizes the loading effect of the oscilloscope on the device under test.

To set the EXT TRIG IN units and probe attenuation:

- 1 Press the **[Mode/Coupling]** key in the Trigger section of the front panel.



- 2 In the Trigger Mode and Coupling Menu, press the **External** softkey.



- 3 In the External Trigger Menu, press the **Units** softkey to select between:
  - **Volts** – for a voltage probe.
  - **Amps** – for a current probe.

## 12 Trigger Mode/Coupling

Measurement results, channel sensitivity, and the trigger level will reflect the measurement units you have selected.

- 4 Press the **Probe** softkey; then, turn the Entry knob to specify the probe attenuation.

The attenuation factor can be set from 0.001:1 to 10000:1 in a 1-2-5 sequence.

The probe attenuation factor must be set properly for measurements to be made correctly.

# 13 Acquisition Control

Running, Stopping, and Making Single Acquisitions (Run Control) / 215

Overview of Sampling / 217

Selecting the Acquisition Mode / 221

Realtime Sampling Option / 227

Acquiring to Segmented Memory / 229

This chapter shows how to use the oscilloscope's acquisition and run controls.

## Running, Stopping, and Making Single Acquisitions (Run Control)

There are two front panel keys for starting and stopping the oscilloscope's acquisition system: **[Run/Stop]** and **[Single]**.

- When the **[Run/Stop]** key is green, the oscilloscope is running, that is, acquiring data when trigger conditions are met.

To stop acquiring data, press **[Run/Stop]**. When stopped, the last acquired waveform is displayed.

- When the **[Run/Stop]** key is red, data acquisition is stopped.

"Stop" is displayed next to the trigger type in the status line at the top of the display.

To start acquiring data, press **[Run/Stop]**.

- To capture and display a single acquisition (whether the oscilloscope is running or stopped), press **[Single]**.

The **[Single]** run control lets you view single-shot events without subsequent waveform data overwriting the display. Use **[Single]** when you want maximum memory depth for pan and zoom.

When you press **[Single]**, the trigger mode is temporarily set to Normal (to keep the oscilloscope from auto-triggering immediately), the trigger circuitry is armed, the **[Single]** key is illuminated, and the oscilloscope waits until a trigger condition occurs before it displays a waveform.

When the oscilloscope triggers, the single acquisition is displayed and the oscilloscope is stopped (the **[Run/Stop]** key is illuminated in red). Press **[Single]** again to acquire another waveform.

If the oscilloscope doesn't trigger, you can press the **[Force Trigger]** key to trigger on anything and make a single acquisition.

To display the results of multiple acquisitions, use persistence. See **"To set or clear persistence"** on page 157.

#### Single vs. Running and Record Length

The maximum data record length is greater for a single acquisition than when the oscilloscope is running (or when the oscilloscope is stopped after running):

- **Single** – Single acquisitions always use the maximum memory available – at least twice as much memory as acquisitions captured when running – and the oscilloscope stores at least twice as many samples. At slower time/div settings, because there is more memory available for a single acquisition, the acquisition has a higher effective sample rate.
- **Running** – When running (versus taking a single acquisition), the memory is divided in half. This lets the acquisition system acquire one record while processing the previous acquisition, dramatically improving the number of waveforms per second processed by the oscilloscope. When running, a high waveform update rate provides the best representation of your input signal.

To acquire data with the longest possible record length, press the **[Single]** key.

For more information on settings that affect record length, see **"Length Control"** on page 326.



## Overview of Sampling

To understand the oscilloscope's sampling and acquisition modes, it is helpful to understand sampling theory, aliasing, oscilloscope bandwidth and sample rate, oscilloscope rise time, oscilloscope bandwidth required, and how memory depth affects sample rate.

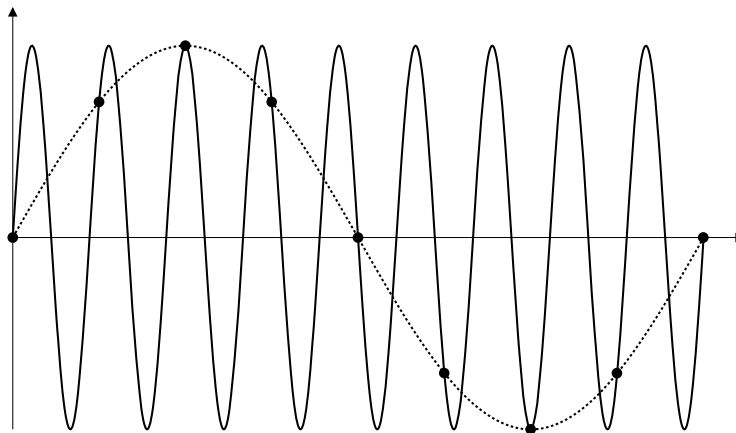
### Sampling Theory

The Nyquist sampling theorem states that for a limited bandwidth (band-limited) signal with maximum frequency  $f_{MAX}$ , the equally spaced sampling frequency  $f_S$  must be greater than twice the maximum frequency  $f_{MAX}$ , in order to have the signal be uniquely reconstructed without aliasing.

$$f_{MAX} = f_S/2 = \text{Nyquist frequency } (f_N) = \text{folding frequency}$$

### Aliasing

Aliasing occurs when signals are under-sampled ( $f_S < 2f_{MAX}$ ). Aliasing is the signal distortion caused by low frequencies falsely reconstructed from an insufficient number of sample points.

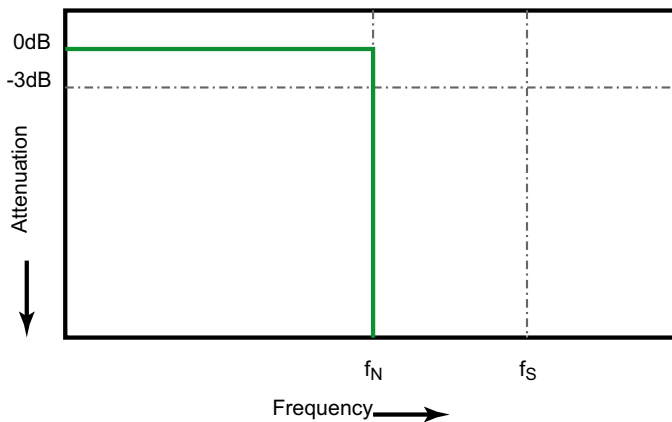


**Figure 34** Aliasing

## Oscilloscope Bandwidth and Sample Rate

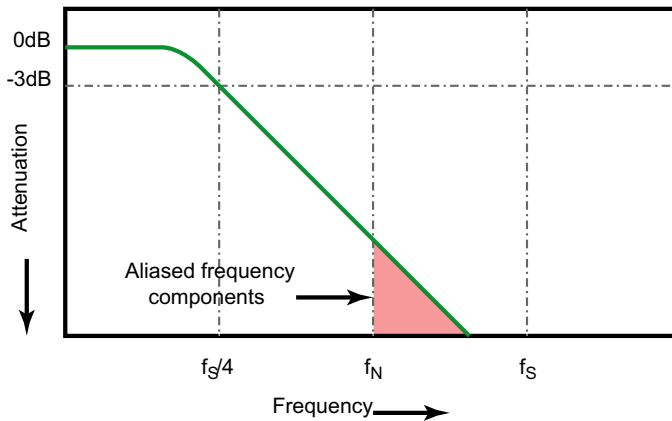
An oscilloscope's bandwidth is typically described as the lowest frequency at which input signal sine waves are attenuated by 3 dB (-30% amplitude error).

At the oscilloscope bandwidth, sampling theory says the required sample rate is  $f_s = 2f_{BW}$ . However, the theory assumes there are no frequency components above  $f_{MAX}$  ( $f_{BW}$  in this case) and it requires a system with an ideal brick-wall frequency response.



**Figure 35** Theoretical Brick-Wall Frequency Response

However, digital signals have frequency components above the fundamental frequency (square waves are made up of sine waves at the fundamental frequency and an infinite number of odd harmonics), and typically, for 500 MHz bandwidths and below, oscilloscopes have a Gaussian frequency response.



Limiting oscilloscope bandwidth (fbw) to 1/4 the sample rate ( $f_s/4$ ) reduces frequency components above the Nyquist frequency ( $f_N$ ).

**Figure 36** Sample Rate and Oscilloscope Bandwidth

So, in practice, an oscilloscope's sample rate should be four or more times its bandwidth:  $f_s = 4f_{BW}$ . This way, there is less aliasing, and aliased frequency components have a greater amount of attenuation.

Note that 1.5 GHz bandwidth 3000T X-Series oscilloscope models have more of a brick-wall type frequency response than the Gaussian response of lower bandwidth 3000T X-Series oscilloscope models. To understand the characteristics of each type of oscilloscope frequency response, see *Understanding Oscilloscope Frequency Response and Its Effect on Rise-Time Accuracy*, Keysight Application Note 1420

(<http://literature.cdn.keysight.com/litweb/pdf/5988-8008EN.pdf>).

**See Also** *Evaluating Oscilloscope Sample Rates vs. Sampling Fidelity: How to Make the Most Accurate Digital Measurements*, Keysight Application Note 1587  
(<http://literature.cdn.keysight.com/litweb/pdf/5989-5732EN.pdf>)

## Oscilloscope Rise Time

Closely related to an oscilloscope's bandwidth specification is its rise time specification. Oscilloscopes with a Gaussian-type frequency response have an approximate rise time of  $0.35/f_{BW}$  based on a 10% to 90% criterion.

An oscilloscope's rise time is not the fastest edge speed that the oscilloscope can accurately measure. It is the fastest edge speed the oscilloscope can possibly produce.

## Oscilloscope Bandwidth Required

The oscilloscope bandwidth required to accurately measure a signal is primarily determined by the signal's rise time, not the signal's frequency. You can use these steps to calculate the oscilloscope bandwidth required:

- 1 Determine the fastest edge speeds.

You can usually obtain rise time information from published specifications for devices used in your designs.

- 2 Compute the maximum "practical" frequency component.

From Dr. Howard W. Johnson's book, *High-Speed Digital Design – A Handbook of Black Magic*, all fast edges have an infinite spectrum of frequency components. However, there is an inflection (or "knee") in the frequency spectrum of fast edges where frequency components higher than  $f_{\text{knee}}$  are insignificant in determining the shape of the signal.

$$f_{\text{knee}} = 0.5 / \text{signal rise time (based on 10\% - 90\% thresholds)}$$

$$f_{\text{knee}} = 0.4 / \text{signal rise time (based on 20\% - 80\% thresholds)}$$

- 3 Use a multiplication factor for the required accuracy to determine the oscilloscope bandwidth required.

Required accuracy	Oscilloscope band width required
20%	$f_{\text{BW}} = 1.0 \times f_{\text{knee}}$
10%	$f_{\text{BW}} = 1.3 \times f_{\text{knee}}$
3%	$f_{\text{BW}} = 1.9 \times f_{\text{knee}}$

**See Also** *Choosing an Oscilloscope with the Right Bandwidth for your Application*, Keysight Application Note 1588  
<http://literature.cdn.keysight.com/litweb/pdf/5989-5733EN.pdf>

## Memory Depth and Sample Rate

The number of points of oscilloscope memory is fixed, and there is a maximum sample rate associated with oscilloscope's analog-to-digital converter; however, the actual sample rate is determined by the time of the acquisition (which is set according to the oscilloscope's horizontal time/div scale).

$$\text{sample rate} = \text{number of samples} / \text{time of acquisition}$$

For example, when storing 50  $\mu\text{s}$  of data in 50,000 points of memory, the actual sample rate is 1 GSa/s.

Likewise, when storing 50 ms of data in 50,000 points of memory, the actual sample rate is 1 MSa/s.

The actual sample rate is displayed in the Summary box in the right-side information area.

The oscilloscope achieves the actual sample rate by throwing away (decimating) unneeded samples.

## Selecting the Acquisition Mode

When selecting the oscilloscope acquisition mode, keep in mind that samples are normally decimated at slower time/div settings.

At slower time/div settings, the effective sample rate drops (and the effective sample period increases) because the acquisition time increases and the oscilloscope's digitizer is sampling faster than is required to fill memory.

For example, suppose an oscilloscope's digitizer has a sample period of 1 ns (maximum sample rate of 1 GSa/s) and a 1 M memory depth. At that rate, memory is filled in 1 ms. If the acquisition time is 100 ms (10 ms/div), only 1 of every 100 samples is needed to fill memory.

To select the acquisition mode:

- 1 Press the **[Acquire]** key on the front panel.
- 2 In the Acquire Menu, press the **Acq Mode** softkey; then, turn the Entry knob to select the acquisition mode.

The InfiniiVision oscilloscopes have the following acquisition modes:

- **Normal** – at slower time/div settings, normal decimation occurs, and there is no averaging. Use this mode for most waveforms. See **“Normal Acquisition Mode”** on page 222.
- **Peak Detect** – at slower time/div settings, the maximum and minimum samples in the effective sample period are stored. Use this mode for displaying narrow pulses that occur infrequently. See **“Peak Detect Acquisition Mode”** on page 222.
- **Averaging** – at all time/div settings, the specified number of triggers are averaged together. Use this mode for reducing noise and increasing resolution of periodic signals without bandwidth or rise time degradation. See **“Averaging Acquisition Mode”** on page 225.
- **High Resolution** – at slower time/div settings, all samples in the effective sample period are averaged and the average value is stored. Use this mode for reducing random noise. See **“High Resolution Acquisition Mode”** on page 227.

## Normal Acquisition Mode

In Normal mode at slower time/div settings, extra samples are decimated (in other words, some are thrown away). This mode yields the best display for most waveforms.

## Peak Detect Acquisition Mode

In Peak Detect mode at slower time/div settings, minimum and maximum samples are kept in order to capture infrequent and narrow events (at the expense of exaggerating any noise). This mode displays all pulses that are at least as wide as the sample period.

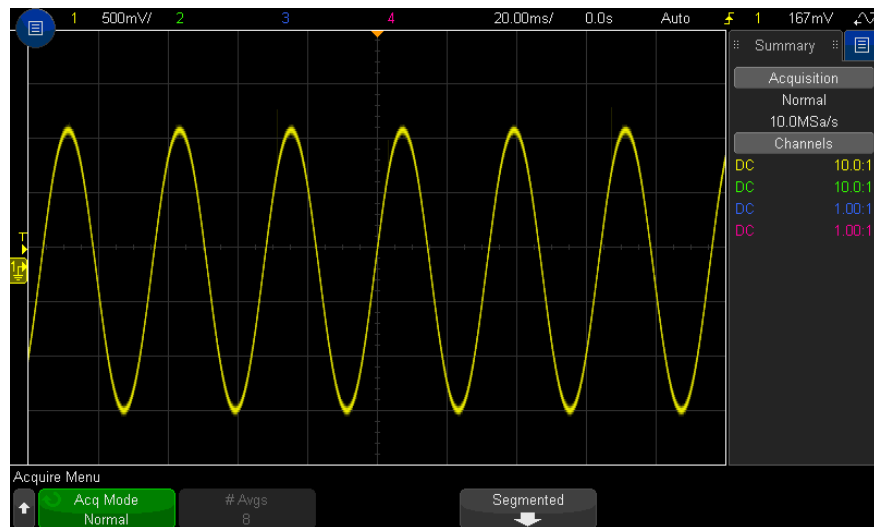
For InfiniiVision 3000T X-Series oscilloscopes, which have a maximum sample rate of 5 GSa/s, a sample is taken every 200 ps (sample period).

- See Also
- **“Glitch or Narrow Pulse Capture”** on page 223
  - **“Using Peak Detect Mode to Find a Glitch”** on page 224

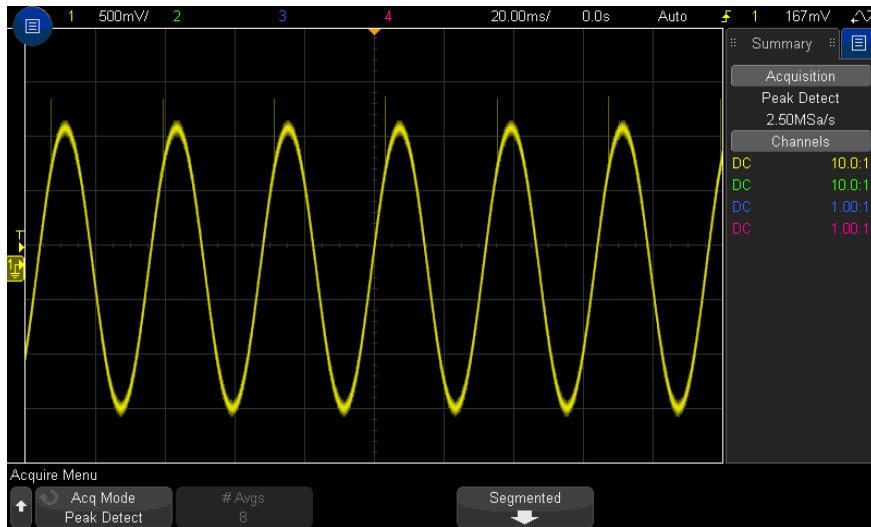
## Glitch or Narrow Pulse Capture

A glitch is a rapid change in the waveform that is usually narrow as compared to the waveform. Peak detect mode can be used to more easily view glitches or narrow pulses. In peak detect mode, narrow glitches and sharp edges are displayed more brightly than when in Normal acquire mode, making them easier to see.

To characterize the glitch, use the cursors or the automatic measurement capabilities of the oscilloscope.



**Figure 37** Sine With Glitch, Normal Mode



**Figure 38** Sine With Glitch, Peak Detect Mode

### Using Peak Detect Mode to Find a Glitch

- 1 Connect a signal to the oscilloscope and obtain a stable display.
- 2 To find the glitch, press the **[Acquire]** key; then, press the **Acq Mode** softkey until **Peak Detect** is selected.
- 3 Press the **[Display]** key then press the  $\infty$  **Persistence** (infinite persistence) softkey.

Infinite persistence updates the display with new acquisitions but does not erase previous acquisitions. New sample points are shown at normal intensity while previous acquisitions are displayed at reduced intensity. Waveform persistence is not kept beyond the display area boundary.

Press the **Clear Display** softkey to erase previously acquired points. The display will accumulate points until  $\infty$  **Persistence** is turned off.

- 4 Characterize the glitch with Zoom mode:
  - a Press the  $\odot$  zoom key (or press the **[Horiz]** key and then the **Zoom** softkey).
  - b To obtain a better resolution of the glitch, expand the time base.



Use the horizontal position knob (◀▶) to pan through the waveform to set the expanded portion of the normal window around the glitch.

## Averaging Acquisition Mode

The Averaging mode lets you average multiple acquisitions together to reduce noise and increase vertical resolution (at all time/div settings). Averaging requires a stable trigger.

The number of averages can be set from 2 to 65536 in power-of-2 increments.

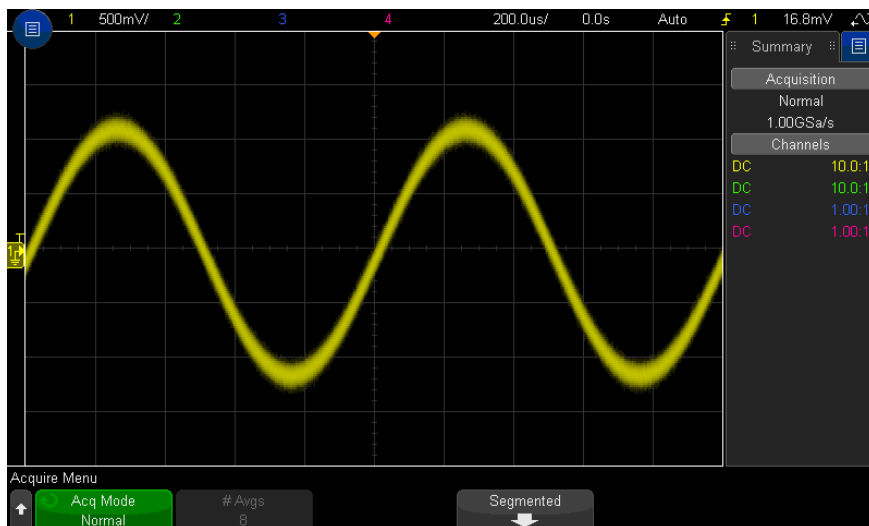
A higher number of averages reduces noise more and increases vertical resolution.

# Avgs	Bits of resolution
2	8
4	9
16	10
64	11
≥ 256	12

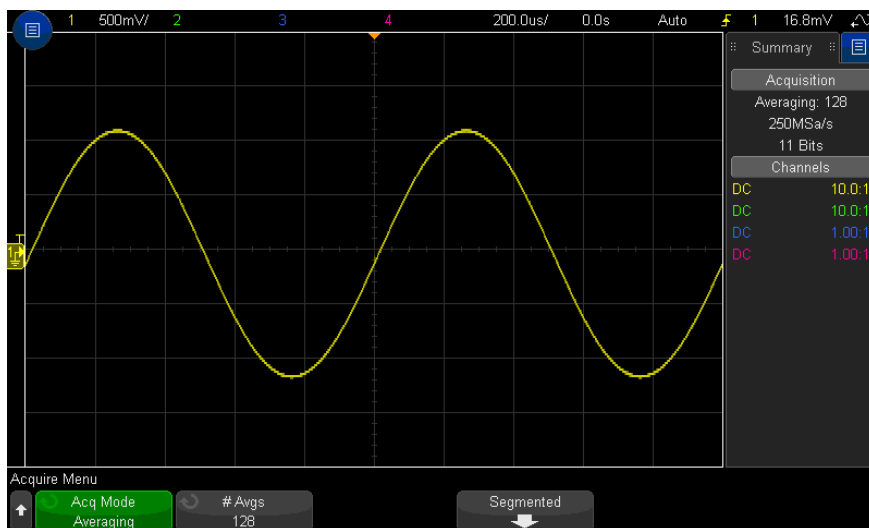
The higher the number of averages, the slower the displayed waveform responds to waveform changes. You must compromise between how quickly the waveform responds to changes and how much you want to reduce the displayed noise on the signal.

To use the Averaging mode:

- 1 Press the **[Acquire]** key, then press the **Acq Mode** softkey until the Averaging mode is selected.
- 2 Press the **#Avgs** softkey and turn the Entry knob to set the number of averages that best eliminates the noise from the displayed waveform. The number of acquisitions being averaged is displayed in the **# Avgs** softkey.



**Figure 39** Random noise on the displayed waveform



**Figure 40** 128 Averages used to reduce random noise

- See Also
- **Chapter 12**, “Trigger Mode/Coupling,” starting on page 207
  - **“Averaged Value”** on page 119

## High Resolution Acquisition Mode

In High Resolution mode, at slower time/div settings extra samples are averaged in order to reduce random noise, produce a smoother trace on the screen, and effectively increase vertical resolution.

High Resolution mode averages sequential sample points within the same acquisition. An extra bit of vertical resolution is produced for every factor of 2 averages. Random noise is reduced by  $\frac{1}{2}$  for every factor of 4 averages. The number of extra bits of vertical resolution is dependent on the time per division setting (sweep speed) of the oscilloscope.

The slower the time/div setting, the greater the number of samples that are averaged together for each display point.

High Resolution mode can be used on both single-shot and repetitive signals and it does not slow waveform update because the computation is done in the MegaZoom custom ASIC. High Resolution mode limits the oscilloscope's real-time bandwidth because it effectively acts like a low-pass filter.

Sweep speed	Bits of resolution
$\leq 1 \mu\text{s}/\text{div}$	8
$2 \mu\text{s}/\text{div}$	9
$5 \mu\text{s}/\text{div}$	10
$10 \mu\text{s}/\text{div}$	11
$\geq 20 \mu\text{s}/\text{div}$	12

## Realtime Sampling Option

With the 3000T X-Series 1 GHz and 1.5 GHz bandwidth models, you can turn off **Realtime** sampling and switch to equivalent time sampling. (Realtime sampling is always on for the lower bandwidth models, and there is no option for turning it off.)

This setting only has an effect when sweep speeds are 20 ns/div or faster. At slower sweep speeds, there are enough sample points in a trigger (acquisition, in other words) to render a waveform on the display.

Realtime sampling specifies that the oscilloscope produce the waveform display from samples collected during one trigger event (that is, one acquisition).

Use Realtime sampling to capture infrequent triggers, unstable triggers, or complex changing waveforms, such as eye diagrams.

When Realtime sampling is on (as in the default setup):

- When less than 1000 samples can be collected in the time spanned by the screen, a sophisticated reconstruction filter is used to fill-in and enhance the waveform display.
- If you press the **[Stop]** key, and pan and zoom through the waveform using the Horizontal and Vertical controls, only the last trigger's acquisition will be displayed.

When Realtime sampling is off (equivalent time mode):

- Instead of the reconstruction filter, a technique known as random repetitive sampling is used to build-up and draw one waveform using multiple triggers (acquisitions).
- Equivalent time sampling mode requires a repetitive waveform with a stable trigger.

**See Also** • ["Realtime Sampling and Oscilloscope Bandwidth"](#) on page 228

## Realtime Sampling and Oscilloscope Bandwidth

To accurately reproduce a sampled waveform, the sample rate should be at least 2.5 times the highest frequency component of the waveform. If not, it is possible for the reconstructed waveform to be distorted or aliased. Aliasing is most commonly seen as jitter on fast edges.

The maximum sample rate for the 3000T X-Series oscilloscopes is 5 GSa/s for a single channel in a channel pair. Channels 1 and 2 constitute a channel pair, and channels 3 and 4 constitute another channel pair. For example, the sample rate of a 4-channel oscilloscope is 5 GSa/s when channels 1 and 3, 1 and 4, 2 and 3, or 2 and 4 are on.

Whenever both channels in a channel pair are on, the sample rate for all channels is halved. For example, when channels 1, 2, and 3 are on, the sample rate for all channels is 2.5 GSa/s.

When Realtime sampling is on, the bandwidth of the oscilloscope is limited because the bandwidth of the reconstruction filter is set to  $f_s/4$ . For example, a MSOX410xA oscilloscope with channels 1 and 2 on has a bandwidth of 625 MHz when Realtime sampling on and 1 GHz when Realtime sampling is off.

The sample rate is displayed in the sidebar Summary dialog.

## Acquiring to Segmented Memory

When capturing multiple infrequent trigger events it is advantageous to divide the oscilloscope's memory into segments. This lets you capture signal activity without capturing long periods of signal inactivity.

Each segment is complete with all analog channel, digital channel (on MSO models), and serial decode data.

When using segmented memory, use the Analyze Segments feature (see [“Measurements, Statistics, and Infinite Persistence with Segmented Memory”](#) on page 231) to show infinite persistence across all acquired segments. See also [“To set or clear persistence”](#) on page 157 for details.

### To acquire to segmented memory

- 1 Set up a trigger condition. (See [Chapter 11](#), “Triggers,” starting on page 169 for details.)
- 2 Press the **[Acquire]** key in the Waveform section of the front panel.
- 3 Press the **Segmented** softkey.
- 4 In the Segmented Memory Menu, press the **Segmented** softkey to enable segmented memory acquisitions.
- 5 Press the **# of Segs** softkey and turn the Entry knob to select the number of segments into which you would like to divide the oscilloscope's memory.

Memory can be divided into as few as two segments and as many as 1000 segments, depending on the oscilloscope model.

- 6 Press the **[Run]** or **[Single]** key.

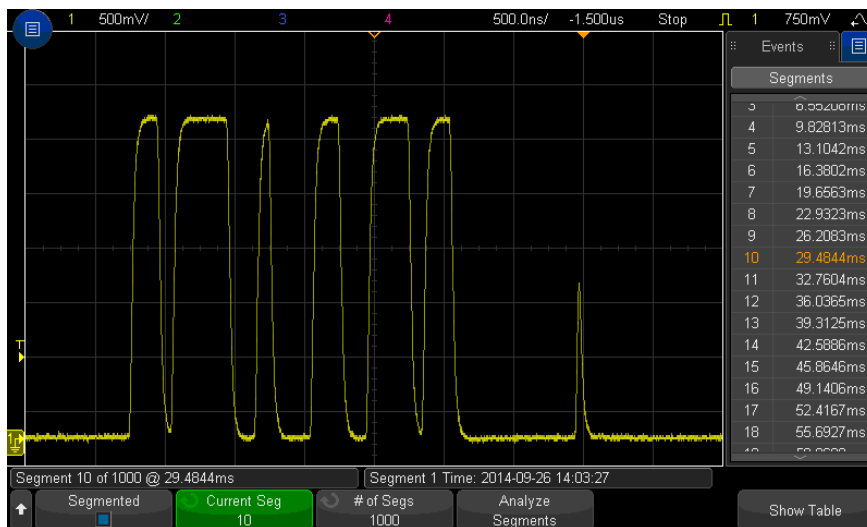
The oscilloscope runs and fills a memory segment for each trigger event. When the oscilloscope is busy acquiring multiple segments, the progress is displayed on screen. The oscilloscope continues to trigger until memory is filled, then the oscilloscope stops.

If the signal you are measuring has more than about 1 s of inactivity, consider selecting the **Normal** trigger mode to prevent AutoTriggering. See **"To select the Auto or Normal trigger mode"** on page 208.

- See Also
- **"Navigating Segments"** on page 230
  - **"Measurements, Statistics, and Infinite Persistence with Segmented Memory"** on page 231
  - **"Segmented Memory Re-Arm Time"** on page 231
  - **"Saving Data from Segmented Memory"** on page 231

## Navigating Segments

- 1 Press the **Current Seg** softkey and turn the Entry knob to display the desired segment along with a time tag indicating the time from the first trigger event.



You can also navigate segments using the **[Navigate]** key and controls. See **"To navigate segments"** on page 76.

## Measurements, Statistics, and Infinite Persistence with Segmented Memory

To perform measurements and view statistical information, press **[Meas]** and set up your desired measurements (see [Chapter 15](#), “Measurements,” starting on page 243). Then, press **Analyze Segments**. Statistical data will be accumulated for the measurements you have chosen.

The **Analyze Segments** softkey appears when the acquisition is stopped and the segmented memory feature is on or when the serial Lister is enabled.

You can also turn on infinite persistence (in the Display Menu) and press the **Analyze Segments** softkey to create an infinite persistence display.

## Segmented Memory Re-Arm Time

After each segment fills, the oscilloscope re-arms and is ready to trigger in about 1  $\mu$ s.

Remember though, for example: if the horizontal time per division control is set to 5  $\mu$ s/div, and the Time Reference is set to **Center**, it will take at least 50  $\mu$ s to fill all ten divisions and re-arm. (That is 25  $\mu$ s to capture pre-trigger data and 25  $\mu$ s to capture post-trigger data.)

## Saving Data from Segmented Memory

You can save either the currently displayed segment (**Save Segment - Current**), or all segments (**Save Segment - All**) in the following data formats: CSV, ASCII XY, and BIN.

Be sure to set the Length control to capture enough points to accurately represent the captured data. When the oscilloscope is busy saving multiple segments, progress is displayed in the upper right area of the display.

For more information, see [“To save CSV, ASCII XY, or BIN data files”](#) on page 324.





# 14 Cursors

To make cursor measurements / 234

Cursor Examples / 237

Cursors are horizontal and vertical markers that indicate X-axis values and Y-axis values on a selected waveform source. You can use cursors to make custom voltage, time, phase, or ratio measurements on oscilloscope signals.

Cursor information is displayed in the right-side information area.

Cursors are not always limited to the visible display. If you set a cursor, then pan and zoom the waveform until the cursor is off screen, its value will not be changed. It will still be there when you return to its original location.

**X Cursors** X cursors are vertical dashed lines that adjust horizontally and can be used to measure time (s), frequency (1/s), phase ( $^{\circ}$ ), and ratio (%).

The X1 cursor is the short-dashed vertical line, and the X2 cursor is the long-dashed vertical line.

When used with the FFT math function as a source, the X cursors indicate frequency.

In XY horizontal mode, the X cursors display channel 1 values (Volts or Amps).

The X1 and X2 cursor values for the selected waveform source are displayed in the softkey menu area.

The difference between X1 and X2 ( $\Delta X$ ) and  $1/\Delta X$  are displayed in the Cursors box in the right-side information area.

**Y Cursors** Y cursors are horizontal dashed lines that adjust vertically and can be used to measure Volts or Amps, dependent on the channel **Probe Units** setting, or they can measure ratios (%). When math functions are used as a source, the measurement units correspond to that math function.

The Y1 cursor is the short-dashed horizontal line and the Y2 cursor is the long-dashed horizontal line.

The Y cursors adjust vertically and typically indicate values relative to the waveform's ground point, except math FFT where the values are relative to 0 dB.

In XY horizontal mode, the Y cursors display channel 2 values (Volts or Amps).

When active, the Y1 and Y2 cursor values for the selected waveform source are displayed in the softkey menu area.

The difference between Y1 and Y2 ( $\Delta Y$ ) is displayed in the Cursors box in the right-side information area.

## To make cursor measurements

**1** Connect a signal to the oscilloscope and obtain a stable display.

**2** Press the **[Cursors]** key.

The Cursors box in the right-side information area appears, indicating that cursors are "on". (Press the **[Cursors]** key again when you want to turn cursors off.)

**3** In the Cursors Menu, press **Mode**; then, select the desired mode:

- **Manual** –  $\Delta X$ ,  $1/\Delta X$ , and  $\Delta Y$  values are displayed.  $\Delta X$  is the difference between the X1 and X2 cursors and  $\Delta Y$  is the difference between the Y1 and Y2 cursors.



- **Track Waveform** – As you move a marker horizontally, the vertical amplitude of the waveform is tracked and measured. The time and voltage positions are shown for the markers. The vertical (Y) and horizontal (X) differences between the markers are shown as  $\Delta X$  and  $\Delta Y$  values.
- **Measure** – When measurements are displayed, this mode shows the cursor locations used to make the measurement. When you add a measurement, it becomes the one that cursors are displayed for. You can use the **Measurement** softkey or touch in the Meas sidebar dialog to select the measurement whose cursor locations are displayed.

- **Binary** – Logic levels of displayed waveforms at the current X1 and X2 cursor positions are displayed in the Cursor sidebar dialog in binary. The display is color coded to match the color of the related channel's waveform.



- **Hex** – Logic levels of displayed waveforms at the current X1 and X2 cursor positions are displayed in the Cursor sidebar dialog in hexadecimal.



**Manual** and **Track Waveform** modes can be used on waveforms that are displayed on the analog input channels (including math functions).

**Binary** and **Hex** modes apply to digital signals (of MSO oscilloscope models).

In **Hex** and **Binary** modes, a level can be displayed as 1 (higher than trigger level), 0 (lower than trigger level), indeterminate state (-), or X (don't care).

In **Binary** mode, X is displayed if the channel is turned off.

In **Hex** mode, the channel is interpreted as 0 if turned off.

- 4 Press **Source** (or **X1 Source**, **X2 Source** in the **Track Waveform** mode); then, select the input source for cursor values.
- 5 Select the cursor(s) to be adjusted:
  - Push the Cursors knob; then, turn the Cursors knob. To finalize your selection, either push the Cursors knob again or wait about five seconds for the pop-up menu to disappear.

Or:

  - Press the **Cursors** softkey; then, turn the Entry knob.

The **X1 X2 linked** and **Y1 Y2 linked** selections let you adjust both cursors at the same time, while the delta value remains the same. This can be useful, for example, for checking pulse width variations in a pulse train.

The currently selected cursor(s) display brighter than the other cursors.

When individual cursors are selected, press the softkey to disable or reenable the cursor display.

- 6** To change the cursor units, press the **Units** softkey.

In the Cursor Units Menu:



You can press the **X Units** softkey to select:

- **Seconds (s)**.
- **Hz (1/s)**.
- **Phase (°)** – when selected, use the **Use X Cursors** softkey to set the current X1 location as 0 degrees and the current X2 location as 360 degrees.
- **Ratio (%)** – when selected, use the **Use X Cursors** softkey to set the current X1 location as 0% and the current X2 location as 100%.

You can press the **Y Units** softkey to select:

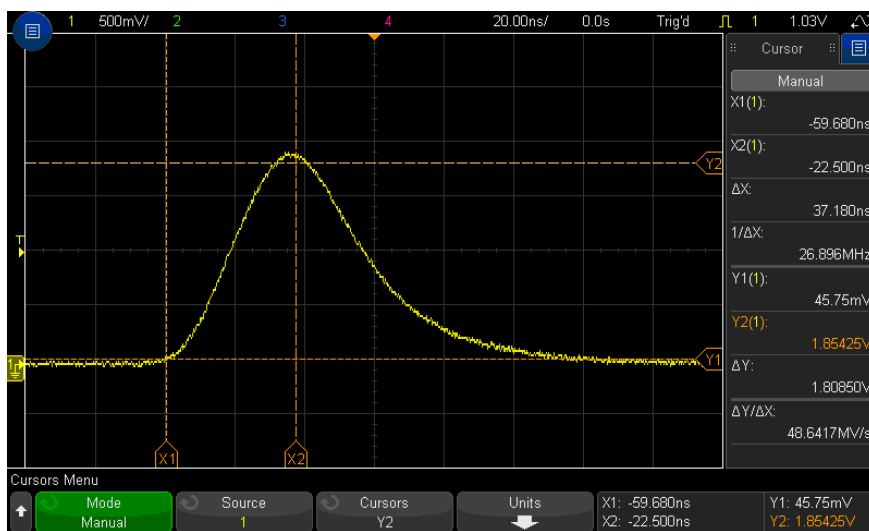
- **Base** – the same units used for the source waveform.
- **Ratio (%)** – when selected, use the **Use Y Cursors** softkey to set the current Y1 location as 0% and the current Y2 location as 100%.

For phase or ratio units, once the 0 and 360 degree or 0 and 100% locations are set, adjusting cursors will display measurements relative to the set locations.

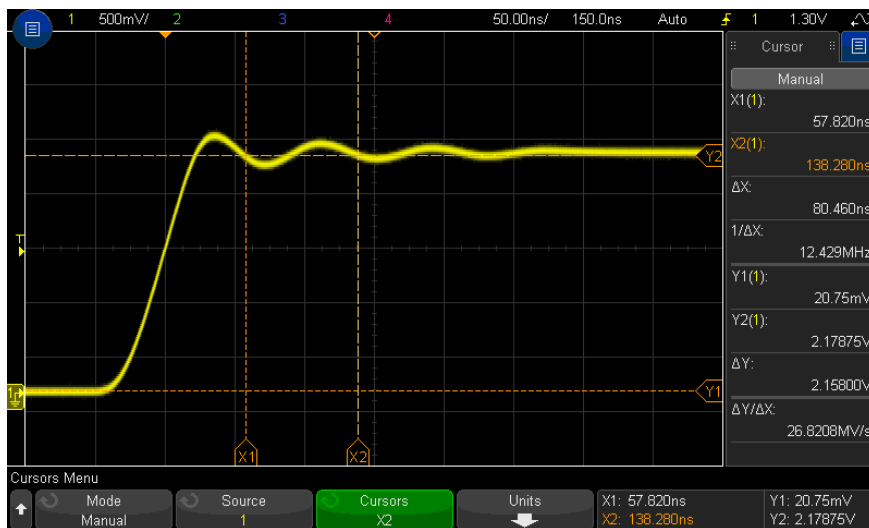
- 7** Adjust the selected cursor(s) by turning the Cursors knob.

You can also position cursors using the touchscreen. See **“Drag Cursors”** on page 51.

## Cursor Examples

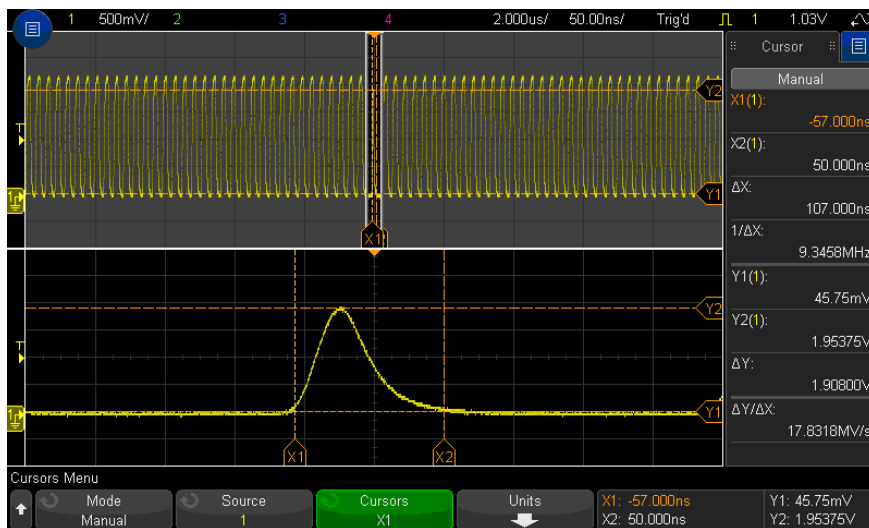


**Figure 41** Cursors used to measure pulse widths other than middle threshold points



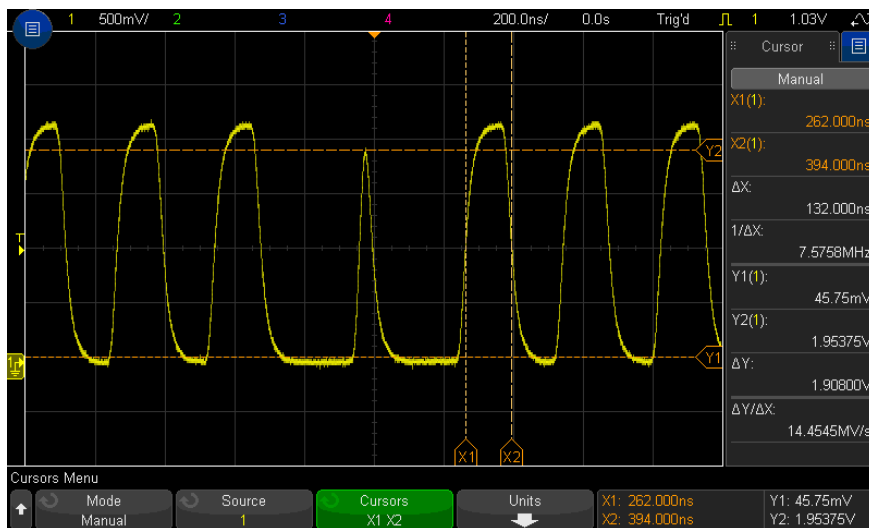
**Figure 42** Cursors measure frequency of pulse ringing

Expand the display with Zoom mode, then characterize the event of interest with the cursors.



**Figure 43** Cursors track Zoom window

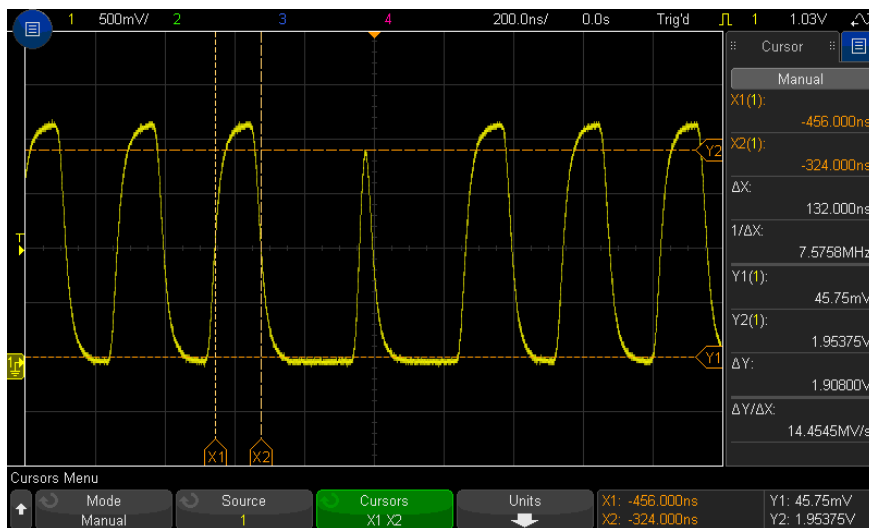
Put the **X1** cursor on one side of a pulse and the **X2** cursor on the other side of the pulse.



**Figure 44** Measuring pulse width with cursors

Press the **X1 X2 linked** softkey and move the cursors together to check for pulse width variations in a pulse train.





**Figure 45** Moving the cursors together to check pulse width variations



# 15 Measurements

To make automatic measurements / 244

To edit measurements / 246

Measurements Summary / 246

Voltage Measurements / 250

Time Measurements / 257

Count Measurements / 265

Mixed Measurements / 266

FFT Analysis Measurements / 267

Measurement Thresholds / 270

Measurement Window / 272

Measurement Statistics / 272

The **[Meas]** key lets you make automatic measurements on waveforms. Some measurements can only be made on analog input channels.

The results of the last eight selected measurements are displayed in the Measurements list dialog (which can be selected from the right-hand sidebar menu – see [“Select Sidebar Information or Controls”](#) on page 49 and [“Undock Sidebar Dialogs by Dragging”](#) on page 49).

When you add a measurement, it appears at the bottom of the Measurements list dialog, and cursors that show the portion of the waveform being measured are automatically displayed. You can change the measurement for which cursors are displayed by touching the measurement in the list and choosing **Track With Cursors** in the popup menu or by selecting the measurement in the Cursors Menu.

**NOTE****Post Acquisition Processing**

In addition to changing display parameters after the acquisition, you can perform all of the measurements and math functions after the acquisition. Measurements and math functions will be recalculated as you pan and zoom and turn channels on and off. As you zoom in and out on a signal using the horizontal scale knob and vertical volts/division knob, you affect the resolution of the display. Because measurements and math functions are performed on displayed data, you affect the resolution of functions and measurements.

## To make automatic measurements

- 1 Press the **[Meas]** key to display the Measurement Menu.



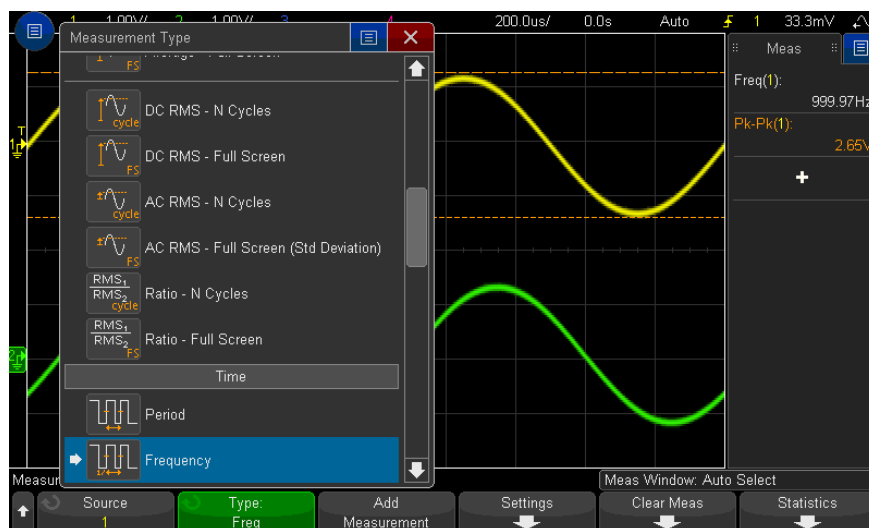
- 2 Press the **Add Meas** softkey to open the Add Measurements Menu.
- 3 If the **Parameter** softkey is available, select the **Source** parameter.  
The **Parameter** softkey is available when there are multiple settings for a measurements.
- 4 Press the **Source** softkey to select the channel, running math function, or reference waveform to be measured.

Only channels, math functions, or reference waveforms that are displayed are available for measurements.

**NOTE**

If a portion of the waveform required for a measurement is not displayed or does not display enough resolution to make the measurement (approximately 4% of full scale), the result will display "No Edges", "Clipped", "Low Signal" (not enough amplitude), "< value", or "> value", or a similar message to indicate that the measurement may not be reliable.

- 5 Press the **Type:** softkey; then, rotate the Entry knob to select a measurement to be made.



You can also use the touchscreen to select measurements. You can touch the "+" in the Measurements sidebar dialog to open the measurement type menu. See also ["Touch Softkeys and Menus On the Screen"](#) on page 51.

For more information on the types of measurements, see ["Measurements Summary"](#) on page 246.

- 6 The **Settings** softkey will be available to make additional measurement settings on some measurements.
- 7 Press the **Add Measurement** softkey or push the Entry knob to display the measurement.

Cursors are turned on to show the portion of the waveform being measured for the most recently added measurement (bottom-most on the display). To view the cursors for a previously added measurement (but not the last one), add the measurement again.

By default, measurement statistics are displayed. See ["Measurement Statistics"](#) on page 272.

- 8 To turn off measurements, press the **[Meas]** key again.  
Measurements are erased from the display.
- 9 To stop making one or more measurements, press the **Clear Meas** softkey and choose the measurement to clear, or press **Clear All**.



After all measurements have been cleared, when **[Meas]** is pressed again, the default measurements will be Frequency and Peak-Peak.

## To edit measurements

When added measurements have parameters that can be edited (like the Delay, Phase, Occupied Bandwidth, ACPR, or THD measurements), you can edit the parameters of those measurements.

- 1 Press the **[Meas]** key to display the Measurement Menu.
- 2 Press the **Edit Meas** softkey open the Edit Measurements Menu.
- 3 Press the **Select Measurement** softkey to select the measurement you would like to edit.
- 4 Press the **Parameter** softkey to select the parameter(s) you would like to edit; then, use the remaining softkeys to edit that parameter.

## Measurements Summary

The automatic measurements provided by the oscilloscope are listed in the following table. All measurements are available for analog channel waveforms. All measurements except Counter are available for reference waveforms and math waveforms other than FFT. A limited set of measurements is available for math FFT waveforms and for digital channel waveforms (as described in the following table).

Measurement	Valid for Math FFT*	Valid for Digital Channels	Notes
"Snapshot All" on page 249			
"Amplitude" on page 251			
"Area" on page 266			

Measurement	Valid for Math FFT*	Valid for Digital Channels	Notes
"Average" on page 254	Yes, Full Screen		
"Base" on page 252			
"Bit Rate" on page 261		Yes	
"Burst Width" on page 260			
"Counter" on page 259		Yes	Not valid for math waveforms.
"Delay" on page 261			Measures between two sources. Press <b>Settings</b> to specify the second source.
"Duty Cycle" on page 260		Yes	
"Fall Time" on page 261			
"Frequency" on page 258		Yes	
"Maximum" on page 251	Yes		
"Minimum" on page 251	Yes		
"Rising Edge Count" on page 266			
"Falling Edges Count" on page 266			
"Positive Pulse Count" on page 265			
"Negative Pulse Count" on page 265			
"Overshoot" on page 252			
"Peak-Peak" on page 251	Yes		
"Period" on page 258		Yes	
"Phase" on page 262			Measures between two sources. Press <b>Settings</b> to specify the second source.

Measurement	Valid for Math FFT*	Valid for Digital Channels	Notes
"Preshoot" on page 254			
"Ratio" on page 257			Measures between two sources. Press <b>Settings</b> to specify the second source.
"Rise Time" on page 261			
"DC RMS" on page 255			
"AC RMS" on page 255			
"Top" on page 251			
"+ Width" on page 260		Yes	
"- Width" on page 260		Yes	
"X at Max Y" on page 264	Yes		The resultant units are in Hertz.
"X at Min Y" on page 264	Yes		The resultant units are in Hertz.
* Use the cursors to make other measurements on FFT.			

#### Power App Measurements

Note that additional Power App measurements are available when the DSOX3PWR power measurement and analysis license is installed and the Power Application is enabled. For more information, see the *PWR Power Measurement Application User's Guide* at [www.keysight.com/find/3000TX-Series-manual](http://www.keysight.com/find/3000TX-Series-manual) or on the Documentation CD.

#### Dual-Channel (N2820A Probe) Measurements

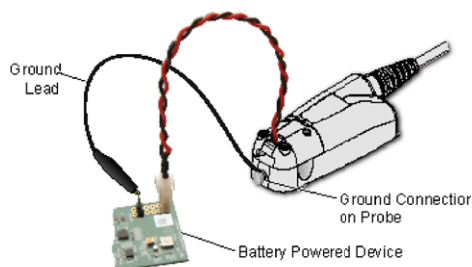
Note that additional measurements are available with the N2820A high-sensitivity current probe when both the Primary and Secondary probe cables are used. Zoom In waveform data below the probe's clamp level is joined with Zoom Out waveform data above the probe's clamp level to create the waveform on which the measurement is made. These measurements are only valid for analog input channels.

Dual-Channel (N2820A Probe) Measurement	Notes
Amplitude	See " <b>Amplitude</b> " on page 251.



Dual-Channel (N2820A Probe) Measurement	Notes
Charge	Charge (in Amp-hours) is the measured area under the waveform. See "Area" on page 266.
Average	See "Average" on page 254.
Base	See "Base" on page 252.
Peak-Peak	See "Peak-Peak" on page 251.
DC RMS	See "DC RMS" on page 255.
AC RMS	See "AC RMS" on page 255.

When using the N2820A probe to make measurements on a battery-powered (floating) device, always connect the supplied ground lead between ground on your device and the probe's ground connector as shown in the following figure. Simply snap the end of the ground lead onto the probe's connector. Without the ground connection, the probe's common-mode input amplifier cannot properly display waveforms.



**Figure 46** Measurements on Battery Powered Devices Using the N2820A Probe

## Snapshot All

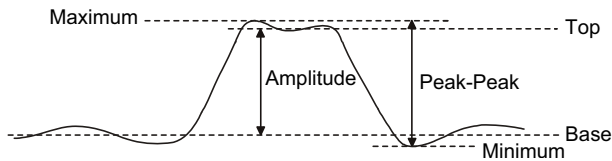
The Snapshot All measurement type displays a popup containing a snapshot of all the single waveform measurements.



You can also configure the **[Quick Action]** key to display the Snapshot All popup. See **“Configuring the [Quick Action] Key”** on page 357.

## Voltage Measurements

The following figure shows the voltage measurement points.



Measurement units for each input channel can be set to Volts or Amps using the channel **Probe Units** softkey. See **“To specify the channel units”** on page 85.

The units of math waveforms are described in **“Units for Math Waveforms”** on page 101.

- **“Peak-Peak”** on page 251
- **“Maximum”** on page 251

- **"Minimum"** on page 251
- **"Amplitude"** on page 251
- **"Top"** on page 251
- **"Base"** on page 252
- **"Overshoot"** on page 252
- **"Preshoot"** on page 254
- **"Average"** on page 254
- **"DC RMS"** on page 255
- **"AC RMS"** on page 255
- **"Ratio"** on page 257

## Peak-Peak

The peak-to-peak value is the difference between Maximum and Minimum values. The Y cursors show the values being measured.

## Maximum

Maximum is the highest value in the waveform display. The Y cursor shows the value being measured.

## Minimum

Minimum is the lowest value in the waveform display. The Y cursor shows the value being measured.

## Amplitude

The Amplitude of a waveform is the difference between its Top and Base values. The Y cursors show the values being measured.

## Top

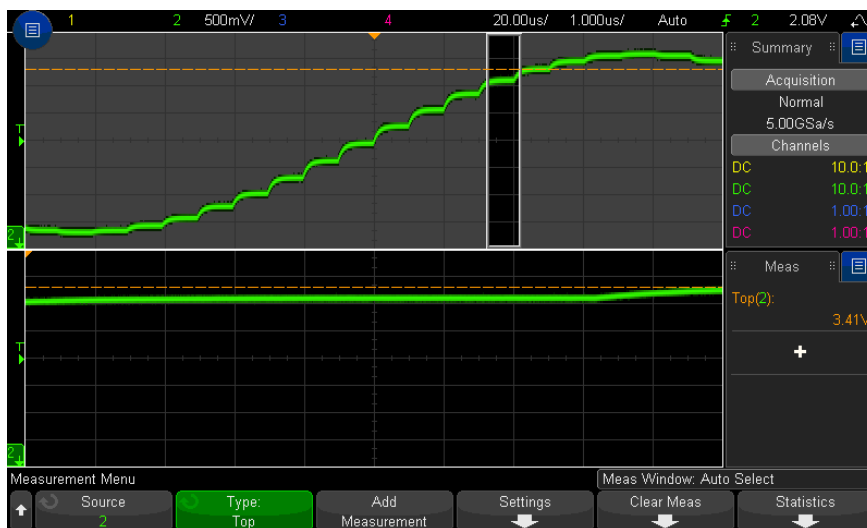
The Top of a waveform is the mode (most common value) of the upper part of the waveform, or if the mode is not well defined, the top is the same as Maximum. The Y cursor shows the value being measured.

**See Also** • **"To isolate a pulse for Top measurement"** on page 252

### To isolate a pulse for Top measurement

The following figure shows how to use Zoom mode to isolate a pulse for a **Top** measurement.

You may need to change the measurement window setting so that the measurement is made in the lower, Zoom window. See **“Measurement Window”** on page 272.



**Figure 47** Isolating area for Top measurement

### Base

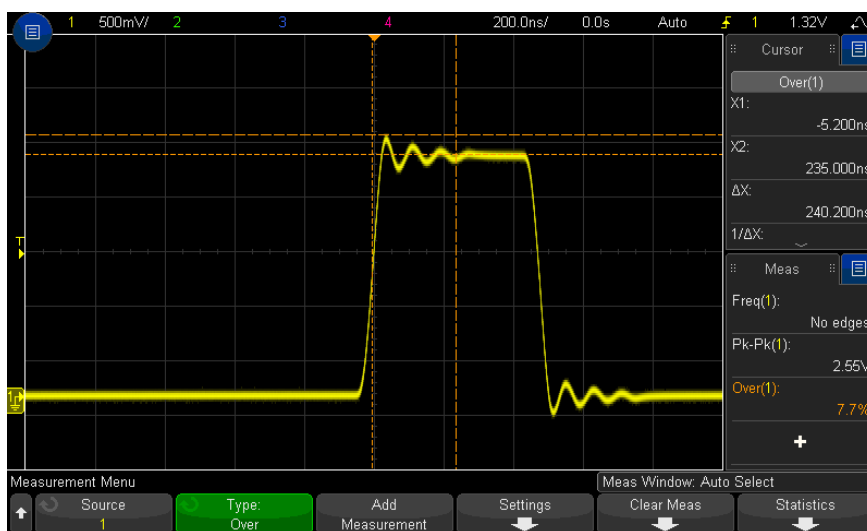
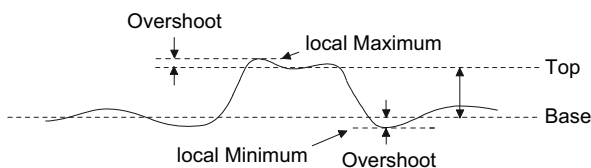
The Base of a waveform is the mode (most common value) of the lower part of the waveform, or if the mode is not well defined, the base is the same as Minimum. The Y cursor shows the value being measured.

### Overshoot

Overshoot is distortion that follows a major edge transition expressed as a percentage of Amplitude. The X cursors show which edge is being measured (edge closest to the trigger reference point).

$$\text{Rising edge overshoot} = \frac{\text{local Maximum} - \text{D Top}}{\text{Amplitude}} \times 100$$

$$\text{Falling edge overshoot} = \frac{\text{Base} - \text{D local Minimum}}{\text{Amplitude}} \times 100$$



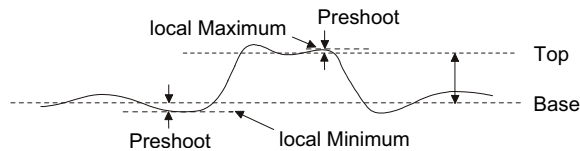
**Figure 48** Automatic Overshoot measurement

## Preshoot

Preshoot is distortion that precedes a major edge transition expressed as a percentage of Amplitude. The X cursors show which edge is being measured (edge closest to the trigger reference point).

$$\text{Rising edge preshoot} = \frac{\text{local Maximum} - \text{D Top}}{\text{Amplitude}} \times 100$$

$$\text{Falling edge preshoot} = \frac{\text{Base} - \text{D local Minimum}}{\text{Amplitude}} \times 100$$



## Average

Average is the sum of the levels of the waveform samples divided by the number of samples.

$$\text{Average} = \frac{\sum x_i}{n}$$

Where  $x_i$  = value at  $i$ th point being measured,  $n$  = number of points in measurement interval.

The Full Screen measurement interval variation measures the value on all displayed data points.

The N Cycles measurement interval variation measures the value on an integral number of periods of the displayed signal. If less than three edges are present, the measurement shows "No edges".

The X cursors show what interval of the waveform is being measured.

## DC RMS

DC RMS is the root-mean-square value of the waveform over one or more full periods.

$$\text{RMS (dc)} = \sqrt{\frac{\sum_{i=1}^n x_i^2}{n}}$$

Where  $x_i$  = value at  $i$ th point being measured,  $n$  = number of points in measurement interval.

The Full Screen measurement interval variation measures the value on all displayed data points.

The N Cycles measurement interval variation measures the value on an integral number of periods of the displayed signal. If less than three edges are present, the measurement shows "No edges".

The X cursors show the interval of the waveform being measured.

## AC RMS

AC RMS is the root-mean-square value of the waveform, with the DC component removed. It is useful, for example, for measuring power supply noise.

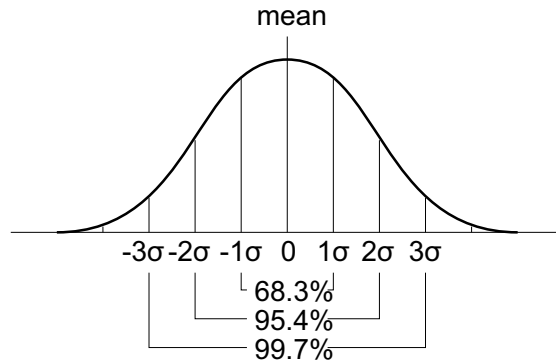
The N Cycles measurement interval measures the value on an integral number of periods of the displayed signal. If less than three edges are present, the measurement shows "No edges".

The X cursors show the interval of the waveform being measured.

The Full Screen (Std Deviation) measurement interval variation is an RMS measurement across the full screen with the DC component removed. It shows the standard deviation of the displayed voltage values.

The standard deviation of a measurement is the amount that a measurement varies from the mean value. The Mean value of a measurement is the statistical average of the measurement.

The following figure graphically shows the mean and standard deviation. Standard deviation is represented by the Greek letter sigma:  $\sigma$ . For a Gaussian distribution, two sigma ( $\pm 1\sigma$ ) from the mean, is where 68.3 percent of the measurement results reside. Six sigma ( $\pm 3\sigma$ ) from is where 99.7 percent of the measurement results reside.



The mean is calculated as follows:

$$\bar{x} = \frac{\sum_{i=1}^N x_i}{N}$$

where:

- $\bar{x}$  = the mean.
- $N$  = the number of measurements taken.
- $x_i$  = the  $i$ th measurement result.

The standard deviation is calculated as follows:

$$\sigma = \sqrt{\frac{\sum_{i=1}^N (x_i - \bar{x})^2}{N}}$$

where:

- $\sigma$  = the standard deviation.



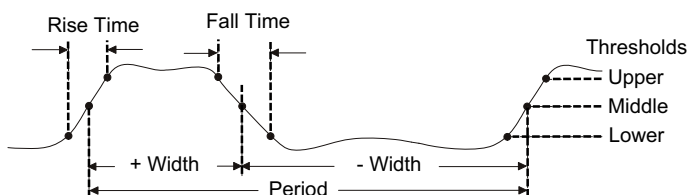
- $N$  = the number of measurements taken.
- $x_i$  = the  $i$ th measurement result.
- $\bar{x}$  = the mean.

## Ratio

The Ratio measurement displays the ratio of the AC RMS voltages of two sources, expressed in dB. Press the **Settings** softkey to select the source channels for the measurement.

## Time Measurements

The following figure shows time measurement points.



The default lower, middle, and upper measurement thresholds are 10%, 50%, and 90% between Top and Base values. See **“Measurement Thresholds”** on page 270 for other percentage threshold and absolute value threshold settings.

- **“Period”** on page 258
- **“Frequency”** on page 258
- **“Counter”** on page 259
- **“+ Width”** on page 260
- **“- Width”** on page 260
- **“Burst Width”** on page 260
- **“Duty Cycle”** on page 260
- **“Bit Rate”** on page 261
- **“Rise Time”** on page 261
- **“Fall Time”** on page 261

- **"Delay"** on page 261
- **"Phase"** on page 262
- **"X at Min Y"** on page 264
- **"X at Max Y"** on page 264

## Period

Period is the time period of the complete waveform cycle. The time is measured between the middle threshold points of two consecutive, like-polarity edges. A middle threshold crossing must also travel through the lower and upper threshold levels which eliminates runt pulses. The X cursors show what portion of the waveform is being measured. The Y cursor shows the middle threshold point.

## Frequency

Frequency is defined as  $1/\text{Period}$ . Period is defined as the time between the middle threshold crossings of two consecutive, like-polarity edges. A middle threshold crossing must also travel through the lower and upper threshold levels which eliminates runt pulses. The X cursors show what portion of the waveform is being measured. The Y cursor shows the middle threshold point.

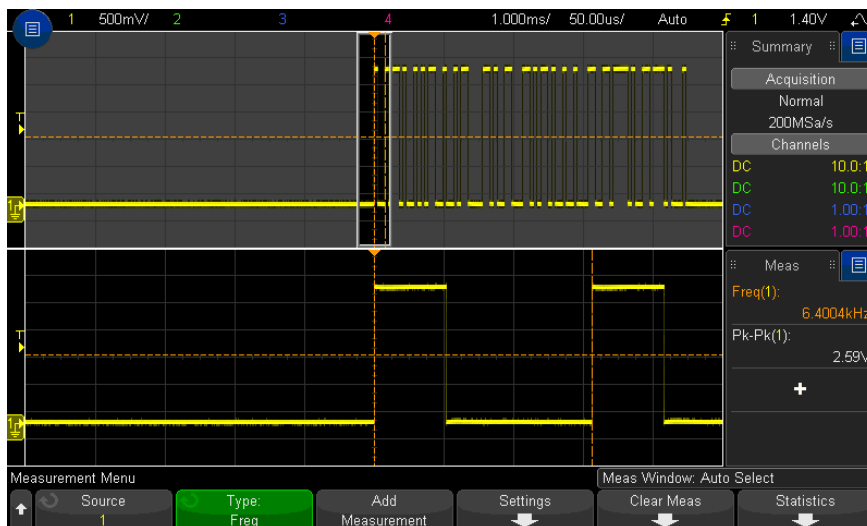
- See Also**
- **"To isolate an event for frequency measurement"** on page 258

### To isolate an event for frequency measurement

The following figure shows how to use Zoom mode to isolate an event for a frequency measurement.

You may need to change the measurement window setting so that the measurement is made in the lower, Zoom window. See **"Measurement Window"** on page 272.

If the waveform is clipped, it may not be possible to make the measurement.



**Figure 49** Isolating an event for Frequency measurement

## Counter

The InfiniiVision X-Series oscilloscopes have an integrated hardware frequency counter which counts the number of cycles that occur within a period of time (known as the gate time) to measure the frequency of a signal.

The gate time is the horizontal range of the oscilloscope but is limited to  $\geq 0.1$  s and  $\leq 10$  s. Unlike other measurements, the Zoom horizontal timebase window does not gate the Counter measurement.

The Counter measurement can measure frequencies up to the bandwidth of the oscilloscope. The minimum frequency supported is  $2.0 / \text{gateTime}$ .

The hardware counter uses the trigger comparator output. Therefore, the counted channel's trigger level (or threshold for digital channels) must be set correctly.

Analog and digital channels can be selected as the source.

Only one Counter measurement can be displayed at a time.

## + Width

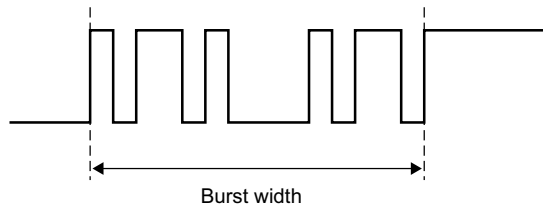
**+ Width** is the time from the middle threshold of the rising edge to the middle threshold of the next falling edge. The X cursors show the pulse being measured. The Y cursor shows the middle threshold point.

## – Width

**– Width** is the time from the middle threshold of the falling edge to the middle threshold of the next rising edge. The X cursors show the pulse being measured. The Y cursor shows the middle threshold point.

## Burst Width

The Burst Width measurement is the time from the first edge to the last edge on screen.



## Duty Cycle

The duty cycle of a repetitive pulse train is the ratio of the pulse width to the period, expressed as a percentage. The X cursors show the time period being measured. The Y cursor shows the middle threshold point.

$$+ \text{Duty cycle} = \frac{+ \text{Width}}{\text{Period}} \times 100 \quad - \text{Duty cycle} = \frac{- \text{Width}}{\text{Period}} \times 100$$

## Bit Rate

The bit rate measurement measures all positive and negative pulse widths on the waveform, takes the minimum value found of either width type and inverts that minimum width to give a value in Hertz.

## Rise Time

The rise time of a signal is the time difference between the crossing of the lower threshold and the crossing of the upper threshold for a positive-going edge. The X cursor shows the edge being measured. For maximum measurement accuracy, set the horizontal time/div as fast as possible while leaving the complete rising edge of the waveform on the display. The Y cursors show the lower and upper threshold points.

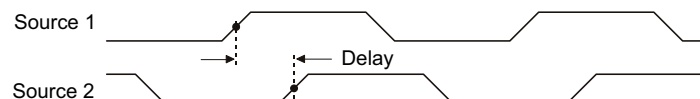
## Fall Time

The fall time of a signal is the time difference between the crossing of the upper threshold and the crossing of the lower threshold for a negative-going edge. The X cursor shows the edge being measured. For maximum measurement accuracy, set the horizontal time/div as fast as possible while leaving the complete falling edge of the waveform on the display. The Y cursors show the lower and upper threshold points.

## Delay

Delay measures the time difference between two waveform edges using the middle threshold points of the waveforms.

Negative delay values indicate that the selected edge of source 1 occurred after the selected edge of source 2.



- 1 Press the **[Meas]** key to display the Measurement Menu.
- 2 Press the **Add Meas** softkey.
- 3 Press the **Type:** softkey; then, turn the Entry knob to select **Delay**.
- 4 Click the **Parameter** softkey; then, select and specify the following parameters:

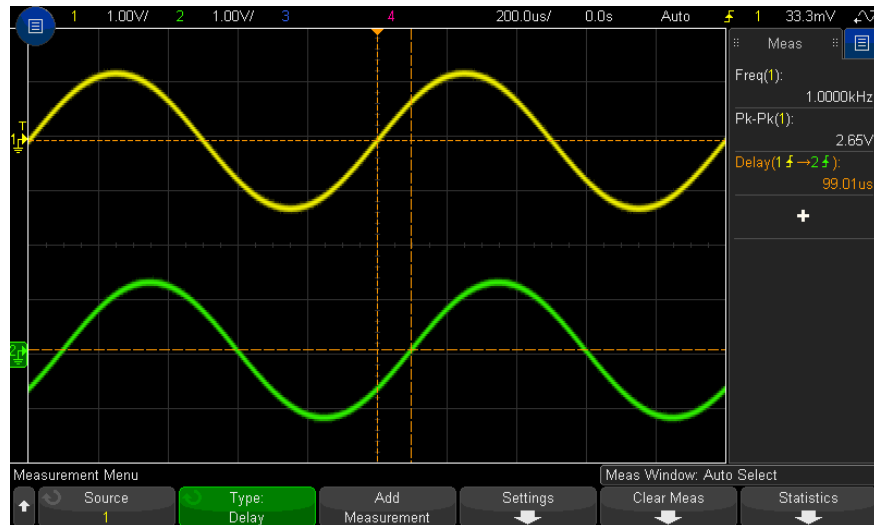
- **Source 1, Source 2** – waveform source.
- **Source 1 Slope, Source 2 Slope** – rising edge or falling edge.
- **Source 1 Edge #, Source 2 Edge #** – edge number for the selected source.

When **Auto** is selected for the **Source 1 Edge #**, the edge closest to the timebase reference point is used. **Auto** is also automatically selected for the **Source 2 Edge #**, and cannot be changed. In this case, the source 2 edge closest to the source 1 edge is used.

When edge numbers are selected, edges are counted from the left side of the display for both sources.

- 5 Press the **Add Measurement** softkey to make the measurement.

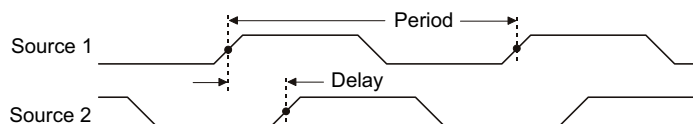
The example below shows a delay measurement between the rising edge of channel 1 and the rising edge of channel 2.



## Phase

Phase is the calculated phase shift from source 1 to source 2, expressed in degrees. Negative phase shift values indicate that the rising edge of source 1 occurred after the rising edge of source 2.

$$\text{Phase} = \frac{\text{Delay}}{\text{Source 1 Period}} \times 360$$

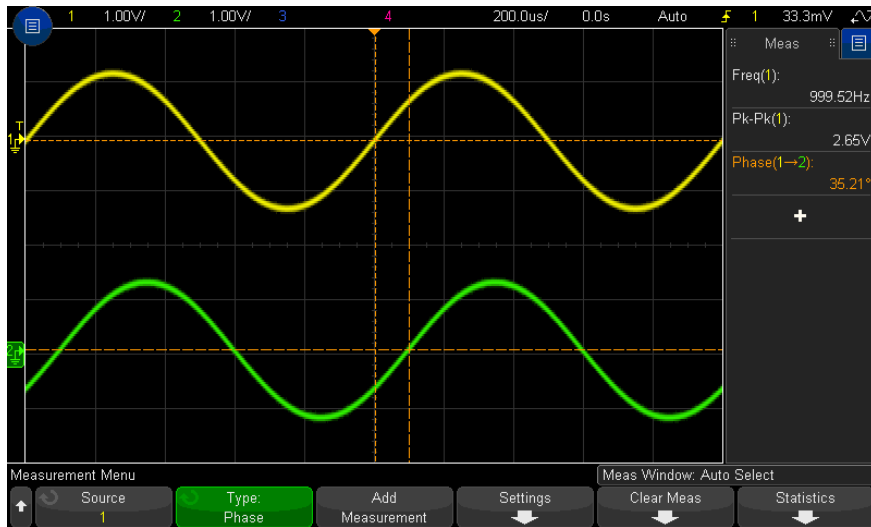


- 1 Press the **[Meas]** key to display the Measurement Menu.
- 2 Press the **Add Meas** softkey.
- 3 Press the **Type:** softkey; then, turn the Entry knob to select **Phase**.
- 4 Click the **Parameter** softkey; then, select and specify the following parameters:
  - **Source 1**
  - **Source 2**

The default Phase settings measure from channel 1 to channel 2.

- 5 Press the **Add Measurement** softkey to make the measurement.

The example below shows a phase measurement between the channel 1 and the math d/dt function on channel 1.



## X at Min Y

X at Min Y is the X axis value (usually time) at the first displayed occurrence of the waveform Minimum, starting from the left-side of the display. For periodic signals, the position of the minimum may vary throughout the waveform. The X cursor shows where the current X at Min Y value is being measured.

## X at Max Y

X at Max Y is the X axis value (usually time) at the first displayed occurrence of the waveform Maximum, starting from the left-side of the display. For periodic signals, the position of the maximum may vary throughout the waveform. The X cursor shows where the current X at Max Y value is being measured.

See Also · ["To measure the peak of an FFT"](#) on page 264

### To measure the peak of an FFT

- 1 Select **FFT** as the Operator in the Waveform Math Menu.
- 2 Choose **Math N** as the source in the Measurement Menu.
- 3 Choose **Maximum** and **X at Max Y** measurements.



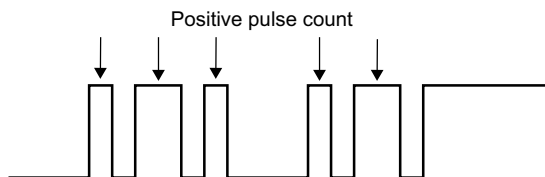
**Maximum** units are in dB and **X at Max Y** units are in Hertz for FFT.

## Count Measurements

- **“Positive Pulse Count”** on page 265
- **“Negative Pulse Count”** on page 265
- **“Rising Edge Count”** on page 266
- **“Falling Edges Count”** on page 266

### Positive Pulse Count

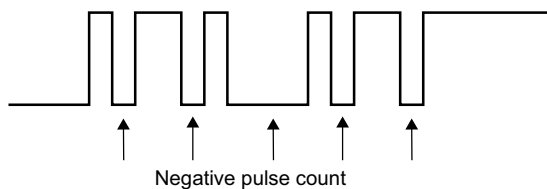
The **Positive Pulse Count** measurement is a pulse count for the selected waveform source.



This measurement is available for analog channels.

### Negative Pulse Count

The **Negative Pulse Count** measurement is a pulse count for the selected waveform source.



This measurement is available for analog channels.

### Rising Edge Count

The **Rising Edge Count** measurement is an edge count for the selected waveform source.

This measurement is available for analog channels.

### Falling Edges Count

The **Falling Edges Count** measurement is an edge count for the selected waveform source.

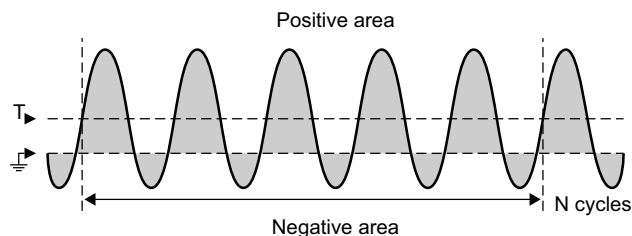
This measurement is available for analog channels.

## Mixed Measurements

- **"Area"** on page 266

### Area

Area measures the area between the waveform and the ground level. Area below the ground level is subtracted from area above the ground level.



The Full Screen measurement interval variation measures the value on all displayed data points.

The N Cycles measurement interval variation measures the value on an integral number of periods of the displayed signal. If less than three edges are present, the measurement shows "No edges".

The X cursors show what interval of the waveform is being measured.

## FFT Analysis Measurements

- **"Channel Power"** on page 267
- **"Occupied Bandwidth"** on page 268
- **"Adjacent Channel Power Ratio (ACPR)"** on page 268
- **"Total Harmonic Distortion (THD)"** on page 269

### Channel Power

**Channel Power** measures the spectral power across a frequency range.

The center frequency used in the measurement is the one defined for the FFT function, and the FFT span specifies the frequency range.

When this measurement is tracked with cursors, the cursors are at the far left and right edges of the graticule.

## Occupied Bandwidth

**Occupied Bandwidth** measures the bandwidth (frequency range) containing some percent (usually 99%) of the total spectral power. While 99% is the industry norm, you can specify the percent you want to use in the measurement.

The center frequency used in the measurement is the one defined for the FFT function, and the FFT span represents the total spectral power.

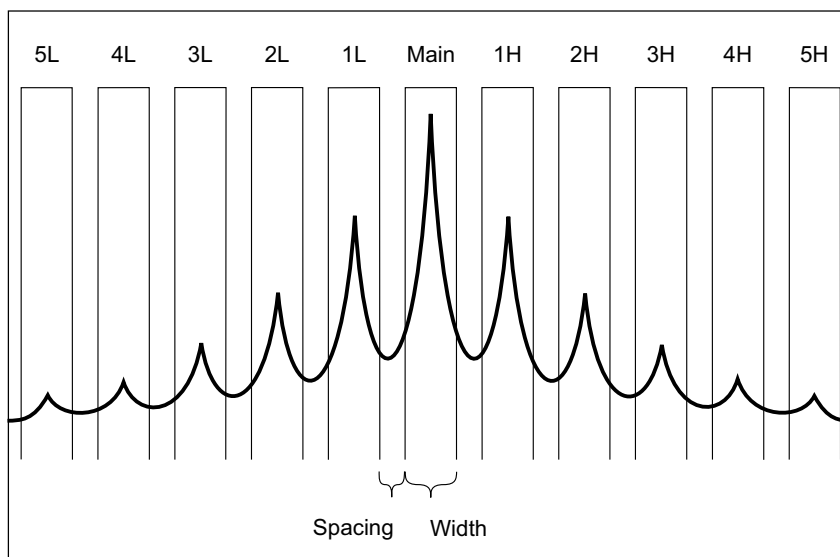
When this measurement is tracked with cursors, the cursors show the measured bandwidth (frequency range).

## Adjacent Channel Power Ratio (ACPR)

Adjacent Channel Power Ratio or just **Adjacent Power Ratio** (or channel leakage ratio) measures the ratio of the power contained in one or more sidebands to the power in the main frequency range.

The main range is specified by a channel width and a center frequency. The Channel Width is one of the measurement's parameters. The center frequency used in the measurement is the one defined for the FFT function.

Sidebands (with the same width as the main range) exist above and below the main range separated by the channel spacing width. The Channel Spacing width is another measurement parameter.



The sideband used for the measurement is selected with the Channel Select parameter. You can select the first through fifth sidebands above or below the main range (1H through 5H above and 1L through 5L below). The full sideband must be in the graticule to be measured. Otherwise, the measurement results will be "Incomplete".

When this measurement is tracked with cursors, the cursors show the sideband being measured.

## Total Harmonic Distortion (THD)

**Total Harmonic Distortion** (THD) is the ratio of power in the fundamental frequency to the power contained in the rest of the harmonics and noise. THD is a measure of signal purity.

**Total Harmonic Distortion** (THD) measures the power contained in the bands surrounding each harmonic and compares it to the power in the band surrounding the fundamental frequency. The width of the bands measured is the same for the fundamental frequency and each harmonic. That width is 1/2 of the fundamental frequency.

You can either enter the fundamental frequency as a measurement parameter and have the fundamental frequency and harmonics be tracked manually, or you can allow the fundamental frequency and harmonics to be tracked automatically, where the highest peak is assumed to be the fundamental frequency.

When this measurement is tracked with cursors, the cursors show the band surrounding the fundamental frequency that is being measured (at  $\pm 1/4$  of the fundamental frequency).

## Measurement Thresholds

Setting measurement thresholds defines the vertical levels where measurements will be taken on an analog channel or math waveform.

### NOTE

#### Changing default thresholds may change measurement results

The default lower, middle, and upper threshold values are 10%, 50%, and 90% of the value between Top and Base. Changing these threshold definitions from the default values may change the returned measurement results for Average, Delay, Duty Cycle, Fall Time, Frequency, Overshoot, Period, Phase, Preshoot, Rise Time, +Width, and -Width.

- 1 From the Measurement Menu, press the **Thresholds** softkey to set analog channel measurement thresholds.

You can also open the Measurement Threshold Menu by pressing **[Analyze] > Features** and then selecting **Measurement Thresholds**.

- 2 Press the **Source** softkey to select the analog channel or math waveform source for which you want to change measurement thresholds.

Each analog channel and the math waveform can be assigned unique threshold values.



- 3 Press the **Type** softkey to set the measurement threshold to **%** (percentage of Top and Base value) or to **Absolute** (absolute value).
  - Percentage thresholds can be set from 0% to 100%.

- The units for absolute threshold for each channel is set in the channel probe menu.

**TIP**
**Absolute threshold hints**

- Absolute thresholds are dependent on channel scaling, probe attenuation, and probe units. Always set these values first before setting absolute thresholds.
- The minimum and maximum threshold values are limited to on-screen values.
- If any of the absolute threshold values are above or below the minimum or maximum waveform values, the measurement may not be valid.

- 
- 4 Press the **Lower** softkey; then, turn the Entry knob to set the lower measurement threshold value.

Increasing the lower value beyond the set middle value will automatically increase the middle value to be more than the lower value. The default lower threshold is 10% or 800 mV.

If threshold **Type** is set to %, the lower threshold value can be set from 0% to 98%.

- 5 Press the **Middle** softkey; then, turn the Entry knob to set the middle measurement threshold value.

The middle value is bounded by the values set for lower and upper thresholds. The default middle threshold is 50% or 1.20 V.

- If threshold **Type** is set to %, the middle threshold value can be set from 1% to 99%.

- 6 Press the **Upper** softkey; then, turn the Entry knob to set the upper measurement threshold value.

Decreasing the upper value below the set middle value will automatically decrease the middle value to be less than the upper value. The default upper threshold is 90% or 1.50 V.

- If threshold **Type** is set to %, the upper threshold value can be set from 2% to 100%.

## Measurement Window

You can choose whether measurements are made in the Main window portion of the display, the Zoom window portion of the display (when the zoomed time base is displayed), or gated by the X1 and X2 cursors.

- 1 Press the **[Meas]** key.
- 2 In the Measurement Menu, press the **Meas Window** softkey; then, turn the Entry knob to select from:
  - **Auto Select** – When the zoomed time base is displayed, the measurement is attempted in the lower, Zoom window; if it cannot be made there, or if the zoomed time base is not displayed, the Main window is used.
  - **Main** – The measurement window is the Main window.
  - **Zoom** – The measurement window is the lower, Zoom window.
  - **Gated by Cursors** – The measurement window is between the X1 and X2 cursors. When the zoomed time base is displayed, the X1 and X2 cursors in the Zoom window portion of the display are used.

## Measurement Statistics

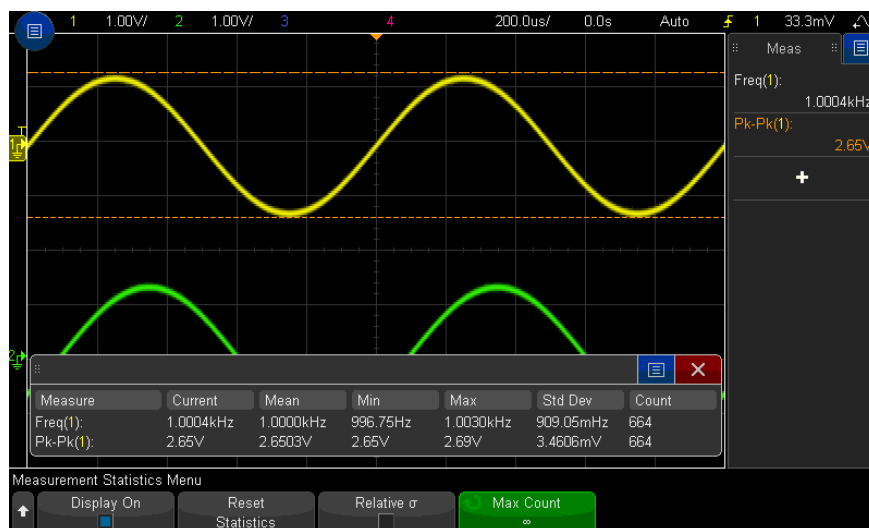
To display measurement statistics:

- 1 Press the **[Meas]** key to enter the Measurement Menu. By default frequency and peak-to-peak voltage are measured on channel 1.
- 2 Select the measurements you desire for the channels you are using (see **"Measurements Summary"** on page 246).
- 3 From the Measurement Menu, press the **Statistics** softkey to enter the Statistics Menu.



- 4 Press the **Display On** softkey to enable the measurement statistics display.





The source channel of the measurement is shown in parenthesis after the measurement name. For example: "**Freq(1)**" indicates a frequency measurement on channel 1.

The following statistics are shown: Name of the measurement, current measured value, mean, minimum measured value, maximum measured value, standard deviation, and the number of times the measurement has been made (count). Statistics are based on the total number of captured waveforms (count).

The standard deviation shown in Statistics is calculated using the same formula used for calculating the standard deviation measurement. The formula is shown in the section titled "**AC RMS**" on page 255.

You can press the **Display On** softkey again to disable the measurement statistics display. Statistics continue to accumulate even when the statistics display is disabled.

- 5 To reset the statistics measurements, press the **Reset Statistics** softkey. This resets all statistics and begins recording statistical data again.

Each time a new measurement (for example: frequency, period, or amplitude) is added the statistics are reset and accumulation of statistical data begins again.

- 6 To enable a relative standard deviation, press the **Relative  $\sigma$**  softkey.

When enabled, the standard deviation shown in measurement statistics becomes the standard deviation/mean.

- 7 To specify the number of values used when calculating measurement statistics, press the **Max Count** softkey and enter the desired value.

Statistics are calculated on the most recent "N" number of values, where N is either the total number of acquisitions measured or a limited **Max Count** number of acquisitions measured.

Other things to know about measurement statistics:

- When the **[Single]** key is pressed, statistics are reset and a single measurement is done (count = 1). Successive **[Single]** acquisitions accumulate statistical data (and the count is incremented).
- The **Increment Statistics** softkey only appears when the acquisition is stopped and the optional segmented memory feature is off. Press the **[Single]** or **[Run/Stop]** key to stop the acquisition. You can use the horizontal position control (in the Horizontal control section of the front panel) to pan through the waveform. Active measurements will stay on screen, allowing you to measure various aspects of the captured waveforms. Press **Increment Statistics** to add the currently measured waveform to the collected statistical data.
- The **Analyze Segments** softkey only appears when the acquisition is stopped and the optional segmented memory feature is on. After an acquisition has completed (and the oscilloscope is stopped), you can press the **Analyze Segments** softkey to accumulate measurement statistics for the acquired segments.

You can also turn on infinite persistence (in the Display Menu) and press the **Analyze Segments** softkey to create an infinite persistence display.

# 16 Mask Testing

To create a mask from a "golden" waveform (Automask) / 275

Mask Test Setup Options / 277

Mask Statistics / 280

To manually modify a mask file / 281

Building a Mask File / 284

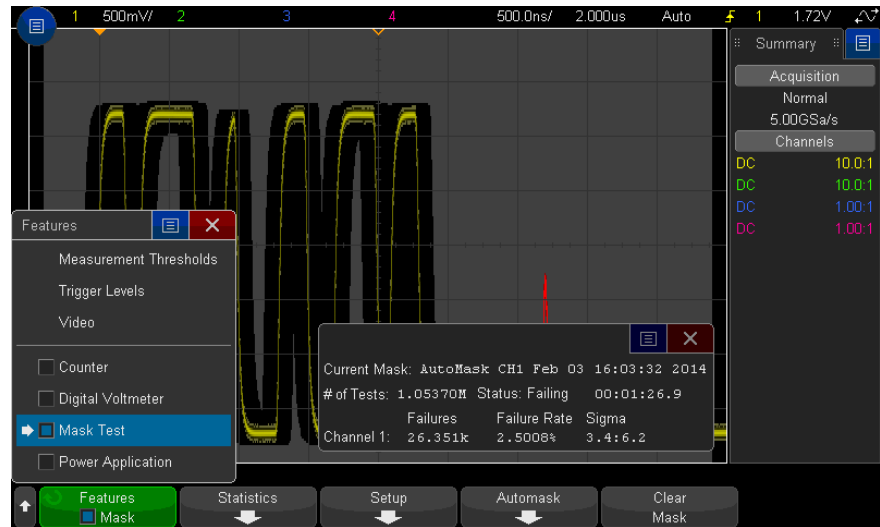
One way to verify a waveform's compliance to a particular set of parameters is to use mask testing. A mask defines a region of the oscilloscope's display in which the waveform must remain in order to comply with chosen parameters. Compliance to the mask is verified point-by-point across the display. Mask test operates on displayed analog channels; it does not operate on channels that are not displayed.

To enable mask test order Option LMT at time of oscilloscope purchase, or order DSOX3MASK as a stand-alone item after oscilloscope purchase.

## To create a mask from a "golden" waveform (Automask)

A golden waveform meets all chosen parameters, and it is the waveform to which all others will be compared.

- 1 Configure the oscilloscope to display the golden waveform.
- 2 Press the **[Analyze]** key.
- 3 Press **Features**; then, select **Mask Test**.
- 4 Press **Features** again to enable mask testing.



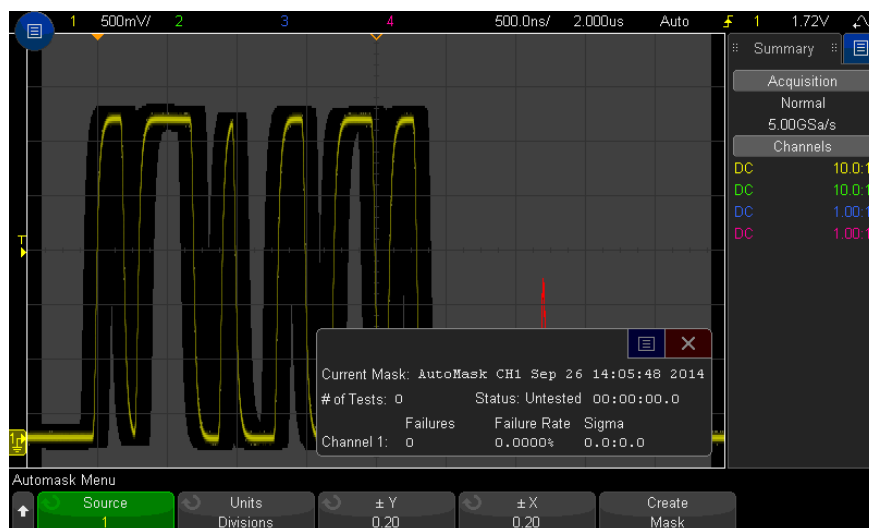
- 5 Press **Automask**.
- 6 In the Automask Menu, press the **Source** softkey and ensure the desired analog channel is selected.




- 7 Adjust the mask's horizontal tolerance ( $\pm Y$ ) and vertical tolerance ( $\pm X$ ). These are adjustable in graticule divisions or in absolute units (volts or seconds), selectable using the **Units** softkey.
- 8 Press the **Create Mask** softkey.

The mask is created and testing begins.

Whenever the **Create Mask** softkey is pressed the old mask is erased and a new mask is created.



- 9 To clear the mask and switch off mask testing, press the  Back/Up key to return to the Mask Test Menu, then press the **Clear Mask** softkey.

If infinite persistence display mode (see **"To set or clear persistence"** on page 157) is "on" when mask test is enabled, it stays on. If infinite persistence is "off" when mask test is enabled, it is switched on when mask test is switched on, then infinite persistence is switched off when mask test is switched off.

#### Troubleshooting Mask Setup

If you press **Create Mask** and the mask appears to cover the entire screen, check the  $\pm Y$  and  $\pm X$  settings in the Automask Menu. If these are set to zero the resulting mask will be extremely tight around the waveform.

If you press **Create Mask** and it appears that no mask was created, check the  $\pm Y$  and  $\pm X$  settings. They may be set so large that the mask is not visible.

## Mask Test Setup Options

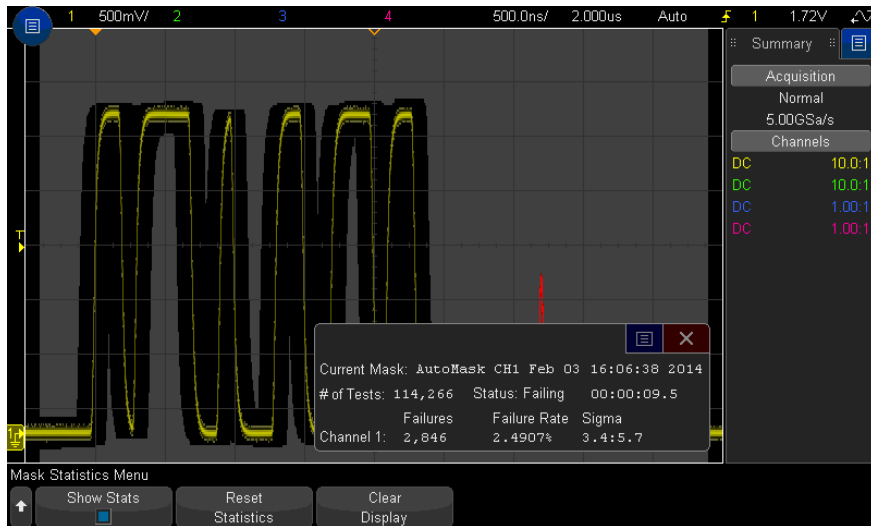
From the Mask Test Menu, press the **Setup** softkey to enter the Mask Setup Menu.

<p><b>Run Until</b></p>	<p>The Run Until softkey lets you specify a condition on which to terminate testing.</p> <ul style="list-style-type: none"> <li>▪ <b>Forever</b> – The oscilloscope runs continuously. However, if an error occurs the action specified using the <b>On Error</b> softkey will occur.</li> <li>▪ <b>Minimum # of Tests</b> – Choose this option and then use the <b># of Tests</b> softkey to select the number of times the oscilloscope will trigger, display the waveform(s), and compare them to the mask. The oscilloscope will stop after the specified number of tests have been completed. The specified minimum number of tests may be exceeded. If an error occurs the action specified using the <b>On Error</b> softkey will occur. The actual number of tests completed is displayed above the softkeys.</li> <li>▪ <b>Minimum Time</b> – Choose this option and then use the <b>Test Time</b> softkey to select how long the oscilloscope will run. When the selected time has passed the oscilloscope will stop. The specified time may be exceeded. If an error occurs the action specified using the <b>On Error</b> softkey will occur. The actual test time is displayed above the softkeys.</li> <li>▪ <b>Minimum Sigma</b> – Choose this option and then use the <b>Sigma</b> softkey to select a minimum sigma. The mask test runs until enough waveforms are tested to achieve a minimum test sigma. (If an error occurs the oscilloscope will perform the action specified by the <b>On Error</b> softkey.) Note that this is a test sigma (the max achievable process sigma, assuming no defects, for a certain number of tested waveforms) as opposed to a process sigma (which is tied to the amount of failures per test). The sigma value may exceed the selected value when a small sigma value is chosen. The actual sigma is displayed.</li> </ul>
-------------------------	--

<b>On Error</b>	<p>The <b>On Error</b> setting specifies the action(s) to take when the input waveform does not conform to the mask. This setting supersedes the <b>Run Until</b> setting.</p> <ul style="list-style-type: none"> <li>▪ <b>Stop</b> – The oscilloscope will stop when the first error is detected (on the first waveform that does not conform to the mask). This setting supersedes the <b>Minimum # of Tests</b> and <b>Minimum Time</b> settings.</li> <li>▪ <b>Save</b> – The oscilloscope saves the screen image when an error is detected. In the Save Menu (press [<b>Save/Recall</b>] &gt; <b>Save</b>), select an image format (*.bmp or *.png), destination (on a USB storage device), and file name (which can be auto-incrementing). If errors occur too frequently and the oscilloscope spends all its time saving images, press the [<b>Stop</b>] key to stop acquisitions.</li> <li>▪ <b>Print</b> – The oscilloscope prints the screen image when an error is detected. This option is only available when a printer is connected as described in “<b>To print the oscilloscope's display</b>” on page 335.</li> <li>▪ <b>Measure</b> – Measurements (and measurement statistics if your oscilloscope supports them) run only on waveforms that contain a mask violation. Measurements are not affected by passing waveforms. This mode is not available when the acquisition mode is set to Averaging.</li> </ul> <p>Note that you can choose to <b>Print</b> or <b>Save</b>, but you cannot select both at the same time. All other actions may be selected at the same time. For example, you can select both <b>Stop</b> and <b>Measure</b> to cause the oscilloscope to measure and stop on the first error..</p> <p>You can also output a signal on the rear panel TRIG OUT BNC connector when there is a mask test failure. See “<b>Setting the Rear Panel TRIG OUT Source</b>” on page 350.</p>
<b>Source Lock</b>	<p>When you turn on Source Lock using the <b>Source Lock</b> softkey, the mask is redrawn to match the source whenever you move the waveform. For example, if you change the horizontal timebase or the vertical gain the mask is redrawn with the new settings.</p> <p>When you turn off Source Lock, the mask is not redrawn when horizontal or vertical settings are changed.</p>
<b>Source</b>	<p>If you change the Source channel, the mask is not erased. It is re-scaled to the vertical gain and offset settings of the channel to which it is assigned. To create a new mask for the selected source channel, go back up in the menu hierarchy; then, press <b>Automask</b>, and press <b>Create Mask</b>.</p> <p>The Source softkey in the Mask Setup Menu is the same as the Source softkey in the Automask Menu.</p>
<b>Test All</b>	<p>When enabled, all displayed analog channels are included in the mask test. When disabled, just the selected source channel is included in the test.</p>

## Mask Statistics

From the Mask Test Menu, press the **Statistics** softkey to enter the Mask Statistics Menu.



<p><b>Show Stats</b></p>	<p>When you enable <b>Show Statistics</b> the following information is displayed:</p> <ul style="list-style-type: none"> <li>▪ Current mask, name of mask, Channel number, date and time.</li> <li>▪ # of Tests (total number of mask tests executed).</li> <li>▪ Status (Passing, Failing, or Untested).</li> <li>▪ Accumulated test time (in hours, minutes, seconds, and tenths of seconds).</li> </ul> <p>And for each analog channel:</p> <ul style="list-style-type: none"> <li>▪ Number of failures (acquisitions in which the signal excursion went beyond the mask).</li> <li>▪ Failure rate (percentage of failures).</li> <li>▪ Sigma (the ratio of process sigma to maximum achievable sigma, based on number of waveforms tested).</li> </ul>
--------------------------	--



<b>Reset Statistics</b>	<p>Note that statistics are also reset when:</p> <ul style="list-style-type: none"> <li>▪ Mask Test is switched on after being switched off.</li> <li>▪ Clear Mask softkey is pressed.</li> <li>▪ An Automask is created.</li> </ul> <p>Additionally, the accumulated time counter is reset whenever the oscilloscope is run after the acquisition was stopped.</p>
<b>Clear Display</b>	Clears acquisition data from the oscilloscope display.

## To manually modify a mask file

You can manually modify a mask file that you created using the Automask function.

- 1 Follow the steps 1-7 in **"To create a mask from a "golden" waveform (Automask)"** on page 275. Do not clear the mask after creating it.
- 2 Attach a USB mass storage device to the oscilloscope.
- 3 Press the **[Save/Recall]** key.
- 4 Press the **Save** softkey.
- 5 Press the **Format** softkey and select **Mask**.
- 6 Press the second softkey and select a destination folder on your USB mass storage device.
- 7 Press the **Press to Save** softkey. This creates an ASCII text file that describes the mask.
- 8 Remove the USB mass storage device and connect it to a PC.
- 9 Open the .msk file your created using a text editor (such as Wordpad).
- 10 Edit, save, and close the file.

The mask file contains the following sections:

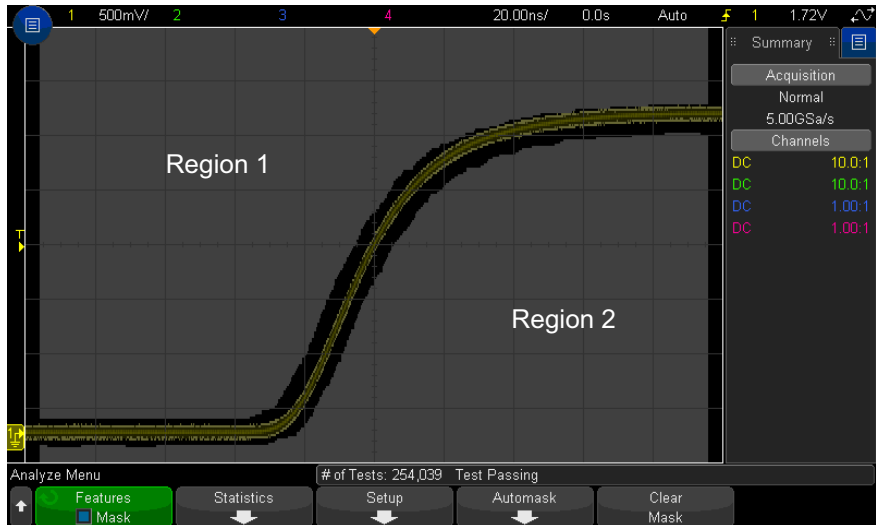
- Mask File Identifier.
- Mask Title.
- Mask Violation Regions.
- Oscilloscope Setup Information.

**Mask File Identifier** The Mask File Identifier is MASK\_FILE\_548XX.

**Mask Title** The Mask Title is a string of ASCII characters. Example: autoMask CH1 OCT 03 09:40:26 2008

When a mask file contains the keyword "autoMask" in the title, the edge of the mask is passing by definition. Otherwise, the edge of the mask is defined as a failure.

### Mask Violation Regions



Up to 8 regions can be defined for a mask. They can be numbered 1-8. They can appear in any order in the .msk file. The numbering of the regions must go from top to bottom, left to right.

An Automask file contains two special regions: the region "glued" to the top of the display, and the region that is "glued" to the bottom. The top region is indicated by y-values of "MAX" for the first and last points. The bottom region is indicated by y-values of "MIN" for the first and last points.

The top region must be the lowest numbered region in the file. The bottom region must be the highest numbered region in the file.

Region number 1 is the top mask region. The vertices in Region 1 describe points along a line; that line is the bottom edge of the top portion of the mask.

Similarly, the vertices in Region 2 describe the line that forms the top of the bottom part of the mask.

The vertices in a mask file are normalized. There are four parameters that define how values are normalized:

- X1
- $\Delta X$
- Y1
- Y2

These four parameters are defined in the Oscilloscope Setup portion of the mask file.

The Y-values (normally voltage) are normalized in the file using the following equation:

$$Y_{\text{norm}} = (Y - Y1)/\Delta Y$$

$$\text{where } \Delta Y = Y2 - Y1$$

To convert the normalized Y-values in the mask file to voltage:

$$Y = (Y_{\text{norm}} * \Delta Y) + Y1$$

$$\text{where } \Delta Y = Y2 - Y1$$

The X-values (normally time) are normalized in the file using the following equation:

$$X_{\text{norm}} = (X - X1)/\Delta X$$

To convert the normalized X-values to time:

$$X = (X_{\text{norm}} * \Delta X) + X1$$

### Oscilloscope Setup Information

The keywords "setup" and "end\_setup" (appearing alone on a line) define the beginning and end of the oscilloscope setup region of the mask file. The oscilloscope setup information contains remote programming language commands that the oscilloscope executes when the mask file is loaded.

Any legal remote programming command can be entered in this section.

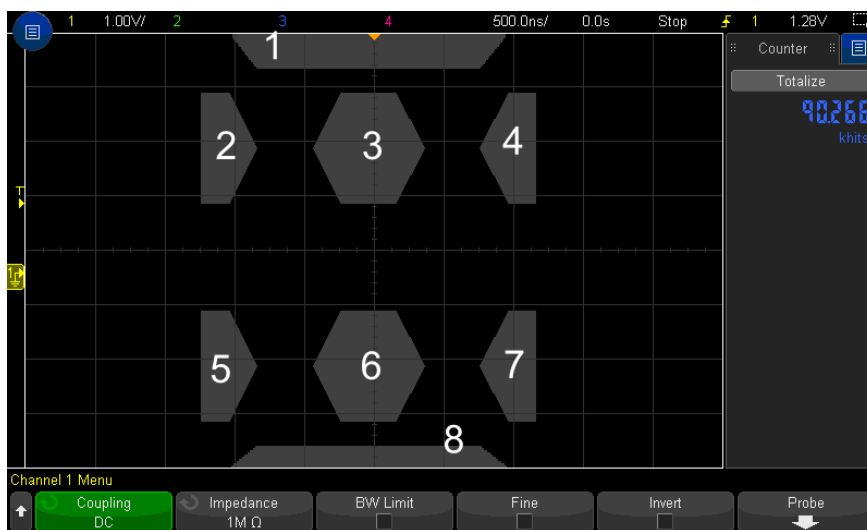
The mask scaling controls how the normalized vectors are interpreted. This in turn controls how the mask is drawn on the display. The remote programming commands that control mask scaling are:

```
:MTES:SCAL:BIND 0
:MTES:SCAL:X1 -400.000E-06
:MTES:SCAL:XDEL +800.000E-06
```

```
:MTES:SCAL:Y1 +359.000E-03
:MTES:SCAL:Y2 +2.35900E+00
```

## Building a Mask File

The following display shows a mask that uses all eight regions.



This mask is created by recalling the following mask file:

```
MASK_FILE_548XX

"All Regions"

/* Region Number */ 1
/* Number of vertices */ 4
-12.50, MAX
-10.00, 1.750
10.00, 1.750
12.50, MAX

/* Region Number */ 2
/* Number of vertices */ 5
-10.00, 1.000
-12.50, 0.500
-15.00, 0.500
-15.00, 1.500
-12.50, 1.500

/* Region Number */ 3
```

```

/* Number of vertices */ 6
-05.00, 1.000
-02.50, 0.500
02.50, 0.500
05.00, 1.000
02.50, 1.500
-02.50, 1.500

/* Region Number */ 4
/* Number of vertices */ 5
10.00, 1.000
12.50, 0.500
15.00, 0.500
15.00, 1.500
12.50, 1.500

/* Region Number */ 5
/* Number of vertices */ 5
-10.00, -1.000
-12.50, -0.500
-15.00, -0.500
-15.00, -1.500
-12.50, -1.500

/* Region Number */ 6
/* Number of vertices */ 6
-05.00, -1.000
-02.50, -0.500
02.50, -0.500
05.00, -1.000
02.50, -1.500
-02.50, -1.500

/* Region Number */ 7
/* Number of vertices */ 5
10.00, -1.000
12.50, -0.500
15.00, -0.500
15.00, -1.500
12.50, -1.500

/* Region Number */ 8
/* Number of vertices */ 4
-12.50, MIN
-10.00, -1.750
10.00, -1.750
12.50, MIN

setup
:CHANnel1:RANGe +8.00E+00
:CHANnel1:OFFSet +2.0E+00
:CHANnel1:DISPlay 1
:TIMEbase:MODE MAIN
:TIMEbase:REFerence CENTER
:TIMEbase:RANGe +50.00E-09
:TIMEbase:POSition +10.0E-09
:MTESt:SOURce CHANnel1
:MTESt:ENABle 1
:MTESt:LOCK 1
:MTESt:SCALe:X1 +10.0E-09
:MTESt:SCALe:XDELta +1.0000E-09
:MTESt:SCALe:Y1 +2.0E+00

```

```
:MTEST:SCALE:Y2 +4.00000E+00
end_setup
```

In a mask file, all region definitions need to be separated by a blank line.

Mask regions are defined by a number of (x,y) coordinate vertices (as on an ordinary x,y graph). A "y" value of "MAX" specifies the top of the graticule, and a "y" value of "MIN" specifies the bottom of the graticule.

The mask x,y graph is related to the oscilloscope graticule using the :MTEST:SCALE setup commands.

The oscilloscope's graticule has a time reference location (at the left, center, or right of the screen) and a trigger (t=0) position/delay value relative to the reference. The graticule also has a vertical ground 0 V reference (offset relative to the center of the screen) location.

The X1 and Y1 setup commands relate the mask region's x,y graph origin to the oscilloscope graticule's t=0 and V=0 reference locations, and the XDELta and Y2 setup commands specify the size of the graph's x and y units.

- The X1 setup command specifies the time location of the x,y graph's x origin.
- The Y1 setup command specifies the vertical location of the x,y graph's y origin.
- The XDELta setup command specifies the amount of time associated with each x unit.
- The Y2 setup command is the vertical location of the x,y graph's y=1 value (so in effect, Y2 - Y1 is the YDELta value).

For example:

- With a graticule whose trigger position is 10 ns (before a center screen reference) and whose ground reference (offset) is 2 V below the center of the screen, to place the mask region's x,y graph's origin at center screen, you would set X1 = 10 ns and Y1 = 2 V.
- If the XDELta parameter is set to 5 ns and Y2 is set to 4 V, a mask region whose vertices are (-1, 1), (1, 1), (1, -1), and (-1, -1) goes from 5 ns to 15 ns and from 0 V to 4 V.
- If you move the mask region's x,y graph origin to the t=0 and V=0 location by setting X1 = 0 and Y1 = 0, the same vertices define a region that goes from -5 ns to 5 ns and from -2 V to 2 V.

**NOTE**

Although a mask can have up to 8 regions, in any given vertical column, it is only possible to define 4 regions. When there are 4 regions in a vertical column, one region must be tied to the top (using the MAX y value) and one must be tied to the bottom (using the MIN y value).

---

## How is mask testing done?

InfiniiVision oscilloscopes start mask testing by creating a database that is 200 x 640 for the waveform viewing area. Each location in the array is designated as either a violation or a pass area. Each time a data point from a waveform occurs in a violation area a failure is logged. If **Test All** was selected, every active analog channel is tested against the mask database for each acquisition. Over 2 billion failures can be logged per-channel. The number of acquisitions tested is also logged and displayed as "# of Tests".

The mask file allows greater resolution than the 200 X 640 database. Some quantization of data occurs to reduce the mask file data for display on-screen.

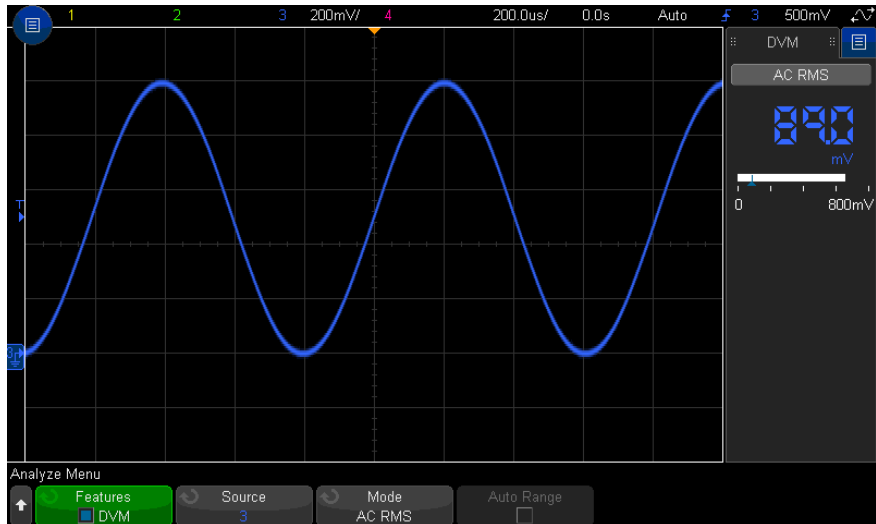




# 17 Digital Voltmeter and Counter

Digital Voltmeter / 290  
Counter / 291

The Digital Voltmeter (DVM) and Counter analysis features are standard on the 3000T X-Series oscilloscopes.



## Digital Voltmeter

The digital voltmeter (DVM) analysis feature provides 3-digit voltage measurements on any analog channel. DVM measurements are asynchronous from the oscilloscope's acquisition system and are always acquiring.

The DVM display is a seven-segment readout like you would see on a digital voltmeter. It shows the selected mode as well as the units. Units are selected using the **Units** softkey in the channel's Probe Menu.

The DVM display also has a scale that is determined by the channel's vertical scale and reference level. The scale's blue triangle pointer shows the most recent measurement. The white bar above that shows the measurement extrema over the last 3 seconds.

The DVM makes accurate RMS measurements when the signal frequency is between 20 Hz and 100 kHz. When the signal frequency is outside this range, "<BW Limit?" or ">BW Limit?" appears in the DVM display to caution you about inaccurate RMS measurement results.

To use the digital voltmeter:

- 1 Press the **[Analyze]** key.
- 2 Press **Features**; then, select **Digital Voltmeter**.
- 3 Press **Features** again to enable the DVM measurements.



- 4 Press the **Source** softkey and turn the Entry knob to select the analog channel on which digital voltmeter (DVM) measurements are made.

The selected channel does not have to be on (displaying a waveform) in order for DVM measurements to be made.

- 5 Press the **Mode** softkey and turn the Entry knob to select the digital voltmeter (DVM) mode:
  - **AC RMS** – displays the root-mean-square value of the acquired data, with the DC component removed.
  - **DC** – displays the DC value of the acquired data.
  - **DC RMS** – displays the root-mean-square value of the acquired data.

- 6** If the selected source channel is not used in oscilloscope triggering, press **Auto Range** to disable or enable automatic adjustment of the DVM channel's vertical scale, vertical (ground level) position, and trigger (threshold voltage) level (used for the counter frequency measurement).

When enabled, **Auto Range** overrides attempted adjustments of the channel's vertical scale and position knobs.

When disabled, you can use the channel's vertical scale and position knobs normally.

## Counter

The counter analysis feature provides frequency, period, or edge event (totalize) counter measurements on any analog channel.

The counter counts trigger level crossings within a certain amount of time (gate time) and displays the results on a seven-segment readout (like you would see on a standalone counter instrument).

For frequency and period counter measurements:

- The gate time is specified indirectly by the selected number of digits of resolution, from 3 to 8. For higher resolutions, the gate time is greater.
- Up to 1 GHz (1.2 GHz typical) frequencies can be measured. With 8 digits of resolution, the counter will saturate for signals greater than 470 MHz.

For totalize measurements:

- A running count of edges is kept. You can choose whether to count positive or negative edges, and when edge triggering on any analog channel, you can gate the count with a positive or negative pulse on a second analog channel.
- Edge events with up to 1 GHz (1.2 GHz typical) frequencies can be counted.
- When gating the count, the gating signal setup time is 0 ns typical and the hold time is 3.5 ns typical when using similar probes for the totalize source and the gate source.

The counter is asynchronous from the oscilloscope's acquisition system and is always acquiring.

To use the counter:

- 1** Press the **[Analyze]** key.

- 2 Press **Features**; then, select **Counter**.
- 3 Press **Features** again to enable the counter.



- 4 Press the **Source** softkey and turn the Entry knob to select the analog channel or **Trigger Qualified Event** signal to make counter measurements on.

With the **Trigger Qualified Event** source (available when the trigger mode is not Edge), you can see how often trigger events are detected. This can be more often than when triggers actually occur, due to the oscilloscope's acquisition time or update rate capabilities. The TRIG OUT signal shows when triggers actually occur. Remember that the oscilloscope's trigger circuitry does not re-arm until the holdoff time occurs and that the minimum holdoff time is 40 ns; therefore, the maximum trigger qualified event frequency that can be counted is 25 MHz.

The selected channel does not have to be on (displaying a waveform) in order for counter measurements to be made.

- 5 Press **Auto Setup Threshold** softkey to have the oscilloscope automatically determine and set the threshold voltage (trigger) level for the selected analog channel source.
- 6 Press the **Measure** softkey and turn the Entry knob to select what the counter measures:
  - **Frequency** – the cycles per second (Hz, kHz, or MHz) of the signal.
  - **Period** – the time periods of the signal's cycles.
  - **Totalize** – the count of edge events on the signal.

#### Frequency and Period Counter

For frequency and period measurements, press the **# of Digits** softkey to specify the resolution of the counter. You can choose from 3 to 8 digit resolutions.

Higher resolutions require longer gate times, which cause the measurement times to be longer as well.

#### Totalize Counter

For (edge event) totalize measurements, press the **Clear Count** softkey to zero the edge event counter.

Press the **Totalize** softkey to open the Counter Totalize Menu where you can:



- Press the **Source** softkey and turn the Entry knob to change the analog channel on which counter measurements are made.
- Press the **Event Slope** softkey to choose whether positive or negative edge events are counted.
- Press the **Gate** softkey to enable or disable gating of the edge event count using a positive or negative level on a second analog channel.

When gating is enabled:

- a Press the **Gate Source** softkey and turn the Entry knob to select the analog channel that will supply the gating signal.

The selected channel does not have to be on (displaying a waveform).

- b Press the polarity softkey to choose whether positive or negative levels are used to gate the edge event count.

The trigger level for the selected analog channel is used to determine the polarity of the signal.



# 18 Frequency Response Analysis

To make connections / 295

To set up and run the analysis / 296

To view and save the analysis results / 298

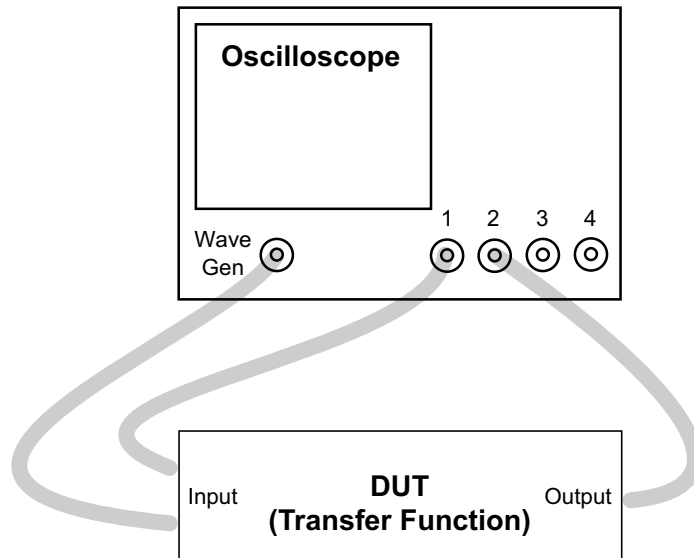
Frequency Response Analysis (FRA) is a licensed feature you can get by purchasing the DSOXT3FRA upgrade.

The Frequency Response Analysis (FRA) feature controls the built-in waveform generator to sweep a sine wave across a range of frequencies while measuring the input to and output from a device under test (DUT). At each frequency, gain (A) and phase are measured and plotted on a frequency response Bode chart.

When the frequency response analysis completes, you can move a marker across the chart to see the measured gain and phase values at each frequency point. You can also adjust the chart's scale and offset settings for the gain and phase plots.

## To make connections

The waveform generator output is connected to a device under test (DUT). The input to the device and the output from the device are probed by the oscilloscope's input channels.



To set up and run the analysis

- 1 Choose **Main Menu > Analyze > Analyze Menu**.
- 2 Click **Features**; then, select **Frequency Response Analysis**.
- 3 Click **Features** again to enable the feature.



- 4 Click the **Setup & Apply...** softkey to open the Frequency Response Analysis dialog box's tab for setting up the swept frequency response analysis.





There are settings for:

- The start and stop frequencies in the sweep, as well as the number of points per decade.
- The channels probing the input and output. (Click the help icon to view a connection diagram.)
- The waveform generator amplitude and expected output load impedance.

To specify different amplitudes for different decades, select **Amplitude Profile**.

The output impedance of the Gen Out signal is fixed at 50 ohms. However, the output load selection lets the waveform generator display the correct amplitude and offset levels for the expected output load. If the actual load impedance is different than the selected value, the displayed amplitude and offset levels will be incorrect.

- 5 Click the **Run Analysis** softkey.

## To view and save the analysis results

Click the **Plot...** softkey to open the Frequency Response Analysis dialog box's tab for viewing the analysis results in a Bode plot.



The plot shows both gain and phase measurements versus frequency. There are two markers that can be dragged to view actual values along the plot. There is a control in the upper right corner for adjusting the scale/offset of the plots or autoscaling.

Click the **Table...** softkey to open the Frequency Response Analysis dialog box's tab for viewing the analysis results in table form.



The table shows: the data point number, the frequency, the waveform generator output amplitude, the measured gain, and the measured phase. You can scroll the data.

You can save (or e-mail) the analysis results by choosing **Main Menu > File > Save Menu**, clicking **Format**, and selecting the **Frequency Response Analysis data (\*.csv)** option.



# 19 Waveform Generator

To select generated waveform types and settings / 301

To edit arbitrary waveforms / 305

To output the waveform generator sync pulse / 312

To specify the expected output load / 312

To use waveform generator logic presets / 313

To add noise to the waveform generator output / 313

To add modulation to the waveform generator output / 314

To restore waveform generator defaults / 318

A waveform generator is built into the oscilloscope. It is enabled by the DSOX3WAVEGEN upgrade license. The waveform generator gives you an easy way to provide input signals when testing circuitry with the oscilloscope.

Waveform generator settings can be saved and recalled with oscilloscope setups. See [Chapter 20](#), "Save/Email/Recall (Setups, Screens, Data)," starting on page 321.

## To select generated waveform types and settings

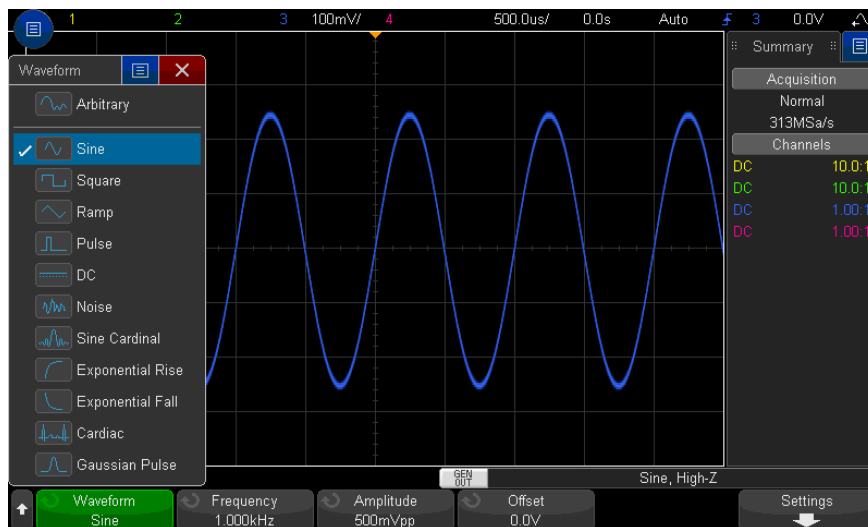
- 1 To access the Waveform Generator Menu and enable or disable the waveform generator output on the front panel Gen Out BNC, press the **[Wave Gen]** key.

When waveform generator output is enabled, the **[Wave Gen]** key is illuminated. When waveform generator output is disabled, the **[Wave Gen]** key is off.

The waveform generator output is always disabled when the instrument is first turned on.

The waveform generator output is automatically disabled if excessive voltage is applied to the Gen Out BNC.

- 2 In the Waveform Generator Menu, press the **Waveform** softkey and turn the Entry knob to select the waveform type.



- 3 Depending on the selected waveform type, use the remaining softkeys and the Entry knob to set the waveform's characteristics.

Waveform Type	Characteristics	Frequency Range	Max. Amplitude (High-Z) <sup>1</sup>	Offset (High-Z) <sup>1</sup>
Arbitrary	Use the <b>Frequency/Frequency Fine/Period/Period Fine, Amplitude/High-Level, and Offset/Low-Level</b> softkeys to set the arbitrary waveform signal parameters.  Use the <b>Edit Waveform</b> softkey to define the arbitrary waveform shape. See <b>"To edit arbitrary waveforms"</b> on page 305.	100 mHz to 12 MHz	20 mVpp to 5 Vpp	±2.50 V
Sine	Use the <b>Frequency/Frequency Fine/Period/Period Fine, Amplitude/High-Level, and Offset/Low-Level</b> softkeys to set the sine signal parameters.	100 mHz to 20 MHz	20 mVpp to 5 Vpp	±2.50 V

Waveform Type	Characteristics	Frequency Range	Max. Amplitude (High-Z) <sup>1</sup>	Offset (High-Z) <sup>1</sup>
Square	Use the <b>Frequency/Frequency Fine/Period/Period Fine, Amplitude/High-Level, Offset/Low-Level, and Duty Cycle</b> softkeys to set the square wave signal parameters. The duty cycle can be adjusted from 20% to 80%.	100 mHz to 10 MHz	20 mVpp to 5 Vpp	±2.50 V
Ramp	Use the <b>Frequency/Frequency Fine/Period/Period Fine, Amplitude/High-Level, Offset/Low-Level, and Symmetry</b> softkeys to set the ramp signal parameters. Symmetry represents the amount of time per cycle that the ramp waveform is rising and can be adjusted from 0% to 100%.	100 mHz to 200 kHz	20 mVpp to 5 Vpp	±2.50 V
Pulse	Use the <b>Frequency/Frequency Fine/Period/Period Fine, Amplitude/High-Level, Offset/Low-Level, and Width/Width Fine</b> softkeys to set the pulse signal parameters. The pulse width can be adjusted from 20 ns to the period minus 20 ns.	100 mHz to 10 MHz.	20 mVpp to 5 Vpp	±2.50 V
DC	Use the <b>Offset</b> softkey to set the DC level.	n/a	n/a	±5.00 V
Noise	Use the <b>Amplitude/High-Level</b> and <b>Offset/Low-Level</b> to set the noise signal parameters.	n/a	20 mVpp to 5 Vpp	±2.50 V
Sine Cardinal	Use the <b>Frequency/Frequency Fine/Period/Period Fine, Amplitude, and Offset</b> softkeys to set the sinc signal parameters.	100 mHz to 1 MHz	20 mVpp to 5 Vpp	±1.25 V
Exponential Rise	Use the <b>Frequency/Frequency Fine/Period/Period Fine, Amplitude/High-Level, and Offset/Low-Level</b> softkeys to set the exponential rise signal parameters.	100 mHz to 5 MHz	20 mVpp to 5 Vpp	±2.50 V
Exponential Fall	Use the <b>Frequency/Frequency Fine/Period/Period Fine, Amplitude/High-Level, and Offset/Low-Level</b> softkeys to set the exponential fall signal parameters.	100 mHz to 5 MHz	20 mVpp to 5 Vpp	±2.50 V

Waveform Type	Characteristics	Frequency Range	Max. Amplitude (High-Z) <sup>1</sup>	Offset (High-Z) <sup>1</sup>
Cardiac	Use the <b>Frequency/Frequency Fine/Period/Period Fine, Amplitude</b> , and <b>Offset</b> softkeys to set the cardiac signal parameters.	100 mHz to 200 kHz	20 mVpp to 5 Vpp	±1.25 V
Gaussian Pulse	Use the <b>Frequency/Frequency Fine/Period/Period Fine, Amplitude</b> , and <b>Offset</b> softkeys to set the Gaussian pulse signal parameters.	100 mHz to 5 MHz	20 mVpp to 4 Vpp	±1.25 V

<sup>1</sup>When the output load is 50 Ω, these values are halved.

Pressing a signal parameter softkey can open a menu for selecting the type of adjustment. For example, you can choose to enter amplitude and offset values, or you can choose to enter high-level and low-level values. Or, you can choose to enter frequency values or period values. Keep pressing the softkey to select the type of adjustment. Turn the Entry knob to adjust the value.

The **Settings** softkey opens the Waveform Generator Settings Menu which lets you make other settings related to the waveform generator.



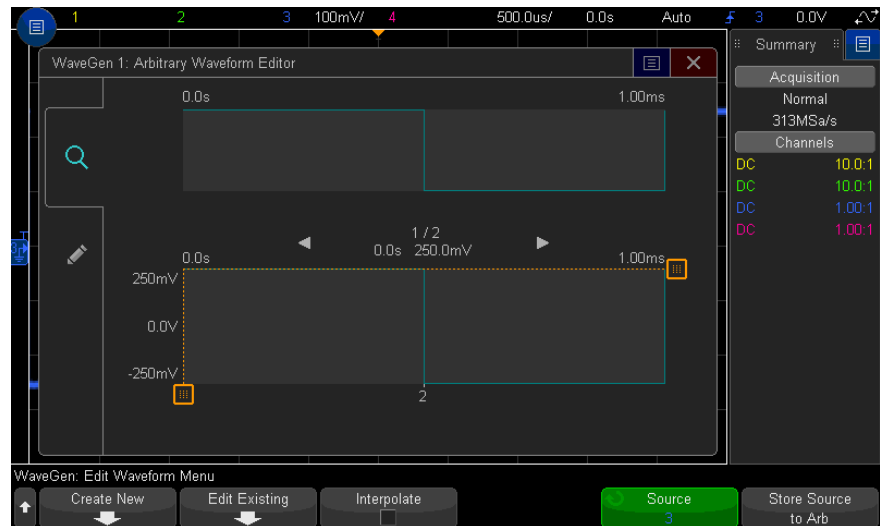
See:

- ["To output the waveform generator sync pulse"](#) on page 312
- ["To specify the expected output load"](#) on page 312
- ["To use waveform generator logic presets"](#) on page 313
- ["To add modulation to the waveform generator output"](#) on page 314
- ["To add noise to the waveform generator output"](#) on page 313
- ["To restore waveform generator defaults"](#) on page 318



## To edit arbitrary waveforms

- 1 When **Arbitrary** is selected as the generated waveform type (see **"To select generated waveform types and settings"** on page 301), press the **Edit Waveform** softkey to open the Edit Waveform Menu.



When you open the Edit Waveform Menu, you see the existing arbitrary waveform definition. The voltage and time period you see in the diagram are the bounding parameters – they come from the frequency and amplitude settings in the main Waveform Generator Menu.

- 2 Use the softkeys in the Edit Waveform Menu to define the shape of the arbitrary waveform:

Softkey	Description
<b>Create New</b>	Opens the New Waveform Menu. See <b>"Creating New Arbitrary Waveforms"</b> on page 306.
<b>Edit Existing</b>	Opens the Edit Waveform Points Menu. See <b>"Editing Existing Arbitrary Waveforms"</b> on page 307.

Softkey	Description
<b>Interpolate</b>	Specifies how lines are drawn between arbitrary waveform points. When enabled, lines are drawn between points in the waveform editor. Voltage levels change linearly between one point and the next. When disabled, all line segments in the waveform editor are horizontal. The voltage level of one point remains until the next point.
<b>Source</b>	Selects the analog channel or reference waveform to be captured and stored to the arbitrary waveform. See <b>"Capturing Other Waveforms to the Arbitrary Waveform"</b> on page 311.
<b>Store Source to Arb</b>	Captures the selected waveform source and copy it to the arbitrary waveform. See <b>"Capturing Other Waveforms to the Arbitrary Waveform"</b> on page 311.

**NOTE**

You can use the **[Save/Recall]** key and menu to save arbitrary waveforms to one of four internal storage locations or to a USB storage device, and you can recall them later. See **"To save arbitrary waveforms"** on page 328 and **"To recall arbitrary waveforms"** on page 333.

## Creating New Arbitrary Waveforms

The New Waveform Menu is opened by pressing **Create New** in the Edit Waveform Menu.



To create a new arbitrary waveform:

- 1 In the New Waveform Menu, press **Initial Pts**; then, use the Entry knob to select the initial number of points in the new waveform.

The new waveform will be a square wave with the number of points you specify. The points are evenly spaced over the time period.

- 2 Use the **Frequency/Frequency Fine/Period/Period Fine** softkey to set the time period bounding parameter (repetition frequency) of the arbitrary waveform.
- 3 Use the **Amplitude/High-Level** and **Offset/Low-Level** softkeys to set the voltage bounding parameter of the arbitrary waveform.

- 4 When you are ready to create the new arbitrary waveform, press **Apply & Edit**.

### CAUTION

When you create a new arbitrary waveform, the existing arbitrary waveform definition is overwritten. Note that you can use the **[Save/Recall]** key and menu to save arbitrary waveforms to one of four internal storage locations or to a USB storage device, and you can recall them later. See **"To save arbitrary waveforms"** on page 328 and **"To recall arbitrary waveforms"** on page 333.

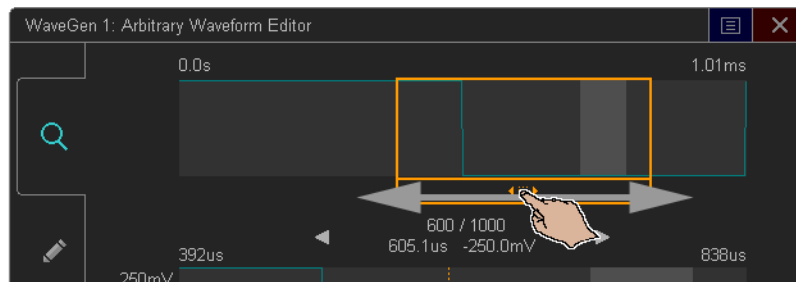
The new waveform is created and the Edit Waveform Points menu is opened. See **"Editing Existing Arbitrary Waveforms"** on page 307.

Note that you can also create a new arbitrary waveform by capturing another waveform. See **"Capturing Other Waveforms to the Arbitrary Waveform"** on page 311.

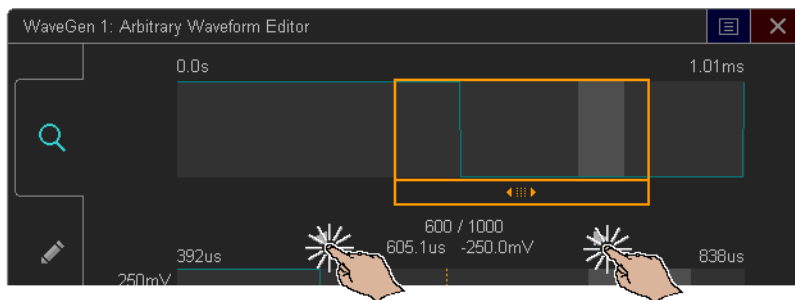
## Editing Existing Arbitrary Waveforms

### Using the Touchscreen to Edit Existing Waveforms

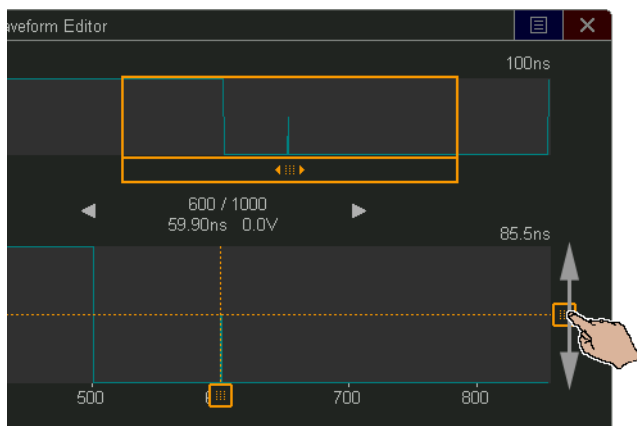
To select a point, touch or drag in the upper, full waveform display:



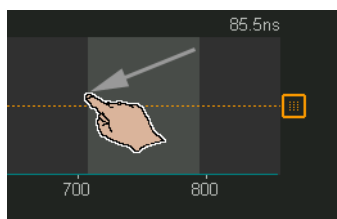
For fine points selection, touch the previous point or next point arrows:



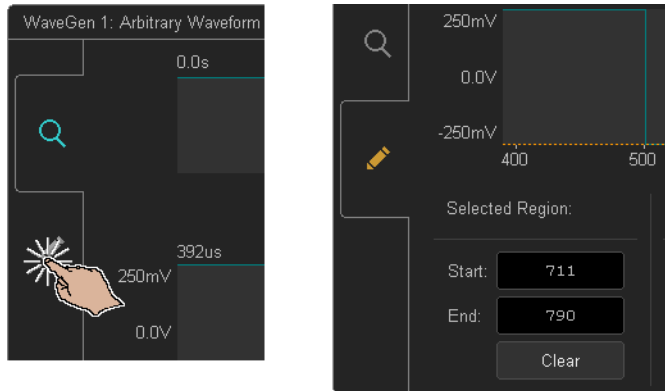
To adjust the value of a point, drag the voltage level handle up or down:



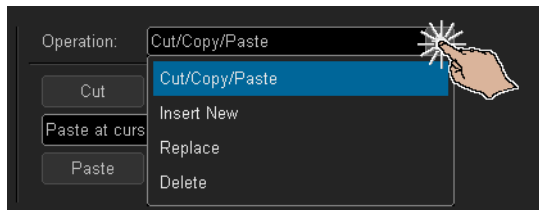
To select a points region, drag across the upper or lower waveform display:



For fine adjustment of the region selection (or to clear the selection), touch the edit tab, and use the **Selected Region** controls:



To perform points operations, touch the **Operation** controls drop-down, select the operation, and use the controls for the selected operation:



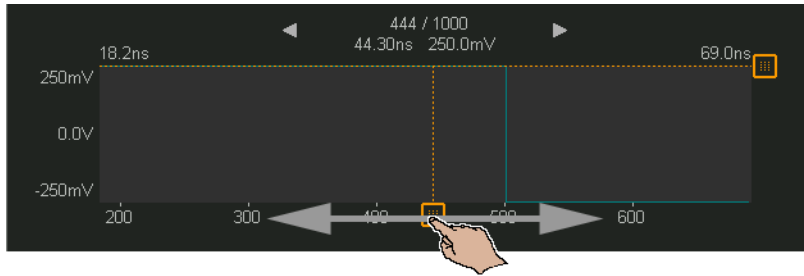
- **Cut/Copy** selected points regions to the clipboard and **Paste** points from the clipboard.

When pasting points from the clipboard, you can paste at the beginning, end, cursor location (currently selected point), or you can replace the currently selected points region.

- **Insert New** points.  
You can specify the number of new points and their voltage.
- **Replace** a selected points region with new points.
- **Delete** a selected points region.

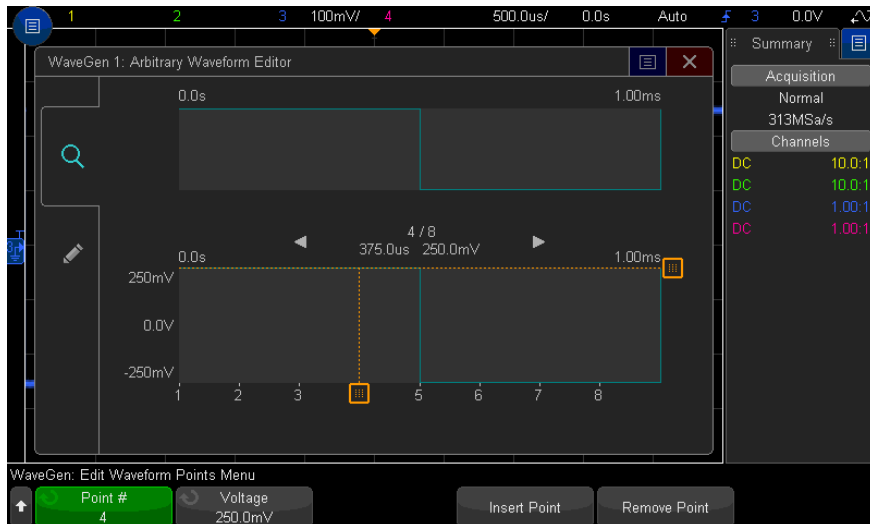
## 19 Waveform Generator

To navigate the arbitrary waveform (and select points), drag the point selection handle left or right across the display area:



### Using Softkeys to Edit Existing Waveforms

The Edit Waveform Points Menu is opened by pressing **Edit Existing** in the Edit Waveform Menu or by pressing **Apply & Edit** when creating a new arbitrary waveform.



To specify the voltage values of points:

- 1 Press **Point #**; then, use the Entry knob to select the point whose voltage value you wish to set.
- 2 Press **Voltage**; then, use the Entry knob to set the point's voltage value.

To insert a point:

- 1 Press **Point #**; then, use the Entry knob to select the point after which the new point will be inserted.
- 2 Press **Insert Point**.

All points are adjusted to maintain uniform time spacing between points.

To remove a point:

- 1 Press **Point #**; then, use the Entry knob to select the point you want to remove.
- 2 Press **Remove Point**.

All points are adjusted to maintain uniform time spacing between points.

## Capturing Other Waveforms to the Arbitrary Waveform

The Edit Waveform Menu is opened by pressing **Edit Waveform** in the main Waveform Generator Menu.



To capture another waveform to the arbitrary waveform:

- 1 Press **Source**; then, use the Entry knob to select the analog channel, math, or reference location whose waveform you wish to capture.
- 2 Press **Store Source to Arb**.

### CAUTION

When you create a new arbitrary waveform, the existing arbitrary waveform definition is overwritten. Note that you can use the **[Save/Recall]** key and menu to save arbitrary waveforms to one of four internal storage locations or to a USB storage device, and you can recall them later. See **"To save arbitrary waveforms"** on page 328 and **"To recall arbitrary waveforms"** on page 333.

The source waveform is decimated into 8192 (maximum) or fewer arbitrary waveform points.

**NOTE**

If the source waveform frequency and/or voltage exceed the capabilities of the waveform generator, the arbitrary waveform will be limited to the capabilities of the waveform generator. For example, a 20 MHz waveform captured as the arbitrary waveform, becomes a 12 MHz waveform.

## To output the waveform generator sync pulse

- 1 If the Waveform Generator Menu is not currently displayed on the oscilloscope's softkeys, press the **[Wave Gen]** key.
- 2 In the Waveform Generator Menu, press the **Settings** softkey.
- 3 In the Waveform Generator Settings Menu, press the **Trig Out** softkey and turn the Entry knob to select **Waveform Generator Sync Pulse**.

Waveform Type	Sync Signal Characteristics
All waveforms except DC, Noise, and Cardiac	The Sync signal is a TTL positive pulse that occurs when the waveform rises above zero volts (or the DC offset value).
DC, Noise, and Cardiac	N/A

## To specify the expected output load

- 1 If the Waveform Generator Menu is not currently displayed on the oscilloscope's softkeys, press the **[Wave Gen]** key.
- 2 In the Waveform Generator Menu, press the **Settings** softkey.
- 3 In the Waveform Generator Settings Menu, press the **Out Load** softkey and turn the Entry knob to select:
  - **50  $\Omega$**
  - **High-Z**

The output impedance of the Gen Out BNC is fixed at 50 ohms. However, the output load selection lets the waveform generator display the correct amplitude and offset levels for the expected output load.



If the actual load impedance is different than the selected value, the displayed amplitude and offset levels will be incorrect.

## To use waveform generator logic presets

With logic level presets, you can easily set the output voltage to TTL, CMOS (5.0V), CMOS (3.3V), CMOS (2.5V), or ECL compatible Low and High levels.

- 1 If the Waveform Generator Menu is not currently displayed on the oscilloscope's softkeys, press the **[Wave Gen]** key.
- 2 In the Waveform Generator Menu, press the **Settings** softkey.
- 3 In the Waveform Generator Settings Menu, press the **Logic Presets** softkey.
- 4 In the Waveform Generator Logic Level Presets Menu, press one of the softkeys to set the generated signal's Low and High voltages to logic compatible levels:

Softkey (logic levels)	Low level	High level
TTL	0 V	+5 V (or a TTL-compatible high level if +5 V cannot be reached)
CMOS (5.0V)	0 V	+5 V
CMOS (3.3V)	0 V	+3.3 V
CMOS (2.5V)	0 V	+2.5 V
ECL	-1.7 V	-0.9 V

## To add noise to the waveform generator output

- 1 If the Waveform Generator Menu is not currently displayed on the oscilloscope's softkeys, press the **[Wave Gen]** key.
- 2 In the Waveform Generator Menu, press the **Settings** softkey.
- 3 In the Waveform Generator Settings Menu, press the **Add Noise** softkey and turn the Entry knob to select the amount of white noise to add to the waveform generator output.

Note that adding noise affects edge triggering on the waveform generator source (see **“Edge Trigger”** on page 172) as well as the waveform generator sync pulse output signal (which can be sent to TRIG OUT, see **“Setting the Rear Panel TRIG OUT Source”** on page 350). This is because the trigger comparator is located after the noise source.

## To add modulation to the waveform generator output

Modulation is where an original carrier signal is modified according to the amplitude of a second modulating signal. The modulation type (AM, FM, or FSK) specifies how the carrier signal is modified.

Modulated waveforms are available on the WaveGen1 output.

To enable and set up modulation for the waveform generator output:

- 1 If the Waveform Generator Menu is not currently displayed on the oscilloscope's softkeys, press the **[Wave Gen]** key.
- 2 In the Waveform Generator Menu, press the **Settings** softkey.
- 3 In the Waveform Generator Settings Menu, press the **Modulation** softkey.
- 4 In the Waveform Generator Modulation Menu:



- Press the **Modulation** softkey to enable or disable modulated waveform generator output.

You can enable modulation for all waveform generator function types except arbitrary, square, pulse, DC, noise, and Gaussian pulse.

- Press the **Type** softkey and turn the Entry knob to select the modulation type:
  - **Amplitude Modulation (AM)** – the amplitude of the original carrier signal is modified according to the amplitude of the modulating signal. See **“To set up Amplitude Modulation (AM)”** on page 315.
  - **Frequency Modulation (FM)** – the frequency of the original carrier signal is modified according to the amplitude of the modulating signal. See **“To set up Frequency Modulation (FM)”** on page 316.

- **Frequency-Shift Keying Modulation (FSK)** – the output frequency "shifts" between the original carrier frequency and a "hop frequency" at the specified FSK rate. The FSK rate specifies a digital square wave modulating signal. See **"To set up Frequency-Shift Keying Modulation (FSK)"** on page 317.

## To set up Amplitude Modulation (AM)

In the Waveform Generator Modulation Menu (under **[Wave Gen] > Settings > Modulation**):

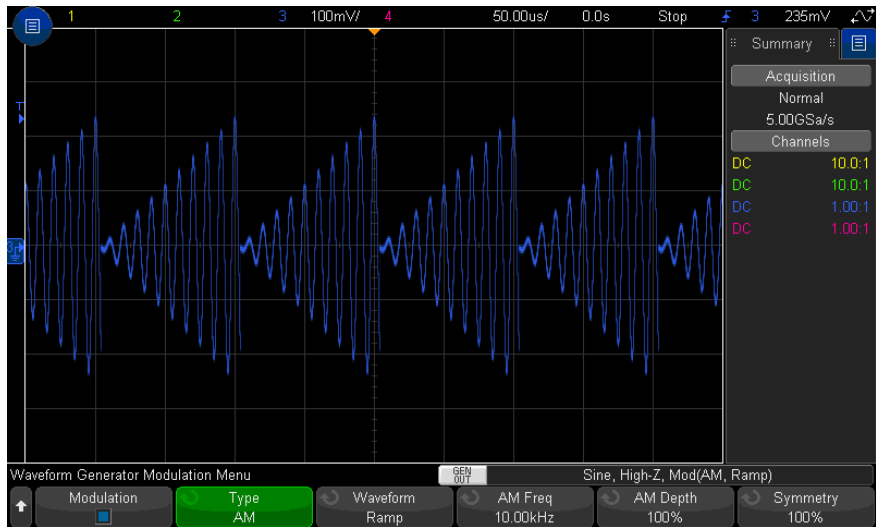
- 1 Press the **Type** softkey and turn the Entry knob to select **Amplitude Modulation (AM)**.
- 2 Press the **Waveform** softkey and turn the Entry knob to select the shape of the modulating signal:
  - **Sine**
  - **Square**
  - **Ramp**

When the **Ramp** shape is selected, a **Symmetry** softkey appears so that you can specify the amount of time per cycle that the ramp waveform is rising.

- 3 Press the **AM Freq** softkey and turn the Entry knob to specify the frequency of the modulating signal.
- 4 Press the **AM Depth** softkey and turn the Entry knob to specify the amount of amplitude modulation.

AM Depth refers to the portion of the amplitude range that will be used by the modulation. For example, a depth setting of 80% causes the output amplitude to vary from 10% to 90% ( $90\% - 10\% = 80\%$ ) of the original amplitude as the modulating signal goes from its minimum to maximum amplitude.

The following screen shows an AM modulation of a 100 kHz sine wave carrier signal.



## To set up Frequency Modulation (FM)

In the Waveform Generator Modulation Menu (under **[Wave Gen] > Settings > Modulation**):

- 1 Press the **Type** softkey and turn the Entry knob to select **Frequency Modulation (FM)**.
- 2 Press the **Waveform** softkey and turn the Entry knob to select the shape of the modulating signal:

- **Sine**
- **Square**
- **Ramp**

When the **Ramp** shape is selected, a **Symmetry** softkey appears so that you can specify the amount of time per cycle that the ramp waveform is rising.

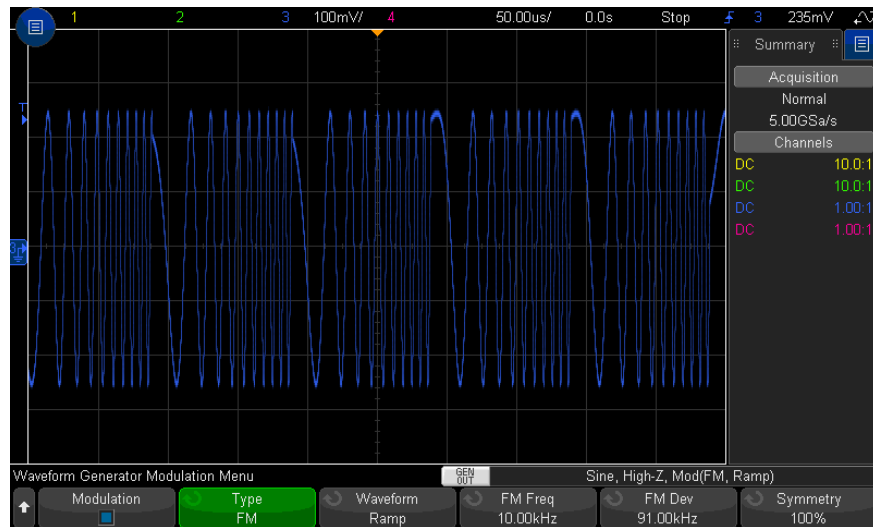
- 3 Press the **FM Freq** softkey and turn the Entry knob to specify the frequency of the modulating signal.
- 4 Press the **FM Dev** softkey and turn the Entry knob to specify the frequency deviation from the original carrier signal frequency.

When the modulating signal is at its maximum amplitude, the output frequency is the carrier signal frequency plus the deviation amount, and when the modulating signal is at its minimum amplitude, the output frequency is the carrier signal frequency minus the deviation amount.

The frequency deviation cannot be greater than the original carrier signal frequency.

Also, the sum of the original carrier signal frequency and the frequency deviation must be less than or equal to the maximum frequency for the selected waveform generator function plus 100 kHz.

The following screen shows an FM modulation of a 100 kHz sine wave carrier signal.



## To set up Frequency-Shift Keying Modulation (FSK)

In the Waveform Generator Modulation Menu (under **[Wave Gen] > Settings > Modulation**):

- 1 Press the **Type** softkey and turn the Entry knob to select **Frequency-Shift Keying Modulation (FSK)**.

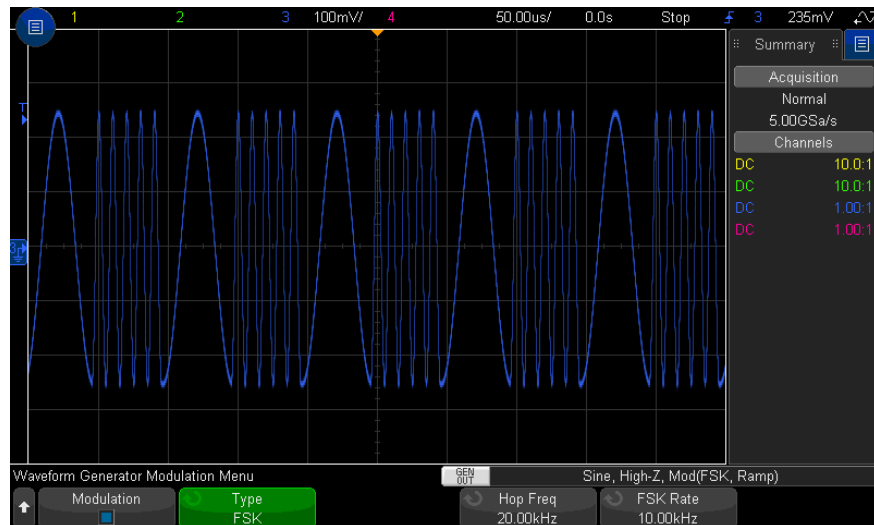
- 2 Press the **Hop Freq** softkey and turn the Entry knob to specify the "hop frequency".

The output frequency "shifts" between the original carrier frequency and this "hop frequency".

- 3 Press the **FSK Rate** softkey and turn the Entry knob to specify the rate at which the output frequency "shifts".

The FSK rate specifies a digital square wave modulating signal.

The following screen shows an FSK modulation of a 100 kHz sine wave carrier signal.



## To restore waveform generator defaults

- 1 If the Waveform Generator Menu is not currently displayed on the oscilloscope's softkeys, press the **[Wave Gen]** key.
- 2 In the Waveform Generator Menu, press the **Settings** softkey.
- 3 In the Waveform Generator Settings Menu, press the **Default Wave Gen** softkey.

The waveform generator factory default settings (1 kHz sine wave, 500 mVpp, 0 V offset, High-Z output load) are restored.





## 20 Save/Email/Recall (Setups, Screens, Data)

Saving Setups, Screen Images, or Data / 321

Emailing Setups, Screen Images, or Data / 330

Recalling Setups, Masks, or Data / 331

Recalling Default Setups / 333

Performing a Secure Erase / 334

Oscilloscope setups, reference waveforms, and mask files can be saved to internal oscilloscope memory or to a USB storage device and recalled later. You can also recall default or factory default setups.

Oscilloscope screen images can be saved to a USB storage device in BMP or PNG formats.

Acquired waveform data can be saved to a USB storage device in comma-separated value (CSV), ASCII XY, and binary (BIN) formats.

Any file that can be saved to a USB storage device can also be e-mailed over the network.

There is also a command to securely erase all the oscilloscope's non-volatile internal memory.

### Saving Setups, Screen Images, or Data

- 1 Press the **[Save/Recall]** key.
- 2 In the Save/Recall Menu, press **Save**.

- 3 In the Save Trace and Setup Menu, press **Format**; then, turn the Entry knob to select the type of file you want to save:
- **Setup (\*.scp)** – The oscilloscope's horizontal timebase, vertical sensitivity, trigger mode, trigger level, measurements, cursors, and math function settings that tell the oscilloscope how to make a particular measurement. See [“To save setup files”](#) on page 323.
  - **8-bit Bitmap image (\*.bmp)** – The complete screen image in a reduced color (8-bit) bitmap format. See [“To save BMP or PNG image files”](#) on page 324.
  - **24-bit Bitmap image (\*.bmp)** – The complete screen image in a 24-bit color bitmap format. See [“To save BMP or PNG image files”](#) on page 324.
  - **24-bit image (\*.png)** – The complete screen image in a 24-bit color PNG format that uses lossless compression. Files are much smaller than the BMP format. See [“To save BMP or PNG image files”](#) on page 324.
  - **CSV data (\*.csv)** – This creates a file of comma-separated values of all displayed channels and math waveforms. This format is suitable for spreadsheet analysis. See [“To save CSV, ASCII XY, or BIN data files”](#) on page 324.
  - **ASCII XY data (\*.csv)** – This creates separate files of comma-separated values for each displayed channel. This format is also suitable for spreadsheets. See [“To save CSV, ASCII XY, or BIN data files”](#) on page 324.
  - **Binary data (\*.bin)** – This creates a binary file, with a header, and data in the form of time and voltage pairs. This file is much smaller than the ASCII XY data file. See [“To save CSV, ASCII XY, or BIN data files”](#) on page 324.
  - **Lister data (\*.csv)** – This is a CSV format file containing serial decode row information with commas separating the columns. See [“To save Lister data files”](#) on page 327.
  - **Reference Waveform data (\*.h5)** – Saves waveform data in a format that can be recalled to one of the oscilloscope's reference waveform locations. See [“To save reference waveform files to a USB storage device”](#) on page 327.
  - **Multi Channel Waveform data (\*.h5)** – Saves multiple channels of waveform data in a format that can be opened by the N8900A Infiniium Offline oscilloscope analysis software. You can recall the first Analog or Math channel from a multi channel waveform data file.

- **Mask (\*.msk)** – This creates a mask file in a Keysight proprietary format that can be read by Keysight InfiniiVision oscilloscopes. A mask data file includes some oscilloscope setup information, but not all setup information. To save all setup information including the mask data file, choose "Setup (\*.scp)" format instead. See **"To save masks"** on page 328.
- **Arbitrary Waveform data (\*.csv)** – This creates a file of comma-separated values for the arbitrary waveform points' time and voltage values. See **"To save arbitrary waveforms"** on page 328.
- **Analysis Results (\*.csv)** – A file of comma-separated values is saved for the analysis types selected using the **Analysis Select** softkey.
- **Current Harmonics data (\*.csv), Power Supply Rejection Ration (PSRR) data (\*.csv), Control Loop Response (Bode) data (\*.csv)** – When the DSOX3PWR power analysis application is licensed, these options create a file of comma-separated values for the different types of analysis results. See the *PWR Power Measurement Application User's Guide* for more information.
- **Frequency Response Analysis data (\*.csv)** – This creates a file of comma-separated values for the Frequency Response Analysis results table values. In the saved file, there are three data columns: frequency (Hz), gain (dB), and phase (degrees). See **"To view and save the analysis results"** on page 298.

You can also configure the **[Quick Action]** key to save setups, screen images, or data. See **"Configuring the [Quick Action] Key"** on page 357.

## To save setup files

Setup files can be saved to one of 10 internal (\User Files) locations or to an external USB storage device.

- 1 Press **[Save/Recall] > Save > Format**; then, turn the Entry knob to select **Setup (\*.scp)**.
- 2 Press the softkey in the second position and use the Entry knob to navigate to the save location. See **"To navigate storage locations"** on page 329.
- 3 Finally, press the **Press to Save** softkey.

A message indicating whether the save was successful is displayed.

Setup files have the extension SCP. These extensions appear when using the File Explorer (see **"File Explorer"** on page 344), but they do not appear when using the Recall Menu.

## To save BMP or PNG image files

Image files can be saved to an external USB storage device.

- 1 Press **[Save/Recall] > Save > Format**; then, turn the Entry knob to select **8-bit Bitmap image (\*.bmp)**, **24-bit Bitmap image (\*.bmp)**, or **24-bit image (\*.png)**.
- 2 Press the softkey in the second position and use the Entry knob to navigate to the save location. See **"To navigate storage locations"** on page 329.
- 3 Press the **Settings** softkey.

In the File Settings Menu, you have these softkeys and options:

- **Setup Info** – setup information (vertical, horizontal, trigger, acquisition, math, and display settings) is also saved in a separate file with a TXT extension.
  - **Invert Graticule** – the graticule in the image file has a white background instead of the black background that appears on-screen.
  - **Palette** – lets you choose between **Color** or **Grayscale** images.
- 4 Finally, press the **Press to Save** softkey.

A message indicating whether the save was successful is displayed.

### NOTE

When saving screen images, the oscilloscope uses the last menu visited before pressing the **[Save/Recall]** key. This lets you save any relevant information within the softkey menu area.

To save a screen image showing the Save/Recall Menu at the bottom, press the **[Save/Recall]** key twice before saving the image.

### NOTE

You can also save the oscilloscope's display image using a web browser. See **"Get Image"** on page 369 for details.

See Also · **"To add an annotation"** on page 166

## To save CSV, ASCII XY, or BIN data files

Data files can be saved to an external USB storage device.

- 1 Press **[Save/Recall] > Save > Format**; then, turn the Entry knob to select **CSV data (\*.csv)**, **ASCII XY data (\*.csv)**, or **Binary data (\*.bin)**.

2 Press the softkey in the second position and use the Entry knob to navigate to the save location. See **"To navigate storage locations"** on page 329.

3 Press the **Settings** softkey.

In the File Settings Menu, you have these softkeys and options:

- **Setup Info** – when enabled, setup information (vertical, horizontal, trigger, acquisition, math, and display settings) is also saved in a separate file with a TXT extension.
- **Length** – sets the number of data points that will be output to the file. For more information, see **"Length Control"** on page 326.
- **Save Seg** – when data is acquired to segmented memory, you can specify whether the currently displayed segment is saved or all acquired segments are saved. (See also **"Saving Data from Segmented Memory"** on page 231.)

4 Finally, press the **Press to Save** softkey.

A message indicating whether the save was successful is displayed.

**CSV Data** When the CSV data (\*.csv) file format is selected, comma-separated values for each displayed waveform and digital channel pod are saved as multiple columns in a single file. Math FFT waveforms, whose values are in the frequency domain, are appended at the bottom of the .csv file. Pod names (for example, D0–D7) or waveform labels are used as column headers. This format is suitable for spreadsheet analysis.

For CSV data, length "N" value-at-time measurements are performed across the entire screen (using the measurement record data) for each active source. Interpolation between measurement record data points is performed as needed.

**ASCII XY Data** When the ASCII XY data (\*.csv) file format is selected, comma-separated value files for each displayed waveform, digital channel pod, digital bus, and serial bus are saved. For digital pods, an underscore (\_) and the pod name (for example, D0–D7) are appended to the specified file name; otherwise, an underscore and the waveform's label are appended.

If the oscilloscope acquisition is stopped, data from the raw acquisition record (which has more points than the measurement record) can be written. Press the **[Single]** key to obtain maximum memory depth with current settings. If enabled, serial decode data is saved.

When you want to save less than the maximum number of data points, a 1-of-N decimation is performed to produce an output whose length is less than or equal to the requested length. For example, if there are 100k points of data, and you specify a length of 2k, 1 of every 50 data points is saved.

- See Also**
- [“Binary Data \(.bin\) Format”](#) on page 381
  - [“CSV and ASCII XY files”](#) on page 388
  - [“Minimum and Maximum Values in CSV Files”](#) on page 389

## Length Control

The **Length** control is available when saving data to CSV, ASCII XY, or BIN format files. It limits the maximum number of data points that can be saved.

When **Max Length** is enabled, the maximum number of waveform data points is saved.

The actual number of data points saved depends on displayed data and on these factors:

- Whether acquisitions are running. When stopped, data comes from the raw acquisition record. When running, data comes from the smaller measurement record.
- Whether the oscilloscope was stopped using **[Stop]** or **[Single]**. Running acquisitions split memory to provide fast waveform update rates. Single acquisitions use full memory.
- Whether only one channel of a pair is turned on. (Channels 1 and 2 are one pair, channels 3 and 4 are the other.) Acquisition memory is divided among the channels in a pair.
- Whether reference waveforms are on. Displayed reference waveforms consume acquisition memory.
- Whether digital channels are on. Displayed digital channels consume acquisition memory.
- Whether segmented memory is on. Acquisition memory is divided by the number of segments.
- The horizontal time/div (sweep speed) setting. At faster settings, fewer data points appear on the display.
- When saving to a CSV format file, the maximum number of data points is 64K.

When necessary, the Length control performs a "1 of n" decimation of the data. For example: if the **Length** is set to 1000, and you are displaying a record that is 5000 data points in length, four of each five data points will be decimated, creating an output file 1000 data points in length.

When saving waveform data, the save times depend on the chosen format:

Data File Format	Save Times
BIN	fastest
ASCII XY	medium
CSV	slowest

- See Also
- ["Binary Data \(.bin\) Format"](#) on page 381
  - ["CSV and ASCII XY files"](#) on page 388
  - ["Minimum and Maximum Values in CSV Files"](#) on page 389

## To save Lister data files

Lister data files can be saved to an external USB storage device.

- 1 Press **[Save/Recall] > Save > Format**; then, turn the Entry knob to select **Lister data file**.
- 2 Press the softkey in the second position and use the Entry knob to navigate to the save location. See ["To navigate storage locations"](#) on page 329.
- 3 Press the **Settings** softkey.

In the File Settings Menu, you have these softkeys and options:

- **Setup Info** – when enabled, setup information (vertical, horizontal, trigger, acquisition, math, and display settings) is also saved in a separate file with a TXT extension.
- 4 Finally, press the **Press to Save** softkey.

A message indicating whether the save was successful is displayed.

## To save reference waveform files to a USB storage device

- 1 Press the **[Save/Recall]** key.

- 2 In the Save/Recall Menu, press the **Save** softkey.
- 3 In the Save Menu, press the **Format** softkey and turn the Entry knob to select **Reference Waveform data (\*.h5)**.
- 4 Press the **Source** softkey and turn the Entry knob to select the source waveform.
- 5 Press the softkey in the second position and use the Entry knob to navigate to the save location. See **"To navigate storage locations"** on page 329.
- 6 Finally, press the **Press to Save** softkey.

A message indicating whether the save was successful is displayed.

### To save masks

Mask files can be saved to one of four internal (\User Files) locations or to an external USB storage device.

- 1 Press **[Save/Recall] > Save > Format**; then, turn the Entry knob to select **Mask (\*.msk)**.
- 2 Press the softkey in the second position and use the Entry knob to navigate to the save location. See **"To navigate storage locations"** on page 329.
- 3 Finally, press the **Press to Save** softkey.

A message indicating whether the save was successful is displayed.

Mask files have the extension MSK.

#### NOTE

Masks are also saved as part of setup files. See **"To save setup files"** on page 323.

---

See Also · **Chapter 16**, "Mask Testing," starting on page 275

### To save arbitrary waveforms

Arbitrary waveform files can be saved to one of four internal (\User Files) locations or to an external USB storage device.

- 1 Press **[Save/Recall] > Save > Format**; then, turn the Entry knob to select **Arbitrary Waveform data (\*.csv)**.
- 2 Press the softkey in the second position and use the Entry knob to navigate to the save location. See **"To navigate storage locations"** on page 329.



- 3 Finally, press the **Press to Save** softkey.

A message indicating whether the save was successful is displayed.

**See Also** · ["To edit arbitrary waveforms"](#) on page 305

## To navigate storage locations

When saving or recalling files, the softkey in the second position of the Save Menu or Recall Menu, along with the Entry knob, are used to navigate to storage locations. The storage locations can be internal oscilloscope storage locations (for setup files or mask files) or they can be external storage locations on a connected USB storage device.

The softkey in the second position can have these labels:

- **Press to go** – when you can push the Entry knob to navigate to a new folder or storage location.
- **Location** – when you have navigated to the current folder location (and are not saving files).
- **Save to** – when you can save to the selected location.
- **Load from** – when you can recall from the selected file.

When saving files:

- The proposed file name is shown in the **Save to file =** line above the softkeys.
- To overwrite an existing file, browse to that file and select it. To create a new file name, see ["To enter file names"](#) on page 329.



## To enter file names

To create new file names when saving files to a USB storage device:

- 1 In the Save Menu, press the **File Name** softkey.

You must have a USB storage device connected to the oscilloscope for this softkey to be active.

- 2 In the File Name Menu, press the **File Name** softkey.
- 3 In the File Name keypad dialog, you can enter file names using:
  - The touch screen (when the front panel **[Touch]** key is lit).

- The  Entry knob. Turn the knob to select a key in the dialog; then, push the  Entry knob to enter it.
  - A connected USB keyboard.
  - A connected USB mouse – you can click anything on the screen that can be touched.
- 4 When you are done entering the file name, select the dialog's Enter or OK key or press the **File Name** softkey again.  
The file name appears in the softkey.
  - 5 When available, the **Increment** softkey can be used to enable or disable automatically incremented file names. Auto increment adds a numeric suffix to your file name and increments the number with each successive save. It will truncate characters as necessary when the file name length is at maximum and more digits are required for the numeric portion of the file name.

## Emailing Setups, Screen Images, or Data

You can send oscilloscope files over the network via e-mail. You can e-mail any file that can be saved.

To e-mail a setup, screen image, or data file:

- 1 Make sure the oscilloscope is connected to the local area network (see **"To establish a LAN connection"** on page 343).
- 2 Press the **[Save/Recall]** key.
- 3 In the Save/Recall Menu, press **Email**.
- 4 In the Email Menu, press **Format**; then, select the type of file you want to send.  
You can select from the same formats that are available when saving files. Settings for the selected format are also the same. See **"Saving Setups, Screen Images, or Data"** on page 321.
- 5 Press the **Attachment Name** softkey and use the keypad dialog to enter the name of the attachment file that will be sent.
- 6 In the e-mail configuration dialog box, touch the **To**, **From**, **Server**, and **Subject** fields and use the keypad dialog to enter the appropriate strings.

You can also enter these strings by pressing the **Config Email** softkey and the **To**, **From**, **Server**, and **Subject** softkeys in the **Configure Email Menu**.

You can specify multiple e-mail addresses by separating each address by a semi-colon.

The Server name is the name of your mail server running the Simple Mail Transfer Protocol (SMTP). If you do not know this name, ask your Network Administrator.

- 7 Finally, press the **Press to Send Email** softkey.

You can also configure the **[Quick Action]** key to e-mail setups, screen images, or data. See **"Configuring the [Quick Action] Key"** on page 357.

## Recalling Setups, Masks, or Data

- 1 Press the **[Save/Recall]** key.
- 2 In the Save/Recall Menu, press **Recall**.
- 3 In the Recall Menu, press **Recall:**, then, turn the Entry knob to select the type of file you want to recall:
  - **Setup (\*.scp)** – See **"To recall setup files"** on page 332.
  - **Mask (\*.msk)** – See **"To recall mask files"** on page 332.
  - **Reference Waveform data (\*.h5)** – See **"To recall reference waveform files from a USB storage device"** on page 332.
  - **Arbitrary Waveform data (\*.csv)** – See **"To recall arbitrary waveforms"** on page 333.
  - **CAN Symbolic data (\*.dbc)** – For CAN serial decode.
  - **LIN Symbolic data (\*.ldf)** – For LIN serial decode.

You can also recall setups and mask files by loading them using the File Explorer. See **"File Explorer"** on page 344.

You can also configure the **[Quick Action]** key to recall setups, masks, or reference waveforms. See **"Configuring the [Quick Action] Key"** on page 357.

## To recall setup files

Setup files can be recalled from one of 10 internal (\User Files) locations or from an external USB storage device.

- 1 Press **[Save/Recall] > Recall > Recall;** then, turn the Entry knob to select **Setup (\*.scp)**.
- 2 Press the softkey in the second position and use the Entry knob to navigate to the file to recall. See **"To navigate storage locations"** on page 329.
- 3 Press the **Press to Recall** softkey.  
A message indicating whether the recall was successful is displayed.
- 4 If you would like to clear the display, press **Clear Display**.

## To recall mask files

Mask files can be recalled from one of four internal (\User Files) locations or from an external USB storage device.

- 1 Press **[Save/Recall] > Recall > Recall;** then, turn the Entry knob to select **Mask (\*.msk)**.
- 2 Press the softkey in the second position and use the Entry knob to navigate to the file to recall. See **"To navigate storage locations"** on page 329.
- 3 Press the **Press to Recall** softkey.  
A message indicating whether the recall was successful is displayed.
- 4 If you would like to clear the display or clear the recalled mask, press **Clear Display** or **Clear Mask**.

## To recall reference waveform files from a USB storage device

- 1 Press the **[Save/Recall]** key.
- 2 In the Save/Recall Menu, press the **Recall** softkey.
- 3 In the Recall Menu, press the **Recall** softkey and turn the Entry knob to select **Reference Waveform data (\*.h5)**.
- 4 Press the **To Ref:** softkey and turn the Entry knob to select the desired reference waveform location.
- 5 Press the softkey in the second position and use the Entry knob to navigate to the file to recall. See **"To navigate storage locations"** on page 329.
- 6 Press the **Press to Recall** softkey.

A message indicating whether the recall was successful is displayed.

- 7 If you would like to clear the display of everything except the reference waveform, press **Clear Display**.

## To recall arbitrary waveforms

Arbitrary waveform files can be recalled from one of four internal (\User Files) locations or from an external USB storage device.

When recalling arbitrary waveforms (from an external USB storage device) that were not saved from the oscilloscope, be aware that:

- If the file contains two columns, the second column is automatically chosen.
- If the file contains more than two columns, you are prompted to select which column to load. Up to five columns are parsed by the oscilloscope; columns above the fifth are ignored.
- The oscilloscope uses a maximum of 8192 points for an arbitrary waveform. For more efficient recalls, make sure your arbitrary waveforms are 8192 points or less.

To recall an arbitrary waveform:

- 1 Press **[Save/Recall] > Recall > Recall**; then, turn the Entry knob to select **Arbitrary Waveform data (\*.csv)**.
- 2 Press the softkey in the second position and use the Entry knob to navigate to the file to recall. See **"To navigate storage locations"** on page 329.
- 3 Press the **Press to Recall** softkey.

A message indicating whether the recall was successful is displayed.

- 4 If you would like to clear the display, press **Clear Display**.

See Also • **"To edit arbitrary waveforms"** on page 305

## Recalling Default Setups

- 1 Press the **[Save/Recall]** key.
- 2 In the Save/Recall Menu, press **Default/Erase**.
- 3 In the Default Menu, press one of these softkeys:

- **Default Setup**— recalls the oscilloscope's default setup. This is the same as pressing the front panel **[Default Setup]** key. See “**Recall the Default Oscilloscope Setup**” on page 33.

Some user settings are not changed when recalling the default setup.

- **Factory Default**— recalls the oscilloscope's factory default settings.

You must confirm the recall because there are no user settings that are left unchanged.

## Performing a Secure Erase

- 1 Press the **[Save/Recall]** key.
- 2 In the Save/Recall Menu, press **Default/Erase**.
- 3 In the Default menu, press **Secure Erase**.

This performs a secure erase of all non-volatile memory in compliance with National Industrial Security Program Operation Manual (NISPOM) Chapter 8 requirements.

You must confirm the secure erase, and the oscilloscope will reboot when finished.

# 21 Print (Screens)

To print the oscilloscope's display / 335

To set up network printer connections / 337

To specify the print options / 338

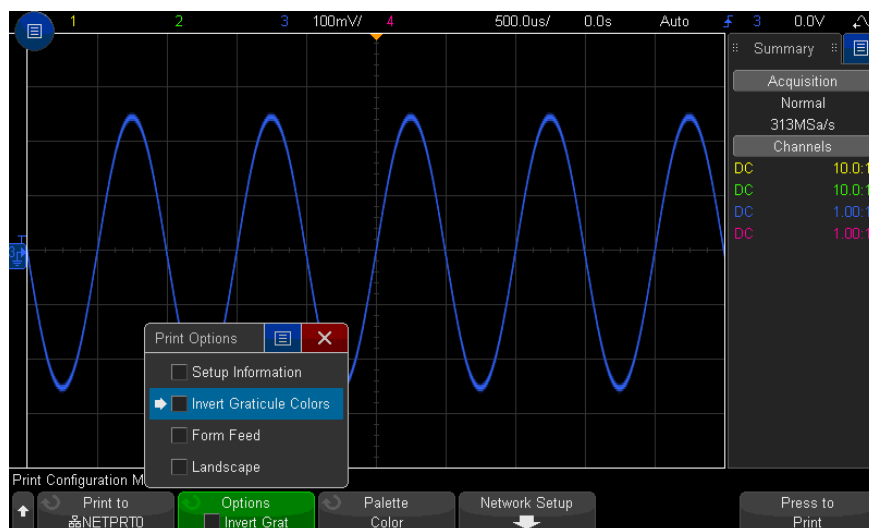
To specify the palette option / 339

You can print the complete display, including the status line and softkeys, to a USB printer or a network printer when the LAN connection is used.

The Print Configuration Menu is displayed when you press the **[Print]** key. The print option softkeys and the **Press to Print** softkey are ghosted (not available) until a printer is connected.

## To print the oscilloscope's display

- 1 Connect a printer. You can:
  - Connect a USB printer to one of the the USB ports on the front panel or the rectangular USB host port on the rear panel.  
  
For the most up-to-date listing of printers that are compatible with the InfiniiVision oscilloscopes, please visit [www.keysight.com/find/InfiniiVision-printers](http://www.keysight.com/find/InfiniiVision-printers).
  - Set up a network printer connection. See "**To set up network printer connections**" on page 337.
- 2 Press the **[Print]** key on the front panel.
- 3 In the Print Configuration Menu, press the **Print to** softkey; then, turn the Entry knob to select the desired printer.
- 4 Press the **Options** softkey to select the print options.



See [“To specify the print options”](#) on page 338.

- 5 Press the **Palette** softkey to select the print palette. See [“To specify the palette option”](#) on page 339.
- 6 Press the **Press to Print** softkey.

You can stop printing by pressing the **Cancel Print** softkey.

## NOTE

The oscilloscope will print the last menu visited before you pressed the **[Print]** key. Therefore, if you have measurements (Amplitude, Frequency, etc.) showing on the display before you press **[Print]**, the measurements will be shown on the printout.

To print the display showing the Print Configuration Menu at the bottom, press the **[Print]** key twice; then, press the **Press to Print** softkey.

You can also configure the **[Quick Action]** key to print the display. See [“Configuring the \[Quick Action\] Key”](#) on page 357.



See Also • [“To add an annotation”](#) on page 166



## To set up network printer connections

When the oscilloscope is connected to a LAN, you can set up network printer connections.

A *network printer* is a printer attached to a computer or print server on the network.

- 1 Press the **[Print]** key on the front panel.
- 2 In the Print Configuration Menu, press the **Print to** softkey; then, turn the Entry knob to select the network printer you want to configure (either #0 or #1).
- 3 Press the **Network Setup** softkey.
- 4 In the Network Printer Setup Menu:
  - a Press the **Address** softkey.
  - b In the Address keypad dialog, you can enter text using:
    - The touch screen (when the front panel **[Touch]** key is lit).
    - The  Entry knob. Turn the knob to select a key in the dialog; then, push the  Entry knob to enter it.
    - A connected USB keyboard.
    - A connected USB mouse – you can click anything on the screen that can be touched.

The Address is the printer or print server's address in one of the following formats:

- IP address of a network-enabled printer (for example: 192.168.1.100 or 192.168.1.100:650). Optionally, a non-standard port number can be specified following a colon.
  - IP address of a print server followed by the path to the printer (for example: 192.168.1.100/printers/printer-name or 192.168.1.100:650/printers/printer-name).
  - Path to a Windows network printer share (for example: \\server\share).
- c When you are done entering text, select the dialog's Enter or OK key or press the **Address** softkey again.

The address appears in the softkey.

- d** When the **Address** is a Windows network printer share, these softkeys appear and let you enter additional settings:
- **Domain** – this is the Windows network domain name.
  - **Username** – this is your login name for the Windows network domain.
  - **Password** – this is your login password for the Windows network domain.
- To clear an entered password, press the Clear key in the Password keypad dialog.
- e** Press the **Apply** softkey to make the printer connection.
- A message appears to tell you whether the connection was successful.

## To specify the print options

In the Print Configuration Menu, press the **Options** softkey to change the following options:

- **Setup Information** – Select this to print oscilloscope setup information on your printout, including vertical, horizontal, trigger, acquisition, math, and display settings.
- **Invert Graticule Colors** – Select this to reduce the amount of black ink it takes to print oscilloscope images by changing the black background to white. **Invert Graticule Colors** is the default mode.
- **Form Feed** – Select this to send a form feed command to the printer after the waveform is printed and before the setup information is printed. Switch **Form Feed** off if you want setup information printed on the same sheet of paper with the waveform. This option only has an effect when the **Setup Information** option is selected. Also, if the amount of setup information will not fit on the same page with the waveform, it will be printed on a new page regardless of the **Form Feed** setting.
- **Landscape** – Select this to print horizontally on the page instead of vertically (portrait mode).

## To specify the palette option

In the Print Configuration Menu, press the **Palette** softkey to change the following options.

- **Color** – Select this to print the screen in color.
- **Grayscale** – Select this to print the screen in shades of gray rather than in color.



## 22 Utility Settings

I/O Interface Settings /	341
Setting up the Oscilloscope's LAN Connection /	342
File Explorer /	344
Setting Oscilloscope Preferences /	346
Setting the Oscilloscope's Clock /	349
Setting the Rear Panel TRIG OUT Source /	350
Enabling Remote Command Logging /	351
Performing Service Tasks /	352
Configuring the [Quick Action] Key /	357

This chapter explains oscilloscope utility functions.

### I/O Interface Settings

The oscilloscope can be accessed and/or controlled remotely via these I/O interfaces:

- USB device port on the rear panel (square shaped USB port).
- LAN interface on the rear panel.

To configure the I/O interfaces:

- 1** On the oscilloscope's front panel, press **[Utility]**.
- 2** In the Utility Menu, press **I/O**.
- 3** In the I/O Menu, press **Configure**.

- **LAN** – When connected to a LAN, you can use the **LAN Settings** and **LAN Reset** softkeys to configure the LAN interface. See **“Setting up the Oscilloscope's LAN Connection”** on page 342.

When an I/O interface is installed, remote control over that interface is always enabled. Also, the oscilloscope can be controlled via multiple I/O interfaces (for example, USB and LAN) at the same time.

- See Also**
- **Chapter 23**, “Web Interface,” starting on page 359 (when the oscilloscope is connected to a LAN).
  - **“Remote Programming via the Web Interface”** on page 365
  - The oscilloscope's *Programmer's Guide*.
  - **“Remote Programming with Keysight IO Libraries”** on page 366

## Setting up the Oscilloscope's LAN Connection

Using the rear panel LAN port, you can place the oscilloscope on the network and set up its LAN connection. Once that is done, you can set up and use network printers or use the oscilloscope's web interface or remotely control the oscilloscope via the LAN interface.

The oscilloscope supports methods for automated LAN configuration or manual LAN configuration (see **“To establish a LAN connection”** on page 343). It is also possible to set up a point-to-point LAN connection between a PC and the oscilloscope (see **“Stand-alone (Point-to-Point) Connection to a PC”** on page 344).

Once the oscilloscope is set up on the network, you can use the oscilloscope's web page to view or change its network configuration and access additional settings (like the network password). See **Chapter 23**, “Web Interface,” starting on page 359.

### NOTE

When you connect the oscilloscope to a LAN it is a good practice to limit access to the oscilloscope by setting a password. By default, the oscilloscope is not password protected. See **“Setting a Password”** on page 372 to set a password.

**NOTE**

Any time you modify the oscilloscope's hostname, it breaks the connection between the oscilloscope and the LAN. You need to re-establish communication to the oscilloscope using the new hostname.

---

### To establish a LAN connection

#### Automatic Configuration

- 1 Press **[Utility] > I/O**.
- 2 Press the **LAN Settings** softkey.
- 3 Press the **Config** softkey; then, turn the Entry knob to select **Automatic**, and press the softkey again to enable it.  
  
If your network supports DHCP or AutoIP, enabling **Automatic** lets the oscilloscope use those services to get its LAN configuration settings
- 4 If your network provides Dynamic DNS, you can enable the **Dynamic DNS** option to let the oscilloscope register its hostname and use the DNS server for name resolution.
- 5 You can enable the **Multicast DNS** option to let the oscilloscope use Multicast DNS for name resolution on small networks without a conventional DNS server.
- 6 Connect the oscilloscope to the local area network (LAN) by inserting the LAN cable into the "LAN" port on the rear panel of the oscilloscope.

In a few moments the oscilloscope will connect to the network automatically.

If the oscilloscope does not automatically connect to the network, press **[Utility] > I/O > LAN Reset**. In a few moments the oscilloscope will connect to the network.

#### Manual Configuration

- 1 Get the oscilloscope's network parameters (host name, IP address, subnet mask, gateway IP, DNS IP, etc.) from your network administrator.
- 2 Press **[Utility] > I/O**.
- 3 Press the **LAN Settings** softkey.
- 4 Press the **Config** softkey; then, turn the Entry knob to select **Automatic**, and press the softkey again to disable it.

If Automatic is not enabled, the oscilloscope's LAN configuration must be set up manually using the **Modify** and **Host name** softkeys

- 5 Configure the oscilloscope's LAN interface:
  - a Use the **Modify** softkey (and the other softkeys and keypad entry dialogs) to enter the IP Address, Subnet Mask, Gateway IP, and DNS IP values.
  - b Press the **Host name** softkey and use the keypad entry dialog to enter the Host Name.
  - c Press the **Apply** softkey.
- 6 Connect the oscilloscope to the local area network (LAN) by inserting the LAN cable into the "LAN" port on the rear panel of the oscilloscope.

## Stand-alone (Point-to-Point) Connection to a PC

The following procedure describes how to establish a point-to-point (stand alone) connection to the oscilloscope. This is useful if you want to control the oscilloscope using a laptop computer or a stand-alone computer.

- 1 Press **[Utility] > I/O**.
- 2 Press the **LAN Settings** softkey.
- 3 Press the **Config** softkey; then, turn the Entry knob to select **Automatic**, and press the softkey again to enable it.

If your network supports DHCP or AutoIP, enabling **Automatic** lets the oscilloscope use those services to get its LAN configuration settings

- 4 Connect your PC to the oscilloscope using a cross-over LAN cable such as Keysight part number 5061-0701, available on the web at [www.keysight.com/find/parts](http://www.keysight.com/find/parts).
- 5 Cycle power on the oscilloscope. Wait until the LAN connection is configured:
  - Press **[Utility] > I/O** and wait until the LAN status shows "configured".

This may take a few minutes.

Now, the instrument is connected, and the instrument's web interface or remote control via LAN may be used.

## File Explorer

The File Explorer lets you navigate the oscilloscope's internal file system and the file systems of connected USB storage devices.

From the internal file system, you can load oscilloscope setup files or mask files.



From a connected USB storage device, you can load setup files, mask files, license files, firmware update (\*.ksx) files, label files, etc. Also, you can delete files on a connected USB storage device.

**NOTE**

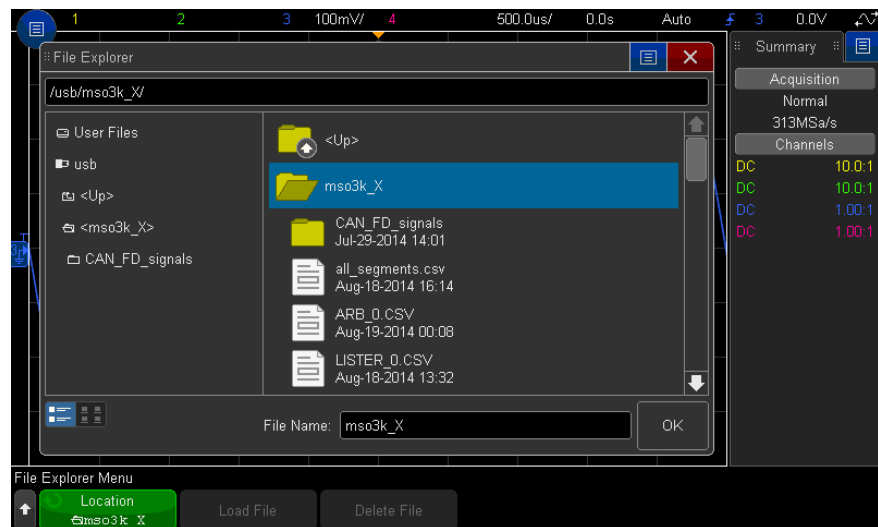
The USB port on the front panel, and the USB port on the rear panel labeled "HOST" are USB Series A receptacles. These are the receptacles to which you can connect USB mass storage devices and printers.

The square receptacle on the rear panel labeled "DEVICE" is provided for controlling the oscilloscope over USB. See the *Programmer's Guide* for more information.

The oscilloscope's internal file system, under "\User Files", consists of 10 locations for oscilloscope setup files, four locations for mask files, and four locations for waveform generator arbitrary waveform files.

To use the File Explorer:

- 1 Press **[Utility] > File Explorer**.
- 2 In the File Explorer Menu, press the softkey in the first position and use the Entry knob to navigate.



The softkey in the first position can have these labels:

- **Press to go** – when you can push the Entry knob to navigate to a new folder or storage location.
- **Location** – when pointing to a directory that is currently selected.
- **Selected** – when pointing to a file that can be loaded or deleted.

When this label appears, you can press the **Load File** or **Delete File** softkeys to take the action.

Pushing the Entry knob is the same as pressing the **Load File** softkey.

A file that has been deleted from a USB storage device cannot be recovered by the oscilloscope.

Use your PC to create directories on a USB storage device.

### USB Storage Devices

Most USB mass storage devices are compatible with the oscilloscope. However, certain devices may be incompatible, and may not be able to be read or written to. USB storage devices must be formatted with the FAT or FAT32 file system format.

When the USB mass storage device is connected to the oscilloscope's front or rear USB host port, a small four-color circle icon may be displayed briefly as the USB device is read.

You do not need to "eject" the USB mass storage device before removing it. Simply ensure that any file operation you've initiated is done, and remove the USB drive from the oscilloscope's host port.

Do not connect USB devices that identify themselves as hardware type "CD" because these devices are not compatible with the InfiniiVision X-Series oscilloscopes.

If two USB mass storage devices are connected to the oscilloscope, the first one is designated "\usb" and the second one is designated "\usb2".

**See Also** • **Chapter 20**, "Save/Email/Recall (Setups, Screens, Data)," starting on page 321

## Setting Oscilloscope Preferences

The User Preferences Menu (under **[Utility] > Options > Preferences**) lets you specify oscilloscope preferences.

- **"To choose "expand about" center or ground"** on page 347
- **"To disable/enable transparent backgrounds"** on page 347

- ["To load the default label library"](#) on page 347
- ["To set up the screen saver"](#) on page 348
- ["To set Autoscale preferences"](#) on page 349


## To choose "expand about" center or ground

When you change a channel's volts/division setting, the waveform display can be set to expand (or compress) about the signal ground level or the center of the display.

To set the waveform expansion reference point:

**1** Press **[Utility] > Options > Preferences > Expand** and select:

- **Ground**— The displayed waveform will expand about the position of the channel's ground. This is the default setting.

The ground level of the signal is identified by the position of the ground level () icon at the far-left side of the display.

The ground level will not move when you adjust the vertical sensitivity (volts/division) control.

If the ground level is off screen, the waveform will expand about the top or bottom edge of the screen based on where the ground is off screen.

- **Center**— The displayed waveform will expand about the center of the display.

## To disable/enable transparent backgrounds

There is a preference setting for whether measurements, statistics, reference waveform information, and other text displays have transparent or solid backgrounds.

**1** Press **[Utility] > Options > Preferences**.

**2** Press **Transparent** to toggle between transparent and solid text display backgrounds.

## To load the default label library

See ["To reset the label library to the factory default"](#) on page 165.

## To set up the screen saver

The oscilloscope can be configured to turn on a display screen saver when the oscilloscope has been idle for a specified length of time.

- 1 Press **[Utility] > Options > Preferences > Screen Saver** to display the Screen Saver Menu.





- 2 Press the **Screen Saver** softkey to select the screen saver type.

The screen saver can be set to **Off**, to display any of the images shown in the list, or can display a user-defined text string.

If **User** is selected:



- a Press the **Text** softkey.
- b In the Text keypad dialog, you can enter text using:
  - The touch screen (when the front panel **[Touch]** key is lit).
  - The  Entry knob. Turn the knob to select a key in the dialog; then, push the  Entry knob to enter it.
  - A connected USB keyboard.
  - A connected USB mouse – you can click anything on the screen that can be touched.
- c When you are done entering text, select the dialog's Enter or OK key or press the **Text** softkey again.

The user-defined screen saver text appears in the softkey.

- 3 Press the **Wait** softkey; then, turn the Entry knob to select the number of minutes to wait before the selected screen saver activates.

When you turn the Entry knob, the number of minutes is displayed on the **Wait** softkey. The default time is 180 minutes (3 hours).

- 4 Press the **Preview** softkey to preview the screen saver you have selected with the **Saver** softkey.
- 5 To view the normal display after the screen saver has started, press any key or turn any knob.

## To set Autoscale preferences

- 1 Press **[Utility] > Options > Preferences > Autoscale**.
- 2 In the Autoscale Preferences Menu, you can:
  - Press the **Fast Debug** softkey enable/disable this type of autoscale.  
 When fast debug is enabled, autoscale lets you make quick visual comparisons to determine whether the signal being probed is a DC voltage, ground, or an active AC signal.  
 Channel coupling is maintained to allow easy viewing of oscillating signals.
  - Press the **Channels** softkey and turn the Entry knob to specify the channels to be autoscaled:
    - **All Channels** – The next time you press **[Auto Scale]**, all channels that meet the requirements of Autoscale will be displayed.
    - **Only Displayed Channels** – The next time you press **[Auto Scale]**, only the channels that are turned on will be examined for signal activity. This is useful if you only want to view specific active channels after pressing **[Auto Scale]**.
  - Press the **Acq Mode** softkey and turn the Entry knob to select whether the acquisition mode should be preserved during autoscale:
    - **Normal** – to make the oscilloscope switch to Normal acquisition mode whenever the **[Auto Scale]** key is pressed. This is the default mode.
    - **Preserve** – to make the oscilloscope remain in the acquisition mode you have chosen when the **[Auto Scale]** key is pressed.

## Setting the Oscilloscope's Clock

The Clock Menu lets you set the current date and time of day (24-hour format). This time/date stamp will appear on hardcopy prints and directory information on the USB mass storage device.

To set the date and time, or to view the current date and time:

- 1 Press **[Utility] > Options > Clock**.



- 2 Press the **Year**, **Month**, **Day**, **Hour** or **Minute** softkey; then, rotate the Entry knob to set to the desired number.

The hours are shown in the 24-hour format. So 1:00 PM is hour 13.

The real-time clock only allows selection of valid dates. If a day is selected and the month or year is changed so the day is invalid, the day is automatically adjusted.

## Setting the Rear Panel TRIG OUT Source

You can choose the source of the TRIG OUT connector on the rear panel of the oscilloscope:

- 1 Press **[Utility] > Options > Rear Panel**.
- 2 In the Rear Panel Menu, press **Trig Out**; then, turn the Entry knob to select from:
  - **Triggers**— Each time the oscilloscope triggers, a rising edge occurs on TRIG OUT. The rising edge is delayed 30 ns from the oscilloscope's trigger point. The output level is 0-5 V into an open circuit, and 0-2.5 V into 50  $\Omega$ . See [Chapter 11](#), “Triggers,” starting on page 169.
  - **Mask**— The pass/fail status is evaluated periodically. When the evaluation of the testing period results in a failure, the trigger output pulses high (+5 V). Otherwise, the trigger output remains at low (0 V). See [Chapter 16](#), “Mask Testing,” starting on page 275.
  - **Waveform Generator Sync Pulse**— All of the waveform generator output functions (except DC, Noise, and Cardiac) have an associated Sync signal:
 

The Sync signal is a TTL positive pulse that occurs when the waveform rises above zero volts (or the DC offset value).

See [Chapter 19](#), “Waveform Generator,” starting on page 301.

- **Trigger Source**— The raw trigger signal from the oscilloscope's trigger circuit is output to Trig Out. It produces a rising edge whenever the input source would cause a trigger, even though that might occur multiple times within the time of a single acquisition. The trigger source can be a front panel analog input channel or an external trigger input. The output level is 0-5 V into an open circuit, and 0-2.5 V into 50  $\Omega$ . This option is not available in all trigger modes.

The TRIG OUT connector also provides the User Calibration signal. See **“To perform user calibration”** on page 352.

## Enabling Remote Command Logging

When remote command logging is enabled, remote commands sent to the instrument (and results returned by the instrument) can be logged to the screen, to a text file on a USB storage device, or to both the screen and a text file.

To enable remote command logging:

- 1 Press **[Utility] > Options > Remote Log** to open the Remote Log Menu:



- 2 Press **Enable** to enable or disable the remote command logging feature.

When remote logging is enabled, additional debug information can be included in the returned error string. If the error is detected by the SCPI command parser, such as a header error or other syntax error, the extra debug information is generated and included. But if the error is detected by the oscilloscope system, such as when an out-of-range value is sent, then no extra debug information is included.

- 3 Press **Destination** to select whether remote commands are logged to a text file (on a connected USB storage device), logged to the screen, or both.
- 4 Press **Write Mode** to specify whether logged commands will be created in a new list or appended to existing logged commands.

Your selection takes effect when remote command logging is enabled.

This option applies to both screen and file logging.

- 5 Press **File Name** to open the Remote Log Filename Menu where you can specify the name of the file (on the USB storage device) to which remote commands are logged.
- 6 Press **Display On** to enable or disable the screen display of logged remote commands and their return values (if applicable).
- 7 Press **Transparent** to disable or enable a transparent background for the remote command logging screen display.

Enable to make the background transparent. This lets you view underlying waveforms.

Disable for a solid background which makes the logged remote commands easier to read.

## Performing Service Tasks

The Service Menu (under **[Utility] > Service**) lets you perform service-related tasks:



- **"To perform user calibration"** on page 352
- **"To perform hardware self test"** on page 355
- **"To perform front panel self test"** on page 356
- **"To display oscilloscope information"** on page 356
- **"To display the user calibration status"** on page 356

For other information related to oscilloscope maintenance and service, see:

- **"To clean the oscilloscope"** on page 356
- **"To check warranty and extended services status"** on page 356
- **"To contact Keysight"** on page 357
- **"To return the instrument"** on page 357

### To perform user calibration

Perform user-calibration:



- Every two years or after 4000 hours of operation.
- If the ambient temperature is  $>10^{\circ}\text{C}$  from the calibration temperature.
- If you want to maximize the measurement accuracy.

The amount of use, environmental conditions, and experience with other instruments help determine if you need shorter User Calibration intervals.

User Calibration performs an internal self-alignment routine to optimize the signal path in the oscilloscope. The routine uses internally generated signals to optimize circuits that affect channel sensitivity, offset, and trigger parameters.

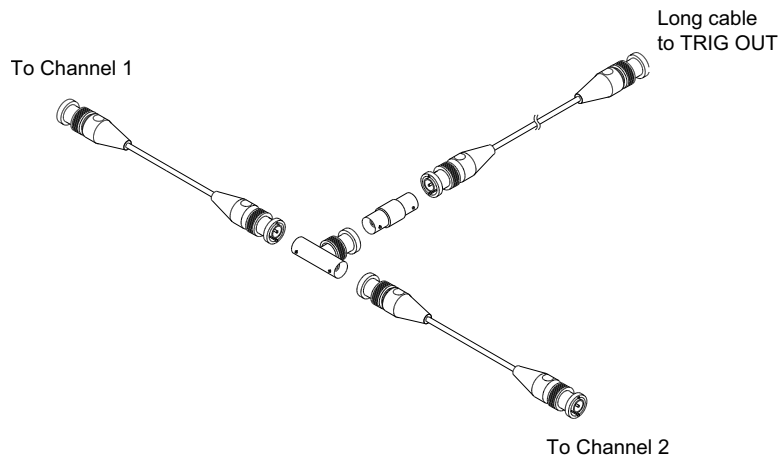
Performing User Calibration will invalidate your Certificate of Calibration. If NIST (National Institute of Standards and Technology) traceability is required, perform the "Performance Verification" procedure in the *Service Guide* using traceable sources.

To perform user calibration:

- 1** Disconnect all inputs from the front and rear panels, including the digital channels cable on an MSO, and allow the oscilloscope to warm up before performing this procedure.
- 2** Press the rear-panel CAL button to disable calibration protection.
- 3** Connect short (12 inch maximum) equal length cables to each analog channel's BNC connector on the front of the oscilloscope. You will need two equal-length cables for a 2-channel oscilloscope or four equal-length cables for a 4-channel oscilloscope.

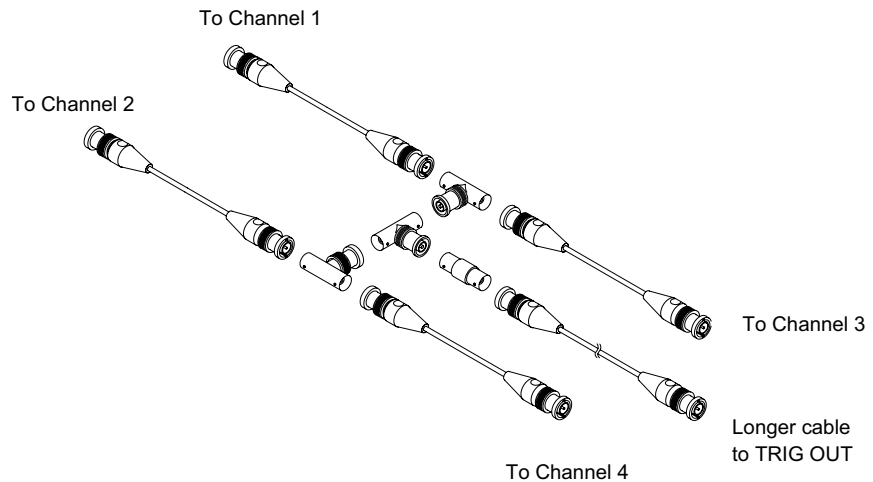
Use 50W RG58AU or equivalent BNC cables when performing User Calibration.

For a 2-channel oscilloscope, connect a BNC tee to the equal length cables. Then connect a BNC(f)-to-BNC(f) (also called a barrel connector) to the tee as shown below.



**Figure 50** User Calibration cable for 2-channel oscilloscope

For a 4-channel oscilloscope, connect BNC tees to the equal-length cables as shown below. Then connect a BNC(f)-to-BNC(f) (barrel connector) to the tee as shown below.



**Figure 51** User Calibration cable for 4-channel oscilloscope

- 4 Connect a BNC cable (40 inches maximum) from the TRIG OUT connector on the rear panel to the BNC barrel connector.
- 5 Press the **[Utility]** key; then, press the **Service** softkey.
- 6 Begin the Self Calibration by pressing the **Start User Calibration** softkey.

## To perform hardware self test

Pressing **[Utility] > Service > Hardware Self Test** performs a series of internal procedures to verify that the oscilloscope is operating properly.

It is recommended you run Hardware Self Test:

- After experiencing abnormal operation.
- For additional information to better describe an oscilloscope failure.
- To verify proper operation after the oscilloscope has been repaired.

Successfully passing Hardware Self Test does not guarantee 100% of the oscilloscope's functionality. Hardware Self Test is designed to provide an 80% confidence level that the oscilloscope is operating properly.

### To perform front panel self test

Pressing **[Utility] > Service > Front Panel Self Test** lets you test the front panel keys and knobs as well as the oscilloscope display.

Follow the on-screen instructions.

### To display oscilloscope information

Press **[Help] > About Oscilloscope** to display information about your oscilloscope:

- Model number.
- Serial number.
- Bandwidth.
- Module installed.
- Software version.
- Installed licenses. See also **"Loading Licenses and Displaying License Information"** on page 378.

### To display the user calibration status

Pressing **[Utility] > Service > User Calibration Status** displays the summary results of the previous User Calibration, and the status of probe calibrations for probes that can be calibrated. Note that passive probes do not need to be calibrated, but InfiniiMax probes can be calibrated. For more information about calibrating probes see **"To calibrate a probe"** on page 86.

### To clean the oscilloscope

- 1 Remove power from the instrument.
- 2 Clean the external surfaces of the oscilloscope with a soft cloth dampened with a mixture of mild detergent and water.
- 3 Make sure that the instrument is completely dry before reconnecting it to a power source.

### To check warranty and extended services status

To learn the warranty status of your oscilloscope:

- 1 Point your web browser to: [www.keysight.com/find/warrantystatus](http://www.keysight.com/find/warrantystatus)

- 2 Enter your product's model number and serial number. The system will search for the warranty status of your product and display the results. If the system cannot find your product's warranty status, select **Contact Us** and speak with a Keysight Technologies representative.

## To contact Keysight

Information on contacting Keysight Technologies can be found at:  
[www.keysight.com/find/contactus](http://www.keysight.com/find/contactus)

## To return the instrument

Before shipping the oscilloscope to Keysight Technologies, contact your nearest Keysight Technologies sales or service office for additional details. Information on contacting Keysight Technologies can be found at:

[www.keysight.com/find/contactus](http://www.keysight.com/find/contactus)

- 1 Write the following information on a tag and attach it to the oscilloscope.
  - Name and address of owner.
  - Model number.
  - Serial number.
  - Description of service required or failure indication.
- 2 Remove accessories from the oscilloscope.
 

Only return accessories to Keysight Technologies if they are associated with the failure symptoms.
- 3 Package the oscilloscope.
 

You can use the original shipping container, or provide your own materials sufficient to protect the instrument during shipping.
- 4 Seal the shipping container securely, and mark it FRAGILE.

## Configuring the [Quick Action] Key

The **[Quick Action]** key lets you perform common, repetitive actions by pressing a single key.

To configure the **[Quick Action]** key:

- 1 Press **[Utility]** > **Quick Action** > **Action**; then, select the action that should be performed:
  - **Off** – disables the **[Quick Action]** key.
  - **Quick Measure All** – displays a popup containing a snapshot of all the single waveform measurements. The **Source** softkey lets you select the waveform source (which also becomes the source selection in the Measurement Menu). See [Chapter 15](#), “Measurements,” starting on page 243.
  - **Quick Measure Statistics Reset** – resets all measurement statistics and the measurement count. See [“Measurement Statistics”](#) on page 272.
  - **Quick Mask Statistics Reset** – resets mask statistics and counters. See [“Mask Statistics”](#) on page 280.
  - **Quick Print** – prints the current screen image. Press **Settings** to set up the printing options. See [Chapter 21](#), “Print (Screens),” starting on page 335.
  - **Quick Save** – saves the current image, waveform data, or setup. Press **Settings** to set up the save options. See [Chapter 20](#), “Save/Email/Recall (Setups, Screens, Data),” starting on page 321.
  - **Quick Email** – e-mails the current setup, screen image, or data file. Press **Settings** to set up the e-mail options. See [“Emailing Setups, Screen Images, or Data”](#) on page 330.
  - **Quick Recall** – recalls a setup, mask, or reference waveform. Press **Settings** to set up the recall options. See [Chapter 20](#), “Save/Email/Recall (Setups, Screens, Data),” starting on page 321.
  - **Quick Freeze Display** – freezes the display without stopping running acquisitions or un-freezes the display if currently frozen. For more information, see [“To freeze the display”](#) on page 159.
  - **Quick Trigger Mode** – toggles the trigger mode between Auto and Normal, see [“To select the Auto or Normal trigger mode”](#) on page 208.
  - **Quick Clear Display** – clears the display, see [“To clear the display”](#) on page 158.

Once the **[Quick Action]** key is configured, you simply press it to perform the selected action.

## 23 Web Interface

Accessing the Web Interface / 360

Browser Web Control / 361

Save/Recall / 367

Get Image / 369

Identification Function / 370

Instrument Utilities / 370

Setting a Password / 372

When Keysight InfiniiVision 3000T X-Series oscilloscopes are set up on the LAN, you can access the oscilloscope's built-in web server using a Java™-enabled web browser. The oscilloscope's web interface lets you:

- View information about the oscilloscope like its model number, serial number, host name, IP address, and VISA (address) connect string.
- Control the oscilloscope using the Remote Front Panel.
- Send SCPI (Standard Commands for Programmable Instrumentation) remote programming commands via the SCPI Commands applet window.
- Save setups, screen images, waveform data, and mask files.
- Recall setup files, reference waveform data files, or mask files.
- Get screen images and save or print them from the browser.
- Activate the Identification function to identify a particular instrument by causing a message to be displayed or a front panel light to blink.
- View installed options, view firmware versions and install firmware upgrade files, and view calibration status (via the Instrument Utilities page).
- View and modify the oscilloscope's network configuration.

The web interface for InfiniiVision X-Series oscilloscopes also provides help for each of its pages.

Microsoft Internet Explorer is the recommended Web browser for communication and control of the oscilloscope. Other Web browsers may work but are not guaranteed to work with the oscilloscope. The Web browser must be Java-enabled.

Before you can use the web interface, you must place the oscilloscope on the network and set up its LAN connection.

## Accessing the Web Interface

To access the oscilloscope's web interface:


- 1 Connect the oscilloscope to your LAN (see **"To establish a LAN connection"** on page 343) or establish a point-to-point connection (see **"Stand-alone (Point-to-Point) Connection to a PC"** on page 344).

It is possible to use a point-to-point connection, but using a normal LAN connection is the preferred method.








- 2 Type the oscilloscope's hostname or IP address in the web browser.  
The oscilloscope's web interface Welcome Page is displayed.



Support | Products | Keysight Site


Oscilloscope


Another web-enabled Instrument  
from Keysight Technologies

-  Welcome Page
-  Browser Web Control
-  Save/Recall
-  Get Image
-  Instrument Utilities
-  Configure Network
-  Print Page
-  Help with this Page

Welcome to your

---

## Web-Enabled Oscilloscope MSO-X 3104T




Information about this Web-Enabled Instrument

Instrument	MSO-X 3104T Oscilloscope
Serial Number	MY53520044
Description	Agilent MSOX3104T Oscilloscope - MY53520044
DNS Hostname	a-mx3104t-20044.cos.agilent.com
NetBIOS Name	a-mx3104t-20044
Multicast DNS Hostname	a-mx3104t-20044.local.
IP Address	130.29.71.59
VISA TCP/IP Connect String	TCPIP0::a-mx3104t-20044::INSTR

▼ Advanced information
Identification:  off  on

Use the navigation bar on the left to access your oscilloscope and related information.

© Keysight Technologies, Inc. 2006-2014



## Browser Web Control

The web interface's Browser Web Control page gives you access to:

- The Full Scope Remote Front Panel (see **“Full Scope Remote Front Panel”** on page 362).
- The Screen Only Remote Front Panel (see **“Screen Only Remote Front Panel”** on page 363).
- The Tablet Remote Front Panel (see **“Tablet Remote Front Panel”** on page 364).
- The SCPI Command window applet for Remote Programming (see **“Remote Programming via the Web Interface”** on page 365).

**NOTE**

If Java is not installed on your PC, you will be prompted to install the Java Plug-in. This plug-in must be installed on the controlling PC for the web interface's Remote Front Panel or Remote Programming operations.

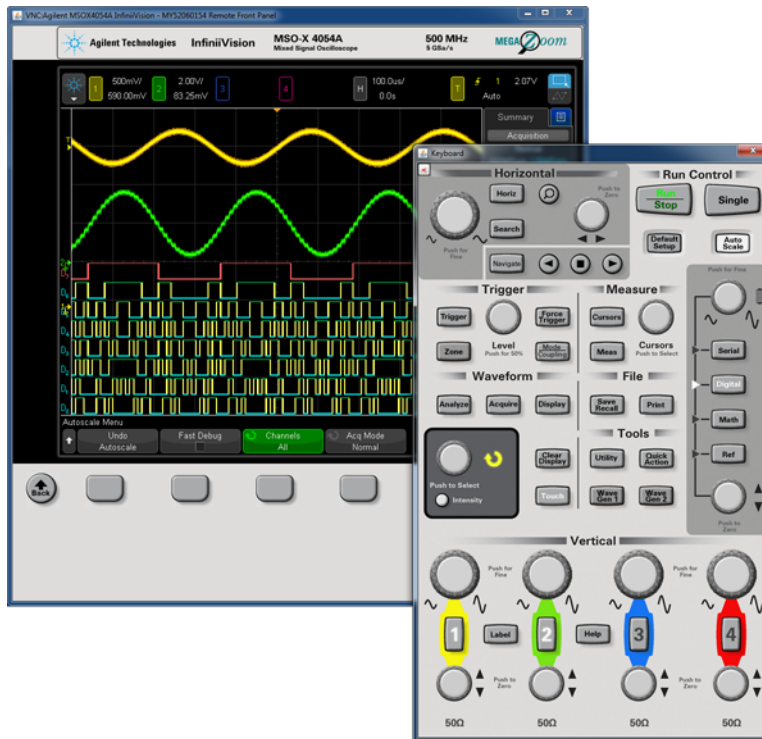
---

The SCPI Command window is useful for testing commands or entering a few commands interactively. When creating automated programs for controlling the oscilloscope, you will typically use the Keysight IO Libraries from within a programming environment like Microsoft Visual Studio (see [“Remote Programming with Keysight IO Libraries”](#) on page 366).

## Full Scope Remote Front Panel

To operate the oscilloscope using the web interface's Full Scope Remote Front Panel:

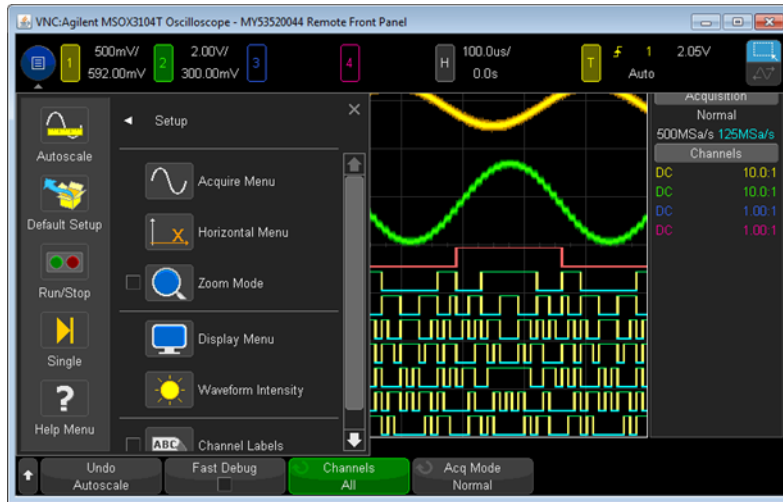
- 1 Access the oscilloscope's web interface (see [“Accessing the Web Interface”](#) on page 360).
- 2 When the oscilloscope's web interface is displayed, select **Browser Web Control**, then select **Full Scope Remote Front Panel**. After a few seconds the Remote Front Panel appears.
- 3 Click keys or knobs that you would normally press on the oscilloscope's front panel. Drag on edges of knobs to turn them.



## Screen Only Remote Front Panel

To operate the oscilloscope using the web interface's Screen Only Remote Front Panel:

- 1 Access the oscilloscope's web interface (see ["Accessing the Web Interface"](#) on page 360).
- 2 When the oscilloscope's web interface is displayed, select **Browser Web Control**, then select **Screen Only Remote Front Panel**. After a few seconds the Remote Front Panel appears.
- 3 Use the Main Menu and the Function Keys to control the oscilloscope. To view Quick Help, right-click on a softkey.



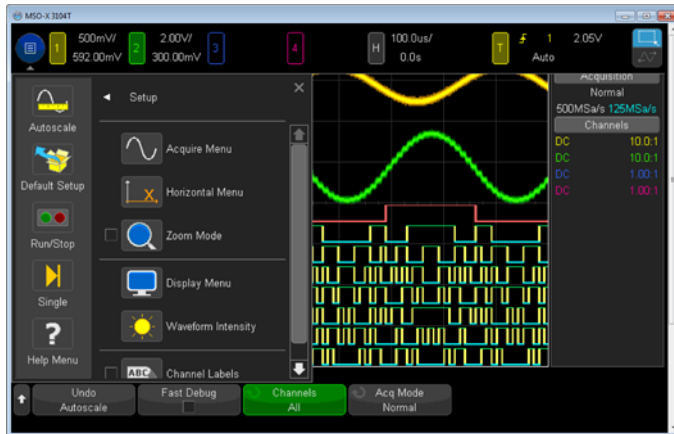
### Scrolling and Monitor Resolution

When using a monitor resolution of 800 x 600 or less on the remote computer, you need to scroll to access the full remote front panel. To display the remote front panel without scroll bars, use a monitor resolution greater than 800 x 600 on your computer's display.

### Tablet Remote Front Panel

To operate the oscilloscope using the web interface's Tablet Remote Front Panel:

- 1 Access the oscilloscope's web interface (see ["Accessing the Web Interface"](#) on page 360).
- 2 When the oscilloscope's web interface is displayed, select **Browser Web Control**, then select **Tablet Remote Front Panel**. After a few seconds the Remote Front Panel appears.
- 3 Click keys or knobs that you would normally press on the oscilloscope's front panel. Buttons have been added for turning knobs.



## Remote Programming via the Web Interface

To send remote programming commands to the oscilloscope via the SCPI Commands applet window:

- 1 Access the oscilloscope's web interface (see ["Accessing the Web Interface"](#) on page 360).
- 2 When the oscilloscope's web interface is displayed, select **Browser Web Control**, then select **Remote Programming**.

The SCPI Commands applet appears within the browser web page.

**KEYSIGHT TECHNOLOGIES** Oscilloscope

**Remote Programming**

You can send remote programming commands directly to your MSO-X 3104T oscilloscope using the tool below. commands, see the [Programming Commands Quick Reference](#).

Clear Commands Options

Command

\*IDN? Send

```

** Successfully connected to Agilent MSOX3104T Oscilloscope - MY53520044 **
> *IDN?
< KEYSIGHT TECHNOLOGIES,MSO-X 3104T,MY53520044,04.00.2014092901

```

## Remote Programming with Keysight IO Libraries

While the SCPI Commands applet window lets you enter and remote programming commands, remote programming for automated test and data acquisition is typically done using the Keysight IO Libraries, which are separate from the instrument's web interface.

The Keysight IO Libraries let a controller PC communicate with Keysight InfiniiVision X-Series oscilloscopes via their USB, LAN, or GPIB interfaces (if available).

The Keysight IO Libraries Suite connectivity software to enables communication over these interfaces. You can download the Keysight IO Libraries Suite from [www.keysight.com/find/iolib](http://www.keysight.com/find/iolib).

Information about controlling the oscilloscope through remote commands is contained in the *Programmer's Guide*, which is included on the documentation CD supplied with this oscilloscope. You can also access this document on the Keysight web site.

For more information about connecting to the oscilloscope, refer to the *Keysight Technologies USB/LAN/GPIB Interfaces Connectivity Guide*. For a printable electronic copy of the *Connectivity Guide*, direct your Web browser to [www.keysight.com](http://www.keysight.com) and search for "Connectivity Guide".

## Save/Recall

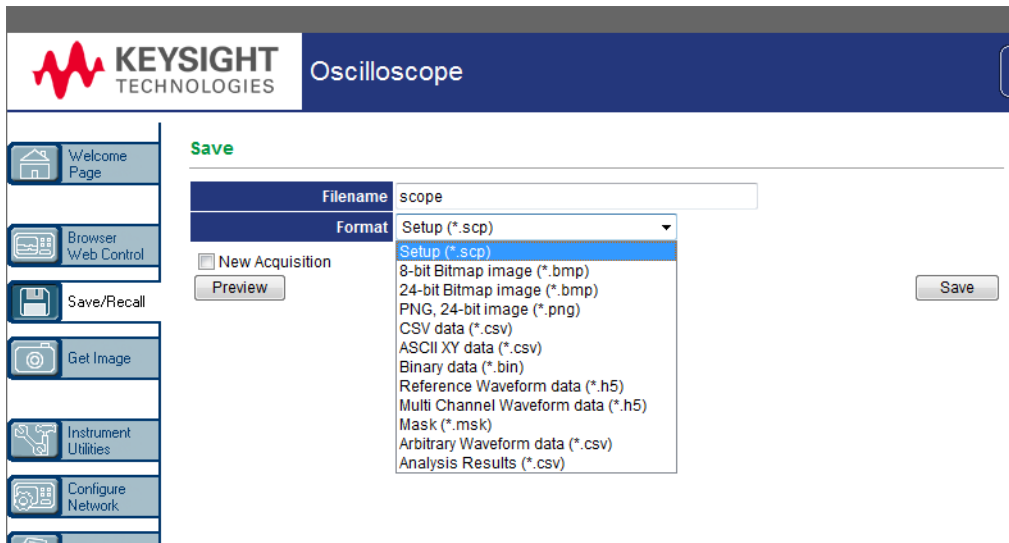
You can save setup files, screen images, waveform data files, or mask files to your PC via the oscilloscope's web interface (see "[Saving Files via the Web Interface](#)" on page 367).

You can recall setup files, reference waveform data files, or mask files from your PC via the oscilloscope's web interface (see "[Recalling Files via the Web Interface](#)" on page 368).

### Saving Files via the Web Interface

To save setup files, screen images, waveform data, Lister data, or mask files to your PC via the oscilloscope's web interface:

- 1 Access the oscilloscope's web interface (see "[Accessing the Web Interface](#)" on page 360).
- 2 When the oscilloscope's web interface is displayed, select the **Save/Recall** tab from the left side of the Welcome screen.
- 3 Click the **Save** link.
- 4 On the Save page:
  - a Enter the name of the file you are saving to.
  - b Select the format.



You can click **Preview** to view the oscilloscope's current screen image. When previewing, you can use the **New Acquisition** check box to force a new acquisition before the preview.

With some formats, you can click **Save Setup Info** to save setup information to an ASCII .txt format file.

**c** Click **Save**.

The current acquisition is saved.

**d** In the File Download dialog, click **Save**.

**e** In the Save As dialog, navigate to the folder where you want to save the file; then, click **Save**.

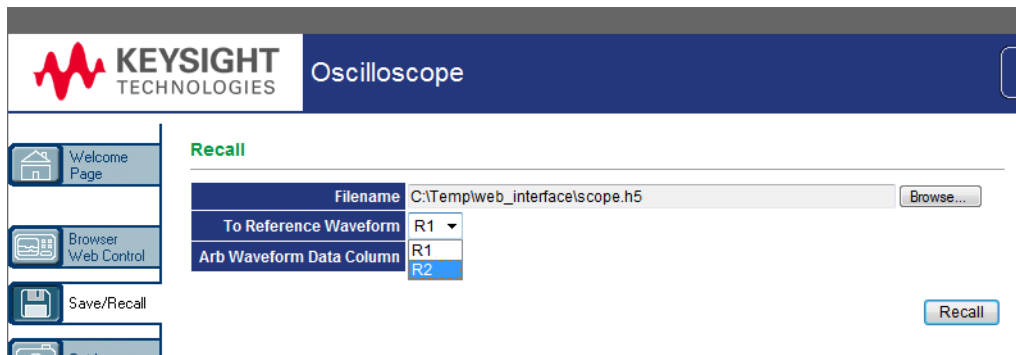
## Recalling Files via the Web Interface

To recall setup files, reference waveform data files, mask files, or arbitrary waveform files from your PC via the oscilloscope's web interface:

- 1** Access the oscilloscope's web interface (see **"Accessing the Web Interface"** on page 360).
- 2** When the oscilloscope's web interface is displayed, select the **Save/Recall** tab from the left side of the Welcome screen.



- 3 Click the **Recall** link.
- 4 On the Recall page:
  - a Click **Browse...**
  - b In the "Choose file" dialog, select the file you want to recall; then, click **Open**.
  - c When recalling reference waveform data files, select the **To Reference Waveform** location.



- d Click **Recall**.

## Get Image

To save (or print) the oscilloscope's display from the web interface:

- 1 Access the oscilloscope's web interface (see **"Accessing the Web Interface"** on page 360).
- 2 When the oscilloscope's web interface is displayed, select the **Get Image** tab from the left side of the Welcome screen. After a delay of several seconds, the oscilloscope's screen image will be displayed.
- 3 Right-click on the image and select **Save Picture As...** (or **Print Picture...**).
- 4 Select a storage location for the image file and click **Save**.

## Identification Function

The Identification web interface feature is useful when trying to locate a specific instrument in a rack of equipment.

- 1 Access the oscilloscope's web interface (see ["Accessing the Web Interface"](#) on page 360).
- 2 When the oscilloscope's web interface Welcome Page is displayed, select the Identification **on** radio button.

An "Identify" message is displayed on the oscilloscope; you can either select Identification **off** or press the **OK** softkey on the oscilloscope to continue.

The screenshot shows the web interface for an Agilent MSO-X 3104T Oscilloscope. The page title is "Web-Enabled Oscilloscope MSO-X 3104T". A table provides information about the instrument, and the Identification function is currently set to "on".

Information about this Web-Enabled Instrument	
Instrument	MSO-X 3104T Oscilloscope
Serial Number	MY53520044
Description	Agilent MSOX3104T Oscilloscope - MY53520044
DNS Hostname	a-mx3104t-20044.cos.agilent.com
NetBIOS Name	a-mx3104t-20044
Multicast DNS Hostname	a-mx3104t-20044.local
IP Address	130.29.71.59
VISA TCP/IP Connect String	TCPIP0::a-mx3104t-20044::INSTR

Advanced information Identification:  off  on

Use the navigation bar on the left to access your oscilloscope and related information.

© Keysight Technologies, Inc. 2006-2014

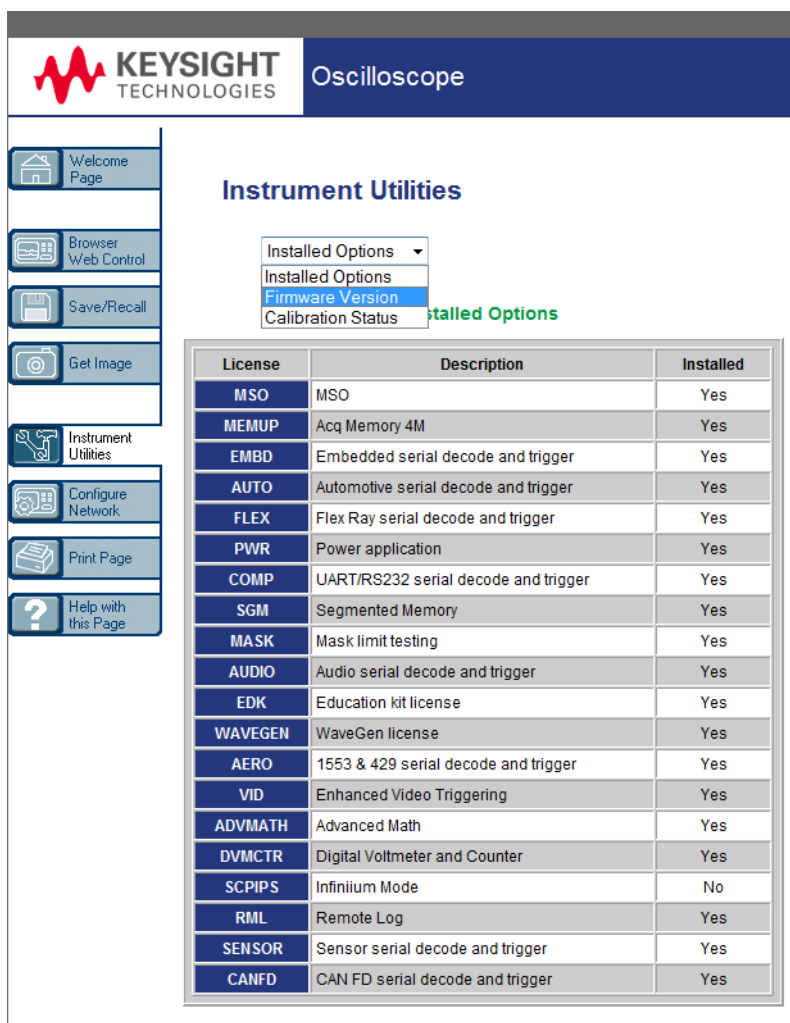
Identification option

## Instrument Utilities

The Instrument Utilities page of the web interface lets you:

- View installed options.
- View firmware versions.
- Install firmware upgrade files.
- View calibration status.

You can select these capabilities via a drop-down menu.



**KEYSIGHT TECHNOLOGIES** Oscilloscope

**Instrument Utilities**

Installed Options ▾  
 Installed Options  
**Firmware Version**  
 Calibration Status

Installed Options

License	Description	Installed
MSO	MSO	Yes
MEMUP	Acq Memory 4M	Yes
EMBD	Embedded serial decode and trigger	Yes
AUTO	Automotive serial decode and trigger	Yes
FLEX	Flex Ray serial decode and trigger	Yes
PWR	Power application	Yes
COMP	UART/RS232 serial decode and trigger	Yes
SGM	Segmented Memory	Yes
MASK	Mask limit testing	Yes
AUDIO	Audio serial decode and trigger	Yes
EDK	Education kit license	Yes
WAVEGEN	WaveGen license	Yes
AERO	1553 & 429 serial decode and trigger	Yes
VID	Enhanced Video Triggering	Yes
ADVMATH	Advanced Math	Yes
DVMCTR	Digital Voltmeter and Counter	Yes
SCPIPS	Infinium Mode	No
RML	Remote Log	Yes
SENSOR	Sensor serial decode and trigger	Yes
CANFD	CAN FD serial decode and trigger	Yes

## Setting a Password

Whenever you connect the oscilloscope to a LAN, it is good practice to set a password. The password prevents someone from remotely accessing the oscilloscope via a Web browser and changing parameters. Remote users can still view the Welcome screen, view network status, etc., but they can't operate the instrument or change its setup without the password.

To set a password:

- 1 Access the oscilloscope's web interface (see ["Accessing the Web Interface"](#) on page 360).
- 2 When the oscilloscope's web interface is displayed, select the Configure Network tab from the instrument's Welcome page.
- 3 Click the **Modify Configuration** button.

The screenshot shows the Keysight Oscilloscope web interface. The left sidebar contains navigation options: Welcome Page, Browser Web Control, Save/Recall, Get Image, Instrument Utilities, **Configure Network** (selected), Print Page, and Help with this Page. The main content area is titled 'Current Network Configuration' and features a 'Modify Configuration' button. Below the button is a table of network parameters.

Parameter	Currently in use
Configuration mode	Automatic
Dynamic DNS	ON
NetBIOS	ON
Multicast DNS	ON
Description	Agilent MSOX3104T Oscilloscope - MY53520044
IP Address	130.29.71.59
Subnet Mask	255.255.248.0
Default Gateway	130.29.64.1
DNS Server(s)	130.29.152.27, 130.29.152.28
Hostname	a-mx3104t-20044
Domain	cos.agilent.com
USB Control	ON
LAN Control	ON

- 4 Enter your desired password, and click **Apply Changes**.

Support | Pr

KEYSIGHT TECHNOLOGIES Oscilloscope Another web from Keysight

Welcome Page

Browser Web Control

Save/Recall

Get Image

Instrument Utilities

Configure Network

Print Page

Help with this Page

### Modify Network Configuration

Undo Changes LAN Reset Apply Changes

Parameter	Configured Value	Edit Configuration
<b>IP Settings may be configured using the following:</b>		
Automatic	ON	<input type="radio"/> OFF <input checked="" type="radio"/> ON
<b>IP Settings to use in non automatic mode:</b>		
IP Address	130.29.71.59	<input type="text" value="130.29.71.59"/>
Subnet Mask	255.255.248.0	<input type="text" value="255.255.248.0"/>
Default Gateway	130.29.64.1	<input type="text" value="130.29.64.1"/>
<b>Name service settings:</b>		
Hostname	a-mx3104t-20044	<input type="text" value="a-mx3104t-20044"/> *
DNS Server	130.29.152.27	<input type="text" value="130.29.152.27"/>
Multicast DNS	ON	<input type="radio"/> OFF <input checked="" type="radio"/> ON
<b>Other settings:</b>		
Description	Agilent MSOX3104T Oscilloscope - MY53520044	<input type="text" value="Agilent MSOX3104T Oscilloscope"/> *
Password		<input type="text" value="Keysight"/> → Enter password

\*Set to blank for factory default value

When accessing the password protected oscilloscope, the user name is the IP address of the oscilloscope.

To reset the password

Do one of these things to reset the password:

- Using the keys on the front panel of the oscilloscope, press **[Utility] > I/O > LAN Reset**.
- Using the web browser select the **Configure Network** tab, select **Modify Configuration**, erase the Password, and select **Apply Changes**.



## 24 Reference

Specifications and Characteristics /	375
Measurement Category /	375
Environmental Conditions /	377
Probes and Accessories /	378
Loading Licenses and Displaying License Information /	378
Software and Firmware Updates /	380
Binary Data (.bin) Format /	381
CSV and ASCII XY files /	388
Acknowledgements /	390
Product Markings and Regulatory Information /	392

### Specifications and Characteristics

Please see the InfiniiVision oscilloscope data sheets for complete, up-to-date specifications and characteristics. To download a data sheet, please visit:

[www.keysight.com/find/3000TX-Series](http://www.keysight.com/find/3000TX-Series)

### Measurement Category

- **"Oscilloscope Measurement Category"** on page 375
- **"Measurement Category Definitions"** on page 376
- **"Maximum Input Voltages"** on page 376

### Oscilloscope Measurement Category

The InfiniiVision oscilloscopes are not intended to be used for measurements in Measurement Category II, III, or IV.

**WARNING**

**Use this instrument only for measurements within its specified measurement category (not rated for CAT II, III, IV). No transient overvoltages allowed.**

---

## Measurement Category Definitions

The "Not rated for CAT II, III, IV" measurement category is for measurements performed on circuits not directly connected to MAINS. Examples are measurements on circuits not derived from MAINS, and specially protected (internal) MAINS derived circuits. In the latter case, transient stresses are variable; for that reason, the transient withstand capability of the equipment is made known to the user.


Measurement category II is for measurements performed on circuits directly connected to the low voltage installation. Examples are measurements on household appliances, portable tools and similar equipment.

Measurement category III is for measurements performed in the building installation. Examples are measurements on distribution boards, circuit-breakers, wiring, including cables, bus-bars, junction boxes, switches, socket-outlets in the fixed installation, and equipment for industrial use and some other equipment, for example, stationary motors with permanent connection to the fixed installation.

Measurement category IV is for measurements performed at the source of the low-voltage installation. Examples are electricity meters and measurements on primary overcurrent protection devices and ripple control units.

## Maximum Input Voltages

**CAUTION**

 **Maximum input voltage at analog inputs**

135 Vrms

**50 $\Omega$  input: 5 Vrms** Input protection is enabled in 50  $\Omega$  mode and the 50  $\Omega$  load will disconnect if greater than 5 Vrms is detected. However the inputs could still be damaged, depending on the time constant of the signal. The 50  $\Omega$  input protection only functions when the oscilloscope is powered on.


---



**CAUTION**

When measuring voltages over 30 V, use a 10:1 probe.

**CAUTION**

 Maximum input voltage at digital channels  
±40 V peak

## Environmental Conditions

Environment	Indoor use only.
Ambient temperature	Operating 0 °C to +55 °C; non-operating -30 °C to +70 °C
Humidity	Operating: 50% to 95% RH at 40 °C for 5 days. Non-operating: 90% RH at 65 °C for 24 hr.
Altitude	Maximum operating altitude: 3,000 m (9,842 ft)
Overvoltage Category	This product is intended to be powered by MAINS that comply to Overvoltage Category II, which is typical of cord-and-plug connected equipment.
Pollution Degree	The InfiniiVision 3000T X-Series oscilloscopes may be operated in environments of Pollution Degree 2 (or Pollution Degree 1).
Pollution Degree Definitions	<p>Pollution Degree 1: No pollution or only dry, non-conductive pollution occurs. The pollution has no influence. Example: A clean room or climate controlled office environment.</p> <p>Pollution Degree 2. Normally only dry non-conductive pollution occurs. Occasionally a temporary conductivity caused by condensation may occur. Example: General indoor environment.</p> <p>Pollution Degree 3: Conductive pollution occurs, or dry, non-conductive pollution occurs which becomes conductive due to condensation which is expected. Example: Sheltered outdoor environment.</p>

## Probes and Accessories

For a list of the probes and accessories that are compatible with the 3000T X-Series oscilloscopes, see the data sheet at:

[www.keysight.com/find/3000TX-Series](http://www.keysight.com/find/3000TX-Series)

### AutoProbe Interface

Most Keysight single-ended active, differential, and current probes are compatible with the AutoProbe interface. Active probes that do not have their own external power supply require substantial power from the AutoProbe interface.

If too much current is drawn from the AutoProbe interface, an error message will be displayed, indicating that you must momentarily disconnect all probes to reset the AutoProbe interface, then connect only the supported quantity of active probes.

### See Also

For more information on probes and accessories, see [www.keysight.com](http://www.keysight.com) for:

- [Probes and Accessories Selection Guide \(5989-6162EN\)](#)
- [InfiniiVision Oscilloscope Probes and Accessories Selection Guide Data Sheet \(5968-8153EN\)](#)
- For compatibility information, manuals, application notes, data sheets, selection guides, SPICE models, and more for oscilloscope probes, see the Probe Resource Center at: [www.keysight.com/find/PRC](http://www.keysight.com/find/PRC)

## Loading Licenses and Displaying License Information

License files are loaded from a USB storage device using the File Explorer (see ["File Explorer"](#) on page 344).

License information is displayed with other oscilloscope information (see ["To display oscilloscope information"](#) on page 356).

For more information about the licenses and other oscilloscope options available, see:

- ["Licensed Options Available"](#) on page 379
- ["Other Options Available"](#) on page 380
- ["Upgrading to an MSO"](#) on page 380

## Licensed Options Available

The following licensed options can be easily installed without returning the oscilloscope to a Service Center. See data sheets for details.

**Table 5** Licensed Options Available

License	Description	Upgrade model number, notes
AERO	MIL-STD-1553 and ARINC 429 Serial Triggering and Analysis.	Order DSOX3AERO.
AUDIO	Audio Serial Triggering and Analysis (I2S).	Order DSOX3AUDIO.
AUTO	Automotive Serial Triggering and Analysis (CAN,LIN).	Order DSOXT3AUTO.
CANFD	Automotive Serial Triggering and Analysis (CAN,LIN).	Order DSOXT3AUTO.
COMP	Computer Serial Triggering and Analysis (RS232/422/485/UART). Provides trigger and decode capability for many UART (Universal Asynchronous Receiver/Transmitter) protocols including RS232 (Recommended Standard 232).	Order DSOX3COMP.
CXPI	CXPI (Clock Extension Peripheral Interface) Serial Triggering and Analysis.	Order DSOXT3CXPI.
EMBD	Embedded Serial Triggering and Analysis (I2C, SPI).	Order DSOX3EMBD.
FLEX	FlexRay Triggering and Analysis.	Order DSOX3FLEX.
FRA	Frequency Response Analysis.	Order DSOXT3FRA.
MASK	Mask Limit Test Lets you create a mask and test waveforms to determine whether they comply to the mask.	Order DSOX3MASK.
memMax	Memory Upgrade. It shows the total memory depth (4 Mpts interleaved).	Order DSOX3MEMUP.
MSO	Mixed Signal Oscilloscope (MSO). Upgrade a DSO to an MSO. Adds 16 digital channels. You do not have to install any hardware.	Order DSOXT3MSO. The digital probe cable kit is supplied with the MSO license.
NFC	Near Field Communication (NFC) Trigger.	Order DSOXT3NFC.
NRZ	Manchester/NRZ (Non Return to Zero) Triggering and Analysis.	Order DSOX3NRZ.

**Table 5** Licensed Options Available (continued)

License	Description	Upgrade model number, notes
PWR	Power Measurement and Analysis.	Order DSOX3PWR. You can find the <i>PWR Power Measurement Application User's Guide</i> at <a href="http://www.keysight.com/find/3000TX-Series-manual">www.keysight.com/find/3000TX-Series-manual</a> or on the Documentation CD.
SENSOR	SENT (Single Edge Nibble Transmission) Triggering and Analysis.	Order DSOXT3SENSOR.
VID	Extended Video Triggering and Analysis.	Order DSOX3VID.
WAVEGEN	Waveform Generator.	Order DSOX3WAVEGEN.

## Other Options Available

**Table 6** Calibration Option

Option	Order
A6J	ANSI Z540 Compliant Calibration

## Upgrading to an MSO

A license can be installed to activate the digital channels of an oscilloscope that was not originally ordered as a mixed-signal oscilloscope (MSO). A mixed signal oscilloscope has analog channels plus 16 time-correlated digital timing channels.

For information about upgrading your oscilloscope through licensing, contact your local Keysight Technologies representative or see [www.keysight.com/find/3000TX-Series](http://www.keysight.com/find/3000TX-Series).

## Software and Firmware Updates

From time to time Keysight Technologies releases software and firmware updates for its products. To search for firmware updates for your oscilloscope, direct your web browser to [www.keysight.com/find/3000TX-Series-sw](http://www.keysight.com/find/3000TX-Series-sw).

To view the currently installed software and firmware press **[Help] > About Oscilloscope**.

Once you have downloaded a firmware update file, you can place it on a USB storage device and load the file using File Explorer (see **"File Explorer"** on page 344), or you can use the Instrument Utilities page of the oscilloscope's web interface (see **"Instrument Utilities"** on page 370).

## Binary Data (.bin) Format

The binary data format stores waveform data in binary format and provides data headers that describe that data.

Because the data is in binary format, the size of the file is approximately 5 times smaller than the ASCII XY format.

If more than one source is on, all displayed sources will be saved, except math functions.

When using segmented memory, each segment is treated as a separate waveform. All segments for a channel are saved, then all segments of the next (higher numbered) channel are saved. This continues until all displayed channels are saved.

When the oscilloscope is in the Peak Detect acquisition mode, the minimum and maximum value waveform data points are saved to the file in separate waveform buffers. The minimum value data points are saved first; then, the maximum value data points are saved.

### BIN data - using segmented memory

When saving all segments, each segment has its own waveform header (see **"Binary Header Format"** on page 382).

In BIN file format, data are presented as follows:

- Channel 1 data (all segments)
- Channel 2 data (all segments)
- Channel 3 data (all segments)
- Channel 4 data (all segments)
- Digital channel data (all segments)
- Math waveform data (all segments)

When not saving all segments, the number of waveforms is equivalent to the number of active channels (including math and digital channels, with up to seven waveforms for each digital pod). When saving all segments, the number of waveforms is equal to the number of active channels multiplied by the number of segments acquired.

## Binary Data in MATLAB

Binary data from an InfiniiVision oscilloscope can be imported to The MathWorks MATLAB®. You can download the appropriate MATLAB functions from the Keysight Technologies web site at [www.keysight.com/find/3000TX-Series-examples](http://www.keysight.com/find/3000TX-Series-examples).

Keysight provides the .m files, which need to be copied into the work directory for MATLAB. The default work directory is C:\MATLAB7\work.

## Binary Header Format

**File Header** There is only one file header in a binary file. The file header consists of the following information.

Cookie	Two byte characters, AG, that indicate the file is in the Keysight Binary Data file format.
Version	Two bytes that represent the file version.
File Size	A 32-bit integer that is the number of bytes that are in the file.
Number of Waveforms	A 32-bit integer that is the number of waveforms that are stored in the file.

**Waveform Header** It is possible to store more than one waveform in the file, and each waveform stored will have a waveform header. When using segmented memory, each segment is treated as a separate waveform. The waveform header contains information about the type of waveform data that is stored following the waveform data header.

Header Size	A 32-bit integer that is the number of bytes in the header.
-------------	---

Waveform Type	<p>A 32-bit integer that is the type of waveform stored in the file:</p> <ul style="list-style-type: none"> <li>▪ 0 = Unknown.</li> <li>▪ 1 = Normal.</li> <li>▪ 2 = Peak Detect.</li> <li>▪ 3 = Average.</li> <li>▪ 4 = Not used in InfiniiVision oscilloscopes.</li> <li>▪ 5 = Not used in InfiniiVision oscilloscopes.</li> <li>▪ 6 = Logic.</li> </ul>
Number of Waveform Buffers	A 32-bit integer that is the number of waveform buffers required to read the data.
Points	A 32-bit integer that is the number of waveform points in the data.
Count	A 32-bit integer that is the number of hits at each time bucket in the waveform record when the waveform was created using an acquisition mode like averaging. For example, when averaging, a count of four would mean every waveform data point in the waveform record has been averaged at least four times. The default value is 0.
X Display Range	A 32-bit float that is the X-axis duration of the waveform that is displayed. For time domain waveforms, it is the duration of time across the display. If the value is zero then no data has been acquired.
X Display Origin	A 64-bit double that is the X-axis value at the left edge of the display. For time domain waveforms, it is the time at the start of the display. This value is treated as a double precision 64-bit floating point number. If the value is zero then no data has been acquired.
X Increment	A 64-bit double that is the duration between data points on the X axis. For time domain waveforms, this is the time between points. If the value is zero then no data has been acquired.
X Origin	A 64-bit double that is the X-axis value of the first data point in the data record. For time domain waveforms, it is the time of the first point. This value is treated as a double precision 64-bit floating point number. If the value is zero then no data has been acquired.

X Units	A 32-bit integer that identifies the unit of measure for X values in the acquired data: <ul style="list-style-type: none"> <li>▪ 0 = Unknown.</li> <li>▪ 1 = Volts.</li> <li>▪ 2 = Seconds.</li> <li>▪ 3 = Constant.</li> <li>▪ 4 = Amps.</li> <li>▪ 5 = dB.</li> <li>▪ 6 = Hz.</li> </ul>
Y Units	A 32-bit integer that identifies the unit of measure for Y values in the acquired data. The possible values are listed above under X Units.
Date	A 16-byte character array, left blank in InfiniiVision oscilloscopes.
Time	A 16-byte character array, left blank in the InfiniiVision oscilloscopes.
Frame	A 24 byte character array that is the model number and serial number of the oscilloscope in the format of: MODEL#:SERIAL#.
Waveform Label	A 16 byte character array that contains the label assigned to the waveform.
Time Tags	A 64-bit double, only used when saving multiple segments (requires segmented memory option). This is the time (in seconds) since the first trigger.
Segment Index	A 32-bit unsigned integer. This is the segment number. Only used when saving multiple segments.

### Waveform Data Header

A waveform may have more than one data set. Each waveform data set will have a waveform data header. The waveform data header consists of information about the waveform data set. This header is stored immediately before the data set.

Waveform Data Header Size	A 32-bit integer that is the size of the waveform data header.
---------------------------	--



Buffer Type	<p>A 16-bit short that is the type of waveform data stored in the file:</p> <ul style="list-style-type: none"> <li>▪ 0 = Unknown data.</li> <li>▪ 1 = Normal 32-bit float data.</li> <li>▪ 2 = Maximum float data.</li> <li>▪ 3 = Minimum float data.</li> <li>▪ 4 = Not used in InfiniiVision oscilloscopes.</li> <li>▪ 5 = Not used in InfiniiVision oscilloscopes.</li> <li>▪ 6 = Digital unsigned 8-bit char data (for digital channels).</li> </ul>
Bytes Per Point	A 16-bit short that is the number of bytes per data point.
Buffer Size	A 32-bit integer that is the size of the buffer required to hold the data points.

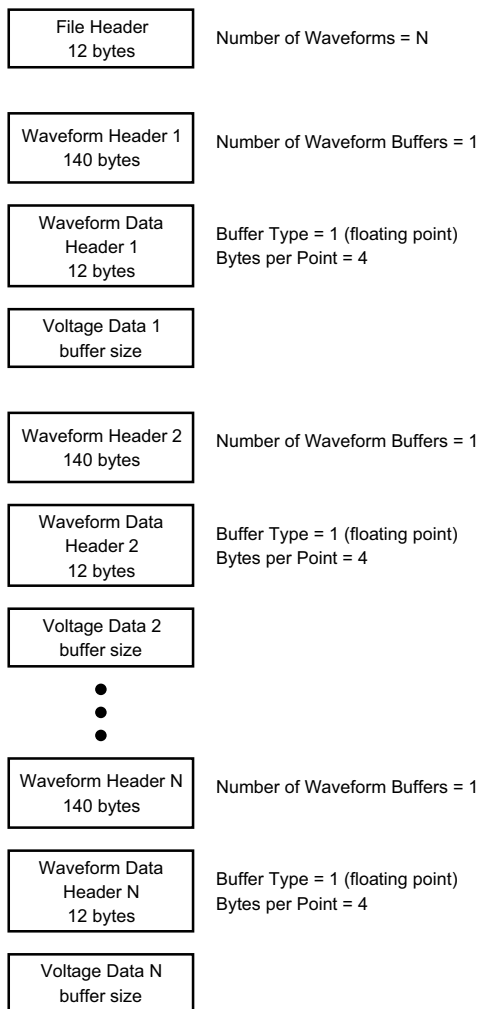
## Example Program for Reading Binary Data

To find an example program for reading binary data, direct your web browser to [www.keysight.com/find/3000TX-Series-examples](http://www.keysight.com/find/3000TX-Series-examples), and select "Example Program for Reading Binary Data".

## Examples of Binary Files

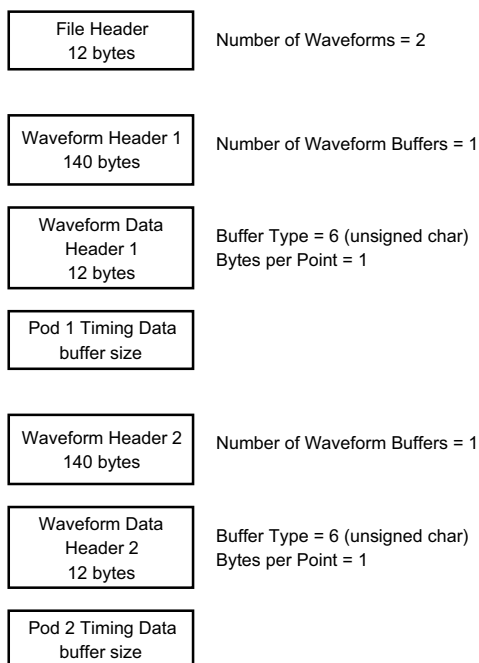
### Single Acquisition Multiple Analog Channels

The following picture shows a binary file of a single acquisition with multiple analog channels.



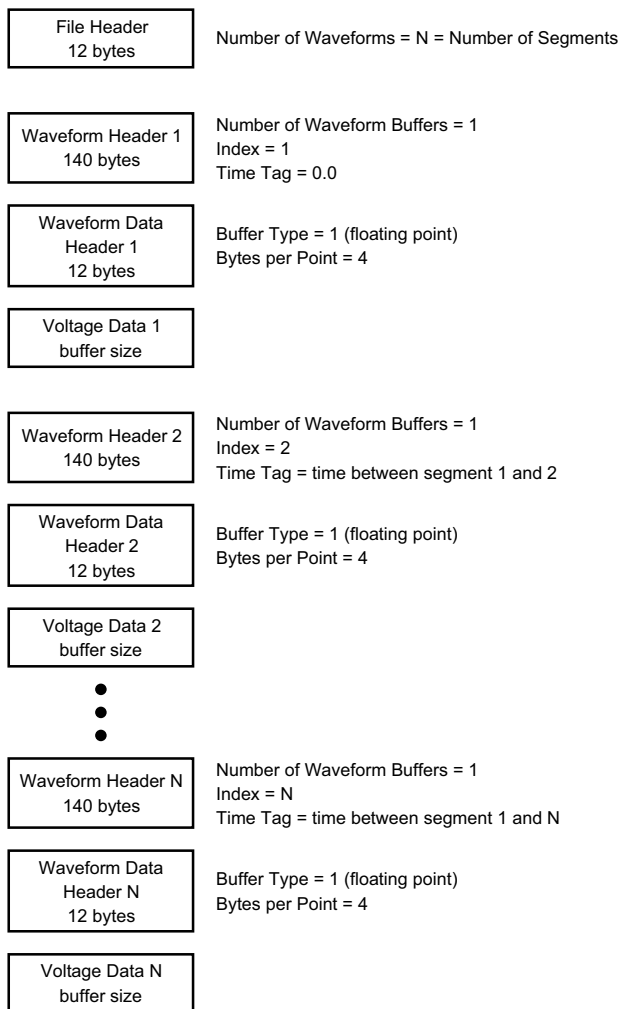
**Single Acquisition  
All Pods Logic  
Channels**

The following picture shows a binary file of a single acquisition with all pods for the logic channels saved.



### Segmented Memory Acquisition on One Analog Channel

The following picture shows a binary file of a segmented memory acquisition on one analog channel.



## CSV and ASCII XY files

- ["CSV and ASCII XY file structure"](#) on page 389
- ["Minimum and Maximum Values in CSV Files"](#) on page 389
- ["Frequency Data in CSV Files"](#) on page 390

## CSV and ASCII XY file structure

In CSV or ASCII XY format the **Length** control selects the number of points per segment. All segments are contained in the CSV file or in each ASCII XY data file.

For example: If the Length control is set to 1000 points, there will be 1000 points (rows in the spreadsheet) per segment. When saving all segments there are three header rows, so the data for the first segment starts at row 4. The second segment's data starts at row 1004. The time column shows the time since the trigger on the first segment. The top row shows the selected number of points per segment.

BIN files are a more efficient data transfer format than CSV or ASCII XY. Use this file format for fastest data transfer.

## Minimum and Maximum Values in CSV Files

If you are running a Minimum or Maximum measurement, the minimum and maximum values shown in the measurement display may not appear in the CSV file.

**Explanation:** When the oscilloscope's sample rate is 4 GSa/s, a sample will be taken every 250 ps. If the horizontal scale is set to 10 us/div, there will be 100 us of data displayed (because there are ten divisions across the screen). To find the total number of samples the oscilloscope will take:

$$100 \text{ us} \times 4 \text{ GSa/s} = 400\text{K samples}$$

The oscilloscope is required to display those 400K samples using 640 pixel columns. The oscilloscope will decimate the 400K samples to 640 pixel columns, and this decimation keeps track of the min and max values of all the points that are represented by any given column. Those min and max values will be displayed in that screen column.

A similar process is used to reduce the acquired data to produce a record usable for various analysis needs such as measurements and CSV data. This analysis record (or *measurement record*) is much larger than 640 and may in fact contain up to 65536 points. Still, once the # of acquired points > 65536, some form of decimation is required. The decimator used to produce a CSV record is configured to provide a best-estimate of all the samples that each point in the record represents. Therefore, the min and max values may not appear in the CSV file.

## Frequency Data in CSV Files

When data for multiple frequency sources is saved to a CSV file, this data is saved as one set (with multiple columns) using a horizontal (X) range that covers all sources.

## Acknowledgements

**Table 7** Third Party Software

Software	Description and Copyright	License <sup>1</sup>
7-zip	Copyright (C) 1999-2016 Igor Pavlov.	GNU LGPL + unRAR restriction
Boost Libraries	Copyright © 2008 Beman Dawes, Rene Rivera	Boost Software License (BSL-1.0)
CUPS	The CUPS and CUPS Imaging libraries are developed by Apple Inc. and licensed under the GNU Library General Public License ("LGPL"), Version 2. Copyright 2007-2016 by Apple Inc.	GNU Library General Public License ("LGPL"), Version 2
HDF5	HDF5 was developed by <b>The HDF Group</b> and by the National Center for Supercomputing Applications at the University of Illinois at Urbana-Champaign. Copyright 2006-2016 by The HDF Group. Copyright 1998-2006 by the Board of Trustees of the University of Illinois.	BSD-style open source
jQuery	Copyright 2012 jQuery Foundation and other contributors <a href="http://jquery.com/">http://jquery.com/</a>	MIT License
libmspack	Copyright: © 2003-2013 Stuart Caie Source code can be obtained from the third party or by contacting Keysight. Keysight will charge for the cost of physically performing the source distribution.	Lesser or Library General Public License version 3.0 (LGPLv3)
libpng	Copyright (c) 1998-2002,2004,2006-2016 Glenn Randers-Pehrson (Version 0.96 Copyright (c) 1996, 1997 Andreas Dilger) (Version 0.88 Copyright (c) 1995, 1996 Guy Eric Schalnat, Group 42, Inc.)	libpng specific

**Table 7** Third Party Software (continued)

Software	Description and Copyright	License <sup>1</sup>
mDNSResponder	The mDNSResponder library is developed by Apple Inc. and licensed under the Apache License, Version 2.0. Copyright (c) 1997-2016 Apple Inc. All rights reserved.	Apache License, Version 2.0
noVNC	Copyright (C) 2011 Joel Martin <github@martintribe.org> Source code can be obtained from the third party or by contacting Keysight. Keysight will charge for the cost of physically performing the source distribution.	Mozilla Public License - MPL
RealVNC	Copyright (C) 2002-2005 RealVNC Ltd. All Rights Reserved. This is free software; you can redistribute it and/or modify it under the terms of the GNU General Public License as published by the Free Software Foundation; either version 2 of the License, or (at your option) any later version. This software is distributed in the hope that it will be useful, but WITHOUT ANY WARRANTY; without even the implied warranty of MERCHANTABILITY or FITNESS FOR A PARTICULAR PURPOSE. See the GNU General Public License for more details. Source code can be obtained from the third party or by contacting Keysight. Keysight will charge for the cost of physically performing the source distribution.	GNU General Public License
Tabber	Copyright (c) 2006 Patrick Fitzgerald	MIT License
TCLAP	Copyright (c) 2003 Michael E. Smoot	MIT License
time_ce	Copyright (C) 2002 Michael Ringgaard. All rights reserved.	MIT License
U-Boot	(C) Copyright 2000 - 2013 Wolfgang Denk, DENX Software Engineering, wd@denx.de. Source code can be obtained from the third party or by contacting Keysight. Keysight will charge for the cost of physically performing the source distribution.	GNU General Public License (GPL or GPLv2)
WCELIBCEX	File copyright is held by a file author. Files created for the first version of the WCELIBCEX project are copyrighted by (c) 2006 Taxus SI Ltd., <a href="http://www.taxussi.com.pl">http://www.taxussi.com.pl</a> See comment in header of source files for more details.	MIT License






**Table 7** Third Party Software (continued)

Software	Description and Copyright	License <sup>1</sup>
websocketify	Copyright 2010 Joel Martin (github.com/kanaka) Source code can be obtained from the third party or by contacting Keysight. Keysight will charge for the cost of physically performing the source distribution.	Lesser or Library General Public License version 3.0 (LGPLv3)
zlib	Copyright (C) 1995-2013 Jean-loup Gailly and Mark Adler	zlib license

<sup>1</sup>These licenses are located on the Keysight InfiniiVision oscilloscopes manuals CD-ROM.

## Product Markings and Regulatory Information

These symbols are used on the 3000T X-Series oscilloscopes.

Symbol	Description
	Caution, risk of electric shock
	Caution, refer to accompanying documentation
	This symbol indicates separate collection for electrical and electronic equipment mandated under EU law as of August 13, 2005. All electric and electronic equipment are required to be separated from normal waste for disposal (Reference WEEE Directive 2002/96/EC).
	Indicates the time period during which no hazardous or toxic substance elements are expected to leak or deteriorate during normal use. Forty years is the expected useful life of the product.
	The RCM mark is a registered trademark of the Australian Communications and Media Authority.



Symbol	Description
 <p>ICES/NMB-001 ISM GRP 1-A</p>	<p>The CE mark is a registered trademark of the European Community.</p> <p>ICES / NMB-001 Cet appareil ISM est conforme a la norme NMB du Canada. This is a marking to indicate product compliance with the Industry Canadian Interference-Causing Equipment Standard (ICES-001).</p> <p>This is also a symbol of an Industrial Scientific and Medical Group 1 Class A product (CISPR 11, Clause 4).</p>
 <p>SP<sup>®</sup> C US</p>	<p>The CSA mark is a registered trademark of the CSA International.</p>
 <p>KCC-REM-ATI- 1ADS0X3000A</p>	<p>South Korean Certification (KC) mark; includes the marking's identifier code which follows this format: MSIP-REM-YYY-<u>ZZZZZZZZZZZZZZZZ</u>.</p>

#### Compliance with German Noise Requirements

This is to declare that this instrument is in conformance with the German Regulation on Noise Declaration for Machines (Laermangabe nach der Maschinenlaermrerordnung -3.GSGV Deutschland).

Acoustic Noise Emission/Geraeuschemission	
LpA <70 dB	LpA <70 dB
Operator position	am Arbeitsplatz
Normal position	normaler Betrieb
per ISO 7779	nach DIN 45635 t.19



# 25 CAN/LIN Triggering and Serial Decode

- Setup for CAN/CAN FD Signals / 395
- Loading and Displaying CAN Symbolic Data / 398
- CAN/CAN FD Triggering / 399
- CAN/CAN FD Serial Decode / 402
- Setup for LIN Signals / 407
- Loading and Displaying LIN Symbolic Data / 409
- LIN Triggering / 409
- LIN Serial Decode / 411

CAN/LIN triggering and serial decode requires the AUTO license that you can get by purchasing the DSOXT3AUTO upgrade.

## Setup for CAN/CAN FD Signals

Setup consists of connecting the oscilloscope to a CAN signal, using the Signals Menu to specify the signal source, threshold voltage level, baud rate, and sample point.

Connect the oscilloscope to a CAN signal that has a dominant-low polarity. If you are connecting to the CAN signal using a differential probe, connect the probe's positive lead to the dominant-low CAN signal and connect the negative lead to the dominant-high CAN signal.

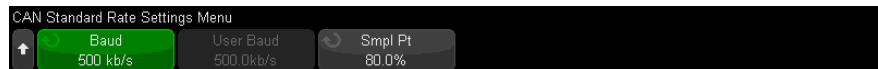
To set up the oscilloscope to capture CAN signals:

- 1 Press **[Serial]**.

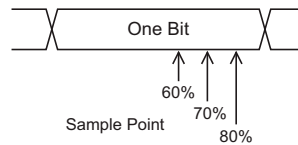
- 2 Press the **Serial** softkey, turn the Entry knob to select Serial 1 or Serial 2, and press the softkey again to enable decode.
- 3 Press the **Mode** softkey; then, select **CAN** trigger type.
- 4 Press the **Signals** softkey to open the CAN Signals Menu.




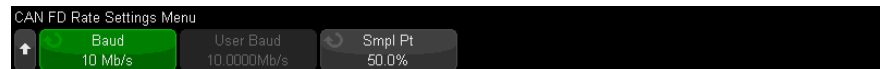
- 5 Press **Source**; then, select the channel for the CAN signal.  
The label for the CAN source channel is automatically set.
- 6 Press the **Threshold** softkey; then, turn the Entry knob to select the CAN signal threshold voltage level.  
The threshold voltage level is used in decoding, and it will become the trigger level when the trigger type is set to the selected serial decode slot.
- 7 Press the **Std. Rate Settings** softkey to open the CAN Standard Rate Settings Menu.



- a Press the **Baud** softkey; then, turn the Entry knob to select the baud rate that matches match your CAN bus signal.  
The CAN baud rate can be set to predefined baud rates from 10 kb/s up to 5 Mb/s or a user-defined baud rate from 10.0 kb/s to 4 Mb/s in increments of 100 b/s. Fractional user-defined baud rates between 4 Mb/s and 5 Mb/s are not allowed.  
The default baud rate is 125 kb/s  
If none of the pre-defined selections match your CAN bus signal, select **User Defined**; then, press the **User Baud** softkey and turn the Entry knob to enter the baud rate.
- b Press the **Sample Point** softkey; then, turn the Entry knob to select the point between phase segments 1 and 2 where the state of the bus is measured. This controls the point within the bit's time where the bit value is captured.



- c Press the  Back/Up key to return to the CAN Signals Menu.
- 8 When decoding CAN FD, press the **FD Rate Settings** softkey to open the CAN FD Rate Settings Menu.

**NOTE**

For standard CAN, only the Standard Rate Settings must be set correctly. For CAN FD, both the Standard Rate Settings and the FD Rate Settings must be set correctly.

- a Press the **Baud** softkey; then, turn the Entry knob to match the CAN FD baud rate of the signal from your device under test.

If the desired baud rate is not shown in the list, select **User Defined** and use the **User Baud** softkey to set the baud rate.


The CAN FD baud rate can be set to predefined baud rates from 1-10 Mb/s or a user-defined baud rate from 10.0 kb/s to 10 Mb/s in increments of 100 b/s.

If the baud rate you select does not match the CAN FD baud rate, false triggers and decoding may occur.

- b Press the **Sample Point** softkey; then, turn the Entry knob to select the sample point.

The sample point is the point during the bit time where the bit level is sampled to determine whether it is dominant or recessive. The sample point represents the percentage of time between the beginning of the bit time to the end of the bit time.

You may need to adjust the sample point to get a reliable trigger and decode, depending on your CAN FD network topology and where the oscilloscope probe is located in the network.

- c Press the **Standard** softkey to select the standard that will be used when decoding or triggering on FD frames, ISO, or non-ISO.  
This setting has no effect on the processing of non-FD (classical) frames.
- d Press the  Back/Up key to return to the CAN Signals Menu.
- 9 Press the **Signal** softkey and select the type and polarity of the CAN signal. This also automatically sets the channel label for the source channel.
  - **CAN\_H** – The actual CAN\_H differential bus.
  - **Differential (H-L)** – The CAN differential bus signals connected to an analog source channel using a differential probe. Connect the probe's positive lead to the dominant-high CAN signal (CAN\_H) and connect the negative lead to the dominant-low CAN signal (CAN\_L).

Dominant low signals:

- **Rx** – The Receive signal from the CAN bus transceiver.
- **Tx** – The Transmit signal from the CAN bus transceiver.
- **CAN\_L** – The actual CAN\_L differential bus signal.
- **Differential (L-H)** – The CAN differential bus signals connected to an analog source channel using a differential probe. Connect the probe's positive lead to the dominant-low CAN signal (CAN\_L) and connect the negative lead to the dominant-high CAN signal (CAN\_H).

## Loading and Displaying CAN Symbolic Data

When you load (recall) a CAN DBC communication database (\*.dbc) file into the oscilloscope, its symbolic information can be:

- Displayed in the decode waveform and Lister window.
- Used when setting up CAN triggering.
- Used when searching for CAN data in the decode.

To recall a DBC file into the oscilloscope:

- 1 Press [**Save/Recall**] > **Recall** > **Recall** > **CAN Symbolic data (\*.dbc)**.

- 2 Press **Press to go** and navigate to the DBC file on a USB storage device.
- 3 Press **Load to:** and select which serial decode (**S1** or **S2**) the symbolic information will be used with.
- 4 Press **Press to Recall**.

The DBC file remains in the oscilloscope until it is overwritten or a secure erase is performed.

To display CAN symbolic data:

- 1 Press **[Serial]**.
- 2 Press the **Display** softkey and select **Symbolic** (instead of **Hexadecimal**).

Your choice affects both the decode waveform and the Lister window.

## NOTE

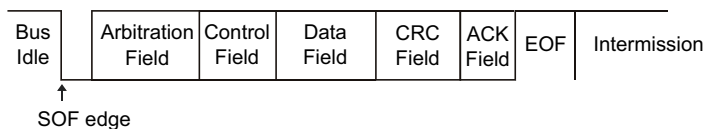
For CAN FD frames, symbolic decoding is limited to the first eight bytes.

## CAN/CAN FD Triggering

To set up the oscilloscope to capture a CAN signal, see **“Setup for CAN/CAN FD Signals”** on page 395.

The Controller Area Network (CAN) trigger allows triggering on CAN version 2.0A, 2.0B, and CAN FD (Flexible Data-rate) signals.

A CAN message frame in CAN\_L signal type is shown below:



After setting up the oscilloscope to capture a CAN signal:

- 1 Press **[Trigger]**.
- 2 In the Trigger Menu, press the **Trigger Type** softkey; then, turn the Entry knob to select Serial 1 or Serial 2 on which the CAN signal is being decoded.



- 3** Press the **Trigger on:** softkey; then, turn the Entry knob to select the trigger condition:
- **SOF - Start of Frame** – triggers at the start bit for both data and overload frames.
  - **EOF - End of Frame** – triggers at the end of any frame. \*
  - **Frame ID** – triggers on any standard CAN (data or remote) or CAN FD frame at the end of the 11- or 29-bit ID field.
  - **Data Frame ID (non-FD)** – triggers on standard CAN data frames at the end of the 11- or 29-bit ID field.
  - **Data Frame ID and Data (non-FD)** – triggers on any standard CAN data frame at the end of the last data byte defined in the trigger. The DLC of the packet must match the number of bytes specified.
  - **Data Frame ID and Data (FD)** – triggers on CAN FD frames at the end of the last data byte defined in the trigger. You can trigger on up to 8 bytes of data anywhere within the CAN FD data, which can be up to 64 bytes long.
  - **Remote Frame ID** – triggers on standard CAN remote frames at the end of the 11- or 29-bit ID field.
  - **Error Frame** – triggers after 6 consecutive 0s while in a data frame, at the EOF. \*
  - **Acknowledge Error** – triggers on the acknowledge bit if the polarity is incorrect. \*
  - **Form Error** – triggers on reserved bit errors. \*
  - **Stuff Error** – triggers on 6 consecutive 1s or 6 consecutive 0s, while in a non-error or non overload frame. \*
  - **CRC Field Error** – triggers when the calculated CRC does not match the transmitted CRC. In addition, for FD frames, will also trigger if the Stuff Count is in error. \*
  - **Spec Error (Ack or Form or Stuff or CRC)** – triggers on Ack, Form, Stuff, or CRC errors. \*
  - **All Errors** – triggers on all Spec errors and error frames. \*
  - **BRS Bit (FD)** – triggers on the BRS bit of CAN FD frames. \*
  - **CRC Delimiter Bit (FD)** – triggers on the CRC delimiter bit in CAN FD frames. \*



- **ESI Bit Active (FD)** – triggers on the ESI bit if set active. \*
- **ESI Bit Passive (FD)** – triggers on the ESI bit if set passive. \*
- **Overload Frame** – triggers on an overload frame.

\* You can optionally qualify the trigger for frames whose ID you specify.

When CAN symbolic data is loaded into the oscilloscope (see **“Loading and Displaying CAN Symbolic Data”** on page 398), you can trigger on:

- **Message** – a symbolic message.
- **Message and Signal (non-FD)** – a symbolic message and a signal value.
- **Message and Signal (FD, first 8 bytes only)** – a symbolic message and a signal value, limited to the first 8 bytes of FD data.

Symbolic messages, signals, and values are defined in the DBC communication database file.

A message is the symbolic name for a CAN frame ID, a signal is the symbolic name for a bit or set of bits within the CAN data, and a value can be a symbolic representation of the signal bit values or it can be a decimal number with units.

- 4 If you select a condition that lets you qualify by ID or trigger on ID or data values, use the **Filter by ID** softkey, or the **Bits** softkey and the CAN Bits Menu, and the remaining softkeys to specify those values.

For details about using the remaining softkeys to enter values, press and hold the softkey in question to display the built-in help.

You can use the **Zoom** mode for easier navigation of the decoded data.

#### NOTE

If the setup does not produce a stable trigger, the CAN signal may be slow enough that the oscilloscope is AutoTriggering. Press the **[Mode/Coupling]** key, then press the **Mode** softkey to set the trigger mode from **Auto** to **Normal**.

#### NOTE

To display CAN serial decode, see **“CAN/CAN FD Serial Decode”** on page 402.

## CAN/CAN FD Serial Decode

To set up the oscilloscope to capture CAN signals, see [“Setup for CAN/CAN FD Signals”](#) on page 395.

### NOTE

For CAN triggering set up see [“CAN/CAN FD Triggering”](#) on page 399.

To set up CAN serial decode:

- 1 Press **[Serial]** to display the Serial Decode Menu.



- 2 If the decode line does not appear on the display, press the **[Serial]** key to turn it on.
- 3 If the oscilloscope is stopped, press the **[Run/Stop]** key to acquire and decode data.

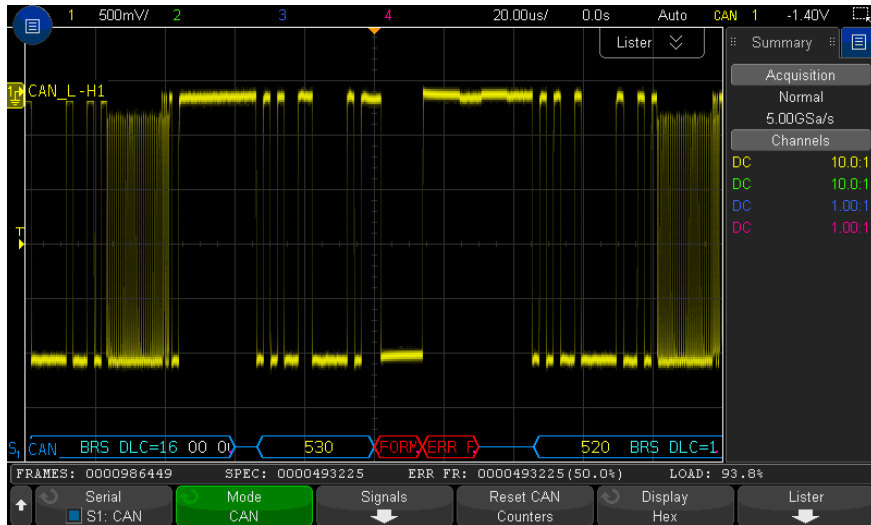
### NOTE

If the setup does not produce a stable trigger, the CAN signal may be slow enough that the oscilloscope is AutoTriggering. Press the **[Mode/Coupling]** key, then press the **Mode** softkey to set the trigger mode from **Auto** to **Normal**.

You can use the horizontal **Zoom** window for easier navigation of the decoded data.

- See Also
- [“Interpreting CAN/CAN FD Decode”](#) on page 403
  - [“CAN Totalizer”](#) on page 404
  - [“Interpreting CAN Lister Data”](#) on page 405
  - [“Searching for CAN Data in the Lister”](#) on page 406

## Interpreting CAN/CAN FD Decode



The CAN decode display is color coded as follows:

- Blue angled waveforms show an active bus (inside a packet/frame).
- Blue mid-level lines show an idle bus.
- Frame ID – yellow.
- Data bytes – white hex digits.
- CAN frame type and Data Length Code (DLC) – blue for data frames, green for remote frames. The DLC is always a decimal value. CAN frame types can be:
  - FD – a CAN FD frame whose bit rate does not switch during the data phase.
  - BRS – a CAN FD frame whose bit rate switches during the data phase.
  - RMT – a standard CAN remote frame.
  - Data – a standard CAN data frame.

The status of the Error State Indicator (ESI) flag is shown in the "Type" column of the Lister. If the ESI bit is recessive, indicating error passive, the background of the "Type" column will be yellow. If the ESI bit indicates error active, the "Type" column's background will be unshaded.

The DLC field will always be displayed in decimal, and will indicate the number of bytes in the frame. So for example, for an FD frame that has the DLC code 0xF, which represents a packet with 64 bytes, "DLC=64" will be displayed on the decode line, and "64" will be displayed in the DLC column of the Lister.

- Overload frame – blue with the text "OVRLD". An overload condition may occur before an end of frame condition. If so, the frame is closed and opened with blue brackets at the start of the overload condition.
- Stuff Count – green hex digit when valid, red when error detected. The hex digit shows the gray-coded with parity bit stuff count.
- CRC – blue hex digits when valid, red when error detected.
- Red angled waveforms – Unknown or error condition.
- Flagged error frames – red with "ERR FRAME", "STUFF ERR", "FORM ERR", "ACK ERR", "GLITCH ERR", or "?" (unknown).
- Pink vertical bars – Expand horizontal scale (and run again) to see decode.
- Red Dot – More information is available. Decoded text is truncated to fit. Expand the horizontal scale to view the information.

## CAN Totalizer

The CAN totalizer provides a direct measure of bus quality and efficiency. The CAN totalizer measures total CAN frames, Specification error counter, flagged error frames, and bus utilization.



The totalizer is always running (counting frames and calculating percentages) and is displayed whenever CAN decode is displayed. The totalizer counts even when the oscilloscope is stopped (not acquiring data). Pressing the **[Run/Stop]** key does not affect the totalizer. When an overflow condition occurs, the counter displays **OVERFLOW**. The counters can be reset to zero by pressing the **Reset CAN Counters** softkey.

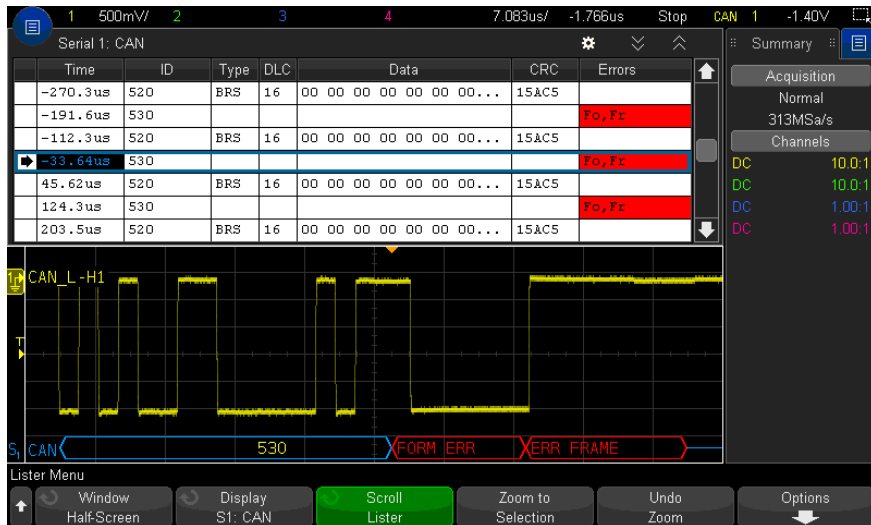
### Types of Frames

- Active error frames are CAN frames in which a CAN node recognizes an error condition during a data or remote frame and issues an active error flag.

- A partial frame occurs when the oscilloscope detects any error condition during a frame that is not followed by an active error flag. Partial frames are not counted.
- Counters**
- The FRAMES counter gives the total number of completed remote, data, overload, and active error frames.
  - The SPEC counter gives the total number of Specification errors. This counter tracks the number of Acknowledge, Form, Stuff, and CRC errors. If a packet has more than one type of error, that packet will increment the counter by the total number of errors in the packet.
  - The ERR FR counter gives the total number of completed active error frames and their percentage of the total number of frames.
  - The LOAD (bus load) indicator measures the percentage of time the bus is active. The calculation is done on 330 ms periods, approximately every 400 ms.

Example: If a data frame contains an active error flag, both the FRAMES counter and the ERR FR counter will be incremented. If a data frame contains an error that is not an active error it is considered a partial frame and no counters are incremented.

## Interpreting CAN Lister Data



In addition to the standard Time column, the CAN Lister contains these columns:

- ID – frame ID. Can be displayed as hex digits or symbolic information (see **“Loading and Displaying CAN Symbolic Data”** on page 398).
- Type – frame type (RMT remote frame or Data).
- DLC – data length code.
- Data – data bytes. Can be displayed as hex digits or symbolic information.
- CRC – cyclic redundancy check.
- Errors – highlighted in red. Errors can be Acknowledge (Ack, A), Form (Fo), or Frame (Fr). Different kinds of errors can be combined like "Fo,Fr" in the above example.

Aliased data is highlighted in pink. When this happens, decrease the horizontal time/div setting and run again.

## Searching for CAN Data in the Lister

The oscilloscope's search capability lets you search for (and mark) certain types of CAN data in the Lister. You can use the **[Navigate]** key and controls to navigate through the marked rows.

- 1** With CAN selected as the serial decode mode, press **[Search]**.
- 2** In the Search Menu, press the **Search** softkey; then, turn the Entry knob to select Serial 1 or Serial 2 on which the CAN signal is being decoded.
- 3** Press **Search for**; then, select from these options:
  - **Frame ID** – Finds remote or data frames matching the specified ID.
  - **Data Frame ID** – Finds data frames matching the specified ID.
  - **Data Frame ID and Data** – Finds data frames matching the specified ID and data.
  - **Remote Frame ID** – Finds remote frames with the specified ID.
  - **Error Frame** – Finds CAN active error frames.
  - **Acknowledge Error** – Finds the acknowledge bit if the polarity is incorrect.
  - **Form Error** – Finds reserved bit errors.
  - **Stuff Error** – Finds 6 consecutive 1s or 6 consecutive 0s, while in a non-error or non overload frame.
  - **CRC Field Error** – Finds when the calculated CRC does not match the transmitted CRC.

- **All Errors** – Finds any form error or active error.
- **Overload Frame** – Finds CAN overload frames.

When CAN symbolic data is loaded into the oscilloscope (see “**Loading and Displaying CAN Symbolic Data**” on page 398), you can search for:

- **Message** – a symbolic message.
- **Message and Signal** – a symbolic message and a signal value.

For more information on searching data, see “**Searching Lister Data**” on page 152.

For more information on using the **[Navigate]** key and controls, see “**Navigating the Time Base**” on page 75.

## Setup for LIN Signals

LIN (Local Interconnect Network) signal setup consists of connecting the oscilloscope to a serial LIN signal, specifying the signal source, threshold voltage level, baud rate, sample point, and other LIN signal parameters.

To set up the oscilloscope to capture LIN signals:

- 1 Press **[Serial]**.
- 2 Press the **Serial** softkey, turn the Entry knob to select the desired slot (Serial 1 or Serial 2), and press the softkey again to enable decode.
- 3 Press the **Mode** softkey; then, select **LIN** trigger type.
- 4 Press the **Signals** softkey to open the LIN Signals Menu.




- 5 Press the **Source** softkey to select the channel connected to the LIN signal line.  
The label for the LIN source channel is automatically set.
- 6 Press the **Threshold** softkey; then, turn the Entry knob to set the LIN signal threshold voltage level to the middle of the LIN signal.  
The threshold voltage level is used in decoding, and it will become the trigger level when the trigger type is set to the selected serial decode slot.
- 7 Press the **Baud Rate** softkey to open the LIN Baud Rate Menu.

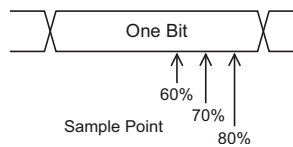
- 8 Press the **Baud** softkey; then, turn the Entry knob to select the baud rate that matches match your LIN bus signal.

The default baud rate is 19.2 kb/s.

If none of the pre-defined selections match your LIN bus signal, select **User Defined**; then, press the **User Baud** softkey and turn the Entry knob to enter the baud rate.

You can set the LIN baud rate from 2.4 kb/s to 625 kb/s in increments of 100 b/s.

- 9 Press the  Back/Up key to return to the LIN Signals Menu.
- 10 Press the **Sample Point** softkey; then, turn the Entry knob to select the sample point at which the oscilloscope will sample the bit value.



- 11 Press the **Standard** softkey; then, turn the Entry knob to select the LIN standard you are measuring:

- **LIN 1.3**
- **LIN 1.3 (no length control)** – Select this for systems where length control is not used and all nodes have knowledge of the data packet size. In LIN 1.3, the ID may or may not be used to indicate the number of bytes. (In LIN 2.X, there is no length control.)
- **LIN 2.X**

For LIN 1.2 signals, use the LIN 1.3 setting. The LIN 1.3 setting assumes the signal follows the "Table of Valid ID Values" as shown in section A.2 of the LIN Specification dated December 12, 2002. If your signal does not comply with the table, use the LIN 2.X setting.

- 12 Press the **Sync Break** softkey and select the minimum number of clocks that define a sync break in your LIN signal.



## Loading and Displaying LIN Symbolic Data

When you load (recall) a LIN description file (\*.ldf) into the oscilloscope, its symbolic information can be:

- Displayed in the decode waveform and Lister window.
- Used when setting up LIN triggering.
- Used when searching for LIN data in the decode.

To recall a LIN description file into the oscilloscope:

- 1** Press **[Save/Recall]** > **Recall** > **Recall** > **LIN Symbolic data (\*.ldf)**.
- 2** Press **Press to go** and navigate to the LIN description file on a USB storage device.
- 3** Press **Load to:** and select which serial decode (**S1** or **S2**) the symbolic information will be used with.
- 4** Press **Press to Recall**.

The LIN description file remains in the oscilloscope until it is overwritten or a secure erase is performed.

To display LIN symbolic data:

- 1** Press **[Serial]**.
- 2** Press the **Display** softkey and select **Symbolic** (instead of **Hexadecimal**).

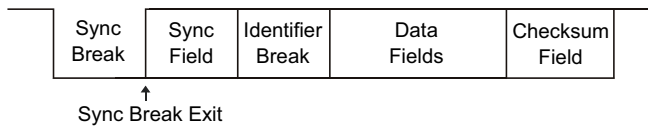
Your choice affects both the decode waveform and the Lister window.

## LIN Triggering

To set up the oscilloscope to capture a LIN signal, see **"Setup for LIN Signals"** on page 407.

LIN triggering can trigger on the rising edge at the Sync Break exit of the LIN single-wire bus signal (that marks the beginning of the message frame), the Frame ID, or the Frame ID and Data.

A LIN signal message frame is shown below:



- 1 Press **[Trigger]**.
- 2 In the Trigger Menu, press the **Trigger Type** softkey; then, turn the Entry knob to select the serial slot (Serial 1 or Serial 2) on which the CAN signal is being decoded.



- 3 Press the **Trigger on:** softkey; then, turn the Entry knob to select the trigger condition:
  - **Sync** (Sync Break) – The oscilloscope triggers on the rising edge at the Sync Break exit of the LIN single-wire bus signal that marks the beginning the message frame.
  - **ID** (Frame ID) – The oscilloscope triggers when a frame with an ID equal to the selected value is detected. Use the **Entry** knob to select the value for the Frame ID.
  - **ID & Data** (Frame ID and Data) – The oscilloscope triggers when a frame with an ID and data equal to the selected values is detected. When triggering on a frame ID and data:
    - To select the frame ID value, press the **Frame ID** softkey, and use the **Entry** knob.  
 Note that you can enter a "don't care" value for the frame ID and trigger on data values only.
    - To set up the number of data bytes and enter their values (in hexadecimal or binary), use the remaining softkeys.
  - **Parity Error** – The oscilloscope triggers on parity errors.
  - **Checksum Error** – The oscilloscope triggers on checksum errors.

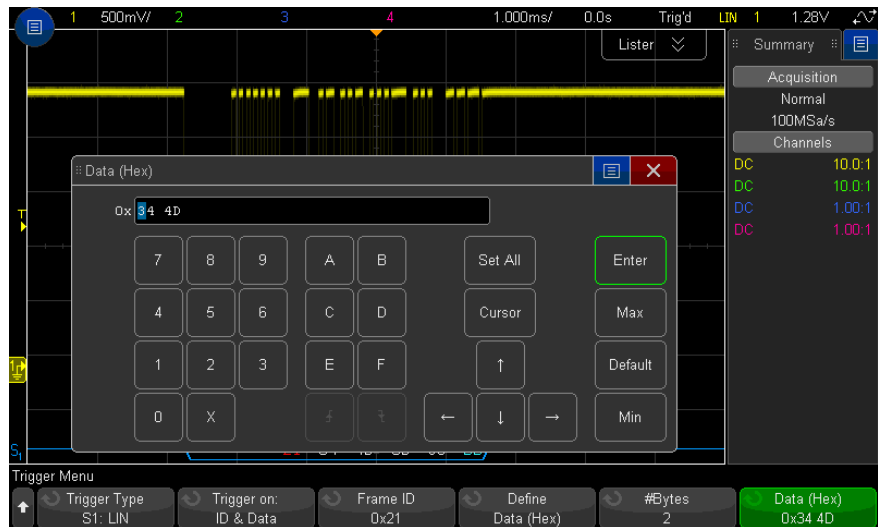
When a LIN description file (\*.ldf) is loaded (recalled) into the oscilloscope (see **"Loading and Displaying LIN Symbolic Data"** on page 409), you can trigger on:

- **Frame (Symbolic)** – a symbolic frame value.

- **Frame and Signal** – a symbolic frame value and a signal value.

Symbolic frames, signals, and values are defined in the LIN description file.

A frame is the symbolic name for a LIN frame ID, a signal is the symbolic name for a bit or set of bits within the LIN data, and a value can be a symbolic representation of the signal bit values or it can be a decimal number with units.



## NOTE

For details about using the LIN Bits Menu softkeys, press and hold the softkey in question to display the built-in help.

## NOTE

For LIN decode information see "[LIN Serial Decode](#)" on page 411.

## LIN Serial Decode

To set up the oscilloscope to capture LIN signals, see "[Setup for LIN Signals](#)" on page 407.

**NOTE**

For LIN triggering setup see [“LIN Triggering”](#) on page 409.

To set up LIN serial decode:

- 1 Press **[Serial]** to display the Serial Decode Menu.



- 2 Choose whether to include the parity bits in the identifier field.
  - a If you want to mask the upper two parity bits, ensure that the box under the **Show Parity** softkey is not selected.
  - b If you want to include the parity bits in the identifier field, ensure that the box under the **Show Parity** softkey is selected.
- 3 If the decode line does not appear on the display, press the **[Serial]** key to turn it on.
- 4 If the oscilloscope is stopped, press the **[Run/Stop]** key to acquire and decode data.

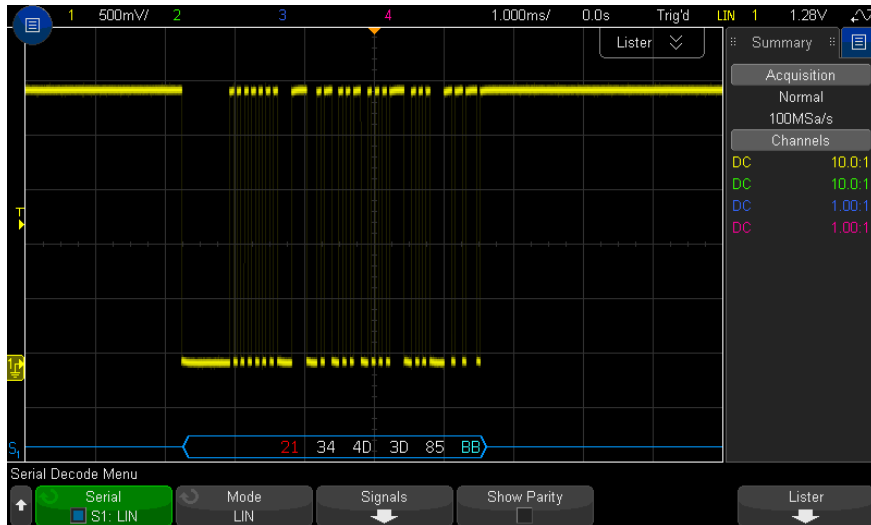
**NOTE**

If the setup does not produce a stable trigger, the LIN signal may be slow enough that the oscilloscope is AutoTriggering. Press the **[Mode/Coupling]** key, then press the **Mode** softkey to set the trigger mode from **Auto** to **Normal**.

You can use the horizontal **Zoom** window for easier navigation of the decoded data.

- See Also
- [“Interpreting LIN Decode”](#) on page 413
  - [“Interpreting LIN Lister Data”](#) on page 414
  - [“Searching for LIN Data in the Lister”](#) on page 414

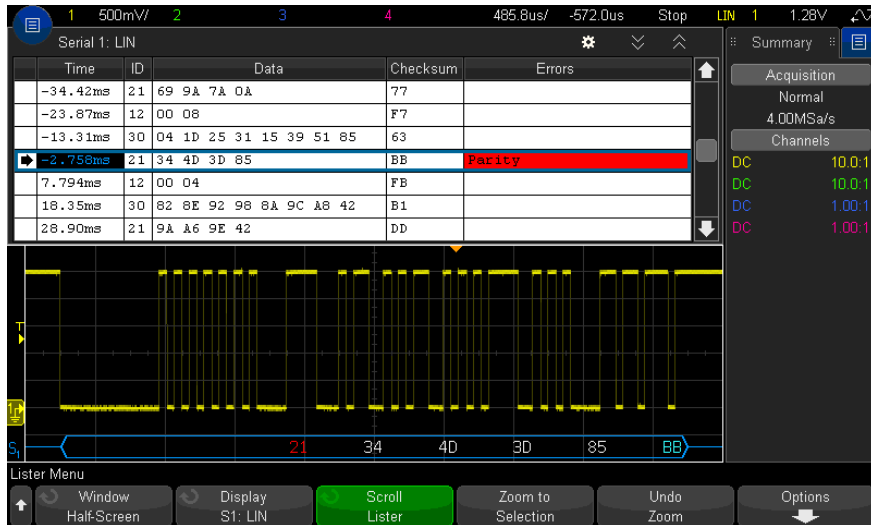
## Interpreting LIN Decode



- Angled waveforms show an active bus (inside a packet/frame).
- Mid-level blue lines show an idle bus.
- The hexadecimal ID and parity bits (if enabled) appear in yellow. If a parity error is detected the hexadecimal ID and parity bits (if enabled) appear in red.
- Decoded hexadecimal data values appear in white.
- The checksum appears in blue if correct, or red if incorrect.
- Decoded text is truncated at the end of the associated frame when there is insufficient space within frame boundaries.
- Pink vertical bars indicate you need to expand the horizontal scale (and run again) to see decode.
- Red dots in the decode line indicate that there is data that is not being displayed. Scroll or expand the horizontal scale to view the information.
- Unknown bus values (undefined or error conditions) are drawn in red.
- If there is an error in the synch field, SYNC will appear in red.
- If the header exceeds the length specified in the standard, THM will appear red.
- If the total frame count exceeds the length specified in the standard, TFM will appear red (LIN 1.3 only).

- For LIN 1.3 a wakeup signal is indicated by WAKE in blue. If the wakeup signal is not followed by a valid wakeup delimiter a wakeup error is detected and displayed as WUP in red.

## Interpreting LIN Lister Data



In addition to the standard Time column, the LIN Lister contains these columns:

- ID – frame ID. Can be displayed as hex digits or symbolic information (see ["Loading and Displaying LIN Symbolic Data"](#) on page 409).
- Data – data bytes. Can be displayed as hex digits or symbolic information.
- Checksum.
- Errors – highlighted in red.

Aliased data is highlighted in pink. When this happens, decrease the horizontal time/div setting and run again.

## Searching for LIN Data in the Lister

The oscilloscope's search capability lets you search for (and mark) certain types of LIN data in the Lister. You can use the **[Navigate]** key and controls to navigate through the marked rows.

- 1 With LIN selected as the serial decode mode, press **[Search]**.
- 2 In the Search Menu, press the **Search** softkey; then, turn the Entry knob to select the serial slot (Serial 1 or Serial 2) on which the LIN signal is being decoded.
- 3 Press **Search**; then, select from these options:
  - **ID** – Finds frames with the specified ID. Press the Frame ID softkey to select the ID.
  - **ID & Data** – Finds frames with the specified ID and data. Press the Frame ID softkey to select the ID. Press the Bits softkey to enter the data value.
  - **Errors** – Finds all errors.

For more information on searching data, see **"Searching Lister Data"** on page 152.

For more information on using the **[Navigate]** key and controls, see **"Navigating the Time Base"** on page 75.





# 26 CXPI Triggering and Serial Decode

Setup for CXPI Signals / 417

CXPI Triggering / 418

CXPI Serial Decode / 421

CXPI (Clock Extension Peripheral Interface) triggering and serial decode requires the DSOXT3CXPI license.

## Setup for CXPI Signals

To set up the oscilloscope to capture CXPI signals:

- 1 Connect an oscilloscope channel to the signal in the device under test.  
Analog channels can be used.
- 2 Press **[Serial]**.
- 3 Press the **Serial** softkey, turn the Entry knob to select the desired slot (Serial 1 or Serial 2), and press the softkey again to enable decode.
- 4 Press the **Mode** softkey; then, select **CXPI**.
- 5 Press the **Bus Config** softkey to open the CXPI Bus Configuration Menu.



- a Press the **Source** softkey; then, turn the Entry knob to select the channel for the signal.
- b Press the **Threshold** softkey; then, turn the Entry knob to select the signal threshold voltage level.


The threshold voltage level is used in decoding, and it will become the trigger level when the trigger type is set to the selected serial decode (Serial 1 or Serial 2).

- c Press the **Tolerance** softkey; then, turn the Entry knob (or press the softkey again and use a keypad dialog) to specify the tolerance as a percentage of the Tbit width.
- d Press the **Baud Rate** softkey; then, turn the Entry knob (or press the softkey again and use a keypad dialog) to match the baud rate of the CXPI signal from your device under test.

The CXPI baud rate can be set from 9600 b/s to 40000 b/s in 100 b/s increments.

You must set the baud rate to match your device under test.

The default baud rate is 20 kb/s.

- e Select **Show Parity** to include the parity bit in the identifier field.  
When **Show Parity** is not selected, the upper bit is masked. The parity is still checked, but it is not displayed unless a parity error occurs.  
Parity errors are shown in red.
- f Press the  Back/Up key to return to the CXPI Serial Decode Menu.

## CXPI Triggering

To set up the oscilloscope to capture CXPI signals, see **“Setup for CXPI Signals”** on page 417.

When CXPI (Clock Extension Peripheral Interface) is selected as one of the serial bus decodes, you can trigger on CXPI signals.

CXPI frames have the following format:

Normal frame

PID (1 byte)		Frame Info (1 byte)			Data (0-12 bytes)	CRC (1 byte)
Parity (1 bit)	Frame ID (7 bits)	DLC (4 bits)	NM (2 bits)		CT (2 bits)	
			wakeup	sleep		

Long frame


PID (1 byte)		Frame Info (2 bytes)				Data (0-255 bytes)	CRC (2 bytes)
Parity (1 bit)	Frame ID (7 bits)	DLC (4 bits, = 0xF)	NM (2 bits)		CT (2 bits)	Extension DLC (1 byte)	
			wakeup	sleep			

- DLC = Data Length Code
- NM = Network Management
- CT = Counter

To set up a CXPI trigger condition:

- 1 Press **[Trigger]**.
- 2 In the Trigger Menu, press the **Trigger Type** softkey; then, turn the Entry knob to select the serial decode (Serial 1 or Serial 2) of the CXPI signal.



- 3 Press the **Trigger on:** softkey and use the  Entry knob to select the CXPI trigger type:

- **SOF - Start of Frame** – triggers at the start bit of any frame.
- **EOF - End of Frame** – triggers at the end of any frame.
- **PTYPE** – triggers on any frame that starts with the special PTYPE byte.

PTYPE frames begins with an extra PID byte with a Frame ID of 0000000b (reserved for only PTYPE frames). The PTYPE PID byte is then followed by a regular PID byte and the rest of the normal frame. The extra PTYPE byte is never included in the CRC calculation.

- **Frame ID** – triggers on a user-defined Frame ID at the end of the PID byte. The Frame ID value is user-defined, 7 bits, and has bitwise don't-cares. You can specify whether to trigger on PTYPE present or no PTYPE present.
  - **Frame ID, Info and Data** – triggers on CXPI frames at the end of the last data byte defined in the trigger. In addition to the PID value, you can specify the contents of the Frame Info byte with bitwise don't-cares. You can specify up to 12 data bytes on which to trigger with bitwise don't-cares.
  - **Frame ID, Info and Data (Long Frame)** – triggers on CXPI frames at the end of the last data byte defined in the trigger. The standard DLC field will be locked to 1111b. You can specify up to 12 bytes of data on which to trigger and specify the start byte number as an offset. The offset can be up to 123 bytes when PTYPE is present or 124 bytes when PTYPE is not present.
  - **CRC Field Error** – triggers when the calculated CRC does not match the transmitted CRC. You can optionally filter by Frame ID and PTYPE as in the Frame ID trigger.
  - **Parity Error** – triggers when the parity bit in the PID or PTYPE field is not correct.
  - **Inter-Byte Space Error** – triggers when there are more than 9 bits between consecutive bytes in a frame. You can optionally filter by Frame ID and PTYPE as in the Frame ID trigger.
  - **Inter-Frame Space Error** – triggers when there are fewer than 10 idle bits before a new frame begins.
  - **Framing Error** – triggers when the stop bit of a byte is not logical 1. You can optionally filter by Frame ID and PTYPE as in the Frame ID trigger.
  - **Data Length Error** – triggers when there are more data bytes in a frame than is indicated by the DLC or Extended DLC field. You can optionally filter by Frame ID and PTYPE as in the Frame ID trigger.
  - **Sample Error** – triggers when 10 consecutive logical 0s are detected.
  - **All Errors** – triggers on all CRC, Parity, IBS, Stop Bit, Data Length, and Sample errors.
  - **Sleep Frame** – triggers when a normal frame is transmitted matching the definition of a sleep frame in the CXPI specification.
  - **Wakeup Pulse** – triggers when a wakeup pulse is detected.
- 4 For the trigger types that let you trigger on data, press the **Bits** softkey. In the CXPI Bits Menu, you can specify ID, Frame Info, and Data values to trigger on:

- **Define** – this softkey selects what you want to specify (ID, Frame Info, or Data) and in what format (Hex, or Binary). The remaining softkeys in the menu let you enter values.
  - **PTYPE** – when specifying ID values, this softkey specifies whether you want to trigger when the special PTYPE byte is present or not present.
  - **DLC** – when specifying Frame Info or Data values, this softkey specifies the data length code to trigger on. This will also affect the number of data bytes you can specify in the trigger.
  - **# of Bytes** – this softkey specifies the number of bytes of data to trigger on. It is limited by the specified DLC value but can be smaller.
  - **Start Byte #** – when triggering on long frames, the maximum number of bytes of data you can trigger on is 12, but those 12 bytes can be located at an offset within the data. This softkey specifies the offset starting byte. The starting byte can be up to 123 when PTYPE is present or up to 124 when PTYPE is not present.
- 5 When triggering on CRC Field Errors, Inter-Byte Space Errors, Framing Errors, or Data Length Errors, there is a **Filter by ID** softkey that you can enable to modify the trigger so that it occurs only for a specified ID.

**NOTE**

If the setup does not produce a stable trigger, the CXPI signals may be slow enough that the oscilloscope is AutoTriggering. Press the **[Mode/Coupling]** key, then press the **Mode** softkey to set the trigger mode from **Auto** to **Normal**.

**NOTE**

To display CXPI serial decode, see **“CXPI Serial Decode”** on page 421.

## CXPI Serial Decode

To set up the oscilloscope to capture CXPI signals, see **“Setup for CXPI Signals”** on page 417.

**NOTE**

For CXPI triggering setup see **“CXPI Triggering”** on page 418.

To set up CXPI serial decode:

- 1 Press **[Serial]** to display the Serial Decode Menu.



- 2 If the decode line does not appear on the display, press the **[Serial]** key to turn it on.
- 3 If the oscilloscope is stopped, press the **[Run/Stop]** key to acquire and decode data.

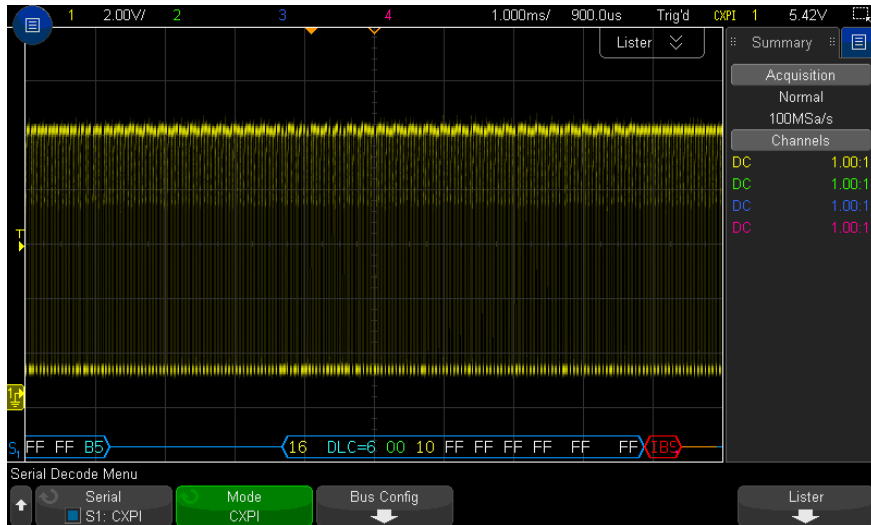
#### NOTE

If the setup does not produce a stable trigger, the CXPI signals may be slow enough that the oscilloscope is AutoTriggering. Press the **[Mode/Coupling]** key, then press the **Mode** softkey to set the trigger mode from **Auto** to **Normal**.

You can use the horizontal **Zoom** window for easier navigation of the acquired data.

- See Also
- [“Interpreting CXPI Decode”](#) on page 423
  - [“Interpreting CXPI Lister Data”](#) on page 425

## Interpreting CXPI Decode



The CXPI decode display is color coded as follows:

- Blue angled waveforms show an active bus (inside a packet/frame).
- Blue mid-level lines show an idle bus.
- For PTYPE frames, the text "PTYPE" is shown in the decode before the Frame ID. If the parity bit in the PTYPE field is in error, the "PTYPE" text is displayed in red.
- Packet/Frame ID – yellow hex digits. The packet/frame ID can optionally show or omit the leading parity bit.
- Data Length Code (DLC) – cyan. The DLC is always a decimal value.
- Network Management (NM) – green. Binary value, two bits.
- Counter (CT) – yellow. Binary value, two bits.
- Data bytes – white text formatted as a pair of hexadecimal nibbles for each byte. These hexadecimal bytes are shown with MSB at the left..
- CRC – cyan hex digits when valid, red when error detected.
- Red angled waveforms – Unknown or error condition.
- Flagged error frames – red, with:

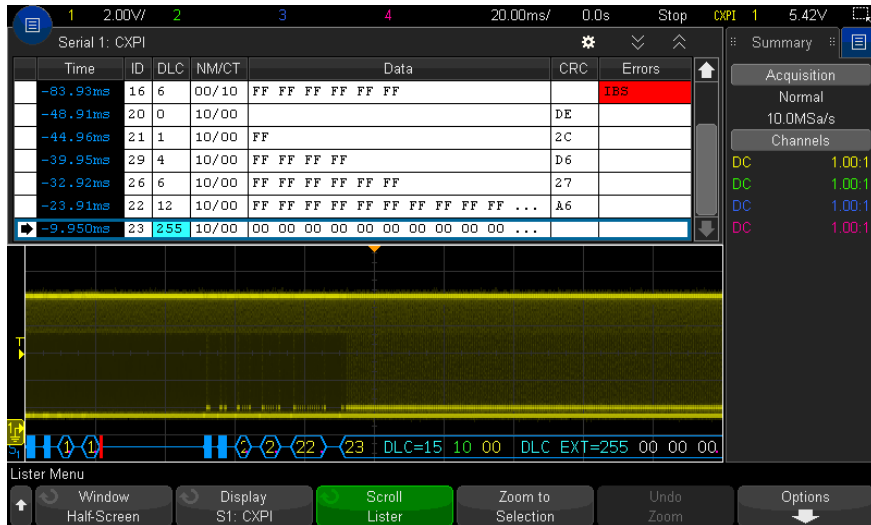
- "IBS ERR" – Inter-Byte Space error. When the space between bytes in a frame is greater than 9 bits.
- "IFS ERR" – Inter-Frame Space error. When there are fewer than 10 bits present in the idle state before a new frame starts.
- "FRAME ERR" – Framing error. When the stop bit is not a logical 1.
- "LEN ERR" – Data Length error. If the frame has more data bytes than are indicated in the DLC field.
- "SAMP ERR" – Sample error. If 10 logical 0s are detected consecutively.
- "?" – (unknown)
- Pink vertical bars – Expand horizontal scale (and run again) to see decode.
- Red Dot – More information is available. Decoded text is truncated to fit. Expand the horizontal scale to view the information.

When the bus goes into sleep conditions, special frames are drawn:

- SLEEP frame – orange. Displayed 2.5 ms after the bus goes idle-high. In the Lister, the fixed hex data values in the Data column are replaced by the text "SLEEP FRAME".
- WAKE frame – blue. When a low pulse of 250-2500  $\mu$ s is detected, it is a wakeup pulse, and a blue WAKE frame will be drawn. After that pulse will be an orange line. The decode line will turn blue/idle after the first 10 clock ticks are detected (but not before).



## Interpreting CXPI Lister Data



In addition to the standard Time column, the CXPI Lister contains these columns:

- ID – value in Hex.
- DLC – (Data Length Code) values in Decimal.
- NM/CT – (Network Management/Counter) values in Binary.
- Data – values in Hex.

For sleep frames, data values are replaced by the text "SLEEP FRAME".

- CRC – value in Hex.
- Errors – string value that displays the type of error detected:
  - CRC – CRC Error.
  - Parity Error.
  - IBS – IBS Error.
  - Fr – Frame Error.
  - LEN – LENGTH Error.
  - SAMP – SAMPLE Error.



# 27 FlexRay Triggering and Serial Decode

Setup for FlexRay Signals / 427

FlexRay Triggering / 428

FlexRay Serial Decode / 431

FlexRay triggering and serial decode requires the FLEX license that you can get by purchasing the DSOX3FLEX upgrade.

## Setup for FlexRay Signals

FlexRay signal setup consists of first connecting the oscilloscope to a differential FlexRay signal using a differential active probe (the Keysight N2792A is recommended), specifying the signal source, threshold voltage trigger level, baud rate, and bus type.

To set up the oscilloscope to capture FlexRay signals:

- 1 Press **[Serial]**.
- 2 Press the **Serial** softkey, turn the Entry knob to select the desired serial bus (Serial 1 or Serial 2), and press the softkey again to enable decode.
- 3 Press the **Mode** softkey; then, select **FlexRay** mode.
- 4 Press the **Signals** softkey to open the FlexRay Signals Menu.



- 5 Press **Source** and select the analog channel that is probing the FlexRay signal.
- 6 Press **Threshold**; then, turn the Entry knob to set the threshold voltage level.  
The threshold level should be set below the idle level.  
  
The threshold voltage level is used in decoding and will become the trigger level when the trigger type is set to the selected serial decode bus.
- 7 Press **Baud** and select the baud rate of the FlexRay signal being probed.
- 8 Press **Bus** and select the bus type of the FlexRay signal being probed.  
  
It is important to specify the correct bus because this setting affects CRC error detection.
- 9 Press **Auto Setup** to perform the following actions:
  - Sets the selected source channel's impedance to 50 Ohms, assuming a differential active probe that requires a 50 ohm termination is being used .
  - Sets the selected source channel's probe attenuation to 10:1.
  - Sets the trigger level (on the selected source channel) to -300 mV.
  - Turns on trigger Noise Reject.
  - Turns on Serial Decode.
  - Sets the trigger type to FlexRay.

## FlexRay Triggering

To set up the oscilloscope to capture a FlexRay signal, see **“Setup for FlexRay Signals”** on page 427.

After you have set up the oscilloscope to capture a FlexRay signal, you can then set up triggers on frames (see [page 429](#)), errors (see [page 430](#)), or events (see [page 430](#)).

### NOTE

To display FlexRay serial decode, see **“FlexRay Serial Decode”** on page 431.

## Triggering on FlexRay Frames

- 1 Press **[Trigger]**.
- 2 In the Trigger Menu, press the **Trigger** softkey; then, turn the Entry knob to select the serial bus (Serial 1 or Serial 2) on which the FlexRay signals are being decoded.



- 3 Press the **Trigger** softkey; then, turn the Entry knob to select **Frame**.
- 4 Press the **Frames** softkey to open the FlexRay Frame Trigger Menu.



- 5 Press the **Frame ID** softkey, and use the Entry knob to select the frame ID value from **All** or 1 to 2047.
- 6 Press the **Frame Type** softkey to select the frame type:
  - **All Frames**
  - **Startup Frames**
  - **NULL Frames**
  - **Sync Frames**
  - **Normal Frames**
  - **NOT Startup Frames**
  - **NOT NULL Frames**
  - **NOT Sync Frames**
- 7 Press the **Cyc Ct Rep** softkey, and use the Entry knob to select the cycle count repetition factor (**2, 4, 8, 16, 32, or 64, or All**).
- 8 Press the **Cyc Ct Bas** softkey, and use the Entry knob to select the cycle count base factor from 0 through the **Cyc Ct Rep** factor minus 1.

For example, with a base factor of 1 and a repetition factor of 16, the oscilloscope triggers on cycles 1, 17, 33, 49, and 65.

To trigger on a particular cycle, set the Cycle Repetition factor to 64 and use the cycle base factor to choose a cycle.

To trigger all (any) cycles, set the Cycle Repetition factor to All. The scope will trigger on any and all cycles.

**NOTE**

Because specific FlexRay frames may occur infrequently, it may be helpful to press the **[Mode/Coupling]** key, then press the **Mode** softkey to set the trigger mode from **Auto** to **Normal**. This prevents the oscilloscope from Auto triggering while waiting for a particular frame and cycle combination.

## Triggering on FlexRay Errors

- 1 Press **[Trigger]**.
- 2 In the Trigger Menu, press the **Trigger** softkey; then, turn the Entry knob to select the serial bus (Serial 1 or Serial 2) on which the FlexRay signals are being decoded.
- 3 Press the **Trigger** softkey; then, turn the Entry knob to select **Error**.



- 4 Press the **Errors** softkey; then, select the error type:
  - **All Errors**
  - **Header CRC Error** – cyclic redundancy check error in the header.
  - **Frame CRC Error** – cyclic redundancy check error in the frame.

**NOTE**

Because FlexRay errors occur infrequently it may be helpful to set the oscilloscope to press the **[Mode/Coupling]** key, then press the **Mode** softkey to set the trigger mode from **Auto** to **Normal**. This prevents the oscilloscope from Auto triggering while waiting for an error to occur. You may need to adjust trigger holdoff to see a particular error when multiple errors exist.

## Triggering on FlexRay Events

- 1 Press **[Trigger]**.

- 2 In the Trigger Menu, press the **Trigger** softkey; then, turn the Entry knob to select the serial bus (Serial 1 or Serial 2) on which the FlexRay signals are being decoded.
- 3 Press the **Trigger** softkey; then, turn the Entry knob to select **Event**.



- 4 Press the **Event** softkey; then, select the event type:
  - **Wake-up**
  - **TSS** – Transmission Start Sequence.
  - **BSS** – ByteStart Sequence.
  - **FES/DTS** – Frame End or Dynamic Trailing Sequence.
- 5 Press **Auto Setup for Event**.

This automatically configures oscilloscope settings (as shown on the display) for the selected event trigger.

## FlexRay Serial Decode

To set up the oscilloscope to capture FlexRay signals, see [“Setup for FlexRay Signals”](#) on page 427.

### NOTE

For FlexRay triggering setup see [“FlexRay Triggering”](#) on page 428.

To set up FlexRay serial decode:

- 1 Press [**Serial**] to display the Serial Decode Menu.

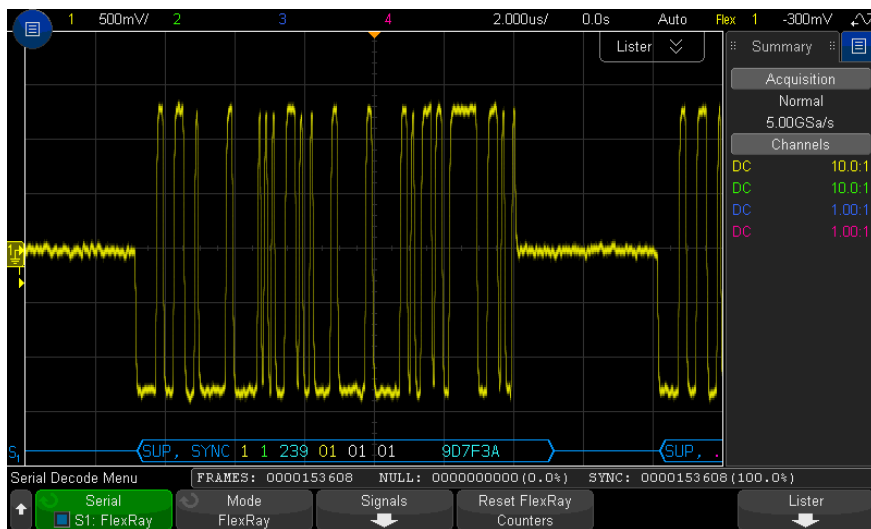


- 2 If the decode line does not appear on the display, press the **[Serial]** key to turn it on.
- 3 If the oscilloscope is stopped, press the **[Run/Stop]** key to acquire and decode data.

You can use the horizontal **Zoom** window for easier navigation of the acquired data.

- See Also
- [“Interpreting FlexRay Decode”](#) on page 432
  - [“FlexRay Totalizer”](#) on page 433
  - [“Interpreting FlexRay Lister Data”](#) on page 434
  - [“Searching for FlexRay Data in the Lister”](#) on page 434

## Interpreting FlexRay Decode



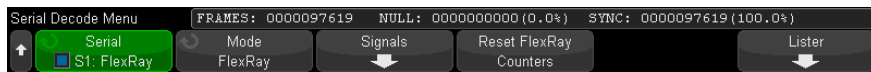
- Frame type (NORM, SYNC, SUP, NULL in blue).
- Frame ID (decimal digits in yellow).
- Payload-length (decimal number of words in green).
- Header CRC (hex digits in blue plus red HCRC error message if invalid).
- Cycle number (decimal digits in yellow).
- Data bytes (HEX digits in white).



- Frame CRC (hex digits in blue plus red FCRC error message if invalid).
- Frame/coding errors (specific error symbol in red).

## FlexRay Totalizer

The FlexRay totalizer consists of counters that provide a direct measure of bus quality and efficiency. The totalizer appears on screen whenever FlexRay Decode is ON in the Serial Decode Menu.



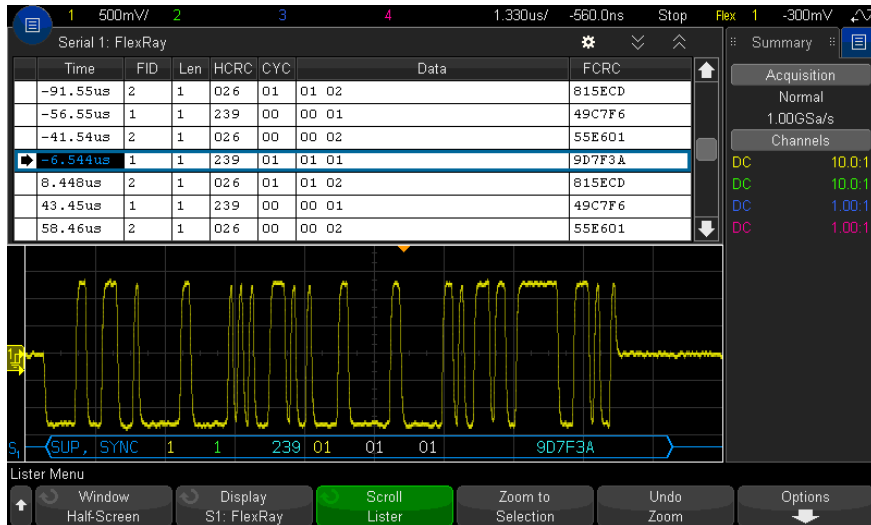
- The FRAMES counter gives a real-time count of all captured frames.
- The NULL counter gives the number and percentage of null frames.
- The SYNC counter gives the number and percentage of sync frames.

The totalizer runs, counting frames and calculating percentages, even when the oscilloscope is stopped (not acquiring data).

When an overflow condition occurs, the counter displays **OVERFLOW**.

The counters can be reset to zero by pressing the **Reset FlexRay Counters** softkey.

## Interpreting FlexRay Lister Data



In addition to the standard Time column, the FlexRay Lister contains these columns:

- FID – frame ID.
- Len – payload length.
- HCRC – header CRC.
- CYC – cycle number.
- Data.
- FCRC – frame CRC.
- Frames with errors are highlighted in red.

## Searching for FlexRay Data in the Lister

The oscilloscope's search capability lets you search for (and mark) certain types of FlexRay data in the Lister. You can use the **[Navigate]** key and controls to navigate through the marked rows.

- 1 With FlexRay selected as the serial decode mode, press **[Search]**.

- 2 In the Search Menu, press the **Search** softkey; then, turn the Entry knob to select the serial bus (Serial 1 or Serial 2) on which the FlexRay signals are being decoded.
- 3 In the Search Menu, press **Search for**; then, select from these options:
  - **Frame ID** – Finds frames with the specified ID. Press the Frame ID softkey to select the ID.
  - **Cycle number (+ Frame ID)** – Finds frames with the specified cycle number and ID. Press the Frame ID softkey to select the ID. Press the Cycle # softkey to select the number.
  - **Data (+ Frame ID + Cycle number)** – Finds frames with the specified data, cycle number, and frame ID. Press the **Frame ID** softkey to select the ID. Press the **Cycle #** softkey to select the number. Press the **Data** softkey to open a menu where you can enter the data value.
  - **Header CRC Error** – Finds cyclic redundancy check errors in headers.
  - **Frame CRC Error** – Finds cyclic redundancy check errors in frames.
  - **Errors** – finds all errors.

For more information on searching data, see "[Searching Lister Data](#)" on page 152.

For more information on using the **[Navigate]** key and controls, see "[Navigating the Time Base](#)" on page 75.



# 28 I2C/SPI Triggering and Serial Decode

Setup for I2C Signals / 437

I2C Triggering / 438

I2C Serial Decode / 442

Setup for SPI Signals / 445

SPI Triggering / 449

SPI Serial Decode / 451

I2C/SPI triggering and serial decode requires the EMBD license that you can get by purchasing the DSOX3EMBD upgrade.

## NOTE

Only one SPI serial bus can be decoded at a time.

---

## Setup for I2C Signals

I<sup>2</sup>C (Inter-IC bus) signals setup consists of connecting the oscilloscope to the serial data (SDA) line and the serial clock (SCL) line and then specifying the input signal threshold voltage levels.

To set up the oscilloscope to capture I<sup>2</sup>C signals, use the **Signals** softkey which appears in the Serial Decode Menu:

- 1 Press **[Serial]**.

- 2 Press the **Serial** softkey, turn the Entry knob to select the desired slot (Serial 1 or Serial 2), and press the softkey again to enable decode.
- 3 Press the **Mode** softkey; then, select **I2C** trigger type.
- 4 Press the **Signals** softkey to open the I<sup>2</sup>C Signals Menu.



- 5 For both the SCL (serial clock) and SDA (serial data) signals:
  - a Connect an oscilloscope channel to the signal in the device under test.
  - b Press the **SCL** or **SDA** softkey; then, turn the Entry knob to select the channel for the signal.
  - c Press the corresponding **Threshold** softkey; then, turn the Entry knob to select the signal threshold voltage level.

The threshold voltage level is used in decoding, and it will become the trigger level when the trigger type is set to the selected serial decode slot.

Data must be stable during the whole high clock cycle or it will be interpreted as a start or stop condition (data transitioning while the clock is high).

The SCL and SDA labels for the source channels are automatically set.

## I2C Triggering

To set up the oscilloscope to capture I2C signals, see **“Setup for I2C Signals”** on page 437.

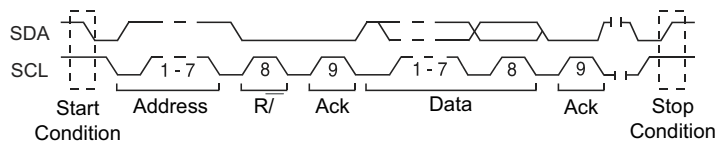
After the oscilloscope has been set up to capture I2C signals, you can trigger on a stop/start condition, a restart, a missing acknowledge, an EEPROM data read, or on a read/write frame with a specific device address and data value.

- 1 Press **[Trigger]**; then, select the **I2C** trigger type.
- 2 Press **[Trigger]**.
- 3 In the Trigger Menu, press the **Trigger** softkey; then, turn the Entry knob to select the serial slot (Serial 1 or Serial 2) on which the I<sup>2</sup>C signals are being decoded.

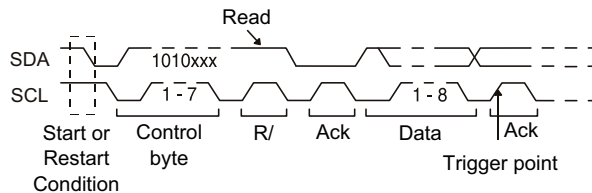


4 Press the **Trigger**: softkey; then, turn the Entry knob to select the trigger condition:

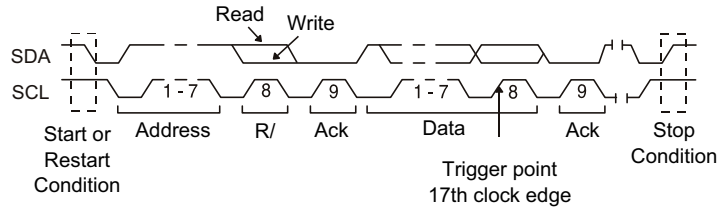
- **Start Condition**– The oscilloscope triggers when SDA data transitions from high to low while the SCL clock is high. For triggering purposes (including frame triggers), a restart is treated as a start condition.
- **Stop Condition**– The oscilloscope triggers when data (SDA) transitions from low to high while the clock (SCL) is high.



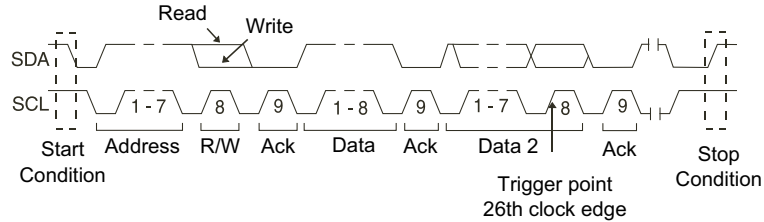
- **Missing Acknowledge**– The oscilloscope triggers when SDA data is high during any Ack SCL clock bit.
- **Address with no Ack**– The oscilloscope triggers when the acknowledge of the selected address field is false. The R/W bit is ignored.
- **Restart**– The oscilloscope triggers when another start condition occurs before a stop condition.
- **EEPROM Data Read**– The trigger looks for EEPROM control byte value 1010xxx on the SDA line, followed by a Read bit and an Ack bit. It then looks for the data value and qualifier set by the **Data** softkey and the **Data is** softkey. When this event occurs, the oscilloscope will trigger on the clock edge for the Ack bit after the data byte. This data byte does not need to occur directly after the control byte.



- Frame (Start: Addr7: Read: Ack: Data) or Frame (Start: Addr7: Write: Ack: Data)**— The oscilloscope triggers on a read or write frame in 7-bit addressing mode on the 17th clock edge if all bits in the pattern match. For triggering purposes, a restart is treated as a start condition.



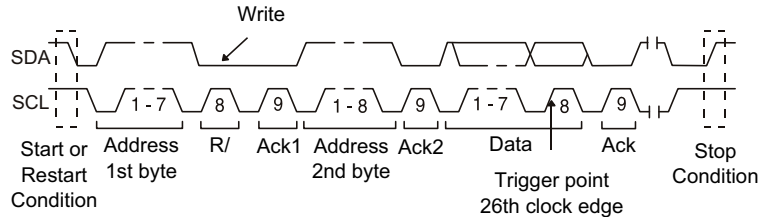
- Frame (Start: Addr7: Read: Ack: Data: Ack: Data2) or Frame (Start: Addr7: Write: Ack: Data: Ack: Data2)**— The oscilloscope triggers on a read or write frame in 7-bit addressing mode on the 26th clock edge if all bits in the pattern match. For triggering purposes, a restart is treated as a start condition.



- 10-bit Write** – The oscilloscope triggers on a 10-bit write frame on the 26th clock edge if all bits in the pattern match. The frame is in the format:

Frame (Start: Address byte 1: Write: Address byte 2: Ack: Data)

For triggering purposes, a restart is treated as a start condition.





**5** If you have set the oscilloscope to trigger on an EEPROM Data Read condition:

Press the **Data is** softkey to set the oscilloscope to trigger when data is = (equal to),  $\neq$  (not equal to),  $<$  (less than), or  $>$  (greater than) the data value set in the **Data** softkey.

The oscilloscope will trigger on the clock edge for the Ack bit after the trigger event is found. This data byte does not need to occur directly after the control byte. The oscilloscope will trigger on any data byte that meets the criteria defined by the **Data is** and **Data** softkeys during a current address read or a random read or a sequential read cycle.

**6** If you have set the oscilloscope to trigger on a 7-bit address read or write frame condition or a 10-bit write frame condition:

- a** Press the **Address** softkey and turn the Entry knob to select the 7-bit or 10-bit device address.

You can select from an address range of 0x00 to 0x7F (7-bit) or 0x3FF (10-bit) hexadecimal. When triggering on a read/write frame, the oscilloscope will trigger after the start, address, read/write, acknowledge, and data events occur.

If don't care is selected (0xXX or 0XXXX) for the address, the address will be ignored. The trigger will always occur on the 17th clock for 7-bit addressing or 26th clock for 10-bit addressing.

- b** Press the **Data** value softkey and turn the Entry knob to select the 8-bit data pattern on which to trigger.

You can select a data value in the range of 0x00 to 0xFF (hexadecimal). The oscilloscope will trigger after the start, address, read/write, acknowledge, and data events occur.

If don't care (0xXX) is selected for data, the data will be ignored. The trigger will always occur on the 17th clock for 7-bit addressing or 26th clock for 10-bit addressing.

- c** If you have selected a three-byte trigger, press the **Data2** value softkey and turn the Entry knob to select the 8-bit data pattern on which to trigger.

**NOTE**

To display I2C serial decode, see **"I2C Serial Decode"** on page 442.

## I2C Serial Decode

To set up the oscilloscope to capture I2C signals, see [“Setup for I2C Signals”](#) on page 437.

### NOTE

For I2C triggering setup see [“I2C Triggering”](#) on page 438.

To set up I2C serial decode:

- 1 Press **[Serial]** to display the Serial Decode Menu.



- 2 Choose 7-bit or 8-bit address size. Use 8-bit address size to include the R/W bit as part of the address value, or choose 7-bit address size to exclude the R/W bit from the address value.
- 3 If the decode line does not appear on the display, press the **[Serial]** key to turn it on.
- 4 If the oscilloscope is stopped, press the **[Run/Stop]** key to acquire and decode data.

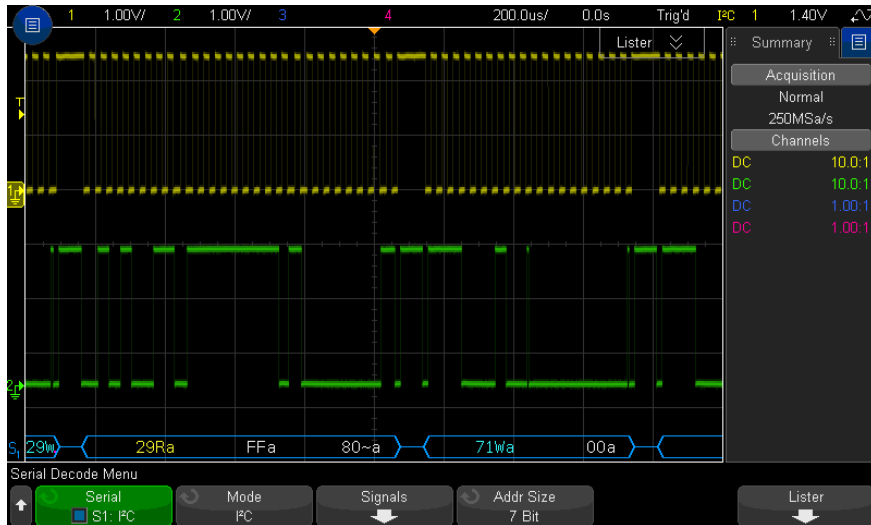
### NOTE

If the setup does not produce a stable trigger, the I2C signals may be slow enough that the oscilloscope is AutoTriggering. Press the **[Mode/Coupling]** key, then press the **Mode** softkey to set the trigger mode from **Auto** to **Normal**.

You can use the horizontal **Zoom** window for easier navigation of the acquired data.

- See Also
- [“Interpreting I2C Decode”](#) on page 443
  - [“Interpreting I2C Lister Data”](#) on page 444
  - [“Searching for I2C Data in the Lister”](#) on page 444

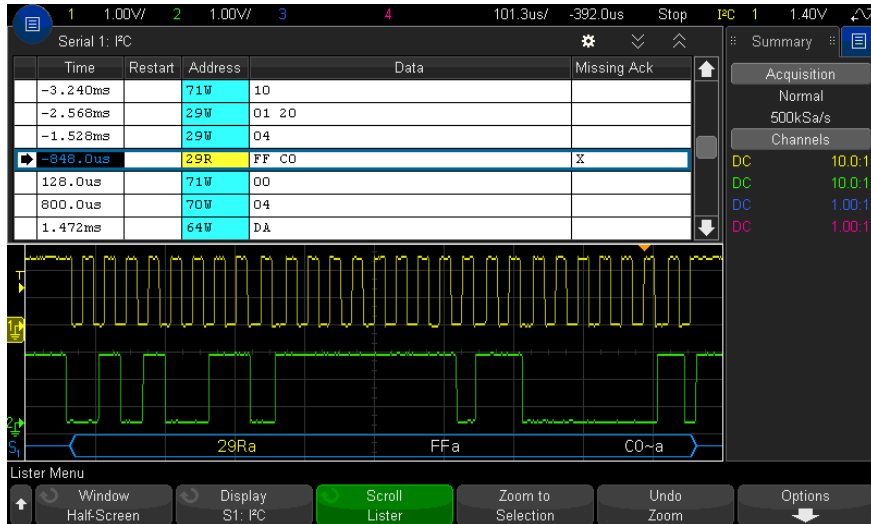
## Interpreting I2C Decode



- Angled waveforms show an active bus (inside a packet/frame).
- Mid-level blue lines show an idle bus.
- In the decoded hexadecimal data:
  - Address values appear at the start of a frame.
  - Write addresses appear in light-blue along with the "W" character.
  - Read addresses appear in yellow along with the "R" character.
  - Restart addresses appear in green along with the "S" character.
  - Data values appear in white.
  - "a" indicates Ack (low), "~a" indicates No Ack (high).
  - Decoded text is truncated at the end of the associated frame when there is insufficient space within frame boundaries.
- Pink vertical bars indicate you need to expand the horizontal scale (and run again) to see decode.
- Red dots in the decode line indicate that more data can be displayed. Scroll or expand the horizontal scale to view the data.
- Aliased bus values (undersampled or indeterminate) are drawn in pink.

- Unknown bus values (undefined or error conditions) are drawn in red.

## Interpreting I2C Lister Data



In addition to the standard Time column, the I2C Lister contains these columns:

- Restart – indicated with an "X".
- Address – colored blue for writes, yellow for reads.
- Data – data bytes.
- Missing Ack – indicated by an "X", highlighted in red if an error.

Aliased data is highlighted in pink. When this happens, decrease the horizontal time/div setting and run again.

## Searching for I2C Data in the Lister

The oscilloscope's search capability lets you search for (and mark) certain types of I2C data in the Lister. You can use the **[Navigate]** key and controls to navigate through the marked rows.

- 1 With I2C selected as the serial decode mode, press **[Search]**.

- 2 In the Search Menu, press the **Search** softkey; then, turn the Entry knob to select the serial slot (Serial 1 or Serial 2) on which the I2C signal is being decoded.
- 3 Press **Search**; then, select from these options:
  - **Missing Acknowledge** – finds SDA data is high during any Ack SCL clock bit.
  - **Address with no Ack** – finds when the acknowledge of the selected address field is false. The R/W bit is ignored.
  - **Restart** – finds when another start condition occurs before a stop condition.
  - **EEPROM Data Read** – finds EEPROM control byte value 1010xxx on the SDA line, followed by a Read bit and an Ack bit. It then looks for the data value and qualifier set by the Data is softkey and the Data softkeys.
  - **Frame(Start:Address7:Read:Ack:Data)** – finds a read frame on the 17th clock edge if all bits in the pattern match.
  - **Frame(Start:Address7:Write:Ack:Data)** – finds a write frame on the 17th clock edge if all bits in the pattern match.
  - **Frame(Start:Address7:Read:Ack:Data:Ack:Data2)** – finds a read frame on the 26th clock edge if all bits in the pattern match.
  - **Frame(Start:Address7:Write:Ack:Data:Ack:Data2)** – finds a write frame on the 26th clock edge if all bits in the pattern match.

For more information on searching data, see [“Searching Lister Data”](#) on page 152.

For more information on using the [\[Navigate\]](#) key and controls, see [“Navigating the Time Base”](#) on page 75.

## Setup for SPI Signals

Serial Peripheral Interface (SPI) signals setup consists of connecting the oscilloscope to a clock, MOSI data, MISO data, and framing signal, then setting the threshold voltage level for each input channel, and finally specifying any other signal parameters.

To set up the oscilloscope to capture SPI signals, use the **Signals** softkey which appears in the Serial Decode Menu:

- 1 Press **[Serial]**.
- 2 Press the **Serial** softkey, turn the Entry knob to select the desired slot (Serial 1 or Serial 2), and press the softkey again to enable decode.
- 3 Press the **Mode** softkey; then, select **SPI** trigger type.

- 4 Press the **Signals** softkey to open the SPI Signals Menu.



- 5 Press the **Clock** softkey to open the SPI Clock Menu.



In the SPI Clock Menu:

- a Press the **Clock** softkey; then, turn the Entry knob to select the channel connected to the SPI serial clock line.

The CLK label for the source channel is automatically set.

- b Press the **Threshold** softkey; then, turn the Entry knob to select the clock signal threshold voltage level.

The threshold voltage level is used in decoding, and it will become the trigger level when the trigger type is set to the selected serial decode slot.

- c Press the slope softkey (↗ ↘) to select rising edge or falling edge for the selected Clock source.

This determines which clock edge the oscilloscope will use to latch the serial data. When **Display Info** is enabled, the graphic changes to show the current state of the clock signal.

- 6 Press the **MOSI** softkey to open the SPI Master-Out Slave-In Menu.



In the SPI Master-Out Slave-In Menu:

- a Press the **MOSI Data** softkey; then, turn the Entry knob to select the channel that is connected to a SPI serial data line. (If the channel you selected is off, switch it on.)

The MOSI label for the source channel is automatically set.

- b Press the **Threshold** softkey; then, turn the Entry knob to select the MOSI signal threshold voltage level.

The threshold voltage level is used in decoding, and it will become the trigger level when the trigger type is set to the selected serial decode slot.

- 7 (Optional) Press the **MISO** softkey to open the SPI Master-In Slave-Out Menu.



In the SPI Master-In Slave-Out Menu:

- a Press the **MISO Data** softkey; then, turn the Entry knob to select the channel that is connected to a second SPI serial data line. (If the channel you selected is off, switch it on.)

The MISO label for the source channel is automatically set.

- b Press the **Threshold** softkey; then, turn the Entry knob to select the MISO signal threshold voltage level.

The threshold voltage level is used in decoding, and it will become the trigger level when the trigger type is set to the selected serial decode slot.

- 8 Press the **CS** softkey to open the SPI Chip Select Menu.



In the SPI Chip Select Menu:

- a Press the **Frame by** softkey to select a framing signal that the oscilloscope will use for determining which clock edge is the first clock edge in the serial stream.

You can set the oscilloscope to trigger during a high chip select (**CS**), a low chip select (**~CS**), or after a **Timeout** period during which the clock signal has been idle.

- If the framing signal is set to **CS** (or **~CS**), the first clock edge as defined, rising or falling, seen after the **CS** (or **~CS**) signal transitions from low to high (or high to low) is the first clock in the serial stream.

**Chip Select** – Press the **CS** or **~CS** softkey; then, turn the Entry knob to select the channel that is connected to the SPI frame line. The label (**~CS** or **CS**) for the source channel is automatically set. The data pattern and the clock transition must occur during the time when the framing signal is valid. The framing signal must be valid for the entire data pattern.

- If the framing signal is set to **Timeout**, the oscilloscope generates its own internal framing signal after it sees inactivity on the serial clock line.



**Clock Timeout** – Select **Clock Timeout** in the **Frame by** softkey, then select the **Timeout** softkey and turn the Entry knob to set the minimum time that the Clock signal must be idle (not transitioning) before the oscilloscope will search for the Data pattern on which to trigger.

The Timeout value can be set anywhere from 100 ns to 10 s.

When you press the **Frame by** softkey, the **Display Info** graphic changes to show timeout selection or the current state of the chip select signal.

- b** Press the **Threshold** softkey; then, turn the Entry knob to select the chip select signal threshold voltage level.

The threshold voltage level is used in decoding, and it will become the trigger level when the trigger type is set to the selected serial decode slot.

When **Display Info** is enabled, information about the selected signal sources and their threshold voltage levels, as well as a waveform diagram, appears on the screen.

## SPI Triggering

To set up the oscilloscope to capture SPI signals, see **“Setup for SPI Signals”** on page 445.

After the oscilloscope has been set up to capture SPI signals, you can then trigger on a data pattern that occurs at the start of a frame. The serial data string can be specified to be from 4 to 32 bits long.

When you select the SPI trigger type and **Display Info** is enabled, a graphic is displayed showing the current state of the frame signal, clock slope, number of data bits, and data bit values.

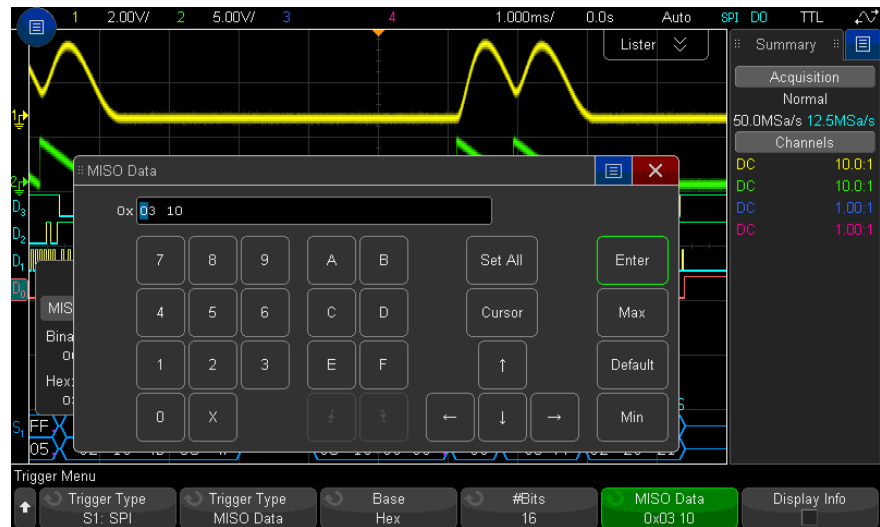
- 1** Press **[Trigger]**.
- 2** In the Trigger Menu, press the **Trigger Type** softkey; then, turn the Entry knob to select the serial slot (Serial 1 or Serial 2) on which the SPI signals are being decoded.



- 3 Press the second **Trigger Type** softkey; then, turn the Entry knob to select the trigger condition:
  - **Master-Out, Slave-In (MOSI) Data** – for triggering on the MOSI data signal.
  - **Master-In, Slave-Out (MISO) Data** – for triggering on the MISO data signal.
- 4 Press the **#Bits** softkey, and turn the Entry knob to set the number of bits (**#Bits**) in the serial data string.

The number of bits in the string can be set anywhere from 4 bits to 64 bits. The data values for the serial string are displayed in the MOSI/MISO Data string in the waveform area.

- 5 Press the **MOSI Data** or **MISO Data** softkey and use the binary keypad dialog to enter bit values of **0** (low), **1** (high), or **X** (don't care).



The data value is left-justified in the frame when setting up the trigger. If the base is Hex, the first digit represents the first 4 bits after the start of frame, continuing with the remaining digits in the data value.

## NOTE

For SPI decode information see **"SPI Serial Decode"** on page 451.

## SPI Serial Decode

To set up the oscilloscope to capture SPI signals, see [“Setup for SPI Signals”](#) on page 445.

### NOTE

For SPI triggering setup see [“SPI Triggering”](#) on page 449.

To set up SPI serial decode:

- 1 Press **[Serial]** to display the Serial Decode Menu.



- 2 Press the **Word Size** softkey; then, turn the Entry knob to select the number of bits in a word.
- 3 Press the **Bit Order** softkey; then turn the Entry knob to select the bit order, most significant bit first (MSB) or least significant bit first (LSB), used when displaying data in the serial decode waveform and in the Lister.
- 4 If the decode line does not appear on the display, press the **[Serial]** key to turn it on.
- 5 If the oscilloscope is stopped, press the **[Run/Stop]** key to acquire and decode data.

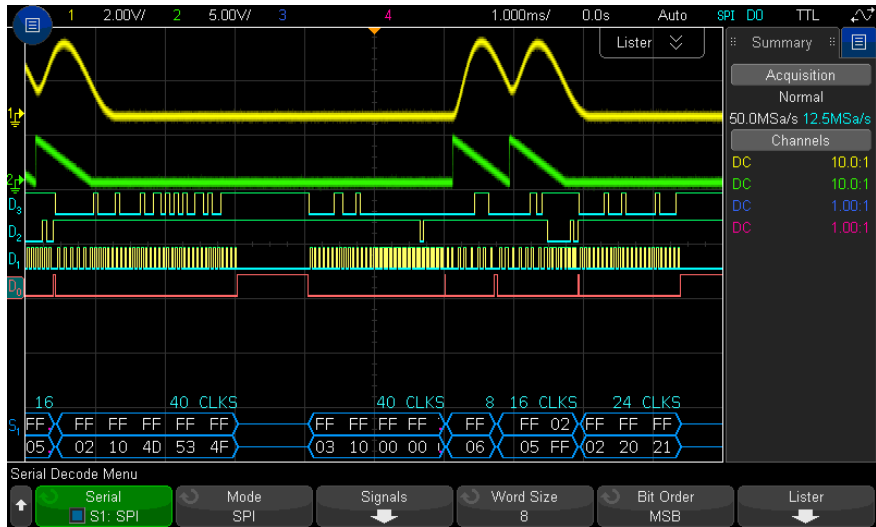
### NOTE

If the setup does not produce a stable trigger, the SPI signal may be slow enough that the oscilloscope is AutoTriggering. Press the **[Mode/Coupling]** key, then press the **Mode** softkey to set the trigger mode from **Auto** to **Normal**.

You can use the horizontal **Zoom** window for easier navigation of the acquired data.

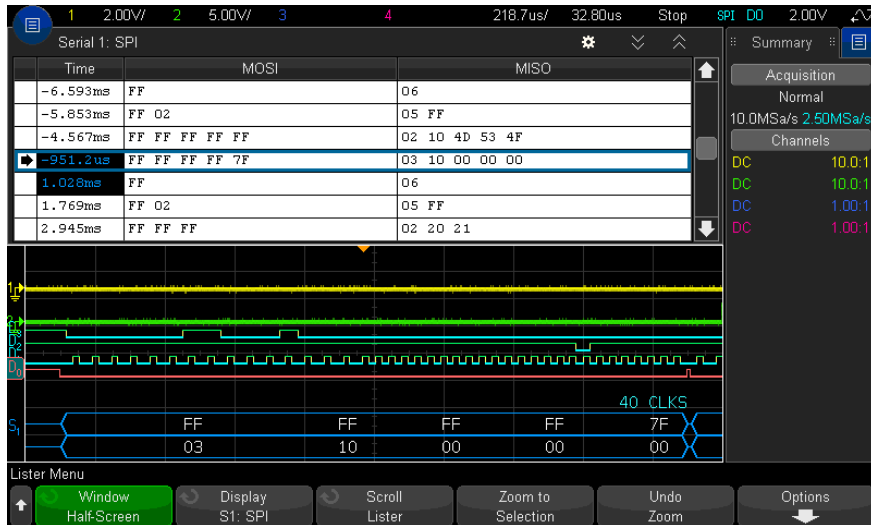
- See Also
- [“Interpreting SPI Decode”](#) on page 452
  - [“Interpreting SPI Lister Data”](#) on page 453
  - [“Searching for SPI Data in the Lister”](#) on page 453

## Interpreting SPI Decode



- Angled waveforms show an active bus (inside a packet/frame).
- Mid-level blue lines show an idle bus.
- The number of clocks in a frame appears in light-blue above the frame, to the right.
- Decoded hexadecimal data values appear in white.
- Decoded text is truncated at the end of the associated frame when there is insufficient space within frame boundaries.
- Pink vertical bars indicate you need to expand the horizontal scale (and run again) to see decode.
- Red dots in the decode line indicate that there is data that is not being displayed. Scroll or expand the horizontal scale to view the information.
- Aliased bus values (undersampled or indeterminate) are drawn in pink.
- Unknown bus values (undefined or error conditions) are drawn in red.

## Interpreting SPI Lister Data



In addition to the standard Time column, the SPI Lister contains these columns:

- Data – data bytes (MOSI and MISO).

Aliased data is highlighted in pink. When this happens, decrease the horizontal time/div setting and run again.

## Searching for SPI Data in the Lister

The oscilloscope's search capability lets you search for (and mark) certain types of SPI data in the Lister. You can use the **[Navigate]** key and controls to navigate through the marked rows.

- 1 With SPI selected as the serial decode mode, press **[Search]**.
- 2 In the Search Menu, press the **Search** softkey; then, turn the Entry knob to select the serial slot (Serial 1 or Serial 2) on which the SPI signals are being decoded.
- 3 Press **Search for;** then, select from these options:
  - **Master-Out, Slave-In (MOSI) Data** – for searching MOSI data.
  - **Master-In, Slave-Out (MISO) Data** – for searching MISO data.

- 4 In the SPI Bits Search Menu, use the **Words** softkey to specify the number of words in the data value; then, use the remaining softkeys to enter the hex digit values.
- 5 Press the **Data** softkey and use the keypad dialog to enter the hexadecimal data value.

The search pattern is always left-justified in the packet. If you want to search for a value in the second or higher word, increase the **Words** count and enter don't cares ('X's) for the earlier words.

For more information on searching data, see ["Searching Lister Data"](#) on page 152.

For more information on using the [Navigate] key and controls, see ["Navigating the Time Base"](#) on page 75.

# 29 I2S Triggering and Serial Decode

Setup for I2S Signals / 455

I2S Triggering / 458

I2S Serial Decode / 461

I2S triggering and serial decode requires the AUDIO license that you get by purchasing the DSOX3AUDIO upgrade.

## NOTE

Only one I2S serial bus can be decoded at a time.

---

## Setup for I2S Signals

I<sup>2</sup>S (Inter-IC Sound or Integrated Interchip Sound) signals setup consists of connecting the oscilloscope to the serial clock, word select, and serial data lines and then specifying the input signal threshold voltage levels.

To set up the oscilloscope to capture I2S signals:

- 1 Press **[Serial]**.
- 2 Press the **Serial** softkey, turn the Entry knob to select the desired slot (Serial 1 or Serial 2), and press the softkey again to enable decode.
- 3 Press the **Mode** softkey; then, select **I2S** trigger type.
- 4 Press the **Signals** softkey to open the I<sup>2</sup>S Signals Menu.




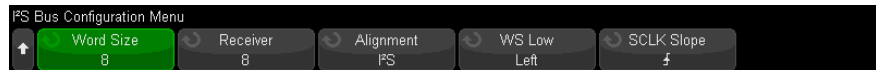
- 5 For the SCLK (serial clock), WS (word select), and SDATA (serial data) signals:
  - a Connect an oscilloscope channel to the signal in the device under test.
  - b Press the **SCLK**, **WS**, or **SDATA** softkey; then, turn the Entry knob to select the channel for the signal.
  - c Press the corresponding **Threshold** softkey; then, turn the Entry knob to select the signal threshold voltage level.

Set the threshold levels for the SCLK, WS, and SDATA signals to the middle of the signals.

The threshold voltage level is used in decoding, and it will become the trigger level when the trigger type is set to the selected serial decode slot.

The SCLK, WS, and SDATA labels for the source channels are automatically set.

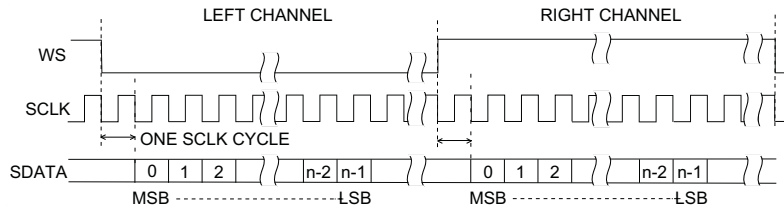
- 6 Press the  Back/Up key to return to the Serial Decode Menu.
- 7 Press the **Bus Config** softkey to open the I<sup>2</sup>S Bus Configuration Menu and display a diagram showing WS, SCLK, and SDATA signals for the currently specified bus configuration.



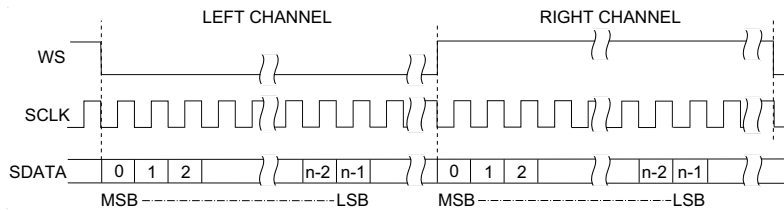
- 8 Press the **Word Size** softkey. Turn the Entry knob to match the transmitter word size of the device under test (from 4 to 32 bits).
- 9 Press the **Receiver** softkey. Turn the Entry knob to match the receiver word size of the device under test (from 4 to 32 bits).
- 10 Press the **Alignment** softkey; then, turn the Entry knob to select the desired alignment of the data signal (SDATA). The on-screen diagram changes with your selection.

**Standard Alignment** – MSB of data for each sample is sent first, LSB is sent last. The MSB appears on the SDATA line one bit clock after the edge of the WS transition.

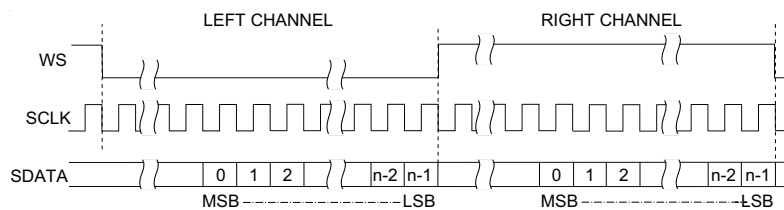




**Left-Justified** – Data transmission (MSB first) begins at the edge of the WS transition (without the one-bit delay that Standard format employs).

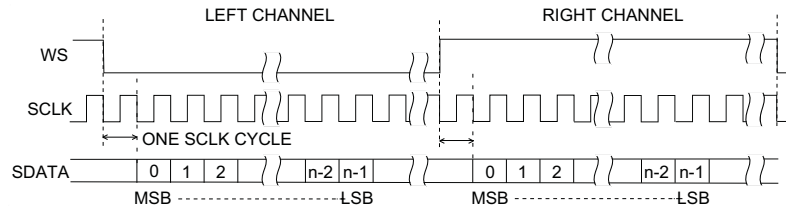


**Right-Justified** – Data transmission (MSB first) is right-justified to the transition of WS.

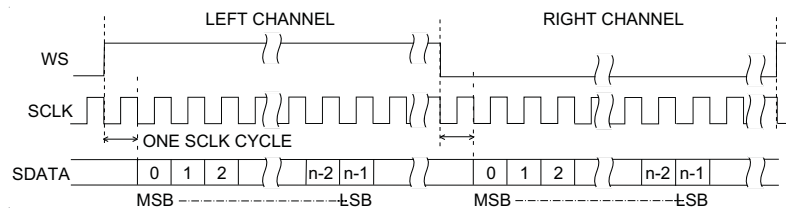


- 11** Press the **WS Low** softkey; then, turn the Entry knob to select whether WS Low indicates Left or Right channel data. The on-screen diagram changes with your selection.

**WS Low = Left Channel** – Left-channel data corresponds to WS=low; right-channel data corresponds to WS=high. WS Low=Left is the oscilloscope's default WS setting.



**WS Low = Right Channel** – Right-channel data corresponds to WS=low; left-channel data corresponds to WS=high.



- 12 Press the **SCLK Slope** softkey; then, turn the Entry knob to select the SCLK edge on which data is clocked in your device under test: either rising or falling. The on-screen diagram changes with your selection.

## I2S Triggering

To set up the oscilloscope to capture I<sup>2</sup>S signals, see **“Setup for I2S Signals”** on page 455.

After you have set up the oscilloscope to capture I<sup>2</sup>S signals, you can then trigger on a data value.

- 1 Press **[Trigger]**.
- 2 In the Trigger Menu, press the **Trigger** softkey; then, turn the Entry knob to select the serial slot (Serial 1 or Serial 2) on which the I2S signals are being decoded.



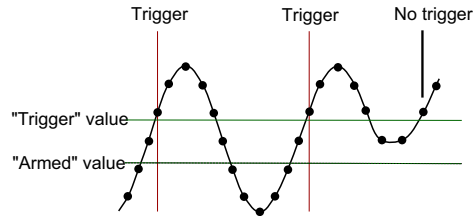
- 3 Press the **Trigger Setup** softkey to open the I<sup>2</sup>S Trigger Setup Menu.



- 4 Press the **Audio** softkey; then, turn the Entry knob to choose to trigger on **Left** channel events, **Right** channel events, or events that occur on **Either** channel.
- 5 Press the **Trigger** softkey and choose a qualifier:
  - **Equal** – triggers on the specified audio channel's data word when it equals the specified word.
  - **Not equal** – triggers on any word other than the specified word.
  - **Less than** – triggers when the channel's data word is less than the specified value.
  - **Greater than** – triggers when the channel's data word is greater than the specified value.
  - **In Range** – enter upper and lower values to specify the range in which to trigger.
  - **Out of Range** – enter upper and lower values to specify range in which trigger will not occur.
  - **Increasing value** – triggers when the data value is increasing over time and the specified value is met or exceeded. Set **Trigger >=** to the data value that must be reached. Set **Armed <=** to the value to which the data must fall before the trigger circuit is re-armed (ready to trigger again). These settings are made in the current menu when **Base** is **Decimal** or in the Bits submenu when the **Base** is **Binary**. The Armed control reduces triggers due to noise.

This trigger condition is best understood when the digital data transferred over the I2S bus is considered in terms of representing an analog waveform. The figure below shows a plot of sample data transmitted over an I2S bus for one channel. In this example, the oscilloscope will trigger at the 2 points shown since there are two instances in which the data increases from a value below (or at) the "Armed" value to a value greater than (or equal to) the specified "Trigger" value.

If you select an "Armed" value that is equal to or greater than the "Trigger" value, the "Trigger" value will be increased so that it is always greater than the "Armed" value.



- **Decreasing value** – similar to the description above except the trigger occurs on a decreasing data word value, and the "Armed" value is the value to which the data must rise in order to re-arm the trigger.
- 6 Press the **Base** softkey and select a number base for entering data values:

- **Binary (2's complement).**

When Binary is selected, the **Bits** softkey appears. This softkey opens the I2S Bits Menu for entering data values.

When the trigger qualifier requires a pair of values (as with In Range, Out of Range, Increasing value, or Decreasing value), the first softkey in the I2S Bits Menu lets you select which value of the pair.

In the I2S Bits Menu, press the **Bit** softkey and rotate the Entry knob to select each bit; then, use the **0 1 X** softkey to set each bit value to zero, one, or don't care. You can use the **Set all Bits** softkey to set all bits to the value chosen on the **0 1 X** softkey. Don't care values are only allowed with Equal or Not Equal trigger qualifiers.

- **Signed decimal.**

When Decimal is selected, the softkey(s) to the right let you enter decimal values with the Entry knob. These softkeys can be **Data**, **<**, **>**, or **Threshold** depending on the selected trigger qualifier.

## NOTE

If the setup does not produce a stable trigger, the I2S signal may be slow enough that the oscilloscope is AutoTriggering. Press the **[Mode/Coupling]** key, then press the **Mode** softkey to set the trigger mode from **Auto** to **Normal**.

**NOTE**

To display I2S serial decode, see [“I2S Serial Decode”](#) on page 461.

## I2S Serial Decode

To set up the oscilloscope to capture I2S signals, see [“Setup for I2S Signals”](#) on page 455.

**NOTE**

For I2S triggering setup see [“I2S Triggering”](#) on page 458.

To set up I2S serial decode:

- 1 Press **[Serial]** to display the Serial Decode Menu.



- 2 Press the **Base** softkey to select the number base in which to display decoded data.
- 3 If the decode line does not appear on the display, press the **[Serial]** key to turn it on.
- 4 If the oscilloscope is stopped, press the **[Run/Stop]** key to acquire and decode data.

**NOTE**

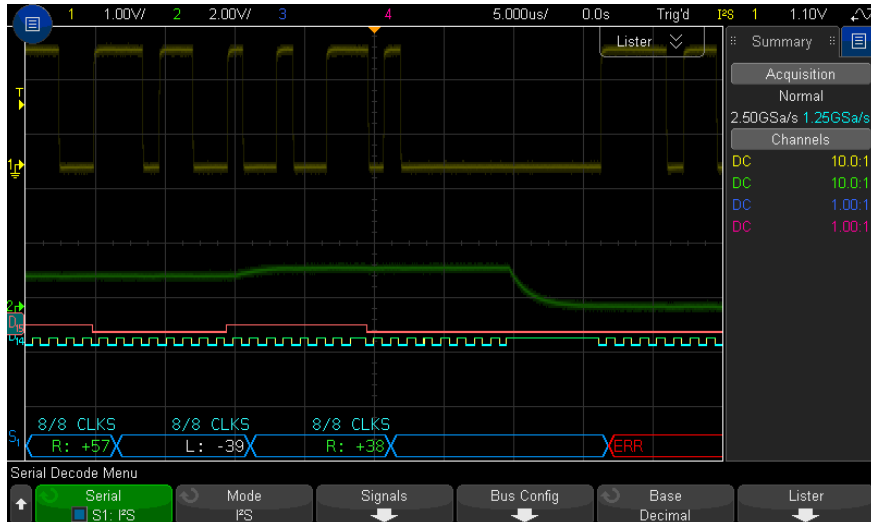
If the setup does not produce a stable trigger, the I2S signal may be slow enough that the oscilloscope is AutoTriggering. Press the **[Mode/Coupling]** key, then press the **Mode** softkey to set the trigger mode from **Auto** to **Normal**.

You can use the horizontal **Zoom** window for easier navigation of the acquired data.

- See Also
- [“Interpreting I2S Decode”](#) on page 462
  - [“Interpreting I2S Lister Data”](#) on page 463

- **“Searching for I2S Data in the Lister”** on page 463

## Interpreting I2S Decode

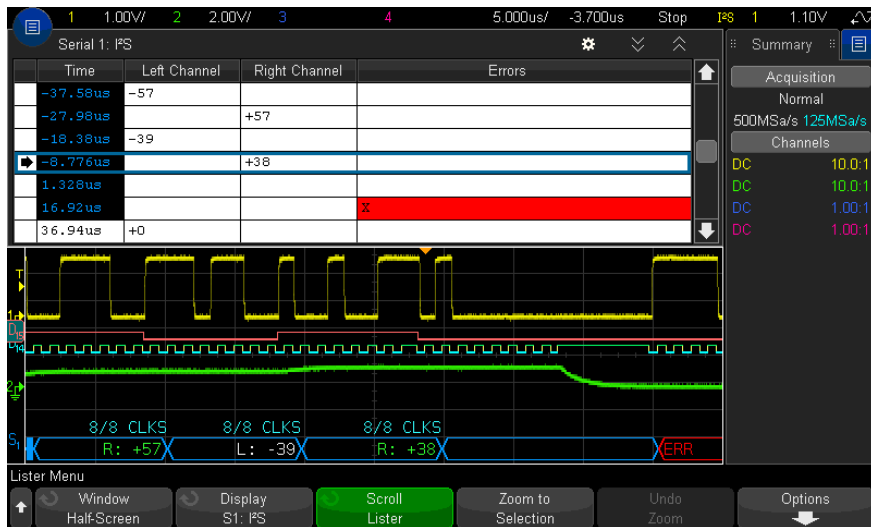


- Angled waveforms show an active bus (inside a packet/frame).
- Mid-level blue lines show an idle bus.
- In the decoded data:
  - Right channel data values appear in green along with the "R:" characters.
  - Left channel data values appear in white along with the "L:" characters.
  - Decoded text is truncated at the end of the associated frame when there is insufficient space within frame boundaries.
- Pink vertical bars indicate you need to expand the horizontal scale (and run again) to see decode.
- Red dots in the decode line indicate that more data can be displayed. Scroll or expand the horizontal scale to view the data.
- Aliased bus values (undersampled or indeterminate) are drawn in pink.
- Unknown bus values (undefined or error conditions) are drawn in red.

**NOTE**

When the receiver word size is greater than the transmit word size, the decoder fills the least significant bits with zeros and the decoded value does not match the trigger value.

## Interpreting I2S Lister Data



In addition to the standard Time column, the I2S Lister contains these columns:

- Left Channel – displays the left channel data.
- Right Channel – displays the right channel data.
- Errors – highlighted in red and marked with an "X".

Aliased data is highlighted in pink. When this happens, decrease the horizontal time/div setting and run again.

## Searching for I2S Data in the Lister

The oscilloscope's search capability lets you search for (and mark) certain types of I2S data in the Lister. You can use the **[Navigate]** key and controls to navigate through the marked rows.

- 1 With I2S selected as the serial decode mode, press **[Search]**.

- 2 In the Search Menu, press the **Search** softkey; then, turn the Entry knob to select the serial slot (Serial 1 or Serial 2) on which the I2S signals are being decoded.
- 3 In the Search Menu, press **Search**; then, select from these options:
  - **= (Equal)** – finds the specified audio channel's data word when it equals the specified word.
  - **!= (Not Equal)** – finds any word other than the specified word.
  - **< (Less than)** – finds when the channel's data word is less than the specified value.
  - **> (Greater than)** – finds when the channel's data word is greater than the specified value.
  - **>< (In Range)** – enter upper and lower values to specify the range to find.
  - **<> (Out of Range)** – enter upper and lower values to specify range not to find.
  - **Errors** – finds all errors.

For more information on searching data, see "[Searching Lister Data](#)" on page 152.

For more information on using the **[Navigate]** key and controls, see "[Navigating the Time Base](#)" on page 75.



# 30 Manchester/NRZ Triggering and Serial Decode

Setup for Manchester Signals / 465

Manchester Triggering / 468

Manchester Serial Decode / 470

Setup for NRZ Signals / 473

NRZ Triggering / 475

NRZ Serial Decode / 477

Manchester/NRZ triggering and serial decode requires the NRZ license that you can get by purchasing the DSOXT3NRZ upgrade.

The Manchester/NRZ triggering and decode solutions support generic Manchester- or NRZ-encoded serial buses.

## Setup for Manchester Signals

Manchester signal setup consists of first connecting the oscilloscope to a Manchester-encoded serial bus signal, then specifying the signal, bus configuration, and other settings.


To set up the oscilloscope to capture Manchester signals:

- 1 Press **[Serial]**.

- 2 Press the **Serial** softkey and choose the serial decode (Serial 1 or Serial 2) to use; then, press the softkey again to enable decode.
- 3 Press the **Mode** softkey; then, select the **Manchester** decode mode.
- 4 Press the **Signals** softkey to open the Manchester Signals Menu.



In the Manchester Signals Menu:

- a Press the **Source** softkey to select the channel connected to the Manchester signal line.  
The label for the Manchester source channel is automatically set.
  - b Press the **Threshold** softkey; then, enter the trigger threshold voltage level.  
The threshold voltage level is used in decoding and will become the trigger level when the trigger type is set to the Manchester serial decode.
  - c Press the **Baud** softkey; then, enter the baud rate of the Manchester signal from your device under test.  
The baud rate can be set from 2 kb/s to 5 Mb/s in 100 b/s increments.  
You must set the baud rate to match your device under test.  
The default baud rate is 125 kb/s.
  - d Press the **Tolerance** softkey to specify the tolerance for the Manchester signal. Valid values range from 5% to 30% in terms of percentage of the bit period.
  - e Press the  Back/Up key to return to the Serial Decode Menu.
- 5 Press the **Bus Config** softkey to open the Manchester Bus Configuration Menu.



In the Manchester Bus Configuration Menu:

- a Press the **Display Format** softkey and select the display format:
  - **Word** – lets you break the frame into sync, header, data, and trailer fields.


In Word format, you can select between hexadecimal, unsigned decimal, and ASCII decode bases. The base setting is used for both the Lister and the decode line and applies to the data field only. The header and trailer fields are always displayed in hex.

- **Bit** – displays the entire content of the frame as a string of bits.

In Bit format, the entire frame is always displayed in binary.

- 6 If the **Word** display format is selected:
  - a Press the **Sync Size** softkey and enter the sync field size, from 0 to 255 bits.
  - b Press the **Header Size** softkey and enter the header size, from 0 to 32 bits.
  - c Press the **# of Words** softkey and enter the number of words in the data field, from 1 to 255.

When the **Trailer Size** is set to 0, the <auto> option becomes available. In <auto> mode, any number of words can be supported.

- d Press the **Data Word Size** softkey and enter the data word size, from 2 to 32 bits.
  - e Press the **Trailer Size** softkey and enter the trailer size, from 0 to 32 bits.
- 7 If the **Bits** display format is selected:
  - a Press the **Sync Size** softkey and enter the sync field size, from 0 to 255 bits.
- 8 Press the  Back/Up key to return to the Serial Decode Menu.
- 9 Press the **Settings** softkey to open the Manchester Settings Menu.



In the Manchester Settings Menu:

- a Press the **Start Edge #** softkey and enter the starting edge of the Manchester signal, from 1 to 256.
- b Press the **Polarity** softkey and select the Manchester signal's logic type:
  - Rising – specifies that a rising edge is used to encode a bit value of logic 1 (and a falling edge encodes a bit value of logic 0).

- Falling – specifies that a falling edge is used to encode a bit value of logic 1 (and a rising edge encodes a bit value of logic 0).

- c** Press the **Bit Order** softkey and select the bit order, either most significant bit first (*MSB*) or least significant bit first (*LSB*).

The selected order is used when displaying data in the serial decode waveform and in the Lister.

This softkey is available when the **Word** display format is selected in the Manchester Bus Configuration Menu.


- d** Press the **Idle Bits** softkey and enter the minimum idle time/inter-frame gap time of the Manchester bus in terms of the bit width.

Framing is determined by idle time.

- e** Use the **Decode Base** softkey to select between hexadecimal, unsigned decimal, or ASCII display of the decoded data.

The decode base setting is used for the display of the data field in both the decode line and in the Lister.

When the **Bit** display format is selected in the Manchester Bus Configuration Menu, this softkey is unavailable and the decode base is forced to Binary.

- f** Press the  Back/Up key to return to the Serial Decode Menu.

## Manchester Triggering

To set up the oscilloscope to capture a Manchester signal, see **“Setup for Manchester Signals”** on page 465.

To set up a Manchester trigger:

- 1 Press **[Trigger]**.
- 2 In the Trigger Menu, press the **Trigger Type** softkey; then, select the Manchester decode (Serial 1 or Serial 2).



- 3 Press the **Trigger** softkey; then, select the trigger condition:

- **SOF - Start of Frame** – triggers after the starting edge, between the starting edge and the sync field.
- **Value** – triggers on a value you specify, up to 128 bits, after the sync field (starting with header bits).

Note that the trigger value is always for bits as they arrive (that is, MSB first).

When the decode bit order (specified in the serial decode settings menu) is MSB first, the decoded value bit order matches the trigger value bit order.

When the serial decode bit order is LSB first, the decoded value bit order is opposite of the trigger value bit order.

When Value is selected:

- Press the **#Bits** softkey and set the number of bits in the serial data value, from 4 bits to 128 bits.

The serial data value is displayed in the Value string in the waveform area.

- Press the **Value** softkey and use the keypad dialog box to enter the data value.

Note that the trigger value is always for bits as they arrive (that is, MSB first).

When the decode bit order (specified in the serial decode settings menu) is MSB first, the decoded value bit order matches the trigger value bit order.

When the serial decode bit order is LSB first, the decoded value bit order is opposite of the trigger value bit order.

- **Manchester Error** – triggers if a Manchester encoding error is detected.

You can use the **Zoom** mode for easier navigation of the decoded data.

## NOTE

For Manchester decode information see **“Manchester Serial Decode”** on page 470.

## Manchester Serial Decode

To set up the oscilloscope to capture Manchester signals, see [“Setup for Manchester Signals”](#) on page 465.

### NOTE

For Manchester triggering setup see [“Manchester Triggering”](#) on page 468.

To set up Manchester serial decode:

- 1 Press **[Serial]** to display the Serial Decode Menu.



- 2 If the decode line does not appear on the display, press the **[Serial]** key to turn it on.
- 3 If the oscilloscope is stopped, press the **[Run/Stop]** key to acquire and decode data.

### NOTE

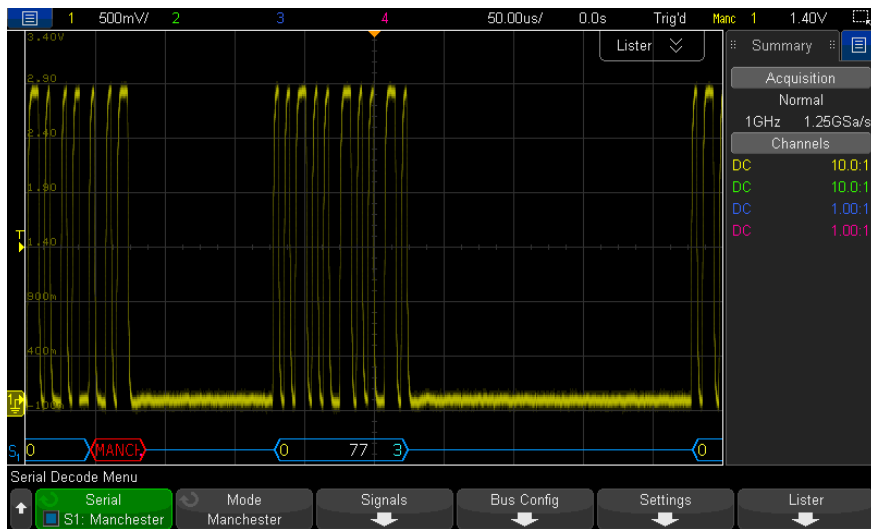
If the setup does not produce a stable trigger, the Manchester signal may be slow enough that the oscilloscope is AutoTriggering. Press the **[Mode/Coupling]** key, then press the **Mode** softkey to set the trigger mode from **Auto** to **Normal**.

You can use the horizontal **Zoom** window for easier navigation of the decoded data.

- See Also
- [“Interpreting Manchester Decode”](#) on page 470
  - [“Interpreting Manchester Lister Data”](#) on page 472

## Interpreting Manchester Decode

To display serial decode information, you must press **[Run]** or **[Single]** after switching on serial decode.



The Manchester decode display is color coded as follows:

- In Word format:
  - Header (yellow)
  - Data (white)
  - Trailer (blue)
- In Bit format:
  - Value (white)

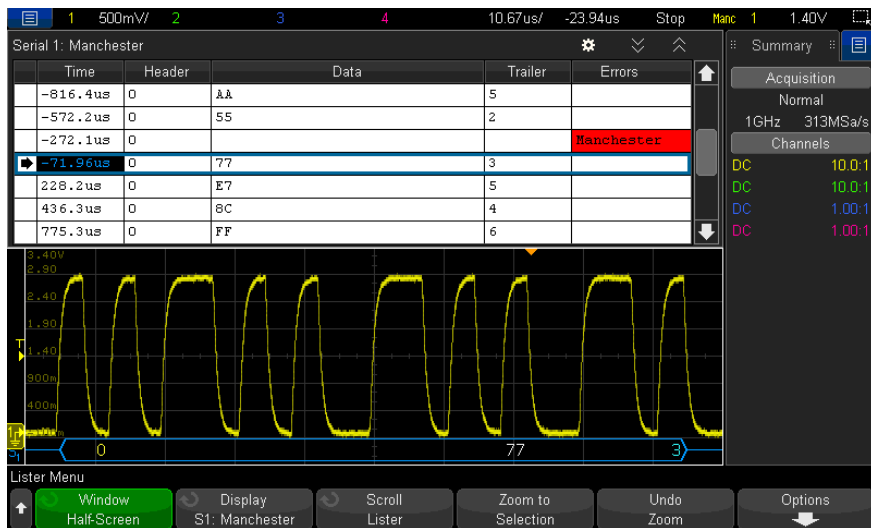
The decode display shows a blue idle line until the specified starting edge # is reached, at which point the start of frame angle bracket is drawn in blue.

In Word format, no value is associated with the sync field. The first value displayed on the decoded bus is associated with the header field if you select a header size > 0. Otherwise, the first value displayed is associated with the data field. The end of frame angle bracket is drawn in blue at the end of the trailer field, or data field if the trailer size is 0, followed by a blue idle line.

In Bit format, the frame is not divided into fields. All bits in the frame are displayed as soon as the starting edge occurs. Each bit is displayed on the decoded bus, time-aligned with the corresponding Manchester signal.

The only type of error that will be reported in the Manchester decode is Manchester Error. When this occurs, a red error frame is drawn with the text "MANCH" in red inside the error frame. Any previously valid frame before the error is terminated with a blue closing > angle bracket. Because all data is assumed invalid following a Manchester Error, the red error frame is drawn until a valid idle signal is detected. In the sync field, any bit value errors are ignored. Manchester errors are reported anywhere in the frame.

## Interpreting Manchester Lister Data



In addition to the standard Time column, the Manchester Lister contains these columns:

- In Word format:
  - Header (hex)
  - Data (hex, unsigned decimal, or ASCII)
  - Trailer (hex)
  - Errors
- In Bit format:
  - Value (binary)



- Errors

Aliased data is highlighted in pink. When this happens, decrease the horizontal time/div setting and run again.

## Setup for NRZ Signals


NRZ signal setup consists of first connecting the oscilloscope to a NRZ-encoded serial bus signal, then specifying the signal, bus configuration, and other settings.

To set up the oscilloscope to capture NRZ signals:

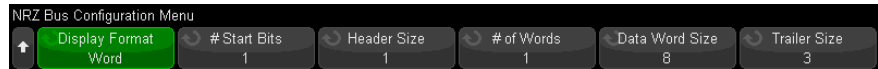
- 1 Press **[Serial]**.
- 2 Press the **Serial** softkey and choose the serial decode (Serial 1 or Serial 2) to use; then, press the softkey again to enable decode.
- 3 Press the **Mode** softkey; then, select the **NRZ** decode mode.
- 4 Press the **Signals** softkey to open the NRZ Signals Menu.




In the NRZ Signals Menu:

- a Press the **Source** softkey to select the channel connected to the NRZ signal line.  
The label for the NRZ source channel is automatically set.
- b Press the **Threshold** softkey; then, enter the trigger threshold voltage level.  
The threshold voltage level is used in decoding and will become the trigger level when the trigger type is set to the NRZ serial decode.
- c Press the **Baud** softkey; then, enter the baud rate of the NRZ signal from your device under test.  
The baud rate can be set from 5 kb/s to 5 Mb/s in 100 b/s increments.  
You must set the baud rate to match your device under test.  
The default baud rate is 125 kb/s.
- d Press the  Back/Up key to return to the Serial Decode Menu.

- 5 Press the **Bus Config** softkey to open the NRZ Bus Configuration Menu.




In the NRZ Bus Configuration Menu:

- a Press the **Display Format** softkey and select the display format:
- **Word** – lets you break the frame into header, data, and trailer fields.  
In Word format, you can select between hexadecimal, unsigned decimal, and ASCII decode bases. The base setting is used for both the Lister and the decode line and applies to the data field only. The header and trailer fields are always displayed in hex.
  - **Bit** – displays the entire content of the frame as a string of bits.  
In Bit format, the entire frame is always displayed in binary.
- 6 If the **Word** display format is selected:
- a Press the **# Start Bits** softkey and enter the number of starting bits, from 0 to 255 bits.
  - b Press the **Header Size** softkey and enter the header size, from 0 to 32 bits.
  - c Press the **# of Words** softkey and enter the number of words in the data field, from 1 to 255.
  - d Press the **Data Word Size** softkey and enter the data word size, from 2 to 32 bits.
  - e Press the **Trailer Size** softkey and enter the trailer size, from 0 to 32 bits.
- 7 If the **Bits** display format is selected:
- a Press the **# Start Bits** softkey and enter the number of starting bits, from 0 to 255 bits.
  - b Press the **Frame Size** softkey and enter the total frame size of the NRZ signal, from 2 to 255 bits.  
This would be equivalent to the sum of the number of bits in the header, data, and trailer fields in Word display format.
- 8 Press the  Back/Up key to return to the Serial Decode Menu.
- 9 Press the **Settings** softkey to open the NRZ Settings Menu.



In the NRZ Settings Menu:

- a Press the **Polarity** softkey and select the NRZ signal's logic type:
  - High – specifies that a positive voltage is used to encode a bit value of logic 1 (and a negative voltage encodes a bit value of logic 0).
  - Low – specifies that a negative voltage is used to encode a bit value of logic 1 (and a positive voltage encodes a bit value of logic 0).
- b Press the **Bit Order** softkey and select the bit order, either most significant bit first (*MSB*) or least significant bit first (*LSB*).  
 The selected order is used when displaying data in the serial decode waveform and in the Lister.
- c Press the **Idle State** softkey and choose the idle state of the NRZ bus, either Low or High.
- d Press the **Idle Bits** softkey and enter the minimum idle time/inter-frame gap time of the NRZ bus in terms of the bit width.  
 Framing is determined by idle time.
- e Use the **Decode Base** softkey to select between hexadecimal, unsigned decimal, or ASCII display of the decoded data.  
 The decode base setting is used for the display of the data field in both the decode line and in the Lister.
- f Press the  Back/Up key to return to the Serial Decode Menu.

## NRZ Triggering

To set up the oscilloscope to capture a NRZ signal, see **“Setup for NRZ Signals”** on page 473.

To set up a NRZ signal:

- 1 Press **[Trigger]**.
- 2 In the Trigger Menu, press the **Trigger Type** softkey; then, select the NRZ decode (Serial 1 or Serial 2).



**3** Press the **Trigger** softkey; then, select the trigger condition:

- **SOF - Start of Frame** – triggers after the starting edge, at the start of a NRZ frame.
- **Value** – triggers on a value you specify, up to 128 bits, after the specified number of starting bits.

Note that the trigger value is always for bits as they arrive (that is, MSB first).

When the decode bit order (specified in the serial decode settings menu) is MSB first, the decoded value bit order matches the trigger value bit order.

When the serial decode bit order is LSB first, the decoded value bit order is opposite of the trigger value bit order.

When Value is selected:

- i Press the **#Bits** softkey and set the number of bits in the serial data value, from 4 bits to 128 bits.

The serial data value is displayed in the Value string in the waveform area.

- ii Press the **Value** softkey and use the keypad dialog box to enter the data value.

Note that the trigger value is always for bits as they arrive (that is, MSB first).

When the decode bit order (specified in the serial decode settings menu) is MSB first, the decoded value bit order matches the trigger value bit order.

When the serial decode bit order is LSB first, the decoded value bit order is opposite of the trigger value bit order.

You can use the **Zoom** mode for easier navigation of the decoded data.

**NOTE**

To display NRZ serial decode, see **“NRZ Serial Decode”** on page 477.

## NRZ Serial Decode

To set up the oscilloscope to capture NRZ signals, see [“Setup for NRZ Signals”](#) on page 473.

### NOTE

For NRZ triggering set up see [“NRZ Triggering”](#) on page 475.

To set up NRZ serial decode:

- 1 Press **[Serial]** to display the Serial Decode Menu.



- 2 If the decode line does not appear on the display, press the **[Serial]** key to turn it on.
- 3 If the oscilloscope is stopped, press the **[Run/Stop]** key to acquire and decode data.

### NOTE

If the setup does not produce a stable trigger, the NRZ signal may be slow enough that the oscilloscope is AutoTriggering. Press the **[Mode/Coupling]** key, then press the **Mode** softkey to set the trigger mode from **Auto** to **Normal**.

You can use the horizontal **Zoom** window for easier navigation of the decoded data.

- See Also
- [“Interpreting NRZ Decode”](#) on page 478
  - [“Interpreting NRZ Lister Data”](#) on page 479

## Interpreting NRZ Decode



The NRZ decode display is color coded as follows:

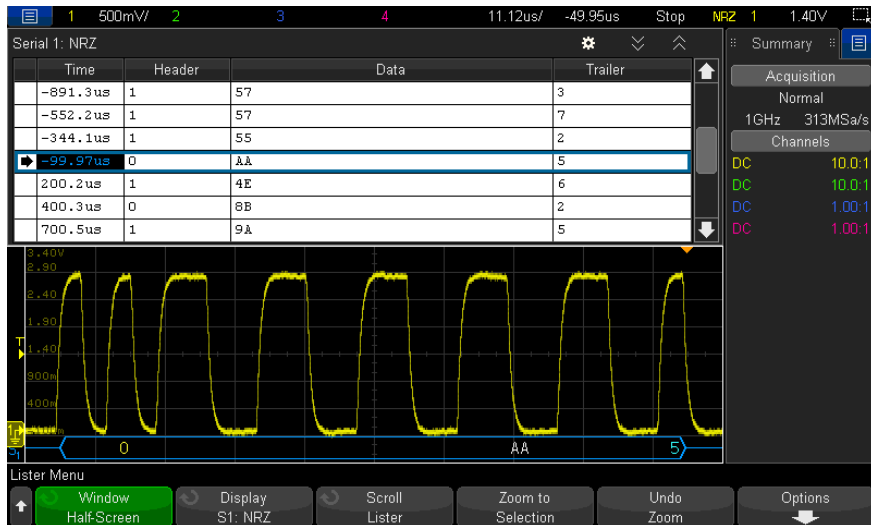
- Word format
  - Header (yellow)
  - Data (white)
  - Trailer (blue)
- Bit format
  - Value (white)

The decode display shows a blue idle line until the start of frame, at which point, the start of frame angle bracket is drawn in blue.

In Word format, the first value displayed on the decoded bus is associated with the header field if you select a header size > 0. Otherwise, the first value displayed is associated with the data field. The end of frame angle bracket is drawn in blue at the end of the trailer field, or data field if the trailer size is 0, followed by a blue idle line.

In Bit format, the frame is not divided into fields. All bits in the frame are displayed as soon as the start of frame occurs. Each bit is displayed on the decoded bus, time-aligned with the corresponding NRZ signal.

## Interpreting NRZ Lister Data



In addition to the standard Time column, the NRZ Lister contains these columns:

- In Word format:
  - Header (hex)
  - Data (hex, unsigned decimal, or ASCII)
  - Trailer (hex)
- In Bit format:
  - Value (binary)

Aliased data is highlighted in pink. When this happens, decrease the horizontal time/div setting and run again.





# 31 MIL-STD-1553/ARINC 429 Triggering and Serial Decode

Setup for MIL-STD-1553 Signals / 481

MIL-STD-1553 Triggering / 483

MIL-STD-1553 Serial Decode / 484

Setup for ARINC 429 Signals / 488

ARINC 429 Triggering / 489

ARINC 429 Serial Decode / 491

MIL-STD-1553/ARINC 429 triggering and serial decode requires the AERO license that you can get by purchasing the DSOX3AERO upgrade.

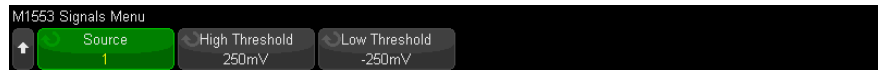
The MIL-STD-1553 triggering and decode solution supports bi-phase MIL-STD-1553 signaling by using dual threshold triggering. The solution supports the standard 1553 Manchester II encoding, data rate of 1 Mb/s, and word length of 20 bits.

## Setup for MIL-STD-1553 Signals

MIL-STD-1553 signal setup consists of first connecting the oscilloscope to a serial MIL-STD-1553 signal using a differential active probe (the Keysight N2791A is recommended), specifying the signal source, and specifying the high and low trigger threshold voltage levels.


To set up the oscilloscope to capture MIL-STD-1553 signals:

- 1 Press **[Serial]**.
- 2 Press the **Serial** softkey, turn the Entry knob to select the desired slot (Serial 1 or Serial 2), and press the softkey again to enable decode.
- 3 Press the **Mode** softkey; then, select **MIL-STD-1553** decode mode.
- 4 Press the **Signals** softkey to open the MIL-STD-1553 Signals Menu.



- 5 Press the **Source** softkey to select the channel connected to the MIL-STD-1553 signal line.

The label for the MIL-STD-1553 source channel is automatically set.

- 6 Press the  Back/Up key to return to the Serial Decode Menu.
- 7 Press the **Auto Setup** softkey which performs these actions:
  - Sets the probe attenuation factor of the input Source channel to 10:1.
  - Sets upper and lower thresholds to a voltage value equal to  $\pm 1/3$  division based on the current V/div setting.
  - Turns off trigger noise reject.
  - Turns on Serial Decode.
  - Sets the trigger type to MIL-1553.
- 8 If the upper and lower thresholds are not set correctly by **Auto Setup**, press the **Signals** softkey to return to the MIL-STD-1553 Signals Menu. Then:
  - Press the **High Threshold** softkey; then, turn the Entry knob to set the high trigger threshold voltage level.
  - Press the **Low Threshold** softkey; then, turn the Entry knob to set the low trigger threshold voltage level.

The threshold voltage levels are used in decoding and will become the trigger levels when the trigger type is set to the selected serial decode slot.

## MIL-STD-1553 Triggering

To set up the oscilloscope to capture a MIL-STD-1553 signal, see **“Setup for MIL-STD-1553 Signals”** on page 481.

To set up a MIL-STD-1553 trigger:

- 1 Press **[Trigger]**.
- 2 In the Trigger Menu, press the **Trigger** softkey; then, turn the Entry knob to select the serial slot (Serial 1 or Serial 2) on which the MIL-STD-1553 signal is being decoded.



- 3 Press the **Trigger** softkey; then, turn the Entry knob to select the trigger condition:
  - **Data Word Start** – triggers on the start of a Data word (at the end of a valid Data Sync pulse).
  - **Data Word Stop** – triggers on the end of a Data word.
  - **Command/Status Word Start** – triggers on the start of Command/Status word (at the end of a valid C/S Sync pulse).
  - **Command/Status Word Stop** – triggers on the end of a Command/Status word.
  - **Remote Terminal Address** – triggers if the RTA of the Command/Status word matches the specified value.

When this option is selected, the **RTA** softkey becomes available and lets you select the hex Remote Terminal Address value to trigger on. If you select 0xXX (don't care), the oscilloscope will trigger on any RTA.

- **Remote Terminal Address + 11 Bits** – triggers if the RTA and the remaining 11 bits match the specified criteria.

When this option is selected, these softkeys become available:

- The **RTA** softkey lets you select the hex Remote Terminal Address value.
- The **Bit Time** softkey lets you select the bit time position.
- The **0 1 X** softkey lets you set the bit time position value as a 1, 0, or X (don't care).

- **Parity Error** – triggers if the (odd) parity bit is incorrect for the data in the word.
- **Sync Error** – triggers if an invalid Sync pulse is found.
- **Manchester Error** – triggers if a Manchester encoding error is detected.

**NOTE**

For MIL-STD-1553 decode information see [“MIL-STD-1553 Serial Decode”](#) on page 484.

## MIL-STD-1553 Serial Decode

To set up the oscilloscope to capture MIL-STD-1553 signals, see [“Setup for MIL-STD-1553 Signals”](#) on page 481.

**NOTE**

For MIL-STD-1553 triggering setup see [“MIL-STD-1553 Triggering”](#) on page 483.

To set up MIL-STD-1553 serial decode:

- 1 Press **[Serial]** to display the Serial Decode Menu.



- 2 Use the **Base** softkey to select between hexadecimal and binary display of the decoded data.

The base setting is used for the display of the remote terminal address and the data, in both the decode line and in the Lister.

- 3 If the decode line does not appear on the display, press the **[Serial]** key to turn it on.
- 4 If the oscilloscope is stopped, press the **[Run/Stop]** key to acquire and decode data.

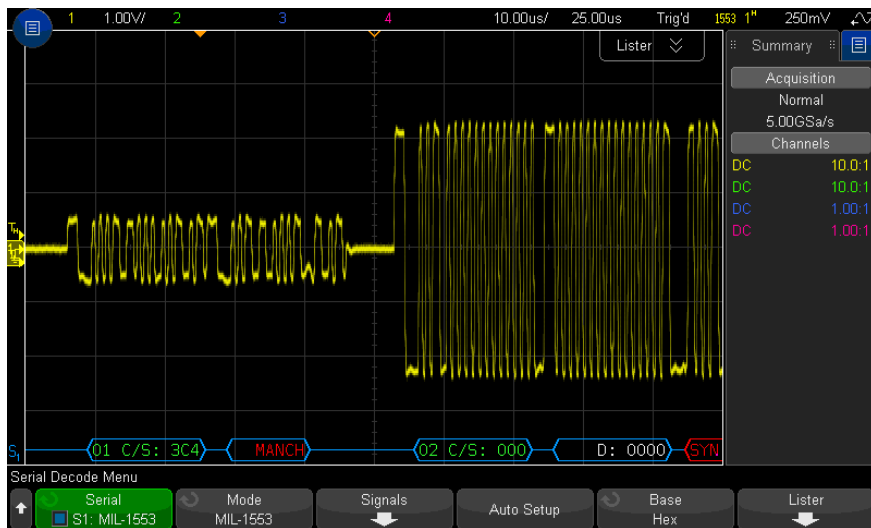
You can use the horizontal **Zoom** window for easier navigation of the decoded data.

**See Also** · [“Interpreting MIL-STD-1553 Decode”](#) on page 485

- "Interpreting MIL-STD-1553 Lister Data" on page 486
- "Searching for MIL-STD-1553 Data in the Lister" on page 487

## Interpreting MIL-STD-1553 Decode

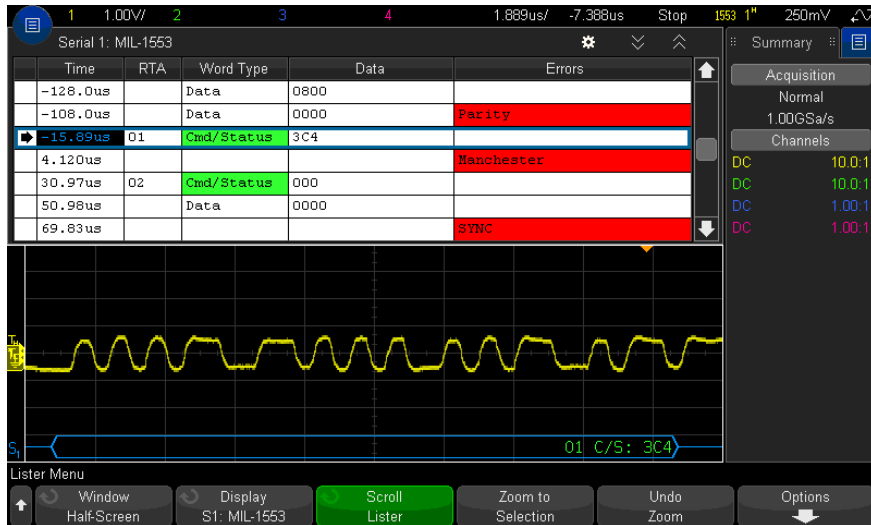
To display serial decode information, you must press **[Run]** or **[Single]** after switching on serial decode.



The MIL-STD-1553 decode display is color coded as follows:

- Command and Status decoded data is colored green, with the Remote Terminal Address (5 bits of data) being displayed first, then the text "C/S:", followed by the value of the remaining 11 bits of a Command/Status word.
- Data word decoded data is colored white, preceded by the text "D:".
- Command/Status or Data words with a Parity error have the decode text displayed in red instead of green or white.
- SYNC errors are displayed with the word "SYNC" within red angle brackets.
- Manchester encoding errors are displayed with the word "MANCH" within blue angle brackets (blue instead of red because a valid Sync pulse started the word).

## Interpreting MIL-STD-1553 Lister Data



In addition to the standard Time column, the MIL-STD-1553 Lister contains these columns:

- RTA – displays the Remote Terminal Address for Command/Status words, nothing for Data words.
- Word Type – "Cmd/Status" for Command/Status words, "Data" for Data words. For Command/Status words the background color is green to match the decode text color.
- Data – the 11 bits after the RTA for Command/Status words, or the 16 bits of a Data word.
- Errors – "Sync", "Parity", or "Manchester" errors as appropriate. The background color is red to indicate an error.

Aliased data is highlighted in pink. When this happens, decrease the horizontal time/div setting and run again.

## Searching for MIL-STD-1553 Data in the Lister

The oscilloscope's search capability lets you search for (and mark) certain types of MIL-STD-1553 data in the Lister. You can use the **[Navigate]** key and controls to navigate through the marked rows.

- 1 With MIL-STD-1553 selected as the serial decode mode, press **[Search]**.
- 2 In the Search Menu, press the **Search** softkey; then, turn the Entry knob to select the serial slot (Serial 1 or Serial 2) on which the MIL-STD-1553 signal is being decoded.
- 3 Press **Search**; then, select from these options:
  - **Data Word Start** – finds the start of a Data word (at the end of a valid Data Sync pulse).
  - **Command/Status Word Start** – finds the start of Command/Status word (at the end of a valid C/S Sync pulse).
  - **Remote Terminal Address** – finds the Command/Status word whose RTA matches the specified value. The value is specified in hex.

When this option is selected, the **RTA** softkey becomes available and lets you select the hex Remote Terminal Address value to find.

- **Remote Terminal Address + 11 Bits** – finds the RTA and the remaining 11 bits that match the specified criteria.
 

When this option is selected, these softkeys become available:

  - The **RTA** softkey lets you select the hex Remote Terminal Address value.
  - The **Bit Time** softkey lets you select the bit time position.
  - The **0 1 X** softkey lets you set the bit time position value as a 1, 0, or X (don't care).
- **Parity Error** – finds (odd) parity bits that are incorrect for the data in the word.
- **Sync Error** – finds invalid Sync pulses.
- **Manchester Error** – finds Manchester encoding errors.

For more information on searching data, see **"Searching Lister Data"** on page 152.

For more information on using the **[Navigate]** key and controls, see **"Navigating the Time Base"** on page 75.

## Setup for ARINC 429 Signals

Setup consists of first connecting the oscilloscope to a ARINC 429 signal using a differential active probe (the Keysight N2791A is recommended), then using the Signals Menu to specify the signal source, the high and low trigger threshold voltage levels, the signal speed, and the signal type.

To set up the oscilloscope to capture ARINC 429 signals:

- 1 Press **[Serial]**.
- 2 Press the **Serial** softkey, turn the Entry knob to select the desired slot (Serial 1 or Serial 2), and press the softkey again to enable decode.
- 3 Press the **Mode** softkey; then, select **ARINC 429** decode mode.
- 4 Press the **Signals** softkey to open the ARINC 429 Signals Menu.



- 5 Press **Source**; then, select the channel for the ARINC 429 signal.  
The label for the ARINC 429 source channel is automatically set.
- 6 Press the **Speed** softkey to open the ARINC 429 Speed Menu.



- 7 In the ARINC429 Speed Menu, press the **Speed** softkey and specify the speed of the ARINC 429 signal:
  - **High** – 100 kb/s.
  - **Low** – 12.5 kb/s.
  - **User Defined** – press the **User Baud** softkey and enter the user-defined speed value.
- 8 Press the **[Back]** Back/Up key to return to the ARINC 429 Signals Menu.
- 9 Press the **Signal Type** softkey and specify the signal type of the ARINC 429 signal:
  - **Line A (non-inverted)**.



- **Line B (inverted).**
- **Differential (A-B).**

**10** Press the **Auto Setup** softkey to automatically set these options for decoding and triggering on ARINC 429 signals:

- High Trigger Threshold: 3.0 V.
- Low Trigger Threshold: -3.0 V.
- Noise Reject: Off.
- Probe Attenuation: 10.0.
- Vertical Scale: 4 V/div.
- Serial Decode: On.
- Base: Hex.
- Word Format: Label/SDI/Data/SSM.
- Trigger: currently active serial bus.
- Trigger Mode: Word Start.

**11** If the high and low thresholds are not set correctly by **Auto Setup**:

- Press the **High Threshold** softkey; then, turn the Entry knob to set the high trigger threshold voltage level.
- Press the **Low Threshold** softkey; then, turn the Entry knob to set the low trigger threshold voltage level.

The threshold voltage levels are used in decoding and will become the trigger levels when the trigger type is set to the selected serial decode slot.

## ARINC 429 Triggering

To set up the oscilloscope to capture a ARINC 429 signal, see **“Setup for ARINC 429 Signals”** on page 488.

After setting up the oscilloscope to capture a ARINC 429 signal:

- 1** Press **[Trigger]**.
- 2** In the Trigger Menu, press the **Trigger** softkey; then, turn the Entry knob to select the serial slot (Serial 1 or Serial 2) on which the ARINC 429 signal is being decoded.



- 3 Press the **Trigger**: softkey; then, turn the Entry knob to select the trigger condition:
  - **Word Start** – triggers on the start of a word.
  - **Word Stop** – triggers at the end of a word.
  - **Label** – triggers on the specified label value.
  - **Label + Bits** – triggers on the label and the other word fields as specified.
  - **Label Range** – triggers on a label following in a min/max range.
  - **Parity Error** – triggers on words with a parity error.
  - **Word Error** – triggers on an intra-word coding error.
  - **Gap Error** – triggers on an inter-word gap error.
  - **Word or Gap Error** – triggers on either a Word or Gap Error.
  - **All Errors** – triggers on any of the above errors.
  - **All Bits (Eye)** – triggers on any bit, which will therefore form an eye diagram.
  - **All 0 Bits** – triggers on any bit with a value of zero.
  - **All 1 Bits** – triggers on any bit with a value of one.
- 4 If you select the **Label** or **Label + Bits** condition, use the **Label** softkey to specify the label value.  
  
Label values are always displayed in octal.
- 5 If you select the **Label + Bits** condition, use the **Bits** softkey and submenu to specify the bit values:



Press the **Data**, **SSM**, and/or **SSM** softkeys and use the binary keypad dialog to enter the 0, 1, or X (don't care) values.

The SDI or SSM selections may not be available, depending on word format selection in the Serial Decode Menu.

- 6 If you select the **Label Range** condition, use the **Label Min** and **Label Max** softkeys to specify the ends of the range.

Again, label values are always displayed in octal.

You can use the **Zoom** mode for easier navigation of the decoded data.

## NOTE

To display ARINC 429 serial decode, see **“ARINC 429 Serial Decode”** on page 491.

## ARINC 429 Serial Decode

To set up the oscilloscope to capture ARINC 429 signals, see **“Setup for ARINC 429 Signals”** on page 488.

## NOTE

For ARINC 429 triggering set up see **“ARINC 429 Triggering”** on page 489.

To set up ARINC 429 serial decode:

- 1 Press **[Serial]** to display the Serial Decode Menu.



- 2 In the submenu accessed by the **Settings** softkey, you can use the **Base** softkey to select between hexadecimal and binary display of the decoded data.

The base setting is used for *data* display in both the decode line and in the Lister.

Label values are always displayed in octal, and SSM and SDI values are always displayed in binary.

- 3 Press the **Word Format** softkey and specify the word decode format:
  - **Label/SDI/Data/SSM:**
    - Label - 8 bits.

- SDI - 2 bits.
  - Data - 19 bits.
  - SSM - 2 bits.
  - **Label/Data/SSM:**
    - Label - 8 bits.
    - Data - 21 bits.
    - SSM - 2 bits.
  - **Label/Data:**
    - Label - 8 bits.
    - Data - 23 bits.
- 4** If the decode line does not appear on the display, press the **[Serial]** key to turn it on.
- 5** If the oscilloscope is stopped, press the **[Run/Stop]** key to acquire and decode data.

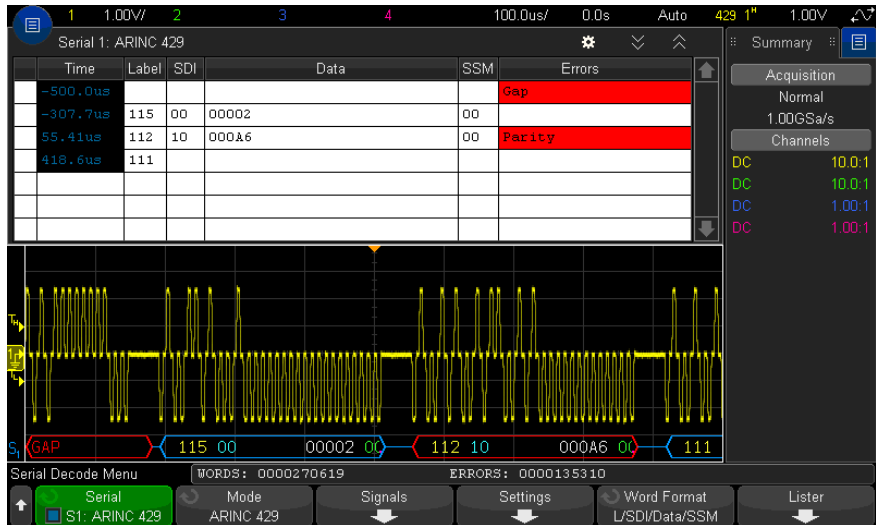
**NOTE**

If the setup does not produce a stable trigger, the ARINC 429 signal may be slow enough that the oscilloscope is AutoTriggering. Press the **[Mode/Coupling]** key, then press the **Mode** softkey to set the trigger mode from **Auto** to **Normal**.

You can use the horizontal **Zoom** window for easier navigation of the decoded data.

- See Also
- ["Interpreting ARINC 429 Decode"](#) on page 493
  - ["ARINC 429 Totalizer"](#) on page 494
  - ["Interpreting ARINC 429 Lister Data"](#) on page 495
  - ["Searching for ARINC 429 Data in the Lister"](#) on page 495

## Interpreting ARINC 429 Decode



Depending on the selected word decode format, the ARINC 429 decode display is color coded as follows:

- When the decode format is Label/SDI/Data/SSM:
  - Label (yellow) (8 bits) – displayed in octal.
  - SDI (blue) (2 bits) – displayed in binary.
  - Data (white, red if parity error) (19 bits) – displayed in the selected Base.
  - SSM (green) (2 bits) – displayed in binary.
- When the decode format is Label/Data/SSM:
  - Label (yellow) (8 bits) – displayed in octal.
  - Data (white, red if parity error) (21 bits) – displayed in the selected Base.
  - SSM (green) (2 bits) – displayed in binary.
- When the decode format is Label/Data:
  - Label (yellow) (8 bits) – displayed in octal.
  - Data (white, red if parity error) (23 bits) – displayed in the selected Base.

The Label bits are displayed in the same order as they are received on the wire. For the Data, SSM, and SDI bits, the fields are displayed in the order received; however, the bits within those fields are displayed in reverse order. In other words, the non-Label fields are displayed in the ARINC 429 Word Format, while the bits for those fields have the opposite transfer order on the wire.

## ARINC 429 Totalizer

The ARINC 429 totalizer measures the total ARINC 429 words and errors.



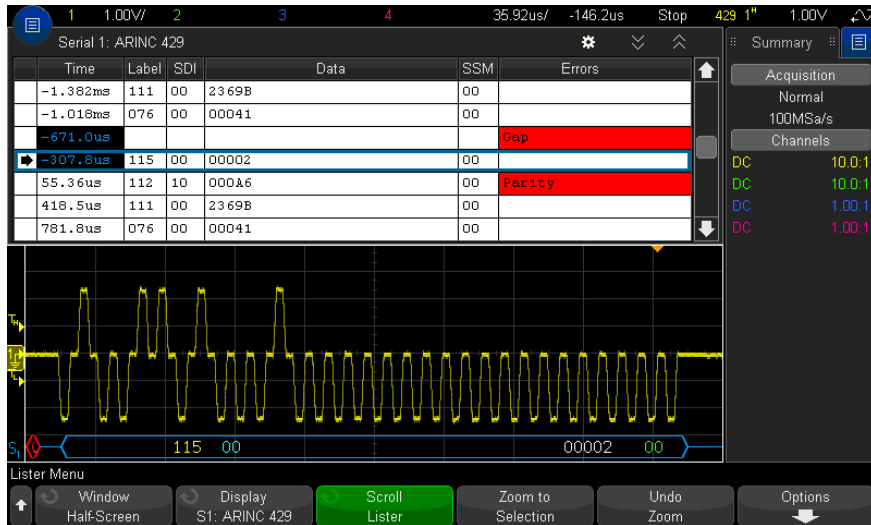
The totalizer is always running, counting words and errors, and is displayed whenever ARINC 429 decode is displayed. The totalizer counts even when the oscilloscope is stopped (not acquiring data).

Pressing the **[Run/Stop]** key does not affect the totalizer.

When an overflow condition occurs, the counter displays **OVERFLOW**.

The counters can be reset to zero by pressing the **Reset ARINC 429 Counters** softkey (in the decode **Settings** menu).

## Interpreting ARINC 429 Lister Data



In addition to the standard Time column, the ARINC 429 Lister contains these columns:

- Label – the 5-bit label value in octal format.
- SDI – the bit values (if included in the word decode format).
- Data – the data value in binary or hex, depending on the base setting.
- SSM – the bit values (if included in the word decode format).
- Errors – highlighted in red. Errors can be Parity, Word, or Gap.

Aliased data is highlighted in pink. When this happens, decrease the horizontal time/div setting and run again.

## Searching for ARINC 429 Data in the Lister

The oscilloscope's search capability lets you search for (and mark) certain types of ARINC 429 data in the Lister. You can use the **[Navigate]** key and controls to navigate through the marked rows.

- 1 With ARINC 429 selected as the serial decode mode, press **[Search]**.

- 2 In the Search Menu, press the **Search** softkey; then, turn the Entry knob to select the serial slot (Serial 1 or Serial 2) on which the ARINC 429 signal is being decoded.
- 3 Press **Search**; then, select from these options:
  - **Label** – finds the specified label value.  
Label values are always displayed in octal.
  - **Label + Bits** – finds the label and the other word fields as specified.
  - **Parity Error** – finds words with a parity error.
  - **Word Error** – finds an intra-word coding error.
  - **Gap Error** – finds an inter-word gap error.
  - **Word or Gap Error** – finds either a Word or Gap Error.
  - **All Errors** – finds any of the above errors.

For more information on searching data, see "[Searching Lister Data](#)" on page 152.

For more information on using the **[Navigate]** key and controls, see "[Navigating the Time Base](#)" on page 75.



# 32 SENT Triggering and Serial Decode

Setup for SENT Signals / 497

SENT Triggering / 502

SENT Serial Decode / 504


SENT (Single Edge Nibble Transmission) triggering and serial decode requires the DSOXT3SENSOR license.

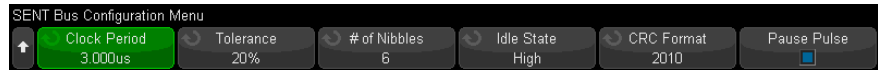
## Setup for SENT Signals

To set up the oscilloscope to capture SENT signals:

- 1 Connect an oscilloscope channel to the signal in the device under test.  
Analog channels or digital channels can be used.
- 2 Press **[Serial]**.
- 3 Press the **Serial** softkey, turn the Entry knob to select the desired slot (Serial 1 or Serial 2), and press the softkey again to enable decode.
- 4 Press the **Mode** softkey; then, select **SENT**.
- 5 Press the **Source** softkey to open the SENT Source Menu.



- a Press the **Source** softkey; then, turn the Entry knob to select the channel for the signal.
  - b Press the **Threshold** softkey; then, turn the Entry knob to select the signal threshold voltage level.  
  
The threshold voltage level is used in decoding, and it will become the trigger level when the trigger type is set to the selected serial decode (Serial 1 or Serial 2).
  - c Press the  Back/Up key to return to the SENT Serial Decode Menu.
- 6 Press the **Bus Config** softkey to open the SENT Bus Configuration Menu.




- a Press the **Clock Period** softkey; then, turn the Entry knob (or press the softkey again and use a keypad dialog) to specify the nominal clock period (tick) time.
- b Press the **Tolerance** softkey; then, turn the Entry knob (or press the softkey again and use a keypad dialog) to specify the percent tolerance for determining whether the sync pulse is valid for decoding the data.  
  
If the measured time of the sync pulse is within the percent tolerance of the nominal clock period setting, the decode proceeds; otherwise, the sync pulse is in error, and the data is not decoded.
- c Press the **# of Nibbles** softkey; then, turn the Entry knob (or press the softkey again and use a keypad dialog) to specify the number of nibbles in a Fast Channel Message.
- d Press the **Idle State** softkey to specify the idle state of the SENT signal.
- e Press the **CRC Format** softkey to specify the CRC format that will be used in calculating the correctness of the CRCs.

Enhanced Serial Message CRCs are always calculated using the 2010 format, but for the Fast Channel Messages, and for Short Serial Message CRCs, the chosen setting is used.

- f** Press the **Pause Pulse** softkey to specify whether there is a pause pulse between Fast Channel Messages.

A SENT serial bus with no pause pulse is never idle. This means, during normal operation, the fast channel decode line will show a continuous stream of packets, with a new packet opening as soon as the previous one has closed.

If there is a pause pulse (and **Pause Pulse** is on), idle time is shown between messages.

- g** Press the  Back/Up key to return to the SENT Serial Decode Menu.
- 7** Press the **Settings** softkey to open the SENT Settings Menu.



- a** Press the **Message Format** softkey to select the message decode/triggering format:
- **Fast Nibbles (All)** – displays the raw transmitted nibble values.
  - **Fast Signals** – displays Fast Channel Message Signals.
  - **Fast + Short Serial** – displays both Fast and Slow Messages (Short format) simultaneously.
  - **Fast + Enhanced Serial** – displays both Fast and Slow Messages (Enhanced format) simultaneously.
  - **Short Serial** – displays Slow Channel Messages in Short format.
  - **Enhanced Serial** – displays Slow Channel Messages in Enhanced format.

This selection affects both decoding and triggering. The decode is affected both in how the system interprets the data, and what will be displayed. The trigger is affected in that the trigger hardware needs to be configured to trigger on serial messages correctly.

You can specify the nibble display order for Fast Channel Message Signals (under the **Fast Signals** softkey). Raw transmitted nibble values are displayed in the order received.

**NOTE**

For the Slow Channel, the proper format, Short or Enhanced, must be chosen for proper decoding and triggering to occur.

---

Slow Channel Serial Messages are always displayed as defined by the SENT specification.

- b** Press the **Display** softkey to select between hexadecimal, unsigned decimal, or "transfer function" display of Fast Channel nibbles, signals, and CRC values, as well as Slow Channel IDs, data, and CRC values. (The S&C value is always displayed in binary.)

Your selection is used for both the Lister and the decode line displays.

When **Transfer Function** is selected (for message formats that include fast signals), Fast Channel Signals display a calculated physical value based on the specified **Multiplier** and **Offset** (under the **Fast Signals** softkey):

$$\text{PhysicalValue} = (\text{Multiplier} * \text{SignalValueAsUnsignedInteger}) + \text{Offset}$$

When **Transfer Function** is selected, the CRC and Slow Channel information is displayed in hex.

- 8** When a fast signals message decode/triggering is selected, press the **Fast Signals** softkey to open the SENT Signals Menu where you can define and specify the display of up to six Fast Signals.



- a Press the **Fast Signals** softkey and use the Entry knob to select the Fast Signal to be defined.

Once a Fast Signal is selected, press the softkey again to enable or disable decode for that signal.

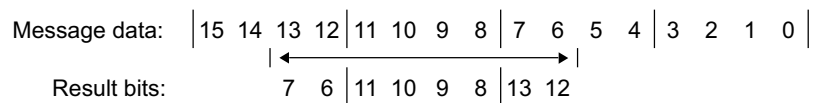
- b Press the **Start Bit # (MSB)** softkey to specify the starting bit for the selected signal.
- c Press the **# of Bits** softkey to specify the number of bits in the selected signal.
- d Press the **Nibble Order** softkey to specify the nibble display order as either most significant nibble (MSN) or least significant nibble (LSN) first.
- e When the display mode setting is **Transfer Function** (see the SENT Settings Menu), press the **Multiplier** or **Offset** softkeys; then, turn the Entry knob (or press the softkey again and use a keypad dialog) to specify the value.

The multiplier and offset values are used in calculating a physical value displayed for the Fast Signal:

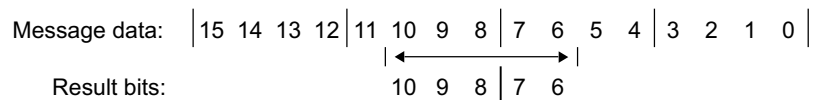
$$\text{Physical Value} = (\text{Multiplier} * \text{SignalValueAsUnsignedInteger}) + \text{Offset}$$

Here are some Fast Signal definition examples:

Example 1: Start Bit # = 13, # of bits = 8, Nibble Order = LSN First



Example 2: Start Bit # = 10, # of bits = 5, Nibble Order = MSN First




## SENT Triggering

To set up the oscilloscope to capture SENT signals, see **"Setup for SENT Signals"** on page 497.

To set up a SENT trigger condition:

- 1 Press **[Trigger]**.
- 2 In the Trigger Menu, press the **Trigger Type** softkey; then, turn the Entry knob to select the serial decode (Serial 1 or Serial 2) of the SENT signal.



- 3 Press the **Trigger on:** softkey and use the  Entry knob to select the SENT trigger condition:
  - **Start of Fast Channel Message** – triggers on the start of any Fast Channel Message (after 56 Synchronization/Calibration ticks).
  - **Start of Slow Channel Message** – trigger on the start of any Slow Channel Message.
  - **Fast Channel SC & Data** – triggers on a Fast Channel Message when the Status & Communication nibble and the data nibbles match the values entered using additional softkeys.
  - **Slow Channel Message ID** – triggers when a Slow Channel Message ID matches the value entered using additional softkeys.
  - **Slow Channel Message ID & Data** – triggers when a Slow Channel Message ID and Data field both match the values entered using additional softkeys.
  - **Tolerance Violation** – triggers when the sync pulse width varies from the nominal value by greater than the entered percentage.
  - **Fast Channel CRC Error** – triggers on any Fast Channel Message CRC error.
  - **Slow Channel CRC Error** – triggers on any Slow Channel Message CRC error.
  - **All CRC Errors** – triggers on any CRC error, Fast or Slow.
  - **Pulse Period Error** – triggers if a nibble is either too wide or too narrow (for example, data nibble < 12 (11.5) or > 27 (27.5) ticks wide). Sync, S&C, data, or checksum pulse periods are checked.

- **Successive Sync Pulses Error** – triggers on a sync pulse whose width varies from the previous sync pulse's width by greater than 1/64 (1.5625%, as defined in the SENT specification).
- 4 If you choose the **Fast Channel SC & Data** trigger condition:
    - a Press the **Base** softkey to choose between Hex or Binary data value entry.
 

Use the Binary method if you need to enter "don't care" bits (X) within a nibble. If all bits in a nibble are "don't care", the hex nibble is displayed as "don't care" (X). When all bits in a nibble are 1s or 0s, the hex value is shown. Hex nibbles that contain a mix of 0/1 bits and "don't care" bits are displayed as "\$".
    - b Press the **SC & Data** softkey and use the keypad dialog to enter the data value.
 

The S&C nibble is the left most nibble entered in the string of numbers, followed by the data nibbles.
  - 5 If you choose the **Slow Channel Message ID** or **Slow Channel Message ID & Data** trigger condition:
    - a Press the **Configuration** softkey to select the desired packet ID for the selected packet type.
 

When an Enhanced Serial message format is specified (see **“Setup for SENT Signals”** on page 497), press this softkey to select which enhanced format configuration is being used:

      - 16-Bit Data, 4-Bit ID
      - 12-Bit Data, 8-Bit ID
    - b Press the **Slow Message ID** softkey and use the Entry knob (or press the softkey again and use a keypad dialog) to specify the Slow Message ID.
    - c If you choose the **Slow Channel Message ID & Data** trigger condition, press the **Slow Data** softkey and use the Entry knob (or press the softkey again and use a keypad dialog) to specify the Slow Message data.
  - 6 If you choose the **Tolerance Violation** trigger condition, press the **Tolerance** softkey and use the Entry knob (or press the softkey again and use a keypad dialog) to specify the tolerance variation that is considered a violation.
 

The percentage entered must be less than the percent tolerance specified in the decode bus configuration settings.

**NOTE**

If the setup does not produce a stable trigger, the SENT signals may be slow enough that the oscilloscope is AutoTriggering. Press the **[Mode/Coupling]** key, then press the **Mode** softkey to set the trigger mode from **Auto** to **Normal**.

**NOTE**

To display SENT serial decode, see **“SENT Serial Decode”** on page 504.

## SENT Serial Decode

To set up the oscilloscope to capture SENT signals, see **“Setup for SENT Signals”** on page 497.

**NOTE**

For SENT triggering setup see **“SENT Triggering”** on page 502.

To set up SENT serial decode:

- 1 Press **[Serial]** to display the Serial Decode Menu.



- 2 If the decode line does not appear on the display, press the **[Serial]** key to turn it on.
- 3 If the oscilloscope is stopped, press the **[Run/Stop]** key to acquire and decode data.

**NOTE**

If the setup does not produce a stable trigger, the SENT signals may be slow enough that the oscilloscope is AutoTriggering. Press the **[Mode/Coupling]** key, then press the **Mode** softkey to set the trigger mode from **Auto** to **Normal**.

You can use the horizontal **Zoom** window for easier navigation of the acquired data.

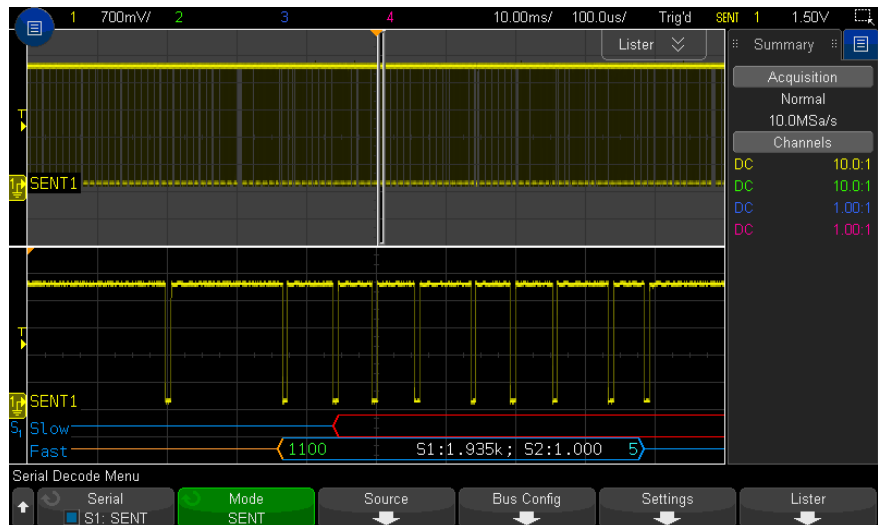


- See Also
- ["Interpreting SENT Decode"](#) on page 505
  - ["Interpreting SENT Lister Data"](#) on page 507
  - ["Searching for SENT Data in the Lister"](#) on page 508

## Interpreting SENT Decode

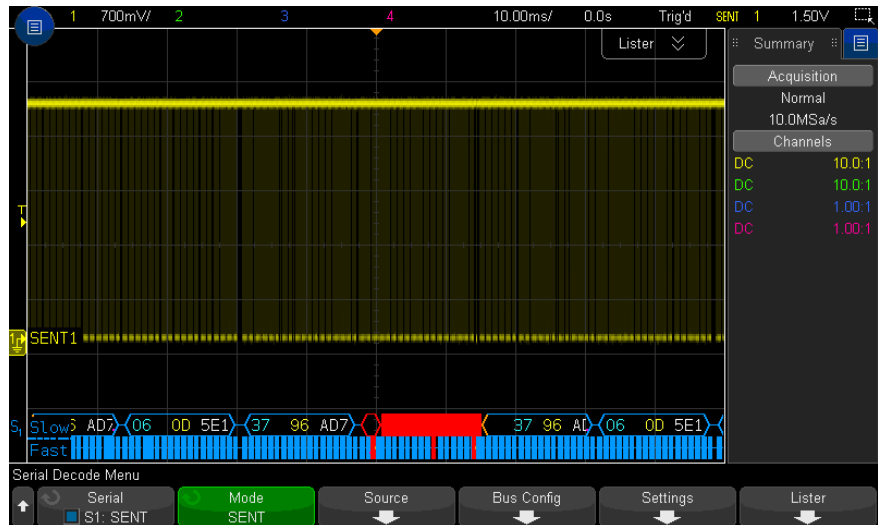
The fields of the Fast and Slow Channels are displayed as follows. Note that the Slow Channel has three different variants. The colors noted below indicate the color of the text:

- Fast Channel:



- Status & Communication (S&C) Nibble (green) (4 bits):
  - 2 Application bits and 2 Serial Message bits will be displayed, in all formats.
- Data Nibbles (white) (4 bits, but may be combined into Signals, based on format):
  - **"Fast Nibbles (All)"** format – each nibble displayed as hex or decimal number.
  - **"Fast Signals"**, **"Fast + Short Serial"**, or **"Fast + Enhanced Serial"** formats – If any fast signals are enabled, signals are displayed like:

- S1:<value>;S2:<value>.
- Unused nibbles are not displayed (example, when 6th nibble is an inverted copy of the 1st nibble).
- CRC Nibble (blue when valid, red when error detected) (4 bits).
- Slow Channel – Short Serial Message:
  - Message ID (yellow) (4 bits).
  - Data Byte (white) (8 bits).
  - CRC (blue when valid, red when error detected) (4 bits).

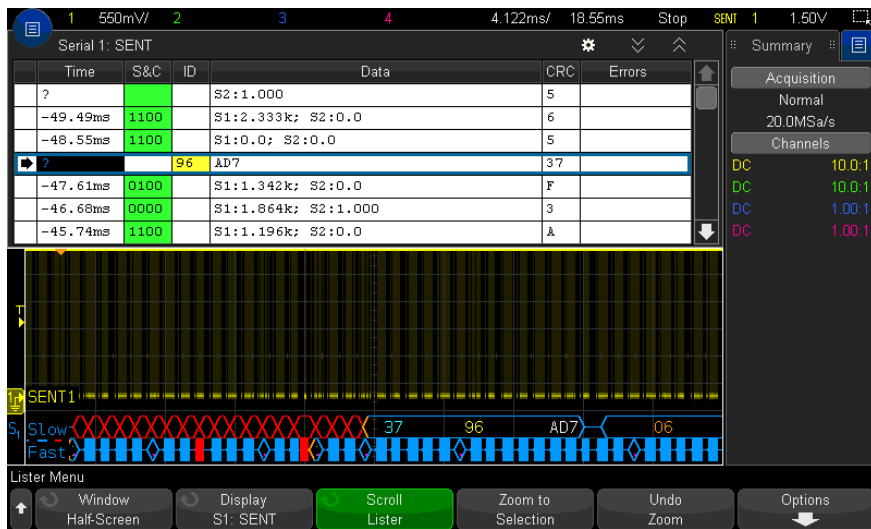


- Slow Channel – Enhanced Serial Message:
  - CRC (blue when valid, orange if end of message is off screen, red when error detected) (6 bits).
  - Message ID (yellow) (4 or 8 bits).
  - Data Field (white) (16 or 12 bits).

Enhanced Serial Message CRCs will be displayed in orange if the data to calculate the CRC is off-screen to the right. Serial messages will also be shown with a leading idle line in orange and an opening brace in orange if the starting location cannot be precisely determined due to that data being off screen to the left.

The decode will also indicate errors where a nibble's pulse is too wide or too narrow. This will be indicated by a ">" or "<" in red, as well as the rest of the packet's outline and closing brace being in red, as well as an orange idle line until the next valid sync. At the time of the valid sync, there will be an orange opening brace.

## Interpreting SENT Lister Data



Each Fast or Slow Channel message is represented on its own row. The start time of Slow Channel messages determines their order relative to the Fast Channel messages. Therefore, a Slow Channel message appears before most of the Fast Channel messages that it was built from. This is due to the "Time" column holding the start time of a packet.

In addition to the standard Time column, the following columns are used to support both the Fast Channel and the Slow Channel simultaneously, and these columns are displayed for all Message Format modes except **Fast Nibbles (All)**:

- S&C – (Fast Channel Only) (binary).
- ID – (Slow Channel Only) (Hex or Decimal).
- Data – (Hex or Decimal):
  - Fast Channel:

- <value> (value in Hex or Decimal) (Raw Decode Format).
- S1:<value>;S2:<value> (values are in Hex or Decimal) (other formats).
- Slow Channel: Hex or Decimal display of a single value.
- CRC – (value in Hex or Decimal).
- Pause Ticks (ticks will be displayed in orange if the uncertainty of the measurement is > 25%).
- Errors.

When the Message Format is set to **Fast Nibbles (All)**, the following columns are displayed:

- Sync Width.
- S&C – (Fast Channel Only) (binary).
- Data – (Hex or Decimal).
- CRC – (value in Hex or Decimal).
- Errors.

When the selected Message Format contains both Fast and Slow Channel Messages, the S&C Lister field (populated for Fast Messages) has a green background, and the ID Lister field (populated for Slow Messages) has a yellow background.

Slow Channel CRC values that cannot be confirmed as valid or invalid due to data used in the calculation being off screen to the right, will have an orange background in the Lister.

## Searching for SENT Data in the Lister

The oscilloscope's search capability lets you search for (and mark) certain types of SENT data in the Lister. You can use the **[Navigate]** key and controls to navigate through the marked rows.

- 1** With SENT selected as the serial decode mode, press **[Search]**.
- 2** In the Search Menu, press the **Search** softkey; then, turn the Entry knob to select Serial 1 or Serial 2, where the SENT signals is being decoded.
- 3** In the Search Menu, press **Search for**; then, select from these options:
  - **Fast Channel Data** – finds Fast Channel data nibbles that match the values entered using additional softkeys.

- **Slow Channel Message ID** – finds Slow Channel Message IDs that match the value entered using additional softkeys.
- **Slow Channel Message ID & Data** – finds Slow Channel Message IDs and Data that match the values entered using additional softkeys.
- **All CRC Errors** – finds any CRC error, Fast or Slow.
- **Pulse Period Error** – finds where a nibble is either too wide or too narrow (for example, data nibble < 12 (11.5) or > 27 (27.5) ticks wide). Sync, S&C, data, or checksum pulse periods are checked.

For more information on searching data, see [“Searching Lister Data”](#) on page 152.

For more information on using the **[Navigate]** key and controls, see [“Navigating the Time Base”](#) on page 75.



# 33 UART/RS232 Triggering and Serial Decode

Setup for UART/RS232 Signals / 511

UART/RS232 Triggering / 513

UART/RS232 Serial Decode / 515

UART/RS232 triggering and serial decode requires the COMP license that you can get by purchasing the DSOX3COMP upgrade.

## Setup for UART/RS232 Signals

To set up the oscilloscope to capture UART/RS232 signals:


- 1 Press **[Serial]**.
- 2 Press the **Serial** softkey, turn the Entry knob to select the desired slot (Serial 1 or Serial 2), and press the softkey again to enable decode.
- 3 Press the **Mode** softkey; then, select **UART/RS232** trigger type.
- 4 Press the **Signals** softkey to open the UART/RS232 Signals Menu.



- 5 For both the Rx and Tx signals:
  - a Connect an oscilloscope channel to the signal in the device under test.
  - b Press the **Rx** or **Tx** softkey; then, turn the Entry knob to select the channel for the signal.
  - c Press the corresponding **Threshold** softkey; then, turn the Entry knob to select the signal threshold voltage level.

The threshold voltage level is used in decoding, and it will become the trigger level when the trigger type is set to the selected serial decode slot.

The RX and TX labels for the source channels are automatically set.

- 6 Press the  Back/Up key to return to the Serial Decode Menu.
- 7 Press the **Bus Config** softkey to open the UART/RS232 Bus Configuration Menu.



Set the following parameters.

- a **#Bits** – Set the number of bits in the UART/RS232 words to match your device under test (selectable from 5-9 bits).
- b **Parity** – Choose odd, even, or none, based on your device under test.
- c **Baud** – Press the **Baud Rate** softkey, then press the **Baud** softkey and select a baud rate to match the signal in your device under test. You can select baud rates from 1.2 kb/s to 12 Mb/s.

If the desired baud rate is not listed, select **User Defined** on the Baud softkey; then, select the desired baud rate using the **User Baud** softkey. You can set the user-defined UART baud rate from 100 b/s to 8.0000 Mb/s.

- d **Polarity** – Select idle low or idle high to match your device under test's state when at idle. For RS232 select idle low.
- e **Bit Order** – Select whether the most significant bit (MSB) or the least significant bit (LSB) is presented after the start bit in the signal from your device under test. For RS232 select LSB.

## NOTE

In the serial decode display, the most significant bit is always displayed on the left regardless of how Bit Order is set.



## UART/RS232 Triggering

To set up the oscilloscope to capture UART/RS-232 signals, see **“Setup for UART/RS232 Signals”** on page 511.

To trigger on a UART (Universal Asynchronous Receiver/Transmitter) signal connect the oscilloscope to the Rx and Tx lines and set up a trigger condition. RS232 (Recommended Standard 232) is one example of a UART protocol.

- 1 Press **[Trigger]**.
- 2 In the Trigger Menu, press the **Trigger** softkey; then, turn the Entry knob to select the serial slot (Serial 1 or Serial 2) on which the UART/RS232 signals are being decoded.



- 3 Press the **Trigger Setup** softkey to open the UART/RS232 Trigger Setup Menu.



- 4 Press the **Base** softkey to select Hex or ASCII as the base displayed on the Data softkey in the UART/RS232 Trigger Setup Menu.

Note that the setting of this softkey does not affect the selected base of the decode display.

- 5 Press the **Trigger** softkey and set up the desired trigger condition:
  - **Rx Start Bit** – The oscilloscope triggers when a start bit occurs on Rx.
  - **Rx Stop Bit** – Triggers when a stop bit occurs on Rx. The trigger will occur on the first stop bit. This is done automatically whether the device under test uses 1, 1.5, or 2 stop bits. You do not need to specify the number of stop bits used by the device Under test.
  - **Rx Data** – Triggers on a data byte that you specify. For use when the device under test data words are from 5 to 8 bits in length (no 9th (alert) bit).

- **Rx 1:Data** – For use when the device under test data words are 9 bits in length including the alert bit (the 9th bit). Triggers only when the 9th (alert) bit is 1. The specified data byte applies to the least significant 8 bits (excludes the 9th (alert) bit).
  - **Rx 0:Data** – For use when the device under test data words are 9 bits in length including the alert bit (the 9th bit). Triggers only when the 9th (alert) bit is 0. The specified data byte applies to the least significant 8 bits (excludes the 9th (alert) bit).
  - **Rx X:Data** – For use when the device under test data words are 9 bits in length including the alert bit (the 9th bit). Triggers on a data byte that you specify regardless of the value of the 9th (alert) bit. The specified data byte applies to the least significant 8 bits (excludes the 9th (alert) bit).
  - Similar choices are available for Tx.
  - **Rx or Tx Parity Error** – Triggers on a parity error based on the parity you have set in the Bus Configuration Menu.
- 6 If you choose a trigger condition that includes "**Data**" in its description (for example: **Rx Data**), then press the **Data is** softkey, and choose an equality qualifier. You can choose equal to, not equal to, less than, or greater than a specific data value.
  - 7 Use the **Data** softkey to choose the data value for your trigger comparison. This works in conjunction with the **Data is** softkey.
  - 8 Optional: The **Burst** softkey lets you trigger on the Nth frame (1-4096) after an idle time you select. All trigger conditions must be met for the trigger to occur.
  - 9 If **Burst** is selected, an idle time (1  $\mu$ s to 10 s) can be specified so that the oscilloscope will look for a trigger condition only after the idle time has past. Press the **Idle** softkey and rotate the Entry knob to set an idle time.

**NOTE**

If the setup does not produce a stable trigger, the UART/RS232 signals may be slow enough that the oscilloscope is AutoTriggering. Press the **[Mode/Coupling]** key, then press the **Mode** softkey to set the trigger mode from **Auto** to **Normal**.

**NOTE**

To display UART/RS232 serial decode, see "**UART/RS232 Serial Decode**" on page 515.

## UART/RS232 Serial Decode

To set up the oscilloscope to capture UART/RS232 signals, see [“Setup for UART/RS232 Signals”](#) on page 511.

### NOTE

For UART/RS232 triggering setup see [“UART/RS232 Triggering”](#) on page 513.

To set up UART/RS232 serial decode:

- 1 Press **[Serial]** to display the Serial Decode Menu.



- 2 Press **Settings**.
- 3 In the UART/RS232 Settings Menu, press the **Base** softkey to select the base (hex, binary, or ASCII) in which decoded words are displayed.



- When displaying words in ASCII, the 7-bit ASCII format is used. Valid ASCII characters are between 0x00 and 0x7F. To display in ASCII you must select at least 7 bits in the Bus Configuration. If ASCII is selected and the data exceeds 0x7F, the data is displayed in hex.
  - When **#Bits** is set to 9 in the UART/RS232 Bus Configuration Menu, the 9th (alert) bit is displayed directly to the left of the ASCII value (which is derived from the lower 8 bits).
- 4 Optional: Press the **Framing** softkey and select a value. In the decode display, the chosen value will be displayed in light blue. However, if a parity error occurs the data will be displayed in red.
  - 5 If the decode line does not appear on the display, press the **[Serial]** key to turn it on.

- If the oscilloscope is stopped, press the **[Run/Stop]** key to acquire and decode data.

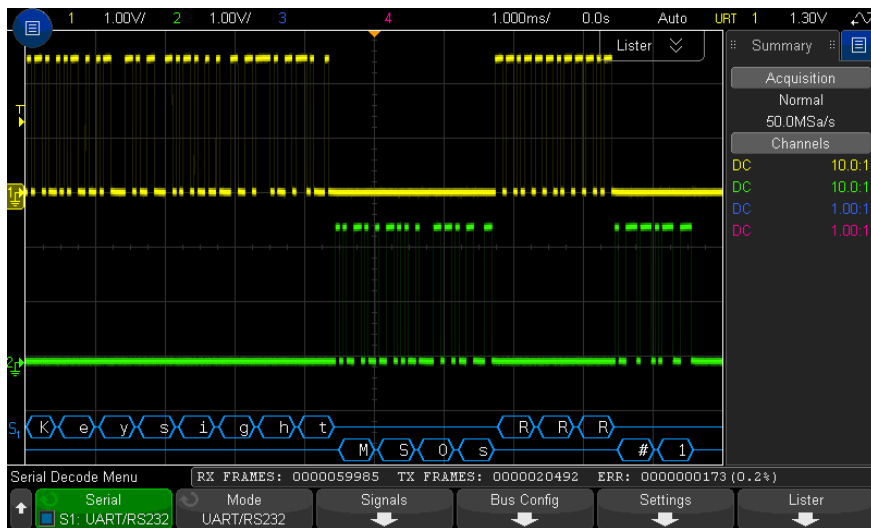
**NOTE**

If the setup does not produce a stable trigger, the UART/RS232 signals may be slow enough that the oscilloscope is AutoTriggering. Press the **[Mode/Coupling]** key, then press the **Mode** softkey to set the trigger mode from **Auto** to **Normal**.

You can use the horizontal **Zoom** window for easier navigation of the acquired data.

- See Also
- [“Interpreting UART/RS232 Decode”](#) on page 516
  - [“UART/RS232 Totalizer”](#) on page 517
  - [“Interpreting UART/RS232 Lister Data”](#) on page 518
  - [“Searching for UART/RS232 Data in the Lister”](#) on page 518

## Interpreting UART/RS232 Decode



- Angled waveforms show an active bus (inside a packet/frame).
- Mid-level blue lines show an idle bus.
- When using 5-8 bit formats, the decoded data is displayed in white (in binary, hex, or ASCII).

- When using the 9 bit format, all data words are displayed in green, including the 9th bit. The 9th bit is displayed on the left.
- When a data word value is selected for framing, it is displayed in light blue. When using 9-bit data words, the 9th bit will also be displayed in light blue.
- Decoded text is truncated at the end of the associated frame when there is insufficient space within frame boundaries.
- Pink vertical bars indicate you need to expand the horizontal scale (and run again) to see decode.
- When the horizontal scale setting does not permit the display of all available decoded data, red dots will appear in the decoded bus to mark the location of hidden data. Expand the horizontal scale to allow the data to display.
- An unknown (undefined) bus is shown in red.
- A parity error will cause the associated data word to be shown in red, which includes the 5-8 data bits and the optional 9th bit.

## UART/RS232 Totalizer

The UART/RS232 totalizer consists of counters that provide a direct measure of bus quality and efficiency. The totalizer appears on screen whenever UART/RS232 Decode is ON in the Serial Decode Menu.

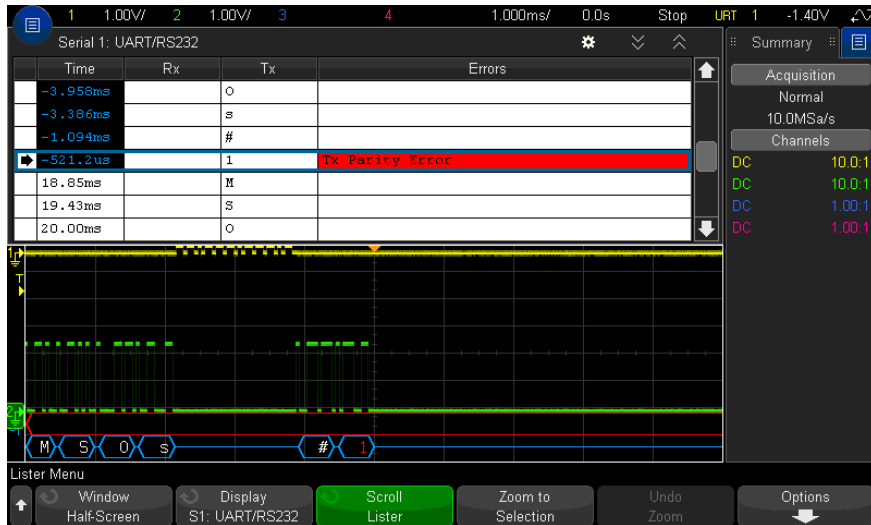


The totalizer is running, counting frames and calculating the percentage of error frames, even when the oscilloscope is stopped (not acquiring data).

The ERR (error) counter is a count of Rx and Tx frames with parity errors. The TX FRAMES and RX FRAMES counts include both normal frames and frames with parity errors. When an overflow condition occurs, the counter displays **OVERFLOW**.

The counters can be reset to zero by pressing the **Reset UART Counters** softkey in the UART/RS232 Settings Menu.

## Interpreting UART/RS232 Lister Data



In addition to the standard Time column, the UART/RS232 Lister contains these columns:

- Rx – receive data.
- Tx – transmit data.
- Errors – highlighted in red, Parity Error or Unknown Error.

Aliased data is highlighted in pink. When this happens, decrease the horizontal time/div setting and run again.

## Searching for UART/RS232 Data in the Lister

The oscilloscope's search capability lets you search for (and mark) certain types of UART/RS232 data in the Lister. You can use the **[Navigate]** key and controls to navigate through the marked rows.

- 1 With UART/RS232 selected as the serial decode mode, press **[Search]**.
- 2 In the Search Menu, press the **Search** softkey; then, turn the Entry knob to select the serial slot (Serial 1 or Serial 2) on which the UART/RS232 signals are being decoded.
- 3 In the Search Menu, press **Search**; then, select from these options:

- **Rx Data** – Finds a data byte that you specify. For use when the DUT data words are from 5 to 8 bits in length (no 9th (alert) bit).
- **Rx 1:Data** – For use when the DUT data words are 9 bits in length including the alert bit (the 9th bit). Finds only when the 9th (alert) bit is 1. The specified data byte applies to the least significant 8 bits (excludes the 9th (alert) bit)
- **Rx 0:Data** – For use when the DUT data words are 9 bits in length including the alert bit (the 9th bit). Finds only when the 9th (alert) bit is 0. The specified data byte applies to the least significant 8 bits (excludes the 9th (alert) bit).
- **Rx X:Data** – For use when the DUT data words are 9 bits in length including the alert bit (the 9th bit). Finds a data byte that you specify regardless of the value of the 9th (alert) bit. The specified data byte applies to the least significant 8 bits (excludes the 9th (alert) bit).
- Similar choices are available for Tx.
- **Rx or Tx Parity Error** – Finds a parity error based on the parity you have set in the Bus Configuration Menu.
- **Rx or Tx Any Error** – Finds any error.

For more information on searching data, see [“Searching Lister Data”](#) on page 152.

For more information on using the **[Navigate]** key and controls, see [“Navigating the Time Base”](#) on page 75.





# Index

## Symbols

- (-) Width measurement, 260
- (+) Width measurement, 260

## Numerics

- 1 M ohm input impedance, 83
- 50 ohm input impedance, 82

## A

- About Oscilloscope, 356
- absolute value math function, 115
- AC channel coupling, 82
- AC RMS - Full Screen measurement, 255
- AC RMS - N Cycles measurement, 255
- accessories, 28, 378
- acquire, 215, 225
- Acquire key, 39
- acquisition memory, 170
- acquisition memory, saving, 326
- acquisition mode, 221
- acquisition mode, averaging, 225
- acquisition mode, high resolution, 227
- acquisition mode, normal, 222
- acquisition mode, peak detect, 222
- acquisition mode, preserve during Autoscale, 349
- acquisition modes, 215
- active serial bus, 413, 443, 452, 462, 516
- activity indicator, 137
- actual sample rate, 221
- adding digital channels license, 380
- addition math function, 102
- address with no ack condition, I2C trigger, 439
- adjacent channel power ratio (ACPR) FFT analysis measurement, 268
- AERO license, 379

- aliasing, 217
- aliasing, FFT, 95
- alternating edge trigger, 173
- AM (amplitude modulation), waveform generator output, 315
- Amplitude measurement, 251
- amplitude modulation (AM), waveform generator output, 315
- analog channel inputs, 43
- analog channel, probe attenuation, 85
- analog channel, setup, 79
- analog filters, adjusting, 89, 109
- analysis results, saving, 323
- Analyze key, 42
- Analyze Segments, 229, 231, 274
- annotation, adding, 166
- arbitrary generated waveforms, editing, 305
- arbitrary waveform generator output, 302
- arbitrary waveforms, copying from other sources, 311
- arbitrary waveforms, creating new, 306
- arbitrary waveforms, editing existing, 307
- Area - Full Screen measurement, 267
- Area - N Cycles measurement, 267
- ARINC 429 serial decode, 491
- ARINC 429 totalizer, 494
- ARINC 429 trigger, 489
- ARINC 429 words/errors counter, 494
- ARINC 429 decode, signal speed, 488
- ARINC 429 decode, signal type, 488
- ARINC 429 decode, word format, 491
- ASCII file format, 322
- ASCII XY data, 325
- attenuation, probe, 85
- attenuation, probe, external trigger, 214
- attenuators, 86
- AUDIO license, 379
- Auto Increment, 330

- AUTO license, 379
- Auto Scale key, 40
- Auto Setup, FFT, 91, 111, 112
- Auto trigger mode, 208
- Auto? trigger indicator, 209
- AutoIP, 343, 344
- automatic measurements, 243, 246
- automatic setup, 135
- AutoProbe interface, 43, 82
- Autoscale preferences, 349
- Autoscale, digital channels, 135
- Autoscale, undo, 35
- Average - Full Screen measurement, 254
- Average - N Cycles measurement, 254
- average measurement trend, 123
- averaged value math function, 119
- averaging acquire mode, 221, 225
- Ax + B math function, 114

## B

- Back Up key, 38
- band width, 356
- band width limit, 83
- band width required, oscilloscope, 220
- band width, oscilloscope, 218
- band width, real time sampling, 228
- Bartlett FFT window, 91, 110
- base 10 exponential math function, 117
- Base measurement, 252
- BIN file format, 322
- binary data (.bin), 381
- binary data file examples, 385
- binary data in MATLAB, 382
- binary data, example program for reading, 385
- binary mode cursors, 235
- bit rate measurement, 261
- bits, SPI trigger, 450
- Blackman Harris FFT window, 90, 110

- blanking, [70](#)
  - BMP file format, [322](#)
  - Bode plot, frequency response analysis, [298](#)
  - brick-wall frequency response, [218](#)
  - brightness of waveforms, [38](#)
  - Browser Web Control, [361](#), [362](#), [363](#), [364](#), [365](#)
  - built-in help, [61](#)
  - burst width measurements, [260](#)
  - burst, capture signal bursts, [229](#)
  - bus display mode, [140](#)
  - buttons (keys), front panel, [37](#)
  - BW Limit? in DVM display, [290](#)
- C**
- calibrate probe, [86](#)
  - calibration, [352](#)
  - calibration protect button, [59](#)
  - calibration protect switch, [58](#)
  - calibration status, [371](#)
  - CAN decode, source channels, [396](#)
  - CAN FD standard, [398](#)
  - CAN frame counter, [404](#)
  - CAN serial decode, [402](#)
  - CAN symbolic data, [398](#)
  - CAN totalizer, [404](#)
  - CAN trigger, [399](#)
  - CANFD license, [379](#)
  - capture signal bursts, [229](#)
  - cardiac waveform generator output, [304](#)
  - Center, FFT, [90](#), [109](#)
  - channel labels, [161](#)
  - channel power FFT analysis measurement, [267](#)
  - channel, analog, [79](#)
  - channel, bandwidth limit, [83](#)
  - channel, coupling, [81](#)
  - channel, fine adjustment, [83](#)
  - channel, invert, [84](#)
  - channel, on/off keys, [42](#)
  - channel, position, [81](#)
  - channel, probe units, [85](#)
  - channel, skew, [86](#)
  - channel, vertical sensitivity, [81](#)
  - characteristics, [375](#)
  - chart logic bus state math function, [125](#)
  - chart logic bus timing math function, [124](#)
  - choosing values, [39](#)
  - cleaning, [356](#)
  - clear display, [158](#), [224](#)
  - clear display, Quick Clear Display, [358](#)
  - clear persistence, [158](#)
  - clock, [349](#)
  - Clock Extension Peripheral Interface (CXPI) serial analysis, license, [379](#)
  - CMOS threshold, [139](#)
  - common logarithm math function, [116](#)
  - COMP license, [379](#)
  - compensate passive probes, [36](#), [43](#)
  - Config softkey, [343](#), [344](#)
  - connect probes, digital, [131](#)
  - connection, to a PC, [344](#)
  - connections for frequency response analysis (FRA), [295](#)
  - connectors, rear panel, [58](#)
  - control, remote, [341](#)
  - controls, front panel, [37](#)
  - copyright, [2](#)
  - counter, [291](#)
  - Counter measurement, [259](#)
  - counter, ARINC 429 words/errors, [494](#)
  - counter, CAN frame, [404](#)
  - counter, FlexRay frame, [433](#)
  - counter, UART/RS232 frame, [517](#)
  - coupling, channel, [81](#)
  - coupling, trigger, [209](#)
  - crosstalk problems, [89](#), [109](#)
  - CSV data, [325](#)
  - CSV file format, [322](#)
  - CSV files, minimum and maximum values, [389](#)
  - cursor measurements, [233](#)
  - cursor units, [236](#)
  - Cursors key, [41](#)
  - Cursors knob, [41](#)
  - cursors, binary, [235](#)
  - cursors, gated measurement window, [272](#)
  - cursors, hex, [235](#)
  - cursors, manual, [234](#)
  - cursors, measure mode, [234](#)
  - cursors, track waveform, [234](#)
  - custom location, time reference, [73](#)
  - CXPI decode, interpreting, [423](#)
  - CXPI decode, signal setup, [417](#)
  - CXPI license, [379](#)
  - CXPI Lister data, [425](#)
  - CXPI serial decode, [421](#)
  - CXPI trigger, [418](#)
  - Czech front panel overlays, [45](#)
  - Czech user interface, [62](#)
- D**
- D\*, [41](#), [139](#)
  - d/dt math function, [105](#)
  - damage, shipping, [27](#)
  - data sheet, [375](#)
  - DC channel coupling, [82](#)
  - DC offset correction for integrate waveform, [107](#)
  - DC RMS - Full Screen measurement, [255](#)
  - DC RMS - N Cycles measurement, [255](#)
  - DC signals, checking, [209](#)
  - DC waveform generator output, [303](#)
  - DDR burst, random trigger holdoff, [212](#)
  - dead time (re-arm), [231](#)
  - decaying average approximation, [120](#)
  - decibels, FFT vertical units, [91](#), [110](#)
  - decimating samples, [221](#)
  - decimation, for measurement record, [389](#)
  - decimation, for screen, [389](#)
  - default configuration, [33](#)
  - default setup, [33](#), [334](#)
  - Default Setup key, [40](#)
  - defaults, waveform generator, [318](#)
  - delay knob, [65](#)
  - Delay measurement, [247](#), [261](#)
  - delay time indicator, [73](#)
  - delayed sweep, [71](#)
  - delete file, [344](#)
  - Demo 1 terminal, [43](#)
  - Demo 2 terminal, [43](#)
  - depth, AM modulation, [315](#)
  - detection type, FFT (Magnitude), [110](#)
  - deviation, FM modulation, [316](#)
  - DHCP, [343](#), [344](#)
  - differentiate math function, [105](#)
  - digital bus mode, [140](#)

- digital channel controls, [41](#)
  - digital channel inputs, [43](#)
  - digital channel menu, [138](#)
  - digital channels, [138](#)
  - digital channels, Autoscale, [135](#)
  - digital channels, enabling, [380](#)
  - digital channels, logic threshold, [138](#)
  - digital channels, probing, [143](#)
  - digital channels, size, [137](#)
  - digital display, interpreting, [136](#)
  - Digital key, [41](#)
  - digital probes, [131](#), [143](#)
  - digital probes, impedance, [143](#)
  - digital voltmeter (DVM), [290](#)
  - digits, counter resolution, [292](#)
  - Display key, [39](#)
  - display multiple acquisitions, [216](#)
  - display, area, [60](#)
  - display, clear, [158](#)
  - display, interpreting, [59](#)
  - display, persistence, [157](#)
  - display, signal detail, [155](#)
  - display, softkey labels, [61](#)
  - display, status line, [60](#)
  - displayed channels Autoscale, [349](#)
  - distortion problems, [89](#), [109](#)
  - Divide math function, [103](#)
  - DNS IP, [343](#)
  - dual-channel (N2820A probe)
    - measurements, [248](#)
  - Duty cycle measurement, [260](#)
  - duty cycle measurement trend, [123](#)
  - DVM (digital voltmeter), [290](#)
  - Dynamic DNS, [343](#)
- E**
- ECL threshold, [139](#)
  - edge speeds, [220](#)
  - edge then edge triggering, [174](#)
  - edge triggering, [172](#)
  - editing measurements, [246](#)
  - EEPROM data read, I2C trigger, [439](#)
  - either edge trigger, [173](#)
  - e-mail setups, images, or data, [330](#)
  - e-mail, Quick Email, [358](#)
  - EMBD license, [379](#)
  - energy of a pulse, [106](#)
- English user interface and Quick Help, [62](#)
  - Entry knob, [39](#)
  - Entry knob, push to select, [39](#)
  - envelope math function, [120](#)
  - envelope, max/min, [122](#)
  - equivalent time sampling, [227](#)
  - erase, secure, [334](#)
  - event table, [151](#)
  - expand about, [81](#), [347](#)
  - expand about center, [347](#)
  - expand about ground, [347](#)
  - exponential fall waveform generator
    - output, [303](#)
  - exponential math function, [117](#)
  - exponential rise waveform generator
    - output, [303](#)
  - exporting waveform, [321](#)
  - EXT TRIG IN as Z-axis input, [70](#)
  - EXT TRIG IN connector, [59](#)
  - external memory device, [43](#)
  - external trigger, [213](#)
  - external trigger, input impedance, [213](#)
  - external trigger, probe
    - attenuation, [214](#)
  - external trigger, probe units, [213](#)
- F**
- factory default settings, [334](#)
  - Fall time measurement, [261](#)
  - fall time measurement trend, [123](#)
  - falling edges count
    - measurements, [266](#)
  - fast debug Autoscale, [349](#)
  - FAT file system format, [346](#)
  - FAT32 file system format, [346](#)
  - FFT (Magnitude) detection type, [110](#)
  - FFT aliasing, [95](#)
  - FFT analysis measurements, [267](#)
  - FFT DC value, [95](#)
  - FFT gating, [91](#), [110](#)
  - FFT key, [41](#)
  - FFT magnitude math function, [108](#)
  - FFT math function, [89](#)
  - FFT measurement hints, [93](#)
  - FFT peaks, searching, [93](#)
  - FFT phase math function, [108](#)
  - FFT resolution, [94](#)
  - FFT spectral leakage, [97](#)
  - FFT units, [95](#)
  - FFT vertical units, [91](#), [110](#)
  - FFT window, [90](#), [110](#)
  - file explorer, [344](#)
  - file format, ASCII, [322](#)
  - file format, BIN, [322](#)
  - file format, BMP, [322](#)
  - file format, CSV, [322](#)
  - file format, PNG, [322](#)
  - File keys, [42](#)
  - file name, new, [329](#)
  - file, save, recall, load, [344](#)
  - filter math function, averaged
    - value, [119](#)
  - filter math function, envelope, [120](#)
  - filter math function, high pass and low pass, [118](#)
  - filter math function, smoothing, [120](#)
  - filters, math, [118](#)
  - fine adjustment, channel, [83](#)
  - fine adjustment, horizontal scale, [72](#)
  - firmware updates, [380](#)
  - firmware upgrade files, [371](#)
  - firmware version information, [359](#)
  - firmware versions, [371](#)
  - flash drive, [43](#)
  - Flat top FFT window, [90](#), [110](#)
  - FLEX license, [379](#)
  - FlexRay frame counter, [433](#)
  - FlexRay serial decode, [431](#)
  - FlexRay totalizer, [433](#)
  - FlexRay trigger, [428](#)
  - FM (frequency modulation), waveform
    - generator output, [316](#)
  - folding frequency, [217](#)
  - forcing a trigger, [171](#)
  - FRA (frequency response analysis), [295](#)
  - FRA license, [379](#)
  - frame trigger, I2C, [440](#)
  - frame, LIN symbolic, [411](#)
  - freeze display, [358](#)
  - freeze display, Quick Freeze
    - Display, [358](#)
  - French front panel overlays, [45](#)
  - French user interface and Quick Help, [62](#)
  - frequency counter, [292](#)
  - frequency data in CSV files, [390](#)

- frequency deviation, FM modulation, [316](#)
  - Frequency measurement, [258](#)
  - frequency measurement trend, [123](#)
  - frequency modulation (FM), waveform generator output, [316](#)
  - frequency peaks, searching, [93](#)
  - frequency requirements, power source, [31](#)
  - frequency response analysis (FRA), [295](#)
  - frequency response analysis data, save, [299](#)
  - frequency, Nyquist, [217](#)
  - frequency-shift keying modulation (FSK), waveform generator output, [317](#)
  - front panel controls and connectors, [37](#)
  - front panel self test, [356](#)
  - front panel, full scope remote, [362](#)
  - front panel, language overlay, [44](#)
  - front panel, screen only remote, [363](#)
  - front panel, tablet remote, [364](#)
  - FSK (frequency-shift keying modulation), waveform generator output, [317](#)
  - Full Scope Remote Front Panel, [362](#)
- G**
- gated by cursors measurement window, [272](#)
  - gateway IP, [343](#)
  - gating, FFT, [91, 110](#)
  - Gaussian frequency response, [218](#)
  - Gaussian pulse waveform generator output, [304](#)
  - Generic video trigger, [195](#)
  - German front panel overlays, [45](#)
  - German noise requirements, [393](#)
  - German user interface and Quick Help, [62](#)
  - glitch capture, [223](#)
  - glitch trigger, [175](#)
  - golden waveform test, [275](#)
  - GPIB module, [30, 59](#)
  - GPIB module installation, [30](#)
  - grabber, [133](#)
  - graphical user interface language, [62](#)
  - graticule intensity, [159](#)
  - graticule type, [158](#)
  - grid intensity, [159](#)
  - grid type, [158](#)
  - ground level, [80](#)
  - Ground terminal, [43](#)
- H**
- Hanning FFT window, [90, 110](#)
  - hard ware self test, [355](#)
  - Help key, [42](#)
  - help, built-in, [61](#)
  - hex bus trigger, [180](#)
  - hex mode cursors, [235](#)
  - HF Reject, [211](#)
  - high pass filter math function, [118](#)
  - high-frequency noise rejection, [211](#)
  - high-resolution mode, [221, 227](#)
  - holdoff, [212](#)
  - hop frequency, FSK modulation, [318](#)
  - Horiz key, [40, 63, 68, 71, 224](#)
  - Horizontal controls, [40, 67](#)
  - horizontal Navigate key, [40](#)
  - horizontal position control, [40](#)
  - horizontal position knob, [65](#)
  - horizontal scale fine adjustment, [72](#)
  - horizontal Search key, [40](#)
  - horizontal sweep speed control, [40](#)
  - horizontal time/div control, [40](#)
  - horizontal Zoom key, [40](#)
  - host name, [343, 359](#)
  - Host name softkey, [344](#)
- I**
- I/O interface settings, [341](#)
  - I2C serial decode, [442](#)
  - I2C trigger, [438](#)
  - I2S serial decode, [461](#)
  - I2S trigger, [458](#)
  - identification function, web interface, [370](#)
  - idle serial bus, [413, 443, 452, 462, 516](#)
  - Imped softkey, [82](#)
  - impedance, digital probes, [143](#)
  - increment statistics, [274](#)
  - indeterminate state, [235](#)
  - infinite persistence, [157, 216, 223](#)
  - information area, [61](#)
  - input impedance, analog channel input, [82](#)
  - installed licenses, [356](#)
  - installed options, [371](#)
  - instantaneous slope of a waveform, [105](#)
  - Instrument Utilities web page, [370](#)
  - Integrate math function, [106](#)
  - intensity control, [155](#)
  - Intensity key, [38](#)
  - interpolate, arbitrary waveform option, [306](#)
  - invert graticule colors, [324](#)
  - invert waveform, [84](#)
  - IP address, [343, 359](#)
  - Italian front panel overlays, [45](#)
  - Italian user interface and Quick Help, [62](#)
- J**
- Japanese front panel overlays, [45](#)
  - Japanese user interface and Quick Help, [62](#)
- K**
- keys, front panel, [37](#)
  - Keysight IO Libraries Suite, [366](#)
  - knobs, front panel, [37](#)
  - Korean front panel overlays, [45](#)
  - Korean user interface and Quick Help, [62](#)
  - ksx files, [345](#)
- L**
- label list, [165](#)
  - label list, loading from text file, [164](#)
  - labels, [161](#)
  - labels, auto-increment, [164](#)
  - labels, reset library, [165](#)
  - LAN connection, [343](#)
  - LAN interface, remote control, [341](#)
  - LAN port, [59](#)
  - LAN Settings softkey, [343, 344](#)
  - LAN/VGA module, [30, 59](#)
  - LAN/VGA module installation, [30](#)

- landscape mode, 338
  - language, user interface, 62
  - length control, 326
  - length softkey, 325
  - level, trigger, 170
  - LF Reject, 210
  - library, labels, 163
  - licenses, 379, 380
  - LIN serial decode, 411
  - LIN symbolic data, 409
  - LIN trigger, 409
  - line voltage, 31
  - Lister, 151
  - load file, 344
  - Load from, 329
  - localized front panel overlay, 44
  - Location, 329
  - Location, File Explorer softkey label, 346
  - logging remote commands, 351
  - logic presets, waveform generator, 313
  - logic threshold, 138
  - low pass filter math function, 118
  - low-frequency noise rejection, 210
- ## M
- magnify math function, 121
  - Manchester serial decode, 470
  - Manchester trigger, 468
  - Manchester/NRZ serial analysis, license, 379
  - markings, product, 392
  - mask files, recall, 332
  - MASK license, 379
  - mask statistics, quick reset, 358
  - mask test, trigger output, 279, 350
  - mask testing, 275
  - mask, TRIG OUT signal, 350
  - math filters, 118
  - math functions, cascaded, 100
  - Math key, 41
  - math operators, 102
  - math transforms, 104
  - math visualizations, 121
  - math, 1\*, 103
  - math, 1/2, 103
  - math, addition, 102
  - math, differentiate, 105
  - math, divide, 103
  - math, FFT, 89
  - math, FFT magnitude/phase, 108
  - math, functions, 99
  - math, integrate, 106
  - math, multiply, 103
  - math, offset, 101
  - math, scale, 101
  - math, subtract, 102
  - math, units, 101
  - math, using waveform math, 99
  - MATLAB binary data, 382
  - max envelope, 122
  - max hold math function, 122
  - maximum input voltages, 376
  - maximum math function, 122
  - Maximum measurement, 251
  - maximum sample rate, 221
  - Meas key, 41, 243
  - Measure controls, 41
  - measure mode cursors, 234
  - measure statistics, quick reset, 358
  - measure, Quick Measure All, 358
  - measurement category, definitions, 376
  - measurement definitions, 246
  - measurement record, 326
  - measurement statistics, 272
  - measurement thresholds, 270
  - measurement trend math function, 122
  - measurement window, 272
  - measurements, 246
  - measurements, automatic, 243
  - measurements, delay, 247
  - measurements, edit, 246
  - measurements, overshoot, 247
  - measurements, phase, 247
  - measurements, preshoot, 248
  - measurements, time, 257
  - measurements, voltage, 250
  - MegaZoom IV, 5
  - memMax, 379
  - memory depth and sample rate, 221
  - memory, segmented, 229
  - menu line, 61
  - message, CAN symbolic, 401
  - MIL-STD-1553 serial decode, 484
  - MIL-STD-1553 trigger, 483
  - min envelope, 122
  - min hold math function, 122
  - minimum math function, 122
  - Minimum measurement, 251
  - missing acknowledgment condition, I2C trigger, 439
  - Mode/Coupling key, trigger, 207
  - model number, 356, 359
  - Modify softkey, 344
  - modulation, waveform generator output, 314
  - module installed, 356
  - module slot, 59
  - MSO, 5
  - MSO feature upgrade, 380
  - MSO license, 379
  - Multicast DNS, 343
  - multiplexed position knob, 41
  - multiplexed scale knob, 41
  - Multiply math function, 103
- ## N
- N2820A high-sensitivity current probe, 248
  - N8900A Infiniium Offline oscilloscope analysis software, 322
  - natural logarithm math function, 116
  - navigate files, 344
  - Navigate key, 40
  - navigating the time base, 75
  - Near Field Communication (NFC) trigger, license, 379
  - Near Field Communication (NFC) triggering, 183
  - negative pulse width measurement trend, 123
  - network configuration parameters, 359
  - network printer connection, 337
  - network, connecting to, 343
  - new label, 163
  - NFC license, 379
  - NFC triggering, 183
  - noise rejection, 211
  - noise waveform generator output, 303
  - noise, adding to waveform generator output, 313
  - noise, high-frequency, 211
  - noise, low-frequency, 210
  - noisy signals, 207

non-volatile memory, secure erase, 334  
 normal acquire mode, 222  
 normal mode, 221, 222  
 Normal trigger mode, 208  
 notices, 2  
 NRZ license, 379  
 NRZ serial decode, 477  
 NRZ trigger, 475  
 Nth edge burst trigger, 186  
 Nth edge triggering, 186  
 number of negative pulses measurements, 265  
 number of positive pulses measurements, 265  
 Nyquist frequency, 95  
 Nyquist sampling theory, 217

## O

occupied band width FFT analysis measurement, 268  
 offset (DC) correction for integrate waveform, 107  
 operators, math, 102  
 options, print, 338  
 OR trigger, 181  
 oscilloscope band width, 218  
 oscilloscope band width required, 220  
 oscilloscope rise time, 219  
 oscilloscope sample rate, 219  
 output load expected, waveform generator, 312  
 output, trigger, 350  
 overlay, localized, 44  
 Overshoot measurement, 247, 252  
 overvoltage category, 377

## P

palette, 324  
 pan and zoom, 64  
 passive probes, compensating, 36  
 password (network), reset, 373  
 password (network), setting, 372  
 pattern trigger, 178  
 pattern, SPI trigger, 450  
 PC connection, 344  
 peak detect mode, 221, 222, 223

peak-peak math function, 122  
 Peak-peak measurement, 251  
 period counter, 292  
 Period measurement, 258  
 period measurement trend, 123  
 persistence, 157  
 persistence, clearing, 158  
 persistence, infinite, 216  
 Phase measurement, 247, 262  
 phase X cursor units, 236  
 PNG file format, 322  
 points per span, FFT (Magnitude), 111  
 point-to-point connection, 344  
 Polish front panel overlays, 45  
 Polish user interface and Quick Help, 62  
 pollution degree, 377  
 pollution degree, definitions, 377  
 Portuguese front panel overlays, 45  
 Portuguese user interface and Quick Help, 62  
 position digital channels, 139  
 position knob, 139  
 position, analog, 81  
 positive pulse width measurement trend, 123  
 post-processing, 244  
 post-trigger information, 66  
 Power App measurements, 248  
 power consumption, 31  
 power cord connector, 59  
 power requirements, 31  
 power supply, 59  
 power switch, 32, 38  
 power-on, 31  
 predefined labels, 162  
 Preshoot measurement, 248, 254  
 Press to go, 329  
 Press to go, File Explorer softkey label, 346  
 pre-trigger information, 65  
 print, 358  
 Print key, 42  
 print options, 338  
 print screen, 335  
 print, landscape, 338  
 print, Quick Print, 358  
 printer, USB, 43, 335  
 printing the display, 335

probe attenuation, 85  
 probe attenuation, external trigger, 214  
 probe compensation, 43  
 probe head, 86  
 probe units, 85  
 probe, AutoProbe interface, 43  
 probe, calibrate, 86  
 probes, 378  
 probes, connecting to oscilloscope, 32  
 probes, digital, 131  
 probes, passive, compensating, 36  
 programmer's guide, 367  
 PTYPE frames, CXPI, 419  
 pulse polarity, 176  
 pulse waveform generator output, 303  
 pulse width trigger, 175  
 PWR license, 380

## Q

qualifier, pulse width, 177  
 Quick Action key, 42, 357  
 Quick Clear Display, 358  
 Quick Email, 358  
 Quick Freeze Display, 358  
 Quick Help, 61  
 Quick Mask Statistics Reset, 358  
 Quick Measure All, 358  
 Quick Measure Statistics Reset, 358  
 Quick Print, 358  
 Quick Recall, 358  
 Quick Save, 358  
 Quick Trigger Mode, 358

## R

ramp waveform generator output, 303  
 random noise, 207  
 random trigger holdoff, 212  
 ratio measurement, 257  
 ratio measurement trend, 123  
 ratio X cursor units, 236  
 ratio Y cursor units, 236  
 raw acquisition record, 326  
 realtime sampling and oscilloscope band width, 228  
 realtime sampling option, 227  
 rear panel connectors, 58

- re-arm time, 231
  - recall, 358
  - recall files via web interface, 368
  - recall mask files, 332
  - recall setups, 332
  - recall, Quick Recall, 358
  - Rectangular FFT window, 90, 110
  - Ref key, 41, 127
  - reference point, waveform, 347
  - reference waveforms, 127
  - regulatory information, 392
  - remote commands, logging, 351
  - remote control, 341
  - Remote Front Panel, 365
  - remote programming, Keysight IO Libraries, 366
  - remote programming, web interface, 365
  - required oscilloscope bandwidth, 220
  - reset label library, 165
  - reset network password, 373
  - restart condition, I2C trigger, 439
  - results, frequency response analysis (FRA), 298
  - return instrument for service, 357
  - Rise time measurement, 261
  - rise time measurement trend, 123
  - rise time, oscilloscope, 219
  - rise time, signal, 220
  - rise/fall time triggering, 182
  - rising edge count measurements, 266
  - RMS - AC measurement trend, 123
  - roll mode, 67
  - RS232 trigger, 513
  - Run Control keys, 40
  - runt pulses, 258
  - runt triggering, 188
  - Russian front panel overlays, 45
  - Russian user interface and Quick Help, 62
- S**
- safety warning, 33
  - sample rate, 4
  - sample rate and memory depth, 221
  - sample rate, current rate displayed, 64
  - sample rate, oscilloscope, 218, 219
  - sampling theory, 217
  - sampling, overview, 217
  - save, 358
  - save file, 344
  - save files via web interface, 367
  - save segment, 325
  - save setup files, 323
  - save times, data, 327
  - Save to, 329
  - save, Quick Save, 358
  - save/recall from web interface, 367
  - Save/Recall key, 42
  - saver, screen, 348
  - saving data, 321
  - SCL, I2C trigger, 438
  - SCLK, I2S trigger, 456
  - SCPI Commands window, 365
  - screen image via web interface, 369
  - Screen Only Remote Front Panel, 363
  - screen saver, 348
  - SDA, 437
  - SDA, I2C trigger, 438
  - Search key, 40
  - secure erase, 334
  - segmented memory, 229
  - segmented memory, re-arm time, 231
  - segmented memory, saving segments, 325
  - segmented memory, statistical data, 231
  - select digital channels, 139
  - select knob, 139
  - Selected, File Explorer softkey label, 346
  - selecting, values, 39
  - self test, front panel, 356
  - self test, hardware, 355
  - SENSOR license, 380
  - SENT data, searching, 508
  - SENT decode, interpreting, 505
  - SENT decode, signal setup, 497
  - SENT fast signals definition, 500
  - SENT Lister data, 507
  - SENT serial decode, 504
  - SENT trigger, 502
  - serial clock, I2C trigger, 438
  - serial clock, I2S trigger, 456
  - serial data, 437
  - serial data, I2C trigger, 438
  - serial decode controls, 41
  - Serial key, 41
  - serial number, 356, 359
  - service functions, 352
  - setup and hold triggering, 190
  - setup files, saving, 323
  - setup, automatic, 135
  - setup, default, 33
  - setup, frequency response analysis (FRA), 296
  - setups, recall, 332
  - shipping damage, 27
  - shipping precautions, 357
  - Sigma, minimum, 278
  - signal, CAN symbolic, 401
  - signal, LIN symbolic, 411
  - Simplified Chinese front panel overlays, 45
  - Simplified Chinese user interface and Quick Help, 62
  - sinc waveform generator output, 303
  - sine waveform generator output, 302
  - single acquisition, 40
  - Single key, 215
  - single-shot acquisitions, 209
  - single-shot events, 216
  - size, 137
  - skew, analog channel, 86
  - slope trigger, 172
  - smoothing math function, 120
  - Snapshot All measurements, 249
  - snapshot all, quick action, 358
  - softkey labels, 61
  - softkeys, 8, 38
  - software updates, 380
  - software version, 356
  - Span, FFT, 90, 109
  - Spanish front panel overlays, 45
  - Spanish user interface and Quick Help, 62
  - specifications, 375
  - spectral leakage, FFT, 97
  - SPI serial decode, 451
  - SPI trigger, 449
  - square math function, 115
  - square root, 113
  - square waveform generator output, 303
  - square waves, 218
  - stand-alone connection, 344

start acquisition, 40  
 start condition, I2C, 439  
 Start Freq, FFT, 90, 109  
 state logic bus chart, 125  
 statistics, increment, 274  
 statistics, mask test, 280  
 statistics, measurement, 272  
 statistics, using segmented memory, 231  
 status line, 60  
 status, User Cal, 356  
 Std Deviation measurement, 255  
 stop acquisition, 40  
 stop condition, I2C, 439  
 Stop Freq, FFT, 90, 109  
 storage locations, navigate, 329  
 subnet mask, 343  
 subtract math function, 102  
 sweep frequencies, frequency response analysis, 297  
 symbolic data, CAN, 398  
 symbolic data, LIN, 409  
 sync pulse, waveform generator, 312

## T

Tablet Remote Front Panel, 364  
 template, front panel, 44  
 test, mask, 275  
 Thai front panel overlays, 45  
 Thai user interface and Quick Help, 62  
 theory, sampling, 217  
 threshold, analog channel measurements, 270  
 threshold, digital channels, 138  
 thumb drive, 43  
 tilt for viewing, 30  
 time measurements, 257  
 time reference indicator, 73  
 time, re-arm, 231  
 timebase, 67  
 times for saving data, 327  
 timing logic bus chart, 124  
 Tools keys, 42  
 Top measurement, 251  
 total harmonic distortion (THD) FFT analysis measurement, 269  
 totalize counter, 292  
 totalizer, ARINC 429, 494

totalizer, CAN, 404  
 totalizer, FlexRay, 433  
 totalizer, UART/rs232, 517  
 Touch key, 39, 45  
 tracking cursors, 234  
 Traditional Chinese front panel overlays, 45  
 Traditional Chinese user interface and Quick Help, 62  
 training signals, 43  
 transforms, math, 104  
 Transparent backgrounds, 347  
 TRIG OUT connector, 59, 350  
 TRIG OUT signal and zone qualified trigger, 206  
 Trig'd trigger indicator, 209  
 Trig'd? trigger indicator, 209  
 Trigger controls, 39  
 trigger coupling, 209  
 trigger indicator, Auto?, 209  
 trigger indicator, Trig'd, 209  
 trigger indicator, Trig'd?, 209  
 trigger level, 170  
 trigger mode, auto or normal, 208  
 trigger mode, Quick Trigger Mode, 358  
 trigger output, 350  
 trigger output, mask test, 279, 350  
 trigger qualified event signal, counting, 292  
 trigger signal, raw, 351  
 trigger type, ARINC 429, 489  
 trigger type, CAN, 399  
 trigger type, CXPI, 418  
 trigger type, edge, 172  
 trigger type, edge then edge, 174  
 trigger type, FlexRay, 428  
 trigger type, glitch, 175  
 trigger type, hex bus, 180  
 trigger type, I2C, 438  
 trigger type, I2S, 458  
 trigger type, LIN, 409  
 trigger type, Manchester, 468  
 trigger type, MIL-STD-1553, 483  
 trigger type, NFC, 183  
 trigger type, NRZ, 475  
 trigger type, Nth edge burst, 186  
 trigger type, OR, 181  
 trigger type, pattern, 178  
 trigger type, pulse width, 175

trigger type, rise/fall time, 182  
 trigger type, RS232, 513  
 trigger type, runt, 188  
 trigger type, SENT, 502  
 trigger type, setup and hold, 190  
 trigger type, slope, 172  
 trigger type, SPI, 449  
 trigger type, UART, 513  
 trigger type, video, 191  
 trigger types, 169  
 trigger, definition, 170  
 trigger, external, 213  
 trigger, forcing a, 171  
 trigger, general information, 170  
 trigger, holdoff, 212  
 trigger, mode/coupling, 207  
 trigger, source, 172  
 trigger, zone qualified, 204  
 triggers, TRIG OUT signal, 350  
 TTL threshold, 139  
 Turkish front panel overlays, 45  
 Turkish user interface, 62  
 turn channel on, 42

## U

UART totalizer, 517  
 UART trigger, 513  
 UART/RS232 frame counter, 517  
 UART/RS232 license, 379  
 UART/RS232 serial decode, 515  
 under-sampled signals, 217  
 units, cursor, 236  
 units, external trigger probe, 213  
 units, math, 101  
 units, probe, 85  
 updating software and firmware, 380  
 upgrade files, 371  
 upgrade options, 379  
 upgrading the oscilloscope, 380  
 upload new firmware, 359  
 usb, 346  
 USB device port, 59  
 USB device port, remote control, 341  
 USB host port, 59, 335  
 USB host ports, 43  
 USB printer, 335  
 USB printers, supported, 335  
 USB storage device, 43



USB, CD device, [346](#)  
 USB, eject device, [43](#)  
 USB, storage device numbering, [346](#)  
 usb2, [346](#)  
 user cal, [352](#)  
 user calibration, [352](#)  
 user interface language, [62](#)  
 User-defined threshold, [139](#)  
 utilities, [341](#)  
 Utility key, [42](#)

## V

V RMS, FFT vertical units, [91](#), [110](#)  
 values, choosing, [39](#)  
 variable persistence, [157](#)  
 ventilation requirements, [31](#)  
 Vertical controls, [42](#)  
 vertical expansion, [81](#)  
 vertical offset, [81](#)  
 vertical position, [81](#)  
 vertical position knobs, [42](#)  
 vertical scale knobs, [42](#)  
 vertical sensitivity, [42](#), [81](#)  
 Vertical Units, FFT, [91](#), [110](#)  
 VGA video output, [59](#)  
 VID license, [380](#)  
 video trigger, [191](#)  
 video trigger, custom Generic, [195](#)  
 viewing, tilt the instrument, [30](#)  
 VISA connect string, [359](#)  
 visualizations, math, [121](#)  
 voltage measurements, [250](#)

## W

warranted specifications, [375](#)  
 warranty, [2](#), [356](#)  
 Wave Gen key, [42](#), [44](#)  
 waveform generator, [301](#)  
 waveform generator amplitude,  
   frequency response analysis, [297](#)  
 waveform generator defaults,  
   restoring, [318](#)  
 waveform generator expected output  
   load, [312](#)  
 waveform generator logic presets, [313](#)  
 waveform generator sync pulse, [312](#)

waveform generator sync pulse, TRIG  
   OUT signal, [350](#)  
 waveform generator, arbitrary  
   waveforms, [305](#)  
 waveform generator, waveform  
   type, [301](#)  
 Waveform keys, [39](#)  
 waveform type, waveform  
   generator, [301](#)  
 waveform, cursor tracking, [234](#)  
 waveform, intensity, [155](#)  
 waveform, printing, [335](#)  
 waveform, reference point, [347](#)  
 waveform, saving/exporting, [321](#)  
 WAVEGEN license, [380](#)  
 web interface, [359](#)  
 web interface, accessing, [360](#)  
 white noise, adding to waveform  
   generator output, [313](#)  
 Width - measurement, [260](#)  
 Width + measurement, [260](#)  
 Window, FFT, [90](#), [110](#)

## X

X at Max Y measurement, [264](#)  
 X at Max Y on FFT, [248](#)  
 X at Min Y measurement, [264](#)  
 X at Min Y on FFT, [248](#)  
 XY mode, [67](#), [68](#)

## Z

Z-axis blanking, [70](#)  
 zero phase reference, FFT (Phase), [111](#)  
 zone qualified trigger, [204](#)  
 zoom and pan, [64](#)  
 zoom display measurement  
   window, [272](#)  
 Zoom key, [40](#)

Test Equipment Depot - 800.517.8431 - 99 Washington Street Melrose, MA 02176  
TestEquipmentDepot.com