

# ***Pro'sKit***<sup>®</sup>

## **MT-4617 Light Intensity Meter**



**User's Manual**

1<sup>st</sup> Edition, 2015

©2015 Prokit's Industries Co., Ltd

## **Introduction**

Thank you for your purchase of the MT-4617 Light Intensity Meter designed and manufactured by our company. This meter will with proper use, provide years of reliable service; therefore, it is recommended that the user read carefully the user manual before using the light meter and keep it in right place for reference.

## **Open-package inspection**

Upon receipt of the light meter, inspect it to ensure no damage happened during shipping. If the user finds obvious damage or malfunction in operation, please contact the supplier.

## **Safety information**





Warning

Do not use the light meter in the environment full of dusts or having gas substances and flammable steam substances!



## **Safety mark description**

This manual contains basic information for MT-4617 safety operation and maintenance. Please read carefully following safety information before use.

**Table 1: Safety information**

	Important information which the user must read before using the light meter
	Mark of conformity

**Table 2: Warning message**

 <b>Warning</b>	It indicates that incorrect operation will lead to serious injury or even fatal accidents
 <b>Notice</b>	It indicates that incorrect operation negligence will lead to meter damage wrong measurement results, etc.
 <b>Tips</b>	Operation suggestions or prompts



### Operation considerations

User should observe the following notices to guarantee safe operation and obtain optimum performance.





#### **Preliminary check**

Before initial use, please check if the light meter operates normally and if it is damaged during storage and transportation. In case of any damage, please contact the supplier.

#### **Placement**

Operation environment	-10~50°C (14~122°F) <80%RH(non-condensed)
Storage environment	-10~+50°C (14~122°F) <70%RH(non-condensed)

To avoid faults, please DO NOT place the light meter in following environments:

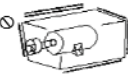
	Direct sunlight High temperature		Corrosive or explosive gas
	Mist /splash High temperature/condensation		Intensive electromagnetic environment
	Dust		Mechanical vibration



### Notice

1. The operation temperature range for the light meter is  $-10-50^{\circ}\text{C}$  ( $14-122^{\circ}\text{F}$ ).
2. In order to avoid damage, especially falling accidents, handling and use should be avoided during severe mechanical vibration.
3. The light meter can only be calibrated and repaired by professional personnel.
4. Before each use, the opto-sensor of light meter should be checked for damage and dust. Make sure the meter is in good, smooth and clean condition. If one or more functions of the light meter are irregular or not ready for operation, avoid using the meter.
5. During the operation of the light meter, the meter

- measurement value should not be at OL for a long time.
6. Keep the meter out of direct sunlight to guarantee its normal operation and long-term service life.
  7. If the meter is subject to effect of intensive electromagnetic field, its functions will be affected.
  8. Only use batteries specified in technical data.
  9. Batteries should avoid dampness. If the low battery symbol appears on the display, the user should replace batteries.



### **Tips**

1. The sensitivity of the optical detector will be lessened due to operation conditions or time. It is recommended to make periodic calibration to maintain the basic accuracy.
2. Please keep original package for future mailing (such as for light meter calibration).

## **Introduction**

### **Product description**

Whether you are a professional or amateur photographer, while shooting, you pay more attention to the surrounding illuminance rather than the setting, because this will help you take the best shot. Although the illuminance can be estimated by the photographer, there is a difference in perception between human and camera about the requirement for supplementing illuminance. This

difference will lead to a big contrast of the expected image effect against the actual one. In the face of this, do you wish to possess a light meter? When you intend to buy a house, you require both good location and indoor brightness during the day. So, do you wish to possess a light meter to measure the illuminance in every corner of the house?

With the progress of human civilization, more and more people emphasize low carbon life. Architects tend to figure out how to bring more natural light into the house while putting up a residential building. However, in many cases, fluorescent lights will be used when the natural light is not enough. In response to the slogan of energy saving and emission reduction advocated by the state, we should use the fluorescent lamps based on the actual needs. So, a professional and convenient light meter can provide you with a reference regarding illuminance.

The MT-4617 Light Intensity Meter has a friendly human-machine interface and can be activated by a simple press of keys. The buzzer activates upon key press to notify that it is effective. This light meter is able to measure the visible light produced by fluorescent lamp, metal-halide lamp, high voltage sodium lamp or electric incandescent lamp for a vivid and intuitive image display.

## **Outstanding features of the MT-4617 multi-function light meter**

- ◆ Automatic and manual range switching;
- ◆ Inquiry function for maximum and minimum values;
- ◆ Data hold function;
- ◆ Peak value measurement function;
- ◆ Relative value measurement function;
- ◆ Zero calibration function;
- ◆ 3 1/2 bit LCD display, with analog bar display;
- ◆ Fc/Lux unit conversion function;
- ◆ Outrange indication (When the measured value exceeds the current range, LCD will display the signal "OL" to indicate that the range is overreached);
- ◆ High precision. Measurement range (0.00~200000Lux);
- ◆ Low battery indicator;
- ◆ Key tone and mute selection;
- ◆ Auto power-off function (The machine will be powered off automatically keys are not operated for more than 10 minutes)
- ◆ Compact design, durable, and portable.

## **Name and function of components**

### **Plan view**

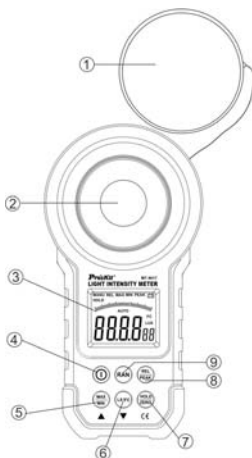

1. Opto-sensor protection cover
2. Opto-sensor
3. LCD display screen
4. Compound key for main power and touch tone:  
 Power on/off: Short press the key to activate the instrument and long press for 1 second to shut it down.  
 Touch tone on/off: Under working mode short press the key to turn the touch tone on and off. Default is key with tone.
5. max and min values inquiry key
6. Lux/Fc unit conversion key
7. Compound key for data hold and zero calibration:  
 Data hold: Short press the key to enter/exit data hold mode.



Zero calibration: Long press for 1 second to perform Zero calibration function.

8. Compound key for relative value and peak value measurement:

Relative value measurement: Short press the key to enter/exit relative value measurement mode.

Peak value measurement: Long press for 1 second to enter/exit peak value measurement mode.

9. Key for manual range switching: Short press the key for 20.00Lux → 200.0Lux → 2000Lux → 20000Lux → 200000Lux (or 20.00Fc → 200.0Fc → 2000Fc → 20000Fc) circulation; Long press for 1 second to exit manual range switching mode.

### LCD display interface



1. Prompt for manual range switching mode
2. Prompt for data hold mode
3. The analog bar shows the current measurement value information.
4. The digit shows the current measurement value information.

5. Lux unit
6. FC unit
7. Prompt for auto measurement mode
8. Prompt for peak value measurement mode
9. Prompt for low battery
10. Prompt for relative value measurement mode
11. Prompt for max and min values inquiry

## 2 Measurement methods

### Notices prior to measurement



#### Warning

- 1: Do not use the light meter in environments full of dusts or having gas substances and flammable steam substances!
- 2: Do not use the light meter for measurement in the place with high temperature and high humidity.
- 3: Do not use the light meter in environments with intense infrared or ultraviolet rays!



#### Tips

- 1: The opto-sensor of this meter is designed by simulating the sensitive curve of light obtained through human eyes. The spectral coverage is between 320nm and 730nm. When it is used for measurement within the infrared range, there will be a large data deviation.
- 2: The opto-sensor is calibrated by common electric incandescent lamp required by CIE under the color temperature of 2854°K; the provided reading number

may be different for the spectrum of other lamps.

- 3: The reference level of light source test is at the top of the spherical surface illuminated.
- 4: The optical detector should be exposed to light for 2 minutes before measurement.
- 5: Influence of tester's shadow and other factors on the optical detector should be avoided.

### **Action principles**

Concepts of illuminance scales

One lux (lumen) indicates the illuminance from a surface of one square meter, all points of which are one meter from a uniform source of one candela.

One foot-candle (Fc) indicates the illuminance from a surface of one square foot, all points of which are one foot from a uniform source of one candela.

### **Unit conversion for illuminance scales**

1 Fc = 10.764 Lux

1 Lux = 0.09290 Fc

### **Conversion formula for illuminance and light intensity**

$$E = I / r^2$$

Wherein E --- illumination value (Unit: Lux);

I --- Light intensity of the light source (Unit: cd);

r --- Distance from the luminous surface of light source to the optical detector (Unit: m) .

During the measurement, the minimum distance between the luminous surface of light source and the opto-sensor

should be more than 15 times greater than maximum size of the luminous surface (or opto-sensor).

### **Typical practice cases**

Remove the protection cover of the MT-4617 multi-functional light meter sensor and place it at right angle to the light source.

Press and hold the MT-4617 power key ④ for a short time to power on the light meter. The LCD screen will illuminate (about 5 seconds) with the buzzer beeping twice, and “AUTO” will appear on the middle of LCD display. This indicates that the auto measurement mode is ON.

Press and hold the manual range switching key ⑨ of the MT-4617 for a short time, “MANU” will appear on the top left position of the LCD display, indicating that the manual range switching mode has been activated. In this mode, each time press and hold the key for a short time, the meter will switch to 20.00Lux—>200.0Lux—>2000Lux—>20000Lux—>200000Lux (or 20.00Fc—>200.0 Fc—>2000 Fc—>20000 Fc) in sequence; pressing the key for one second will result in the inscription “MANU” disappearing from top left position of LCD display, replaced by “AUTO” appearing in the middle, to indicate that the meter has switched the manual range switching mode to the auto range switchover.

Press and hold the REL/PEAK key ⑧ of the MT-4617 for a short time, “REL” will appear on the top left position of the LCD interface, indicating the activation of the relative value measurement mode. Press and hold the key ⑧ for a short

time again, the device will exit the relative value measurement mode and return to the original measurement mode, and “REL” on the top left position of the LCD interface will disappear; pressing the key for one second will lead to the peak measurement mode, “PEAK” and “MANU” will appear on top right position of LCD display; press and hold the key for one second once again, “PEAK” will disappear from the top right position of the LCD interface, and “AUTO” will appear in the middle of LCD, and the mode will return to auto measurement mode.

Press and hold max/min value inquiry key ⑤ for a short time, “MAX” will appear on top position of LCD interface, switching the device to the max/min value inquiry mode; in this mode, each short press of the key causes the mode to change from MAX to MIN or from MIN to MAX; press and hold the “MAX/MIN” key ⑤ for one second, “MAX/MIN” on top position of the LCD interface will disappear, and the mode will exit. Press and hold the data hold/zero calibration key ⑦ of the MT-4617 for a short time to enter the data hold mode, which will be indicated by the apparition of “HOLD” on the top left position of the LCD interface; press and hold the key for a short time once again, “HOLD” will disappear from the top left position of the LCD interface, and the device will exit the data hold mode.

In any mode with sensor covered, press and hold data hold/zero calibration key ⑦ for one second, “ADJ” will appear on the LCD interface, and the device will enter the zero calibration mode: several seconds later “ADJ” will

disappear from the LCD interface, and the device will exit the data hold mode and return to auto measurement mode.

### **Tips**

- 1: The reference position of light source test is at top of sphere surface under light.
- 2: In various measurement modes, analog bar in the middle of the LCD screen will change with figures of Nixie tubes.
- 3: When reading, existing data can be locked by pressing and holding “HOLD/ZERO” key for a short time;
- 4: In zero calibration mode, the opto-sensor must be covered by opto-sensor visor before calibration.
- 5: After completing the test, the sensor protection cover should be put back to protect light filter and sensor.

### **Specific Application**

#### **Application of manual switchover of range measurement mode**

- Press and hold the RAN key (range manual switchover key) for a short time, “MANU” will appear on the top left position of the LCD interface, and the meter will enter the manual switchover measurement mode (as shown in figure 3-1-1);
- When entering manual switchover of range function, press RAN key for a short time each time, it will switch to 20.00Lux—>200.0Lux—>2000Lux—>20000Lux—>200000Lux (or 20.00Fc—>200.0 Fc—>2000 Fc—>20000 Fc) in sequence;
- Press and hold RAN key for one second, “MANU” on the

top left position of the LCD interface will disappear, and “AUTO” will appear in middle of LCD interface, and manual range switchover function will exit and the device will return to auto range switchover mode;

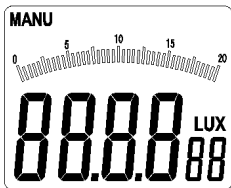
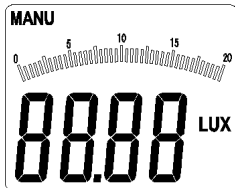
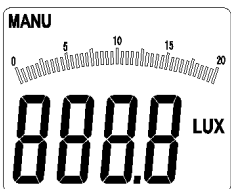

Figure 3-1-1



20.00Lux interface



200.0Lux interface

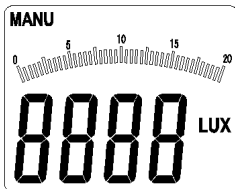

2000Lux interface

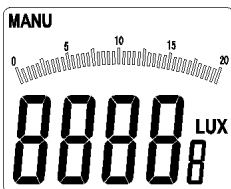

20000Lux interface

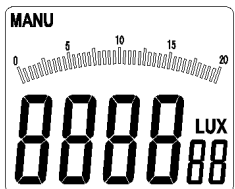

200000Lux



interface

Tips

- 1: Only in peak value measurement mode, relative value measurement mode and max/min value inquiry mode, will it be effective to press RAN key for a short time.
- 2: In relative value measurement mode and max/min value inquiry mode, press and hold the key for one second, it will return to auto switchover of range.
- 3: In peak value measurement mode, data hold mode and zero calibration modes, it will be effective to press and hold RAN key for a long time.
- 4: In this mode, when measurement value exceeds present range, "OL" will appear on LCD interface to indicate over-range, and the user should switch over the measurement range at this time.

### **Application of relative/peak value measurement mode**

- Press and hold REL/PEAK key for a short time (composite key for relative/peak value measurement), "REL" will appear on the top left position of the LCD interface (as shown in figure 3-1-2A), and the device will enter the relative value measurement mode;
- Press and hold REL/PEAK key for a short time again, "REL" on the top left position of the LCD interface will disappear, and the device will exit the relative value measurement mode and return to original measurement mode;
- Press and hold "REL/PEAK" key for one second, the device will enter the peak value measurement mode, "PEAK" LCD will appear on the top right position of the LCD interface, and at the same time, "MENU" will



appear on the top left position of the LCD interface (as shown in figure 3-1-2B);

- Press and hold the key once again for one second, “PEAK” on top right position of LCD interface will disappear, and “AUTO” will appear on the middle of LCD interface, and the device will exit the peak value measurement mode and return to auto measurement mode (as shown in 3-1-2C).

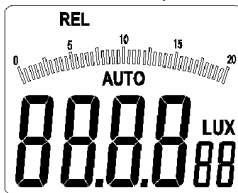

Figure 3-1-2A

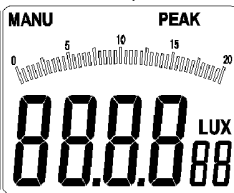

Figure 3-1-2B

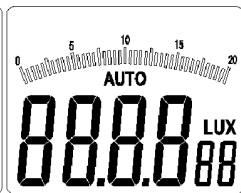

Figure 3-1-2C

### Tip

- 1: Only in auto measurement mode, peak value measurement mode, max/min value inquiry mode and data hold mode, it will be effective to press and hold REL/PEAK key for a short time.
- 2: In non-zero calibration mode, press and hold “REL/PEAK” for one second, the device will enter the peak value measurement mode.

### Application of maximum/minimum value inquiry mode

- Press and hold “MAX/MIN” key for a short time, “MAX” will appear on top LCD interface (as shown in figure 3-1-3);

- In max/min value inquiry mode, press “MAX/MIN” key once, you will switch MAX to MIN or MIN to MAX;
- Press and hold “MAX/MIN” for one second, “MAX/MIN” on top LCD interface will disappear, and the max/min value inquiry mode will exit.

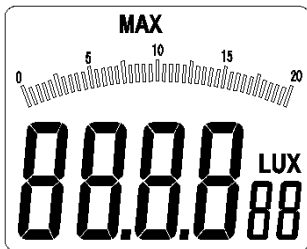

Figure 3-1-3

### Tips

In non-zero calibration mode, press and hold “MAX/MIN” key for a short time to use the max/min value inquiry functions;

### Application of data hold and zero calibration mode

- Press and hold “HOLD/ZERO” key for a short time, “HOLD” will appear on the top left position of the LCD interface (as shown in 3-1-4A), then the device will enter the data hold mode;
- Press and hold the key again, “HOLD” on the top left position of the LCD interface will disappear, and the meter will exit the data hold mode;
- Cover the opto-sensor with the visor, and press and hold “HOLD/ZERO” key for one second, “ADJ” will

appear on LCD interface (as shown in figure 3-1-4B), then the device will enter the zero calibration mode. Several seconds later, “ADJ” on LCD interface will disappear, and zero calibration mode will automatically exit and return to auto measurement mode.

## Notice

Before zero calibration, the opto-sensor must be covered with the opto-sensor visor.

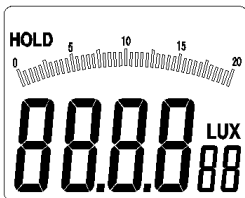

Figure 3-1-4A



Figure 3-1-4B

## Tips

1. In non-zero calibration mode, press and hold “HOLD/ZERO” key for a short time to enter the data hold mode.
2. Zero-calibration can be made in any mode.

## Other Functions

### Auto power-off

If there is no action on keys of the MT-4617 for a long time, the meter will automatically power off about 10 minutes later.

### Technical Data

- Temperature range:

Operation: -10~50°C, max 80 % HR ( Non-Condensed )  
Storage: -10~50°C , max 80 % HR (Non-Condensed)  
(removing batteries)

- Sampling rate:  $\geq 2$  times/s
- Display: 3½ digits, max reading of 1999, with analog bar display;
- Sensor: silicon photoelectric diode
- Measured spectral range: 320~730nm
- Measurement ranges: 20, 200, 2000, 20000, 200000  
Lux20, 200, 2000, 20000 FC
- Operating environment: indoor use
- Height: 2000m highest
- Battery life: Approx. 200 hours
- Power supply: 1×9 V , IEC 6LR61
- Dimensions (H×W×D): 170 mm×85 mm×45 mm
- Accuracy:  $\pm 3\%$  (calibrated with incandescent lamps in 2854K)  $\pm 6\%$  other visible light source

Cosine angle deviation characteristics	
Cosine angle	Deviations
30°	$\pm 2\%$
60°	$\pm 6\%$

Tips: cosine angle is corrected in accordance with JIS C 1609:1993 and CNS 5119 Grade A General Specification.

- Luminous sensitivity characteristics:

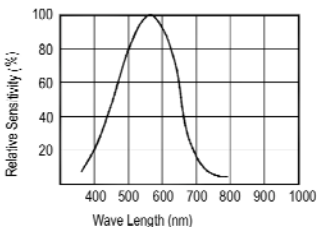

## Maintenance and Service

### Service



#### Notice

When the meter seemingly fails during operation, following steps should be followed to check the fault problem:

- 1: Check batteries. If “” appears on the LCD display, batteries should be replaced.
- 2: Repair on the meter should be performed by service centers or other qualified service professionals.

### Cleaning

First wipe the meter with a damp soft cloth with clean water or neutral detergent and then with a dry cloth.



#### Notice

- 1: Please make sure the light meter is turned off before cleaning.
- 2: Do not use benzene, alcohol, acetone, ethyl ether, ketones, thinners and gasoline, etc. in cleaning, because

they will transform or fade the light meter.

- 3: The light meter can only be used again when it is completely dry after cleaning.

## **Battery replacement**

If the battery symbol appears on the LCD accompanied by buzzer alarm, batteries must be replaced.

Batteries should be replaced as follow:

- Turn off the meter;
- Remove the screw on the back of the meter and open the battery compartment;
- Remove exhausted batteries;
- Replace new batteries observing polarity;
- Replace the battery compartment cover and secure the compartment screw.



### **Warning**

- 1: Do pay attention to the right polarity of battery when putting in or replacing batteries. In case of polarity reversal, the light meter will be damaged, and can even cause explosion or fire.
- 2: Never connect one polarity of the battery to the other one with wire, nor throw batteries into fire, or it will cause an explosion.
- 3: Do not attempt to dismantle the battery! The battery's intensively alkaline electrolyte is corrosive and endangers the user. In case of contact of the electrolyte with skin or clothes, immediately rinse touched parts with clean water; in case of contact of the electrolyte with eyes, immediately rinse eyes with clean water and seek medical advice.



## Notice

- 1: The light meter should be turned off before replacing batteries.
- 2: Use batteries specified in technical data only.
- 3: If the meter is not to be used for a long time, take out the batteries. In case the meter is polluted due to battery leak, the meter should be sent by post to the manufacturer for cleaning and checking.
- 4: For disposal of used batteries, follow existing specifications on battery recycling, reuse and treatment.

## Reference Table for Illumination Standard of Various locations Fc illuminance value can be obtained from Lux illumination value divided by 10.764

Schools:

Illuminance (Lux)	Locations
1500~300	Drafting classroom, sewing classroom, computer classroom
750~200	Classroom, laboratory, practice workshop, research room, reading room, stack room, office, staff lounge, conference room, health center, restaurant, kitchen, pantry, radio room, printing room, switchboard room, guard room, indoor stadium
300~150	Large classroom, auditorium, storage cabinet room, lounge, staircase
150~75	Corridor, elevator corridor, toilet, duty room, workers room, bridge, school outdoor

	playground
75~30	Warehouse, garage, fire escape

Office:

Iluminance (Lux)	Locations
2000~1500	Design office, clerk's office
1500~750	Hall information channel (daytime), parlor, drawing office, punching, typing
750~300	Calculator room, conference room, printing room, switchboard room, control room, reception room, recreation room, restaurant
300~150	Stack room, entertainment room, dining room, lounge, guard room, elevator (passway), washroom, toilet
150~75	Tea room, changing room, warehouse, nightwatchmen office (entrance)
75~30	Fire escape

Factories:

Iluminance (Lux)	Locations
3000~1500	Ultra-precision operation, design, drafting, precision inspection
1500~750	Design office, analysis, assemble line, coating
750~300	Packaging, measurement, surface treatment, warehouse office
300~150	Dyeing, casting, electrical room



150~75	Entrance and exit, corridor, information channel, staircase, dressing room, toilet, operation warehouse
75~30	Fire escape, warehouse, outdoor power equipment (loading and unloading, inventory move operation)

Hospital:

Illuminance (Lux)	Locations
10000~5000	Visual function test chamber (ophthalmology lightroom)
1500~750	Operating room
750~300	Consulting room, treatment room, pharmacy room, prescription room, drug store, dissection room, pathological bacteria room, emergency rooms, maternity ward, dean's office, offices, nursing room, conference room
300~150	Ward, medicine room, bed reading, medicine changing, plaster bandage for fractures, infant room, record room, waiting room, consulting room, outpatient corridor
150~75	Locker room, physical therapy room, X-ray room, ward corridor, medicine room, sterilization room, ward room, stairs, endoscopy room
75~30	Animal room, dark room (photo), fire escape

Hair salon:

Iluminance (Lux)	Locations
1500~750	Haircut, perm, hair dyeing, cosmetics
750~300	Shave, hairdressing, lobby registration counter, makeup
300~150	Toilet in salon
150~75	Corridor, stairways

Hotel, restaurant, recreation ground:

Iluminance (Lux)	Locations
1500~750	Counter
750~300	Halfway, banquet hall, business room, parking lot, kitchen
300~150	Restaurant, toilet, a large Japanese-style room
150~75	Recreation room, corridor, stairways, guest room, bathroom, accent lighting for gardens, changing room
75~30	Fire escape

Shop, department store:

Iluminance (Lux)	Locations
3000~750	Indoor display, decorative window display, demonstration area, checkout counter, packaging table
750~300	Elevator lobby, escalators

300~150	Discussion room, dressing room, toilet, stairs, walkways
150~75	Lounge, general lighting in store

House:

Illuminance (Lux)	Locations
2000~750	Handcraft, tailoring
1000~500	Writing, work
750~300	Reading, makeup, kitchen table, processing area, telephone
300~150	Wash sink, entertainment room, living room, family reunion, entrance (inside) mirror
150~70	Wardrobe, bedroom, bathroom, stairs, corridor
75~30	Doorplate, mailbox, doorbell key, terrace

# MT-4617 照度計 使用說明書

## 聲明

根據國際版權法，未經允許和書面同意，不得以任何形式複製本說明書的任何內容。

本說明書在將來的版本中如有更改，恕不另行通知。

## 安全聲明

 小心或注意

“小心”或“注意”標誌表示會對儀錶或設備造成損壞的狀況和操作。

它要求在執行此操作時必須小心，如果不正確執行此操作或不遵循此操作步驟，則可能導致儀錶或設備損壞。在不滿足這些條件或沒有完全理解的情況下，請勿繼續執行小心標誌所指示的任何操作。

 警告

“警告”標誌表示會對用戶造成危險的狀況和操作。

它要求在執行此操作時必須注意，如果不正確執行此操作或不遵守此操作步驟，則可能導致人身傷害或傷亡。在不滿足這些條件或沒有完全理解的情況下，請勿繼續執行警告標誌所指示的任何操作。

## 安全資訊

### 警告

請勿在存在爆炸性氣體物質、可燃蒸汽物質及充滿粉塵的環境中使用本儀錶！

## 安全符號說明

本說明書包含安全操作和維護的基本要素。使用前，請仔細閱讀下面的安全資訊。

表 1：安全資訊





	用戶在使用前必須閱讀的重要資訊
	符合歐盟 CE 安全規範

表 2：警告資訊

 警告	表明錯誤的操作將導致嚴重的傷害甚至死亡事故發生
 注意	表明錯誤的操作或疏忽將導致儀錶損壞或測量結果錯誤等
 提示	操作建議或提示

## 操作注意事項

遵從以下注意事項，確保安全操作和獲得最佳的性能。

1. 首次使用前，請檢查照度計是否工作正常，確認在存儲和運輸期間沒有受到損壞。
2. 使用環境：溫度-10°C~50°C；濕度<80%RH（無凝露）
3. 存放環境：溫度-10°C~50°C；濕度<70%RH（無凝露）
4. 為避免故障，請不要使照度計處於高溫或高濕、腐蝕性或爆炸性氣體、強電磁或強振動、粉塵的環境。
5. 為避免損壞，搬運及使用過程中應避免劇烈機械振動，尤其避免發生跌落事故。

6. 只有專業人員才能對本照度計進行校準和維修。
7. 在每次使用前，都要檢查照度計的光感測器有無磨損、有無粉塵。請確保照度計的光感測器是處於光滑完好、潔淨的狀態。如果照度計的一個或多個功能不正常或沒有為工作準備就緒，則不得使用照度計進行測量工作。
8. 在使用照度計時，不能長期使儀錶測量值處於溢出狀態（OL）。
9. 要避免日光暴曬。只有這樣才能保證儀錶的功能正常和長久的使用壽命。
10. 如果儀錶受到極強電磁場的作用，則其功能會受影響。
11. 電池注意避免受潮。若顯示幕顯示電池欠壓提示符，則必須更換電池，只允許使用技術資料中指定電池型號。
12. 光檢測器的靈敏度會因使用條件或時間而降低。建議您將儀錶做定期校正，以保證精確度。
13. 請您妥善保管原始包裝，以便今後郵寄之用（如對照度計校準時）。

## 概述

如果您是一個專業攝影師或者是一個業餘攝影愛好者，您在攝影時想要抓到完美的鏡頭，那麼您要考慮的不僅僅是場景，更要注重周圍的光照度，雖然人眼可以大概的估算光的亮度，但是攝影機對光亮度的補償要求是存在差異的，這會導致實際照出來的圖片與預計的效果形成較大的反差。此時您是否渴望擁有一個測量光照度的儀器？當您在購置新房時，您不但要求地理位置好，而且要求白天時室內要明亮，此時您是否也渴望擁有一個測量光照度的儀器探測室內的各個角落的光照度？

多功能照度計的人機介面十分友好，按鍵操作便捷，顯示效果直觀形象，可測量螢光燈、金屬鹵化燈、高壓鈉燈或白熾燈等光源發出的可見光。

## 功能特點

1. 自動和手動切換量程；
2. 最大、最小值查詢功能；
3. 資料保持功能；
4. 峰值測量功能；
5. 相對值測量功能；
6. 零點校準功能；
7. 3 1/2 位元 LCD 顯示，帶類比條顯示
8. 單位轉換功能 Fc/Lux
9. 超量程顯示“OL”，提示超量程；
10. 精度高，測量範圍寬（0.00~200000Lux）；
11. 電池欠壓指示；
12. 按鍵音和靜音選擇；
13. 自動關機功能(超過 10 分鐘無按鍵操作即自動關閉電源)
14. 結構緊湊，牢固耐用，便於攜帶

## 儀錶面板說明

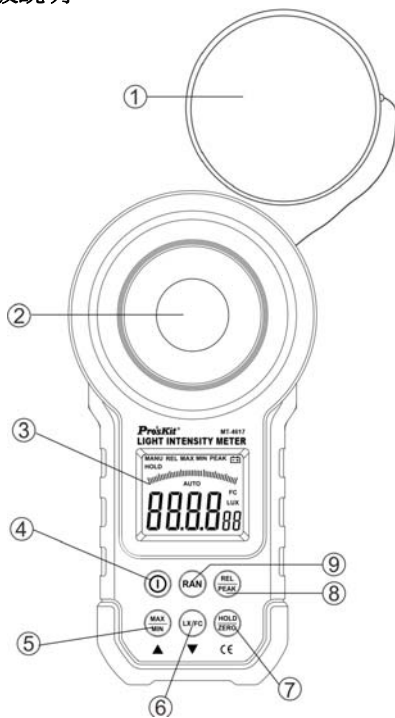

- ① 光感測器保護蓋
- ② 光感測器
- ③ LCD 顯示幕



④ 電源、按鍵音複合按鈕：

開/關電源：短按開機，長按 1S 關機；

開啟/關閉按鍵音：工作模式，短按開啟/關閉按鍵音，開機默認有按鍵音。

⑤ 最大最小值查詢模式按鈕。

⑥ 單位轉換按鈕：

勒克司/英尺燭光(Lux/ Fc)

⑦ 資料保持、零點校準複合按鈕：

資料保持：短按，進入/退出資料保持模式

零點校準：長按 1S，執行零點校準功能

⑧ 相對值測量、峰值測量複合按鈕：

相對值測量：短按，進入/退出相對值測量模式

峰值測量：長按 1S，進入/退出峰值測量模式

⑨ 手動切換量程按鈕：

短按，進入手動量程狀態，按一下跳到下一量程。

長按超過 1 秒，則退出手動量程模式。

## LCD 顯示介面

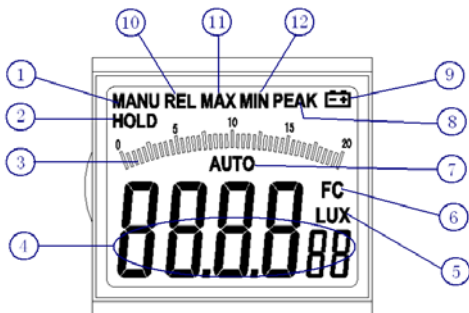

1. 手動切換量程模式提示符號
2. 資料保持模式提示符號
3. 類比條顯示當前測量值資訊
4. 數位顯示當前測量值資訊
5. Lux 單位符號
6. Fc 單位符號
7. 自動測量模式提示符號
8. 峰值測量模式提示符號
9. 電池電壓低電提示符號
10. 相對值測量模式提示符號
11. 最大值查詢模式提示符號
12. 最小值查詢模式提示符號

## 測量方法

### 測量前的注意事項

#### 警告

- 1：請勿在存在爆炸性氣體物質、可燃蒸汽物質及充滿粉塵的環境中使用本儀錶！
- 2：請勿在高溫、高濕場所下測量。
- 3：請勿在強紅外線或紫線環境中使用本儀錶！



#### 提示

1. 本儀器光感測器類比人眼對光的敏感曲線而設計，光譜範圍為 320~730nm。若處於紅外線區域測量，則資料將偏差較大。
2. 光感測器在 2854 °K 色溫條件下依照 CIE 普通白熾燈進行校準；對其他類燈的光譜，所提供的讀數可能不同。
3. 光源測試參考准位在受光球面正頂端。
4. 測量前使光檢測器曝光 2 分鐘後，方可開始測量。
5. 要防止測試者的人影和其他因素對光檢測器的影響。

### 作用原理

#### 各照度標度的概念

1 勒克司(流明)是與光強為一燭光的燈垂直距離 1 米處，面積為 1 平方米的表面上接受的照度。

1 英尺燭光 (Fc) 是與光強為一燭光的燈垂直距離 1 英尺處，面積為 1 平方英尺的表面上接受的照度。

#### 照度標度單位轉換：

1 Fc = 10.764 Lux；

1 Lux = 0.09290 Fc。

光照度與發光強度的換算公式： $E = I / r^2$

式中：E --- 光照度值(單位：Lux)；

I --- 光源的發光強度(單位：cd)；

r --- 光源發光面到光檢測器之間的距離(單位：m)。

測定時，要求光源發光面和光感測器之間的最小距離應大於光源發光面(或光感測器)最大尺寸的 15 倍。

### 典型練習實例

站在某一光源下，取下多功能照度計感測器保護蓋並將它與光源垂直放置。

短按電源鍵開機，此時 LCD 屏全顯(約 1S)，同時蜂鳴器鳴響兩聲，LCD 屏正中間顯示“AUTO”字樣，儀器進入自動測量模式。短按手動切換量程 RAN 鍵，LCD 左上方顯示“MANU”字樣進入手動切換量程模式，進入手動切換量程功能後每次短按該鍵，則按 20.00Lux—>200.0Lux—>2000Lux—>20000Lux—>200000Lux(或 20.00Fc—>200.0 Fc—>2000 Fc—>20000 Fc)迴圈；長按該鍵 1 秒，LCD 左上方的“MANU”字樣熄滅，LCD 正中間顯示“AUTO”字樣，退出手動切換量程功能，返回自動切換量程。短按相對值測量、峰值測量 REL/PEAK 複合鍵，LCD 介面左上方顯示“REL”字樣，進入相對值測量模式，再次短按該鍵則退出相對值測量模式，LCD 介面左上方“REL”字樣熄滅，返回原來的測量模式；長按相對值測量、峰值測量複合鍵 1 秒，進入峰值測量模式，LCD 介面右上方顯示“PEAK”和“MANU”字樣，再次長按該鍵 1 秒，LCD 右上方的“PEAK”字樣熄滅，LCD 正中間顯示“AUTO”字樣，

返回自動測量模式。短按最大最小值查詢 **MAX/MIN** 鍵，LCD 介面正上方顯示“MAX”字樣，進入最大最小值查詢模式，最大最小值查詢模式下，每次短按該鍵，則按 **MAX<—>MIN** 迴圈切換；長按“MAX/MIN”鍵 1 秒，LCD 介面正上方的“MAX/MIN”字樣消失，退出最大最小值查詢模式。短按資料保持、零點校準 **HOLD/ZERO** 複合鍵，LCD 介面左上方顯示“HOLD”字樣，進入資料保持模式，再次短按該鍵，LCD 介面左上方的“HOLD”字樣消失，退出資料保持模式；在任何模式下蓋住感測器，長按資料保持、零點校準複合鍵 1 秒，LCD 介面顯示“ADJ”字樣，進入零點校準模式，幾秒後 LCD 介面顯示的“ADJ”字樣消失，自動退出零點校準模式，返回自動測量模式。

#### 提示

1. 光源測試參考准位在受光球面正頂端。
2. 在各種測量模式下，LCD 正中間的類比條都會隨著數碼管的數位的變化而相應地變化。
3. 讀數時，可短按“HOLD/ZERO”鎖定當前資料；
4. 在進行零點校準時，一定要將光感測器保護蓋蓋住光感測器，方可進行。
5. 當完成測試時，將感測器保護罩蓋回，以保護濾光片和感測器。

## 具體應用

### 手動切換量程測量模式應用

1. 短按 **RAN** 鍵（手動切換量程鍵），進入手動切換量程，LCD 左上方顯示“MANU”字樣（如下圖所示）；

2. 進入手動切換量程功能後每次短按 RAN 鍵，則按 20.00Lux—>200.0Lux—>2000Lux—>20000Lux—>200000Lux(或 20.00Fc—>200.0 Fc—>2000 Fc—>20000 Fc)迴圈；
3. 長按 RAN 鍵 1 秒，LCD 左上方的“MANU”字樣熄滅，LCD 正中間顯示“AUTO”字樣，退出手動切換量程功能，返回自動切換量程；
- 4.

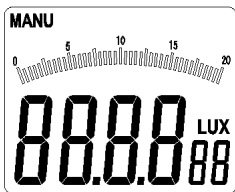

20.00Lux 檔介面

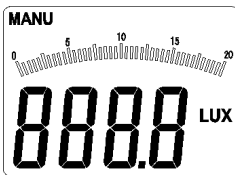
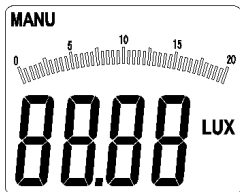

2000Lux 檔介面

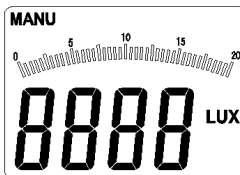

20000Lux 檔介面

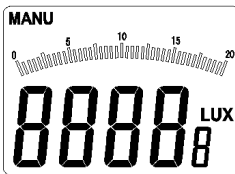

200000Lux 檔介面

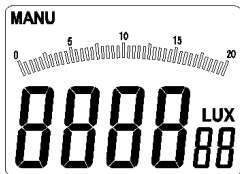

2000000Lux 檔界

## 提示

1. 在峰值測量、相對值測量和最大最小值查詢模式下短按 **RAN** 鍵方有效。
2. 在相對值測量模式和最大最小值查詢模式下長按該鍵 1 秒，則返回自動切換量程。
3. 在峰值測量模式、資料保持模式和零點校準模式下長按 **RAN** 鍵無效。
4. 在此模式中，當測量值超過當前量程時，LCD 顯示“OL”，提示超量程。此時用戶應切換測量量程；

## 相對值與峰值測量模式應用

1. 短按 **REL/PEAK** 鍵（相對值測量、峰值測量複合鍵），LCD 介面左上方顯示“REL”字樣（如下圖 3-1-2A 所示），進入相對值測量模式；
2. 再次短按 **REL/PEAK** 鍵則退出相對值測量模式，LCD 介面左上方“REL”字樣熄滅，返回原來的測量模式；
3. 長按“REL/PEAK”鍵 1 秒，進入峰值測量模式，LCD 介面右上方顯示“PEAK”字樣，同時 LCD 左上方顯示“MENU”字樣（如圖 3-1-2B 所示）；
4. 再次長按該鍵 1 秒，LCD 右上方的“PEAK”字樣熄滅，LCD 正中間顯示“AUTO”字樣，返回自動測量模式（如圖 3-1-2C 所示）。



圖 3-1-2A



圖 3-1-2B

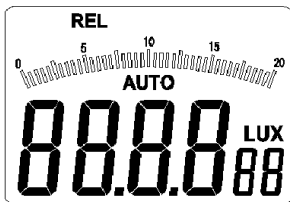

圖 3-1-2C

### ⚠ 提示

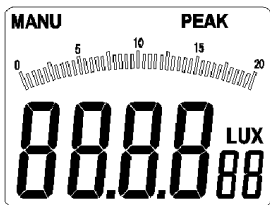
1. 在自動測量模式、峰值測量模式、最大最小值查詢模式和資料保持模式下短按 REL/PEAK 鍵方有效。
2. 在非零點校準模式下長按“REL/PEAK”鍵 1 秒，均能進入峰值測量模式。

### 最大最小值查詢模式應用

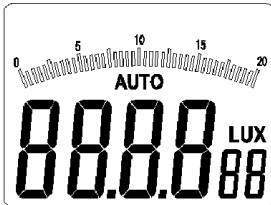
1. 短按“MAX/MIN”鍵，LCD 介面正上方顯示“MAX”字樣（如圖 3-1-3 所示），進入最大最小值查詢模式；
2. 最大最小值查詢模式下，每次短按“MAX/MIN”鍵，則按 MAX<—>MIN 迴圈切換；



3. 長按“MAX/MIN”鍵 1 秒，LCD 介面正上方的“MAX/MIN”字樣消失，退出最大最小值查詢模式。



圖 3-1-3



### 提示

在非零點校準模式下，短按“MAX/MIN”鍵均有效，都可進行最大最小值查詢功能；

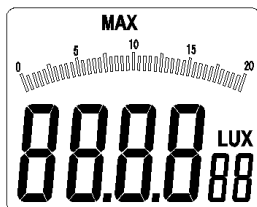
### 資料保持與零點校準模式應用

1. 短按“HOLD/ZERO”鍵，LCD 介面左上方顯示“HOLD”字樣（如圖 3-1-4A 所示），進入資料保持模式；
2. 再次短按該鍵，LCD 介面左上方的“HOLD”字樣消失，退出資料保持模式；
3. 將光感測器保護蓋蓋住光感測器，長按“HOLD/ZERO”鍵 1 秒，LCD 介面顯示“ADJ”字樣（如圖 3-1-4B 所示），進入零點校準模式，幾秒後 LCD 介面顯示的“ADJ”字樣消失，自動退出零點校準模式，返回自動測量模式。



圖 3-1-4A



圖 3-1-4B

### ⚠ 注意

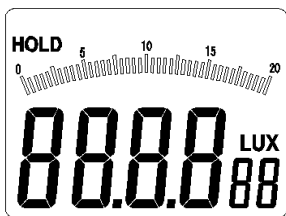
在零點校準前，一定要將光感測器保護蓋蓋住光感測器，方可進行。

### ⚠ 提示

1. 在非零點校準模式下，短按“HOLD/ZERO”鍵均有效，都可進入資料保持模式。
2. 在任何模式下都可進行零點校準。

## 其他功能

### 靜音功能

短按電源/按鍵音複合按鈕開啟或關閉按鍵音。

### 自動關機功能

在 10 分鐘內無任何操作，儀錶將自動關機。

## 技術資料

### 1. 溫度範圍：

工作：-10~50 °C，最大 80 %的相對濕度（非凝結）。

儲存：-10~50 °C，最大 80 %的相對濕度（非凝結）  
（取掉電池）。

2. 採樣速率： $\geq 2$  次/秒。
3. 顯示幕： $3\frac{1}{2}$  位元，最大讀數 1999，帶類比條顯示；
4. 感測器：矽光電二極體
5. 測量光譜範圍：320~730nm
6. 測量範圍：20、200、2000、20000、200000 Lux  
20、200、2000、20000 FC
7. 使用環境：室內使用
8. 海拔：最高 2000m
9. 電池壽命：大約 200 小時
10. 電源：1×9 V，IEC 6LR61
11. 尺寸（高×寬×深）：170 mm×85 mm×45 mm
12. 精度： $\pm 3\%$ （在 2854K 時依照普通白熾燈校準）  
 $\pm 6\%$  其他可見光光源

余弦角度偏差特性	
余弦角度	誤差
30°	$\pm 2\%$
60°	$\pm 6\%$

注：余弦角度依照 JIS C 1609:1993 和 CNS 5119 A 級通用規範修正。

### 13. 光靈敏度特性：

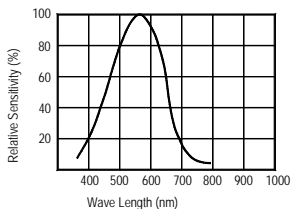

## 維護和維修

### 維修

#### 注意

如果儀錶在使用過程中似乎存在故障，應執行下列步驟確定問題的根源：

1. 檢查電池。當液晶顯示幕上出現“”符號時應立即更換電池。
2. 查閱操作說明確定操作步驟是否有誤。
3. 儀錶的維修必須由經廠家授權的服務中心或其他具備資格的儀器維修人員承擔。

#### 清潔

先用沾有清水或中性清潔劑的軟布擦拭探測儀，最後用幹布擦乾。

#### 注意

1. 在進行清潔工作之前，請您確保設備已經關機。
2. 在清潔工作中，請勿使用苯類，酒精，丙酮，乙醚，酮，稀釋劑，汽油等，這些會造成設備變形或退色。
3. 在清潔之後要等到設備完全乾燥之後，方可繼續使用。

#### 更換電池

如果顯示幕上出現電池符號閃爍（LCD 介面⑨）則必須更換電池。更換電池步驟如下：

1. 將儀錶關機；
2. 擰儀錶備背面的螺釘，揭開儀錶的電池格蓋罩；
3. 取出耗盡的電池；

4. 按照正確的極性安裝新的電池；



### 注意

1. 在更換電池之前，必須將儀錶關機。
2. 只能夠使用在技術資料中指定的電池。
3. 如果在較長時期內不使用儀錶，則要將其中的電池取出來。
4. 在處理廢舊電池時，必須遵照現行的關於電池回收、再利用和處理的規定。

### 各種場所照度標準參考表

將 Lux 照度值除以 10.764，即可求得 Fc 照度值。

學校：

照度 (Lux)	場所
1500~300	製圖教室、縫紉教室、電腦教室
750~200	教室、實驗室、實習工廠、研究室、圖書閱覽室、書庫、辦公室、教職員休息室、會議室、保健室、餐廳、廚房、配膳室、廣播室、印刷室、總機室、守衛室、室內運動場
300~150	大教室、禮堂、貯櫃室、休息室、樓梯間
150~75	走廊、電梯走道、廁所、值班室、工友室、天橋、校內室外運動場
75~30	倉庫、車庫、安全梯

事務所：

照度 (Lux)	場所
2000~1500	設計室、事務室
1500~750	大廳通道(白天)、營業室、製圖室、打卡、打字
750~300	計算器室、會議室、印刷室、總機室、控制室、招待室、娛樂室、餐廳
300~150	書庫、娛樂室、餐廳教室、休息室、警衛室、電梯(走道)、盥洗室、廁所
150~75	喝茶室、更衣室、倉庫、值夜室(入口處)
75~30	太平梯

工廠：

照度 (Lux)	場所
3000~1500	超精密作業、設計、製圖、精密檢查
1500~750	設計室、分析、組立線、塗裝
750~300	包裝、計量、表面處理、倉庫辦公室
300~150	染色、鑄造、電氣室
150~75	進出口、走廊、通道、樓梯、化粧室、廁所、附作業場倉庫
75~30	太平梯、倉庫、屋外動力設備(裝卸貨、存貨移動作業)

醫院：

照度 (Lux)	場所
10000~5000	視機能檢查室 (眼科明室)
1500~750	開刀房

750~300	診療室、治療室、制藥室、配藥室、藥局室、解剖室、病理細菌室、急救室、產房、院長室、辦公室、護士室、會議室
300~150	病房、藥品室、病床看書、換藥、骨折石膏包紮、嬰房、紀錄室、候診室、會診室、門診走廊
150~75	更衣室、物療室、X光室、病房走廊、藥品室、滅菌室、病房室、樓梯、內視鏡室
75~30	動物室、暗室(照片)、太平梯

理髮院：

照度 (Lux)	場所
1500~750	剪燙髮、染整發、化妝
750~300	修臉、洗髮、前廳掛號台、整裝
300~150	店內廁所
150~75	走廊、樓梯

旅館、飯店、娛樂場：

照度 (Lux)	場所
1500~750	櫃檯
750~300	玄關、宴會場、事務室、停車處、廚房
300~150	餐廳、洗手間、日式大房間
150~75	娛樂室、走廊、樓梯、客房、浴室、庭院 重點照明、更衣室
75~30	太平梯

商店、百貨店：

照度 (Lux)	場所
3000~750	室內陳列、飾窗陳列、示範表演場所、結帳櫃檯、包裝台
750~300	電梯大廳、電扶梯
300~150	商談室、化粧室、廁所、樓梯、走道
150~75	休息室、店內一般照明

住家：

照度 (Lux)	場所
2000~750	手工藝、裁縫
1000~500	寫作、作業
750~300	讀書、化妝、廚桌、調理、電話
300~150	洗水槽、娛樂室、客廳、團聚、玄關(內側)鏡子
150~70	衣櫃、寢室、廁所、樓梯、走廊
75~30	門牌、信箱、門鈴鈕、陽臺

**Pro'sKit®**



PROKIT'S INDUSTRIES CO., LTD.

Test Equipment Depot - 800.517.8431  
99 Washington Street Melrose, MA 02176  
TestEquipmentDepot.com

©2015 Prokit's Industries Co., Ltd. All rights reserved 2015001