

# INSTRUCTION MANUAL

## MW806 MAX pH / EC / TDS / Temperature Portable Meter





**THANK YOU** for choosing Milwaukee Instruments!  
This instruction manual will provide you the necessary  
information for correct use of the meter.

*All rights are reserved. Reproduction in whole or in part is prohibited without the written consent of the copyright owner, Milwaukee Instruments Inc., Rocky Mount, NC 27804 USA.*

**TABLE OF CONTENTS**

1. Preliminary Examination..... 4

2. Instrument Overview ..... 5

3. Meter Specifications ..... 6

    3.1. Probe Specifications.....7

4. Functional & Display Description ..... 8

5. Probe Description ..... 10

6. General Operations.....11

    6.1. Powering the Meter On & Off.....11

    6.2. Battery Management.....11

    6.3. Connecting the Probe .....11

    6.4. Electrode Care & Maintenance.....12

7. Setup..... 14

    7.1. Measurement Modes..... 14

    7.2. General Setup Options ..... 15

    7.3. pH Mode Setup Options ..... 20

    7.4. EC Mode Setup Options .....21

8. pH .....24

    8.1. Preparation.....24

    8.2. Calibration .....24

    8.3. Measurement.....27

    8.4. Warnings & Messages ..... 28

9. EC / TDS.....32

    9.1. Preparation.....32

    9.2. Calibration .....32

    9.3. Measurement.....34

    9.4. Warnings & Messages ..... 36

10. Logging ..... 38

    10.1. Types of Logging ..... 38

    10.2. Data Management ..... 41

11. GLP .....47

12. Troubleshooting ..... 48

13. Accessories.....49

Certification..... 50

Recommendations for Users..... 50

Warranty..... 50

## 1. PRELIMINARY EXAMINATION

MW806 portable meter is delivered in a rugged carrying case and is supplied with:

- **MA852** Pre-amplified pH/EC/TDS/Temperature probe with DIN connector and 1 meter (3.2 feet) cable
- **M10004** pH 4.01 buffer solution (sachet)
- **M10007** pH 7.01 buffer solution (sachet)
- **M10030** 12880  $\mu\text{S}/\text{cm}$  conductivity calibration solution (sachet)
- **M10016** Electrode cleaning solution (sachet)
- 1.5V Alkaline AA battery (3 pcs.)
- Micro USB cable
- Instrument quality certificate
- Instruction manual

## 2. INSTRUMENT OVERVIEW

**MW806** portable meter combines the main features of a benchtop unit into a portable, water-resistant meter that can measure up to 4 different parameters – pH, EC (Conductivity), TDS (Total Dissolved Solids), and temperature.

- Easy to read LCD display
- Auto-off feature to prolong battery life
- Internal clock and date to keep track of time-dependent functions (calibration timestamp, calibration time out)
- Up to 5-point pH calibration (selection from 7 standard calibration buffers and 2 custom buffers)
- Automatically (ATC) or manually temperature compensated (MTC) measurements, with a user-selectable compensation coefficient
- Available log space for up to 1000 records
- Logged data can be exported using a micro USB cable
- Dedicated GLP key to store and recall data on system status

**3. METER SPECIFICATIONS**

Range	pH	-2.00 to 20.00 pH
	EC	0.00 to 20.00 mS/cm
	TDS	0.00 to 10.00 ppt (g/L) up to 16.00 ppt (g/L) with TDS 0.80 factor
	Temperature	-20.0 to 120.0 °C (-4.0 to 248.0 °F)
Resolution	pH	0.01 pH
	EC	0.01 mS/cm
	TDS	0.01 ppt (g/L)
	Temperature	0.1 °C / 0.1 °F
Accuracy @ 25 °C (77 °F)	pH	±0.01 pH
	EC / TDS	±2 % of full scale
	Temperature	±0.5 °C / ±0.9 °F
Calibration	pH	Up to 5-point automatic pH calibration, 7 standard calibration buffers: pH 1.68; 4.01; 6.86; 7.01; 9.18; 10.01 and 12.45 2 custom buffers
	EC / TDS	Single cell factor calibration, 3 standards: 1413 µS/cm; 5.00 mS/cm; 12.88 mS/cm One-point offset: 0.00 mS/cm
	Temperature	Factory calibrated
Temperature compensation	ATC – automatic, from -20 to 120 °C (-4 to 248 °F) MTC – manual, from -20 to 120 °C (-4 to 248 °F)	
Conductivity temperature coefficient	0.00 to 6.00 %/°C (EC & TDS only) Default value: 1.90 %/°C	
TDS factor	0.40 to 0.80; default value: 0.50	
Logging memory	Up to 1000 log records (stored in up to 100 lots) On demand, up to 200 logs On stability, up to 200 logs Interval logging, up to 1000 logs Parameter-specific log storage location	
PC connectivity	1 micro USB port	
Battery type	3 x 1.5V Alkaline AA batteries (included) Approximately 200 hours of use	
Environment	0 to 50 °C (32 to 122 °F); maximum RH 95 %	
Dimensions	200 x 85 x 50 mm (7.9 x 3.3 x 2.0")	
Casing	IP67 protection level	
Weight	260 g (0.57 lb)	



### 3.1. PROBE SPECIFICATIONS

<b>MA852</b> Amplified pH/EC/TDS/ Temperature	pH range	0 to 13.00 pH
	Temperature range	0.0 to 60.0 °C (32.0 to 140.0 °F)
	EC electrodes	2 x graphite
	Reference (pH)	Single, Ag/AgCl
	Junction (pH)	Cloth
	Electrolyte (pH)	Gel
	Body	ABS
	Connection	DIN
	Cable	1 m (3.3')

## 4. FUNCTIONAL & DISPLAY DESCRIPTION

### Front Panel

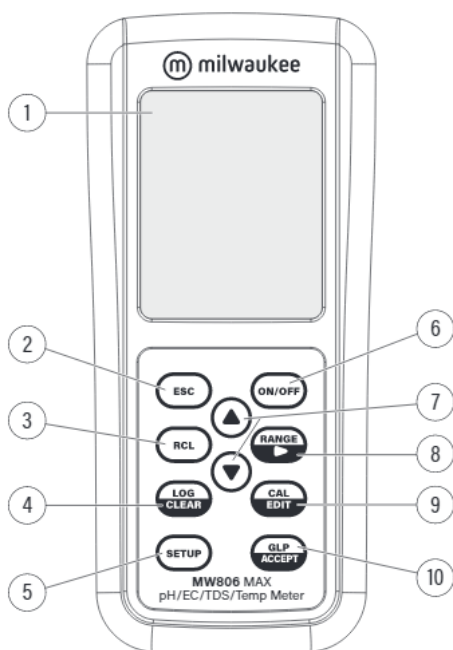

1. Liquid Crystal Display (LCD)
2. ESC key, to exit current mode
3. RCL key, to recall logged values
4. LOG/CLEAR key, to log readings or clear calibration / logging
5. SETUP key, to enter setup mode
6. ON/OFF key
7. ▲▼ directional keys (menu navigation, setting parameters)
8. RANGE/► key, to select measurement mode
9. CAL/EDIT key, to enter or edit calibration and setup settings
10. GLP/ACCEPT key, to enter GLP or to confirm selected action



Top Panel

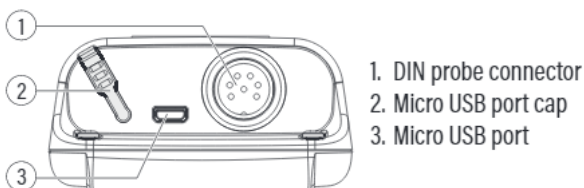

Display Description

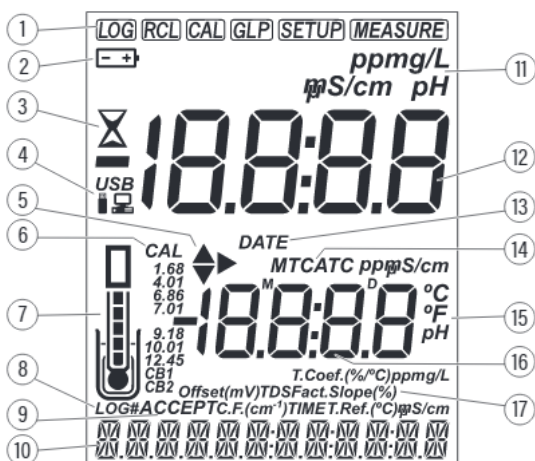

1. Mode tags
2. Battery status
3. Stability indicator
4. USB connection status
5. Arrow tags, menu navigation in either direction
6. Calibration buffers
7. Probe symbol and probe condition
8. Log tag
9. Accept tag
10. Third LCD line, message area
11. Measurement units
12. First LCD line, measurement readings
13. Date tag
14. Temperature compensation status (MTC, ATC)
15. Temperature units
16. Second LCD line, temperature readings
17. Measurement units, offset and slope indicators, TDS settings, Time tag

## 5. PROBE DESCRIPTION

The MA852 multiparameter probe incorporates a domed shaped pH bulb, a single junction Ag/AgCl reference electrode with gel electrolyte and a retractable cloth junction, a graphite EC/TDS cell, and a temperature sensor, all in one rugged ABS body.

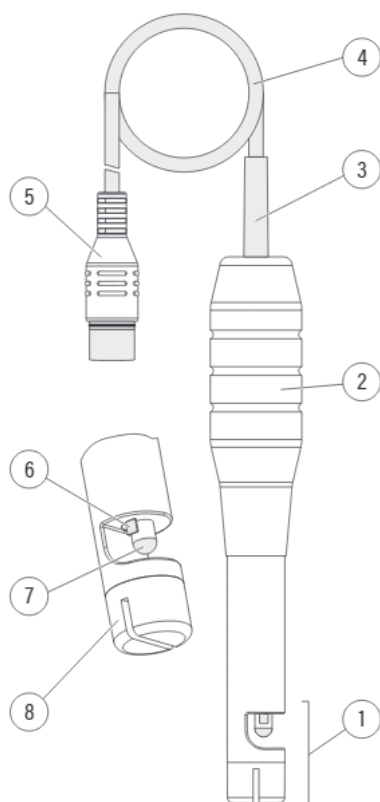

1. Sensing tip
2. Probe body
3. Cable strain relief
4. Connection cable
5. DIN connector
6. Cloth reference junction
7. pH sensor
8. EC sensor

## 6. GENERAL OPERATIONS

### 6.1. POWERING THE METER ON & OFF

Press the ON/OFF key to power the meter on or off.

At power-on the instrument performs an auto-diagnostic test. All LCD segments are displayed for a few seconds.

### 6.2. BATTERY MANAGEMENT

The meter is supplied with 3 x 1.5V Alkaline AA batteries. To conserve battery, the meter will turn off automatically after 10 minutes of inactivity (see Auto Off, GENERAL SETUP OPTIONS section).

From measurement screen, use ▲▼ keys to check the battery percentage.

#### Battery replacement

1. Turn the meter off.
2. Remove the 4 screws on the back of the meter to open the battery compartment.
3. Remove the old batteries.
4. Insert the 3 new 1.5V AA batteries while paying attention to their polarity.
5. Close the battery compartment using the 4 screws.

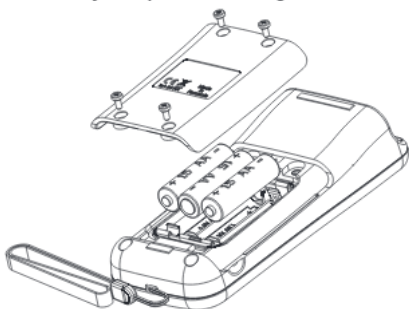

### 6.3. CONNECTING THE PROBE

**MA852** is connected to the meter through a DIN connector, making attaching and removing the probe an easy process.

- With the meter off, connect the probe to the DIN socket on the top of the meter.
- Align the pins and key then push the plug into the socket.
- Remove the protective cap from the probe before taking measurements.

## 6.4. ELECTRODE CARE & MAINTENANCE

### Calibrating & Conditioning

Maintaining a combination pH/EC/TDS/Temperature electrode is critical to ensure reliable measurements.

Frequent 2- or 3-point calibrations are recommended to ensure accurate and repeatable results.

#### Prior to first use

1. Remove the protective cap. Do not be alarmed if salt deposits are present, this is normal. Rinse the electrode with distilled or deionized water.
2. Place the electrode in a beaker containing **MA9016** Cleaning solution for a minimum of 30 minutes.

*Note: Do not condition a pH electrode in distilled or deionized water as this will damage the glass membrane.*

3. After conditioning, rinse the sensor with distilled or deionized water.

*Note: To ensure quick response and avoid cross-contamination, rinse the pH electrode tip with the solution to be tested before measurement.*

#### Best practice when handling an electrode

- pH electrodes should always be rinsed between samples with distilled or deionized water.
- Blot the end of the pH portion of this probe with lint-free paper. Do not wipe to avoid erroneous readings due to static charges.
- Connectors should be clean and dry.

#### Storage

To minimize clogging and ensure quick response time, the glass bulb and the junction should be kept hydrated.

Add a few drops of **MA9015** Storage solution to the protective cap. Replace the storage cap when the probe is not in use.

*Note: Never store the probe in distilled or deionized water.*

### Regular Maintenance

- Inspect the probe. If cracked, replace the probe.
- Inspect the cable. Cable and insulation must be intact.
- Connectors should be clean and dry.
- Rinse off salt deposits with water.
- Follow storage recommendations.

If electrodes are not maintained correctly, both accuracy and precision are affected. This can be observed as a steady decrease in the slope of the electrode.

The slope (%) indicates the sensitivity of the glass membrane, the offset value (mV) indicates the age of electrode and provides an estimation when the probe needs to be changed. The slope percentage is referenced to the ideal slope value at 25 °C.

Milwaukee Instruments recommends that the offset does not exceed  $\pm 30$  mV and that the slope percentage is between 85 - 105 %. When the slope value drops below 50 mV per decade (85 % slope efficiency) or the offset at the zero point exceeds  $\pm 30$  mV, reconditioning may improve performance, but a change of electrode may be necessary to ensure accurate pH measurements.

### Electrode Status

MW806 displays electrode status after calibration. See probe icon on the LCD screen. The assessment remains active for 12 hours and is based on the electrode offset and slope during calibration.

	5 bars	Excellent condition
	4 bars	Very good condition
	3 bars	Good condition
	2 bars	Fair condition
	1 bar	Poor condition
	1 bar blinking	Very poor condition
	no bar	Not calibrated

Recommendations:

- **1 bar:** Clean the electrode and recalibrate. If there is still only 1 bar or 1 bar blinking after recalibration, replace the probe.
- **No bar:** Instrument was not calibrated on current day or a one-point calibration was performed with previous calibration not yet deleted.

## 7. SETUP

### 7.1. MEASUREMENT MODES

Setup options and calibration depend on the selected measurement mode.

Press RANGE/▶ from the measurement screen to select:

- PH, to enter pH mode
- CONDUCTIVITY or TDS, to enter EC mode

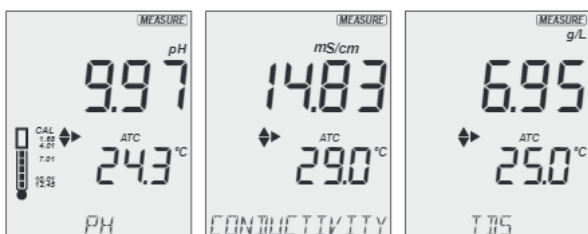

Measurement Mode	Setup Mode	Measurement Unit
PH	PH (default)	pH
CONDUCTIVITY	EC	mS/cm
TDS	EC	g/L

**Note:** At power on, the meter starts in the previously selected measurement mode.

To configure the meter settings, modify default values, or set measurement parameters:

- Press RANGE/▶ to select measurement mode.
- Press SETUP to enter (or exit) Setup mode.
- Use ▲▼ keys to navigate the menus (view parameters).
- Press CAL/EDIT to enter Edit mode (modify parameters).
- Press RANGE/▶ key to select between parameter options. Use ▲▼ keys to modify values (value being modified is displayed blinking).
- Press GLP/ACCEPT to confirm and save changes (ACCEPT tag is displayed blinking).
- Press ESC (or CAL/EDIT again) to exit Edit mode without saving (return to menu).

## 7.2. GENERAL SETUP OPTIONS

General options can be configured with or without the probe being connected.

### Log Type

Options: INTERVAL (default), MANUAL, STABILITY

Press RANGE/▶ to select between options.

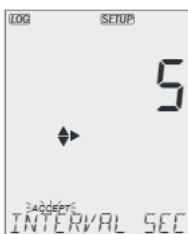
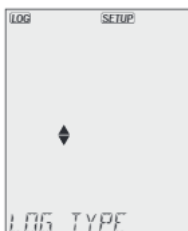

Use ▲▼ keys to set time interval: 5 (default), 10, 30 seconds or 1, 2, 5, 15, 30, 60, 120, 180 minutes.

Use ▲▼ keys to select stability type: fast (default), medium or accurate.



### Calibration Expired Warning

Options: 1 to 7 days (default) or off

Use ▲▼ keys to select the number of days since last calibration has elapsed.



### Date

Options: year, month, day

Press RANGE/▶ to select. Use ▲▼ keys to modify the values.



### Time

Options: hour, minute, second

Press RANGE/▶ to select. Use ▲▼ keys to modify the values.

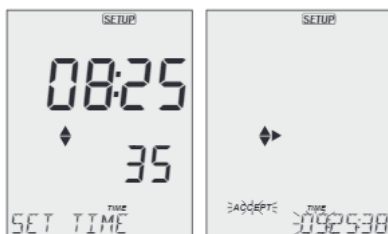



### Auto Off

Options: 5, 10 (default), 30, 60 minutes, or off

Use ▲▼ keys to select the time.

The meter will power off after the set period of time has elapsed.

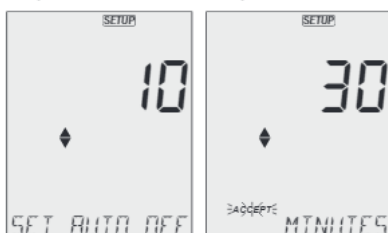

### Sound

Options: On (default) or Off (disabled)

Use ▲▼ keys to enable or disable option.

When pressed, each key will emit a short acoustic signal.



### Temperature Unit

Options: °C (default) or °F

Use ▲▼ keys to select the unit.

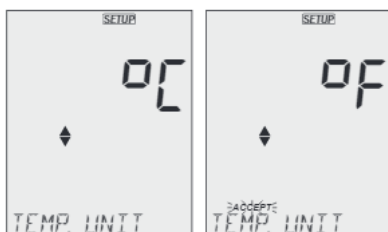

### LCD Contrast

Options: 1 to 9 (default)

Use ▲▼ keys to select LCD contrast values.

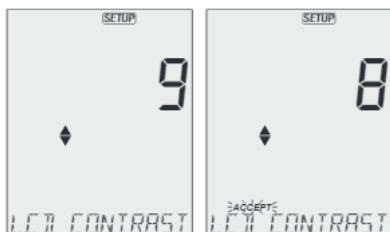

### Default Values

Resets meter settings to factory defaults.

Press GLP/ACCEPT to restore the default values. "RESET DONE" message confirms that the meter performs with default settings.



### Instrument Firmware Version

Displays the installed firmware version.

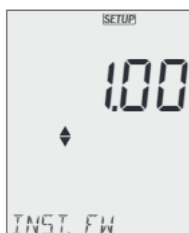

### Meter ID / Serial Number

Use ▲▼ keys to assign a meter ID from 0000 to 9999.  
 Press RANGE/▶ to view the serial number.



### Separator Type

Options: comma (default) or semicolon

Use ▲▼ keys to select the columns separator for the CSV file.

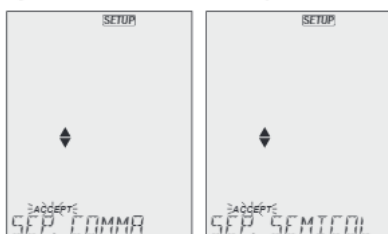

### Export to PC / Log on Meter

Options: Export to PC (default) or Log on Meter

The export options are only available while connected to a PC.

With the micro USB cable connected, press SETUP.

Press CAL/EDIT to enter Edit mode. Use ▲▼ keys to select option.

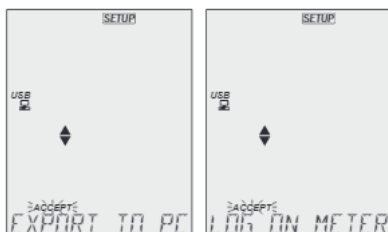

**Note:** The USB/PC icon is not displayed with LOG ON METER option selected.

### 7.3. pH MODE SETUP OPTIONS

The following options are available only with PH mode selected.

#### pH Information

Options: On (default) or Off (disabled)

Use ▲▼ keys to enable or disable option.

When enabled, it displays pH buffer calibration information and electrode condition.

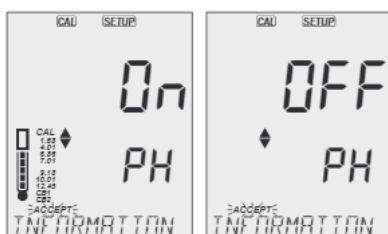

#### First Custom Buffer

Press RANGE/▶ to select from default buffers.

Use ▲▼ keys to edit the first custom value.

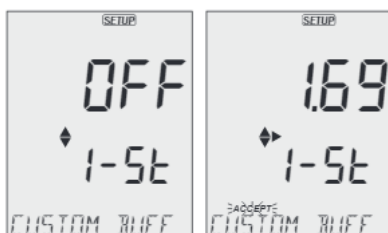

#### Second Custom Buffer

Press RANGE/▶ to select from default buffers.

Use ▲▼ keys to edit the second custom value.

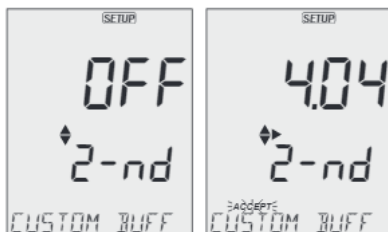

### Out of Calibration Range

Options: On (default) or Off (disabled)

Use ▲▼ keys to enable or disable option.



### pH Temperature Compensation

Options: ATC (default) or MTC

Press RANGE/▶ to select option.



## 7.4. EC MODE SETUP OPTIONS

The following options are available only with EC mode selected.

### EC Temperature Compensation

Options: ATC (default) or MTC

Press RANGE/▶ to select option.



### EC Cell Factor

Options: 0.010 to 9.999 (1.000 default)

Use ▲▼ keys to change the value.

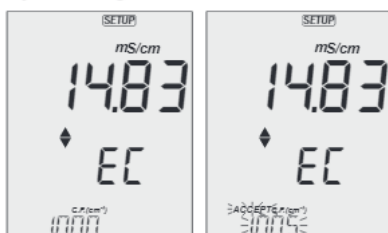

**Note:** Setting the EC cell-factor value directly erases any previous EC calibration. Log files and GLP display "MANUAL" as standard.

### EC Temperature Coefficient (T.Coef.)

Options: 0.00 to 6.00 (1.90 default)

Use ▲▼ keys to change the value.

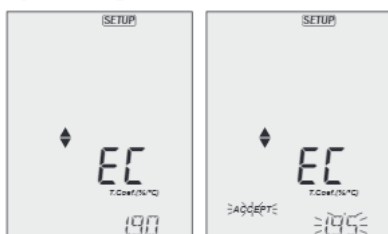

### EC Temperature Reference (T.Ref.)

Options: 25 °C (default) or 20 °C

Use ▲▼ keys to change the value.



### TDS Factor

Options: 0.40 to 0.80 (0.50 default)

Use ▲▼ keys to change the value.

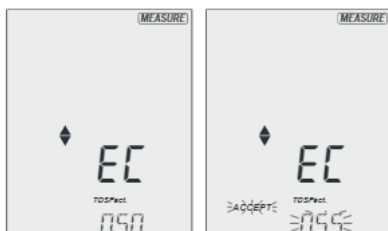

### EC Temperature Coefficient / Reference View

Options: T.Coeff.(%/°C) or T.Ref.(°C) (default)

Use ▲▼ keys to select option.

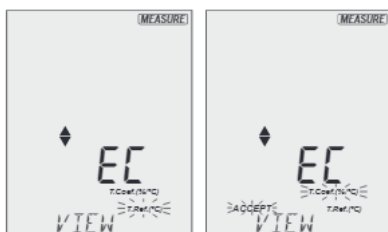

## 8. pH

### 8.1. PREPARATION

Up to a 5-point calibration can be performed using 7 standard buffers and 2 custom buffers (CB1 and CB2).

1. Prepare two clean beakers. One for rinsing and one for calibration.
2. Pour small quantities of the selected buffer solution into each beaker.
3. Remove the protective cap and rinse the probe with the buffer solution for the first calibration point.

### 8.2. CALIBRATION

#### General Guidelines

For better accuracy, frequent calibrations are recommended.

The probe should be recalibrated at least once a week, or:

- Whenever it is replaced
- After testing aggressive samples
- When high accuracy is required
- When the calibration timeout has expired

#### Procedure

##### 1-point Calibration

1. Place the probe tip approximately 4 cm (1½") into the buffer solution and stir gently.

*Note: For a 2-point calibration, use the pH 7.01 (pH 6.86 for NIST) buffer first.*

2. Press CAL/EDIT to enter Calibration mode. Buffer value and "WAIT" message are displayed blinking. If required, use the ▲▼ keys to select a different buffer value.

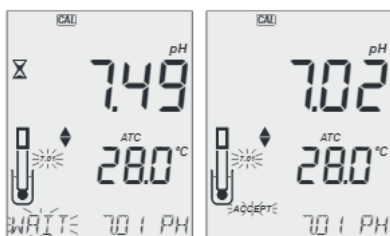

3. When the reading is stable and close to the selected buffer, the ACCEPT tag is displayed blinking. Press GLP/ACCEPT to confirm calibration.



After the first calibration point has been confirmed, the calibrated value is displayed on the first LCD line and the second expected buffer value on the third LCD line (i.e. pH 4.01). The first buffer value is saved and the second proposed buffer is displayed blinking.



4. Press CAL/EDIT to exit 1-point calibration and return to Measurement mode.

#### Up to 5-point Calibration

To continue calibrating, rinse and place the probe tip approximately 4 cm (1½") into the second buffer solution and stir gently. If needed, use the ▲▼ keys to select a different buffer value.

**Note:** When attempting to calibrate with a different buffer (not yet used), the previously used buffers are displayed blinking.

Follow 1-point calibration steps for up to 5-point calibration. Press CAL/EDIT to store the value and return to Measurement mode.

For improved accuracy, a minimum of 2-point calibration is recommended.

**Note:** When performing a new calibration (or adding to an existing calibration), the first calibration point is treated as an offset. Press CAL/EDIT after the first or second calibration point has been confirmed, and the instrument stores the calibration data and returns to Measurement mode.

### Calibrating with Custom Buffers

Custom buffer value needs to be configured in pH mode Setup. Temperature compensation of custom buffers is set to the value of 25 °C.

- Press RANGE/▶. The custom buffer value is displayed blinking on the third LCD line.
- Use the ▲▼ keys to modify the value based on temperature reading. The buffer value is updated after 5 seconds.

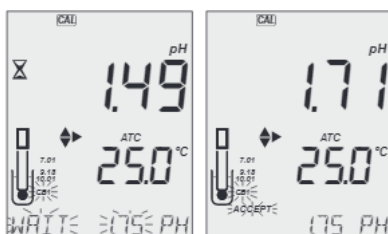

**Note:** When using custom buffers, CB1 and CB2 tags are displayed. If only one custom buffer is used, CB1 is displayed together with its value.

### Clear Calibration

1. Press CAL/EDIT to enter Calibration mode.
2. Press LOG/CLEAR.  
ACCEPT tag is displayed blinking and "CLEAR CAL" message is displayed on the third LCD line.
3. Press GLP/ACCEPT to confirm.  
"PLEASE WAIT" message is displayed, followed by the "NO CAL" confirmation screen.

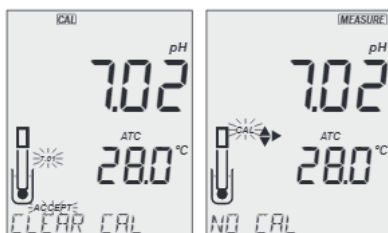

### 8.3. MEASUREMENT

For best results, it is recommended to:

- Calibrate the probe before use and recalibrate periodically.
- Keep the electrode hydrated.
- Rinse the probe with the sample before use.
- Soak in **MA9015** Storage solution for at least 1 hour before measurement.

Remove the probe protective cap and place the tip approximately 4 cm (1 ½") into the sample. It is recommended to wait for the sample and the probe to reach the same temperature.

If necessary, press the RANGE/▶ to select pH mode. Allow the reading to stabilize (stability indicator – ⌘ – is no longer displayed).

Measurement screen displays:

- Measurement and temperature readings
- Temperature compensation mode (MTC or ATC)
- Buffers used (if option enabled in Setup)
- Electrode condition (if option enabled in Setup)
- On third LCD line: mV offset & slope values, time and date of measurement, battery status. Use the ▲▼ keys to scroll between them.

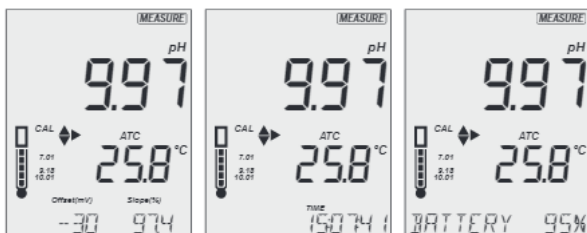

#### MTC Mode

1. Press CAL/EDIT and use the ▲▼ keys to set the temperature value manually.
2. Press GLP/ACCEPT to confirm or press ESC (or CAL/EDIT again) to exit without saving.

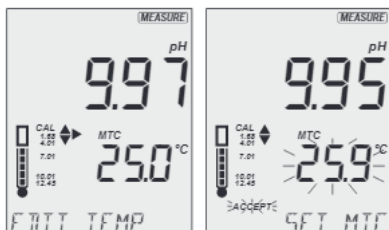

## 8.4. WARNINGS & MESSAGES

### Messages Displayed During Calibration

- "WRONG BUFFER" is displayed blinking when the difference between the pH reading and selected buffer value is significant. Check if correct calibration buffer has been used.



- "WRONG OLD POINTS INCONSISTENT" is displayed if there is discrepancy between new calibration value and old value recorded when calibrating with the same probe in a buffer of the same value.

Clear the previous calibration and calibrate with fresh buffers. See Clear Calibration section for details.

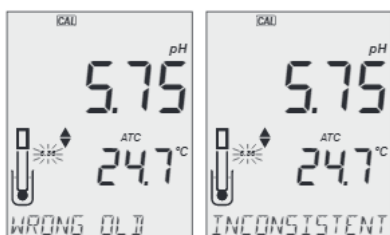

- "CLEAN ELEC" is displayed when the offset is out of the accepted window, or the slope is under the accepted lower limit.

Clean the probe to improve response time.

Repeat calibration after cleaning. See ELECTRODE CARE & MAINTENANCE for details.



- "CHECK PROBE CHECK BUFFER" is displayed when the electrode's slope exceeds the highest accepted slope limit. Inspect the electrode and make sure the buffer solution is fresh. Clean the probe to improve response time.

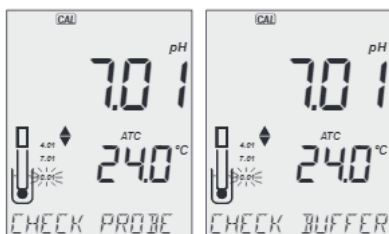

- "BAD ELEC" is displayed when, after cleaning, the electrode's performance has not improved. Replace the probe.



- "WRONG BUFFER TEMPERATURE" is displayed when buffer temperature is out of range. The calibration buffers are affected by temperature changes.

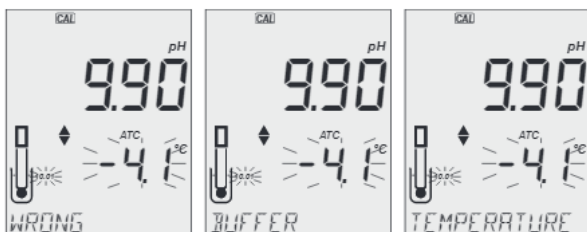

- When "CONTAMINATED BUFFER" is displayed, replace the buffer with a new one and continue the calibration.

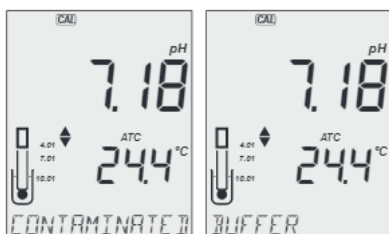

- "VALUE USED BY CUST1" or "VALUE USED BY CUST2" is displayed when setting a CUST1 or CUST2 value already saved for a custom buffer.

Make sure that set custom buffers have different values.

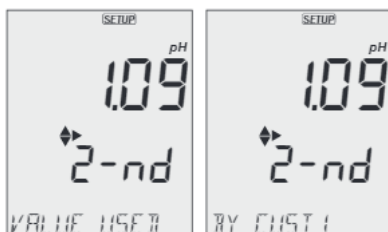

- "VALUE CALIBRATED WITH CUST1" or "VALUE CALIBRATED WITH CUST2" is displayed when calibrating with a custom value already used in a previous calibration.



### Messages Displayed During Measurement

- "OUT OF SPEC" and the temperature value (blinking) are displayed when the measured temperature is out of range. If the reading is out of range, the full-scale value is blinking.

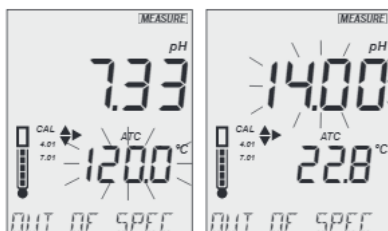

- "OUT CAL RNG" is displayed when the measured value is outside calibration range and the option has been enabled (see Out of Calibration Range, GENERAL SETUP OPTIONS section).



- "CAL EXPIRED" is displayed if the Calibration Expired Warning function is on and the number of days set have passed. See Calibration Expired Warning section for details.



- "NO CAL" is displayed when the probe needs to be calibrated or that the previous calibration has been deleted.



- "NO PROBE" is displayed if the probe is not connected.

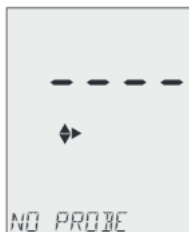

## 9. EC / TDS

### 9.1. PREPARATION

Pour small quantities of conductivity calibration solution into clean beakers. To minimize cross-contamination, use two beakers: one for rinsing the probe and the other for calibration.

*Note: The TDS reading is automatically derived from the EC reading and no TDS calibration is needed.*

### 9.2. CALIBRATION

#### General Guidelines

For better accuracy, frequent calibration is recommended.

The probe should be calibrated:

- Whenever it is replaced
- After testing aggressive samples
- When high accuracy is required
- If "NO CAL" is displayed on the third LCD line
- At least once a week

Before performing a calibration:

- Inspect the probe for debris or blockages.
- Always use an EC calibration standard that is close to the sample. Selectable calibration points are 0.00 mS/cm for offset and 1.41 mS/cm, 5.00 mS/cm, 12.88 mS/cm for slope.

To enter EC calibration:

1. Press RANGE/▶ to select EC measurement mode ("CONDUCTIVITY" displays briefly).
2. Press CAL/EDIT to enter calibration mode.

#### Zero Calibration

For zero calibration, to correct readings around 0.00 mS/cm, keep the dry probe in the air. The slope is evaluated when the calibration is performed in any other point.

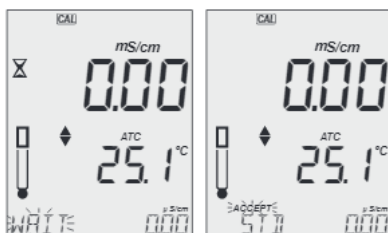



### 1-Point Calibration

1. Place the probe in the calibration solution ensuring that the EC sensor (tip) is submersed. Center the probe away from the bottom or beaker walls.
2. Lift and lower the probe and tap the probe repeatedly to remove any trapped air bubbles.
3. Press CAL/EDIT and use the ▲▼ keys to select a standard value. The stability indicator -X- and "WAIT" message (blinking) are displayed until the reading is stable.



When the reading is stable and close to the selected calibration standard, "SOL STD" and the value are displayed on the third LCD line with ACCEPT tag blinking.

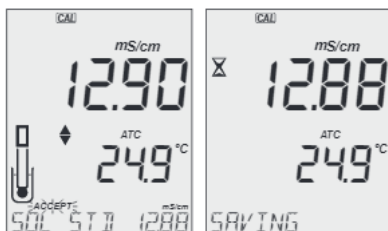

4. Press GLP/ACCEPT key to confirm calibration. The meter displays "SAVING"; it stores the calibration values and returns to measurement mode.

### Manual Calibration

To set the cell-constant value directly:

1. Rinse the probe in the calibration standard and shake off any excess solution (first beaker).
2. Place the probe in the standard ensuring that the EC sensor (tip) is submersed (second beaker).
3. Press SETUP and use the ▲▼ keys to select C.F. ( $\text{cm}^{-1}$ ).
4. Press CAL/EDIT.
5. Use the ▲▼ keys to modify C.F. ( $\text{cm}^{-1}$ ) until the display reads the custom standard value.
6. Press GLP/ACCEPT. "MANUAL CALIBRATION CLEARS PREVIOUS CALIBRATIONS" is scrolled on the third LCD line. CAL and ACCEPT tags are displayed blinking.
7. Press GLP/ACCEPT to confirm or press ESC to exit without changing.

*Note: Using manual calibration will erase previous calibrations; and both log files and GLP will display "MANUAL" as standard.*

### Clear Calibration

1. Press CAL/EDIT followed by LOG/CLEAR.  
ACCEPT tag is displayed blinking and "CLEAR CALIBRATION" message on the third LCD line.
2. Press GLP/ACCEPT to confirm. "PLEASE WAIT" message is displayed followed by "NO CAL" confirmation screen.

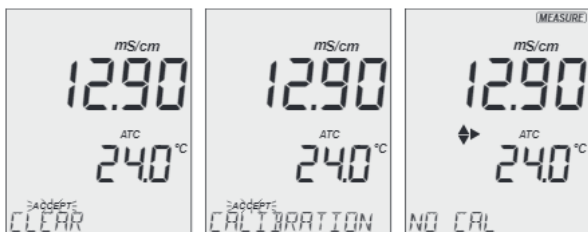

## 9.3. MEASUREMENT

### Conductivity Measurement

When connected, the probe is automatically recognized. Place the calibrated probe in the sample. Tap the probe to remove any trapped air bubbles.

To change to EC mode, press RANGE/▶.

The conductivity value is displayed on the first LCD line, the temperature on the second LCD line and calibration information on the third LCD line.

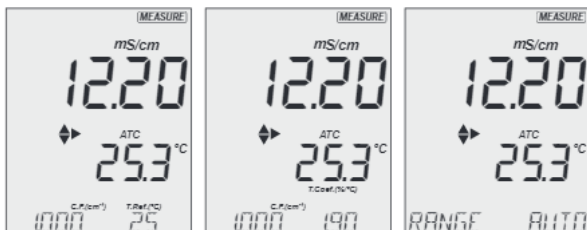

To navigate the information displayed on the third LCD line, use the ▲▼ keys.

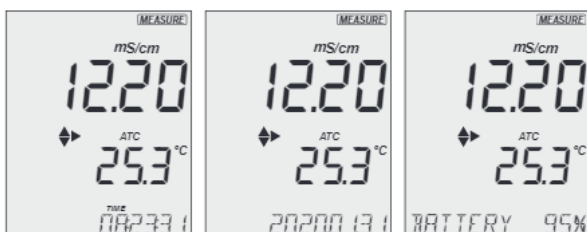

Readings can be temperature compensated.

- **Automatic Temperature Compensation (ATC), default:** The probe has a built-in temperature sensor; the temperature value is used to automatically compensate the EC / TDS reading.

When in ATC mode, ATC tag is displayed and measurements are compensated using the temperature coefficient. Recommended default value for water samples is 1.90 %/°C. Temperature compensation is referenced to the selected reference temperature.

Use the ▲▼ keys to view the current temperature coefficient. The value is displayed along with the Cell Factor (C.F.) on the third LCD line.

To change the temperature coefficient, see SETUP section for details.

A temperature coefficient must also be set for the sample.

**Note:** If the reading is outside of range when the range is set to automatic, the full-scale value (20.00 mS/cm) is displayed blinking.

- **Manual Temperature Compensation (MTC):** The temperature value, shown on the second LCD line, can be manually set using the ▲▼ keys. When in MTC mode, the °C tag is blinking.

**Note:** Temperature-compensation is configured in Setup.

### TDS Measurement

Press RANGE/▶ to select TDS range.

- The TDS reading is displayed on the first LCD line and the temperature reading on the second LCD line.

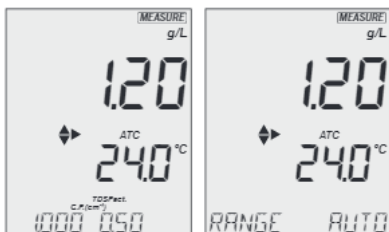

To navigate the information displayed on the third LCD line, use the ▲▼ keys.

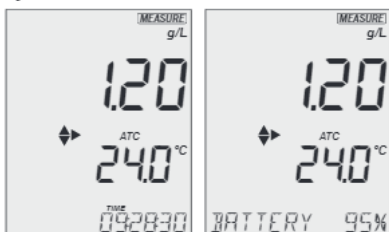

## 9.4. WARNINGS & MESSAGES

### Messages Displayed During Calibration

- "WRONG STANDARD" is displayed when the difference between the reading and selected calibration solution is significant. Check if correct calibration solution has been used and / or clean the probe. See ELECTRODE CARE & MAINTENANCE section for details.

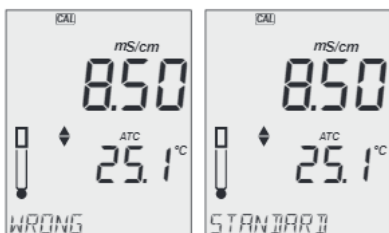

- "WRONG STANDARD TEMPERATURE" is displayed when using ATC mode and solution temperature is outside accepted interval. Temperature is displayed blinking.

### Messages Displayed During Measurement

- "OUT OF SPEC" is displayed if the reading exceeds the parameter range limits or the temperature exceeds the supported range.

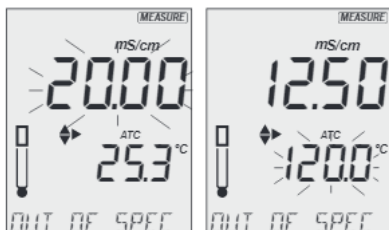

- "CAL EXPIRED" is displayed if the Calibration Expired Warning function is on and the number of days set have passed. See Calibration Expired Warning section for details.

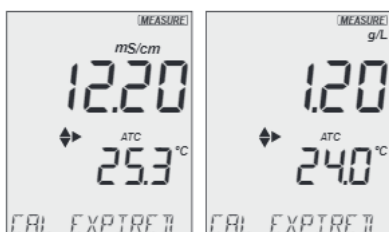

- "NO CAL" is displayed if the probe needs to be calibrated or if the previous calibration has been deleted.



- "NO PROBE" is displayed if the probe is not connected.

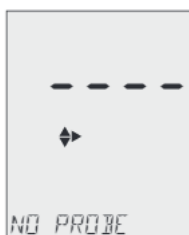

## 10. LOGGING

Logging locations are measurement mode specific. pH logs are saved under "PH", CONDUCTIVITY and TDS logs under "EC".

- Press LOG/CLEAR to log a measurement.
- Press RCL to access or export logged data.

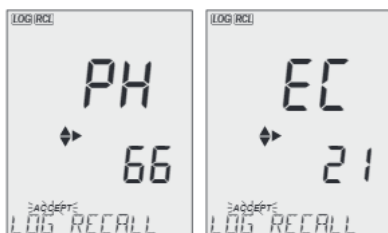

For log types and stability criteria, see Log Type, GENERAL SETUP OPTIONS and DATA MANAGEMENT sections.

### 10.1. TYPES OF LOGGING

#### Manual log on demand

- Readings are logged each time LOG/CLEAR is pressed.
- All manual readings are stored in a single lot (i.e. records made on different days share the same lot).

#### Log on stability

- Readings are logged each time LOG/CLEAR is pressed and stability criteria is reached.
- All stability readings are stored in a single lot (i.e. records made on different days are logged in the same lot).

#### Interval logging

**Note:** An interval logging lot can hold up to 600 records. When an interval logging session exceeds 600 records, another log file is automatically generated.

- Readings are logged continuously at a set time interval (e.g. every 5 or 10 minutes).
- Records are added to the lot until the session stops.
- For each interval logging session, a new lot is created.

A complete set of GLP information including date, time, range selection, temperature reading and calibration information is stored with each log.

### Manual Log on Demand

1. From the Setup mode, set Log Type to MANUAL.
2. From the measurement screen press LOG/CLEAR.  
 "PLEASE WAIT" is displayed followed by number of logs saved and available ("FREE") space.  
 Meter then returns to measurement mode.

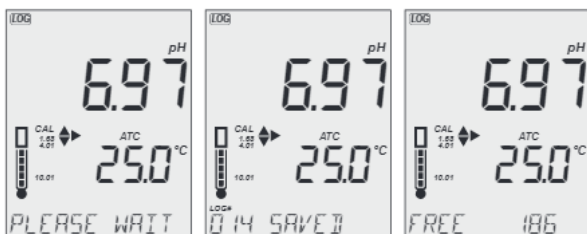

### Log on Stability

1. From the Setup mode, set Log Type to STABILITY and the desired stability criteria.
2. From the measurement screen press LOG/CLEAR.  
 "PLEASE WAIT" followed by "WAITING" is displayed until stability criteria is reached. The meter displays the number of logs saved followed by available ("FREE") space.  
 Meter then returns to measurement mode.

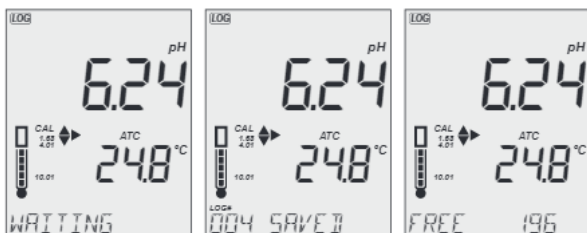

**Note:** Press ESC or LOG/CLEAR before stability criteria is reached to exit without logging.

### Interval Logging

1. From the Setup mode, set Log Type to INTERVAL (default) and desired time interval.
2. From the measurement screen press LOG/CLEAR.  
"PLEASE WAIT" is displayed followed by number of saved logs and lot logging number.

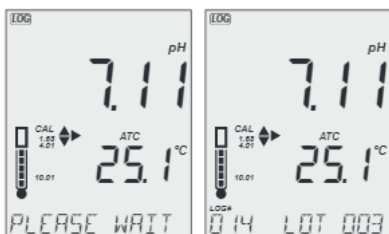

3. Press RANGE/▶ during logging to view the available ("FREE") space left. Press RANGE/▶ again to return to active logging screen.
4. Press LOG/CLEAR (or ESC) to end current interval logging session. "LOG STOPPED" is displayed and the meter returns to measurement mode.

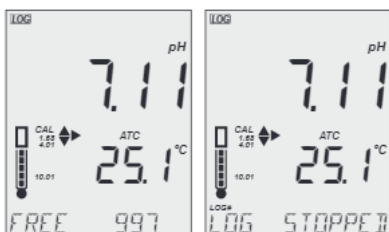

### Interval Logging Warnings

	Sensor failure and logging stops.
"OVER RANGE"	Measurement exceeds the specifications limit of the probe or meter.
"MAX LOTS"	Maximum number of lots (100) was reached. Cannot create new lots.
"LOG FULL"	Log space is full (1000 logs limit was reached). Logging stops.
"NO PROBE"	Probe is disconnected or damaged. Logging stops.



## 10.2. DATA MANAGEMENT

- A lot contains 1 to 600 log records (saved measurement data).
- Maximum number of lots that can be stored is 100, excluding Manual and Stability.
- Maximum number of log records that can be stored is 1000, across all lots.
- Manual and Stability logs can store up to 200 records (each).
- Interval logging sessions (across all 100 lots) can store up to 1000 records. When a logging session exceeds 600 records a new lot will be created.
- Lot name is given by a number, from 001 up to 999. Names are allocated incrementally, even after some lots have been deleted. Once lot name 999 was assigned, all lots have to be deleted, to reset lot naming to 001.

See Deleting Data section.

### 10.2.1. Viewing Data

1. Press RCL and number of stored logs is displayed.

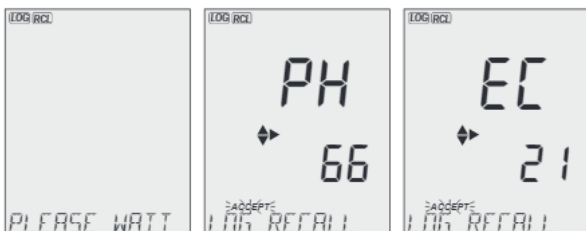

2. Use ▲▼ keys to select "PH" or "EC" log storage location. Press GLP/ACCEPT to confirm.
3. Use ▲▼ keys to select the lot type (MANUAL, STABILITY or INTERVAL ###). Press GLP/ACCEPT to confirm.

**Note:** Press RANGE/▶ to export all "PH" or "EC" logs to USB.

**Note:** Press RANGE/▶ to export the selected lot to USB.

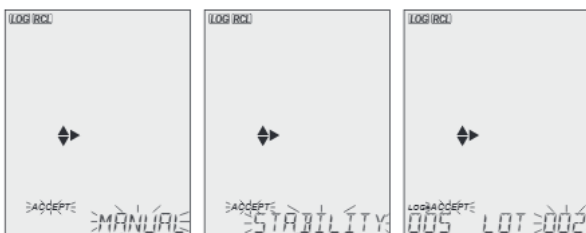

4. With a lot selected, use ▲▼ keys to view the records stored in that lot.

- Press RANGE/▶ to view additional log data displayed on the third LCD line:
  - for pH logs: offset, slope, calibration points, corresponding mV value, date, time and log type information
  - for EC logs: cell factor, temperature coefficient, temperature reference, TDS factor, date, time, log type information and standard used for calibration

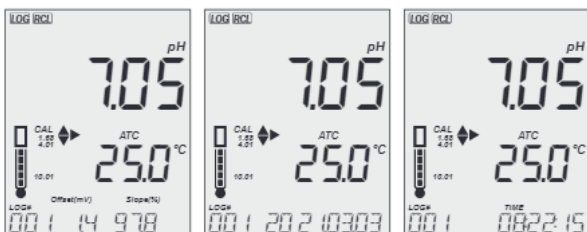

### 10.2.2. Deleting Data

#### Manual Log on Demand & Stability Log

- Press RCL to access logged data.
- Use ▲▼ keys to select log storage location ("PH" or "EC") and press GLP/ACCEPT to confirm.
- Use ▲▼ keys to select lot type and press LOG/CLEAR to delete entire lot. Press GLP/ACCEPT to confirm.  
(To exit prior to confirming, press ESC or CAL/EDIT)  
Confirmation screen displays "CLEAR DONE" followed by "NO MANUAL/LOGS" or "NO STABILITY/LOGS").



#### Individual Logs / Records

- Press RCL to access logged data.
- Use ▲▼ keys to select log storage location ("PH" or "EC") and press GLP/ACCEPT to confirm.
- Use ▲▼ keys to select lot type and press GLP/ACCEPT to confirm.
- Use ▲▼ keys to select log record number and press LOG/CLEAR to delete.

- Log number selected for deletion is displayed blinking. Press GLP/ACCEPT to confirm.

Confirmation screen displays "CLEAR DONE" and the meter displays logged data for next log.



*Note: Logs stored within an interval lot cannot be deleted individually.*

### Log on Interval

- Press RCL to access logged data.
- Use ▲▼ keys to select storage location. Press GLP/ACCEPT to confirm.
- Use ▲▼ keys to select lot number to be deleted and press LOG/CLEAR to delete entire lot.
- Lot number selected for deletion is displayed blinking. Press GLP/ACCEPT to confirm.

Confirmation screen displays "CLEAR DONE" and the meter displays a previously saved lot number.



### Delete All

- Press RCL to access logged data.
- Use ▲▼ keys to select storage location ("PH" or "EC").
- Press LOG/CLEAR to delete all logs from selected location.
- Selected storage location ("PH" or "EC") is displayed blinking. Press GLP/ACCEPT to confirm.

Confirmation screen displays "CLEAR DONE" and the meter returns to log recall screen.

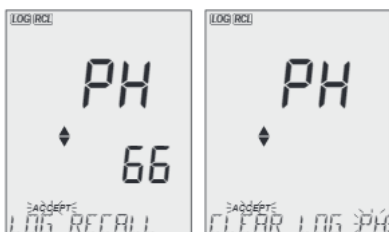

### 10.2.3. Exporting Data

#### PC Export

1. With the meter on, use the supplied micro USB cable to connect to a PC.
2. Press SETUP then CAL/EDIT.
3. Use the ▲▼ keys and select "EXPORT TO PC".  
The meter is detected as a removable drive. LCD displays the PC icon.
4. Use a file manager to view or copy files on the meter.

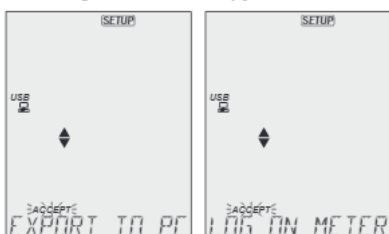

When connected to a PC, to enable logging:

- Press LOG/CLEAR. LCD displays "LOG ON METER" with ACCEPT tag blinking.
- Press GLP/ACCEPT. Meter disconnects from the PC and the PC icon is no longer displayed.
- To return to "EXPORT TO PC" mode, follow steps 2 and 3 above.

Exported data file details:

- The CSV file (comma separated values) may be opened with a text editor or spreadsheet application.
- The CSV file encoding is Western Europe (ISO-8859-1).
- Field separator may be set as comma or semicolon. See Separator Type, GENERAL SETUP OPTIONS section.

**Note:** File prefix depends on measurement log storage locations: "PHLOT###" for pH logs, and "ECLOT###" for EC and TDS logs.

- Interval log files are named PHLOT### or ECLOT###, where ### is the lot number (e.g. PHLOT051 or ECLOT051).
- Manual log file is named PHLOTMAN / ECLOTMAN and stability log file is named PHLOTSTA / ECLOTSTA.

### USB Export All

1. With the meter on, connect a USB flash drive to the meter.
2. Use ▲▼ keys to select "PH" or "EC" log storage location.
3. Press RANGE/▶ to export all logs from the selected location.
4. Press GLP/ACCEPT to confirm.

Confirmation screen displays "DONE" and the meter returns to lot selection screen.

**Note:** The USB flash drive can be safely removed if the USB icon is not displayed. Do not remove the USB drive during export.

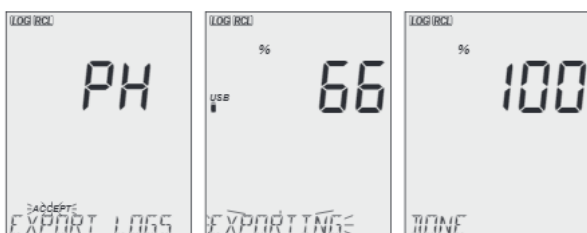

### Overwriting existing data:

When the LCD displays "OVR" with LOT### blinking (USB icon displayed), an identical named lot exists on the USB.

1. Press ▲▼ keys to select option, i.e. YES, NO, YES ALL, NO ALL (ACCEPT tag blinking).
2. Press GLP/ACCEPT to confirm. Not confirming exits the export. Display returns to lot selection screen.

### USB Export Selected

Logged data can be transferred separately by lots.

1. Press RCL to access the logged data.
2. Use ▲▼ keys to select "PH" or "EC" log storage location and press GLP/ACCEPT to confirm.
3. Use ▲▼ keys to select the lot type (MANUAL, STABILITY or interval number)
4. With the lot selected, press RANGE/▶ to export. "PLEASE WAIT" is displayed followed by "EXPORTING" with ACCEPT tag and selected lot name (MAN / STAB / ###) blinking. Confirmation screen displays "DONE" when export is complete and the meter returns to lot-selection screen.

**Note:** The USB flash drive can be safely removed if the USB icon is not displayed. Do not remove the USB drive during export.

Overwriting existing data:

When the LCD displays "EXPORT" with ACCEPT tag and lot number blinking (USB icon displayed), an identically named lot exists on the USB.

1. Press GLP/ACCEPT to continue. "OVERWRITE" is displayed with ACCEPT tag blinking.
2. Press GLP/ACCEPT to confirm. Not confirming exits the export. Display returns to lot selection screen.

#### Data Management Warnings

"NO MANUAL / LOGS"	No manual records saved. Nothing to display.
"NO STABILITY / LOGS"	No stability records saved. Nothing to display.
"OVR" with lot ### (blinking)	Identically named lots on USB. Select overwrite option.
"NO MEMSTICK"	USB drive is not detected. Data cannot be transferred. Insert or check the USB flash drive.
"BATTERY LOW" (blinking)	When low battery, export is not executed. Replace the battery.

#### Logged Data Warnings in CSV file

°C !	Probe used beyond its operation specifications. Data not reliable.
°C !!	Meter in MTC mode.
"Log end - Probe disconnected"	Data logged with the probe disconnected or damaged.

## 11. GLP

Good Laboratory Practice (GLP) allows the user to store and recall calibration data. Correlating readings with specific calibrations ensures uniformity and consistency.

Calibration data is stored automatically after a successful calibration.

1. Press RANGE/▶ to select mode (PH, CONDUCTIVITY, or TDS).
2. From the measurement screen, press GLP/ACCEPT to view GLP data.
3. Use the ▲▼ keys to navigate calibration data displayed on the third LCD line.

**pH Data:** offset, slope, pH calibration solutions, time, date, calibration expiration time (if enabled in SETUP).

**EC/TDS Data:** cell factor (C.F.), offset, EC standard solution, temperature coefficient (T.Coef.), temperature reference (T.Ref.), time, date, calibration expiration time (if enabled in SETUP).

4. Press ESC or GLP/ACCEPT to return to measurement mode.

If the probe has not been calibrated or calibration has been deleted, the blinking "NO CAL" message is displayed in GLP.

If calibration expiration time is disabled, "EXP WARN DIS" is displayed.

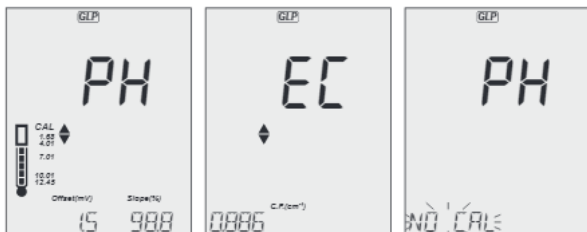

## 12. TROUBLESHOOTING

Symptom	Problem / Solution
Slow response / Excessive drift	Dirty probe. Soak the electrode tip in <b>MA9016</b> for 30 minutes, then follow the Cleaning procedure.
Reading fluctuates up and down (noise)	Clogged/dirty pH electrode junction. Clean the electrode. Refill with fresh <b>MA9012</b> electrolyte. Air bubbles. Tap the probe to remove air bubbles.
Display shows reading blinking	Reading is out of range. Recalibrate the meter. Sample not within measurable range. Disable autoranging feature.
Meter fails to calibrate or gives faulty readings	Broken probe. Replace the probe.
LCD tags displayed continuously at startup	ON/OFF key is blocked. Check the keyboard. If the error persists, contact Milwaukee Technical Service.
"Internal Er X"	Internal hardware error. Restart the meter. If the error persists, contact Milwaukee Technical Service.



**13. ACCESSORIES**

<b>MA852</b>	Pre-amplified pH/EC/TDS/Temperature probe with DIN connector and 1 meter (3.2 feet) cable
<b>MA9001</b>	pH 1.68 buffer solution (230 mL)
<b>MA9004</b>	pH 4.01 buffer solution (230 mL)
<b>MA9006</b>	pH 6.86 buffer solution (230 mL)
<b>MA9007</b>	pH 7.01 buffer solution (230 mL)
<b>MA9009</b>	pH 9.18 buffer solution (230 mL)
<b>MA9010</b>	pH 10.01 buffer solution (230 mL)
<b>MA9112</b>	pH 12.45 buffer solution (230 mL)
<b>M10004B</b>	pH 4.01 buffer solution (20 mL sachet, 25 pcs.)
<b>M10007B</b>	pH 7.01 buffer solution (20 mL sachet, 25 pcs.)
<b>M10010B</b>	pH 10.01 buffer solution (20 mL sachet, 25 pcs.)
<b>MA9060</b>	12880 $\mu\text{S}/\text{cm}$ calibration solution (230 ml)
<b>MA9061</b>	1413 $\mu\text{S}/\text{cm}$ calibration solution (230 ml)
<b>MA9069</b>	5000 $\mu\text{S}/\text{cm}$ calibration solution (230 ml)
<b>M10030B</b>	12880 $\mu\text{S}/\text{cm}$ calibration solution (20 mL sachet, 25 pcs.)
<b>M10031B</b>	1413 $\mu\text{S}/\text{cm}$ calibration solution (20 mL sachet, 25 pcs.)
<b>MA9015</b>	Electrode storage solution (230 mL)
<b>MA9016</b>	Electrode cleaning solution (230 mL)
<b>M10000B</b>	Electrode rinse solution (20 mL sachet, 25 pcs.)
<b>M10016B</b>	Electrode cleaning solution (20 mL sachet, 25 pcs.)

## CERTIFICATION

Milwaukee Instruments conform to the **CE European Directives**.



**Disposal of Electrical and Electronic Equipment.** The product should not be treated as household waste. Instead, hand it over to the appropriate collection point for the recycling of electrical and electronic equipment, which will conserve natural resources.

**Disposal of waste batteries.** This product contains batteries, do not dispose of them with other household waste. Hand them over to the appropriate collection point for recycling. Ensuring proper product and battery disposal prevents potential negative consequences for the environment and human health. For more information, contact your city, your local household waste disposal service, or the place of purchase.

## RECOMMENDATIONS FOR USERS

Before using this product, make sure it is entirely suitable for your specific application and for the environment in which it is used. Any variation introduced by the user to the supplied equipment may degrade the instrument's performance. For your and the instrument's safety do not use or store it in hazardous environments.

## WARRANTY

This instrument is warranted against defects in materials and manufacturing for a period of 2 years from the date of purchase. Electrodes and Probes are warranted for 6 months. This warranty is limited to repair or free of charge replacement if the instrument cannot be repaired. Damage due to accidents, misuse, tampering or lack of prescribed maintenance is not covered by warranty. If service is required, contact your local Milwaukee Instruments Technical Service. If the repair is not covered by the warranty, you will be notified of the charges incurred. When shipping any product, make sure it is properly packaged for complete protection.

*Milwaukee Instruments reserves the right to make improvements in design, construction and appearance of its products without advance notice.*

THANK YOU FOR CHOOSING



Sales and Technical Service Contacts:

MANMW806

Test Equipment Depot - 800.517.8431 - 5 Commonwealth Ave, MA 01801

[TestEquipmentDepot.com](http://TestEquipmentDepot.com)