

HOBO® MX CO₂ Logger (MX1102A) Manual



The HOBO MX CO₂ data logger records carbon dioxide, temperature, and relative humidity (RH) data in indoor environments using non-dispersive infrared (NDIR) self-calibrating CO₂ sensor technology and integrated temperature and RH sensors. This Bluetooth® Low Energy-enabled logger is designed for wireless communication with a mobile device and also supports a USB connection. Using the HOBOMobile® app on your phone or tablet or HOBOWare software on your computer, you can easily configure the logger, read it out, and view plotted data. The logger can calculate minimum, maximum, average, and standard deviation statistics and can be configured to trip audible or visual alarms at thresholds you specify. In addition, it supports burst logging in which data is logged at a different interval when sensor readings are above or below certain limits. This logger also has a built-in LCD screen to display the current CO₂ level, temperature, RH, logging status, battery use, memory consumption, and more.

Specifications

HOBO MX CO₂ Logger

MX1102A

Included Items:

- Four AA 1.5 V alkaline batteries

Required Items:

- HOBOMobile app and Device with iOS or Android™ and Bluetooth
- OR
- HOBOWare 3.7.3 or later and USB cable

Accessories:

- Mounting kit with mounting brackets, screws, tie wraps, and Command™ strip

Temperature Sensor

Range	0° to 50°C (32° to 122°F)
Accuracy	±0.21°C from 0° to 50°C (±0.38°F from 32° to 122°F), see Plot A
Resolution	0.024°C at 25°C (0.04°F at 77°F), see Plot A
Drift	<0.1°C (0.18°F) per year

RH Sensor*

Range	1% to 90% RH (non-condensing)
Accuracy	±2% from 20% to 80% typical to a maximum of ±4.5% including hysteresis at 25°C (77°F); below 20% and above 80% ±6% typical
Resolution	0.01%
Drift	<1% per year typical

CO₂ Sensor

Range	0 to 5,000 ppm
Accuracy	±50 ppm ±5% of reading at 25°C (77°F), less than 90% RH (non-condensing) and 1,013 mbar
Warm-up Time	15 seconds
Calibration	Auto or manual to 400 ppm
Non-linearity	<1% of FS
Pressure Dependence	0.13% of reading per mm Hg (corrected via user input for elevation/altitude)
Operating Pressure Range	950 to 1,050 mbar (use Altitude Compensation for outside of this range)
Compensated Pressure Range	-305 to 5,486 m (-1,000 to 18,000 ft)
Sensing Method	Non-dispersive infrared (NDIR) absorption

Response Time

Temperature	12 minutes to 90% in airflow of 1 m/s (2.2 mph)
RH	1 minute to 90% in airflow of 1 m/s (2.2 mph)
CO ₂	1 minute to 90% in airflow of 1 m/s (2.2 mph)



Logger

Radio Power	1 mW (0 dBm)
Transmission Range	Approximately 30.5 m (100 ft) line-of-sight
Wireless Data Standard	Bluetooth Low Energy (Bluetooth Smart)
Logger Operating Range	0° to 50°C (32° to 122°F); 0 to 95% RH (non-condensing)

*Per RH sensor manufacturer data sheet

Note: The HOBO U-Shuttle (U-DT-1) is not compatible with this logger.

Specifications (continued)

Logging Rate	1 second to 18 hours
Logging Modes	Fixed interval (normal, statistics) or burst
Memory Modes	Wrap when full or stop when full
Start Modes	Immediate, push button, date & time, or next interval
Stop Modes	When memory full, push button, date & time, or after a set logging period
Time Accuracy	±1 minute per month at 25°C (77°F), see Plot B
Power Source	4 AA 1.5 Volt batteries (user replaceable) or USB power source (5 V DC, 2 Watts)
Battery Life	6 months, typical with logging and sampling intervals of 5 minutes or slower; 6 months or less with logging and sampling intervals faster than 5 minutes while logging CO ₂ . Entering burst logging mode will impact battery life. With HOBOMobile use, battery life can be reduced by remaining connected, excessive readouts, checking of Full Status Details, audible alarms, and paging. Visual/audible alarms and other events can have a marginal impact on battery life.
Memory	128 KB (84,650 measurements, maximum)
Download Type	USB 2.0 interface or via Bluetooth Smart
Full Memory Download Time	20 seconds via USB; approximately 60 seconds via Bluetooth Smart, may take longer the further the device is from the logger
LCD	LCD is visible from 0° to 50°C (32° to 122°F); the LCD may react slowly or go blank in temperatures outside this range
Size	7.62 x 12.95 x 4.78 cm (3.0 x 5.1 x 1.88 inches)
Weight	267.4 g (9.43 oz)
Environmental Rating	IP50
	The CE Marking identifies this product as complying with all relevant directives in the European Union (EU).
	See last page

*Per RH sensor manufacturer data sheet

Note: The HOBO U-Shuttle (U-DT-1) is not compatible with this logger.

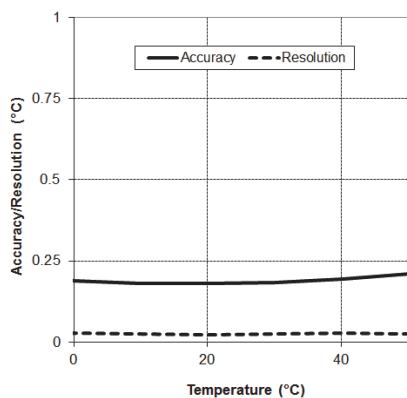

Plot A: Temperature Accuracy and Resolution

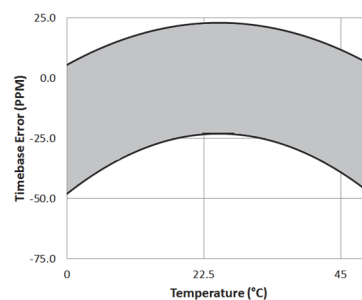

Plot B: Time Accuracy

Logger Components and Operation

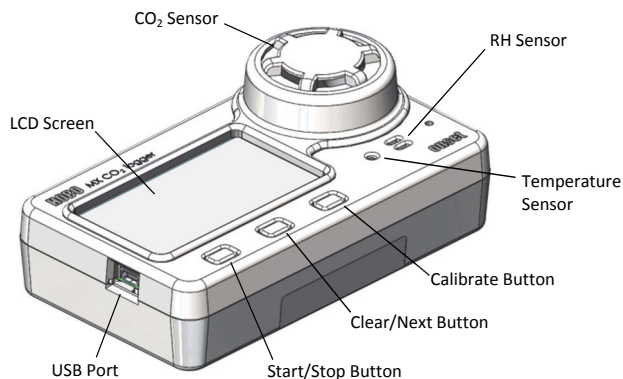

USB Port: Use this port to connect the logger to a computer for use with HOBOWare or to power the logger for longer deployments or if faster logging intervals are required.

Start/Stop Button: Press this button for 3 seconds to start or stop logging data, or to resume logging on the next even logging interval. This requires configuring the logger with a push button start or stop (see *Choosing Logger Settings*). You can also press this button for 1 second to record an internal event (see *Recording Internal Logger Events*), to silence a beeping alarm (see *Setting up Alarms*), or to turn the LCD screen on if the option to turn off the LCD has been enabled (see *Choosing Logger Settings*).

Press both the Start/Stop button and the Clear/Next button simultaneously for 3 seconds to reset a logger password.

Clear/Next Button: Press this button for 1 second to switch between statistics, alarm readings, and the current sensor readings as applicable or to silence a beeping alarm. Press this button for 3 seconds to clear a visual alarm if the logger was configured to maintain the alarm until the button is pressed (see *Setting up Alarms*).

Calibrate Button: Press this button to start a five-minute manual calibration process of the CO₂ sensor. This requires configuring the logger with the manual calibration CO₂ sensor setting enabled in HOBOMobile or HOBOWare and bringing the logger into a fresh air environment (see *Calibrating the Logger*).

Temperature Sensor: This sensor is located to the right of the LCD screen below the large CO₂ sensor.



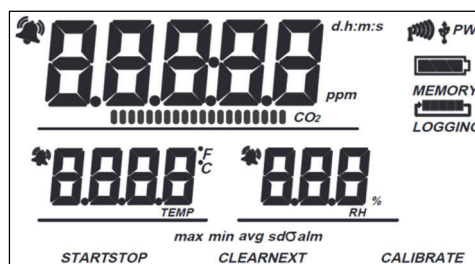

RH Sensor: This sensor is located behind the vented panel in the logger case to the right of the temperature sensor.

CO₂ Sensor: This sensor is located below the large vented circular panel to the right of the LCD screen.

LCD Screen: This logger is equipped with an LCD screen that displays details about the current status. The example shows all symbols illuminated on the LCD screen followed by definitions of each symbol in the table.



LCD Symbol	Description
	The logger is currently communicating with HOBOMobile via Bluetooth. The more bars there are, the stronger the Bluetooth signal.
	The logger is currently communicating with HOBOWare via USB cable.
PWR	The logger is currently being powered by USB cable.
	The battery indicator shows the approximate battery power remaining.
MEMORY 	The logger has been configured to stop logging when memory fills. The memory bar indicates the approximate space remaining in the logger to record data. When first started, all five segments in the bar will be empty. In this example, the logger memory is almost full (only one segment in the memory bar is empty).
MEMORY 	The logger has been configured to never stop logging (wrapping). The logger will continue recording data indefinitely, with newest data overwriting the oldest data until the batteries die or the logger is reconfigured. When first launched, all five segments in the memory bar will be empty. In this example, the memory is full (all five segments are filled in) and new data is now overwriting the oldest data.
LOGGING	The logger is currently logging.
	A sensor reading is above or below the high or low alarm limit that you configured. Press and release the Clear/Next button until the “alm” symbol (described later in this table) is displayed on the screen. This symbol at left will clear depending on how alarms were configured to be cleared in the software. If the alarm was set to clear when the logger is reconfigured or relaunched, this symbol will remain on the LCD until the next time the logger is configured (see <i>Setting up Alarms</i>). Otherwise, it will clear when the sensor reading is back within the alarm limits or by pressing the Clear/Next button for 3 seconds.
START	The logger is waiting to be started. Press and hold the Start/Stop button for 3 seconds to start the logger.
STOP	The logger has been started with push button stop enabled; press and hold the Start/Stop button for 3 seconds to stop the logger.
CLEAR	An alarm displayed on the LCD is ready to be cleared. This will only appear if the logger was configured to maintain the alarm until the Clear/Next button is pressed (for 3 seconds). Note that an audible alarm can be silenced by pressing the Start/Stop button or Clear/Next button for 1 second.
NEXT	Press this button to view the latest statistics (if enabled) or the sensor reading associated with a tripped alarm.

LCD Symbol	Description
CALIBRATE	Press this button for 5 seconds to manually calibrate the CO ₂ sensor (if enabled). "Calibrate" and "CO ₂ " will blink on the LCD during the 5-minute manual calibration process.
max min avg sdσ	These symbols show the maximum, minimum, average, and standard deviation values most recently calculated by the logger (if enabled). Press the Next/Clear button for 1 second to cycle through the available statistics and then back to the current sensor reading (or to the alarm value if applicable).
alm	This is the farthest out-of-range sample displayed during the logger deployment. Press the Clear/Next button to view this reading. Press the Clear/Next button again to cycle through any statistics (defined above) and ultimately back to the current sensor reading.
	This is an example of a CO ₂ reading in parts per million. If the logger is powered by battery: A new segment appears in the status bar every 15 seconds to indicate how long until the display will be updated. In this example, there are 18 segments. This means it has been 4 minutes and 30 seconds since the CO ₂ reading was updated on the LCD. There are 30 seconds left (two segments) before the reading will be updated on the LCD. If the logger is powered by USB cable: The segmented status bar is not displayed and the current reading is updated every second.
	This is an example of a temperature reading. Temperature units are determined by the settings in the software. To switch between Celsius and Fahrenheit, change the units in the software and then reconfigure the logger. Temperature readings are updated on the LCD every 15 seconds if the logger is battery-powered or every second if it is USB-powered regardless of logging interval.
	This is an example of an RH reading. RH readings are updated on the LCD every 15 seconds if the logger is battery-powered or every second if it is USB-powered regardless of logging interval.
	The logger has been configured to start logging on a particular date/time. The display will count down in days, hours, minutes, and seconds until logging begins. In this example, 5 minutes and 38 seconds remain until logging will begin.
LoAd	The configure settings are being loaded onto the logger from the software.
Err	An error occurred while loading the configure settings onto the logger from the software. Try reconfiguring the logger.
StoP	The logger has been stopped with the software or because the memory is full.

Notes:

- You can disable the LCD screen in the software. When the LCD is turned off for logging, you can still temporarily view the LCD screen by pushing the Start/Stop or Clear/Next button. The LCD will then remain on for 10 minutes.
- When the logger is connected to the computer with the USB cable, the LCD screen refreshes every second regardless of logging interval.
- When the logger has stopped logging, the LCD screen will remain on with "STOP" displayed until the logger is

offloaded (unless the LCD screen was turned off in the software). Once the logger has been offloaded, the LCD will turn off automatically after 2 hours.

- The LCD screen flashes "HELLO" when you page the logger from HOBOMobile (see *Getting Started with HOBOMobile*).
- The LCD screen flashes "CHIRP OFF" when an audible alarm is cleared.

Setting up the Logger

Important: The CO₂ sensor within this logger can experience measurement drift during storage and shipment. It is strongly recommended that a manual calibration be performed prior to deploying the logger. Start the logger as described in this section and perform a manual calibration. See *Calibrating the Logger* for more details; follow the manual calibration steps in that section. Improper manual calibration can cause incorrect sensor readings.

Install the batteries in the logger. Use a Phillips-head screwdriver to open the battery cover on the back of the logger and insert four AA batteries observing polarity (see *Battery Information*). Screw the cover back in place.

You can use both the HOBOMobile app and HOBOWare software with this logger. The following sections provide an overview for using the logger with both programs. You can switch back and forth between the two programs (for example, configure the logger in HOBOWare, and read it out in HOBOMobile). However, you can only connect to one program at a time. If you attempt to use HOBOMobile while the logger is connected to HOBOWare, a message appears in HOBOMobile indicating a live USB session is underway. If you attempt to use the logger in HOBOWare while it is connected to HOBOMobile, the device will not be found. If you want to connect to HOBOMobile after using the logger with HOBOWare, you will need to disconnect the USB cable once you are done with HOBOWare.

Getting Started with HOBOMobile

These steps provide an overview of setting up the logger with HOBOMobile. For complete details, see the *HOBOMobile User's Guide*.

1. Go to the App Store® or Google Play™ and download HOBOMobile to your phone or tablet.
2. Open HOBOMobile and enable Bluetooth in your device settings if prompted.
3. Tap  and then tap the logger in the In Range list to connect to it. If the logger does not appear in the list, follow these tips for connecting:
 - Make sure the logger is within range of your mobile device. The range for successful wireless communication is approximately 30.5 m (100 ft) with full line-of-sight.
 - If your device can connect to the logger intermittently or loses its connection, move closer to the logger, within sight if possible.
 - If the logger appears in the In Range list, but you cannot connect to it, close HOBOMobile and power cycle the

mobile device. This forces the previous Bluetooth connection to close.

- Once connected, tap Configure.



- Choose your logger settings in the Configure screen. See *Choosing Logger Settings* for details on the available settings.
- Tap the CO₂ sensor and select manual and/or auto calibration (both are selected by default). Select Altitude Compensation and enter the altitude above or below sea level. Tap Done. See *Calibrating the Logger* for more details on calibration settings.

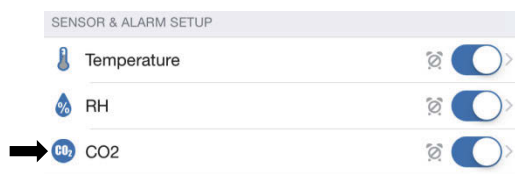

- Tap Start in the upper right corner of the Configure screen.

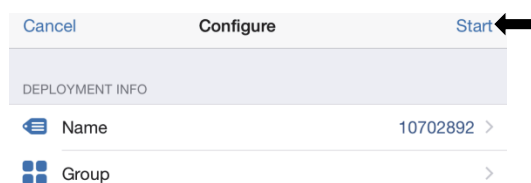

Logging will begin based on the settings you selected. Deploy the logger using the included mounting materials (see *Mounting the Logger*). After logging begins, you can read out the logger at any time (see *Reading Out the Logger* for details).

Note: The sensor readings displayed within HOBOMobile may not match what is displayed on the logger. The readings in the HOBOWare screen are updated every minute and the readings in the Connected screen and Status Details screen are updated every 5 seconds.

When connected to the logger, the following actions are also available in addition to configure:

- Readout.** Offload logger data. See *Reading Out the Logger*.
- Full Status Details.** Check the battery level and view the configuration settings currently selected for the logger.
- Start Logging.** This option appears if On Button Push is selected as a Start Logging setting as described in the *Choosing Logger Settings*.
- Stop Logging.** Stop the logger from recording data (this overrides any Stop Logging settings described in *Choosing Logger Settings*).

- Page.** Press and hold the Page icon and the logger will beep to help you locate a deployed logger (tap the Page icon if you only want the logger to beep once). “HELLO” also appears on the LCD when the logger is paged.
- Clear Audible Alarm.** If audible alarms are enabled as described in *Setting up Alarms*, use this to clear a beeping alarm on the logger.
- Logger Password.** Select this to create a password for the logger that will be required if another mobile device attempts to connect to it. To reset a password, simultaneously press both the Start/Stop button and the Clear/Next button for 3 seconds or tap Reset to Factory Default in the Set Logger Password screen.
- Update Firmware.** When new logger firmware is available, this action appears in the list. Select it and follow the instructions on the screen. A logger readout will be completed automatically at the beginning of the firmware update process. If the connection is lost between the logger and the mobile device during the firmware update, a Firmware Update Pending Status displays for the logger in the HOBOWare list. Connect to the logger and select Restore Logger (or Update Firmware if that option is available) to continue updating the firmware.

Important: Before updating the firmware on the logger, check the remaining battery level by selecting Full Status Details and make sure it is no less than 30%. Make sure you have the time to complete the entire update process, which requires that the logger remains connected to the device during the upgrade.

- Force Offload.** This may appear if an error was encountered when loading configure settings. Select this to offload all the data on the logger before reconfiguring the logger.

Getting Started with HOBOWare

These steps provide an overview of setting up the logger with HOBOWare. For complete details, see the HOBOWare Help.

- Install HOBOWare on your computer.
- Connect the logger to the computer with a USB cable.

Important: USB 2.0 specifications do not guarantee operation outside the range of 0°C (32°F) to 50°C (122°F).

- From the device menu in HOBOWare, select Launch.
- Choose your logger settings. See *Choosing Logger Settings* for details on the available settings.
- Click the CO₂ Settings button and select manual and/or auto calibration (both are selected by default). Select “Use Carbon Dioxide sensor altitude compensation” and enter the altitude above or below sea level. Click OK. See *Calibrating the Logger* for more details on calibration settings.

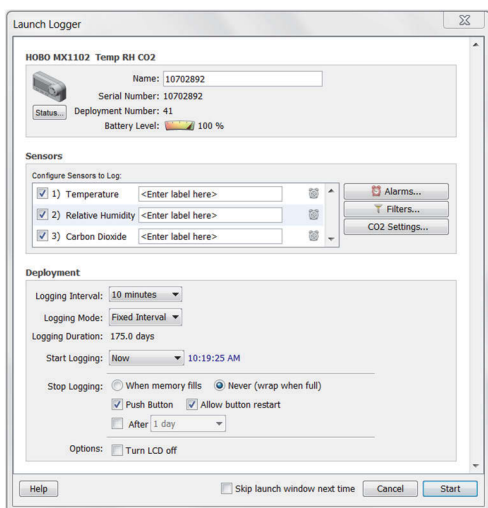

6. Click the Start button when finished. Note that the Start button text changes based on your Start Logging selection.

Logging will begin based on the settings you selected. Deploy the logger using the included mounting materials (see *Mounting the Logger*). After logging begins, you can read out the logger at any time (see *Reading Out the Logger* for details).

Choosing Logger Settings

The following table lists the available settings when configuring the logger with HOBOMobile or HOBOWare.

Logger Setting	Action
Name	Enter a name for the logger up to 20 characters. This name will be used as the title on the graph and in the file name. A name also helps identify the logger in the HOBOS screen in HOBOMobile. If no name is entered, the logger serial number is used.
Group (HOBOMobile only)	Add the logger to the Favorites group or a custom group to help identify the logger and its resulting data files.
Logging Interval	Select how often the logger will record data.
Start Logging Options	Choose one of the following: <ul style="list-style-type: none"> • Now. Logging will begin 15 seconds after selecting Start. • On Next Logging Interval. Logging will begin at the next even interval as determined by the selected logging interval. • On Button Push. Logging will begin 15 seconds after you press the Start/Stop logging button on the logger for 3 seconds. • On Date/Time. Logging will begin at a date and time you specify.
Stop Logging Options	Choose a memory option: <ul style="list-style-type: none"> • When Memory Fills. The logger will continue recording data until the memory is full. • Never (Wrap When Full). The logger will continue recording data indefinitely, with newest data overwriting the oldest. This option is not available if the Logging Mode is set to Burst (see <i>Burst Logging</i>). Choose this stop logging option if desired: <ul style="list-style-type: none"> • On Button Push. Select this if you want to be

Logger Setting	Action
----------------	--------

able to stop logging by pushing the Start/Stop button on the logger. Note that if you also choose On Button Push for the Start Logging option, then you will not be able to stop logging until 30 seconds after logging begins.

Choose a Stop Logging time-based option.

- **Never.** Select this if you do not want the logger to stop at any predetermined time frame.
- **On Date/Time.** Select this if you want the logger to stop logging on a specific date and time. Select the date and time and then tap Done.
- **After.** Select this if you want to control how long the logger should continue logging once it starts. Choose the amount of time you want the logger to log data and then tap Done. For example, select 30 days if you want the logger to log data for 30 days after logging begins.

Sensor & Alarm Setup	Enable the sensor measurement types that will be logged: temperature, RH, and/or CO ₂ . Both temperature and RH are required to calculate dew point, which is an additional data series available for plotting after reading out the logger. You can configure alarms for sensors. See <i>Setting up Alarms</i> . If logging CO ₂ , you can select calibration settings. See <i>Calibrating the Logger</i> .
----------------------	--

Logging Mode	Choose a logging mode: <ul style="list-style-type: none"> • Fixed Interval Logging. The logger will record data for all enabled sensors at the selected logging interval. • Burst Logging. In burst mode, logging occurs at a different interval when a specified condition is met. See <i>Burst Logging</i> for more information. • In HOBOMobile, select Normal if you want the logger to log current readings. Select each statistic you want the logger to log. In HOBOWare, select Statistics and then select Current Reading if you want sensor readings to be logged. Select each statistic you want the logger to log. Current readings and statistics are logged at the logging interval rate. See <i>Statistics Logging</i> for more information.
--------------	--

Show LCD	Enable or disable to control whether the LCD remains illuminated while the logger is logging. If you disable the LCD, the logger will not show the current reading, status, or other information while the logger is logging. You will, however, be able to temporarily turn the LCD screen on by pressing the Start/Stop button on the logger for 1 second.
----------	--

Calibrating the Logger

The CO₂ sensor in the logger requires altitude compensation and regular calibration to ensure accurate readings are being taken in the location where it is deployed. Both auto and manual calibration are selected by default when first configuring the logger. Altitude compensation should be used if you are monitoring CO₂ at elevations above or below 305 meters (1,000 feet).

Some CO₂ measurement drift may occur during shipment and storage. A manual calibration immediately after logging begins is recommended for best accuracy.

Important: If performing a manual calibration, be sure to follow the instructions later in this section. Improper manual calibration can result in incorrect sensor readings.

The following CO₂ settings are available in both HOBOMobile and HOBOWare:

- **Manual calibration.** Manual calibration is the best way to calibrate your logger. Use this option if you want to manually calibrate the logger to 400 ppm using the Calibrate button on the logger. This requires taking the logger outside in fresh air on a dry day or to an indoor location that is unoccupied and has no connection to a ventilation system for five minutes on a regular basis. Press the Calibrate button on the logger for 5 seconds to manually calibrate the CO₂ sensor. “Calibrate” and “CO₂” will blink on the LCD during the 5-minute manual calibration process in which 300 measurements are taken to get the average and create the offset from 400 ppm. (See the steps later in this section for more details on manual calibration.) This is recommended if the logger is deployed in a building that is always occupied, if you want the logger to be calibrated more frequently than every eight days (the normal auto calibration schedule), or if you want to calibrate the logger immediately after logging begins. **Note:** Once a manual calibration is performed, the 24-hour auto calibration is canceled and an auto calibration will be performed eight days from the time the manual calibration occurred.
- **Auto calibration.** Use this option if you want the logger to automatically calibrate within the first 24 hours after logging begins and then every eight days thereafter. The logger will be calibrated based on the average of the three CO₂ measurements that follow the lowest CO₂ value identified during the 24-hour or 8-day time period as applicable.

Important: Accurate auto-calibration requires the building or location where the logger is deployed to be empty at least once during the eight-day period (for example, an empty office building during the weekend or overnight will typically have background CO₂ levels of 400 to 450 ppm).

If the logger is deployed in an area where the CO₂ level does not go down to 400 ppm during the eight-day time period, then manual calibration should be performed regularly instead or inaccurate CO₂ readings will be reported. If you plan on using auto calibration but the A mabuilding will be occupied during the first day after logging begins, then you can use the manual calibration option as well. You can manually calibrate the logger immediately after logging begins and use auto calibration thereafter. **Note:** Every time the logger is started, auto calibration will occur after 24 hours and then again after eight days unless a manual calibration is performed first.

- **Altitude compensation.** The CO₂ sensor must compensate for locations above or below 305 meters (1,000 feet) to provide an accurate reading. You must enter the altitude above or below sea level in either meters or feet when configuring the logger if it will be deployed at a location above or below sea level. In normal use, the CO₂ measurement will vary by approximately 0.135% of the reading for each mbar change in barometric pressure (the

sensor is calibrated at 1,013 mbar). Use altitude compensation when deploying the logger for the best CO₂ accuracy possible.

To access calibration and altitude compensation settings in HOBOMobile:

1. Connect to the logger.
2. Tap Configure.
3. Tap the CO₂ sensor.
4. Select auto calibration, manual calibration, or both.
5. Select “Altitude Compensation” and enter the altitude above or below sea level where the logger will be deployed in either meters or feet. You can also tap Use Location if you want the location services within the phone or tablet to calculate altitude.
6. Tap Done.
7. Tap Start to load settings to the logger.

To access calibration and altitude compensation settings in HOBOWare:

1. Connect the logger to the computer with the USB cable.
2. From the Device menu in HOBOWare, select Launch.
3. Click the CO₂ Settings button.
4. Select auto calibration, manual calibration, or both.
5. Select “Use Carbon Dioxide sensor altitude compensation” and enter the altitude above or below sea level where the logger will be deployed in either meters or feet.
6. Click OK.
7. Click Start in the Launch Logger window to load settings to the logger.

Note: If both auto calibration and manual calibration are selected, the logger will automatically calibrate within 24 hours after logging begins unless a manual calibration occurs during that time period. In addition, when both calibration settings are selected, the eight-day calibration cycle will be reset any time a manual calibration is performed.

To manually calibrate the CO₂ sensor:

Important: If you do not follow these manual calibration instructions as described, the sensor readings will be incorrect and you will need to manually calibrate the logger again.

1. Take the logger outside in fresh air on a dry day where the carbon dioxide level is 400 ppm. You can also use an indoor location for manual calibration if it is unoccupied and is not exposed to a ventilation system.
2. Press the Calibrate button on the logger for 5 seconds until it beeps. The logger will then calibrate for 5 minutes. The CO₂ and Calibrate symbols on the LCD will flash while the calibration is underway. A time- and date-stamped manual calibration event is logged in the data at the end of the 5-minute calibration sequence.
3. Once the Calibration process is complete, return the logger to its deployment location. Repeat this process at least once every eight days for best accuracy.

Setting up Alarms

You can set an alarm to trip on the logger when a sensor reading rises above or falls below a specified value. This can

alert you to problems so you can take corrective action. To set up a sensor alarm:

1. In HOBOMobile: Connect to the logger and tap Configure.
In HOBOWare: From the device menu, select Launch. Click the Alarms button in the Launch Logger window.
2. Select the sensor that you want to set up with an alarm condition.
3. Enable the High Alarm if you want an alarm to trip when the sensor reading rises above the high alarm value. Drag the slider to the reading that will trip the alarm or type a specific reading.
4. Enable the Low Alarm if you want an alarm to trip when the sensor reading falls below the low alarm value. Drag the slider to the reading that will trip the alarm or type a specific reading.
5. Set the duration before an alarm is tripped.
6. Select either Cumulative Samples or Consecutive Samples. If you select Cumulative Samples, then the alarm will trip when the time the sensor is out of range over the course of the deployment is equal to the selected duration. If you select Consecutive Samples, then the alarm will trip when the time the sensor is continuously out of range is equal to the selected duration. For example, the high alarm for temperature is set to 85°F and the duration is set to 30 minutes. If Cumulative is selected, then an alarm will trip once a sensor reading has been at or above 85°F for a total of 30 minutes since the logger was configured; specifically, this could be 15 minutes above 85°F in the morning and then 15 minutes above 85°F again in the afternoon. If Consecutive is selected, then an alarm will trip only if all sensor readings are 85°F or above for a continuous 30-minute period.
7. Repeat steps 2–6 for any other sensors if desired (tap Done in HOBOMobile first).
8. Enable Audible Alarms if you want a beep to sound on the logger every 30 seconds when the sensor alarm trips (in HOBOMobile, enable this in the Configure screen; in HOBOWare, select the Use Audible Alarm checkbox in the Configure Alarms window). The beeping will continue until the alarm is cleared from the software, a button on the logger is pressed, or 7 days have passed. Battery life will be slightly reduced when this setting is enabled. It is recommended that you only enable this feature if you have regular access to the logger so that you can easily turn off the beeping.
9. Select one of the following options for when to clear the alarm symbol that appears on the LCD (in HOBOMobile, enable this in the Configure screen; in HOBOWare, select the checkbox in the Configure Alarms window).
 - **Logger reconfigured or relaunched.** The alarm icon will remain visible on the LCD until the next time the logger is reconfigured.
 - **Sensor is in limits.** The alarm icon will remain visible on the LCD until the sensor reading returns to the normal range between any configured high and low alarm limits.
 - **Alarm button is pressed.** The alarm icon will remain visible until you press the Clear/Next button on the logger.
10. In HOBOMobile: Tap Start in the Configure screen to load the alarm settings onto the logger when ready.
In HOBOWare: Click OK in the Configure Alarms window and then click Start in the Launch Logger window when ready.

Notes about alarms:

- The alarm icon will be illuminated on the logger LCD when the alarm trips. You can also press the Clear/Next button on the logger to view the farthest out-of-range value during the deployment.
- Alarm limits for temperature and RH sensors are checked every 15 seconds. The CO₂ alarm limits are checked every 15 seconds if the logger is powered by USB cable or every 5 minutes if it is powered by batteries. If you are configuring a CO₂ sensor alarm for a battery-powered logger, it is recommended that the duration you select is divisible by 5 and a minimum of 5 minutes.
- For USB-powered loggers, CO₂ alarms will not be tripped for the first 15 seconds after logging begins as the CO₂ sensor requires a 15-second warmup period.
- The actual values for the high and low alarm limits are set to the closest value supported by the logger. For example, the closest value to 85°F that the logger can record is 84.990°F and the closest value to 32°F is 32.043°F. In addition, alarms can trip or clear when the sensor reading is within the logger specifications of 0.02°C resolution. This means the value that triggers the alarm may differ slightly than the value entered. For example, if the High Alarm is set to 75.999°F, the alarm can trip when the sensor reading is 75.994°F (which is within the 0.02°C resolution).
- When you read out the logger, alarm events can be displayed on the plot or in the data file. See *Recording Internal Logger Events*.
- Once cleared, an audible alarm will start beeping again if the sensor values go out of the normal range. Even if an audible alarm is cleared, a visual alarm may remain on the logger LCD and in HOBOMobile (if applicable) depending on the settings selected for maintaining visual alarms or because the alarm condition may still be in effect. In addition, an audible alarm will continue beeping when the sensor values have returned to the normal range until it is cleared.
- Although an audible alarm and a visual alarm can occur at the same time when a sensor alarm is tripped, they are cleared in different ways. The audible alarm can be cleared from within the software, a button on the logger is pressed, or 7 days have passed. Meanwhile, a visual alarm is cleared as determined by the setting selected for maintaining an alarm in the software. This means you could clear a beeping audible alarm and the visual alarm will remain on the LCD and in HOBOMobile (if applicable) until the logger is reconfigured, the sensor is in limits, or the alarm button is pressed—whichever setting you selected.
- If the logger was configured to stop logging with a button push, any tripped alarms will be cleared automatically when logging is stopped and no Alarm Cleared event will be logged in the data file.

Burst Logging

Burst logging is a logging mode that allows you to set up more frequent logging when a specified condition is met. For example, a logger is recording data at a 5-minute logging interval and burst logging is configured to log every 30 seconds when the temperature rises above 85°F (the high limit) or falls below 32°F (the low limit). This means the logger will record data every 5 minutes as long as the temperature remains between 85°F and 32°F. Once the temperature rises above 85°F, the logger will switch to the faster logging rate and record data every 30 seconds until the temperature falls back to 85°F. At that time, logging then resumes every 5 minutes at the normal logging interval. Similarly, if the temperature falls below 32°F, then the logger would switch to burst logging mode again and record data every 30 seconds. Once the temperature rises back to 32°F, the logger will then return to normal mode, logging every 5 minutes.

To set up burst logging:

1. In HOBOMobile: Connect to the logger and tap Configure.
In HOBOWare: From the Device menu, select Launch.
2. Set the Logging Mode to burst logging. (If already selected in HOBOWare, click the Edit button.)
3. Select the sensor that will have burst limits.
4. Enable High Limit if you want burst logging to occur when the sensor reading rises above a specific reading. Drag the slider to the reading that will trigger burst logging or type a specific reading.
5. Enable Low Limit if you want burst logging to occur when the sensor reading falls below a specific reading. Drag the slider to the reading that will trigger burst logging or type a specific reading.
6. Repeat steps 3–5 for any other sensors if desired (tap Done in HOBOMobile first).
7. Set the burst logging interval. Select an interval faster than the logging interval. Keep in mind that the more frequent the burst logging rate, the greater the impact on battery life and the shorter the logging duration. In HOBOMobile, tap Done.
8. In HOBOMobile: Tap Done to return to the Configure screen. Tap Start to load the burst settings onto the logger when ready.
In HOBOWare: Click OK in the Burst Logging window and then click Start in the Launch Logger window when ready.

Notes about Burst Logging:

- Sensor alarms, statistics, and the Stop Logging option “Never (Wrapping)” are not available in burst logging mode.
- Once the logger is configured, the high and low burst limits are checked every 15 seconds. Therefore, if you set the logging interval to less than 15 seconds and the sensor reading falls outside the levels, the burst logging will not begin until the next 15-second cycle.
- If high and/or low limits have been configured for more than one sensor, then burst logging will begin when any high or low condition goes out of range. Burst logging will not end until all conditions on all sensors are back within normal range.

- The actual values for the burst logging limits are set to the closest value supported by the logger. For example, the closest value to 85°F that the logger can record is 84.990°F and the closest value to 32°F is 32.043°F.
- Burst logging mode can begin or end when the sensor reading is within the logger specifications of 0.02°C resolution. This means the value that triggers burst logging may differ slightly than the value entered. For example, if the high limit for a temperature alarm is set to 75.999°F, burst logging can start when the sensor reading is 75.994°F (which is within the 0.02°C resolution).
- Once the high or low condition clears, the logging interval time will be calculated using the last recorded data point in burst logging mode, not the last data point recorded in “normal mode.” For example, a logger has a 10-minute logging interval and logged a data point at 9:05. Then, the high limit was surpassed and burst logging began at 9:06. Burst logging then continued until 9:12 when the sensor reading fell back below the high limit. Now back in normal mode, the next logging interval will be 10 minutes from the last burst logging point, or 9:22 in this case. If burst logging had not occurred, the next data point would have been at 9:15.
- A New Interval event is created each time the logger enters or exits burst logging mode. See *Recording Internal Logger Events* for details on plotting and viewing the event. In addition, if the logger is stopped with a button push while in burst logging mode, then a New Interval event is automatically logged and the burst condition is cleared, even if the actual high or low condition has not cleared.

Statistics Logging

During fixed interval logging, the logger records data for enabled sensors and/or selected statistics at the logging interval selected. Statistics are calculated at a sampling rate you specify with the results for the sampling period recorded at each logging interval. The following statistics can be logged for each sensor:

- The maximum, or highest, sampled value,
- The minimum, or lowest, sampled value,
- An average of all sampled values, and
- The standard deviation from the average for all sampled values.

For example, a logger is configured with the temperature and CO₂ sensors enabled and the logging interval set to 5 minutes. The current reading and all four statistics are enabled. The statistics sampling interval is set to 30 seconds. Once logging begins, the logger will measure and record the actual temperature and CO₂ sensor values every 5 minutes. In addition, the logger will take a temperature and CO₂ sample every 30 seconds and temporarily store them in memory. The logger will then calculate the maximum, minimum, average, and standard deviation using the samples gathered over the previous 5-minute period and log the resulting values. When reading out the logger, this would result in the following 10 data series (not including any derived series): two sensor series (with temperature and CO₂ current readings logged every 5 minutes) plus eight maximum, minimum, average, and standard

deviation series (four for temperature and four for CO₂ with values calculated and logged every 5 minutes based on the 30-second sampling rate).

To set up statistics:

- In HOBOMobile: Connect to the logger and tap Configure.
In HOBOWare: From the Device menu, select Launch.
- In HOBOMobile: Tap Logging Mode and then select Fixed Interval Logging.
In HOBOWare: Select Statistics for the logging mode.
- Select Normal in HOBOMobile or Current Reading in HOBOWare to record the current reading for each enabled sensor at the logging interval selected. Do not select this if you only want to log statistics.
- Select the statistics you want the logger to record at each logging interval: Maximum, Minimum, Average, and Standard Deviation (average is automatically enabled when selecting Standard Deviation). Statistics will be logged for all enabled sensors. In addition, the more statistics you record, the shorter the logger duration and the more memory is required.
- Set the statistics sampling interval. The rate selected must be less than, and a factor of, the logging interval. For example, if the logging interval is 1 minute and you select 5 seconds for the sampling rate, then the logger will take 12 sample readings between each logging interval (one sample every 5 seconds for a minute) and use the 12 samples to record the resulting statistics at each 1-minute logging interval. Note that the more frequent the sampling rate, the greater the impact on battery life. In HOBOMobile, tap Done.
- In HOBOMobile: Tap Done to return to the Configure screen. Tap Start to load the burst settings onto the logger when ready.
In HOBOWare: Click OK in the Burst Logging window and then click Start in the Launch Logger window when ready.

Once logging begins, press the Clear/Next button on the logger to cycle through the current maximum, minimum, average, and standard deviation data on the LCD screen. Note that the logger will always display the current sensor readings in HOBOMobile (If applicable) even if they are not being logged. You can plot the statistics series once you read out the logger.

Reading Out the Logger

To offload data from the logger to HOBOMobile:

- Connect to the logger and tap Readout.
- Tap  to view a mini-graph of the offloaded data.
- Tap the mini-graph to view a larger version of the graph or to share the file. See the *HOBOMobile User's Guide* for details on viewing graphs and sharing data. Data can also be uploaded automatically to HOBOLink, Onset's web-based software. For details on working with data in HOBOLink, refer to the HOBOLink Help.

To offload data from the logger to HOBOWare:



- Connect the logger to the computer with the USB cable.
- From the Device menu, select Readout.

- Save the data file when prompted. See the HOBOWare Help for details on plotting and exporting data in HOBOWare.

Note: Data files read out from the logger in one program are not automatically available in the other. To open HOBOMobile files in HOBOWare, share the file and select HOBO as the file type. Email the file and then open it in HOBOWare. Files in HOBOWare cannot be viewed in HOBOMobile. You can, however, export data in HOBOWare to a text or Excel file that you can open on your mobile device. See the *HOBOMobile User's Guide* and HOBOWare Help for details on sharing or exporting data.

Recording Internal Logger Events

The logger records the following internal events to track logger operation and status.

To plot events in HOBOMobile, tap a mini-graph and then tap  in the upper right corner. Select the events you wish to plot and then tap  in the upper left. You can also view events in shared or exported data files.

To plot events in HOBOWare, select the events you wish to plot in the Plot Setup window when opening a data file. The following events may occur:

Internal Event Name	Definition
Host Connected	The logger was connected to the mobile device or computer as applicable.
Started	The Start/Stop button was pressed to begin or resume logging.
Stopped	The logger received a command to stop recording data (from the software or by pushing the Start/Stop button).
Button Up/Button Down	The Start/Stop button was pressed for 1 second.
Chan <#> Alarm Tripped	A sensor alarm has tripped; <#> is the sensor number, where 1 is CO ₂ , 2 is temperature, and 3 is RH.
Chan <#> Alarm Cleared	A sensor alarm has cleared; <#> is the sensor number, where 1 is CO ₂ , 2 is temperature, and 3 is RH. This event also contains the value that was furthest out of range for the sensor before the alarm cleared, which is only available in a shared or exported file.
New Interval	The logger has entered or exited burst logging mode.
Automatic Calibration	The CO ₂ sensor has been calibrated automatically; the data file will show the offset calculated in PPM during the calibration.
Manual Calibration	The CO ₂ sensor has been manually calibrated; the data file will show the offset calculated in PPM during the calibration.
Safe Shutdown	The battery level dropped below 3.7 V; the logger performs a safe shutdown.

Mounting the Logger

There are several ways to mount the logger using the materials included:

- Attach Command strips to the back of the logger to mount it to a wall or other flat surface.
- Screw in the brackets onto both sides of the logger using the two small holes labeled in the diagram below and then use tie wraps to mount it to a pole or pipe.
- Mount the logger to the wall or a flat surface using two screws and the included template. The dimensions are also shown in the following example.

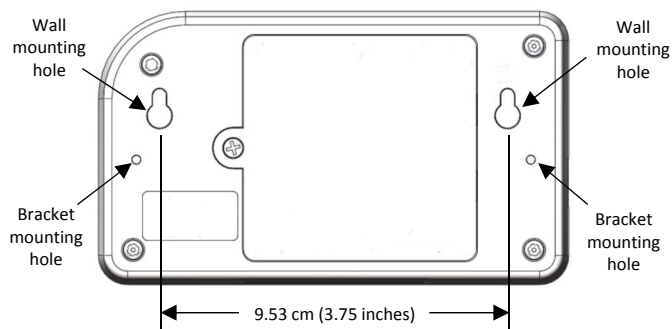

Protecting the Logger

The logger is designed for indoor use and can be permanently damaged by corrosion if it gets wet. Protect it from condensation. If the message FAIL CLK appears on the LCD screen, there was a failure with the internal logger clock possibly due to condensation. Remove the battery immediately and dry the circuit board.

Note: Static electricity may cause the logger to stop logging.

The logger has been tested to 8 KV, but avoid electrostatic discharge by grounding yourself to protect the logger. For more information, search for “static discharge” on onsetcomp.com.

Battery Information

The logger requires four user-replaceable AA 1.5 V alkaline or optional lithium batteries for operation at the extreme ends of the logger operating range. Expected battery life varies based on the ambient temperature where the logger is deployed, the logging or sampling interval, frequency of offloading and connection to a mobile device, number of channels that are active, audible alarms duration, use of burst mode or statistics logging, and battery performance. New batteries typically last 6 months with logging and sampling intervals greater than 5 minutes.

Deployments in extremely cold or hot temperatures, or a logging or sampling interval faster than 5 minutes can impact battery life. Estimates are not guaranteed due to uncertainties in initial battery conditions and operating environment.

The logger can also be powered by the USB cable if faster logging intervals are desired or when the remaining battery voltage is too low for it to continue logging. Connect the logger to the computer, click the Readout button on the toolbar in HOBOWare, and save the data as prompted. Replace the battery before launching the logger again.

To install or replace the batteries:

1. Use a Phillips-head screwdriver to unscrew the battery cover on the back of the logger.

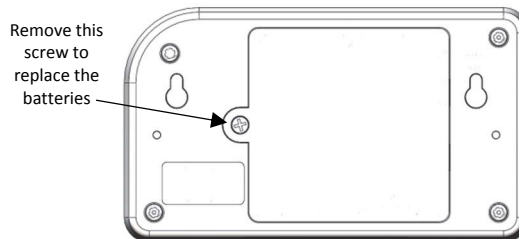

2. Remove any old batteries.
3. Insert four new batteries observing polarity.
4. Screw the battery cover back in place.

⚠ WARNING: Do not cut open, incinerate, heat above 85°C (185°F), or recharge the lithium batteries. The batteries may explode if the logger is exposed to extreme heat or conditions that could damage or destroy the battery case. Do not dispose of the logger or batteries in fire. Do not expose the contents of the batteries to water. Dispose of the batteries according to local regulations for lithium batteries.

Note: CO₂ sensor readings may temporarily appear as 0 ppm in HOBOMobile when replacing the batteries until the logger begins logging again.

Federal Communication Commission Interference Statement

This equipment has been tested and found to comply with the limits for a Class B digital device, pursuant to Part 15 of the FCC Rules. These limits are designed to provide reasonable protection against harmful interference in a residential installation. This equipment generates uses and can radiate radio frequency energy and, if not installed and used in accordance with the instructions, may cause harmful interference to radio communications. However, there is no guarantee that interference will not occur in a particular installation. If this equipment does cause harmful interference to radio or television reception, which can be determined by turning the equipment off and on, the user is encouraged to try to correct the interference by one of the following measures:

- Reorient or relocate the receiving antenna
- Increase the separation between the equipment and receiver
- Connect the equipment into an outlet on a circuit different from that to which the receiver is connected
- Consult the dealer or an experienced radio/TV technician for help

This device complies with Part 15 of the FCC Rules. Operation is subject to the following two conditions: (1) This device may not cause harmful interference, and (2) this device must accept any interference received, including interference that may cause undesired operation.

FCC Caution: Any changes or modifications not expressly approved by the party responsible for compliance could void the user's authority to operate this equipment.

Industry Canada Statements

This device complies with Industry Canada license-exempt RSS standard(s). Operation is subject to the following two conditions: (1) this device may not cause interference, and (2) this device must accept any interference, including interference that may cause undesired operation of the device.

Avis de conformité pour l'Industrie Canada

Le présent appareil est conforme aux CNR d'Industrie Canada applicables aux appareils radio exempts de licence. L'exploitation est autorisée aux deux conditions suivantes : (1) l'appareil ne doit pas produire de brouillage, et (2) l'appareil doit accepter tout brouillage radioélectrique subi, même si le brouillage est susceptible d'en compromettre le fonctionnement.

To comply with FCC and Industry Canada RF radiation exposure limits for general population, the HOBO MX logger must be installed to provide a separation distance of at least 20 cm from all persons and must not be co-located or operating in conjunction with any other antenna or transmitter.

NCC Statement

經型式認證合格之低功率射頻電機，非經許可，公司、商號或使用者均不得擅自變更頻率、加大功率或變更原設計之特性及功能。

低功率射頻電機之使用不得影響飛航安全及干擾合法通信；經發現有干擾現象時，應立即停用，並改善至無干擾時方得繼續使用。前項合法通信，指依電信法規定作業之無線電通信。低功率射頻電機須忍受合法通信或工業、科學及醫療用電波輻射性電機設備之干擾。

Translation:**Article 12**

Without permission granted by the NCC, any company, enterprise, or user is not allowed to change frequency, enhance transmitting power or alter original characteristic as well as performance to an approved low power radio-frequency device.

Article 14

The low power radio-frequency devices shall not influence aircraft security and interfere with legal communications. If found, the user shall cease operating immediately until no interference is achieved. The said legal communications means radio communications is operated in compliance with the Telecommunications Act. The low power radio-frequency devices must be susceptible with the interference from legal communications or ISM radio wave radiated devices.