



**TREND NETWORKS**

# NavITEK NT



## **COPYRIGHT NOTICE**

The information contained in this document is the property of TREND Networks and is supplied without liability for errors and omissions. No part of this document may be reproduced or used except as authorized by contract or other written permission from TREND Networks. The copyright and all restrictions on reproduction and use apply to all media in which this information may be placed.

TREND Networks pursues a policy of continual product improvement and reserves the right to alter without notice the specification, design, price or conditions of supply of any product or service.

### **© TREND Networks 2021**

All rights reserved  
Publication ref: 153800  
Applies to software revision 1.0.10 onwards

TREND Networks

Stokenchurch House  
Oxford Road  
Stokenchurch  
High Wycombe  
Buckinghamshire  
HP14 3SX UK

---

## CONTENTS

Care of your NaviTEK NT.....	4
Final Disposal.....	4
Safety Information.....	4
Connector Safety.....	4
Power.....	5
Power Module Management.....	5
Power Module Recharging.....	5
Battery Pack.....	5
Switching ON and OFF.....	6
Power Saving.....	6
Master Reset.....	6
Replaceable insert - RJ-45 socket.....	7
Functional overview.....	7
Handset Controls, Indicators and Ports.....	8
Menu Navigation.....	9
Soft Keys.....	9
Data entry.....	9
Getting started.....	10
Modes of Operation.....	10
Cable.....	10
Ethernet.....	10
Setup.....	11
Setup menu descriptions.....	11
Tests - General.....	13
Tests menu description - Cable mode.....	15
Wiremap.....	15
Tone.....	18
Auto test.....	18
Tests menu description - Ethernet mode.....	19
Blink.....	19
Ping4 and Ping6.....	19
TRoute4 and TRoute6.....	20
Statistics.....	21
Stats menu description.....	21
Specifications - NaviTEK NT.....	22
Glossary, abbreviations and acronyms.....	29

---

## Care of your NavITEK NT

Although light and portable, NavITEK NT is robust and has been designed to operate in a protected outdoor working environment.

To ensure reliable operation:

- Avoid very high or low temperatures - NavITEK NT is designed to operate between 0°C and +40°C, although you should only charge the battery between +10°C and +30°C. You can store the unit safely between -20°C and +70°C.
- To avoid damage, we recommend that you keep NavITEK NT in its carrying case when you are not using it.
- Do not use solvents, strong detergents or abrasive materials to clean NavITEK NT. Use only cleaning agents approved for use on ABS and polycarbonate plastics.

## Final Disposal

When your NavITEK NT has reached the end of its life you must dispose of the complete unit in accordance with local environmental regulations.

## Safety Information

When using NavITEK NT, always take basic safety precautions to reduce the risk of fire, electric shock and injury to persons. These include the following:

- When connecting to the line, special care must be taken as high voltages may be present on the line and there may be a danger of electrocution.
- Avoid using the tester during an electrical storm - there is a remote risk of electric shock by lightning.
- Use only the mains electricity adaptor supplied with your NavITEK NT.

## Connector Safety

The following connectors conform to EN60950 SELV safety status:

- RJ-45 Ethernet port.
- USB port.
- DC inlet port.



**DO NOT CONNECT ANY TELECOMMUNICATIONS  
NETWORK TO ANY OF THE TESTER'S PORTS**

---

## Power

NaviTEK NT can be powered from:

- A rechargeable power module,
- Directly from power connected to the DC inlet built in to the power module.
- From an alkaline battery pack.

The type of module or pack supplied as standard depends on the model purchased.

### Power Module Management

A fully charged power module will support up to five hours of heavy, continuous use. For maximum life of the power module it is recommended to discharge it fully and then recharge it fully at least once a month.

The power module is not user-serviceable. When it has reached the end of its life, contact your local TREND representative for service.

### Power Module Recharging

The power module can be fully recharged in three hours with the NaviTEK NT switched ON or OFF. To recharge the power module, connect the supplied power adaptor to the DC inlet. For convenience the power module may be removed from, or left attached to, the tester for charging. The Power LED next to the DC inlet glows green to show that the battery is being charged, and flashes green to show that it is not being charged. The power module's charge state is indicated at FULL, 2/3, 1/3 and EMPTY by the graphical power meter shown in the information bar at the top of the display.



Fig 1 Power indications

### Battery Pack

The battery pack accepts four replaceable AA alkaline cells. These cells cannot be recharged.

---

## Switching ON and OFF

To switch the tester ON, press and hold the Power button. Wait until the home screen is visible on the display; the tester is ready for use.

To switch the tester OFF, press and hold the Power for approximately 1/2 second, a shutdown message is displayed on the screen. The currently stored setup is saved.

## Power Saving

Power saving preferences are selected from SETUP>SYSTEM>PREF. Auto off can be Disabled (tester remains ON indefinitely), or set to switch the tester OFF after three, 10 or 30 minutes of inactivity. The backlight can be set to Always On, or to dim to 50% brightness after three minutes of inactivity. Note that when mains power is connected the display is always on full brightness and the tester remains ON indefinitely.

## Master Reset

In the unlikely event of a system lock-up which prevents the tester from being switched OFF, it may be necessary to perform a master reset. This will not delete any stored data.

- Remove the power module or battery pack to access a small aperture in the NaviTEK NT (Fig 2).
- Insert a paper clip into the reset hole and press the internal reset switch.

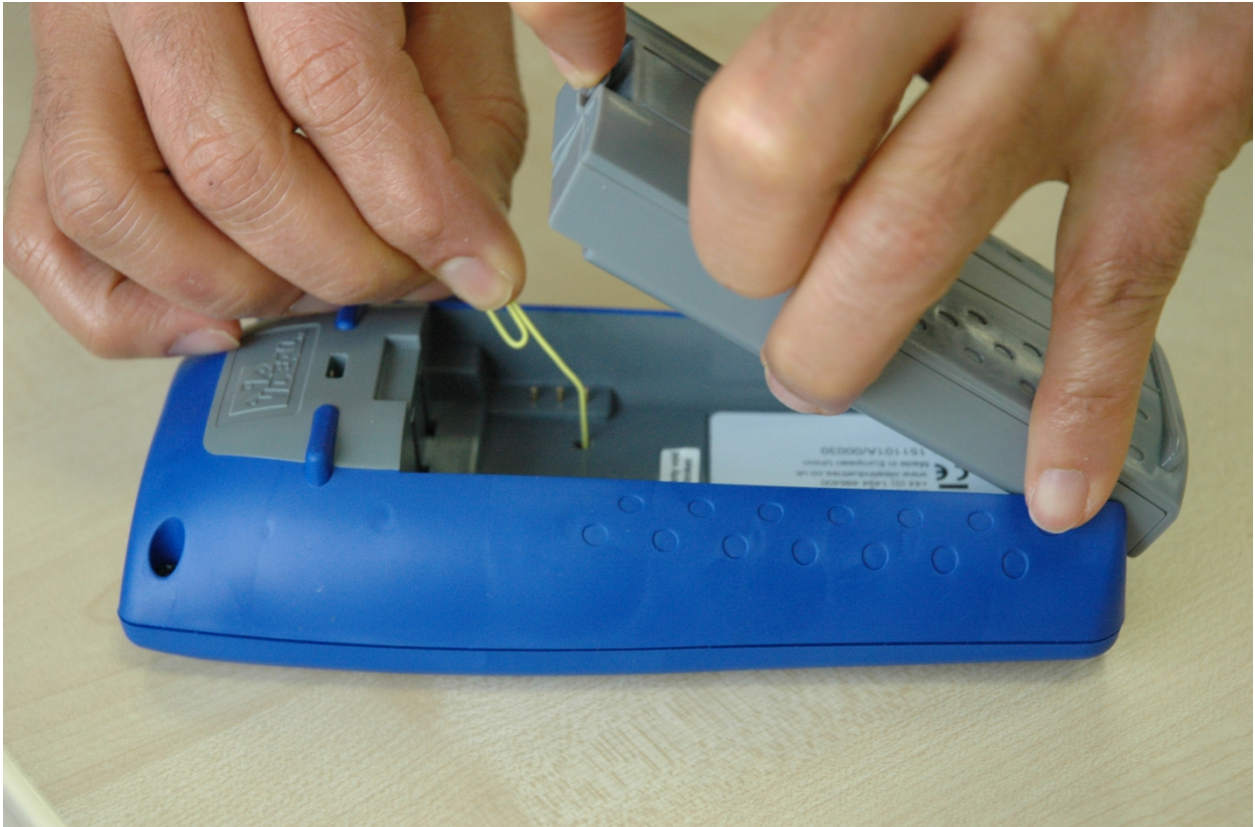

Fig 2

- Replace the power module or battery pack.

---

## Replaceable insert - RJ-45 socket

To replace a damaged or worn RJ-45 socket insert proceed as follows:

Equipment required: Kit, TREND part number 150058 - includes Tool x1 and Replacement Insert x10.

1. Switch the NaviTEK NT off.
2. Remove cables.
3. Carefully push the tool STRAIGHT into the socket. BE CAREFUL - DO NOT MOVE THE TOOL VERTICALLY!
4. Keeping the tool STRAIGHT firmly pull the insert out from the socket.
5. Using fingers replace a new insert STRAIGHT into the socket and secure in place by firmly pushing



3.



4.

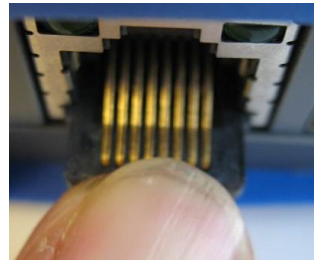

5.

## Functional overview

Function	NaviTEK NT
LAN testing over copper	✓
IPv4	✓
IPv6	✓
Advanced Wiremap	✓
PoE detection	✓
Tone Generator	✓
Ping test	✓
Traceroute test	✓
Hub blink	✓

## Handset Controls, Indicators and Ports

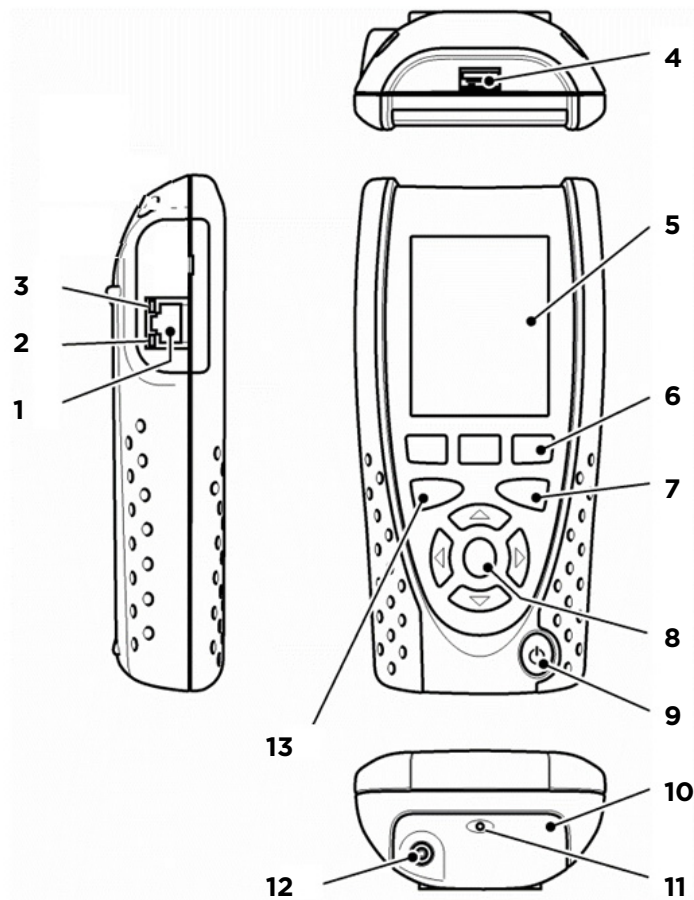

**Fig 3**

- |   |                        |    |  |
|---|------------------------|----|--|
| 1 | RJ 45 port             | 7  | Escape key                             |
| 2 | RJ 45 activity LED     | 8  | Cursor and ENTER keys                  |
| 3 | RJ 45 link LED         | 9  | ON/OFF button                          |
| 4 | USB port               | 10 | Power module (optional)                |
| 5 | LCD color display      | 11 | Charger LED (only on Power module)     |
| 6 | Function keys F1 to F3 | 12 | DC in connector (only on Power module) |
|   |                        | 13 | Autotest button                        |



---

## Menu Navigation

**Cursor and ENTER keys.** The arrowed cursor keys are intuitively marked to move the highlighted field between all menu icons, and settings fields. To select a value from a field that offers a list of values, use the LEFT and RIGHT cursor keys. To move to the previous or next field on the screen use the UP or DOWN cursor keys. ENTER will move to the next field.

**Escape key.** Returns to previous screen. Note that when a value in a settings field is changed, if the Escape key is pressed *before* the soft key 'APPLY', the value will not be stored.

**Autotest key.** Immediately runs pre-stored tests. A new tester will have factory stored tests in memory. These are easily changed using the SETUP menu.

**Function keys.** F1 to F3 are to select the corresponding soft keys at the lower edge of the display.

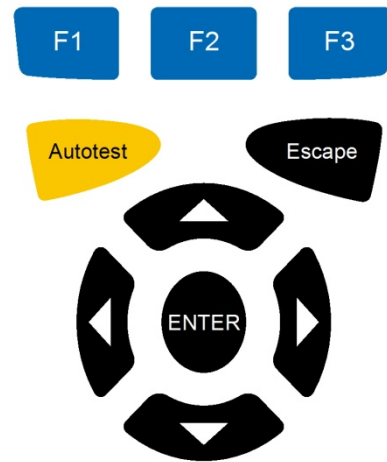

Fig 4

## Soft Keys

The soft keys appear along the bottom edge of the display. Their function changes and is dependent on the screen currently shown on the display.

## Data entry



Fig 5

When you navigate to and select a field that requires a value or text to be entered, such as a customer's name or a URL, a QWERTY keyboard will be shown on the display (Fig 5). All data is entered using the QWERTY keyboard. Move the key that is highlighted on the keyboard using the tester's cursor keys. ENTER selects the currently highlighted key which will now appear in the text window directly above the keyboard. Key stroke errors are corrected using the backspace key (<-). Press the UP cursor key to move the cursor into the text window for editing.

Press the QWERTY keyboard's SHIFT key to change the display from lower to upper case. Press SHIFT a second time to display symbols and punctuation characters.

When the text or value has been entered, press the soft key OK (F1). The display will return to the previous screen which is now populated with the required data. You must press the soft key APPLY to save the changes.

---

## Getting started

Press the soft key DETECT (F1) and the tester will determine the mode of operation dependent on the services detected.

The modes of operation that follow are available:

## Modes of Operation

NaviTEK NT has two fundamental modes of operation -

### Cable

When the tester is connected to a copper cable, with or without an active remote, press the soft key DETECT (F1) to display all options available from the Cable mode screen (Fig 6). When an active remote is connected it will be shown on screen and its identification number displayed. For a full description of these options, see - *Tests menu description - Cable mode*.

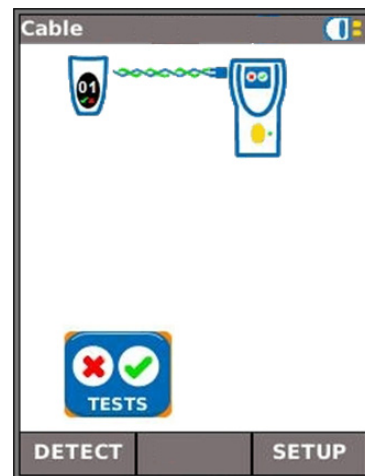

Fig 6

### Ethernet



Fig 7

When the tester is connected to a network/device, using either copper or fiber cable, press the soft key DETECT (F1), to display all options available from the Ethernet mode screen (Fig 7). For a full description of these options see - *Tests menu description - Ethernet mode*.

The detected services are PoE (802.3af/at. Not Cisco pre-standard), ISDN S, PBX and Unknown. The IPv4 and IPv6 addresses assigned to the tester are displayed (when available).

---

## NOTES

If the NaviTEK NT is connected to an active network when it is switched ON, it will automatically detect the network and display its IP address in the HOME screen.

If the NaviTEK NT is not connected to an active network when it is switched ON, it will automatically enter Cable mode and run a Wiremap test.

If the NaviTEK NT is connected to an active network after it is switched ON, press the soft key DETECT (F1) to detect the network.

## Setup

All user-defined settings and preferences of the NaviTEK NT are set from the SETUP menu.

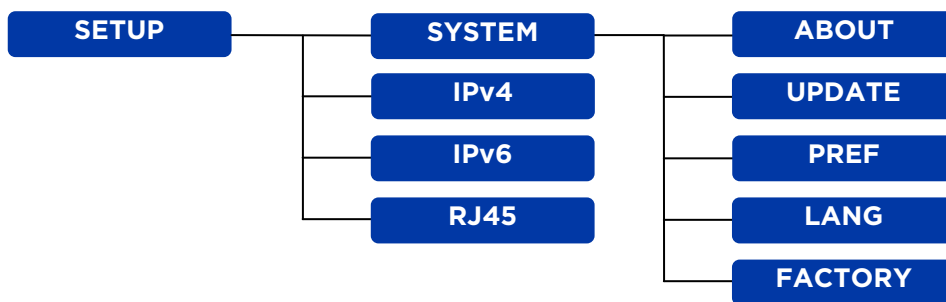

Fig 8

## Setup menu descriptions

From the Cable or Ethernet home screen, press the soft key SETUP (F3) to display the Setup menu .

Selecting any of the icons will produce the options that follow:

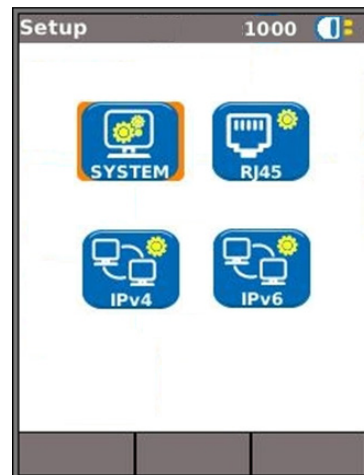

Fig 9



Highlight the System icon and press ENTER to access the settings and preferences listed below:



Sets the language for the tester. The on-screen display will appear in the selected language.



Sets the power saving options and the preferred units of length.



This menu item facilitates software updates downloaded from the TREND website and saved to a USB key. Select the update icon and follow the on-screen instructions. A dialogue will then appear on screen indicating that a software update is in progress.



Provides model, software, hardware and firmware information.



Provides the option to return all settings to the factory default.



Enable/disable IPv4 and set IP address as static or dynamic (DHCP) depending on which type your network supports. If Static is selected, enter the numerical address, Netmask, Gateway, DNS1 and DNS2.



Enable/disable IPv6 and select address type as Static, Stateless, Stateful (DCHP) depending on which type your network supports. If Static is selected, enter numerical IP address, Prefix (64 or 128), Gateway, DNS1 and DNS2.



Enable Auto negotiate to allow NaviTEK NT to change its settings automatically to suit the connected network.

Disable Auto negotiate to fix the settings, and set speed (10Mb/s, 100Mb/s or 1Gb/s), and mode to Full or Half Duplex.

Set minimum Rx size (19 to 99), used to detect Undersize frames in LINK STATS.

Set MDI to Auto to compensate for straight/crossover connections automatically.

Set MDI to MDI or MDIX to fix the MDI type for network troubleshooting.

**NOTE.** The factory set MAC address of the tester is displayed for information only and cannot be adjusted.

## Tests - General

In either Cable or Ethernet mode, when you select the TESTS icon, the display will show the range of tests available.

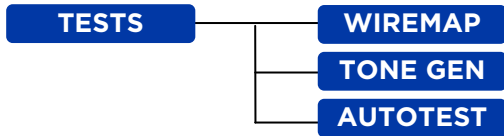

Fig 10 Tests Menu - Cable mode

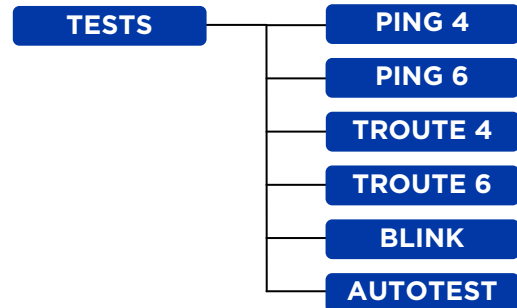

Fig 11 Tests menu - Ethernet mode

To select a test highlight its icon and press Enter. Each test has its own result screen. This is indicated by the test name being shown in the information bar. Press the soft key RUN (F1) to start the test. The test will use the setup criteria currently stored for that test. The F1 soft key changes to STOP, giving you the opportunity to abort the test.

When you want to change the setup criteria before a test is run, press the soft key SETUP (F3). The display will show a screen where all variables for the test can be changed. Press the soft key APPLY (F2) to save the changes and return to the result screen.



Highlight the Tests icon and press ENTER to access the settings and preferences listed below:



Set the cable type and color scheme to suit the cable to be tested, crossover allowed y/n, and NVP. NVP is preset at 72% but can be custom set anywhere in the range of 59 to 89% to suit the cable to be tested.



Select from three tones. This avoids confusion when a second or third tester is being used on the same installation. Choose on which pin, or pin pair, to play the tone to achieve the best results.



Set the target URL/Numerical address,

Count (Number of times to repeat the Ping - 1 to 999999),

Pause (Interval between successive Pings - 1 to 5 seconds),

Length (Number of bytes in Ping frame payload - 8 to 1000 bytes).



Set the target URL/Numerical address.

Timeout (Abort timeout for any hop: 2 to 30 secs), Use a short timeout to reduce test time, or a long timeout to reach remote internet locations.

Protocol (ICMP or UDP as required by your network).

Select Name Lookup if supported by your network. If not required, de-select Name Lookup to reduce test time.



Set the target URL/Numerical address,

Count (Number of times to repeat the Ping - 1 to 999999),

Pause (Interval between successive Pings - 1 to 5 seconds),

Length (Number of bytes in the Ping frame payload - 8 to 1000 bytes).



Set the target URL/Numerical address,

Maximum number of hops (1 to 30),

Timeout (Abort timeout for any hop - 2 to 30 secs),

Select Name Lookup if supported by your network. If not required, de-select Name Lookup to reduce test time.



Select the Cable mode and Ethernet mode tests that will run every time the NaviTEK NT's Autotest button is pressed. Select from: Wiremap, Ping4, Ping6, TRoute4, TRoute6.

For all tests a symbol is displayed at the top right hand corner of the screen below the information bar.



Indicates test has not been run and that the tester is ready.



Indicates test is in progress. This symbol is also displayed while the tester is detecting a port.



Will be displayed if the test is aborted, or when a test has been run and a fault detected or a network is unknown or unreachable.



Indicates a test has been run with no faults detected.

## Tests menu description - Cable mode

When the TESTS icon from the cable mode home screen is selected, Fig 12, the available tests will be displayed, Fig 13.

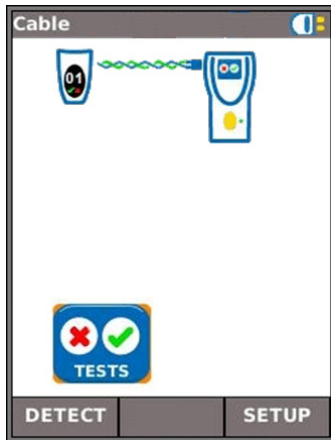

Fig 12

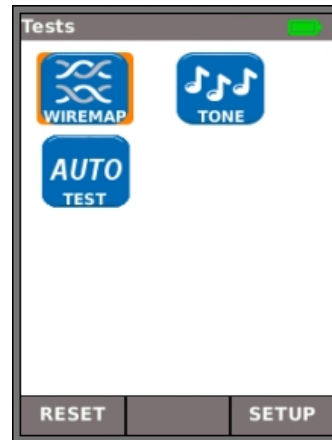

Fig 13

After any one of the three available tests from the menu is selected, the soft keys RUN and SETUP will appear:



### Wiremap

When the soft key RUN (F1) is pressed a wiremap test will be run on the cable currently connected to the tester's RJ45 port. The settings used for the test will be those that have been preset via the setup menu: SETUP>TESTS>WIRETEST>WIREFMAP.

After the test has been run, the display will show a graphical interpretation of the result (Fig 14) and an indication of the distance to the fault or, the length of the cable. Select F2 (FAULT) and the display will show a textual list of the faults detected Fig 15.

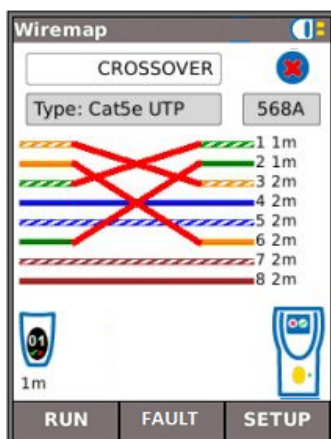

Fig 14



Fig 15

Note that for the example of a Wiremap test shown above; if the option 'XOver Allowed' had been checked in the Wiremap SETUP options, the results would be displayed as shown in Fig 16 and Fig 17.

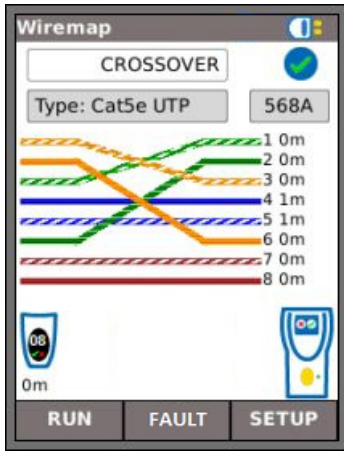

Fig 16

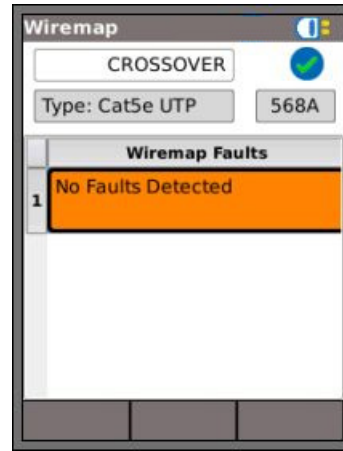

Fig 17

The wiremap tests may be run with no termination - open, or with an Active Remote termination. When connected, an image of an Active Remote will be shown on the display and its type identified. After a test has been run, the length of the cable is displayed (range up to 100m (330ft)).

With an open termination the possible faults detected are:

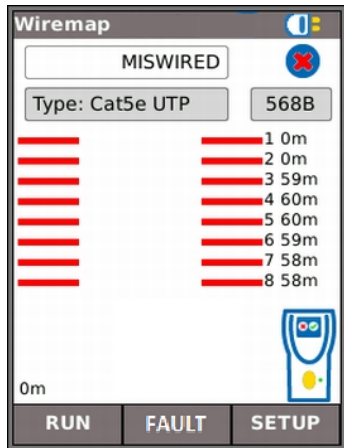

Fig 18 Open circuit by pair

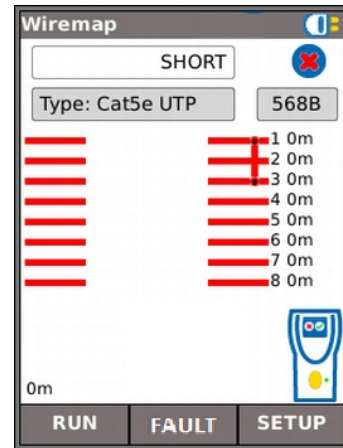

Fig 19 Short circuit by pin



With an active remote termination the possible faults detected are:

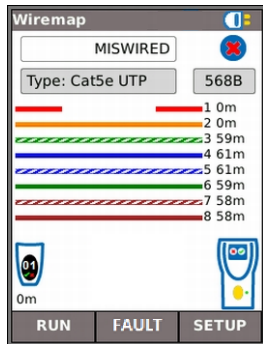

Fig 20 Open circuit by pin

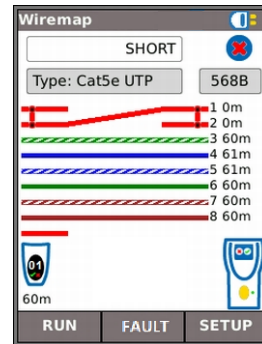

Fig 21 Short circuit by pin

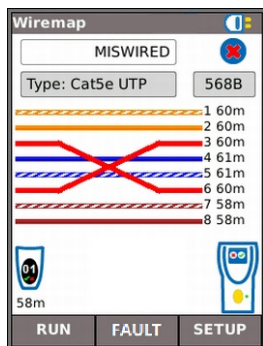

Fig 22 Crossed pairs

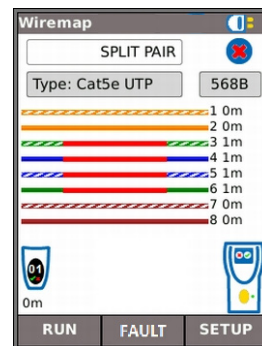

Fig 23 Split pairs

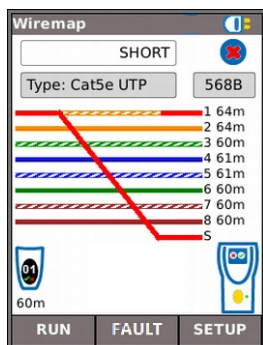

Fig 24 Bridged shorts

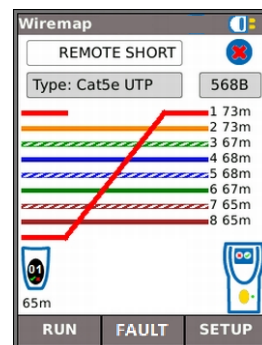

Fig 25 Remote shorts

The indications that follow appear on the Active Remote device:

- Flashing green LED - Test Passed.
- Flashing red LED - Test Failed.
- Amber LED - DC voltage greater than 12 Volts detected - cannot perform test.



## Tone



Fig 26

NaviTEK NT can act as a tone generator (Fig 26). Together with a compatible tone probe, the route of a cable can be traced. A choice of three tones can be selected. To achieve the best result, the tone may be played over one of eight pins relative to the other seven, or over one of four pairs. The tone is started and stopped with the F1 soft key which displays as RUN or STOP accordingly.

Press the soft key SETUP (F3) to change the tone and the pin, or pin pair, that the tone is played on. Press the soft key APPLY (F2) for your changes to take effect.



## Auto test

NaviTEK NT can be set up to run a predefined range of tests when the yellow Autotest button on the handset is pressed. The range includes Wiremap, Ping4, Ping6, TRoute4, TRoute6 and Netscan.

The range of tests is set from SETUP>TESTS>AUTOTEST by ticking the check boxes next to your choice, Fig 27. Press the soft key APPLY (F2) for your changes to take effect.

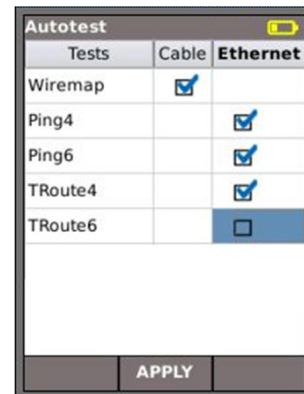

Fig 27

When an Autotest is run, Fig 28, the display shows a list of selected tests and the status of each. After the Autotest is complete, or has been stopped, each individual test can be selected and its detailed results displayed.

In Cable mode, Autotest is limited to Wiremap.

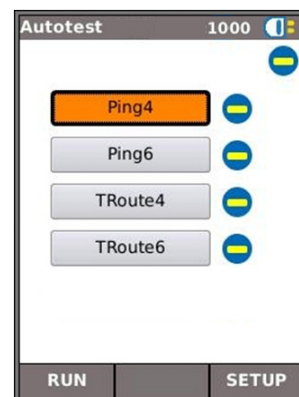

Fig 28

## Tests menu description - Ethernet mode

When the TESTS icon from the Ethernet mode home screen is selected, Fig 29, the available IP tests will be displayed on the Tests screen as shown in Fig 30.



Fig 29

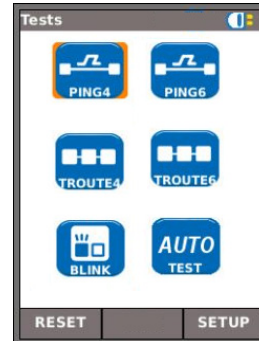

Fig 30



### Blink

A Hub Blink test forces the connected port of a network device to blink. NaviTEK NT also changes the speed and therefore LED color (on supporting devices) making it easier to identify the correct port. Select the BLINK icon from the Tests screen, the test is started and stopped with the soft key F1 which displays as RUN or STOP accordingly.



### Ping4 and Ping6

Ping will test the availability and measure the response times of devices and URLs.

The results of a successful test, both in progress and passed are shown. The range of possible results are listed next to the figure.



Fig 31

- Info: READY, IN PROGRESS, PASSED, NO RESPONSE, UNKNOWN HOST.
- Tx: Count of transmitted ping frames: 1 to 999999.
- Rx: Count of successfully received Ping responses: 1 to 999999.
- Delay: Round trip delay in ms between transmitting Ping and receiving response. Displayed as Minimum, Average and Maximum.



## TRoute4 and TRoute6

Trace Route will display the route and measure transit delays of frames across an IP network.

Press the soft key SETUP (F3) to enter the target or select one from the v4 or v6 TARGET look-up table, and to view or amend the test settings.

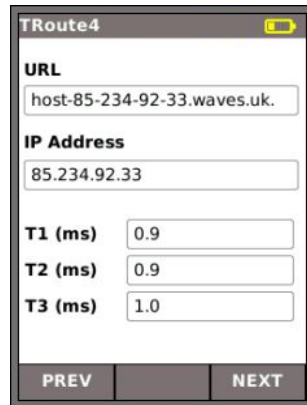

Select an individual hop to view its statistics.

The soft keys PREV (F1) and NEXT (F3) are used to navigate between individual hops.

Each hop is traced three times. The time recorded during each trace is displayed in ms as T1, T2 and T3.

Fig 32

---

## Statistics

From the Ethernet home screen select the STATS icon, the Stats screen is shown on the display,

### Stats menu description

Select from the buttons below the graph to provide the information that follows:

**IP** The F2 soft key is used to toggle between IPv4 and IPv6 data.

The IPv4 data listed is:

Info: IP Assigned successfully or, Listening or, DHCP failed.

Also listed are: IP Address, Gateway, Subnet Mask, Primary & Secondary DNS, DHCP Server.

The IPv6 data listed is:

Info: IP Assigned successfully or, Listening or, DHCP failed.

Also listed are: IP Address, Prefix-64 or 128 bit, Link Address, Gateway, Primary & Secondary DNS.

### MAC

Tx and Rx data listed is:

Total frames, Total Bytes,

### LINK

Port data listed is:

PoE Voltage: 0 to 60V, Speed, Duplex.

Partner data listed is:

10M-HD, 10M-FD, 100M-HD, 100M-FD, 1000M-HD, 1000M-FD.

---

## Specifications - NavITEK NT

### Connectors

#### *Test Ports*

##### **RJ45**

*Used for* - Cable Test  
- Ethernet Test

*Connector type* - Lifejack with user-replaceable contacts

#### *System Ports*

##### **USB**

*Used for* - Software Update

*Class* - Host

*Connector type* - A

*USB type* - 1.1

##### **Power**

*Used for* - Battery charging  
- Mains powering via adaptor

*Connector type* - 2.5mm pin power jack

*Polarity* - Centre pin positive

*Voltage* - 12v

*Current* - 2 amp

*Location* - Bottom of optional power module  
(Not present in standard alkaline battery pack)

### Controls

#### *ON/OFF*

##### **Push button**

*Used for* - Power ON/OFF

#### *Function Keys*

##### **F1 to F3**

*Used for* - Screen-defined functions

#### *Navigation Keys*

##### **Cursor and ENTER**

*Used for* - User interface navigation

##### **Escape**

*Used for* - Return to previous menu

##### **Autotest**

*Used for* - Launch of automatic test function

#### *Reset*

##### **Push button**

*Used for* - Escape from exceptional lockup condition

---

## Displays

### Screen

#### LCD

*Used for* - Display of setup functions and results

*Location* - Front

*Size* - 2.8 inch diagonal

*Type* - QVGA Colour

*Pixels* - 240 x 320

### LEDs

#### Charger LED

*Used for* - Indication of charging status

*Colour* - Green

*Location* - Bottom of optional power module

(Not present in standard alkaline battery pack)

#### RJ45 Link LED

*Use* - ON indicates link UP

*Colour* - Green

#### RJ45 Activity LED

*Use* - Flashing indicates link activity

*Colour* - Green

## Ports

### RJ45

#### Setup

*Auto Negotiation* - Enabled  
- Disabled

*Speed* - 10Mbps  
- 100Mbps  
- 1Gbps

*Mode* - Full Duplex  
- Half Duplex

*MDI* - AUTO  
- MDI  
- MDIX

*Min Rx Size* - 19-99 bytes

*MAC* - Factory set

#### Tests

*Ethernet Mode* - Ping4  
- Ping6  
- Trace Route4  
- Trace Route6  
- Hub Blink  
- Auto (Ping, Trace Route,)  
*Cable Mode* - Wiremap  
- Tone Generator  
- Auto (Wiremap)

#### Service Detection

*Detected Services* - PoE (802.3af/at. Not Cisco pre-standard)  
- ISDN S  
- PBX  
- Unknown

---

## Cable Tests

### **Wiremap Setup**

- Cable Type*
- Cat3 UTP
  - Cat3 STP
  - Cat5 UTP
  - Cat5 STP
  - Cat5e UTP
  - Cat5e STP
  - Cat6 UTP
  - Cat6 STP
  - Cat7
  - USOC
  - ETH S1236
  - ETH S1278
  - ETH U1236
  - ETH U1278
  - IND. M12
  - COAX RJ59
- Colour Scheme*
- None
  - 568A
  - 568B
  - USOC
  - TERA
- Crossover Allowed*
- Yes
  - No
- NVP - Fixed 72%*
- Custom 59% - 89%

### **Termination Type**

- None* - Open
- Active Remote* - #1 - #12

### **Tests (No Termination)**

- Faults*
- Open circuit by pair
  - Short circuit by pin
- Length of pair*
- Metres / Feet (Set in System Setup)
  - Range 100m / 330ft

### **Tests (Active Remote Termination)**

- I/D - Remote #*
- Indications on Remote*
- Voltage Warning (>±10volts on any pins)
  - Pass/Fail
- Faults*
- Open circuit by pin
  - Short circuit by pin
  - Crossed pairs
  - Split pairs
  - Bridged shorts
  - Remote shorts
- Length of pair*
- Metres / Feet (Set in System Setup)
  - Range 100m / 330ft

### **Tone Generator Setup**

- Tones* - 3
- Wire I/D*
- Tone applied to one of 8 pins relative to the other 7
  - Tone applied across one of 4 pairs

### **Test**

- Audible tone detected using compatible tone probe*



---

## Ethernet Tests

### IPv4

#### Setup

- IPv4 Enable*
  - Enabled
  - Disabled
- Addressing- DHCP*
  - Static
- Numerical*
  - Address
  - Netmask
  - Gateway
  - DNS1
  - DNS2

### IPv6

#### Setup

- IPv6 Enable*
  - Enabled
  - Disabled
- Addressing- Stateful (DHCPv6)*
  - Stateless
  - Static
- Numerical*
  - 128bit HEX IP address
- Network Prefix*
  - 64 bit
  - 128 bit

### Pingv4

#### Setup

- Target*
  - Numerical address
  - URL
- Count*
  - 1 to 999999
- Pause*
  - 1 to 5 Sec
- Length*
  - 8 to 1000 bytes.

#### Results

- Info*
  - READY
  - IN PROGRESS
  - PASSED
  - NO RESPONSE
  - UNKNOWN HOST
- Tx Count*
  - 1 to 999999
- Rx Count*
  - 1 to 999999
- Delay(ms)*
  - Minimum
  - Average
  - Maximum

### Pingv6

#### Setup

- Target*
  - IPv6 address
  - URL
- Count*
  - 1 to 999999
- Pause*
  - 1 to 5 Sec
- Length*
  - 8 to 1000 bytes.

### Pingv6

#### Results

- Info*
  - READY
  - IN PROGRESS
  - PASSED
  - NO RESPONSE
  - UNKNOWN HOST
- Tx Count*
  - 1 to 999999
- Rx Count*
  - 1 to 999999
- Delay(ms)*
  - Minimum

- Average
- Maximum

**Trace Routev4  
Setup**

- Target* - Numerical address
- URL
- Max Hops* - 2 to 100
- Timeout* - 2 to 30 sec
- Type* - ICMP
- UDP

**Results**

- Info* - READY
- IN PROGRESS
- PASSED
- NO RESPONSE
- UNKNOWN HOST
- Hop* - Numerical address
- Delay(ms)* - t1
- t2
- t3

**Trace Routev6  
Setup**

- Target* - Numerical address
- URL
- Max Hops* - 2 to 100
- Timeout* - 2 to 30 sec
- Type* - UDP

**Results**

- Info* - READY
- IN PROGRESS
- PASSED
- NO RESPONSE
- UNKNOWN HOST
- Hop* - Numerical address
- Delay(ms)* - t1
- t2
- t3

**Blink**

**Test**

- Sequence* - Off/10/Off/100/Off/1000 Mb/s

---

## Statistics

### *IP*

#### Results

##### IPv4

- Enabled or Disabled
- info: listening, assigned, DHCP failed
- DHCP or Static
- IPv4 Address
- IPv4 Netmask
- IPv4 Gateway
- IPv4 DNS1
- IPv4 DNS2

##### IPv6

- Enabled or Disabled
- info: listening, assigned, DHCP failed
- Stateful (DHCPv6) or Stateless or Static
- IPv6 Address
- IPv6 Network Prefix, 64 bit or 128 bit
- IPv6 Link Address
- IPv6 DNS

### *MAC*

#### Results (Tx & Rx)

- Total Frames
- Total Bytes

### *LINK*

#### Results

##### *PORT*

- PoE Voltage 0 - 60V
- Speed, Duplex

-

##### *PARTNER*

- 10M-HD
- 10M-FD
- 100M-HD
- 100M-FD
- 1000M-HD
- 1000M-FD

---

## System

### Setup

#### Preferences

- Language* - English
- French
- German
- Spanish
- Italian
- Portuguese
- Chinese
- Auto off* - Disabled
- 3 mins
- 10 mins
- 30 mins
- Backlight* - Always On
- Dims to 50% after 3 mins
- Length Units* - Meters
- Feet

#### Software update

- Upgrade* - Via USB

## General

### Power

#### Battery

- Supported Types* - Standard power module (4 x AA NiMH cells)
- Alkaline battery pack with 4 AA cells
- Autonomy* - Up to 5 hours (power module only)
- Recharge time* - 3 hours (Power module only)
- Battery level Indication* - Full
- 2/3
- 1/3
- Empty

### Physical

#### Dimensions

- Length* - 175mm
- Width* - 80mm
- Depth* - 40mm

#### Weight

- Unit* - 0.22kg
- Batteries* - 0.18kg

### Environmental

#### Temperature

- Operating - 0°C to 40°C
- Storage - -20°C to 70°C

#### Relative Humidity

- Min 5%
- Max 90% non-condensing

### Approvals

#### EMC

- EN 55022:2006 / A1:2007
- EN55024:1998 / A1:2001 / A2:2003

#### Safety

- IEC 60950-1:2005+A1:2009/EN 60950-1:2006+A1:2010

## Glossary, abbreviations and acronyms

Term	Description
10M-HD	10 Mb/s Half Duplex
10M-FD	10 Mb/s Full Duplex
100M-HD	100 Mb/s Half Duplex
100M-FD	100 Mb/s Full Duplex
1000M-HD	1000 Mb/s Half Duplex
1000M-FD	1000 Mb/s Full Duplex
IP	Internet Protocol
IPv4	Internet Protocol version 4
Static	IP address assigned manually by the operator
Dynamic	IP address assigned automatically using DHCP
IPv6	Internet Protocol version 6
Stateful	IP address assigned automatically using DHCPv6
Stateless	IP address assigned automatically using ICMPv6
Static	IP address assigned manually by the operator
MAC	Media Access Control
MDI	Medium Dependent Interface
MDIX	Medium Dependent Interface Crossover
NVP	Nominal Velocity of Propagation of signals in a cable, expressed as a percentage of the speed of light in a vacuum. Can be determined using cable manufacturers' data or experimentally using a known cable length.
PoE	Power over Ethernet
RJ45	Registered Jack standard for a modular connector using 8 conductors
Rx	Receive
STP	Shielded Twisted Pair
Tx	Transmit
URL	Uniform Resource Locator
USB	Universal Serial Bus
UTP	Unshielded Twisted Pair