



Courier 1000 Instruction Manual



REVISION HISTORY

Date	Version	Description
February 6, 2023	A	New manual

TABLE OF CONTENTS

1.	INTRODUCTION	2
1.1.	Safety Precautions	2
1.2.	Intended Use	2
1.3.	Control Functions	3
2.	INSTALLATION.....	4
2.1	Packing List	4
2.2	Selecting the Location	4
2.3	Power Supply Connection	4
2.3.1	AC Adapter Power	4
2.3.2	Battery Power.....	4
3.	OPERATION.....	5
3.1	Turning On/Off the Scale	5
3.2	Zero Operation	5
3.3	Changing the Units of Measure.....	5
3.4	Auto Shut-Off.....	5
3.5	Dynamic Weighing	5
3.6	Weight Alert™	5
4.	CALIBRATION	6
4.1	Span Calibration.....	6
4.2	Calibration Locking.....	7
5.	MAINTENANCE	8
5.1	Cleaning	8
5.2	Troubleshooting.....	8
5.3	Service Information	8
6.	TECHNICAL DATA	9
6.1	Specifications	9
6.2	Drawings and Dimensions	9
7.	COMPLIANCE.....	10

1. INTRODUCTION

This manual contains installation, operation, and maintenance instructions for Courier 1000. This instruction manual helps you to install and use this scale easily. Therefore, you must read it carefully before installation and operation.

1.1. Safety Precautions

Definition of Signal Warnings and Symbols

Safety notes are marked with signal words and warning symbols. These show safety issues and warnings. Ignoring the safety notes may lead to personal injury, damage to the instrument, malfunctions and false results.

Signal Words

WARNING	For a hazardous situation with medium risk, possibly resulting in severe injuries or death if not avoided.
CAUTION	For a hazardous situation with low risk, resulting in damage to the device or the property or in loss of data, or minor or medium injuries if not avoided.
ATTENTION	For important information about the product. May lead to equipment damage if not avoided.
NOTE	For useful information about the product.

Warning Symbols



General hazard



Explosion hazard



Electrical shock hazard

Safety Precautions



CAUTION: Read all safety warnings before installing, making connections, or servicing this equipment. Failure to comply with these warnings could result in personal injury and/or property damage. Retain all instructions for future reference.

- Before connecting power, verify that the AC adapter's input voltage range and plug type are compatible with the local AC mains power supply.
- Do not position the equipment such that it is difficult to reach the power connection.
- Make sure that the power cord does not pose a potential obstacle or tripping hazard.
- Operate the equipment only under ambient conditions specified in these instructions.
- The equipment is for indoor use only.
- Do not operate the equipment in wet, hazardous, or unstable environments.
- Do not allow liquids to enter the equipment.
- Do not load the equipment above its rated capacity.
- Do not drop loads on the platform.
- Do not place the equipment upside down on the platform.
- Use only approved accessories and peripherals.
- Disconnect the equipment from the power supply when cleaning.
- Service should only be performed by authorized personnel.



WARNING: Never work in an environment subject to explosion hazards! The housing of the instrument is not gas tight. (Explosion hazard due to spark formation, corrosion caused by the ingress of gases).



WARNING: Electrical shock hazards exist within the housing. The housing should only be opened by authorized and qualified personnel. Remove all power connections to the unit before opening.



1.2. Intended Use

This instrument is intended for use in pharmacies, schools, businesses and light industry. It must only be used for measuring the parameters described in these operating instructions. Any other type of use and operation beyond the limits of technical specifications, without written consent from OHAUS, is considered as not intended. This instrument complies with current industry standards and the recognized safety regulations; however, it can constitute a hazard in use. If the instrument is not used according to these operating instructions, the intended protection provided by the instrument may be impaired.

1.3. Control Functions



Figure 1-2 Courier 1000 Control Panel

Button	On/Zero Off	Units Cal
Primary Function (Short Press) 	On/Zero <ul style="list-style-type: none"> • Turn on the scale. • If the scale is On, set the display to zero. • Perform tare operation. 	Units <ul style="list-style-type: none"> • Change the weighing unit. • Enter Dynamic Weighing or Weigh Alert Mode. • Initiate countdown in Dynamic Weighing mode.
Secondary Function (Long Press) 	Off <ul style="list-style-type: none"> • If the scale is on, long press to turn off the scale. 	Cal <ul style="list-style-type: none"> • Perform the calibration process.

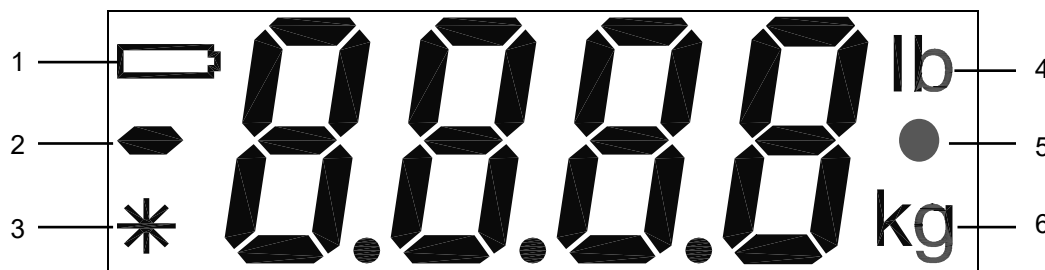



Figure 1-3 Display

Elemento	Descripción
1	Low Battery Indication: The battery symbol on the left side of the display indicates a low battery condition. When first displayed, approximately 12 hours of operation remain. When the battery is fully depleted, the scale will momentarily display “Lo bAt” and shut off.
2	Large 7-Segment Numeric Characters: Weight (mass) values are shown using 4 digits including negative sign and decimal places. Prompts for calibration and possible error conditions are also shown using these digits.
3	Stable Reading Indication: A * will appear in the lower left corner of the display to indicate when the reading is stable.
4 / 6	Weighing Unit Indication: The weighing unit selected appears on the right side of the display
5	Dynamic Weighing Mode Indication: A • will flash next to the selected unit during this mode.

2. INSTALLATION

2.1 Packing List

Item	Description	Picture	Quantity
1	Courier 1000 scale		1
2	AC adapter		1

2.2 Selecting the Location

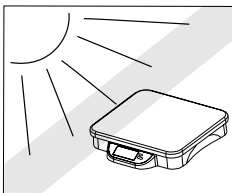

Avoid heat sources

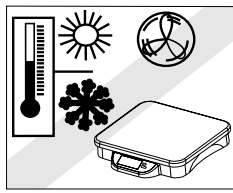

Rapid temperature changes

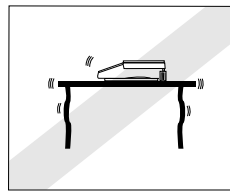

Air current or excessive vibrations

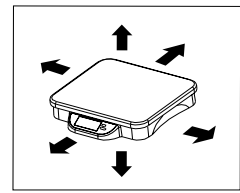

Allow sufficient space

2.3 Power Supply Connection

2.3.1 AC Adapter Power

The AC adapter (included) may be used to supply power to the scale when battery power is not available. Connect the AC adapter plug to the input jack. Then plug the AC adapter into a properly grounded power outlet.

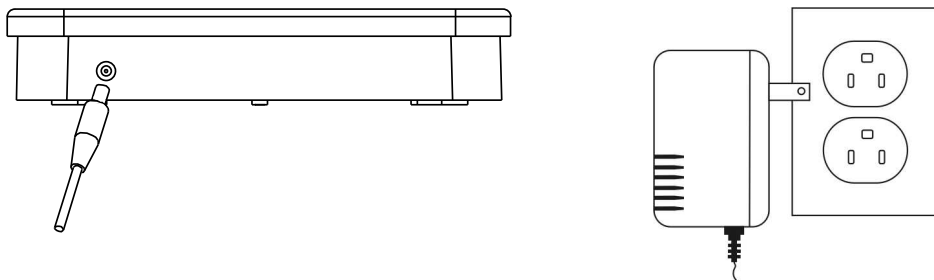

Figure 2-1. Power Connection.

2.3.2 Battery Power

Open the battery cover on the bottom of the scale and install 3 x C (LR14) batteries into the compartment. Orient the batteries as shown on the inside of the compartment. Close the battery cover.

NOTE: Batteries are not included in the packaging.

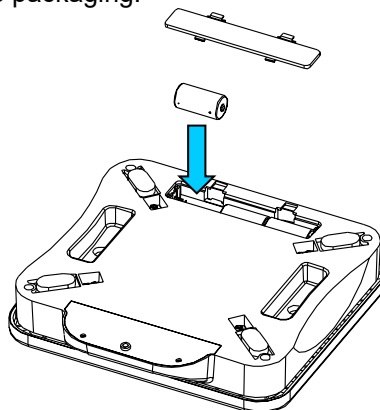

Figure 2-2. Battery Installation.



CAUTION: Do not dispose of used batteries in domestic waste. Follow the proper disposal or recycling requirements in accordance with local laws and regulations.

3. OPERATION

3.1 Turning On/Off the Scale

To turn the scale on, short press the **ON/ZERO Off** button. The scale performs a display test, momentarily displays the model/software version, and then enters the weighing mode.

To turn the scale off, long press **ON/ZERO Off** button until OFF is displayed.

3.2 Zero Operation

By short pressing the **ON/ZERO Off** button, the scale display returns to zero. When adding additional mass, the **ON/ZERO Off** button may be used repeatedly until the full capacity of the scale is reached. When a container is used, the **ON/ZERO Off** button may be used to initiate Tare function. Additional mass may then be added as a NET weight. When removing both the sample and container from the scale, a negative value may be displayed. Zero the scale again before subsequent usage.

NOTE: The **ON/ZERO Off** button will perform a true zero setting function when displayed values are within +2% of full capacity. Above 2%, the range is limited to full capacity by subtraction.

3.3 Changing the Units of Measure

Short press the **UNITS Cal** button to display the next available measuring unit.

3.4 Auto Shut-Off

To extend battery life, the scale will automatically turn off after approximately four minutes of inactivity. This feature is only active during battery operation.

3.5 Dynamic Weighing

With the platform empty, short press the **UNITS Cal** button to cycle through the units. Dynamic mode is active when the symbol "•" is flashing.

Place an item on the platform. The scale will show "-A-".

NOTE: If using a container, press **ON/ZERO Off** to tare the weight and return to zero.

With an item or a container on the platform, a short press of **UNITS Cal** will start the averaging countdown from 5 seconds.

The average weight is then displayed. The terminal "•" stops flashing when the process is complete.

The display will hold until a button is pressed.

To repeat the process, press **UNITS Cal** with an item or a container on the platform.

To Exit, remove all weight from the platform or container and short press **UNITS Cal** button.

3.6 Weight Alert™

With platform empty, press the **UNITS Cal** button until the lb unit displayed.

The digits will start to flash if the weight on the platform is over 70 lb. If the weight on the pan is over 150 lb, the digits will stop flashing.

NOTE: Weight Alert™ is only available on i-C12P75 model. Weight Alert™ is available only in lb mode without Dynamic Weighing. Make sure that the "lb" is turned On and the "•" dynamic weighing is turned Off.



4. CALIBRATION

For best results, calibrate the scale at regular intervals. (Calibration weights are not supplied with the scale.)



Caution: use extreme care when handling calibration weights as they are very heavy. Improper lifting methods or misuse of calibration weights may result in personal injury. Multiple weights may be used to equal the required calibration weight.

NOTE:

- Ensure the appropriate calibration masses are available before beginning calibration (see Table 4-1).
- Ensure that the scale is level and stable during the entire calibration process.
- Calibration is unavailable in Dynamic Weighing Mode.
- Allow the scale to warm up for at least 2 minutes after stabilizing to room temperature.
- To abort calibration, press **UNITS Cal**, or power off the scale.

Table 4-1. Calibration weight

Model	Calibration weight (kg/lb)
i-C12P9	9 / 20
i-C12P20	20 / 40
i-C12P75	50 / 100

4.1 Span Calibration

Span Calibration uses two points to adjust the scale. The first point is the zero value where there is no weight on the scale. The second point is the Span value where a calibration mass is placed on the scale.

To select the weighing unit to be used for calibration, press the **UNITS Cal** button until the correct unit is displayed.

Long press the **UNITS Cal** button until “CAL” is displayed.

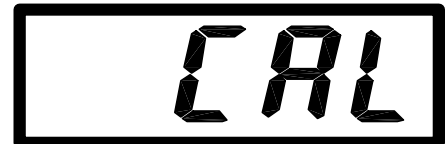

With the platform empty, press the **ON/ZERO Off** button to capture the scale zero. The display will show “-C-”.

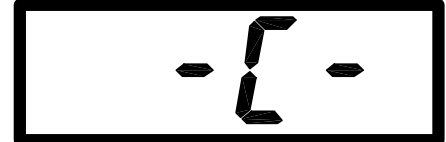

After the zero is captured, the required span calibration weight in the selected unit is displayed.

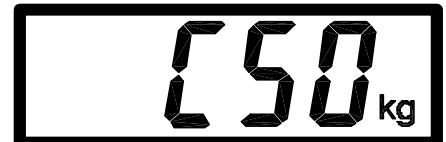

Place the calibration weight on the platform and press **ON/ZERO Off** button. The display will again show “-C-”.

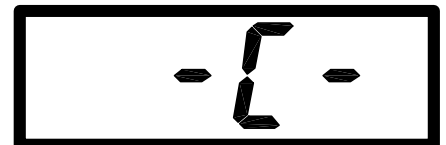

After span capture, the display will return to the normal weighing mode.

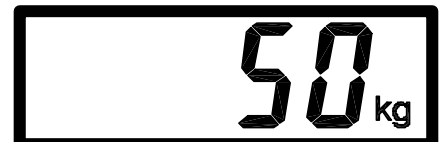

NOTE: The message “CAL E” will appear if an incorrect calibration weight was applied. Repeat the procedure using the correct calibration weight.

4.2 Calibration Locking

By use of the internal switch, the calibration function may be locked (disabled), and unauthorized recalibration prevented.

With the scale powered off, remove the cover under the display by unscrewing the two screws at the bottom.

Slide the switch on the PCB (marked SW3) to the position marked "CAL LOCK".

Reassemble the cover.

If required, place tamper evident sealing labels over the screw holes or over the housing edges.

If later recalibration is required, the cover will need to be reopened and the lock switch returned to the original position.

NOTE: When the lock switch is set to the CAL LOCK position, the power-on zero range is reduced to 10% of full capacity.

5. MAINTENANCE

Caution: Before cleaning, turn off the scale, and remove the AC adapter.

5.1 Cleaning



WARNING: Electric Shock Hazard. Disconnect the equipment from the power supply before cleaning. Make sure that no liquid enters the interior of the instrument.



Attention: Do not use solvents, harsh chemicals, ammonia or abrasive cleaning agents.

The housing may be cleaned with a cloth dampened with a mild detergent if necessary.

5.2 Troubleshooting

The following table lists common problems and possible causes and remedies. If the problem persists, contact Ohaus or your authorized dealer.

Table 5-1 Troubleshooting

Symptom	Possible Cause(s)	Remedy
Unable to turn on the scale	<ol style="list-style-type: none"> 1. Power cord not plugged in or properly connected. 2. Power outlet not supplying power. 3. Batteries out of power. 4. Other failure. 	<ol style="list-style-type: none"> 1. Check power cord connections. Make sure power cord is plugged in properly into the power outlet. 2. Check the power source. 3. Change batteries. 4. Service required.
Poor accuracy	<ol style="list-style-type: none"> 1. Improper calibration. 2. Unstable environment. 	<ol style="list-style-type: none"> 1. Perform calibration. 2. Move scale to suitable location.
Unable to calibrate	<ol style="list-style-type: none"> 1. CAL LOCK is set to ON. 2. Unstable environment. 3. Incorrect calibration mass. 	<ol style="list-style-type: none"> 1. Set CAL LOCK to OFF. 2. Move the scale to suitable location. 3. Use correct calibration mass.
Scale displays "Lo bAt"	Low battery	Connect the scale to power outlet. Replace batteries.
Scale displays "Lo Line"	Low Line voltage	Verify source voltage.
Scale displays "E"	Weight on platform exceeds capacity	Remove load on scale.
Scale displays "CALE"	Calibration failure	Use the correct calibration weight.
Scale displays "UnSt"	Scale is unstable at power up	Relocate scale to a more stable environment.

5.3 Service Information

If the troubleshooting section does not resolve or describe your problem, contact your authorized Ohaus service agent. For service assistance or technical support in the United States call toll-free 1-800-526-0659 between 8.00 AM and 5:00 PM EST. An Ohaus product service specialist will be available to help. Outside the USA, please visit our website, www.ohaus.com to locate the Ohaus office nearest you.

6. TECHNICAL DATA

6.1 Specifications

Equipment Ratings:

Indoor use only
 Altitude: 2,000m/6,562ft
 Operating temperature: 5°C to 40°C (41°F to 104°F)
 Humidity: Maximum relative humidity 80% for temperatures up to 31°C (87.8°F) decreasing linearly to 50% relative humidity at 40°C (104°F).
 Electrical supply: 12VDC, 100mA. (For use with certified or approved power supply, which must have a SELV and limited energy output.) or 3 x C (LR14) Batteries.
 Voltage fluctuations: Mains supply voltage fluctuations up to ±10% of the nominal voltage.
 Overvoltage category (Installation category): II
 Pollution degree: 2

Table 6-1 Specification

Model	i-C12P9	i-C12P20	i-C12P75
Capacity x Readability	9 kg x 0.005 kg 20 lb x 0.01 lb	20 kg x 0.01 kg 44 lb x 0.02 lb	75 kg x 0.05 kg 165 lb x 0.1 lb
Weighing Units	kg, lb		
Modes	Weighing, Dynamic Weighing, Weight Alert™ (Weigh Alert™ is only available when lb is activated on i-C12P75 model.)		
Keypad	2-button mechanical keys		
Calibration Weights	9 kg / 20 lb	20 kg / 40 lb	50 kg / 100 lb
Display	4-digit 7-segment, 20mm / 0.8 in characters		
Tare range	To capacity by subtraction		
Stabilization Time	≤ 3 seconds		
Maximum Overload	150%		
Operating temperature/humidity range	5°C to 40°C / 41°F to 104°F at 50% to 80% relative humidity, non-condensing		
Power Requirements	Dry cell battery: 3 x C (LR14) batteries (not included) or AC power adapter: 100-240VAC ~ 0.2A 50/60Hz; power output: 12 VDC 0.5 A		
Auto Shut-Off	4 minutes no activity (battery operation only)		
Typical Battery life	300 hours		
Scale Dimensions (mm / in)	316 x 316 x 60 mm/ 12.4 x 12.4 x 2.4 in		

6.2 Drawings and Dimensions

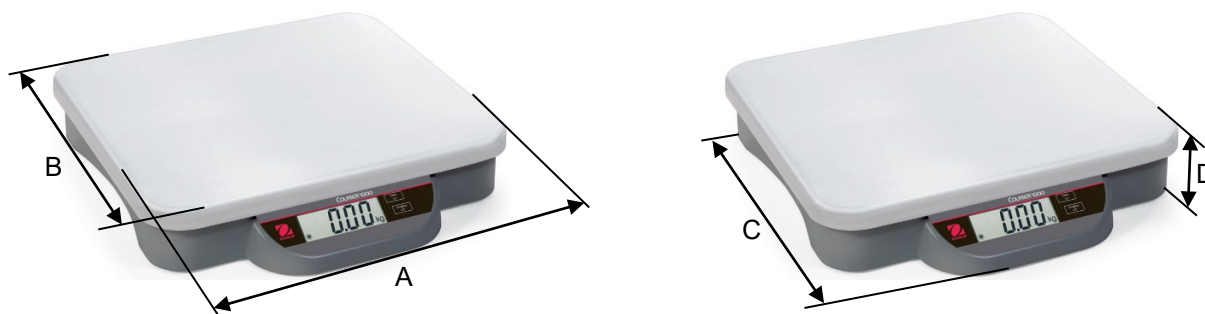





Table 6-2 Dimensions of All Models

A	B	C	D
316mm/12.4"	280mm/11.0"	316mm/12.4"	60mm/2.36"

7. COMPLIANCE

Compliance to the following standards is indicated by the corresponding mark on the product.

Mark	Standard
	This product complies with the applicable harmonized standards of EU Directives 2011/65/EU (RoHS), 2014/30/EU (EMC) and 2014/35/EU (LVD). The EU Declaration of Conformity is available online at www.ohaus.com/ce .
	This product complies with the applicable statutory standards of the Restriction of the Use of Certain Hazardous Substances in Electrical and Electronic Equipment Regulations 2012, UK Electromagnetic Compatibility Regulations 2016 and Electrical Equipment (Safety) Regulations 2016. The UK Declaration of Conformity is available online at www.ohaus.com/uk-declarations .
	This product complies with the EU Directive 2012/19/EU (WEEE). Please dispose of this product in accordance with local regulations at the collecting point specified for electrical and electronic equipment. For disposal instructions in Europe, refer to www.ohaus.com/weee .
	EN 61326-1

ISED Canada Compliance Statement:
CAN ICES-003(A) / NMB-003(A)

ISO 9001 Registration

The management system governing the production of this product is ISO 9001 certified.

FCC Supplier Declaration of Conformity

Unintentional Radiator per 47CFR Part B

Trade Name: OHAUS CORPORATION

Model: i-C12Pxxx

Party issuing Supplier's Declaration of Conformity:

Ohaus Instruments (Changzhou) Co., Ltd.

Building C, No. 6 Zhengqiang Road, Xuejia Town, Xinbei District, Changzhou

Jiangsu 213022,

China

Responsible Party – U.S. Contact Information:

Ohaus Corporation

8 Campus Drive, Suite 105

Parsippany, NJ 07054

United States

FCC Compliance Statement:

Note: This equipment has been tested and found to comply with the limits for a Class A digital device, pursuant to part 15 of the FCC Rules. These limits are designed to provide reasonable protection against harmful interference when the equipment is operated in a commercial environment. This equipment generates, uses, and can radiate radio frequency energy and, if not installed and used in accordance with the instruction manual, may cause harmful interference to radio communications. Operation of this equipment in a residential area is likely to cause harmful interference in which case the user will be required to correct the interference at his own expense.

Changes or modifications not expressly approved by the party responsible for compliance could void the user's authority to operate the equipment.

LIMITED WARRANTY

OHAUS products are warranted against defects in materials and workmanship from the date of delivery through the duration of the warranty period. During the warranty period OHAUS will repair, or, at its option, replace any component(s) that proves to be defective at no charge, provided that the product is returned, freight prepaid, to OHAUS. This warranty does not apply if the product has been damaged by accident or misuse, exposed to radioactive or corrosive materials, has foreign material penetrating to the inside of the product, or as a result of service or modification by other than OHAUS. In lieu of a properly returned warranty registration card, the warranty period shall begin on the date of shipment to the authorized dealer. No other express or implied warranty is given by OHAUS Corporation. OHAUS Corporation shall not be liable for any consequential damages.

As warranty legislation differs from state to state and country to country, please contact OHAUS or your local OHAUS dealer for further details



Ohaus Corporation
8 Campus Drive
Suite 105
Parsippany, NJ 07054 USA

With offices worldwide / Con oficinas en todo el mundo / Avec des bureaux partout dans le monde / Mit Büros weltweit /
Con uffici in tutto il mondo
www.ohaus.com



* 3 0 7 4 6 0 1 0 *

P/N 30746010 A © 2023 Ohaus Corporation, all rights reserved / todos los derechos reservados / tous droits réservés / alle Rechte vorbehalten / tutti i diritti riservati