



Courier 7000 Instruction Manual



REVISION HISTORY

Date	Version	Description
March 30, 2023	A	Initial release
July 7, 2023	B	Updated the company address in the back cover and FCC page
August 22, 2023	C	Updated the battery life in specifications

TABLE OF CONTENTS

1.	INTRODUCTION	3
1.1.	Safety Precautions	3
1.2.	Intended Use	3
1.3.	Overview of Parts and Controls	4
1.4.	Control Functions	4
2.	INSTALLATION	6
2.1	Packing List	6
2.2	Unpacking the Scale	6
2.3	Setup	7
2.3.1	Power Supply Connection	7
2.3.2	PC Connection	7
2.3.3	Direct Wall Mounting	8
2.3.4	2nd Display Installation (available as option)	8
2.4	Leveling the Equipment	10
3.	OPERATION	11
3.1	Turning On/Off the Scale	11
3.2	Setting the Display to Zero	11
3.3	Changing the Units of Measure	11
3.4	Printing Data	11
3.5	Application Modes	11
3.5.1	Weighing	11
3.5.2	Totalization	12
3.5.3	Dynamic Weighing	13
3.5.4	Weight Alert	15
4.	MENU SETTINGS	16
4.1	Menu Navigation	16
4.1.1	User Menu (In segments)	16
4.1.2	Button Navigation	17
4.2	Calibration Menu	17
4.2.1	Initial Calibration	18
4.2.2	Zero Calibration [ZER0]	18
4.2.3	Span Calibration [SPAN]	18
4.2.4	Linearity Calibration [L IN]	19
4.2.5	GEO Code Adjustment [GEO]	19
4.2.6	Calibration Test [TEST]	20
4.2.7	End Cal [End]	20
4.3	Setup Menu	20
4.4	Readout Menu	21
4.5	Unit Menu	23
4.6	RS232 Menu	23
4.7	Print Menu	24
4.8	Lock Button Configuration	27
5.	LEGAL FOR TRADE	28
5.1	Settings	28
5.2	Verification	28
5.3	Sealing	29
6.	COMMUNICATION	30
6.1	UPS WorldShip / FedEx Software Compatibility	30
6.1.1	UPS WorldShip	30
6.1.2	FedEx	32
6.2	Scale to Device Port Connections	34
6.2.1	USB (Type C) Port	34
6.2.2	RS232 Port	35
6.2.3	Other Options (2nd RS232 or Ethernet or WiFi / Bluetooth or 2nd Display)	36
6.3	Interface Protocols	36
6.3.1	NCI Protocol	36
6.3.2	8213 Interface Protocol	37
6.3.3	3835 Protocol	40
6.3.4	NCI-SCP01 Protocol	41
7.	MAINTENANCE	43
7.1	Cleaning	43
7.2	Troubleshooting	43

7.3	Service Information	43
8.	ACCESSORY	44
9.	TECHNICAL DATA	46
9.1	Specifications	46
9.2	Drawings and Dimensions	48
9.3	Table of GEO Code Values.....	49
10.	COMPLIANCE	50
11.	APPENDICES.....	52
11.1	MT Standard Continuous Output	52
11.2	MT-SICS Commands	54
11.3	OHAUS Commands	55
11.4	OH-Continuous Print	56
11.5	Column Kit Installation.....	57
	LIMITED WARRANTY	58

1. INTRODUCTION

This manual contains installation, operation, and maintenance instructions for Courier 7000. This instruction manual helps you to install and use this scale easily. Therefore, you must read it carefully before installation and operation.

1.1. Safety Precautions

Definition of Signal Warnings and Symbols

Safety notes are marked with signal words and warning symbols. These show safety issues and warnings. Ignoring the safety notes may lead to personal injury, damage to the instrument, malfunctions and false results.

Signal Words

WARNING	For a hazardous situation with medium risk, possibly resulting in severe injuries or death if not avoided.
CAUTION	For a hazardous situation with low risk, resulting in damage to the device or the property or in loss of data, or minor or medium injuries if not avoided.
ATTENTION	For important information about the product. May lead to equipment damage if not avoided.
NOTE	For useful information about the product.

Warning Symbols



General hazard



Explosion hazard



Electrical shock hazard

Safety Precautions



CAUTION: Read all safety warnings before installing, making connections, or servicing this equipment. Failure to comply with these warnings could result in personal injury and/or property damage. Retain all instructions for future reference.

- Before connecting power, verify that the equipment's input voltage range and plug type are compatible with the local AC mains power supply.
- Do not position the equipment such that it is difficult to reach the power connection.
- Make sure that the power cord does not pose a potential obstacle or tripping hazard.
- Operate the equipment only under ambient conditions specified in these instructions.
- The equipment is for indoor use only.
- Do not operate the equipment in wet, hazardous, or unstable environments.
- Do not allow liquids to enter the equipment.
- Do not load the equipment above its rated capacity.
- Do not drop loads on the platform.
- Do not place the equipment upside down on the platform.
- Use only approved accessories and peripherals.
- Disconnect the equipment from the power supply when cleaning.
- Service should only be performed by authorized personnel.



WARNING: Never work in an environment subject to explosion hazards! The housing of the instrument is not gas tight. (Explosion hazard due to spark formation, corrosion caused by the ingress of gases)



WARNING: Electrical shock hazards exist within the housing. The housing should only be opened by authorized and qualified personnel. Remove all power connections to the unit before opening.

1.2. Intended Use

This instrument is intended for use in pharmacies, schools, businesses and light industry. It must only be used for measuring the parameters described in these operating instructions. Any other type of use and operation beyond the limits of technical specifications, without written consent from OHAUS, is considered as not intended. This instrument complies with current industry standards and the recognized safety regulations; however, it can constitute a hazard in use. If the instrument is not used according to these operating instructions, the intended protection provided by the instrument may be impaired.

1.3. Overview of Parts and Controls

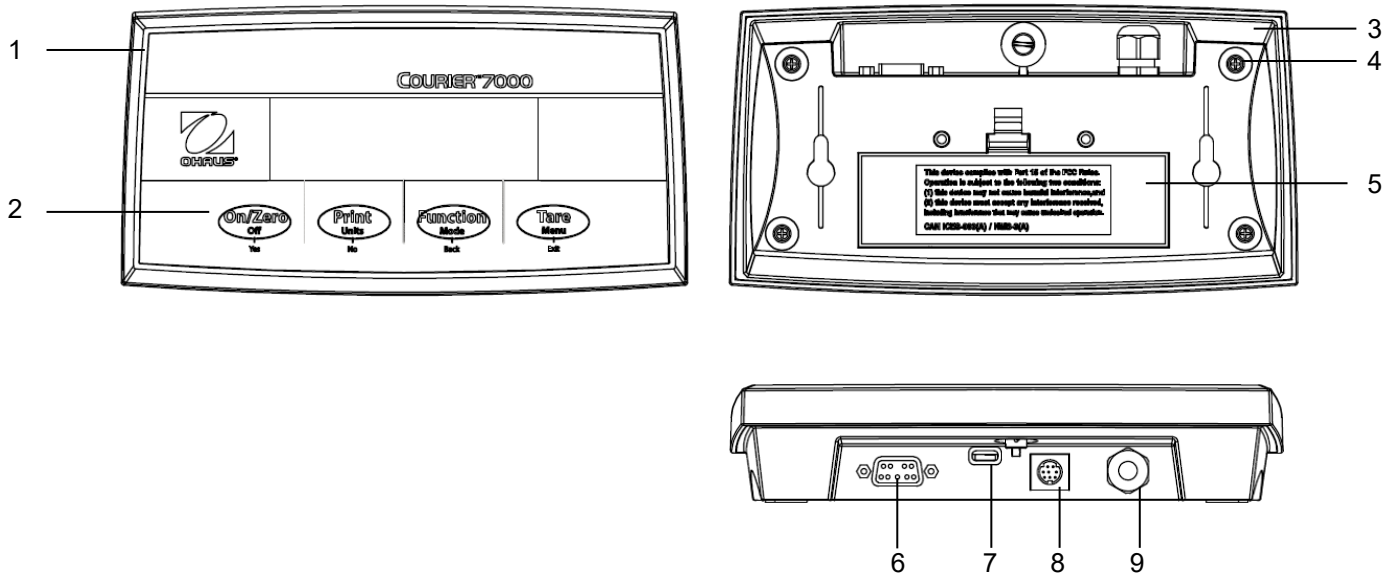

Figure 1-1 i- Courier 7000

Item	Description	Item	Description
1	Front Housing	6	RS232 Connector
2	Control Panel	7	USB Type-C Connector
3	Rear Housing	8	Mini DIN Connector
4	Screws (4)	9	Load Cell Connector
5	Battery Cover		

1.4. Control Functions

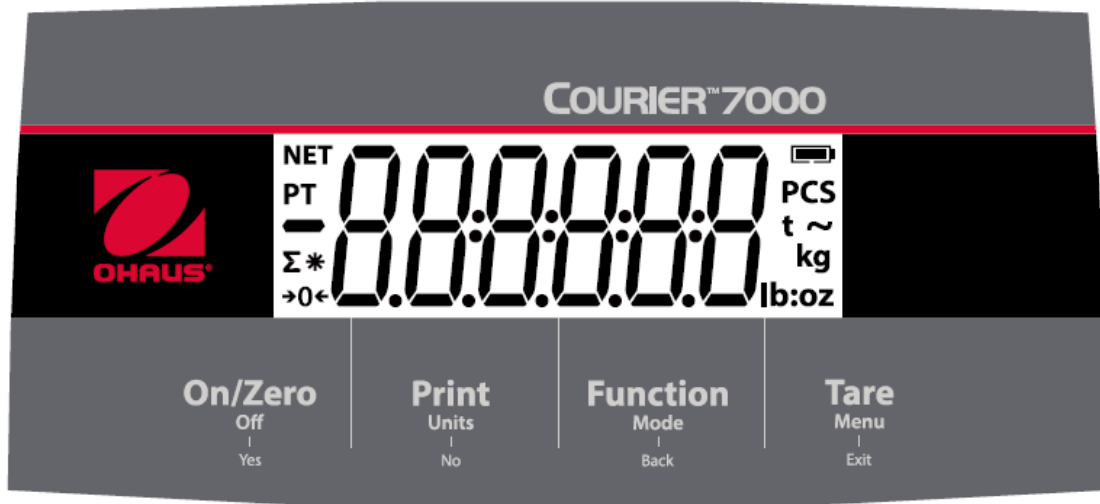

Figure 1-2 i- Courier 7000 Control Panel

Button	On/Zero Off Yes	Print Units No	Function Mode Back	Tare Menu Exit
Primary Function (Short Press)	On/Zero If the scale is off, short press to turn on the scale. If the scale is on, short press to set the display value to zero.	Print If an interface is enabled, the current display value can be transmitted to the interface port.	Function This key initiates the specific function in different application modes.	Tare Performs a tare operation.
Secondary Function (Long Press)	Off If the scale is on, long press to turn off the scale.	Units Changes the weighing unit.	Mode Changes the application mode.	Menu Enters the user menu.
Menu Function (Short Press)	Yes Selects the current setting on the display or goes into a sub-menu.	No Moves to the next menu or menu item. Rejects the current setting on the display and moves to the next available one.	Back Moves back to the previous menu item.	Exit Exits the user menu. Aborts a calibration in progress.

NOTE:

- Short Press: Press the key less than 1 second.
- Long Press: Press and hold the key for more than 3 seconds.

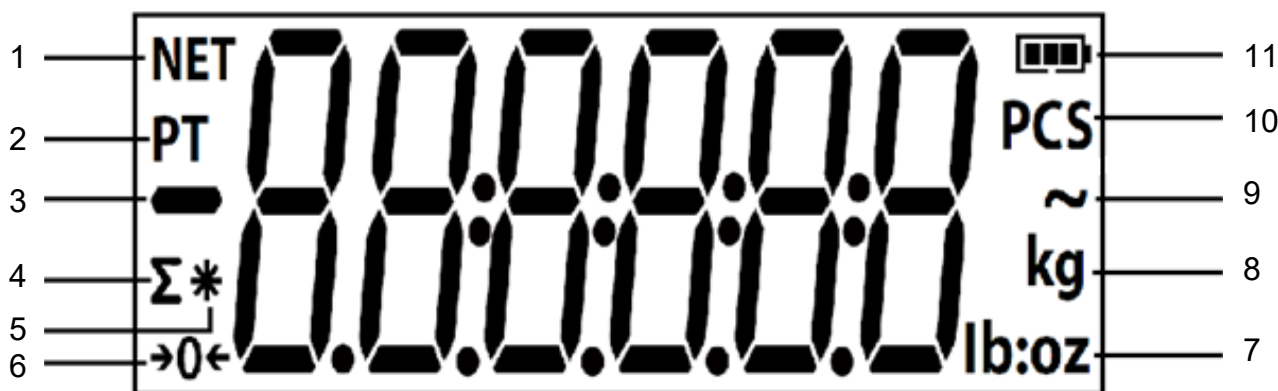





Figure 1-3 Display

Item	Description	Item	Description
1	Net weight symbol	7	Pound, Ounce, Pound:Ounce symbols
2	Preset Tare, Tare symbols	8	Kilogram, gram symbols
3	Negative symbol	9	Dynamic Weighing mode symbol
4	Totalization symbol	10	Pieces symbol
5	Stable weight symbol	11	Battery symbol
6	Center of Zero symbol		

2. INSTALLATION

2.1 Packing List

Item	Description	Picture	Quantity
1	Courier 7000 scale		1
2	USB cable		1
3	AC adapter		1

2.2 Unpacking the Scale

Steps

1. Take out the documents, cable and power adapter, then put them to the side.
2. Remove the foam blocks.

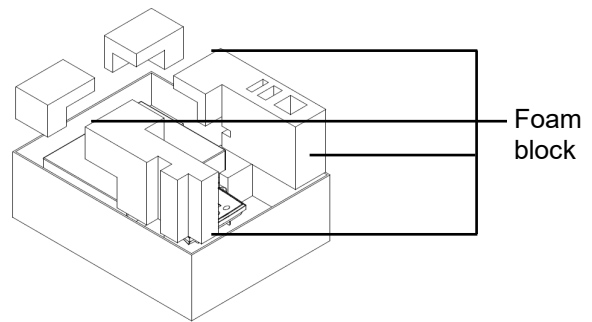

3. Take the Courier 7000 scale out of the box and put it on a stable surface.
NOTE: For i-C71M150X, please refer to the pictures on the right to carry the Courier 7000 scale.
4. Remove the platform and 4 red shipping tabs between the upper and lower frames of the scale's base.

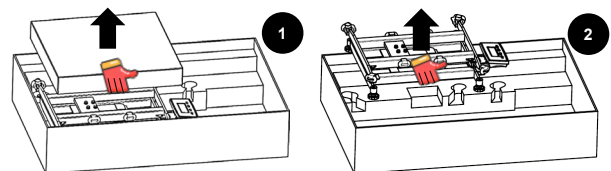

2.3 Setup

2.3.1 Power Supply Connection

The Type-C cable and the AC adapter can supply power to the scale.

USB Power

1. Use the Type-A end of the USB cable to connect to the PC.
2. Use the other side of the USB cable to connect the terminal through the mounting hole in the bracket.



AC Adapter Power

1. Use the Type-A end of the USB cable to connect to the AC adapter.
2. Use the other side of the USB cable to connect the terminal through the mounting hole in the bracket.
3. Plug the AC Adapter into the electrical outlet.

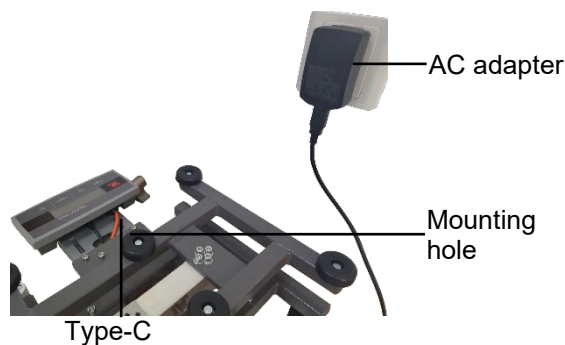

Dry Battery Power

4 disposable AA size dry batteries (not included) can supply power to the scale.

1. Loosen the 2 screws on the terminal mounting bracket to remove the terminal.
2. Install the batteries in the battery compartment.



The battery symbol indicates the battery status:

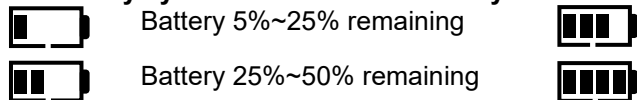

Battery 50%~75% remaining

Battery 75%~100% remaining

2.3.2 PC Connection

USB to PC

USB is the preferred method of connection. If you connect a USB cable to the PC, it allows the USB communication with the PC.

NOTE: The USB cable to a PC connection can supply power to the scale as well.

1. Use the Type-A end of the USB cable to connect to the PC.
2. Use the other side of the USB cable to connect the terminal through the mounting hole in the bracket.



RS232 to PC

The RS232 is the alternative method of the connection.

1. Connect the RS232 cable to the terminal through the mounting hole in the bracket.
2. Connect the other side of the RS232 cable to the PC. (Typically labeled COM 1, COM A or IOIOI).
3. To supply power, you can use the USB cable and AC adapter or the dry batteries (Refer to **2.3.1 Power Supply Connection**).



NOTE:

Connections can also be made using the options for a 2nd RS232, Ethernet or WiFi/Bluetooth connection via the Mini DIN connection. More details about each connection is found in the manuals for each option. Once an option is connected to the scale, the menu will then show options for configuring the connection.

2.3.3 Direct Wall Mounting

The terminal may be mounted directly to a wall using two screws (not included).

1. Remove the cable ties on the bottom of the scale to release the load cell cable.

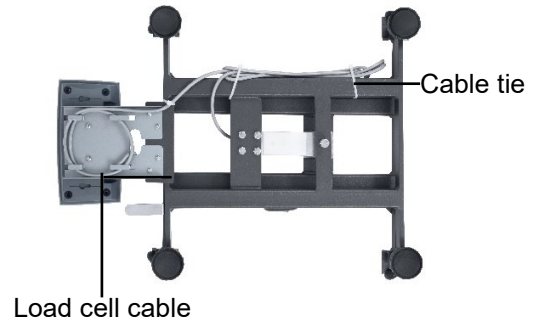

2. Loosen the 2 screws on the terminal mounting bracket to remove the terminal.
3. Select appropriate size screws that fit into the holes at the bottom of the terminal housing. See **Figure A**. When mounting to a wall without a solid backing, use appropriate anchoring hardware.

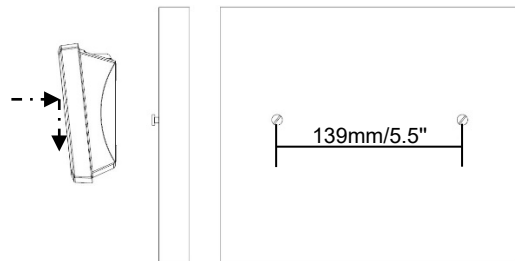

Figure A. Direct Wall Mount Arrangement

2.3.4 2nd Display Installation (available as option)

OHAUS offers a remote 2nd Display as an option which can be either mounted to a wall or desk, or mounted on an optional column. Commonly this is used for displaying weight results to a customer in a retail application. The remote 2nd Display connects to the Courier 7000 terminal using the Mini DIN connection – when connected, the other connection options (2nd RS232, Ethernet or WiFi/Bluetooth) cannot be also connected.

Wall-Mounted Display

The 2nd display may be mounted directly to a wall using two screws (not included).

1. Use the male end of the 2nd display to connect the Mini DIN on the terminal through the hole on the terminal mounting bracket.

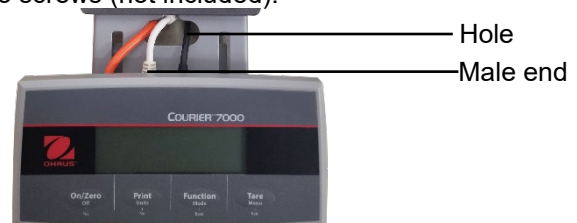

2. Select appropriate size screws that fit into the holes at the bottom of the housing. See **Figure B**. When mounting to a wall without a solid backing, use appropriate anchoring hardware.

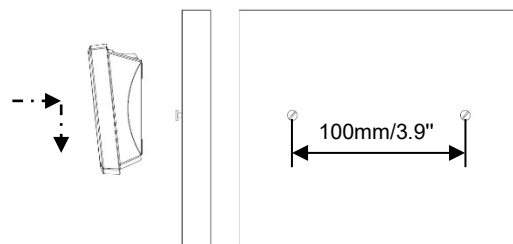
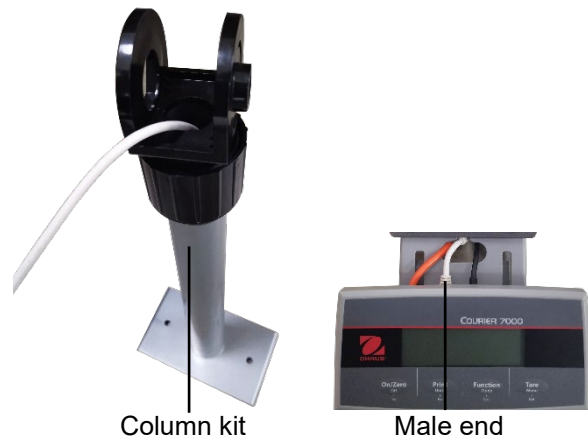

Figure B. Direct Wall Mount Arrangement

Column Kit Display

To install the 2nd display on the column kit:

1. Use the male end of the 2nd display to connect the Mini DIN of the terminal through the column kit.



2. Install the 2nd display on the column kit.
3. Install the column kit to the countertop with the screws.

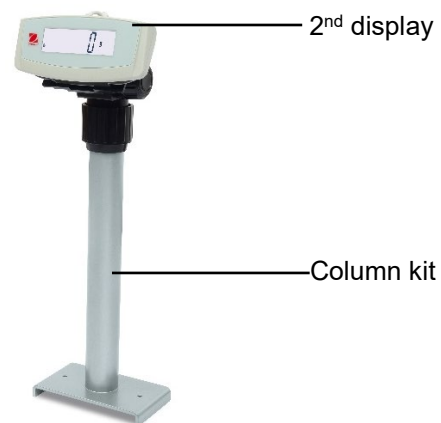

All the options can work via the Mini DIN connector on the Courier 7000 scale. Refer to the figure 2-1, you can find the pinouts definition for the Mini DIN.

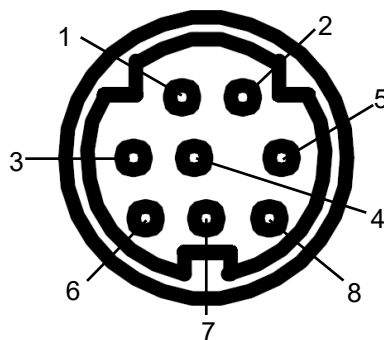

Figure 2-1 Courier 7000 Mini DIN

Item	Function (color)	Item	Function (color)
1	GND	5	CTS
2	VCC	6	RTS
3	TXD	7	P_EN
4	RXD	8	Option_DCT

2.4 Leveling the Equipment

To ensure accuracy, proper performance and safety, locate and operate the base on a stable, level surface. Avoid locations with rapid temperature changes or excessive dust, air currents, vibrations, electromagnetic fields or heat.

Level the base by adjusting the four leveling feet until the bubble in the level indicator is centered. A wrench may be needed to loosen the locking nut above each leveling foot. When the base is level, retighten the locking nuts up against the base to lock each foot into place.

NOTE: Ensure that the base is level each time its location is changed.



Correct



Incorrect

3. OPERATION

3.1 Turning On/Off the Scale

To turn on the scale, you can press the **On** button. The scale performs a display test, and momentarily displays the software version, the GEO value and then enters the last active weighing mode.

NOTE: If the hardware lock switch is enabled, **LFE ON** will also be displayed briefly.

To turn the scale off, you can long press the **Off** button until **OFF** is displayed.

3.2 Setting the Display to Zero

The value of the display can be set to zero under the following conditions:

1. Automatically at Power On (Initial zero).
2. Semi-automatically (Manually) by pressing the **ON/ZERO Off** button.
3. Semi-automatically by sending the **Zero** command (Z or alternate zero command).

If you want to set the value of the display by pressing the **ON/ZERO Off** button, please make sure that the scale is stable.

3.3 Changing the Units of Measure

To change the weighing unit, you can long press the **Print Units** button until the wanted weighing unit appears on the display.

3.4 Printing Data

Before you print out the displayed data with a printer or sending the data to a computer, please set the communication parameters in the **Print Menu** (Refer to 4.7 Print Menu).

You can press the **PRINT Units** button for sending the displayed data to the communication port.

3.5 Application Modes

Activating / Deactivating the Application Mode

To activate or deactivate the application mode, you can do the steps that follow.

1. Long press the **Menu** button until **APP.M.U** appears on the display.
2. Release the **Menu** button, and **C.R.L** appears on the display.
3. Short press the **No** button several times until **APP.d.E** appears on the display.
4. Press the **Yes** button to enter the application mode.
5. Short press the **No** button several times until the wanted selection appears on the display.
6. Press the **Yes** button, and **ON** appears on the display. If you want to activate the application mode, short press the **Yes** button. If you want to deactivate the application mode, short press the **No** button until **OFF** appears on the display, then short press **Yes** button.

3.5.1 Weighing

This mode is the default factory setting, and it is used to determine the weight of the loads in the selected unit of measure.

Entering the Mode and Starting to Weigh

To enter the weighing mode, you can do the steps that follow:

1. Long press the button **Function Mode** until **WEIGH** appears on the display.
2. Put the container on the scale. Once the value is stable, you can see “*” on the display.
3. Press the button **Tare** to tare. If the scale performs well, you can see the value on the display is 0.
4. Put the load on the container and read the weight value of the load from the display. Once the value is stable, you can see the “*” is on the display.

NOTE: You can check the value of the tare weight by long pressing the **Tare** button.

The Weighing configurations are defined below (Defaults in Bold).

Item	Available Settings	Comments
Weighing (WEIGH)	On , off	To enable or disable Weighing

NOTE: You cannot disable the Weighing mode if you are in the mode currently.

3.5.2 Totalization

This application is used to accumulate the multiple weights manually or automatically. Statistical data (the number of samples, the total weight, the average weight, the minimum weight, the maximum weight and the difference in weight) is stored in memory for review and printing.

Application Settings

There are three totalization options:

Off (**OFF**): Disable the totalization function.

Manual (**MAN**): Enable the totalization function manually with **Function** button.

Automatic (**AUTO**): The scale performs the totalization function automatically.

NOTE: The option of Manual is the default setting.

Setting the Totalization Option:

1. Long press the **Menu** button until the **MEAU** appears on the display.
2. Release the **Menu** button, the **CAL** appears on the display.
3. Short press the **No** button several times until **MODE** appears on the display, then press the **Yes** button. If you do it successfully, you can see the **RESET** on the display.
4. Short press the **No** button several times until **LEGAL** appears on the display, then press **Yes** button to enter the sub menu.
5. Short press the **No** button several times to select the wanted totalization option. If the wanted option appears on the display, you can press **Yes** button to confirm.
6. Press the **Exit** button to exit.

Entering the Mode

1. Long press the **Mode** button until **LEGAL** appears on the display.
2. Release the **Mode** button, and the **CLR.ACC** appears on the display.
 - If you need to remove the stored totalization result of the last time, you can press the **Yes** button, and then the scale performs the totalization function.
 - If you need to reuse the stored totalization result of the last time, you can press the **No** button to continue the totalization of the last time.

NOTE: If there is a container on the scale, the display shows **CLR.PAN** until the container is removed or you press the **Tare** button to tare.

Totalization Method

Manual: The operator initiates the totalization with the **Function** button.

Automatic: The scale performs the totalization function automatically.

If the scale performs the totalization well, you can see the Σ is flashing. It will keep flashing until the weight is removed and the platform is stable.

NOTE:

- Before you weigh the next load, you must remove the previous load from the scale.
- The scale only stores the stable value of the display.
- When Legal for Trade is turned ON, for NTEP models, gross and net weight cannot be added to the same total. If the first weight is recorded in gross, the next one should be recorded in the same way. It is the same for the net weight.

Checking the Totalization Result

When the scale is empty, you can press the **Function** button to check the result.

The result includes the number of samples, the total weight, the average weight, the minimum weight, the maximum weight and the difference in weight (the maximum weight minus the minimum weight). The values are displayed for 1 second each.

Totalization Rules

You will fail to do the totalization operation under the following conditions.

1. The current weight value is unstable.
2. The net weight of the load is smaller than 5d.
3. The overall totalized weight is larger than 999999. (The unit depends on your setting.)
4. The total number of totalizations exceeds 9999 times.

Printing Totalization Result and Format

1. Refer to the steps below, you can enable the Table on (**TABLE**) option in the menu.
 - a) Long press the **Menu** button until you see **TABLE**.
 - b) Release the **Menu** button and **TABLE** appears on the display.
 - c) Short press the **No** button several times until **TABLE** appears on the display.
 - d) Press the **Yes** button to enter the sub menu
 - e) Short press the **No** button several times until **TABLE** appears on the display, then press the **Yes** button to enter the table setting options.
 - f) Short press the **No** button until **ON** on the screen.
 - g) Press the **Yes** button to confirm. And **END** appears on the display.
 - h) Press the **Exit** button to exit.
2. The Table option is enabled.
 - In automatic totalization mode, the scale will automatically totalize the current weight when it performs totalization successfully.
 - In manual totalization mode, you can press the **Function** button to totalize the current weight and print it accordingly.

3. The output for current weight will appear as the example below.

Example:

1.	1000 g N
2.	2000 g N
3.	3000 g N
4.	1999 g N
5.	1000 g N

4. When the totalization is finished, you can print the totalization result by below two steps.
 1. Remove the load from the scale.
 2. Press the **Function** button, and the totalization result appears on the display.
 3. Press the **Print** button to print the result.

Refer to the example below, you will see the output of the totalization result.

Example:

n:	5
Total:	100.000 g
Avg:	200.000 g
Min:	10.500 g
Max:	88.200 g
Diff:	78.300 g

NOTE: The scale supports 32 characters, the first line is "-". The colon is left aligned, and the Weights/Numbers are right aligned.

3.5.3 Dynamic Weighing

This application is used to weigh an unstable load, such as a moving animal. Three different start/reset operation types can be selected:

- Off (**OFF**) = Disable the mode.
- Manual (**MAN**) = Averaging and resetting are initiated manually by pressing the **FUNCTION** key.
- Semi-Automatic (**SEMI**) = Averaging is automatically initiated when the load weight is bigger than the start weight; resetting is initiated by pressing the **FUNCTION** key.
- Automatic (**AUTO**) = Averaging is automatically initiated when the load weight is bigger than the start weight; resetting is automatically initiated when the weight on the display is less than 5d.

Display Hold

When the time is set to 0, the instrument will hold the displayed weight value on the display if that weight is greater than 5 divisions.

NOTE: The minimum start weight is 5 divisions. If the scale does not operate, please check if the load is greater than 5 divisions.

Entering the Dynamic Weighing Mode

To enter the dynamic weighing mode, you can do the steps that follow.

1. Long press the button **Function Mode** until **ᄇᄃᄆᄆᄆ** appears on the display.
2. Release the button **Function Mode**, and **ᄆᄆᄆᄆ** appears on the display.

Starting Dynamic Weighing

1. Put the load on the scale.
 - If the operation type is manual, you must press the **Function** button to start the averaging process.
 - If the operation type is semi-automatic/automatic, the scale performs the averaging process automatically when the load weight is bigger than the start weight.

NOTE:

- You can set the value of the start weight via this path: **ᄆᄆᄆᄆ.ᄆᄆᄆᄆ > ᄆᄆᄆᄆᄆᄆ > ᄇᄃᄆᄆᄆᄆ > ᄆᄆᄆᄆᄆᄆ**. And the correct range of the start weight value is 5d - capacity value.
 - During the averaging period, the countdown timer decreases in one second increments. If the set average time is 0s, the countdown timer is not displayed.
 - The values on the display are averaged and held on the display when the countdown is completed.
2. Read the values on the display if the tilde (dynamic) symbol blinks on the display.
 3. Reset the countdown timer:
 - If the operation type is manual/semi-automatic, you can press the **Function** button to reset the countdown timer when the countdown is running. The display shows **ᄆᄆᄆᄆᄆ**, and start to re-count.
 - If the operation type is automatic, you can remove the load from the scale. And the average weight will still be displayed until the duration time is over. Then the display shows **ᄆᄆᄆᄆᄆ**, and start to re-count.

NOTE:

- The **ᄆᄆᄆᄆᄆ** display must be at zero gross or net value to reset the countdown timer.

Application Settings

The Dynamic Weighing Configurations are defined below (Defaults in Bold).

Item	Available Settings	Comments
Dynamic Mode (ᄇᄃᄆᄆᄆᄆ)	Off (ᄆᄆᄆ) / on (ᄆᄆ)	Count down: There is a countdown time.
Dynamic Operation Type (ᄆᄆᄆᄆᄆᄆ)	Manul (ᄆᄆᄆᄆᄆ)/ Semi-auto (ᄆᄆᄆᄆ ᄆ)/ Auto (ᄆᄆᄆᄆᄆ)	Manual: The averaging process is started and reset manually. Semi-auto: The averaging process is started automatically and reset manually. Auto: The averaging process is started and reset automatically.
Start Weight (ᄆᄆᄆᄆᄆᄆ)	5d ~ Capacity Weight	Dynamic weighing will start when the load is bigger than the start weight (for Semi-auto and Auto mode).
Duration Time (ᄆᄆᄆ ᄆᄆᄆᄆ)	1 ~ 10s	It is the time for the display to remain the dynamic weighing result after the load is removed.
Average Time (ᄆᄆᄆ ᄆᄆᄆᄆ)	0 ~ 30s	Time in Seconds. If the average time is 0, the first stable weight (more than or equal to 5d) will be the result.

NOTE: The Dynamic mode cannot be disabled if the scale is in the Dynamic mode currently.

3.5.4 Weight Alert

This application is used to judge if the weight of the item is within the target limit. There are 2 limit values for setting, the limit 1 is normally open as default.

Setting the Limit Values

1. Long press the **Mode** button until **AL EAL** appears on the display.
2. Release the **Mode** button, the **CLr.ALE** appears on the display.
3. Press **Yes** button to remove the stored alert limit value, and **L 100.1** appears on the display.
4. Press **Yes** button, **000000** is flashing on the display with the current unit.
5. To set the limit value 1, you can do the steps that follow:
 - a) Use the buttons **NO** and **Back** to set a number for the first digit.
 - b) Short press the **Yes** button to confirm the number and move to the next digit.
 - c) Repeat the steps a) and b) to set numbers for all the digits.
 - d) Press **Yes** button to confirm the value. If the value is not in the correct range, the **NO** appears on the display. You must repeat the steps 3, 4 and 5 to set the value. If the value is in the correct range, the **L 100.2** appears on the display.

NOTE: If the **L 100.2** is set to off, the **L 100.2** will not appear on the display and the scale goes into the weighing status directly.
6. Repeat steps 4 and 5 to set the limit value 2. If the value is not in the correct range, **NO** appears on the display. If the value is in the correct range, the scale goes into the weighing status.

NOTE:

1. You can check the limit values by short pressing the **Function** key.
2. You can set either or both of the limit values. If the weight value of the load is larger than either limit value, the segment text and the backlight blinks at the same time. Thus, the load is not acceptable.

If the weight value of the load is larger than both the limit values, the segment text blinks. Thus, the load is not acceptable.

The maximum limit value is not larger than the capacity value.

4. MENU SETTINGS

The User Menu allows the users to customize the scale settings.

Note: Sub-menu for options (USB, Ethernet and Wireless in the table below) will be active when the specific board is installed. Refer to the accessory manuals, you can find the additional setting information.

4.1 Menu Navigation

4.1.1 User Menu (In segments)

CAL	SEt.uP	r.EAd	MOdE	UNIt	r.S.2.3.2	P.r. int	2.5.E.r. 1A	P.r. int2
ZErD	rESEt	rESEt	rESEt	rESEt	rESEt	rESEt	rESEt	rESEt
SPAN	C.UnIt	StAbLE	bWElGH	g	bAud	ASSIGN	bAud	ASSIGN
LIn	CRP	ZErD	dYNAMM	kg	PARity	dERRAN	PARity	dERRAN
GEO	GrAd	FILtEr	d.tYPE	lb	StOP	ON.StAb	StOP	ON.StAb
C.tESEt	P.ZErD	RZt	d.StAr-t	oz	H.SHARtE	ON.ACCEP	H.SHARtE	ON.ACCEP
ENd	P.UNIt	b.LIGHt	d.tIPtE	lb:oz	ALt.P	INtEr	ALt.P	INtEr
	A.tAr-E	SCR-EEN	A.tIPtE	ENd	ALt.t	MOt.Con	ALt.t	MOt.Con
	ENd	A.OFF	tOtAL		ALt.2	OH.Con	ALt.2	OH.Con
		P.SAUEr	tAbLE		ENd	SICS	ENd	SICS
		ENd	ALERt			NC1		NC1
			L.MO.2			8213		8213
			ENd			3835		3835
						SCPD1		SCPD1
						StAbLE		StAbLE
						CONtNt		CONtNt
						LAYOUT		LAYOUT
						ENd		ENd
U.S.b	P.r. int.U	E.t.H.N.E.t	P.r. int.E	bW. l.-b.t	P.r. int.H	L.o.c.t	ENd	
rESEt	rESEt	rESEt	rESEt	rESEt	rESEt	rESEt		
tYPE	ASSIGN	IP.Addr	ASSIGN	tYPE	ASSIGN	L.ALL		
HId	dERRAN	v.E.r.	dERRAN	IP.Addr	dERRAN	L.OFF		
CdC	ON.StAb	ALt.P	ON.StAb	d.NARtE	ON.StAb	L.ZErD		
ALt.P	ON.ACCEP	ALt.t	ON.ACCEP	P.COdE	ON.ACCEP	L.Pr int		
ALt.t	INtEr	ALt.2	INtEr	ALt.P	INtEr	L.UnIt		
ALt.2	MOt.Con	ENd	MOt.Con	ALt.t	MOt.Con	L.MOde		
ENd	OH.Con		OH.Con	ALt.2	OH.Con	L.MENU		
	SICS		SICS	ENd	SICS	L.tAr-E		
	NC1		NC1		NC1	ENd		
	8213		8213		8213			
	3835		3835		3835			
	SCPD1		SCPD1		SCPD1			
	StAbLE		StAbLE		StAbLE			
	CONtNt		CONtNt		CONtNt			
	LAYOUT		LAYOUT		LAYOUT			
	ENd		ENd		ENd			

NOTE:

- The following menus will not appear until the corresponding accessories are installed.
 - The **2.5.E.r. 1A** and **P.r. int2** will not appear until option RS232 is installed.
 - The **U.S.b** will appear if you connect the scale into a PC with the USB type-C. And you can select the **HId** or **CdC** type.
 - The **P.r. int.U** will appear if you select **CdC** type.
 - The **E.t.H.N.E.t** and **P.r. int.E** will appear if the ethernet board is installed.
 - The **bW. l.-b.t** and **P.r. int.H** will appear if the USB Host is installed.

2. Some modes/units may not be available in all models. When LEGAL FOR TRADE is turned **ON** (the security switch S1 is in the locked position), the menu settings will be affected as below:
- Calibration function is disabled.
 - Zero Range setting is locked at 2%.
 - Stable Range setting is locked at 1d.
 - Auto-Zero Tracking setting is locked at 0.5d.
 - Filter and Units are locked at their current settings.
 - Stable Only is locked at On.
 - Lb:oz unit is only for postal use if it is available.
 - Power saving mode is disabled.
- NOTE:** Refer to 5.1 Settings for the position of the security switch S1.

4.1.2 Button Navigation

For menu items which need to set numbers such as the scale capacity, the current number is displayed with all digits flashing. To revise:

1. Press the **No** button to begin editing.

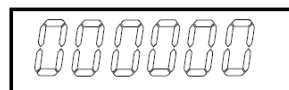

2. The first digit is displayed flashing.



3. Press the **No** button to increase the digit or press the **Yes** button to accept the digit and move to the next one.



NOTE: press the **Back** button can decrease the digit.

4. Repeat this process for all digits.



5. Press the **Yes** button when the last digit has been set.



6. The new setting is displayed with all digits flashing. Press the **Yes** button to accept the setting or press the **No** button to resume editing.

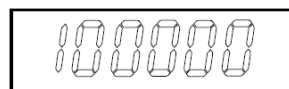

7. To end the current menu selection, press the **Yes** button to advance to the next menu, or press the **No** button to return to the top of the current menu.

4.2 Calibration Menu

The scale can perform calibrations if you select the calibration menu **C.A.L.**

Changing the Calibration Unit

If you want to change the calibration unit, you can do the following steps.

1. Long press the **Menu** button until **U.N.I.T** appears on the display.
2. Release the **Menu** button, and **C.A.L** appears on the display.
3. Short press the **No** button, and **S.E.T.U.P** appears on the display.
4. Press the **Yes** button to enter the sub menu.
5. Short press the **No** button, and **C.U.N.I.T** appears on the display.
6. Short press the **Yes** button, and **kg / lb** blinks on the display. If you want to change the unit, short press the **No** button.
7. Short press the **Yes** button to confirm.

4.2.1 Initial Calibration

When the scale is operated for the first time, a zero and span calibration are recommended to ensure accurate weighing results.

Before performing the calibration, be sure to have the appropriate calibration weights as listed in table 4-1. Ensure that the LFT switch/calibration lock is set to the unlocked position.

You can also adjust the GEO setting according to your location. For detailed GEO information, please check the **GEO Code Adjustment** section below.

Table 4-1 Suggested Span Calibration Mass (Sold Separately)

Max Capacity (kg)	Mass* (kg)	Max Capacity (lb)	Mass* (lb)
15kg	15kg	30lb	30lb
60kg	60kg	100lb	100lb
150kg	150kg	150lb	150lb
		250lb	250lb

NOTE: The calibration unit is consistent with the capacity unit.

4.2.2 Zero Calibration [ZE-0]

The scale performs zero calibration with one calibration point. The zero-calibration point is established with no weight on the scale. You can use this calibration method to adjust for a different static load without affecting the span or linearity calibration.

Calibration procedures:

1. Long press the **Menu** button until you see **0.0.0.0**.
 2. Release the button and wait for the display to show **C.A.L.** Press the **Yes** button.
 3. The display shows **ZE-0**. Press the **Yes** button.
 4. **0** kg and the calibration unit are flashing on the display. With no weight on the platform, press the **Yes** button to establish the zero point.
 5. The display shows **--C--**, and then **-done-** when the Zero calibration is finished.
- NOTE:** If zero calibration is failed or if after 40 seconds the calibration is still not successful, **CAL E** is displayed for 3 seconds and the previous calibration data will be restored.
6. Then the display shows **SPAN**. Press the **Exit** button to exit.

4.2.3 Span Calibration [SPAN]

The scale performs span calibration with one calibration point. It is established with a calibration mass placed on the scale.

NOTE: Span calibration should be performed after zero calibration.

Calibration procedures:

1. Long press the **Menu** button until you see **0.0.0.0**.
2. Release the button and wait for the display to show **C.A.L.** Press the **Yes** button.
3. Short press the **No** button to navigate until you see **SPAN**. Press the **Yes** button.
4. The calibration point and the unit are flashing on the display based on the scale capacity and unit set in the menu. (e.g. **030.000** kg) If you do not need to change the calibration point, skip to step 6.
5. To change the calibration point, you can do the steps that follow.
 - a) Short press the **No** button several times until the desired number appears.
NOTE: press the **Back** button can decrease the digit.
 - b) Short press the **Yes** button to accept the number and move on to the next digit.
 - c) Repeat the process until all the digits are correct.
 - d) Press the **Yes** button to accept calibration point. It is flashing on the display.
6. Place a calibration mass of the specified weight on the platform and press the **Yes** button.
7. The display shows **--C--**, and then **-done-** when the calibration is finished.
8. Then the display shows **L IN**. Press the **Exit** button to exit.

NOTE:

- If the scale does not perform the calibration successfully, **CAL E** is displayed for 3 seconds and the previous calibration data is restored.
- After waiting for 40 seconds, if the scale still fails to perform the calibration, **CAL E** is displayed for 3 seconds, and the previous calibration data is restored.

4.2.4 Linearity Calibration [L 17]

The scale performs linearity calibration with 3 calibration points. The full calibration point is established with a weight on the platform. The mid calibration point is established with a weight equal to half of the full calibration weight on the platform. The zero calibration point is established with no weight on the platform. The full calibration and mid calibration points can be altered by users during the calibration procedure.

Calibration procedures:

1. Long press the **Menu** button until you see **07.E.N.U.**
2. Release the button and wait for the display to show **C.R.L.** Press the **Yes** button.
3. Short press the **No** button several times to navigate until you see **L 17**. Press the **Yes** button.
4. **0** kg and the calibration unit are flashing on the display. With no weight on the platform, press the **Yes** button to establish the zero point. The display shows **--[--**.
5. Then the first calibration point and the unit are flashing on the display based on the scale capacity and unit you set in the setup menu. (For example, **0 15.000** kg). If you do not need to change the calibration point, skip to step 7.
6. To change the calibration point, you can do the steps that follow.
 - a) Short press the **No** button several times until the desired number appears.
NOTE: press the **Back** button can decrease the digit.
 - b) Short press the **Yes** button to accept the number and move on to the next digit.
 - c) Repeat the process until all the digits are correct.
 - d) Press the **Yes** button to accept calibration point. It is flashing on the display.
7. Place a calibration mass of the specified weight on the platform and press the **Yes** button. The display shows **--[--**.
8. The second calibration point and the unit are flashing on the display based on the capacity and unit you set in the setup menu. (For example, **030.000** kg)
NOTE: After waiting for 40s, if the scale still fails to perform the calibration, **CAL E** is displayed for 3 seconds and the previous calibration data is restored.
9. Repeat step 6 and 7.
10. The display shows **--[--**, and then **-donE-** when the Linearity calibration is finished.
11. After that the display shows **GEO**. Press the **Exit** button to exit.

4.2.5 GEO Code Adjustment [GEO]

Geographical Adjustment Factor (GEO) code is used to adjust the calibration based on the current location. Settings from 0 to 31 are available with 12 being the default.

Refer to **9.3 Table of GEO Code Values** to determine the GEO factor that corresponds to the terminal's location.

To set the GEO factor, you can do the steps that follow.

1. Long press the **Menu** button until you see **07.E.N.U.**
2. Release the button and wait for the display to show **C.R.L.** Press the **Yes** button.
3. Short press the **No** button several times to navigate until you see **GEO**. Press the **Yes** button.
4. The GEO point is flashing on the display (For example, **12**).
5. Short press the **No** button several times until the desired GEO number appears. Press the **Yes** button to accept.
NOTE: Press the **Back** button can decrease the digit.
6. Then the display shows **C.tESEt**. Press the **Exit** button to exit.

4.2.6 Calibration Test [C.ESEt]

Calibration test procedures:

1. Long press the **Menu** button until you see **00.E.0.0**.
2. Release the button and wait for the display to show **C.R.L**. Press the **Yes** button.
3. Short press the **No** button several times to navigate until you see **C.ESEt**. Press the **Yes** button.
4. **0** and the calibration unit are flashing on the display based on the capacity and unit you set in the setup menu. With no weight on the platform, press the **Yes** button to establish the zero point.
5. The display shows **--C--** while the zero point is recorded.
6. The calibration weight and the unit of the last time are flashing on the display. (For example, **0 15.000** kg).
6. To change the test calibration weight, you can do the steps below.
 - a) Short press the **No** button several times until the desired number appears.
NOTE: press the **Back** button can decrease the digit.
 - b) Short press the **Yes** button to accept the number and move on to the next digit.
 - c) Repeat the process until all the digits are correct.
 - d) Press the **Yes** button to accept the calibration point. It is flashing on the display.
7. Place the specified test weight on the platform and press the **Yes** button.
8. The difference between the calibration data and the test weight is flashing on the display. (For example, **0.0 10** kg). If the terminal is connected to a printer or other devices, the result will be printed.
NOTE: the printed result will appear as below:

Example:

```

----- Cal Test -----
New Cal:15.000kg
Old Cal:15.000kg
Diff Cal:0.0000kg
Wt. ID:_____
----- End -----

```

9. After 5 seconds, the test ends and the scale returns to the active weighing mode, displaying the current weight.

4.2.7 End Cal [End]

When **End** is displayed, you can press the **Yes** button to exit this menu and enter the next sub-menu, or press the **No** button to enter to the first menu item in this sub-menu.

4.3 Setup Menu

You can set the scale parameters with the menu **S.E.t.u.P**. Default settings are in **bold**.

Menu	Sub-Menu	Sub-Menu (in segment)	Options	Options (in segment)
Setup S.E.t.u.P	Reset	rESEt	no, yes	NO. YES
	Capacity Unit	C.UN t	kg, lb	/
	Capacity	CAP	1-99999.9	/
	Graduation	GrAd	0.0001~100	/
	Power On Zero	P.ZEr0	Off, On	OFF, ON
	Power On Unit	P.UN t	Auto , g, kg, lb, oz, lb:oz	AUTO
	Auto Tare	A.tArE	Off , On	OFF, ON
	End	End	/	/

NOTE: / indicates that it is not applicable in the table above.

Reset [rESEt]

Reset the Setup menu to factory defaults.

NO = do not reset

YES = reset

Capacity Unit [C.UN t]

Select the unit used for calibration.

kg

lb

Capacity [CAP]

Set the capacity of the scale or the first capacity of the scale.
1-999999

Grad [GrAd]

Set the scale readability or the first readability of the scale.
0.0001~100

Power On Zero [P.ZEr0]

Zero the scale at Power On.

- OFF = disabled.
- ON = enabled.

Power On Unit [P.ON U]

Set the unit that will be displayed at Power On.

- AUTO = last unit in use when turned off
- kg = kilograms
- g = grams
- lb = pounds
- oz = ounces
- lb:oz = pound ounces

Auto Tare [A.tArE]

Set the automatic tare feature.

- OFF = automatic tare is disabled.
- ON = the first stable gross weight is tared. The tared value will be cleared when the terminal returns to gross zero.

4.4 Readout Menu

You can set the user preferences with the readout menu. Default settings are in **bold**.

Menu	Sub-Menu	Sub-Menu (in segment)	Options	Options (in segment)
Read Out (r.E.R.d)	Reset	rESEt	no, yes	NO, YES
	Stability	StAbLE	0.5d, 1d , 2d, 5d	0.5d, 1d , 2d, 5d
	Zero Range	ZEr0	2%, 100%	2, 100
	Filter Level	FiLteR	Low, Medium , High	LOW, MEd , HIGH
	Auto Zero Track	AZt	Off, 0.5d , 1d, 3d	OFF, 0.5d , 1d, 3d
	Back Light	b.LiGHt	Off, On, Auto	OFF, ON, AUTO
	Screen Saver	ScREEn	Off, 1min , 2min, 5min	OFF, 1 , 2, 5
	Auto Off	A.OFF	Off , 1min, 5min, 10min	OFF , 1, 5, 10
	PWM.SAVE	P.SAVEr	ON, OFF	ON, OFF
	End	ENd	/	/

NOTE: / indicates that it is not applicable in the table above.

Reset [rESEt]

Reset the readout menu to factory defaults.

- NO = do not reset.
- YES = reset

Stability [StAbLE]

Set the amount reading can vary before the stability symbol turns off.

- 0.5d = 0.5 of a scale division
- 1d = 1 scale division**
- 2d = 2 scale divisions
- 5d = 5 scale divisions

Zero [ZEro]

Set the percentage of scale capacity that can be zeroed.

- 2% = zero range is within +/-2%
- 100% = zero range is within +/-100%**

Filter [F ILtEr]

Set the amount of signal filtering.

- LOW = faster stabilization time with less stability.
- NORM = normal stabilization time with normal stability.**
- HIGH = slower stabilization time with more stability.

AZT [AZt]

Set the automatic zero tracking feature.

- OFF = disabled
- 0.5d = the display will maintain zero until a change of 0.5 of a divisions per second has been exceeded.**
- 1d = the display will maintain zero until a change of 1 division per second has been exceeded.
- 3d = the display will maintain zero until a change of 3 divisions per second has been exceeded.

Backlight [b.L IGht]

Set the display backlight feature.

- OFF = backlight is disabled.
- ON = backlight is enabled and always on.
- AUTO = backlight is disabled after 20 seconds of no activity.**

Screen Saver [ScREEn]

Set whether the screen saver is enabled after the selected time period.

- OFF = screen saver is disabled
- 1 = the screen saver is enabled after 1 minute of no activity.**
- 2 = the screen saver is enabled after 2 minutes of no activity.
- 5 = the screen saver is enabled after 5 minutes of no activity.

Auto Off [A.OFF]

Set whether the display enters sleep mode after the selected time period.

- OFF = disabled
- 1 = the display enters sleep mode after 1 minute of no activity.
- 5 = the display enters sleep mode after 5 minutes of no activity.
- 10 = the display enters sleep mode after 10 minutes of no activity.

PWM.SAVE [P.SAVEr]

Set whether to enable power saving mode after the scale enters standby mode. If it is enabled, it will take about 3 seconds before the terminal returns to weighing when weight is changed on the platform or you press the terminal's buttons.

- ON = power saving is enabled.
- OFF = power saving is disabled.**

End Readout [ENd]

Advance to the next menu or return to the top of the current menu.

4.5 Unit Menu

You can activate the desired units with the menu **U.N. I.E.**

- Reset
- Gram (g)
- Kilogram (kg)
- Pound (lb)
- Ounce (oz)
- Pound:Ounce (lb:oz)
- End

NOTE:

- Available units vary by model. In addition, due to national laws, the terminal may not include some of the units listed.
- If the security switch is turned on, the Units menu will be locked at their current setting.

4.6 RS232 Menu

You can define the communication parameters with this menu. Factory default settings are shown in **bold**.

Menu	Sub-Menu	Sub-Menu (In segment)	Options	Options (in segment)
RS232 (r.5.2.3.2)	Reset	rESEt	no, yes	NO , YES
	Baud Rate	bRud	300, 600, 1200, 2400, 4800, 9600 , 19200, 38400, 57600	/
	Parity	PAR tY	7 Even, 7 Odd, 7 None, 8 None	7 EVEN , 7 Odd , 7 NONE , 8 NONE
	Stop Bit	StOP	1 bit, 2 bit	1 b it , 2 b it
	Handshake	H.SHAKE	None , Xon/Xoff	NONE , ON-OFF
	Alt Print CMD	ALt.P	'A' ~ 'Z', P	/
	Alt Tare CMD	ALt.t	'A' ~ 'Z', T	/
	Alt Zero CMD	ALt.z	'A' ~ 'Z', Z	/
End	ENd	/	/	

NOTE: / indicates that it is not applicable in the table above.

Reset [rESEt]

Reset the RS232 menu to factory defaults.

- NO** = do not reset.
- YES** = reset

Baud Rate [bRud]

Set the baud rate (bits per second).

- 300 = 300 bps
- 600 = 600 bps
- 1200 = 1200 bps
- 2400 = 2400 bps
- 4800 = 4800 bps
- 9600** = 9600 bps
- 19200 = 19200 bps
- 38400 = 38400 bps
- 57600 = 57600 bps

Parity [PAR tY]

Set the data bits and parity.

- 7 **EVEN** = 7 data bits, even parity
- 7 **Odd** = 7 data bits, odd parity
- 7 **NONE** = 7 data bits, no parity
- 8 NONE** = 8 data bits, no parity

Stop bit [STOP]

Set the number of stop bits.

1 bit = 1 stop bits

2 bit = 2 stop bits

Handshake [HANDSHAKE]

Set the flow control method. Hardware handshaking is only available for COM1 menu.

NONE = no handshaking

ON-OFF = XON/XOFF software handshaking

Alternate Print command [ALT.P]

Set the alternate command character for Print.

Settings of A (a) to Z (z) are available. The default setting is **P**.

Alternate Tare command [ALT.T]

Set the alternate command character for Tare.

Settings of A(a) to Z(z) are available. The default setting is **T**.

Alternate Zero command [ALT.Z]

Set the alternate command character for Zero.

Settings of A (a) to Z (z) are available. The default setting is **Z**.

NOTE: Setting of **P**, **T** and **Z** are not available in more than one command options.

End [END]

Advance to the next menu or return to the top of the current menu.

4.7 Print Menu

You can set the parameters with the Print menu. Default settings are in **bold**.

Menu	Sub-Menu	Sub-Menu (In segment)	Options	Options (In segment)
Print (P.r. n.t)	Reset	rESEt	no , yes	NO , YES
	Assignment	ASSIGN	Demand , Auto On Stable, Auto On Accept, Interval(seconds), MT-Continuous, OH-Continuous, SICS, NCI, 8213, 3835, SCP01	DEMAND , ON.StAb, ON.ACCEP, INLEr, P7E.CON, OH.CON, SICS, NC I, 8213, 3835, SCP01
	Stable Weight Only [Demand]	StAbLE	Off , On (LFT Force On)	OFF , ON
	Mode [Auto On Stable]	MOdE	Load , Load and Zero	LOAD , LOAD:Zr
	Time [Interval (seconds)]	tIME	1~5000	/
	Content	CONtEnt	Result , Gross, Net, Tare, Header, Footer, Mode, Unit, Info	rESult , GROSS, NET, tArE, HEAdEr, FOOtEr, MOdE, UN It, INfO
	Layout	LAYOUt	Format , Feed	FORMat , FEEd
	End	END	/	/

NOTE: / indicates that it is not applicable in the table above.

Reset [rESEt]

Reset the Print menu to factory defaults.

NO = do not reset

YES = reset

Assignment [A55 500]

Demand = printing occurs when **Print** key is pressed.

On Stable = printing occurs each time the stability criteria are met

On Accept = printing occurs each time the display is within the Weight Alert accept range and stability criteria are met.

NOTE: On Accept will appear when the **Weight Alert** mode is enabled.

Interval = printing occurs at the defined interval

Continuous = printing occurs continuously

NCI = Refer to 6.3.1 NCI Protocol

8213 = Refer to 6.3.2 8213 Interface Protocol

3835 = Refer to 6.3.3 3835 Protocol

NCI-SCP01 = Refer to 6.3.4 NCI-SCP01 Protocol

Demand [dE0000]

If **Demand** is selected, the sub-menu **Stable Only** will display.

Set the printing criteria.

OFF = values are printed immediately, regardless of stability.

ON = values are printed only when the stability criteria is met.

Auto On Stable [00.5tAb]

If **Auto On Stable** is selected, the sub-menu **Mode** will display.

Set the printing mode.

Load = prints when the displayed load is stable.

Load:Zr = prints when the displayed load and zero reading are stable.

Auto On Accept [00.ACeP]

If **Auto On Accept** is selected and the weighing mode is **Alert**, values will be printed when the weight is accepted.

00.ACeP = printing occurs each time the display is within the Alert range and stability criteria is met.

Interval [IntEr]

If **Interval** is selected, the sub-menu **Time** will display.

IntEr = printing occurs at the defined time interval.

Settings of 1 to 5000 seconds are available. Default is 1.

Printing occurs at the defined time interval.

MT-Continuous [00t.C00]

Continuous = printing occurs continuously.

If MT-Continuous is selected, the print output will be in the MT-Continuous format.

00t.C00 = printing occurs continuously.

NOTE: Refer to 11.1 MT Standard Continuous Output for MT-Continuous format.

C.5000

The **C.5000** has two options.

OFF = disabled

ON = enabled

When the **C.5000** is set to on, if you select MT-Continuous, the output has the check digits.

When the **C.5000** is set to off, if you select MT-Continuous, there are no check digits in the output.

OH-Continuous [0H.C00]

If OH-Continuous is selected, the print output will be in the OH-Continuous format.

NOTE: Refer to 11.4 OH-Continuous Print for OH-Continuous format.

0H.C00 = printing occurs continuously.

SICS [5 tS]

OFF = disable MT-SICS command

ON = enable MT-SICS command

NOTE: Refer to 11.2 MT-SICS Commands for SICS commands

Content [CONTENT]

Define the content of the printed data.

Result

Set the status.

OFF = disabled

ON = the displayed reading is printed

Gross

Set the status.

OFF = disabled

ON = the gross weight is printed

Net

Set the status.

OFF = disabled

ON = the net weight is printed

Tare

Set the status.

OFF = disabled

ON = the Tare weight is printed

Header

Set the status.

OFF = disabled

ON = the Header is printed

NOTE: Refer to 11.3 OHAUS Commands to learn how to enter the header text.

Footer

Set the status.

OFF = disabled

ON = the Footer is printed

NOTE: Refer to 11.3 OHAUS Commands to learn how to enter the footer text.

Mode

Set the status.

OFF = disabled

ON = the Mode is printed

Unit

Set the status.

OFF = disabled

ON = the Unit is printed

Info

Set the status.

OFF = disabled

ON = the reference information is printed (ex. Alert limits)

Layout [LAYOUT]

Set the format of the data output to a printer or computer.

Format

Set the printing format.

MULTI = a multi-line (single column style) printout is generated.

SINGLE = a single line printout is generated.

Feed

Set the paper feed.

LINE = move a paper up one line after printing.

4LF = move a paper up four lines after printing.

FORM = a form feed is appended to the printout.

End Print [END]

Move to the next menu or return to the top of the current menu.

Selecting the Print Content

You may connect the terminal to a PC via the standard RS232 or optional communication interface and run the OHAUS ScaleMate software on the PC.

In **OHAUS ScaleMate > Print**, you can select the print contents (**Result, Gross, Net, Tare, Header, Footer, Mode, Unit and Info**). After you select the wanted content, please click the **Write** button to transmit the data to the scale. (For example: If you select the **Net** and **Gross**, then click the **Write** button in the ScaleMate software. The **Result** and **Gross** are enabled, and other options are disabled in the scale.) Therefore, you can see the net weight and the gross weight from the output.

NOTE: You can contact an authorized OHAUS dealer to install the ScaleMate software and learn more about the software's other functions.

4.8 Lock Button Configuration

This menu **L.o.c.k** is used to lock access to certain buttons. When you select ON for one selection, the associated button press will be ignored.

If you select **Lock All Keys**, you will lose function of all buttons.

If the **Menu** button has been locked, long press the **Menu** button for 15 seconds until you see **UN.LOCK**. Press the **Yes** button to confirm.

Item	Available Settings (Bold is the default settings)
Lock All Keys [L.ALL]	OFF, ON
Lock Off Key [L.OFF]	OFF, ON
Lock Zero Key [L.ZErO]	OFF, ON
Lock Print Key [L.Pr int]	OFF, ON
Lock Unit Key [L.Un it]	OFF, ON
Lock Mode Key [L.MoDE]	OFF, ON
Lock Menu Key [L.MENU]	OFF, ON
Lock Tare key [L.tArE]	OFF, ON
Reset	NO, YES

5. LEGAL FOR TRADE

When the scale is used in trade or a legally controlled application, it must be set up, verified and sealed in accordance with local weights and measures regulations. It is the responsibility of the purchaser to ensure that all pertinent legal requirements are met.

5.1 Settings

Before verification and sealing, you can do the following steps:

1. Verify that the menu settings meet the local weights and measures regulations.
2. Perform a calibration as explained in **Calibration Menu** section.
3. Turn off the terminal.

Refer to the steps below, you can turn the security switch on.

1. Disconnect the power from the terminal.
NOTE: Remove the dry batteries of Courier 7000 if used.
2. Remove the housing.
3. Move the security switch (S1) to ON. Refer to the following graphic for the location of S1.

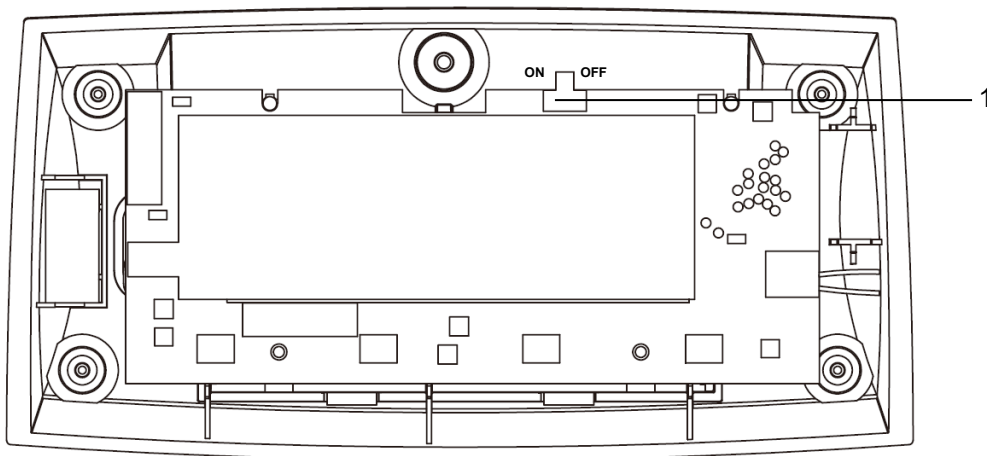

Item	Description
1	Security switch (S1)

Figure 5-1 Courier 7000 Security Switch (S1) Location

4. Install the housing.
5. Reconnect the power and turn the terminal on.

5.2 Verification

The local weights and measures official or authorized service agent must perform the verification procedure.

5.3 Sealing

The scale is verified and must be sealed to prevent undetected access to the legally controlled settings. Refer to the illustrations below for sealing methods.

- Paper sealing: affix the sealing paper on the countersunk screw shown as Figure 5-2.
- Wire Sealing: replace the countersunk screw by a cross-drilled screw that can be found in the packaging box. Then thread a sealing wire through the screw head and a permanent tab on the bottom housing shown as Figure 5-3.

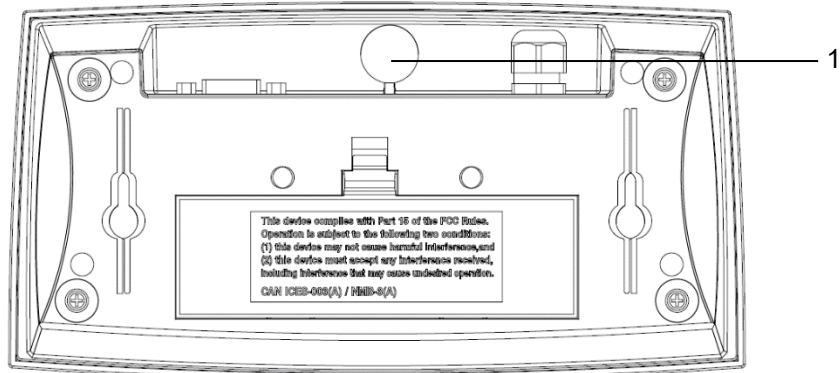

Figure 5-2 Courier 7000 Paper Sealing

Item	Description
1	Paper Sealing

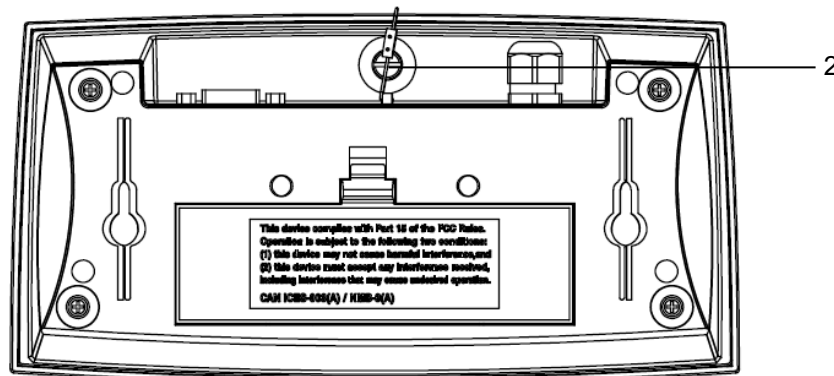
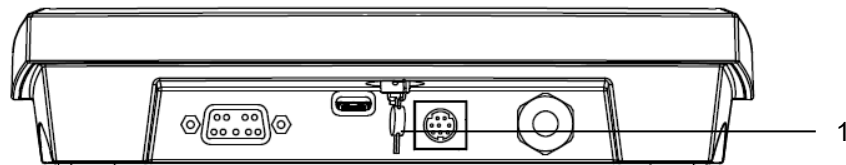

Figure 5-3 Courier 7000 Wire Sealing

Item	Description
1	Wire Seal
2	Seal Screw

6. COMMUNICATION

The Courier 7000 scale can be set up to be compatible with the certain third party shipping software.

6.1 UPS WorldShip / FedEx Software Compatibility

6.1.1 UPS WorldShip

The OHAUS UPS WorldShip Update Tool allows the UPS World software to recognize the scale. You can download the tool via this website: <http://dmx.ohaus.com/WorkArea/showcontent.aspx?id=4295011443>

1. Download the OHAUS UPS WorldShip Update Tool and decompress the installation package.
2. Double click the execution file, a window appears on the screen.
3. Click **Run** button.
4. Click **OK** button.

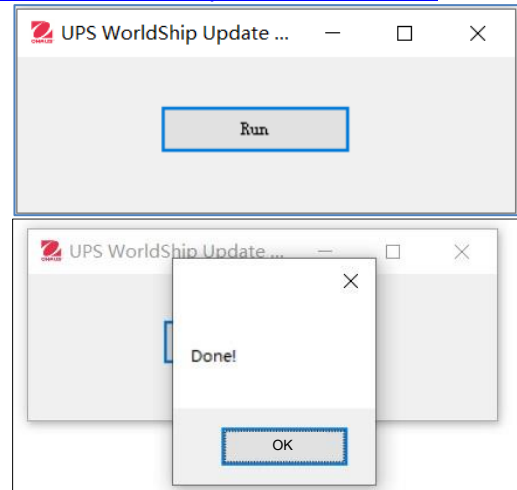

Shipping Software	Scale to PC connection	Protocol Settings	Terminal Settings
UPS WorldShip	USB HID	/	/

1. Click the **System Preferences** and select the **Hardware**.
2. Select the USB from the Scale port drop-down list.
3. Select the **OHAUS Courier 7000** from the Scale Type drop-down list.
4. Click the **Test Scale** button. A window for Test Active Scale will appear.
NOTE: As the test goes from start to end, you can see the information changes from Weight Processing to Weight Processed.
5. Click **OK** button to close the Test Active Scale window once weight is successfully processed.
NOTE: The weight on the scale and the weight in UPS WorldShip should be the same. In some cases, UPS WorldShip may round extra digits from the display weight. If the displayed weight and UPS WorldShip weights are very different, check that the scale and UPS WorldShip are using the same weighing unit (kg, lb or oz).
6. Click **Apply** button to save the selections.
7. Click **OK** button to close the **System Preferences Editor** window.
8. Select the Company or Name from the drop-down list. Courier 7000 is ready for UPS weight processing.

NOTE: UPS WorldShip software only processes the numeric weight value from the scale -- it does not autosense the weighing unit (kg, lb or oz) nor does it make a conversion from one weighing unit to another. Make sure the correct weighing unit is selected on the scale before weighing.

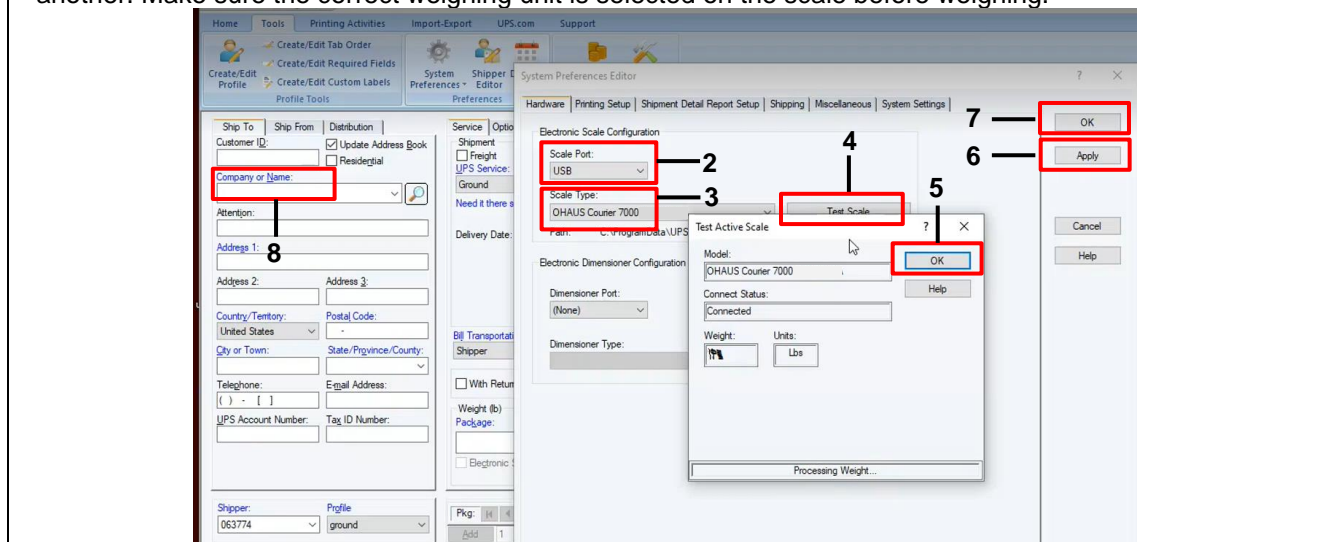

Shipping Software	Scale to PC connection	Protocol Settings	Terminal Settings
UPS WorldShip	USB CDC	3835	/
	RS232	3835	9600, 8, N, 1

1. Click the **System Preferences** and select the **Hardware**.
2. Select the corresponding COM port from the Scale port drop-down list.
NOTE: You can check the exact COM port from the Windows Device Manager without leaving the WorldShip software.
3. Select the **OHAUS Courier 7000** protocol from the Scale Type drop-down list.
4. Click the **Test Scale** button. A window for Test Active Scale will appear.
NOTE: As the test goes from start to end, you can see the information changes from Weight Processing to Weight Processed.
5. Click **OK** button to close the Test Active Scale window once weight is successfully processed.
NOTE: The weight on the scale and the weight in UPS WorldShip should be the same. In some cases, UPS WorldShip may round extra digits from the display weight. If the displayed weight and UPS WorldShip weights are very different, check that the scale and UPS WorldShip are using the same weighing unit (kg, lb or oz).
6. Click **Apply** button to save the selections.
7. Click **OK** button to close the **System Preferences Editor** window.
8. Select the Company or Name from the drop-down list. Courier 7000 is ready for UPS weight processing.

NOTE: UPS WorldShip software only processes the numeric weight value from the scale -- it does not autosense the weighing unit (kg, lb or oz) nor does it make a conversion from one weighing unit to another. Make sure the correct weighing unit is selected on the scale before weighing.

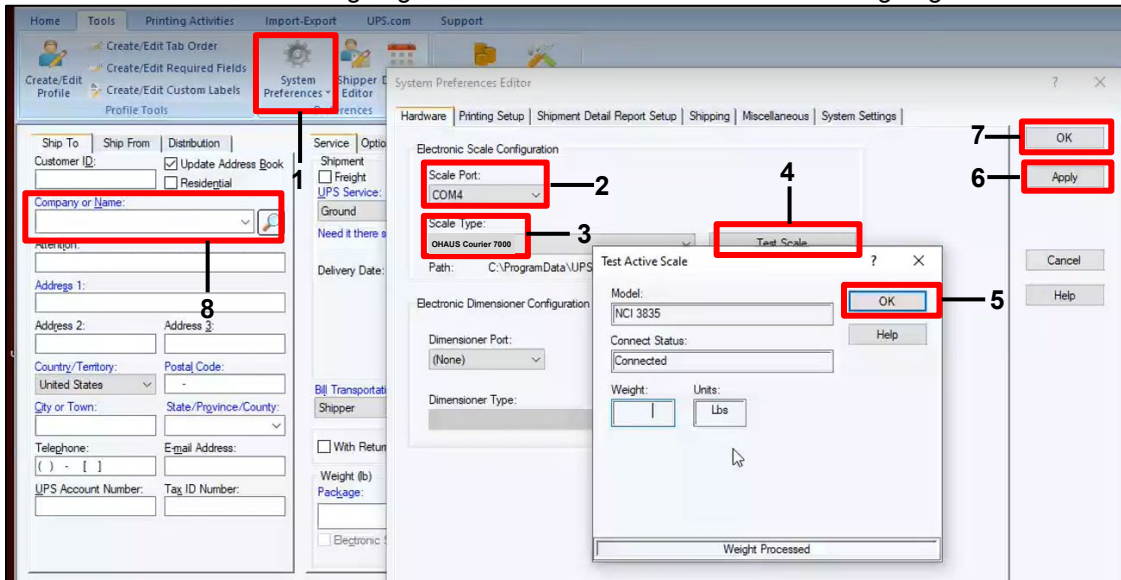

NOTE: Before you connect the scale to the PC, please install the OHAUS UPS WorldShip Update Tool.

6.1.2 FedEx

Shipping Software	Scale to PC connection	Protocol Settings	Terminal Settings
FedEx	USB HID	/	/

1. Install the **FedEx Ship Manager** software on the PC.
2. Start the **FedEx Ship Manager** software and go to **Utilities** to select **Configure Scale**. A window called configure scale appears on the screen.
3. Type into the **Vendor Id(0EB8)** and **Product Id(2407)**.
4. Click the **Test Scale** button. The correct weight and weight type appear on the right side.
5. Click **OK** button to close the **Configure Scale** window.

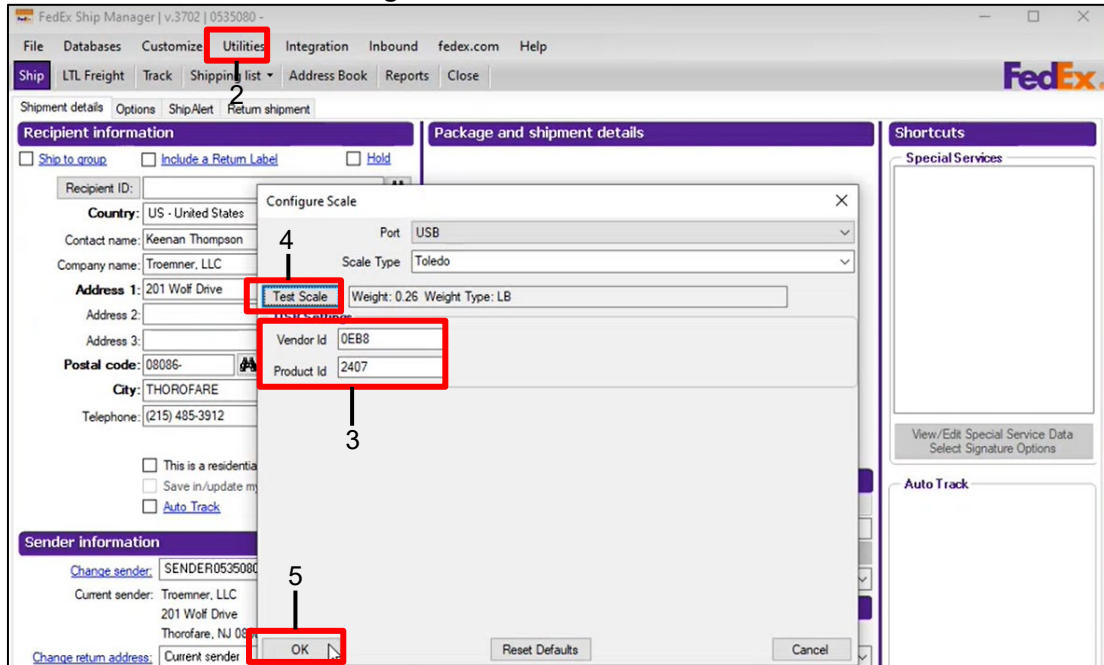

6. Put an object on the platform to read the value from the **FedEx Ship Manager** window.

NOTE:

- The weight value on the scale and the weight value in FedEx Ship Manager should be the same. FedEx Ship Manager does not round up extra digits from the display weight.
- FedEx Ship Manager software only processes the numeric weight value from the scale -- it can autosense the weighing unit (kg, lb or oz) from the scale.

Shipping Software	Scale to PC connection	Protocol Settings	Terminal Settings
FedEx	RS232	3835	Baud rate: 4800; Parity: Even; Data Bit: 7; Stop bit: 1 bit
	USB CDC		/

FedEx Ship Manager provides access only to COM ports 1-9 when using RS-232 to USB converter, assign the USB COM port through Device Manager to reflect as COM port 1-9 in advanced settings.

1. Install the **FedEx Ship Manager** tool on the PC.
2. Start the **FedEx Ship Manager** software and go to **Utilities** to select **Configure Scale**. A window called configure scale appears on the display.
3. Do the following settings:
 - Port drop-down list: The corresponding COM port.
 - Bits Per Second: 4800
 - Data Bits: 8
 - Parity: None
 - Stop Bits: 1
 - Protocol: Custom
 - Query String: W
 - Response Format: xxwwwwwttxxx
4. Click the **Test Scale** button.
5. Click **OK** button to close the **Configure Scale** window.

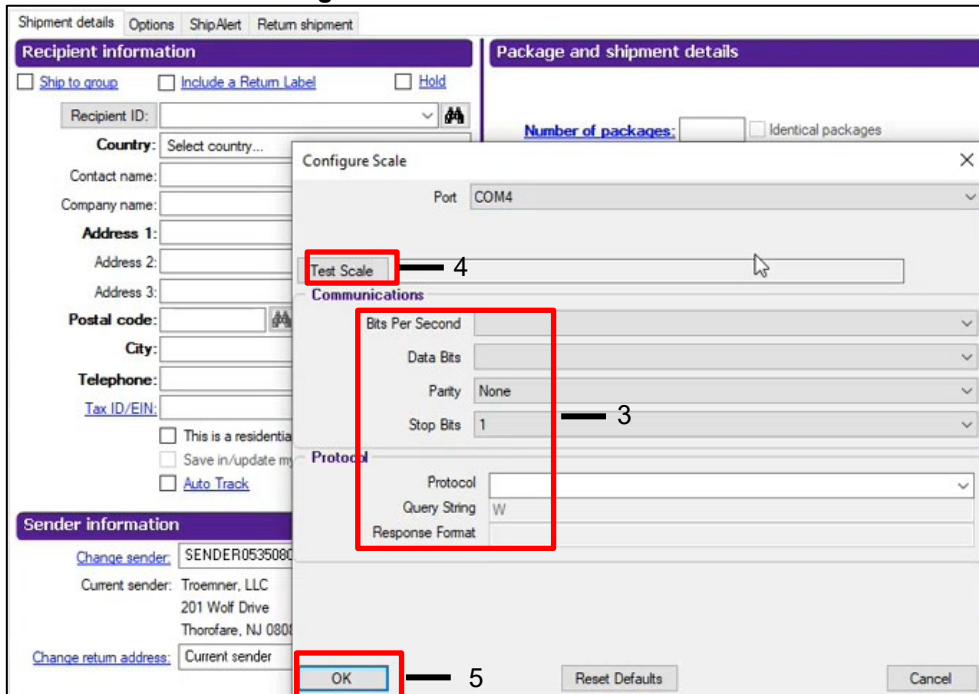

6. Put an object on the platform to read the value from the **FedEx Ship Manager** window.

NOTE:

- The weight value on the scale and the weight value in FedEx Ship Manager should be the same. FedEx Ship Manager does not round up extra digits from the display weight.
- FedEx Ship Manager software only processes the numeric weight value from the scale -- it can autosense the weighing unit (kg, lb or oz) from the scale.
- If the USB CDC is selected, you do not have to set the Bits Per Second, Data Bits, Parity and Stop Bits.

6.2 Scale to Device Port Connections

The Courier 7000 scale has a standard RS232 port and a USB type C port.

6.2.1 USB (Type C) Port

The USB allows two types of USB communication to be configured including HID and CDC (virtual serial connections).

6.2.1.1 USB HID

If you connect the scale to a PC by using the USB Type C and select HID type (**HID is the default setting**), the scale will be compatible with the shipping software (UPS WorldShip / FedEx) without any additional settings.

HIDPOS is a standard Microsoft Human Interface Device protocol for Point-of-Sale equipment which includes a scale. If the software on the PC is programmed for HIDPOS, the connection is “Plug and Play” and no additional drivers are needed. In this case, the scale operates as a USB peripheral to the PC.

After connecting the scale to a PC with the USB, turn on the scale and the PC. Check the device manager on the PC, where the Courier 7000 scale should be identified as a HID-compliant device:

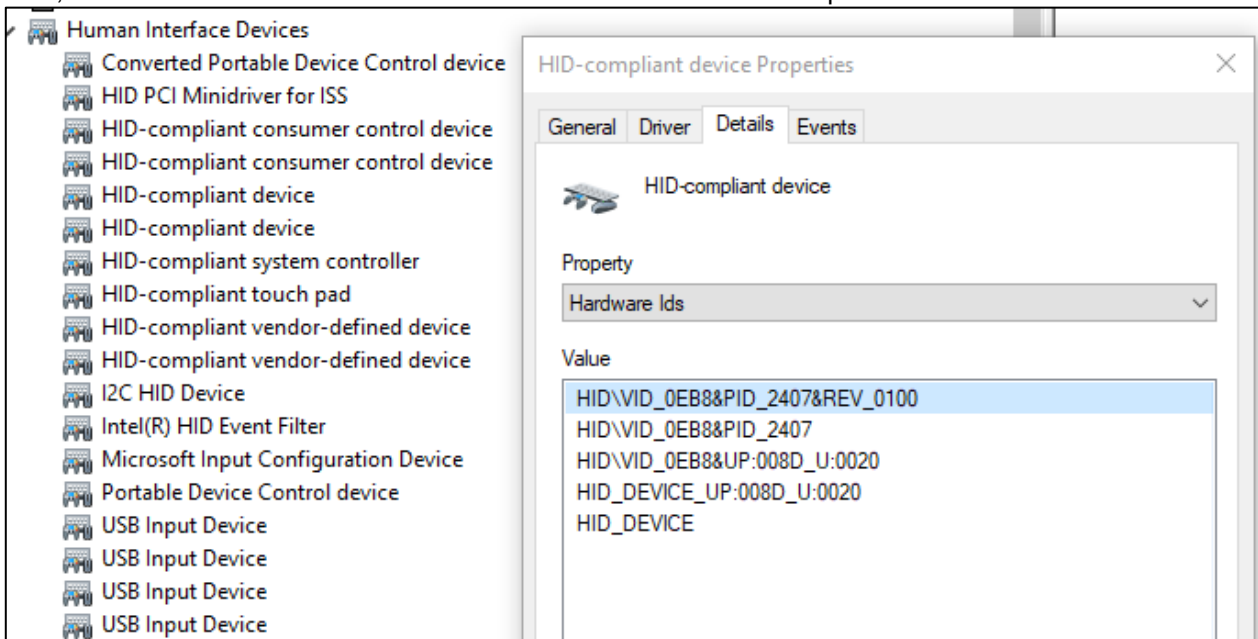

Once the HID-compliant device is found, the device is ready for use.

The USB specification should show:

- Vender ID= 0EB8
- Product ID= 2407

If you cannot find this device in the HID list, please double check your USB connection.

6.2.1.2 USB CDC

If you need to connect the host computer software via the virtual serial port, you may connect the scale to a PC by using the USB Type C cable and selecting the CDC type connection in the Courier 7000 software:

Steps

1. Long press the **Menu** button until **ꠄ.ꠄ.ꠄ** appears on the display.
2. Release the **Menu** button, and **ꠄ.ꠄ.ꠄ** appears on the display.
3. Short press the **No** button several times until **ꠄ.ꠄ.ꠄ** appears on the display.
4. Press the **Yes** button, and **ꠄ.ꠄ.ꠄ** appears on the display.
5. Short press the **No** button once, and **ꠄ.ꠄ.ꠄ** appears on the display.
6. Short press the **Yes** button to enter the sub menu.
7. Short press the **No** button several times until **ꠄ.ꠄ.ꠄ** appears on the display.
8. Short press the **Yes** button to confirm.

After selecting the CDC type in the Courier 7000 software, select the corresponding protocol to be compatible with the shipping software you are using:

Steps

1. Long press the **Menu** button until **ꠄ.ꠄ.ꠄ** appears on the display.
2. Release the **Menu** button, and **ꠄ.ꠄ.ꠄ** appears on the display.
3. Short press the **No** button several times until **ꠄ.ꠄ.ꠄ** appears on the display.

4. Press the **Yes** button, and **r.E.5.E.t** appears on the display.
5. Short press the **No** button once, and **ASS tgn** appears on the display.
6. Short press the **Yes** button to enter the sub menu.
7. Short press the **No** button several times until the wanted protocol (NCI/8213/3835/SCP01) appears on the display.
8. Short press the **Yes** button to confirm.

For example: UPS WorldShip / FedEx Ship Manager uses protocol 3835.

6.2.2 RS232 Port

The scale can be also set up to communicate via the RS232 port:

Steps

1. Long press the **Menu** button until **nn.E.n.u** appears on the display.
2. Release the **Menu** button, and **C.n.t** appears on the display.
3. Short press the **No** button several times until **P.r. n.t** appears on the display.
4. Press the **Yes** button and **r.E5E.t** appears on the display.
5. Short press the **No** button once, and **ASS tgn** appears on the display.
6. Short press the **Yes** button to enter the sub menu.
7. Short press the **No** button several times until the wanted protocol appears on the display.
8. Short press the **Yes** button to confirm.

NOTE: For example: UPS WorldShip / FEDEX -3835.

Courier 7000 RS232 Connection

You can connect the optional RS232 cable to the RS232 connector on the Courier 7000 terminal. Refer to figure 6-1, you can find the definition of each pin.

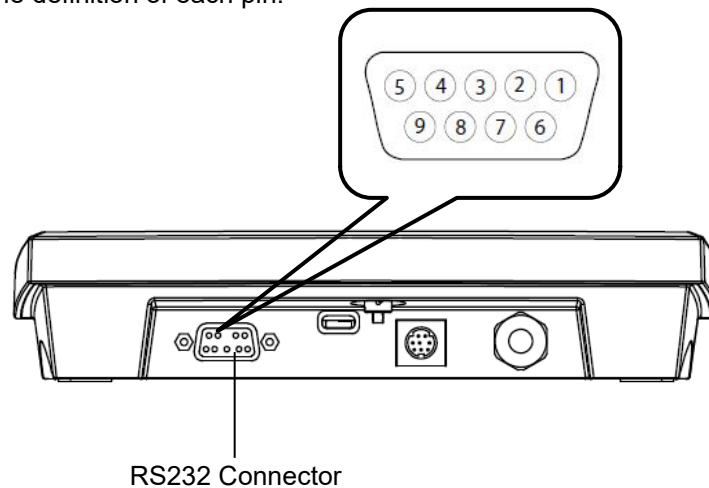

Figure 6-1 Courier 7000 RS232 Connector

Pin	Connection	Pin	Connection
1	N/C	6	N/C
2	TXD	7	N/C
3	RXD	8	N/C
4	N/C	9	N/C
5	GND		

6.2.3 Other Options (2nd RS232 or Ethernet or WiFi / Bluetooth or 2nd Display)

The scale can be set up to print and communicate with the other device via the 2nd RS232 or Ethernet or WiFi / Bluetooth.

Refer to **4.1.1 User Menu (In segments)**, you can find the setting of the wireless, the ethernet and the option RS232.

For more information, you can consult the accessory manuals.

6.3 Interface Protocols

If you connect the scale to a PC by using the USB CDC / RS232 / 2nd RS232 / Ethernet / WiFi - BT, please select the corresponding protocol to be compatible with the shipping software.

For example: UPS WorldShip / FedEx Ship Manager – 3835.

- NCI protocol
- 8213 protocol
- 3835 protocol
- NCI-SCP01 protocol

6.3.1 NCI Protocol

NCI Protocol																			
Request displayed weight																			
Command	W<CR>(57h,0dh)																		
over capacity (invalid data)	<LF>	^	^	^	^	^	^	^	^	<U>	<U>	<CR>	<LF>	<H1>	<H2>	<CR>	<ETX>		
under capacity (-20d)	<LF>	-	-	-	-	-	-	-	-	<U>	<U>	<CR>	<LF>	<H1>	<H2>	<CR>	<ETX>		
zero point error (Initial Zero)	<LF>	-	-	-	-	-	-	-	-	<U>	<U>	<CR>	<LF>	<H1>	<H2>	<CR>	<ETX>		
in lb/oz/kg/g (normal data)	<LF>	<p>	<W>	.	<W>	<W>	<W>	<W>	<U>	<U>	<CR>	<LF>	<H1>	<H2>	<CR>	<ETX>			
in lb/oz/kg/g	<LF>	<p>	<W>	<W>	.	<W>	<W>	<W>	<U>	<U>	<CR>	<LF>	<H1>	<H2>	<CR>	<ETX>			
in lb/oz/kg/g	<LF>	<p>	<W>	<W>	<W>	.	<W>	<W>	<U>	<U>	<CR>	<LF>	<H1>	<H2>	<CR>	<ETX>			
in lb/oz/kg/g	<LF>	<p>	<sp>	<W>	<W>	<W>	<W>	<W>	<U>	<U>	<CR>	<LF>	<H1>	<H2>	<CR>	<ETX>			
in lb:oz	<LF>	<p>	<W>		b	<sp>	<W>	<W>	.	<W>	<W>	o	z	<CR>	<LF>	<H1>	<H2>	<CR>	<ETX>
in lb:oz	<LF>	<p>	<W>	<W>		b	<sp>	<W>	<W>	.	<W>	o	z	<CR>	<LF>	<H1>	<H2>	<CR>	<ETX>
in lb:oz	<LF>	<p>	<sp>	<W>	<W>	<W>		b	<sp>	<W>	<W>	o	z	<CR>	<LF>	<H1>	<H2>	<CR>	<ETX>

Request High-Resolution weight (10x)																				
Command	H<CR>(48,0dh)																			
over capacity (invalid data)	<LF>	^	^	^	^	^	^	^	^	<U>	<U>	<CR>	<LF>	<H1>	<H2>	<CR>	<ETX>			
under capacity	<LF>	-	-	-	-	-	-	-	-	<U>	<U>	<CR>	<LF>	<H1>	<H2>	<CR>	<ETX>			
zero point error	<LF>	-	-	-	-	-	-	-	-	<U>	<U>	<CR>	<LF>	<H1>	<H2>	<CR>	<ETX>			
in lb/oz/kg/g (normal data)	<LF>	<p>	<W>	.	<W>	<W>	<W>	<W>	<U>	<U>	<CR>	<LF>	<H1>	<H2>	<CR>	<ETX>				
in lb/oz/kg/g	<LF>	<p>	<W>	<W>	.	<W>	<W>	<W>	<U>	<U>	<CR>	<LF>	<H1>	<H2>	<CR>	<ETX>				
in lb/oz/kg/g	<LF>	<p>	<W>	<W>	<W>	.	<W>	<W>	<U>	<U>	<CR>	<LF>	<H1>	<H2>	<CR>	<ETX>				
in lb/oz/kg/g	<LF>	<p>	<W>	<W>	<W>	.	<W>	<W>	<U>	<U>	<CR>	<LF>	<H1>	<H2>	<CR>	<ETX>				
in lb:oz	<LF>	<p>	<W>		b	<sp>	<W>	<W>	.	<W>	<W>	o	z	<CR>	<LF>	<H1>	<H2>	<CR>	<ETX>	
in lb:oz	<LF>	<p>	<W>	<W>		b	<sp>	<W>	<W>	.	<W>	o	z	<CR>	<LF>	<H1>	<H2>	<CR>	<ETX>	
in lb:oz	<LF>	<p>	<W>	<W>	<W>		b	<sp>	<W>	<W>	.	<W>	o	z	<CR>	<LF>	<H1>	<H2>	<CR>	<ETX>
in lb:oz	<LF>	<p>	<sp>	<W>	<W>	<W>		b	<sp>	<W>	<W>	o	z	<CR>	<LF>	<H1>	<H2>	<CR>	<ETX>	

Request current status					
Command: S<CR>(53h,0dh)					
Response	<LF>	<H1>	<H2>	<CR>	<ETX>

Request scale to zero					
Command: Z<CR>(5ah,0dh)					
simulate ZERO key	<LF>	<H1>	<H2>	<CR>	<ETX>

Request scale to tare					
Command: T<CR> (54h,0dh)					
simulate TARE key	<LF>	<H1>	<H2>	<CR>	<ETX>

Change units of measure												
Command: U<CR> (55h,0dh)												
simulate UNIT key (lb/kg)	<LF>	<U>	<U>	<CR>	<LF>	<H1>	<H2>	<CR>	<ETX>			
simulate UNIT key (lb:oz)	<LF>	l	b	:	o	z	<CR>	<LF>	<H1>	<H2>	<CR>	<ETX>

Power off the scale					
Command: X<CR> (58h,0dh)					
simulate OFF key	x	x	x	x	x

Unrecognized Command				
Command: others (xxh, 0dh)				
Response	<LF>	?	<CR>	<ETX>

Definition of the Symbols and the Bits

Symbols Used	<LF>	line feed (0Ah)
	<CR>	carriage return (0Dh)
	<ETX>	end of text (03h)
	<sp>	space (20h)
	<p>	polarity "-" or "+" (2Dh or 20h)
	<U><U>	measure units "lb", "oz", "kg", "g"
	<W><W><W><W><W>	weight data 5~6 Bytes
<H1><H2>	current status	

Bit definition <H1-H2>	Bit	Byte 1 (H1)	Byte 2 (H2)
	0	0=stable 1=no stable	0=not under capacity 1=under capacity
	1	0=not at zero point 1= at zero point	0=not over capacity 1=over capacity
	2	0=RAM ok 1=RAM error	0=Flash ROM ok 1= Flash ROM error
	3	0=eeprom ok 1=eeprom error	0=calibration ok 1= calibration error
	4	always 1	always 1
	5	always 1	always 1
	6	always 0	always 0
7	parity	parity	

6.3.2 8213 Interface Protocol

8213 Protocol										
Request displayed weight										
Command: W (57h)										
over capacity (invalid data)	<STX>	?	<S>	<CR>						
under capacity (-20d)	<STX>	?	<S>	<CR>						
under zero (Mulis)	<STX>	?	<S>	<CR>						
not stable	<STX>	?	<S>	<CR>						
in lb/oz/kg/g (normal data)	<STX>	<W>	.	<W>	<W>	<W>	<W>	<U>	<U>	<CR>
in lb/oz/kg/g	<STX>	<W>	<W>	.	<W>	<W>	<W>	<U>	<U>	<CR>

in lb/oz/kg/g	<STX>	<W>	<W>	<W>	.	<W>	<W>	<U>	<U>	<CR>		
in lb/oz/kg/g	<STX>	<W>	<W>	<W>	<W>	.	<W>	<U>	<U>	<CR>		
in lb/oz/kg/g	<STX>	<sp>	<W>	<W>	<W>	<W>	<W>	<U>	<U>	<CR>		
in lb:oz	<STX>	<W>	l	b	<W>	<W>	.	<W>	<W>	o	z	<CR>
in lb:oz	<STX>	<W>	<W>	l	b	<W>	<W>	.	<W>	o	z	<CR>
in lb:oz	<STX>	<sp>	<W>	<W>	<W>	l	b	<W>	<W>	o	z	<CR>
Request High-Resolution Weight (10 x)												
Command: H (48h)												
over capacity (invalid data)	<STX>	?	<S>	<CR>								
under capacity (-20d)	<STX>	?	<S>	<CR>								
under zero (Mulis)	<STX>	?	<S>	<CR>								
not stable	<STX>	?	<S>	<CR>								
in lb/oz/kg/g (normal data)	<STX>	<W>	.	<W>	<W>	<W>	<W>	<W>	<U>	<U>	<CR>	
in lb/oz/kg/g	<STX>	<W>	<W>	.	<W>	<W>	<W>	<W>	<U>	<U>	<CR>	
in lb/oz/kg/g	<STX>	<W>	<W>	<W>	.	<W>	<W>	<W>	<U>	<U>	<CR>	
in lb/oz/kg/g	<STX>	<W>	<W>	<W>	<W>	.	<W>	<W>	<U>	<U>	<CR>	
in lb/oz/kg/g	<STX>	<W>	<W>	<W>	<W>	<W>	.	<W>	<U>	<U>	<CR>	
in lb:oz	<STX>	<W>	l	b	<W>	<W>	.	<W>	<W>	<W>	o	z <CR>
in lb:oz	<STX>	<W>	<W>	l	b	<W>	<W>	.	<W>	<W>	o	z <CR>
in lb:oz	<STX>	<W>	<W>	<W>	l	b	<W>	<W>	.	<W>	o	z <CR>
in lb:oz	<STX>	<sp>	<W>	<W>	<W>	<W>	l	b	<W>	<W>	o	z <CR>

Request scale to zero			
Command: Z (5ah)			
simulate ZERO key	<STX>	?	<S> <CR>

Scale is placed in echo mode			
Command: E (45h)			
echo mode enable	<STX>	E	<CR>

Scale is taken out of echo mode			
Command: F (46h)			
echo mode disable	<STX>	F	<CR>

Scale initiates a test of RAM and ROM			
Command: A (41h)			
RAM/ROM TEST	<STX>	?	<CR>

Scale confidence test result status			
Command: B (42h)			
Test result (Command A)	<STX>	<C>	<CR>

Bit Definition	Bit	Confidence <C>
	0	always 0
	1	always 0
	2	always 0
	3	0=RAM ok 1=RAM error
	4	0=Flash ROM ok 1=Flash ROM error
	5	always 0
	6	always 0
7	parity	

Unrecognized Command				
Command: others				
Response	<STX>	?	<S>	<CR>

Definition of the Symbols and the Bits

Symbols Used	<STX>	start of test (02h)
	<CR>	carriage return (0Dh)
	<sp>	space (20h)
	<U><U>	measure units "lb", "oz", "kg", "g"
	<W><W><W><W><W>	weight data 5~6 Bytes

Bit Definition	Bit	Status <S>
	0	0=stable 1=no stable
	1	0=not cover capacity 1= cover capacity
	2	0=not under zero 1= under zero
	3	0=initial zero inside 1=initial zero outside
	4	0=not center of zero 1=center of zero
	5	always 1
	6	always 1
7	parity	

6.3.3 3835 Protocol

3835 Protocol																		
Request displayed weight																		
Command: W <CR>(57h, 0dh)																		
over capacity (invalid data)	<LF>	^	^	^	^	^	^	^	^	<U>	<U>	<CR>	<H1>	<H2>	<ETX>			
under capacity (-20d)	<LF>	_	_	_	_	_	_	_	_	<U>	<U>	<CR>	<H1>	<H2>	<ETX>			
in lb/oz/kg/g (normal data)	<LF>	<p>	<W>	.	<W>	<W>	<W>	<W>	<U>	<U>	<CR>	<H1>	<H2>	<ETX>				
in lb/oz/kg/g	<LF>	<p>	<W>	<W>	.	<W>	<W>	<W>	<U>	<U>	<CR>	<H1>	<H2>	<ETX>				
in lb/oz/kg/g	<LF>	<p>	<W>	<W>	<W>	.	<W>	<W>	<U>	<U>	<CR>	<H1>	<H2>	<ETX>				
in lb/oz/kg/g	<LF>	<p>	<sp>	<W>	<W>	<W>	<W>	<W>	<U>	<U>	<CR>	<H1>	<H2>	<ETX>				
in lb:oz	<LF>	<p>	<W>	l	b	<sp>	<W>	<W>	.	<W>	<W>	o	z	<CR>	<H1>	<H2>	<ETX>	
in lb:oz	<LF>	<p>	<W>	<W>	l	b	<sp>	<W>	<W>	.	<W>	o	z	<CR>	<H1>	<H2>	<ETX>	
in lb:oz	<LF>	<p>	<sp>	<W>	<W>	<W>	<W>	l	b	<sp>	<W>	<W>	o	z	<CR>	<H1>	<H2>	<ETX>
Initial Zero Error	<LF>	<H1>	<H2>	<CR>	<ETX>													

Request current status					
Command: S <CR> (53h, 0dh)					
Response	<LF>	<H1>	<H2>	<CR>	<ETX>

Request scale to zero	
Command: Z <CR> (5ah, 0dh)	
Response	Scale is zeroed, no response from scale

Unrecognized Command			
Command: others			
Response	<LF>	?	<CR>

Definition of the Symbols and the Bits

Symbols Used	<LF>	line feed (0Ah)
	<CR>	carriage return (0Dh)
	<ETX>	end of text (03h)
	<sp>	space (20h)
	<p>	polarity "-" or "+" (2Dh or 20h)
	<U><U>	measure units "lb", "oz", "kg", "g"
	<W><W><W><W><W><W>	weight data 6 Bytes
	<H1><H2>	current status

Bit definition <H1 H2>	Bit	Byte 1 (H1)	Byte 2 (H2)
	0	0=stable 1=not stable	0=not under capacity 1=under capacity
	1	0=not at zero point 1= at zero point	0=not over capacity 1=over capacity
	2	0=RAM ok 1=RAM error	0=Flash ROM ok 1= Flash ROM error
	3	0=eeprom ok 1=eeprom error	0=calibration ok 1= calibration error
	4	always 1	always 1
	5	always 1	always 1
	6	always 0	always 0
7	parity	parity	

6.3.4 NCI-SCP01 Protocol

Command: W<CR> (57h 0dh), request current reading

Response
<LF>^^^^^^^U ₁ U ₂ U ₃ U ₄ U ₅ <CR><LF>H ₁ H ₂ H ₃ H ₄ <CR><ETX>---over capacity
<LF>_____U ₁ U ₂ U ₃ U ₄ U ₅ <CR><LF>H ₁ H ₂ H ₃ H ₄ <CR><ETX>---under capacity
<LF>-----U ₁ U ₂ U ₃ U ₄ U ₅ <CR><LF> H ₁ H ₂ H ₃ H ₄ <CR><ETX>---zero-point error
Note: U ₁ U ₂ U ₃ U ₄ U ₅ is 1,2,3 or 5 bytes according to current unit: kg, lb, pcs, g, oz, lb:oz
<LF><P>W ₁ W ₂ W ₃ W ₄ W ₅ <DP>W ₆ U ₁ U ₂ U ₃ U ₄ U ₅ <CR><LF> H ₁ H ₂ H ₃ H ₄ <CR><ETX>---normal data
Note: (1) The decimal point position is determined by CONFIG-PRIM.D (2) If current unit is "lb:oz", the format will be similar with following:
<LF><P>W ₁ W ₂ W ₃ lb <SP> W ₄ W ₅ <DP> W ₆ oz<CR><LF> H ₁ H ₂ H ₃ H ₄ <CR><ETX>

Command: S<CR> (53h 0dh), request current status

Response
<LF>H ₁ H ₂ H ₃ H ₄ <CR><ETX>

Command: Z<CR> (5ah 0dh)

Response
Zero function is activated (simulate ZERO key), and it returns to current scale status.
<LF>H ₁ H ₂ H ₃ H ₄ <CR><ETX>

If ZERO function cannot be activated, it will return to current scale status.

Command: T<CR> (54h 0dh)

Response
TARE function is activated (simulate TARE key), and then returns scale status.
<LF>H ₁ H ₂ H ₃ H ₄ <CR><ETX>

If TARE function cannot be activated, it will return to current scale status.

Command: U<CR> (55h 0dh)

Response
Changes units of measure (simulate UNIT key) and return scale status with new units. The new measure unit should be allowed to use
<LF>U ₁ U ₂ U ₃ U ₄ U ₅ <CR><LF>H ₁ H ₂ H ₃ H ₄ <CR><ETX>

Command: L<CR> (4ch 0dh)

Response
If Hold function can be activated, it will enable/disable hold function (simulate HOLD key) and returns scale status.
<LF>H ₁ H ₂ H ₃ H ₄ <CR><ETX>

Command: X<CR> (58h 0dh)

Response
Power off the scale. Same as pressing the ON/OFF key to turn off the scale.

Command: all others

Response
Unrecognized command
<LF>?<CR><ETX>

Transaction String

The length of each item in a transition string.

- Reading data--6 bytes
- Data polarity---1 byte: “-“ for negative, and followed the first digit, “ ” for positive.
- Decimal point--1 byte: “.”
- Measure unit---1-5 bytes: “lb”, “kg”, “lb:oz”, “pcs”, “%”. Units are always lower case, left aligned.
- Current status--4 bytes
 - If the weight is over capacity, the scale will return eight “^” characters (the field of polarity, decimal point, weight data is filled by “^”).
 - If the weight is under capacity, it will return eight “_” characters (the field of polarity, decimal point, weight data is filled by “_”).
 - If the zero point is error, it will return eight “-” characters (the field of polarity, decimal point, and weight data is filled by “-”).

Useless leading 0 before digits is suppressed. Reading weight is right aligned.

Table 6-1 Symbols Used

<LF>	Line Feed character (hex 0AH)
<CR>	Carriage Return character (hex 0DH)
<ETX>	End of Text character (hex 03H)
<SP>	Space (hex 20H)
H ₁ H ₂ H ₃ H ₄	Four current status bytes
<P>	Polarity character: “-” or “ ”
W ₁ ...W ₆	Reading data, 1-6 bytes (six digits)
<DP>	Decimal point
U ₁ U ₂ U ₃ U ₄ U ₅	Measure units, kg, lb, lb:oz, % or pcs; 2-5 bytes
<Add>	Address of scale; 2 bytes (00-99)
<Prompt>	Prompt characters of output content; max. 11 bytes

Table 6-2 Bit Definition of H₁H₂H₃H₄

Bit	Byte 1 (H ₁)	Byte 2 (H ₂)	Byte 3 (H ₃)	Byte 4 (H ₄)
0	0= stable	0= not under capacity	00= compare disable 01= lower limit	00= normal weighing 01= count weighing
	1= not stable	1= under capacity		
1	0= not at zero point	0= not over capacity	10= ok 11= upper limit	10= percent weighing 11= other mode
	1= at zero point	1= over capacity		
2	0= RAM ok	0= ROM ok	0= gross weight 1= net weight	0= not in HOLD 1= in HOLD
	1= RAM error	1= ROM error		
3	0= eeprom OK	0= calibration ok	0= initial zero ok 1= initial zero error	0= battery ok 1= low battery
	1= eeprom error	1= calibration error		
4	always 1	always 1	always 1	always 1
5	always 1	always 1	always 1	always 1
6	always 0	always 1	always 1	always 0
7	parity	parity	parity	parity

7. MAINTENANCE

7.1 Cleaning

For Courier 7000, the housing may be cleaned with a cloth dampened with a mild detergent if necessary.

CAUTION: DISCONNECT THE UNIT FROM THE POWER SUPPLY BEFORE CLEANING.



WARNING: Electric Shock Hazard. Disconnect the equipment from the power supply before cleaning. Make sure that no liquid enters the interior of the instrument.



Attention: Do not use solvents, harsh chemicals, ammonia or abrasive cleaning agents.

7.2 Troubleshooting

Table 7-1 Troubleshooting





SYMPTOM	PROBABLE CAUSE (s)	REMEDY
EEP Error	EEPROM Checksum Error	Corrupted EEPROM data
Unable to turn on the scale.	<ol style="list-style-type: none"> 1. USB cable not plugged in or properly connected with PC. 2. Power cord not plugged in or properly connected. 3. Power outlet not supplying power. 4. Batteries out of power. 5. Other failure. 	<ol style="list-style-type: none"> 1. Check USB cable connections. Make sure USB cable is plugged in properly. 2. Check power cord connections. Make sure power cord is plugged in properly into the power outlet. 3. Check power source. 4. Change batteries. 5. Service required.
Cannot zero the scale, or will not zero when turned on.	<ol style="list-style-type: none"> 1. Weights on the platform exceeds allowable limits. 2. Weight is not stable. 3. Load cell is damaged. 	<ol style="list-style-type: none"> 1. Remove weights on the platform. 2. Wait for weight to become stable, check area around the scale and weight on scale for excessive vibration or movement, or increase filtering. 3. Service required.
Unable to calibrate.	LFT security switch is turned on.	Turn the LFT security switch off.
Cannot display weight in desired weighing unit.	Unit is disabled.	Enable unit in the Units Menu. Refer to 4.5 Unit Menu for help.
Cannot change menu settings.	The Menu button has been locked.	<ol style="list-style-type: none"> 1. Hold Menu key for up to 30 seconds to access menu. Can be permanently unlocked using Lock menu. 2. The LFT security switch may need to be switched off.
Error 8.1	Weight reading exceeds Power On Zero limit.	<ol style="list-style-type: none"> 1. Remove weight from the platform. 2. Recalibrate the scale.
Error 8.2	Weight reading below Power On Zero limit.	<ol style="list-style-type: none"> 1. Add weight to the platform. 2. Recalibrate the scale (The Span Calibration and Linearity Calibration require calibration masses).
Error 8.3	Weight reading exceeds Overload limit.	Reduce load on the scale.
Error 8.4	Weight reading below Underload limit.	<ol style="list-style-type: none"> 1. Add weight to the platform. 2. Recalibrate the scale.
Error 8.5	Weight value exceeds 6 digits	Reduce load on scale.
Error 9.5	Calibration data is missing.	Calibrate the scale.
Battery symbol flashing	Low battery	Replace batteries.
ERR E	Calibration failure	Use correct calibration weight.



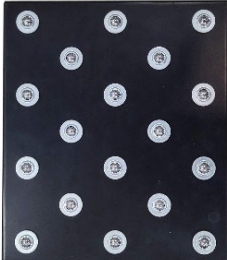

NOTE: Refer to 5.1 Settings, you can find the position of the LFT security switch.

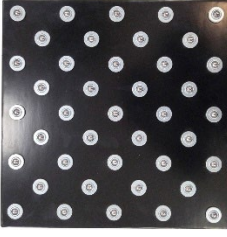
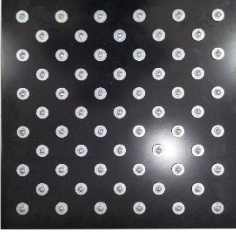
7.3 Service Information

If the troubleshooting section does not resolve your problem, you can contact an authorized OHAUS Service Agent. For Service assistance in the United States, call toll-free 1-800-526-0659 between 8:00 AM and 5:00 PM Eastern Standard Time. An OHAUS Product Service Specialist will be available to assist you. Outside the USA, please visit our website www.ohaus.com to locate the OHAUS office nearest you.

8. ACCESSORY

Item	Description	Picture
1	Platform i-C71 Balltop for R base	 <p>A black square platform with a grid of 16 silver ball-tops arranged in a 4x4 pattern.</p>
2	Platform i-C71 Rollertop for R base	 <p>A black square platform with four horizontal silver rollers.</p>
3	Platform i-C71 Balltop for X base	 <p>A black square platform with a grid of 25 silver ball-tops arranged in a 5x5 pattern.</p>
4	Platform i-C71 Balltop for L base	 <p>A black square platform with a grid of 36 silver ball-tops arranged in a 6x6 pattern.</p>
5	Platform i-C71 Rollertop for L base	 <p>A black square platform with four horizontal silver rollers.</p>
6	Platform i-C71 Rollertop for X base	 <p>A black square platform with eight vertical silver rollers.</p>

7	Column Kit i-C71 CS	
8	RS232 Interface Kit	
9	Wi-Fi / Bluetooth Kit i-C71	
10	Ethernet Interface i-C71	
11	Auxiliary display i-C71	
12	SF40 Printer	/
13	Cable RS232 IBM 9P Male-to-Female	/

9. TECHNICAL DATA

9.1 Specifications

Equipment Ratings:

Indoor use only

Altitude: 2,000m/6,562ft

Operating temperature: -10°C to 40°C (14°F to 104°F)

Humidity: Maximum relative humidity 80% for temperatures up to 31°C (87.8°F) decreasing linearly to 50% relative humidity at 40°C (104°F).

Electrical supply: 5VDC, 1A. (For use with certified or approved power supply, which must have a SELV and limited energy output.)
or 4 x AA (LR6) Batteries.

Voltage fluctuations: Mains supply voltage fluctuations up to $\pm 10\%$ of the nominal voltage.

Overvoltage category II

(Installation category):

Pollution degree: 2

Table 9-1 AM Models Specification

Model	i-C71M15R	i-C71M75R	i-C71M50L	i-C71M125L	i-C71M125X
Capacity x Default Readability Non-approved	15 kg x 0.005 kg 15,000 g x 5 g 30 lb x 0.01 lb 480 oz x 0.2 oz 30 lb x 0.2 oz	75 kg x 0.02 kg 75,000 g x 20 g 150 lb x 0.05 lb 2,400 oz x 1 oz 150 lb x 1 oz	50 kg x 0.01 kg 50,000 g x 10 g 100 lb x 0.02 lb 1,600 oz x 0.5 oz 100 lb x 0.5 oz	125 kg x 0.02 kg 125,000 g x 20 g 250 lb x 0.05 lb 4,000 oz x 1 oz 250 lb x 1 oz	125 kg x 0.02 kg 125,000 g x 20 g 250 lb x 0.05 lb 4,000 oz x 1 oz 250 lb x 1 oz
Maximum Displayed Resolution Non-approved	1:3,000	1:3,750	1:5,000	1:6,250	1:6,250
Capacity x Approved Readability	15 kg x 0.005 kg 15,000 g x 5 g 30 lb x 0.01 lb 480 oz x 0.2 oz	75 kg x 0.05 kg 75,000 g x 50 g 150 lb x 0.05 lb 2,400 oz x 1 oz	50 kg x 0.01 kg 50,000 g x 10 g 100 lb x 0.02 lb 1,600 oz x 0.5 oz	125 kg x 0.05 kg 125,000 g x 50 g 250 lb x 0.05 lb 4,000 oz x 1 oz	125 kg x 0.05 kg 125,000 g x 50 g 250 lb x 0.05 lb 4,000 oz x 1 oz
NTEP & Measurement Canada Approved Resolution	1:3,000	1:3,000	1:5,000	1:5,000	1:5,000
Weighing Units	g, kg, lb, oz, lb:oz				
Interface	Standard: USB Type-C, RS232, Mini DIN				
	Optional: 2 nd RS232, Ethernet, Wi-Fi/Bluetooth				
Application Mode	Weighing, Weight Alert, Dynamic Weighing / Display Hold, Totalization				
Operating Temperature Range	14°F to 104°F / -10°C to 40°C				
Keyboard	4 functions				
Display	28 mm / 1.1 in digit height LCD display with white backlit				
Stabilization Time	1 second				
Auto-zero Tracking	Off, 0.5 d, 1 d or 3 d				
Zeroing Range	2% or 100% of capacity				
Power	Dry cell battery: 4 x AA (LR6) Batteries or AC Power adapter: 100-240VAC ~ 0.5A 50/60Hz; Power output: 5.0 VDC 1.0 A or USB cable (USB connection to PC)				
Battery Life	70 hours continuous use with backlight off				
Safe Overload Capacity	150% of capacity				
Platform Dimensions	305 x 355 mm / 12.0 x 14.0 in		457 x 457 mm / 18.0 x 18.0 in		610 x 610 mm / 24.0 x 24.0 in
Base Construction	Stainless Steel platform with carbon steel frame and rubber leveling feet				
Net Weight	8 kg / 17.6 lb		14 kg / 28.6 lb		32 kg / 71.5 lb
Shipping Weight	10 kg / 22.5 lb		18 kg / 39.6 lb		37 kg / 81.4 lb
Shipping Dimensions	642 x 497 x 212 mm / 25.3 x 19.6 x 8.3 in		994 x 680 x 235 mm / 39.1 x 26.8 x 9.3 in		1,165 x 780 x 235 mm / 45.9 x 30.7 x 9.3 in

Table 9-2 Other Models Specification

Model	i-C71M15R	i-C71M60R	i-C71M60L	i-C71M150L	i-C71M150X
Capacity × Readability Non-approved	15 kg x 0.002 kg 15,000 g x 2 g	60 kg x 0.01 kg 60,000 g x 10 g	60 kg x 0.01 kg 60,000 g x 10 g	150 kg x 0.02 kg 15,000 g x 20 g	150 kg x 0.02 kg 15,000 g x 20 g
Maximum Displayed Resolution	1:7,500	1:6,000	1:6,000	1:7,500	1:7,500
Capacity × Approved Readability	15 kg x 0.005 kg 15,000 g x 5 g	60 kg x 0.02 kg 60,000 g x 20 g	60 kg x 0.02 kg 60,000 g x 20 g	150 kg x 0.05 kg 15,000 g x 50 g	150 kg x 0.05 kg 15,000 g x 50 g
OIML/EC type Approved Resolution	1:3,000	1:3,000	1:3,000	1:3,000	1:3,000
Weighing Units	g, kg, lb, oz, lb:oz				
Interface	Standard: USB Type-C, RS232, Mini DIN				
	Optional: 2 nd RS232, Ethernet, Wi-Fi/Bluetooth				
Application Mode	Weighing, Weight Alert, Dynamic Weighing / Display Hold, Totalization				
Operating Temperature Range	14°F to 104°F / -10°C to 40°C				
Keyboard	4 functions				
Display	28 mm digit height LCD display with cold white backlit				
Stabilization Time	1 second				
Auto-zero Tracking	Off, 0.5 d, 1 d or 3 d				
Zeroing Range	2% or 100% of capacity				
Power	Dry cell battery: 4 x AA (LR6) Batteries or AC Power adapter: 100-240VAC ~ 0.5A 50/60Hz; Power output: 5.0 VDC 1.0 A or USB cable (USB connection to PC)				
Battery Life	70 hours continuous use with backlight off				
Safe Overload Capacity	150% of capacity				
Platform Dimensions	305 x 355 mm		457 x 457 mm		610 x 610 mm
Base Construction	Stainless Steel platform with carbon steel frame and rubber leveling feet				
Net Weight	8 kg		14 kg		32 kg
Shipping Weight	10 kg		18 kg		37 kg
Shipping Dimensions	642 x 497 x 212 mm		994 x 680 x 235 mm		1,165 x 780 x 235 mm

9.2 Drawings and Dimensions

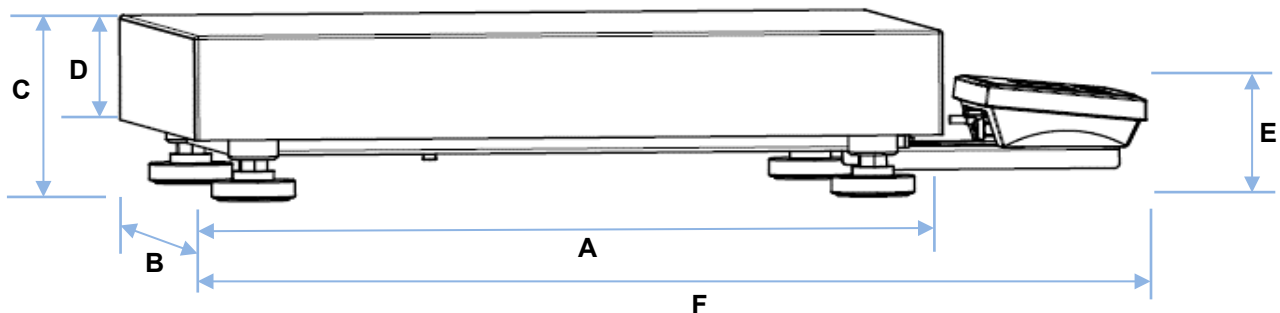

Table 9-3 Dimensions of All Models

No.	Model	Platform Size (mm/inch)	Dimension (mm/inch)					
			A	B	C	D	E	F
1	i-C71M15R	305 x 355/12.0 x 14.0"	305/12.0"	355/14.0"	121.8/4.8"	75/3.0"	73/2.9"	457.8/18.0"
2	i-C71M60R		305/12.0"	355/14.0"	121.8/4.8"	75/3.0"	73/2.9"	457.8/18.0"
3	i-C71M60L	457 x 457/18.0 x 18.0"	457/18.0"	457/18.0"	111.5/4.4"	70/2.8"	71/2.8"	597.8/23.5"
4	i-C71M150L		457/18.0"	457/18.0"	111.5/4.4"	70/2.8"	71/2.8"	597.8/23.5"
5	i-C71M150X	610 x 610/24.0 x 24.0"	610/24.0"	610/24.0"	132.3/5.2"	90/3.5"	70.2/2.8"	743.8/29.3"





9.3 Table of GEO Code Values

Table 9-4 GEO Codes

		Elevation in meters										
		0	325	650	975	1300	1625	1950	2275	2600	2925	3250
		325	650	975	1300	1625	1950	2275	2600	2925	3250	3575
		Elevation in feet										
		0	1060	2130	3200	4260	5330	6400	7460	8530	9600	10660
		1060	2130	3200	4260	5330	6400	7460	8530	9600	10660	11730
Latitude		GEO value										
0°00'	5°46'	5	4	4	3	3	2	2	1	1	0	0
5°46'	9°52'	5	5	4	4	3	3	2	2	1	1	0
9°52'	12°44'	6	5	5	4	4	3	3	2	2	1	1
12°44'	15°06'	6	6	5	5	4	4	3	3	2	2	1
15°06'	17°10'	7	6	6	5	5	4	4	3	3	2	2
17°10'	19°02'	7	7	6	6	5	5	4	4	3	3	2
19°02'	20°45'	8	7	7	6	6	5	5	4	4	3	3
20°45'	22°22'	8	8	7	7	6	6	5	5	4	4	3
22°22'	23°54'	9	8	8	7	7	6	6	5	5	4	4
23°54'	25°21'	9	9	8	8	7	7	6	6	5	5	4
25°21'	26°45'	10	9	9	8	8	7	7	6	6	5	5
26°45'	28°06'	10	10	9	9	8	8	7	7	6	6	5
28°06'	29°25'	11	10	10	9	9	8	8	7	7	6	6
29°25'	30°41'	11	11	10	10	9	9	8	8	7	7	6
30°41'	31°56'	12	11	11	10	10	9	9	8	8	7	7
31°56'	33°09'	12	12	11	11	10	10	9	9	8	8	7
33°09'	34°21'	13	12	12	11	11	10	10	9	9	8	8
34°21'	35°31'	13	13	12	12	11	11	10	10	9	9	8
35°31'	36°41'	14	13	13	12	12	11	11	10	10	9	9
36°41'	37°50'	14	14	13	13	12	12	11	11	10	10	9
37°50'	38°58'	15	14	14	13	13	12	12	11	11	10	10
38°58'	40°05'	15	15	14	14	13	13	12	12	11	11	10
40°05'	41°12'	16	15	15	14	14	13	13	12	12	11	11
41°12'	42°19'	16	16	15	15	14	14	13	13	12	12	11
42°19'	43°26'	17	16	16	15	15	14	14	13	13	12	12
43°26'	44°32'	17	17	16	16	15	15	14	14	13	13	12
44°32'	45°38'	18	17	17	16	16	15	15	14	14	13	13
45°38'	46°45'	18	18	17	17	16	16	15	15	14	14	13
46°45'	47°51'	19	18	18	17	17	16	16	15	15	14	14
47°51'	48°58'	19	19	18	18	17	17	16	16	15	15	14
48°58'	50°06'	20	19	19	18	18	17	17	16	16	15	15
50°06'	51°13'	20	20	19	19	18	18	17	17	16	16	15
51°13'	52°22'	21	20	20	19	19	18	18	17	17	16	16
52°22'	53°31'	21	21	20	20	19	19	18	18	17	17	16
53°31'	54°41'	22	21	21	20	20	19	19	18	18	17	17
54°41'	55°52'	22	22	21	21	20	20	19	19	18	18	17
55°52'	57°04'	23	22	22	21	21	20	20	19	19	18	18
57°04'	58°17'	23	23	22	22	21	21	20	20	19	19	18
58°17'	59°32'	24	23	23	22	22	21	21	20	20	19	19
59°32'	60°49'	24	24	23	23	22	22	21	21	20	20	19
60°49'	62°90'	25	24	24	23	23	22	22	21	21	20	20
62°90'	63°30'	25	25	24	24	23	23	22	22	21	21	20
63°30'	64°55'	26	25	25	24	24	23	23	22	22	21	21
64°55'	66°24'	26	26	25	25	24	24	23	23	22	22	21
66°24'	67°57'	27	26	26	25	25	24	24	23	23	22	22
67°57'	69°35'	27	27	26	26	25	25	24	24	23	23	22
69°35'	71°21'	28	27	27	26	26	25	25	24	24	23	23
71°21'	73°16'	28	28	27	27	26	26	25	25	24	24	23
73°16'	75°24'	29	28	28	27	27	26	26	25	25	24	24
75°24'	77°52'	29	29	28	28	27	27	26	26	25	25	24
77°52'	80°56'	30	29	29	28	28	27	27	26	26	25	25
80°56'	85°45'	30	30	29	29	28	28	27	27	26	26	25
85°45'	90°00'	31	30	30	29	29	28	28	27	27	26	26

10. COMPLIANCE

Compliance to the following standards is indicated by the corresponding mark on the product.

Mark	Standard
	This product complies with the applicable harmonized standards of EU Directives 2011/65/EU (RoHS), 2014/30/EU (EMC), 2014/35/EU (LVD) and 2014/31/EU (NAWI). The EU Declaration of Conformity is available online at www.ohaus.com/ce .
	This product complies with the applicable statutory standards of the Restriction of the Use of Certain Hazardous Substances in Electrical and Electronic Equipment Regulations 2012, UK Electromagnetic Compatibility Regulations 2016, Electrical Equipment (Safety) Regulations 2016 and Non-Automatic Weighing Instruments Regulations 2016. The UK Declaration of Conformity is available online at www.ohaus.com/uk-declarations .
	This product complies with the EU Directive 2012/19/EU (WEEE). Please dispose of this product in accordance with local regulations at the collecting point specified for electrical and electronic equipment. For disposal instructions in Europe, refer to www.ohaus.com/weee .
	EN 61326-1
	UL 61010-1 CAN/CSA-C22.2 No. 61010-1

Important notice for i-C71...M verified weighing instruments in the EU and UK

When the instrument is used in trade or a legally controlled application it must be set up, verified, and sealed in accordance with local weights and measures regulations. It is the responsibility of the purchaser to ensure that all pertinent legal requirements are met.

Weighing Instruments verified at the place of manufacture bear the following supplementary metrology marking on the descriptive plate.

  1259

  8506

Weighing Instruments to be verified in two stages have no supplementary metrology marking on the descriptive plate. The second stage of conformity assessment must be carried out by the applicable weights and measures authorities.

If national regulations limit the validity period of the verification, the user of the weighing instrument must strictly observe the re-verification period and inform the weights and measures authorities.

As verification requirements vary by jurisdiction, the purchaser should contact their local weights and measures office if they are not familiar with the requirements.

ISED Canada Compliance Statement:

CAN ICES-003(A) / NMB-003(A)

ISO 9001 Registration

The management system governing the production of this product is ISO 9001 certified.

FCC Supplier Declaration of Conformity

Unintentional Radiator per 47CFR Part B
Trade Name: OHAUS CORPORATION
Model or Family identification: i-C71

Party issuing Supplier's Declaration of Conformity:

Ohaus Instruments (Changzhou) Co., Ltd.
Building C, No. 6 Zhengqiang Road, Xuejia Town, Xinbei District, Changzhou
Jiangsu 213022
China

Responsible Party – U.S. Contact Information:

Ohaus Corporation
8 Campus Drive, Suite 105
Parsippany, NJ 07054
United States

FCC Compliance Statement:

Note: This equipment has been tested and found to comply with the limits for a Class A digital device, pursuant to part 15 of the FCC Rules. These limits are designed to provide reasonable protection against harmful interference when the equipment is operated in a commercial environment. This equipment generates, uses, and can radiate radio frequency energy and, if not installed and used in accordance with the instruction manual, may cause harmful interference to radio communications. Operation of this equipment in a residential area is likely to cause harmful interference in which case the user will be required to correct the interference at his own expense.

Changes or modifications not expressly approved by the party responsible for compliance could void the user's authority to operate the equipment.

11. APPENDICES

11.1 MT Standard Continuous Output

A checksum character can be enabled or disabled with continuous output. The data consists of 17 or 18 bytes as shown in the standard continuous output.

Non-significant weight data and tare data digits are transmitted as spaces. The continuous output mode provides compatibility with OHAUS products that require real-time weight data. the standard continuous output.

Table 11-1 shows the format for the standard continuous output.

Table 11-1: Standard Continuous Output Format

	Status ²				Indicated Weight ³					Tare Weight ⁴								
Character	1	2	3	4	5	6	7	8	9	10	11	12	13	14	15	16	17	18
Data	STX ¹	SB-A	SB-B	SB-C	MSD	-	-	-	-	LSD	MSD	-	-	-	-	LSD	CR ⁵	CHK ⁶

Continuous Output Format Notes:

1. ASCII Start of Text character (02 hex), always transmitted.
2. Status bytes A, B and C. Refer to Table 11-2, Table 11-3, and Table 11-4 for details of the structure.
3. Displayed weight. Either gross or net weight. Six digits, no decimal point or sign. Insignificant leading zeroes are replaced with spaces.
4. Tare weight. Six digits of tare weight data. No decimal point in field.
5. ASCII Carriage Return <CR> character (0D hex).
6. Checksum, transmitted only if enabled in setup. Checksum is used to detect errors in the transmission of data. Checksum is defined as the 2's complement of the seven low order bits of the binary sum of all characters preceding the checksum character, including the <STX> and <CR> characters.

Table 11-2, Table 11-3, and Table 11-4 detail the status bytes for standard continuous output.

Table 11-2: Status Byte A Bit Definitions

Bits 2, 1, and 0			
2	1	0	Decimal Point Location
0	0	0	XXXXX00
0	0	1	XXXXX0
0	1	0	XXXXXX
0	1	1	XXXXX.X
1	0	0	XXXX.XX
1	0	1	XXX.XXX
1	1	0	XX.XXXX
1	1	1	X.XXXXX
Bits 4 and 3			
4		3	Build Code
0		1	X1
1		0	X2
1		1	X5
Bit 5			Always = 1
Bit 6			Always = 0

Table 11-3: Status Byte B Bit Definitions

Status Bits	Function
Bit 0	Gross = 0, Net = 1
Bit 1	Sign, Positive = 0, Negative = 1
Bit 2	Out of Range = 1 (Over Capacity or Under Zero)
Bit 3	Motion = 1, Stable = 0
Bit 4	lb = 0, kg = 1 (see also Status Byte C, bits 0, 1, 2)
Bit 5	Always = 1
Bit 6	Zero Not Captured after power-up = 1

Table 11-4: Status Byte C Bit Definitions

Bits 2, 1, and 0			Weight Description
2	1	0	
0	0	0	lb or kg, selected by Status Byte B, bit 4
0	0	1	grams (g)
0	1	0	metric tons (t)
0	1	1	ounces (oz)
1	0	0	not used
1	0	1	not used
1	1	1	tons (ton)
1	1	1	no units
Bit 3			Print Request = 1
Bit 4			Expand Data x 10 = 1, Normal = 0
Bit 5			Always = 1
Bit 6			Always = 0

11.2 MT-SICS Commands

	Command	Function
LEVEL 0	@	Reset the scale
	I1	Inquiry of SICS level and SICS versions
	I2	Inquiry of scale data
	I3	Inquiry of scale software version
	I4	Inquiry of serial number
	S	Send stable weight value
	SI	Send weight value immediately
	SIR	Send weight value repeatedly
	Z	Zero the scale
	ZI	Zero immediately
LEVEL 1	D	Write text into display
	DW	Weight display
	SR	Send and repeat stable weight value
	T	Tare
	TA	Tare value
	TAC	Clear tare
	TI	Tare immediately

	Command	Function
LEVEL 2	C2	Calibrate with the external calibration weight
	C3	Calibrate with the internal calibration weight
	I10	Inquire or set scale ID
	I11	Inquire of scale type
	P100	Print out on the printer
	P101	Print out stable weight value
	P102	Print out current weight value immediately
	SIRU	Send weight value in the current unit immediately and repeat
	SIU	Send weight value in the current unit immediately
	SNR	Send stable weight value and repeat after every weight change
	SNRU	Send stable weight value in the current unit and repeat after every weight change
	SRU	Send weight value in the current unit and repeat
	ST	After pressing the Transfer key, send the stable weight value
	SU	Send stable weight value in the current unit
	M01	Weighing mode
	M02	Stability setting
	M03	Autozero function
	M19	Send calibration weight
	M21	Inquire/set weight unit
	PRN	Print out at every printer interface
	RST	Restart
	SFIR	Send weight value immediately and repeat quickly
	SIH	Send weight value immediately in high resolution
	SWU	Switch weight unit
	SX	Send stable data record
	SXI	Send data record immediately
	SXIR	Send data record immediately and repeat
	U	Switch weight unit

11.3 OHAUS Commands

Commands listed in the following table will be acknowledged by the scale.

The scale will return "ES" for invalid commands.

Please add `\r\n` after each command to send (`\r` refers to `\return`; `\n` refers to `\newline`)

OHAUS Commands

Command	Function
P	Print displayed weight (stable or unstable).
IP	Print displayed weight immediately (stable or unstable).
CP	Print weight continuously.
SP(0-60)	Print weight when stable.
Z	Same as pressing Zero Key.
T	Same as pressing Tare Key.
TA	Set/inquiry of tare weight value. <ul style="list-style-type: none"> Set: TA <i>tare value unit</i> Example: TA 5 kg Inquiry: TA
U	Set/inquiry current display unit. <ul style="list-style-type: none"> Set: U <i>unit ID</i> Example: U 1 Please check the following table 11-5 for the ID of each unit. Inquiry: U
M	Set/inquiry current application mode. <ul style="list-style-type: none"> Set: M <i>application ID</i> Example: M 0 Please check the following table 11-6 for the ID of each application. Inquiry: M
PSN	Print terminal's serial number.
PV	Print name, software revision and LFT ON (if LFT security switch is turned ON).
H x "text"	Enter Header String content, x = string number (1-5), "text" = string text up to 40 alphanumeric characters.
F x "text"	Enter Footer String content, x = string number (1-2), "text" = string text up to 40 alphanumeric characters.

NOTE:

- The italic content in each command needs to be filled with actual value.
- Space in each command is needed. Please pay attention to it when input commands.

Table 11-5 Unit ID

Unit ID	Unit Name	Abbreviation
0	Gram	g
1	Kilogram	kg
7	Pound	lb
8	Ounce	oz
20	Pound:Ounces	lb:oz

Table 11-6 Application ID

Application ID	Unit Name
0	Weighing
4	Dynamic
6	Totalization
18	Weight Alert

11.4 OH-Continuous Print

- Format 1: For the printout result including interval and continuous printing mode of Weight Alert application

Field	Weight (Right aligned)	Space	Unit (Right aligned)	Space	Stability (?)
Length	11	1	5	1	1
Field	Space	T/N/G/PT (Right aligned)	Space	Application Status (Right aligned)	Term.
Length	1	2	1	6	2

NOTE: **Application Status** is fixed to 6 or 11 characters. The printed status will be "Under", "Accept", "Over LMTx" for Weight Alert. In Alert mode, the over status will be printed as 6 + 1 space + 4 characters. Such as "Over LMT1". If the status is undefined, 6 spaces will be printed.

- Format 2: For Non-Weight Alert applications' printout result

Field	Weight (Right aligned)	Space	Unit (Right aligned)	Space	Stability (?)	Space	T/N/G/PT (Right aligned)	Term
Length	11	1	5	1	1	1	2	2

NOTE: Even for Weight Alert application, only result printout (include interval/ continuous print) follows format 1, all other printouts (tare, net, etc.) follows format 2.

11.5 Column Kit Installation

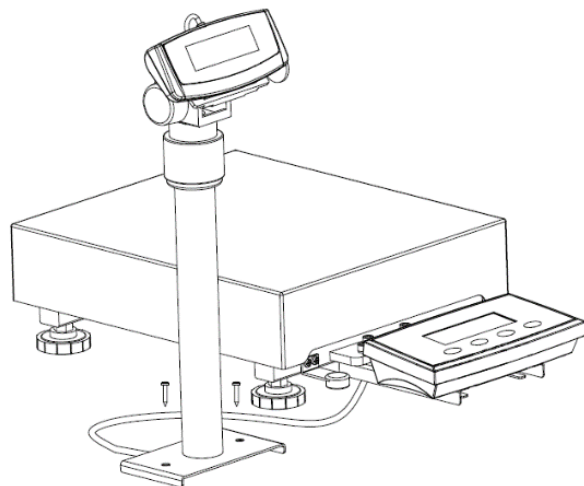
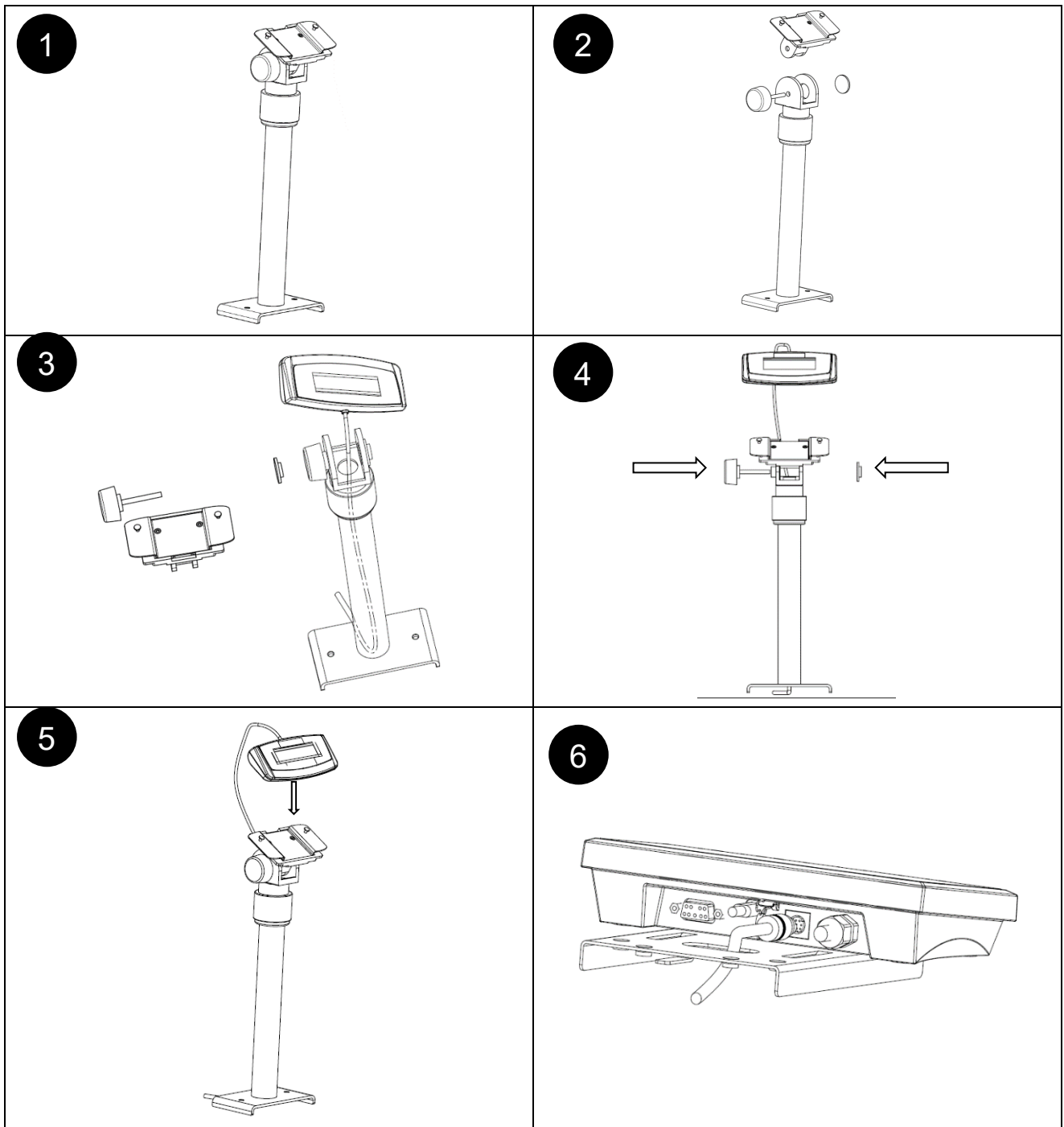

LIMITED WARRANTY

OHAUS products are warranted against defects in materials and workmanship from the date of delivery through the duration of the warranty period. During the warranty period OHAUS will repair, or, at its option, replace any component(s) that proves to be defective at no charge, provided that the product is returned, freight prepaid, to OHAUS. This warranty does not apply if the product has been damaged by accident or misuse, exposed to radioactive or corrosive materials, has foreign material penetrating to the inside of the product, or as a result of service or modification by other than OHAUS. In lieu of a properly returned warranty registration card, the warranty period shall begin on the date of shipment to the authorized dealer. No other express or implied warranty is given by OHAUS Corporation. OHAUS Corporation shall not be liable for any consequential damages.

As warranty legislation differs from state to state and country to country, please contact OHAUS or your local OHAUS dealer for further details



Ohaus Corporation
8 Campus Drive
Suite 105
Parsippany, NJ 07054 USA

With offices worldwide / Con oficinas en todo el mundo / Avec des bureaux partout dans le monde / Mit Büros weltweit /
Con uffici in tutto il mondo
www.ohaus.com



* 3 0 8 0 9 9 2 9 *

P/N 30809929 C © 2023 Ohaus Corporation, all rights reserved / todos los derechos reservados /
tous droits réservés / alle Rechte vorbehalten / tutti i diritti riservati