

Operating and Service Guide

Keysight IntegraVision PA2200 Series Power Analyzers



Notices

Copyright Notice

© Keysight Technologies 2015-2016

No part of this manual may be reproduced in any form or by any means (including electronic storage and retrieval or translation into a foreign language) without prior agreement and written consent from Keysight Technologies, Inc. as governed by United States and international copyright laws.

Manual Part Number

PA2200-90001

Edition

Edition 2, February 2016

Published by

Keysight Technologies, Inc.
900 S. Taft Ave.
Loveland, CO 80537
USA

Warranty

THE MATERIAL CONTAINED IN THIS DOCUMENT IS PROVIDED “AS IS,” AND IS SUBJECT TO BEING CHANGED, WITHOUT NOTICE, IN FUTURE EDITIONS. FURTHER, TO THE MAXIMUM EXTENT PERMITTED BY APPLICABLE LAW, KEYSIGHT DISCLAIMS ALL WARRANTIES, EITHER EXPRESS OR IMPLIED, WITH REGARD TO THIS MANUAL AND ANY INFORMATION CONTAINED HEREIN, INCLUDING BUT NOT LIMITED TO THE IMPLIED WARRANTIES OF MERCHANTABILITY AND FITNESS FOR A PARTICULAR PURPOSE. KEYSIGHT SHALL NOT BE LIABLE FOR ERRORS OR FOR INCIDENTAL OR CONSEQUENTIAL DAMAGES IN CONNECTION WITH THE FURNISHING, USE, OR PERFORMANCE OF THIS DOCUMENT OR OF ANY INFORMATION CONTAINED HEREIN. SHOULD KEYSIGHT AND THE USER HAVE A SEPARATE WRITTEN AGREEMENT WITH WARRANTY TERMS COVERING THE MATERIAL IN THIS DOCUMENT THAT CONFLICT WITH THESE TERMS, THE WARRANTY TERMS IN THE SEPARATE AGREEMENT SHALL CONTROL.

Waste Electrical and Electronic Equipment (WEEE)

This product complies with the WEEE Directive) marketing requirement. The affixed product label (see below) indicates that you must not discard this electrical/electronic product in domestic household waste.

Product Category: With reference to the equipment types in the WEEE directive Annex 1, this product is classified as “Monitoring and Control instrumentation” product. Do not dispose in domestic household waste.

To return unwanted products, contact your local Keysight office, or see

about.keysight.com/en/companyinfo/environment/takeback.shtml for more information.



Technology Licenses

The hardware and/or software described in this document are furnished under a license and may be used or copied only in accordance with the terms of such license.

U.S. Government Rights

The Software is “commercial computer software,” as defined by Federal Acquisition Regulation (“FAR”) 2.101. Pursuant to FAR 12.212 and 27.405-3 and Department of Defense FAR Supplement (“DFARS”) 227.7202, the U.S. government acquires commercial computer software under the same terms by which the software is customarily provided to the public. Accordingly, Keysight provides the Software to U.S. government customers under its standard commercial license, which is embodied in its End User License Agreement (EULA). The license set forth in the EULA represents the exclusive authority by which the U.S. government may use, modify, distribute, or disclose the Software. The EULA and the license set forth therein, does not require or permit, among other things, that Keysight: (1) Furnish technical information related to commercial computer software or commercial computer software documentation that is not customarily provided to the public; or (2) Relinquish to, or otherwise provide, the government rights in excess of these rights customarily provided to the public to use, modify, reproduce, release, perform, display, or disclose commercial computer software or commercial computer software documentation. No additional government requirements beyond those set forth in the EULA shall apply, except to the extent that those terms, rights, or licenses are explicitly required from all providers of commercial computer software pursuant to the FAR and the DFARS and are set forth specifically in writing elsewhere in the EULA. Keysight shall be under no obligation to update, revise or otherwise modify the Software. With respect to any technical data as defined by FAR 2.101, pursuant to FAR 12.211 and 27.404.2 and DFARS 227.7102, the U.S. government acquires no greater than Limited Rights as defined in FAR 27.401 or DFAR 227.7103-5 (c), as applicable in any technical data.

Declarations of Conformity

Declarations of Conformity for this product and for other Keysight products may be downloaded from the Web. Go to <http://regulations.corporate.keysight.com/DoC/search.htm> and click on “Declarations of Conformity.” You can then search by product number to find the latest Declaration of Conformity.

Safety Information

CAUTION





A CAUTION notice denotes a hazard. It calls attention to an operating procedure, practice, or the like that, if not correctly performed or adhered to, could result in damage to the product or loss of important data. Do not proceed beyond a CAUTION notice until the indicated conditions are fully understood and met.

WARNING

A WARNING notice denotes a hazard. It calls attention to an operating procedure, practice, or the like that, if not correctly performed or adhered to, could result in personal injury or death. Do not proceed beyond a WARNING notice until the indicated conditions are fully understood and met.

Safety Information

Safety Symbols

-  Alternating current
-  AC and/or DC current
-  Frame or chassis terminal
-  Off indication. Unit is completely disconnected from AC mains power when switch is off.
-  On indication. Unit is connected to AC mains power and turned on.

 **WARNING** Risk of electric shock

 **CAUTION** Refer to accompanying documents.

 **ISM 1-A** The CE mark indicates the instrument meets the requirements of the applicable European Community Directives to be placed on the European Community market. "ISM 1-A" indicates that the instrument is an "Industrial, Scientific and Medical Group 1, Class A" product. The CE mark is a registered trademark of the European Community.

 The ETL mark with the 'c' and 'us' subscript indicates the instrument is certified to the applicable Canadian and United States of America product safety standards respectively.

CAT II 1000V IEC Measurement Category II. Inputs may be connected for the purposes of performing measurements to AC mains power sources up to 1000 VAC in Measurement Category II environments. Such environments are typically within equipment that is connected to the mains by a cord and plug, and not by a permanent connection.

 The RCM mark is a registered trademark of the Spectrum Management Agency of Australia. This signifies compliance with the Australian EMC Framework regulations under the terms of the Radio Communications Act of 1992.

ICES-001 This mark indicates the instrument complies with the Canadian Interference-Causing Equipment Standard for Industrial, Scientific and Medical (ISM) Radio Frequency Generators.

 This equipment is Class A suitable for professional use and is for use in electromagnetic environments outside of the home.

이 기기는 업무용 (A 급) 전자파적합기기로서 판매자 또는 사용자는 이 점을 주의하시기 바라며, 가정외의 지역에서 사용하는 것을 목적으로 합니다.

 Contains more than the maximum concentration value (MCV) of one or more of 6 specified hazardous substances; 40 Year EPUP.

Safety Information

General

Do not use this product in any manner not specified by the manufacturer. The protective features of this product may be impaired if it is used in a manner not specified in the operation instructions. Do not install substitute parts or perform any unauthorized modification to the product. Return the product to a Keysight Technologies Service facility for service and repair to ensure that safety features are maintained.

WARNING

Product Grounding

The instrument is a Class 1 product and is provided with a grounding-type power cord set. The instrument chassis and cover are connected to the instrument electrical ground to minimize shock hazard. The ground pin of the cord set plug must be firmly connected to the electrical ground (safety ground) terminal at the power outlet. Any interruption of the protective earth (grounding) conductor or disconnection of the protective earth terminal will cause a potential shock hazard that could result in personal injury or death.

WARNING

Cleaning

To prevent electrical shock, disconnect the instrument from AC mains power and disconnect all test leads before cleaning. Clean the outside of the instrument using a soft, lint-free cloth slightly dampened with water. Do not use detergent or solvents. Do not attempt to clean internally. If needed, contact a Keysight Technologies Service facility to arrange for proper cleaning to ensure that safety features and performance are maintained.

WARNING

AC Power Cord

Removal of the AC power cord is the disconnect method to remove power from the instrument. Be sure to allow for adequate access to the power cord to permit disconnection from AC power. Use only the Keysight specified power cord for the country of use or one with equivalent ratings.

WARNING

Do Not Remove Instrument Cover

Only qualified, service-trained personnel should remove the cover from the instrument. Service: Unplug instrument from wall outlet, remove power cord, and remove all connections from all terminals before servicing.

WARNING

Current Measurement Protection Fuse

The internal current measurement terminals I2A or I50A or COM do not have any fusing. Be sure to provide adequate external fusing appropriate for your application to ensure the input measurement limits for these terminals are not exceeded. Failure to do so may result in fire and/or damage to the instrument.

WARNING

Do Not Operate in an Explosive Atmosphere

This instrument is not designed to be operated in an explosive environment. The instrument enclosure complies with the IP20 rating.

WARNING

In Case of Damage

An instrument that appears damaged or defective should be turned off, unplugged, and secured against unintended operation until qualified service personnel can repair it.

WARNING

Self-Test

Before measuring any hazardous voltage or current, remove all test leads to the instrument, and run both self-tests from the front panel. Press the [Utility] hard key, and then the 'Service' soft key to navigate to the self-test options. Run the Hardware Self-Test by pressing the 'Hardware Self-Test' soft key. After this test is completed, run the Interactive Self-Test by pressing the 'Interactive Self-Test' soft key. If either Self-Test fails, the instrument should be turned off, unplugged, and secured against unintended operation until qualified service personnel can repair it.

WARNING

Measuring AC Power Mains

The U+ and U- input terminals, I2A and I50A input terminals and IEXT input terminals may be connected to AC mains power in IEC Category II installations for line voltages up to 1000 VAC. To avoid the danger of electric shock, do not connect the inputs to AC mains power for line voltages above 1000 VAC. Do not use this instrument for performing measurements in Measuring Category III or IV environments. See the section titled "IEC Measurement Category II" for further information.

WARNING

Measuring Circuits with Voltage or Current Transformers

If a current transformer is used with the Internal Current Measurement Inputs, the transformer must contain internal protection. When using a transformer with the voltage inputs or external transducer inputs, be sure to provide adequate external protection for the application. Always ensure that the resulting signals applied to the instrument will not exceed the specified input limits when using a transformer. Using a transformer without protection may result in a hazardous voltage resulting in a severe shock or death, or may cause damage to the instrument.

WARNING

Applying Hazardous Voltages to the Instrument Measurement Terminals

Connecting hazardous live voltage to any terminal may expose the user to hazardous live voltages on other terminals. Do not modify the connections to the instrument input terminals while any of the connected circuits are energized, regardless of any readings reported by the instrument. The user should verify all measurement circuits are correctly wired to the instrument before energizing the measurement circuits.

WARNING

De-energizing Measurement Circuits with Hazardous Voltages

Always allow adequate time for circuits to fully de-energize after removing power from these circuits. Do not rely on the reported readings from the instrument to determine whether a circuit is de-energized.

WARNING

Readings Reported by the Browser Web Control Page

Should network communication issues occur, the reported readings and instrument configuration settings shown in the Browser Web Control page may not represent the actual readings or instrument state. Do not rely on the reported readings from the Web Control Browser to determine if a circuit that may have hazardous voltages present is safely de-energized.

WARNING

Leads and Connectors

For voltage measurements, assure that all leads and connectors are suitably insulated and rated for the highest voltage that is applied to any voltage measurement terminal on any channel. For current measurements, assure that all leads and connectors are suitably insulated and rated for the highest current and voltage that is applied to any current measuring terminal on any channel.

WARNING

Overload Indication

When the overload indicator is displayed, any traces or numerical measurements appearing on the display are not considered to be reliable. Even if a trace or numerical measurement appears to be within the bounds of the allowable input range for a given configuration, the instrument may not be providing accurate measurements when the overload indicator is displayed due to the recovery time required for the measurement hardware after certain overload events.

I1: OVERLOAD - Fixed Range

WARNING

Operating Conditions

Never use the instrument outside of the specified operating conditions described in the 'Environment' section of the specifications. Never apply signals to measurement inputs or apply AC power to the instrument in a condensing environment.

WARNING

Measurement Limits

To avoid instrument damage and the risk of electric shock, do not exceed any of the Measurement Limits defined in the following section.

CAUTION

Measurement Limits

This is a sensitive measurement apparatus by design and may have some performance loss when exposed to ambient continuous electromagnetic phenomenon.

Measurement Limits

The PA2201A Series Power Analyzer provides protection circuitry to prevent damage to the instrument and to protect against the danger of electric shock, provided the Measurement Limits are not exceeded. To ensure safe operation of the instrument, do not exceed the Measurement Limits shown on the rear panel, and defined as follows:

PA2201A Measurement Module Markings

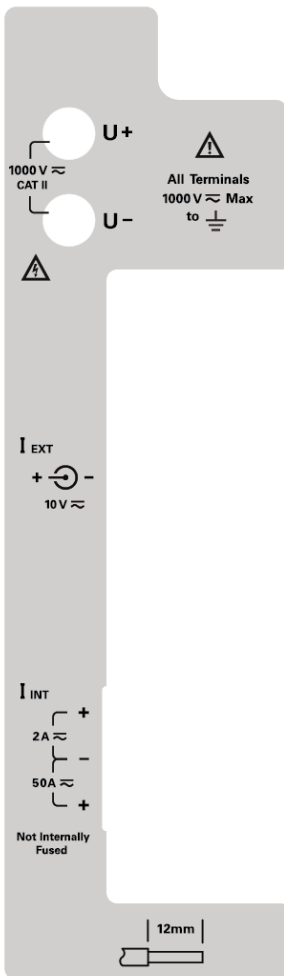

Input Terminal Measurement Limits

Measurement Limits are defined for the input terminals, as described below.

Voltage Input Terminals: U+ and U-

The U+ and U- input terminals are used for voltage measurements. The Measurement Limit from U+ to U- is 1000 VAC rms, 1000 VDC, or 2000 V peak. The Measurement Limit from U+ or U- to chassis is 1000 VAC rms or VDC.

Current Input Terminals I2A and I50A

The I2A and I50A input terminals are used for current measurements. The current input ("I2A") terminal has a Measurement Limit of 2 AAC rms between the "I2A " terminal and the COM input terminal. The current input ("I50A") terminal has a Measurement Limit of 50 AAC rms between the "I50A " terminal and the COM input terminal. The voltage from I2A or I50A or COM to chassis may not exceed 1000 VAC rms or VDC. Note that the current input terminals will always be at approximately the same voltage as the LO terminal.

Current Transducer Input Connector IEXT.

The Measurement Limit from the center conductor to the outer conductor is 10 VAC rms or VDC. The Measurement Limit from either the center conductor or the outer conductor to the chassis is 1000 VAC rms or VDC.

PA2201A I/O, Trigger, Reference In and AC Mains Power Input Markings

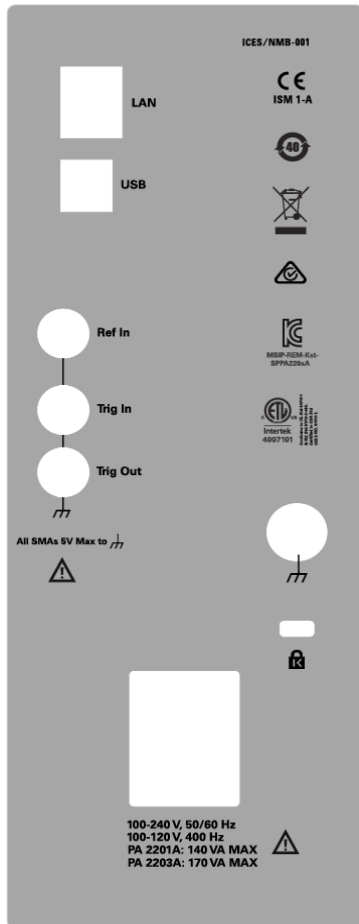

The outer shell of the Ref In, Trig In and Trig Out SMA connectors are connected directly to chassis. The maximum voltage that may be applied to the center conductor of these terminals with respect to the outer shell/chassis is 5 V.

IEC Measurement Category II

The PA2201A Series Power Analyzer is designed to protect the user from typical overvoltage events that occur on AC mains power circuits. When performing measurements on circuits connected to measuring AC mains, the U+ and U- input terminals, I2A and I50A input terminals, and IEXT input terminals may be connected to AC mains- powered circuits with voltages up to 1000 VAC rms in Measurement Category II environments as defined below.

IEC Measurement Category II includes electrical devices connected to AC mains power at an outlet on a branch circuit. Such devices include most small appliances, test equipment, and other devices that plug into a branch outlet or socket. The instrument may be used to make measurements with the

U+ and U- input terminals, I2A and I50A input terminals and IEXT input terminals connected to AC mains power in such devices, or to the branch outlet itself (up to 1000 VAC). However, the instrument may not be used with its input terminals connected to AC mains power in permanently installed electrical devices such as the main circuit-breaker panel, sub-panel disconnect boxes, or permanently-wired motors. Such devices and circuits are subject to over voltages that may exceed the instrument's protection capabilities.

Voltage Input Warnings

WARNING

Voltage Input

The Measurement Limit from U+ to U- is 1000 V ac rms, 1000 V dc, and 2000 V peak. The Measurement Limit from U+ or U- to chassis is 1000 VAC rms or DC.

Before energizing measurement circuits, ensure the leads connecting to the voltage measurement terminals are firmly secured and all measurement circuits are properly configured. Never modify any connections to the instrument or touch any input terminal while measurement circuits are energized.

Always use connectors and leads that are suitably rated and insulated for the maximum voltage that could be applied to any terminal. Be sure to consider both the differential and common mode voltages that may appear on your measurement circuit when choosing appropriate cables and test leads.

Always allow adequate time for circuits being measured to fully de-energize after removing power from these circuits. Do not rely on the reported readings from the instrument to determine whether a circuit is de-energized.

Current Measurement Input Warnings

WARNING

Current Measurement Input - Shutter Operation

A mechanical shutter is used to choose between the Internal Current Measurement terminals (I2A, I50A and COM) and the External Transducer Input (IEXT). The instrument will automatically detect whether the Internal Current Measurement terminals or the External Transducer input is selected by sensing the position of the shutter. Be sure the shutter is slid all the way to the appropriate end of its track when selecting between the Internal Current Measurement terminals and the External Transducer Input to ensure the instrument correctly senses which input is selected. Always de-energize all circuits connected to measurement inputs when changing the position of the shutter.

If the shutter fails to actuate, or the instrument does not correctly sense the position of the sensor, return the instrument for service. You can verify that the instrument correctly senses the position of the shutter by running the 'Interactive Self Test' found under **[Utility] > Service** on the front panel interface.

WARNING**Internal Current Measurement Input**

There is a Measurement Limit of 2 AAC rms between the "I2A " current input terminal and the COM terminal. There is a Measurement Limit of 50 AAC rms between the "I50A " current input terminal and the COM terminal.

The voltage from I2A or I50A or COM to chassis may not exceed 1000 VAC rms or VDC.

Before energizing any measurement circuits, ensure proper connections are made to the external mating connector. Wires should be stripped to 12 mm according to the strip guide on the measurement module label. Ensure the wires are secured into the mating connector before connecting it to the Internal Current Measurement input terminals.

Before energizing any measurements, ensure the mating connector is secured to the Internal Current Measurement Input Terminals by fully tightening both securing screws.

Always use wiring that is suitably rated and insulated for the maximum current and common mode voltage that could be applied to any compatible terminal. Be sure to consider both the maximum current and common mode voltages that may appear in your measurement circuit when choosing appropriately rated and insulated wires.

Always allow adequate time for circuits being measured to fully de-energize after removing power to these circuits. Do not rely on the reported readings from the instrument to determine whether a circuit is de-energized.

The PA2200 Series Power Analyzer has no internal fusing in the internal current measurement circuits. Always provide external adequate fusing for your application to prevent the risk of electric shock or instrument damage. The fuse current rating should not exceed 50 A for the I50A terminal or 2 A for the I2A terminal. The fuse voltage rating must equal or exceed the voltages in the circuit that is to be connected to the terminal. For circuits that are connected directly to mains circuits, the breaking capacity (or interrupting capacity) of the fuse must be properly coordinated with the fault current capacity of the mains circuit. Consult your site electrician for breaking capacity ratings.

The I2A input has a parallel protection relay that will close if excess current is applied to this input. A prompt will appear on the display to allow the user to indicate that the overload condition has been cleared. This relay is not intended as a safety feature, and is only designed to prevent instrument damage during limited overload conditions. Always provide adequate external fusing for your application when using the I2A or I50A inputs.

The instrument does not automatically detect whether a signal is applied to the I2A or I50A inputs when using the Internal Current Measurement inputs. The proper input must be selected via the front-panel interface. Never apply signals to I2A and I50A simultaneously, as this may cause incorrect measurements.

WARNING

External Transducer Input

The Measurement Limit from the center conductor to the outer conductor is 10 VAC rms or VDC. The Measurement Limit from center conductor or the outer conductor to the chassis is 1000 VAC rms or VDC.

Before energizing any measurement circuits, ensure that the external transducer's BNC terminal is properly locked onto the instrument's BNC receptacle and that all measurement circuits are properly configured. Never modify any connections to the instrument or touch any input terminals while measurement circuits are energized.

Always use a cable that is suitably rated and insulated for the maximum voltage that could be applied to any terminal. Be sure to consider both the differential and common mode voltages that may appear on your measurement circuit when choosing an appropriate cable.

Always allow adequate time for circuits being measured to fully de-energize after removing power to these circuits. Do not rely on the reported readings from the instrument to determine whether a circuit is de-energized.

Instrument Service Tasks

Hardware self test

Press **[Utility] > Service > Hardware Self Test** to perform a series of internal procedures that verify proper instrument operation.

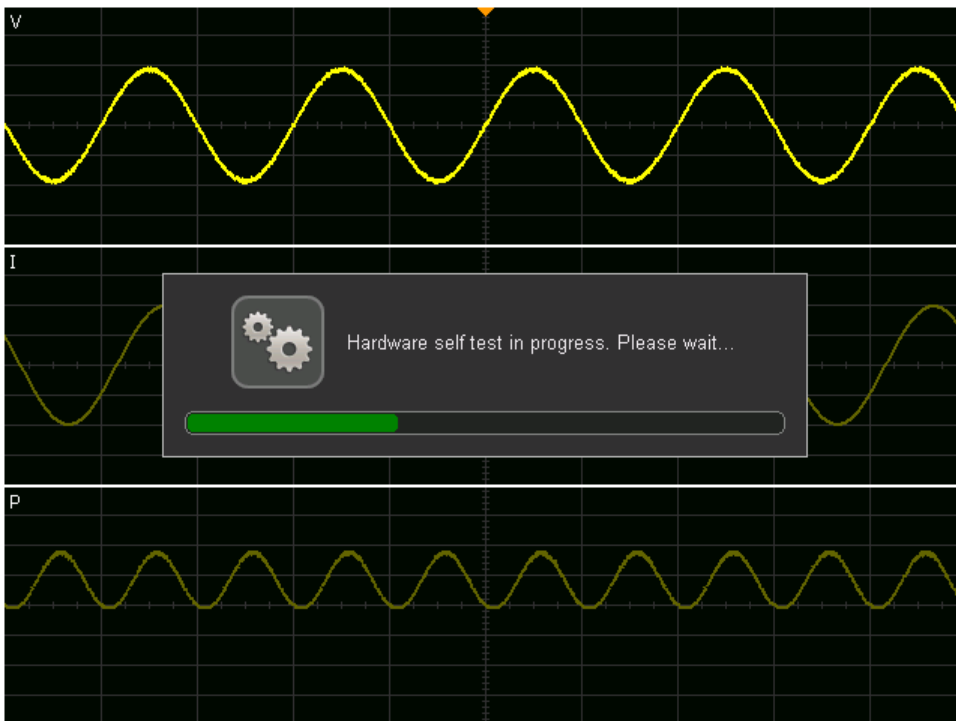

You should run Hardware Self Test after experiencing abnormal operation, for diagnostic information, or to verify proper operation after a repair.

A successful Hardware Self Test provides an 80% confidence level that the instrument is operating properly.

Front-panel self test

Press **[Utility] > Service > Front Panel Self Test** and follow the on-screen instructions that allow you to test the front-panel keys, knobs, and display.

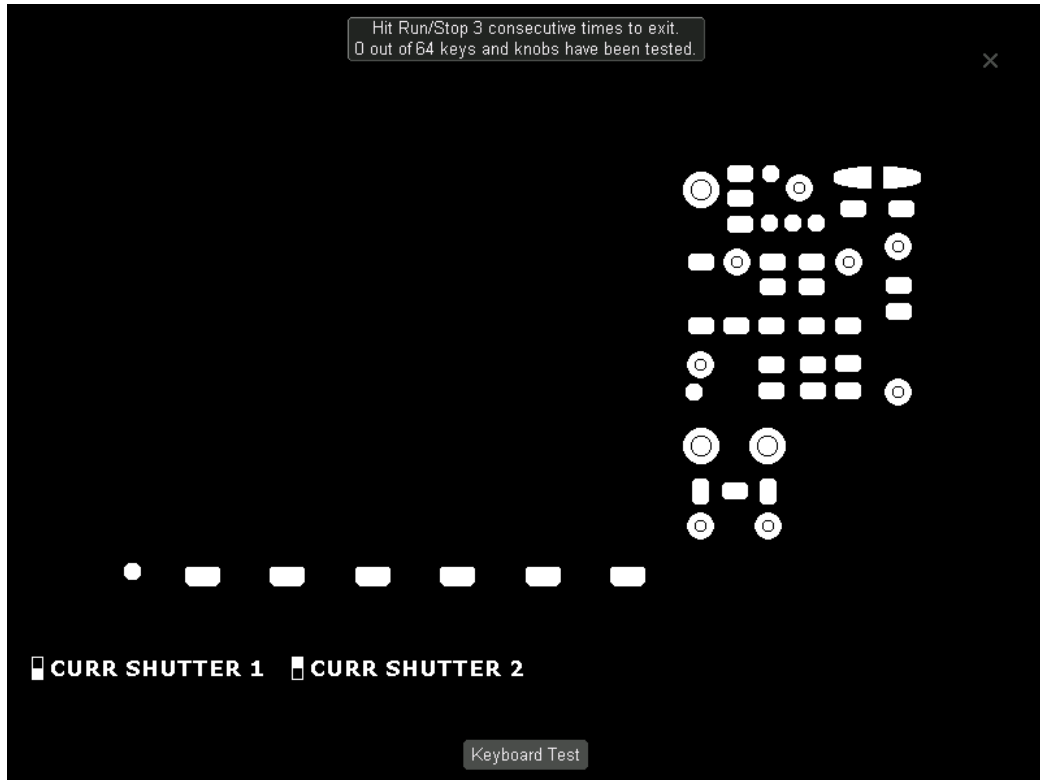

Instrument information

Press **[Help] > About IntegraVision** to display information about your instrument, including model number, serial numbers, and firmware version.

Instrument cleaning

To clean the instrument, disconnect power and all connections to the instrument. Then clean the external surfaces with a soft cloth slightly dampened with a solution of mild detergent and water. Ensure that the instrument is completely dry before reconnecting it.

1 Getting Started

[Inspect the Package Contents](#)

[Learn the Front Panel](#)

[Learn the Rear Panel](#)

[Use the Touchscreen](#)

[Access the Built-In Quick Help](#)

[Softkey Menu Overview](#)

Inspect the Package Contents

Inspect the shipping container for damage. If it appears to be damaged, keep the shipping container and cushioning material until you have inspected the contents of the shipment for completeness and checked the instrument mechanically and electrically.

Verify that you received the following items:

- IntegraVision PA2201A or PA2203A power analyzer
- Power cord (destination country determines specific type)
- Current connectors (one per channel)
- Certificate of calibration
- Safety information document
- Getting Started sheet
- AC Power Source Analyzer ROHS Addendum

Learn the Front Panel

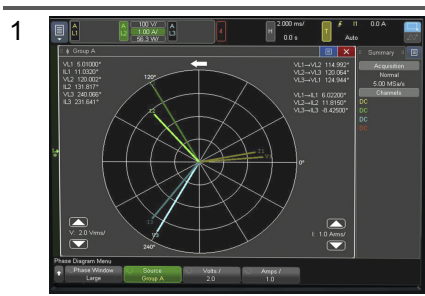
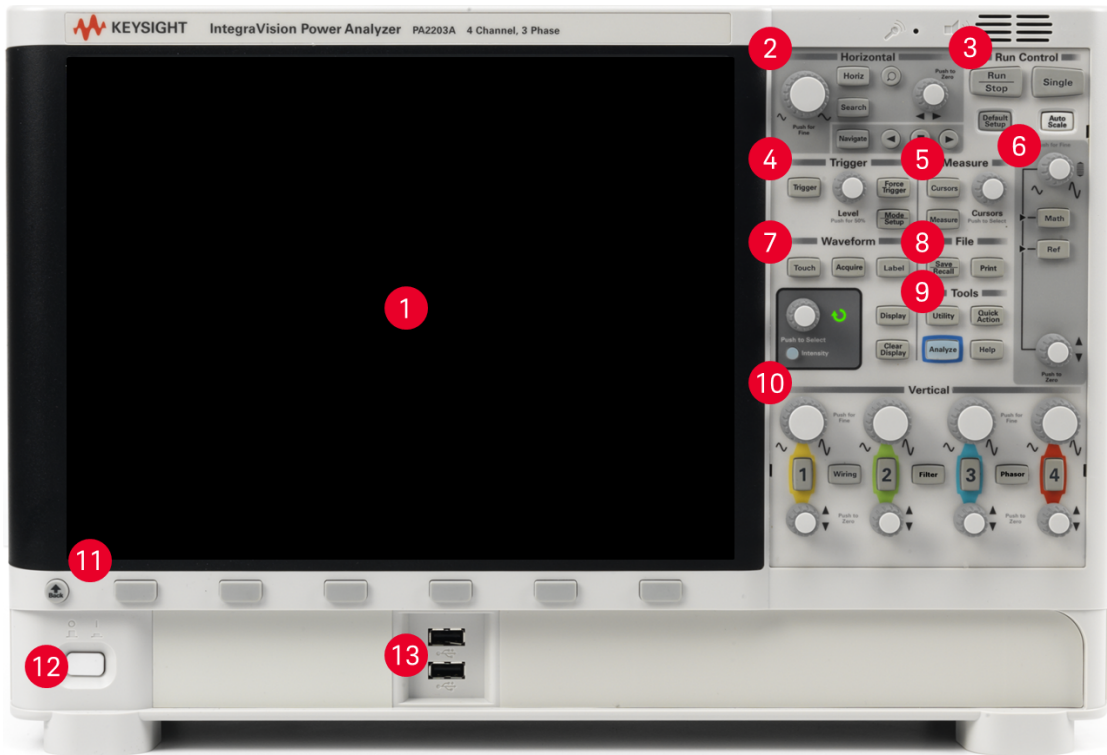

The color display (800x600 pixels) is the heart of the power analyzer's user interface.



Configure the horizontal axis and navigate through the waveform.

Horizontal Controls

3 **Run Control**

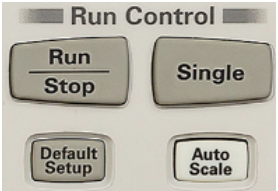

Start and stop running acquisitions or take a single-shot acquisition. Use the **[Default Setup]** and **[Auto Scale]** keys to get to a known state quickly.

Run Control

4 **Trigger**



Configure and execute triggers.

Triggering

5 **Measure**



Configure automatic measurements and statistics or use cursors to make custom waveform measurements.

Cursors

Measurements

6

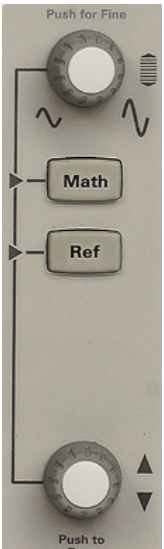

Configure, scale, and offset math and reference waveforms. Use powerful math functions to uncover insights.

Math Waveforms

Math Operators

Math Transforms

FFT Measurement

Reference Waveforms

7 **Waveform**



Specify, adjust and annotate the way the waveform is displayed. Enable or disable the touchscreen for enhanced usability.

Display Settings

8

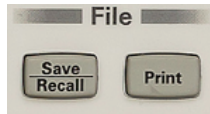

Save and recall screen images, instrument setups, data, and analysis results. Print screen images and setup information.

Save and Recall

Printing Screens

9



Press **[Analyze]** to perform Power Quality, Harmonics, Energy, Efficiency, and I^2t analyses. Press **[Utility]** to customize LAN settings or to configure the instrument for the way you want to use it.

Power Analysis

Setting User Options

10

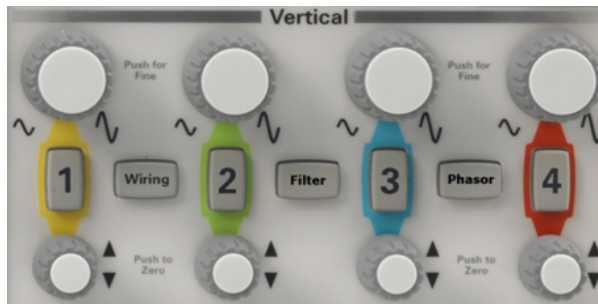

Press **[1]**, **[2]**, **[3]**, or **[4]** to configure and display the voltage, current, and power channels, along with the associated channel sidebars. Use the scale and offset knobs to quickly zoom in on critical information. Use the **[Wiring]** key to specify how your DUT is wired to your instrument and to adjust channel the channel skew. Use the **[Filter]** key to select a high-pass filter, low-pass filter, or no filter for each channel. Use the **[Phasor]** key to configure and display a phasor diagram.

Note that channels **[3]** and **[4]** and the **[Filter]** and **[Phasor]** keys are available only on the PA2203A power analyzer. You can also display the phasor diagram by pressing **[Display] > Phasor**, and you can also configure filters by pressing a channel key (**[1]**, **[2]**, **[3]**, or **[4]**) and then pressing the **Filter** softkey.

Channel Controls

[Wiring] Key: Channel Skew

[Wiring] Key: Channel Grouping

To Filter Incoming Signals

Phasor Diagrams

11



Use the six softkeys (two shown here) to navigate through the menus. Press the round **[Back]** key to return to the previous menu.

12



Press the power switch to turn the instrument on.

13



Use the two USB ports to save and load files.

Tilt the Instrument for Easy Viewing

Move the support feet on the bottom of the front of the instrument (both sides) into the tilted position as shown below.





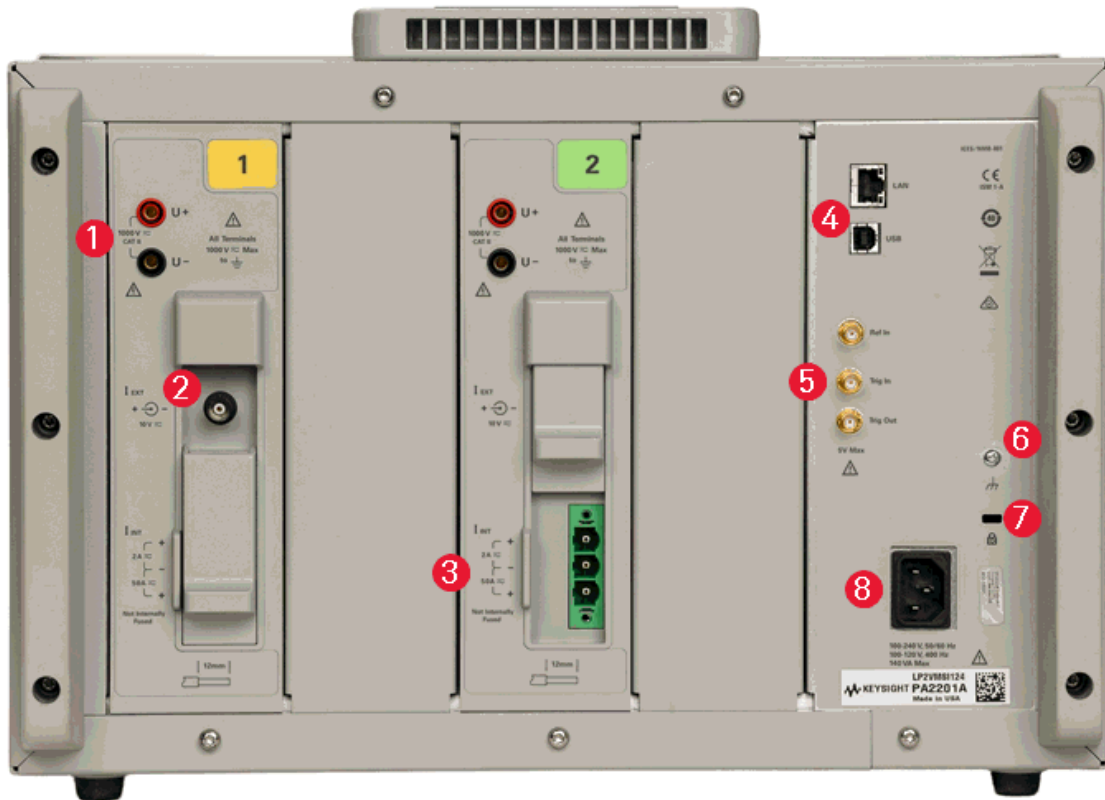

Learn the Rear Panel

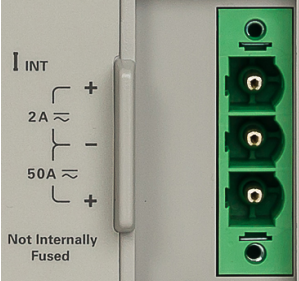
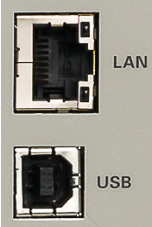

The image above shows a PA2201A. The PA2203A is similar, but it has four identical power channels, labeled 1, 2, 3, and 4.

The external current input (item 2, above) is shown on Channel 1, and the internal current shunts connector (item 3, above) is shown on Channel 2. Both channels are identical on the PA2201A, and all four channels are identical on the PA2203A. The sliders are shown in the down position on Channel 1 and in the up position on Channel 2. The sliders prevent current inputs from going into the external and internal current inputs simultaneously.

<p>1</p> <p>1000 V \approx CAT II</p> <p>U+ U-</p>	<p>Connect your voltage signal here. The maximum input range is 1000 V.</p>
<p>2</p> <p>I_{EXT} + - 10 V \approx</p>	<p>Connect a voltage signal from a current transducer here (shown on channel 1). The maximum input range is 10 V.</p>

<p>3</p> 	<p>Use the three-pin connector (shown on channel 2) for either the internal 2-A (upper and middle pins) or 50-A (lower and middle pins) current shunts. Never connect to them simultaneously. On the front panel, press the channel key, then press Current Input > Internal to specify which shunt you are using.</p>
<p>4</p> 	<p>Use these LAN and USB 2.0 ports for remote instrument control.</p>
<p>5</p> 	<p>Use these SMA ports to synchronize the instrument with other instruments and the application environment. The [Ref In] clock input should be a 10-MHz square wave from 0 to 3.3 V. The [Trig In] and [Trig Out] ports are 0 to 3.3 V, and [Trig In] can tolerate up to 5 V.</p>
<p>6</p> 	<p>Connect to this earth ground access point if you need access to earth ground near the instrument.</p>
<p>7</p> 	<p>Attach a Kensington lock to secure the instrument.</p>
<p>8</p> 	<p>Connect power here. This may be 100 to 240 VAC at 50 to 60 Hz or 100 to 120 VAC at 400 Hz. The maximum power is 140 VA for the PA2201A and 170 VA for the PA2203A.</p>

Use the Touchscreen

Pressing the **[Touch]** key enables and disables the touchscreen functionality of the display. When the **[Touch]** key is not lit, the touchscreen is disabled. When the **[Touch]** key is lit, you can control the instrument by touching different areas of the screen.

Drag and Zoom Waveforms

The icon in the upper right corner of the display toggles between two modes.



When the lower half of the icon is highlighted, you can drag the waveform horizontally.

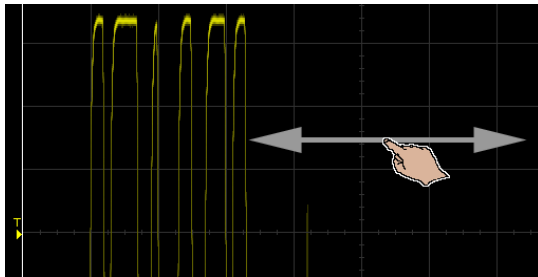

When the top half of the icon is highlighted, you can drag your finger across the touchscreen to draw a rectangle, as shown below.

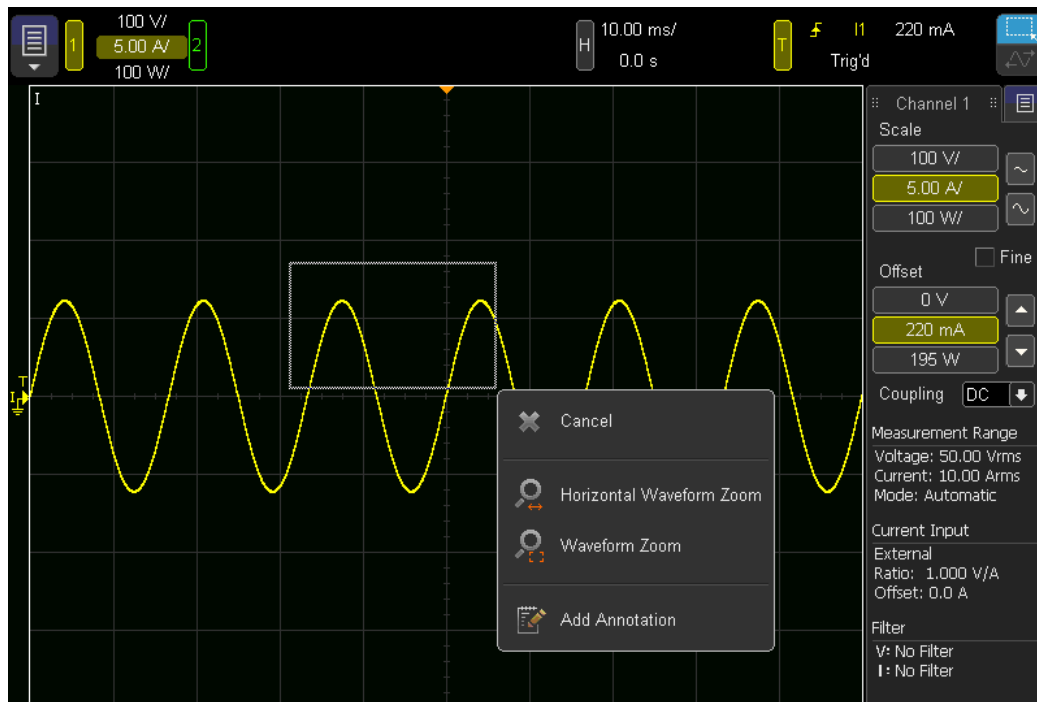

If you choose **Waveform Zoom**, the display will zoom in to the portion of the waveform that you selected, as shown below. Note that you can also select **Horizontal Waveform Zoom** to zoom in horizontally, but not vertically.

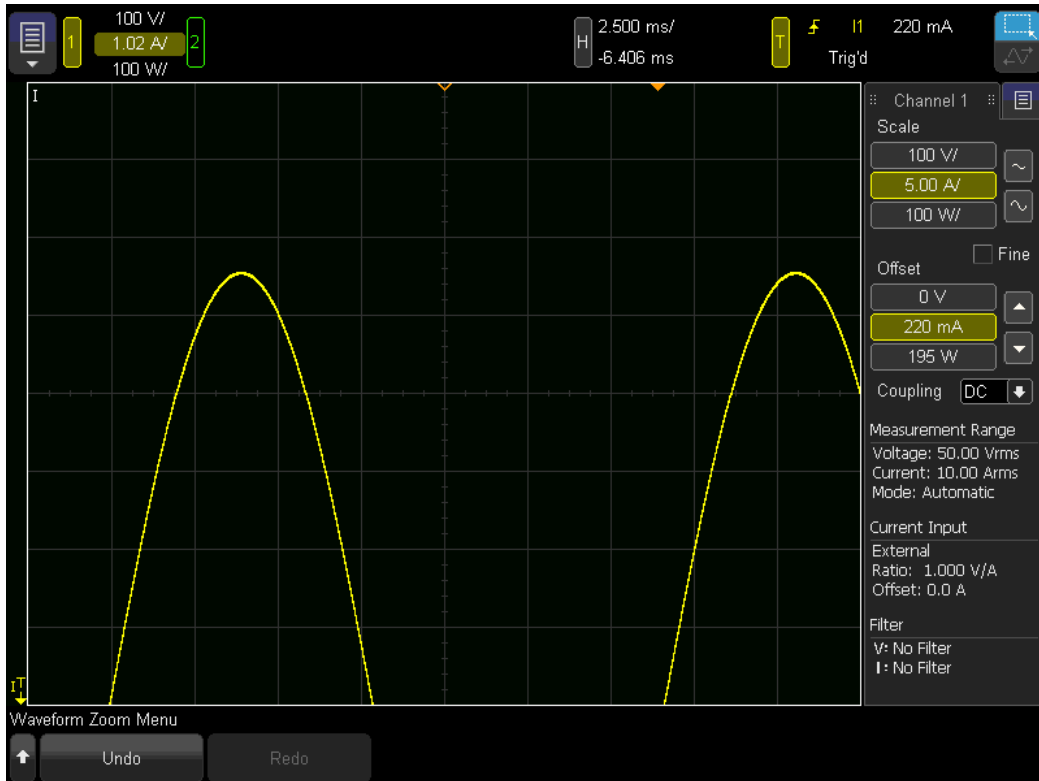

Press **Undo** to revert to the previous vertical and horizontal zoom levels.

Select Sidebar Information or Controls

Press the blue menu button near the upper right corner of the display to show a list of sidebars.

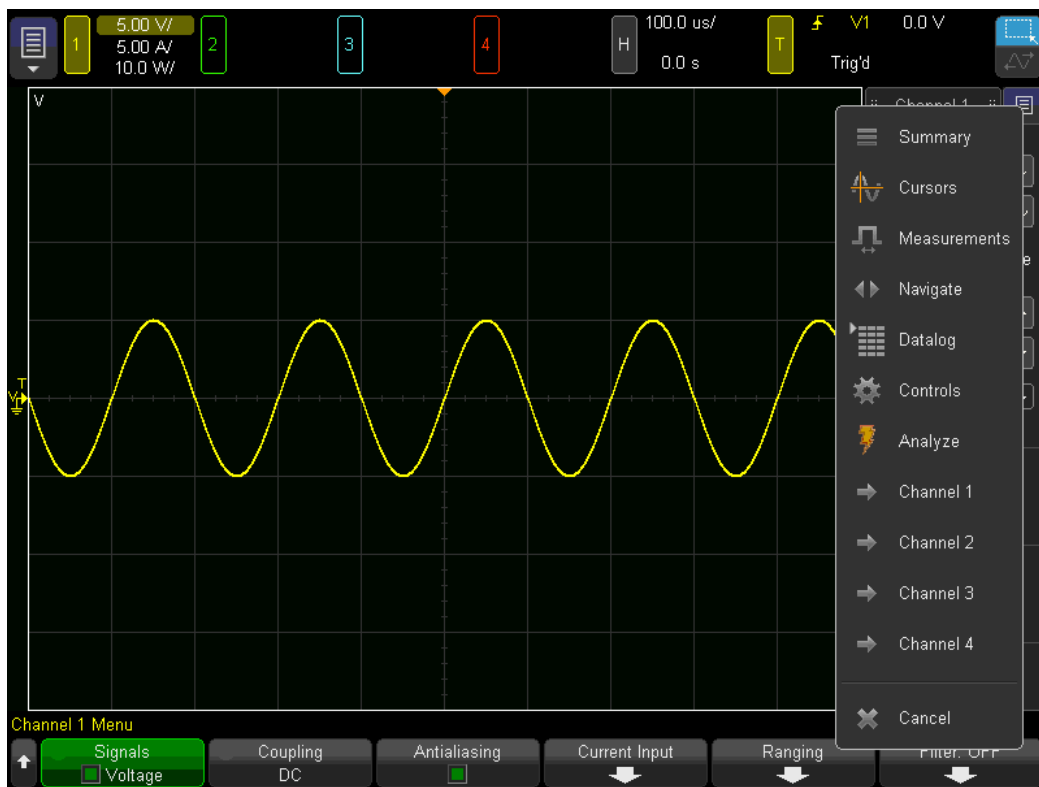

The sidebar that you select (Ctrls, in the image below) will appear on top of the previous one.

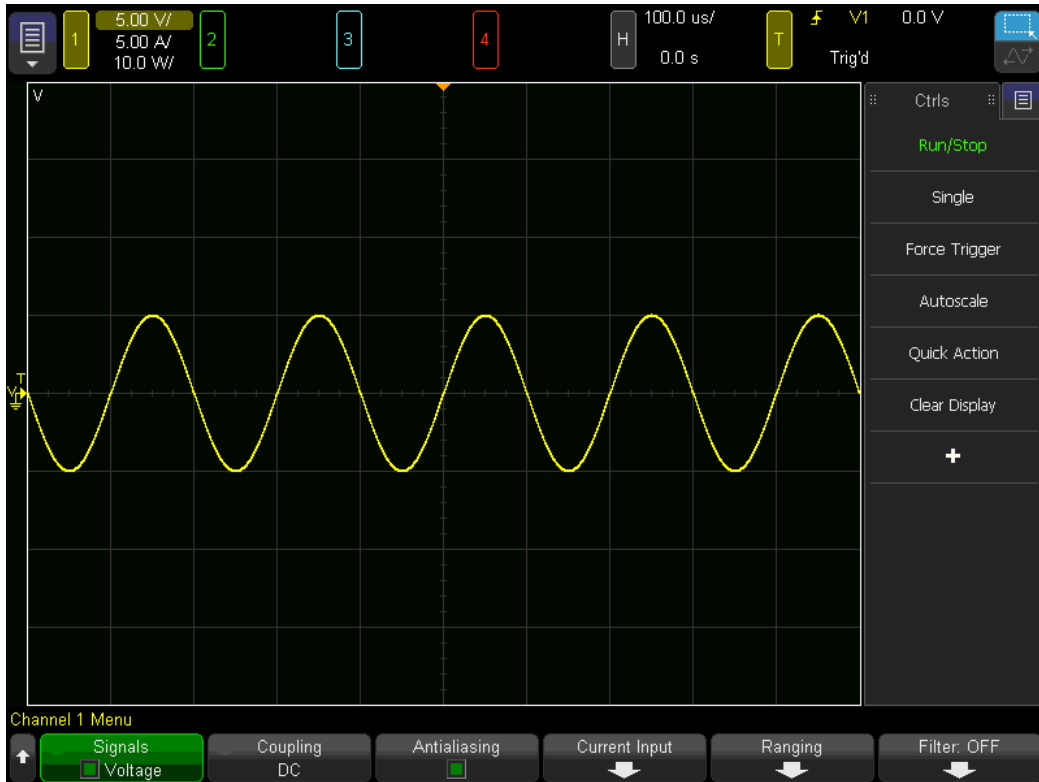

You can drag sidebar titles to move sidebars to other parts of the display, as shown below.

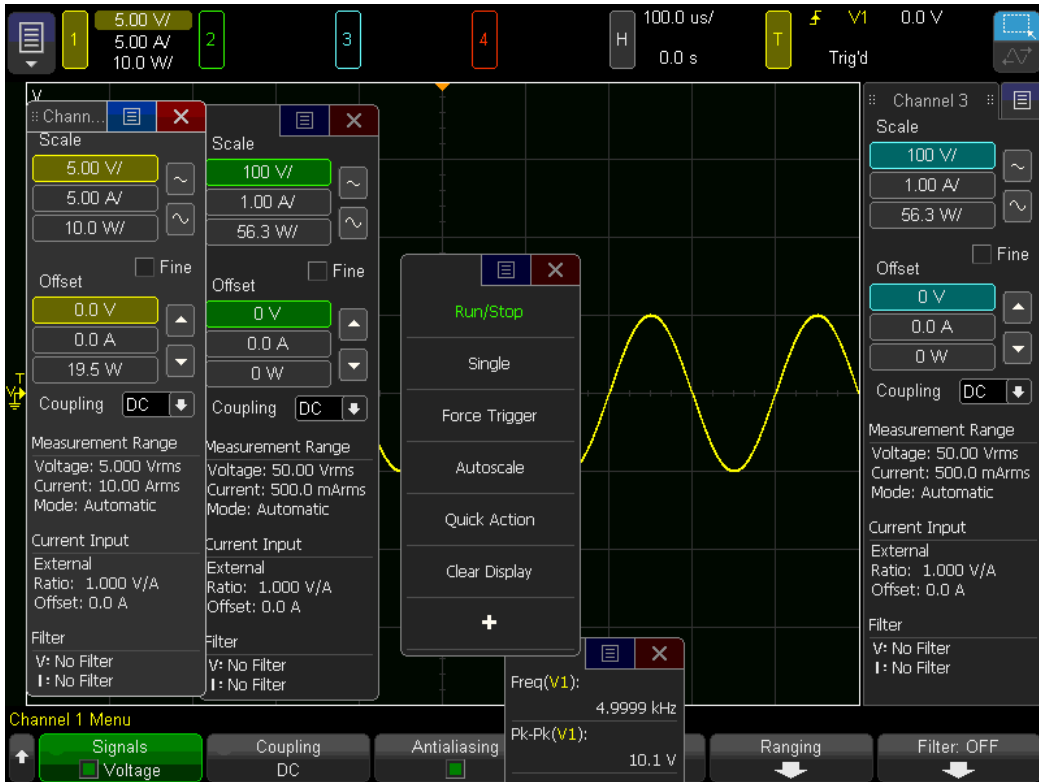

Once you have dragged a sidebar away from its default position on the right, a blue control appears at the top center of the sidebar. Press this button to open a Help control. Pressing the Help control will open a help window describing the sidebar.



Drag Cursors

Drag the name handles of cursors to position them.

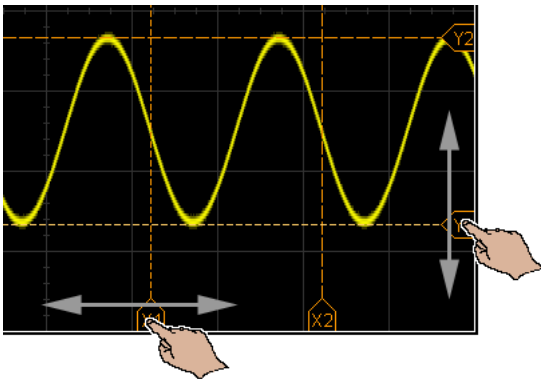

Touch Softkeys and Menus On the Screen

Touch onscreen softkey labels to select them. This is the same as pressing the physical softkeys below the display. When softkeys provide menus, double-touch to select a menu item.

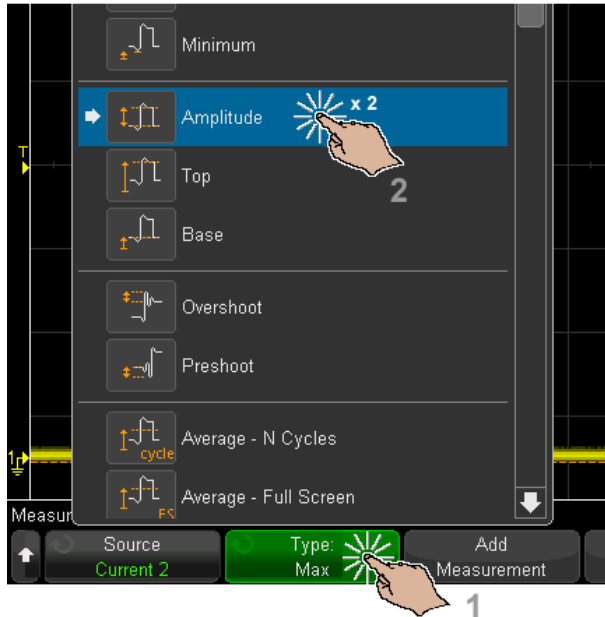

This may be easier than selecting a menu item with the **Entry** knob.

Enter Names Using Alphanumeric Keypad Dialogs

Some softkeys open alphanumeric dialogs that let you touch to enter names. Simply press the keys on the keyboard, and then press **OK** when done. Note that the **Shift** key allows you to access symbols, such as **!**, **@**, **#**, and **\$**.

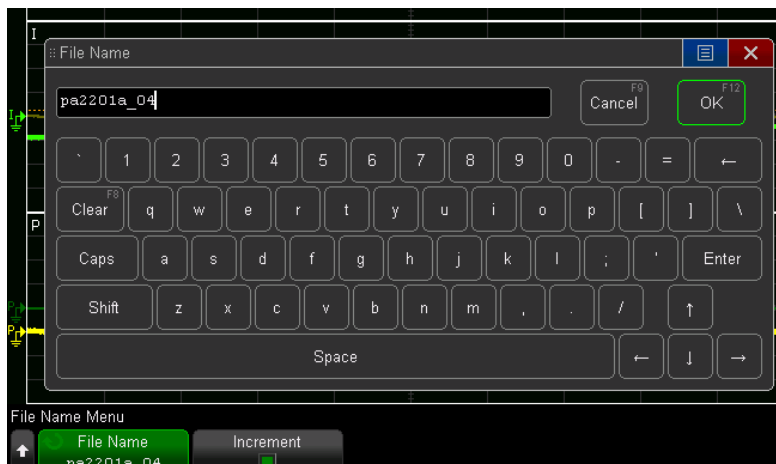

Change Waveform Offsets By Dragging Ground Reference Icons

You can drag ground icons to change a waveform's vertical offset.



Access Controls and Menus

Touch the blue menu icon in the upper-left corner of the display to open the main menu.

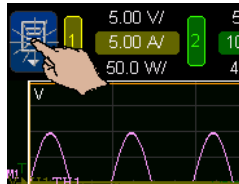

Touch menu items and submenu items to access menus and additional controls.



Touch left side controls to perform instrument operations.

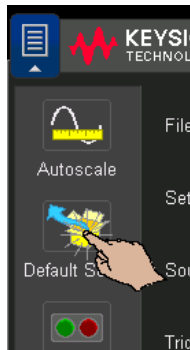

Turn Channels On-Off and Open Scale-Offset Dialogs

Touch channel numbers to turn them on or off. You can also do this with the numbered channel keys in the lower right part of the front panel.

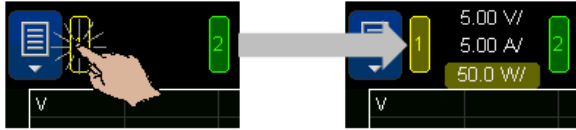

When channels are on, touch the scale and offset values to access a dialog for changing them.

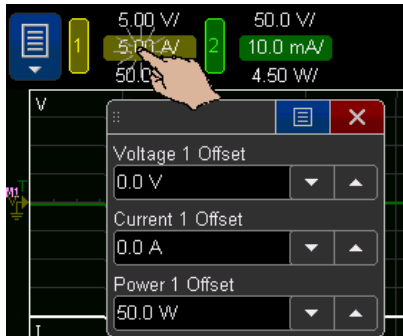

Access the Horizontal Menu and Open the Scale-Delay Dialog

Touch "H" to access the Horizontal Menu.

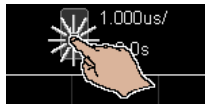

Touch the horizontal scale and delay values to access a dialog for changing them.

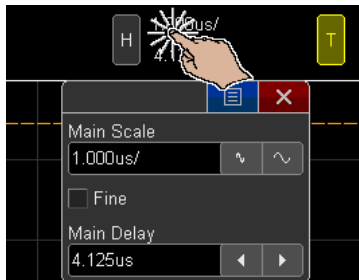

Modify Triggering

Touch "T" to access the Trigger Menu. This is equivalent to pressing the **[Trigger]** key on the front panel.

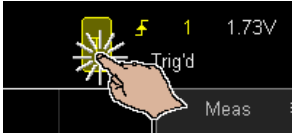

Touch the trigger level value(s) to access a dialog for changing the level(s).

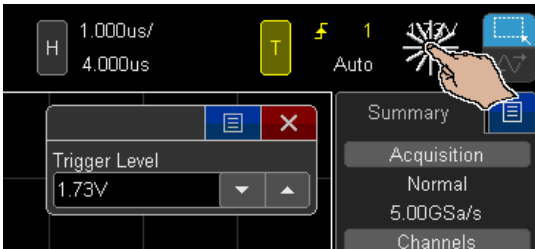

Touch "Auto" or "Trig'd" to quickly toggle the trigger mode.



Access the Built-In Quick Help

Press the **[Help]** key in the Tools section of the front panel for basic information about your instrument.



Getting Started and About IntegraVision

When you press **[Help]**, the instrument displays the following information.

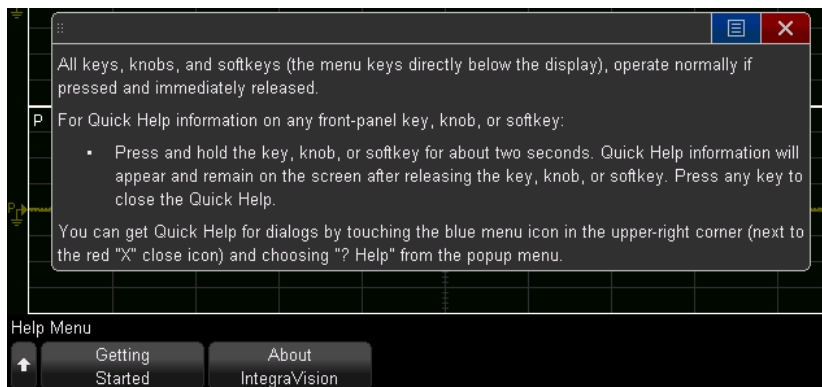

The **Getting Started** softkey contains additional helpful information about using the instrument; read through it to get up to speed quickly. The **About IntegraVision** softkey provides information about your instrument, including serial number, firmware revision, and where to download the latest firmware.

Context-sensitive help

Press and hold any key or softkey for context-specific help, shown below. The help text remains on the screen until another key is pressed or a knob is turned. You may also close the help window by pressing the red "X" in the upper right corner of the window.

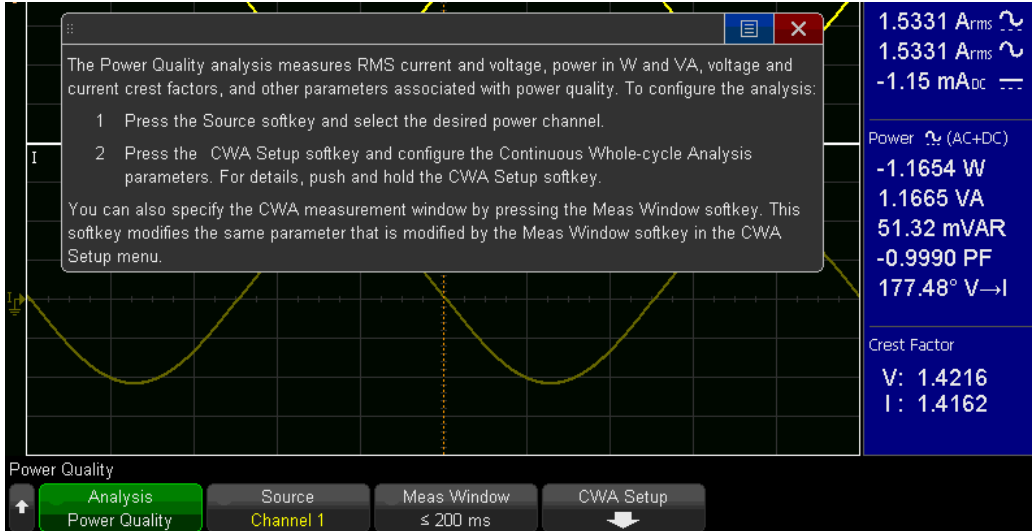

Sidebar help

Once you have dragged a sidebar away from its default position on the right, a blue control appears at the top center of the sidebar. Press this button to open a Help control.

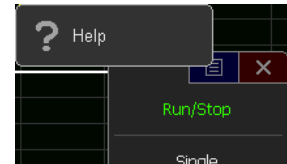

Pressing the Help control will open a help window describing the sidebar, as shown below.

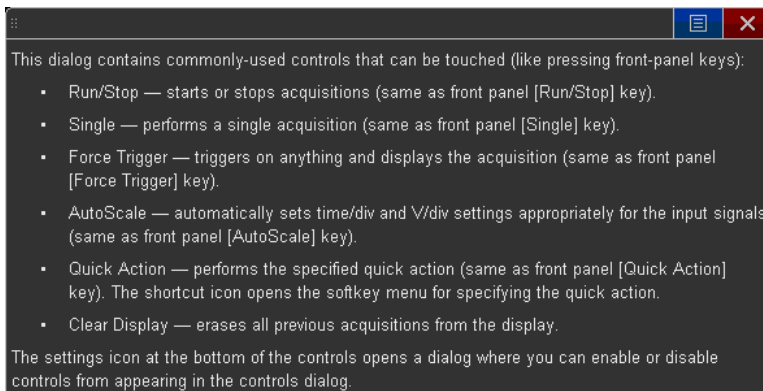

Softkey Menu Overview

The softkey menus associated with front-panel keys are shown in the table below.

Section	Key	Softkeys
Horizontal	Horiz	Fine, Time Ref
	Search	Search, Settings, Thresholds
	Navigate	Navigate, Event
Run Control	Default Setup	Undo Default Setup, Default Setup, Default GUI Layout, Factory Default, Secure Erase
	Auto Scale	Undo Autoscale, Arrange
Trigger	Trigger	Trigger Type, Source, Slope
	Mode/Setup	Trigger Mode, Noise Reject
Measure	Cursors	Mode, Measurement
	Measure	Source, Type, Add Measurement, Settings, Clear Meas, Statistics
Waveform	Acquire	Acq Mode, Datalog, Zero Compensation
	Label	Channel, New Label, Apply New Label, Library, Reset Library, Annotation
	Display	Clear Display, Grid Intensity, Screen Layout, Phasor
File	Save/Recall	Save, Recall, Email, Defaults, Press to Save
	Print	Print to, Options, Palette, Network Setup, Press to Print
Tools	Utility	I/O, File Explorer, User Options, Service, Quick Action
	Quick Action	Action
	Analyze	Analysis, Source, Meas Window, CWA Setup
	Help	Getting Started, About IntegraVision
Math/Reference	Math	Display Math, Operator, Source 1, Source 2
	Ref	Display Ref, Source, Save to, Clear, Skew, Display Info
Vertical	1, 2, 3, 4	Signals, Coupling, Antialiasing, Current Input, Ranging, Filter
	Wiring (PA2201A)	Channel 1, Channel 2, Phase Names, Channel Skew
	Wiring (PA2203A)	Channel 1, Channel 2, Channel 3, Channel 4, Phase Names, Channel Skew
	Filter (PA2203A only)	Channel 1, Channel 2, Channel 3, Channel 4
	Phasor (PA2203A only)	Phasor Diagram, Source, Volts /, Amps /

2 Channel Configuration

Voltage and Current Signals

Channel Controls

Horizontal Controls

Auto Scale

Channel Skew

Channel Grouping

Voltage and Current Signals

Be sure to read and understand the important safety information at the beginning of the manual before proceeding.

Configure Voltage

1. Connect to the channel voltage inputs, shown below.



2. Press [1] or [2] (or [3] or [4] on the PA2203A) to open the channel menu. Then press **Ranging > Ranging Mode** and choose Fixed or Automatic ranging. Automatic ranging is generally recommended, because it chooses an appropriate measurement range based on the input signal level. Downranging is limited by the present display scale; for optimal range and display scale, press the **[Auto Scale]** key.
3. If you are using Fixed ranging, press **Voltage Range** and choose a measurement range.
4. The **Voltage HV** softkey will become available when the channel is AC coupled and measuring on a low, fixed range. If most of your signal is near the top of the range, you can enable this configuration to improve measurement resolution.

The instrument achieves the HV configuration by inserting an amplifier into the signal path and spreading the information content over more bits of the analog-to-digital converter. In the example below, enabling HV reveals the noise on the sine wave.

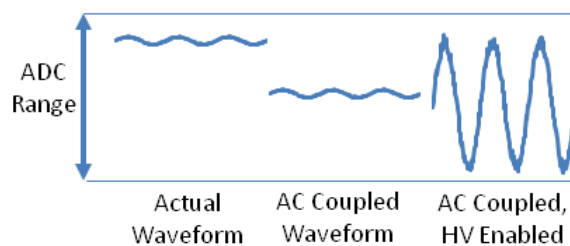

Configure an External Current Probe

The IntegraVision PA2200 Series power analyzers support several types of current probes, including external current shunts, current clamps, current transformers, Hall effect probes, Rogowski coils, and the Keysight N2780B, N2781B, N2782B, and N2783B current probes.

These current probes typically produce a voltage output proportional to the measured current. If your current probe produces a current output, you may route that output directly to an internal current shunt on the rear panel, or you may route the current through an appropriate resistor and use the voltage drop across the resistor as the input to the power analyzer's external current input.

Wiring Diagram

A typical wiring diagram for an external current probe is shown below.

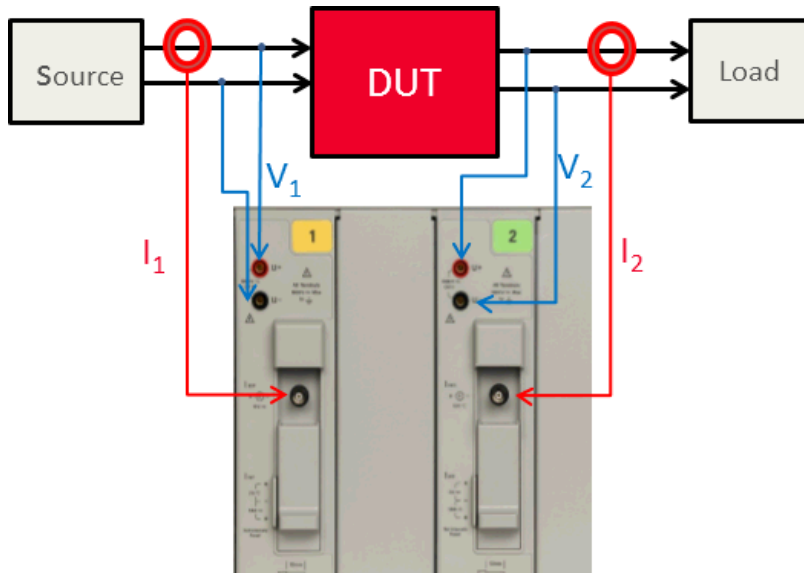

External Probe Configuration

To configure an external current probe:

1. Connect to the channel's external current probe input, shown below.



2. Press [1] or [2] (or [3] or [4] on the PA2203A) to open the channel menu. Then press **Current Input**.
3. Press **Current Ratio** and specify the current probe output ratio in V/A.
4. Press **Current Offset** and specify the current probe offset in Amps.
5. Press [Back] > **Ranging** > **Ranging Mode** and choose Fixed or Automatic ranging. Note that Automatic ranging choose a range such that the signal occupies approximately half the vertical height of the signal on the display.
6. If you are using Fixed ranging, press **Current Range** and choose a measurement range.
7. The **Ext Curr HV** softkey will become available when the channel is AC coupled and measuring on a low, fixed range. If most of your signal is near the top of the range, you can enable these softkeys to improve measurement resolution.

The instrument achieves this result by inserting an attenuation resistor into the signal path and spreading the information content over more bits of the analog-to-digital converter. In the example below, enabling HV reveals the noise on the sine wave.

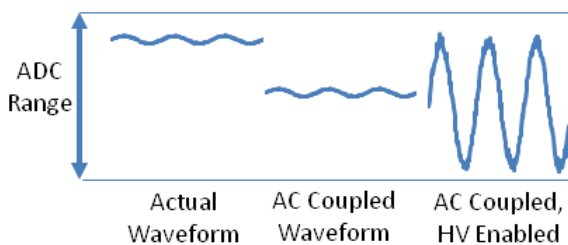

Note that when you calculate measurement uncertainty, you should refer to the probe's datasheet and add the probe's uncertainty to the measurement uncertainty of the power analyzer.

Configure an Internal Current Measurement

The power analyzer has 2-A and 50-A current shunts, only one of which should be wired at a time. The 2-A and 50-A values are rms values, with a crest factor up to 3. Use the green connectors that came with your instrument to connect to the current shunts.

When you use either the 2-A or 50-A internal shunt to measure current, firmly secure the connector in place with both terminal screws, as shown here. The torque setting is 1.7 to 1.8 Nm, and you should retorque the screws periodically. The retorque time period will vary according to your application and your environment.

Proper screw torque prevents accidental disconnection, which could cause safety issues. In addition, if the connector is not properly secured, contact resistance and voltage drop may vary.



WARNING

Use only the specified mating connector.

Do not use unspecified mating connectors, including mating connectors with strain reliefs such as the part shown below. Unspecified mating connectors could expose the user to hazardous voltages.

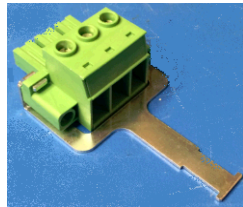

Wiring Diagram

A typical wiring diagram for an internal current shunt measurement is shown below.

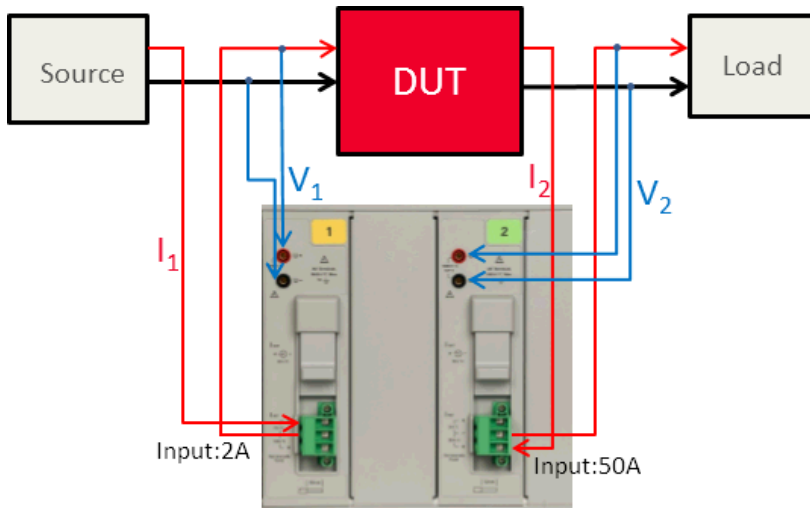

Internal Current Shunt Measurement Configuration

Connect to the channel's internal current shunt input, shown below. Use the three-pin connector (shown on channel 2) for either the internal 2-A (upper and middle pins) or 50-A (lower and middle pins) current shunts. Never connect to them simultaneously.

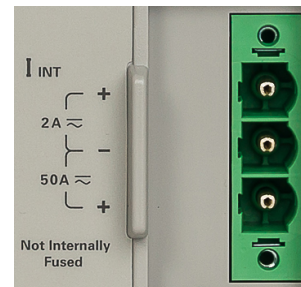

CAUTION

Internal Current Shunt Input Protection

Internal current shunt measurement paths are not fused. The user must provide current limit protection (fuse or breaker) and use appropriately sized wires. Currents exceeding 140% of the rated RMS currents may permanently damage the current measurement shunts. The 2-A shunt has internal protection to avoid damage due to miswiring, but the user should use the 50-A shunt when currents above 2 Arms are possible.

To configure a measurement using the internal shunt:

1. On the front panel, press [1] or [2] (or [3] or [4] on the PA2203A), then press **Current Input > Internal** to specify which shunt you are using (2-A or 50-A).

CAUTION

Confirm which shunt is being used.

To ensure that you measure the intended signals, before you do this step, confirm that the shunt in use on the rear panel matches this setting for each channel that uses the three-pin, green connector for current input. This prevents you from accidentally measuring a relatively small current signal that may appear on the unused shunt.

2. Press **Current Ratio** and specify the current probe's output ratio in A/A.
3. Press [Back] > **Ranging > Ranging Mode** and choose Fixed or Automatic ranging. Note that Automatic ranging choose a range such that the signal occupies approximately half the vertical height of the signal on the display.
4. If you are using Fixed ranging, press **Current Range** and choose a measurement range.
5. The **Int Curr HV** softkey will become available when the channel is AC coupled and measuring on a low, fixed range. If most of your signal is near the top of the range, you can enable these softkeys to improve measurement resolution.

The instrument achieves this result by inserting an attenuation resistor into the signal path and spreading the information content over more bits of the analog-to-digital converter. In the example below, enabling HV reveals the noise on the sine wave.

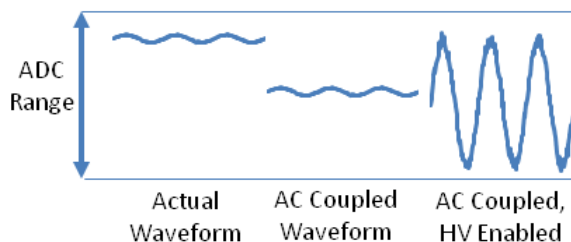

Note that when you calculate measurement uncertainty, you should refer to the probe's data sheet and add the probe's uncertainty to the measurement uncertainty of the power analyzer.

Channel Controls

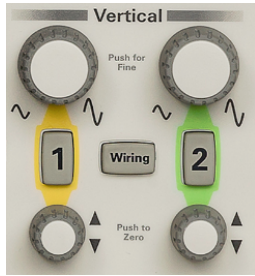

Overview

The [1] and [2] keys (the PA2203A also has [3] and [4] keys) enable channels and open the channel menus (channel 1 shown below); the knobs set the channels' vertical scale and position.

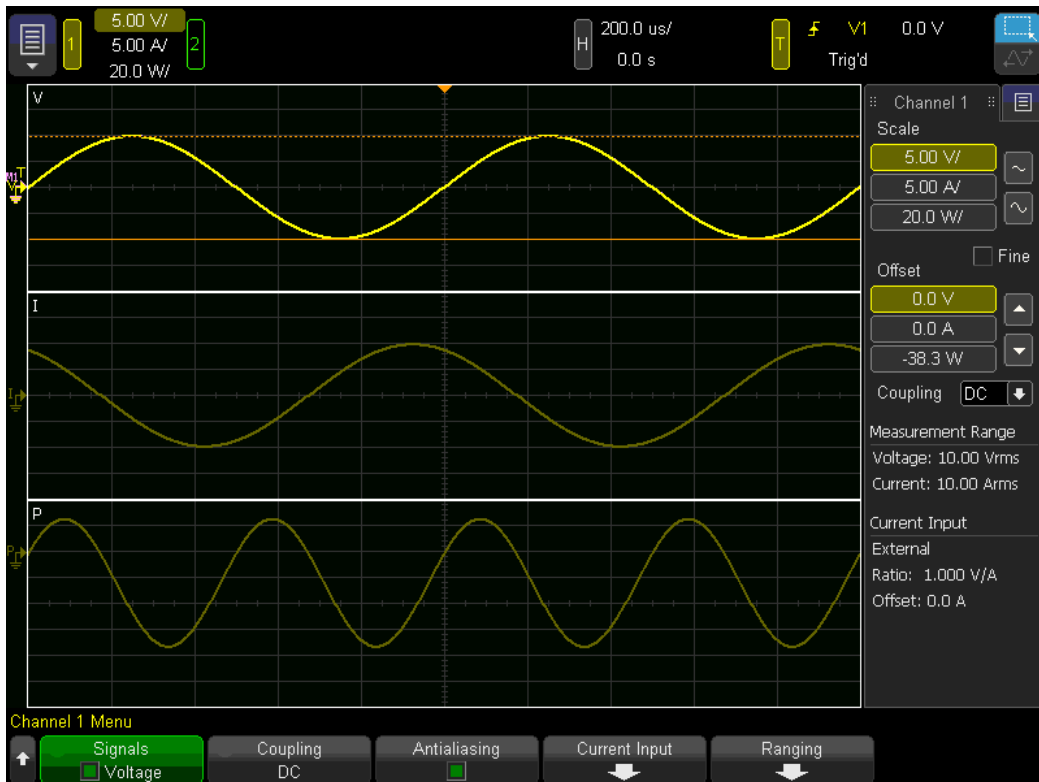

The ground level of the signal for each displayed signal is identified by the position of the icon at the far left side of the display.

To turn waveforms on or off

Press a channel key ([1], [2], [3], or [4]) to turn the channel on or off (and to display the channel's menu). When a channel is on, its key is illuminated. You can also turn channels on or off by pressing the channel number in the upper left corner of the screen.

From the channel menu, press **Signals** to indicate the waveforms to display.

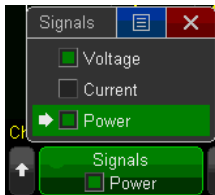

To adjust the vertical scale

Turn the large knob above the channel key marked to set the channel's vertical scale, which is displayed in the status line at the top of the display. For example, in the figure below, Channel 1 is on, with vertical resolutions of 5 V, 5 A, and 20 W per division. Channel 2 is off.

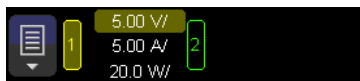

The vertical scale knob changes the signal's scale in a 1-2-5 step sequence unless fine adjustment is enabled. Push the channel's vertical scale knob (or press the channel key and then **Fine** in the sidebar) to toggle between fine and coarse adjustment.

The default mode for expanding the signal when you turn the vertical scale knob is vertical expansion about the channel's ground level; you can change this to expand about the center of the display. To set this preference, press [Utility] > **User Options** > **Preferences** > **Expand**.

To adjust the vertical position

Turn the small vertical position knob (↕) to move the channel's waveform up or down on the display. The offset value represents the difference between the vertical center of the display and the ground level (⚡) icon. It also represents the signal value at the vertical center of the display if vertical expansion is set to expand about ground (the default).

To adjust scale and offset with the touchscreen

You can also adjust the vertical scale and offset using the touchscreen. For example, below, the user has touched the 2.00 A/ indicator at upper left to open the Channel 1 sidebar on the right. You can use this sidebar to configure the channel's scale, offset, and coupling.

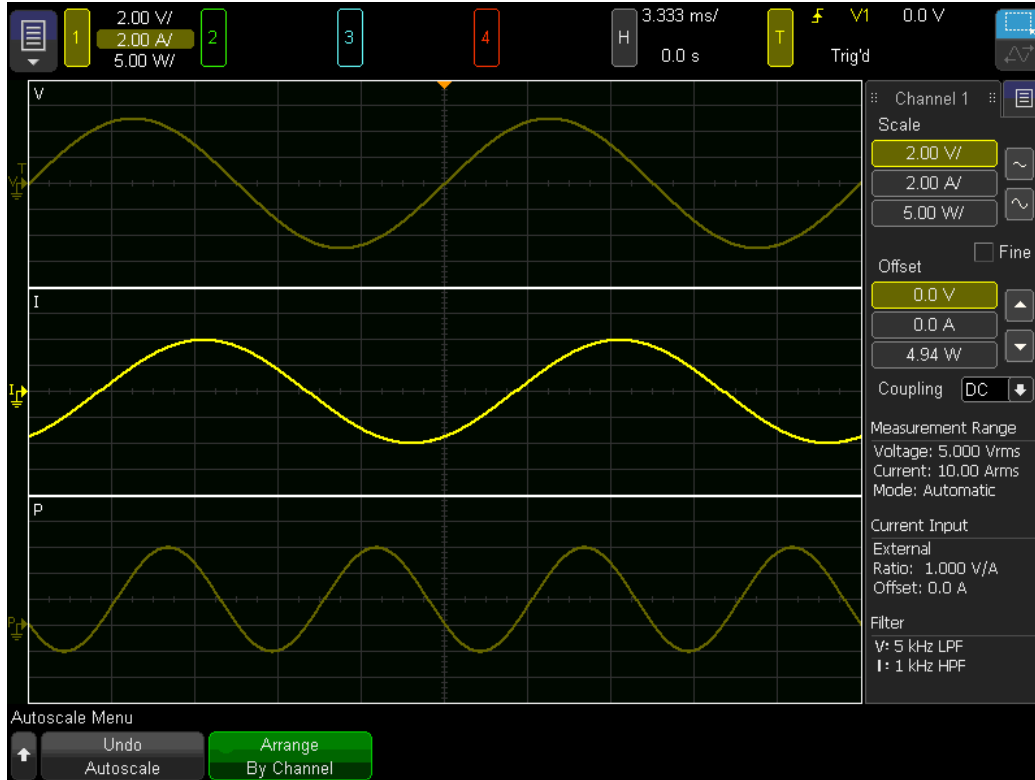

To specify channel coupling

You can specify each channel's input coupling as AC or DC. If the channel is DC coupled, you can quickly measure the DC component of the signal by simply noting its distance from the ground symbol. If the channel is AC coupled, the DC component of the signal is removed, allowing you to use greater sensitivity to display the AC component of the signal.

To configure coupling, press [1] or [2] (or [3] or [4] on the PA2203A), and then use the **Coupling** softkey to make your selection.

To enable antialiasing

Aliasing can occur when the instrument's sampling rate is less than twice as fast as the waveform's highest frequency component. When enabled (default) the Antialiasing softkey switches a 100-kHz, low pass filter into the analog measurement front end before signals are digitized. This reduces aliasing by reducing the signal's frequency content above the instrument's sample rate that reaches the analog to digital converter.

To filter incoming signals

You may choose to apply a filter to an incoming waveform to remove unwanted frequency content. On the PA2203A, the **[Filter]** key is located between channels 2 and 3 on the front panel. On the PA2201A and the PA2203A, you can access the Filter menu by pressing a channel key (such as **[1]** or **[2]**) and then the **Filter** softkey.

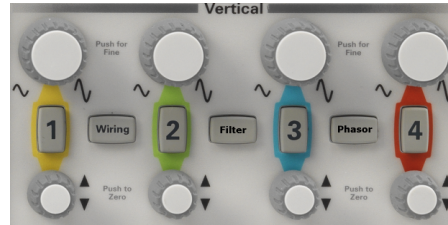

The Filter Menu is shown below. The word OFF means that no current or voltage filter is applied.



If you have defined a wiring group of two or three channels, the group itself will replace those channels in the Filters Menu:



Each channel softkeys leads to a menu similar to the one shown below.



For each voltage or current signal, you can select a high-pass filter, a low-pass filter, or no filter. For low pass filters, the listed frequencies represent the nominal 3-dB cut-off frequency of the respective filter. For high pass filters, the listed frequencies represents the nominal 3-dB cut-in frequency of the respective filter.

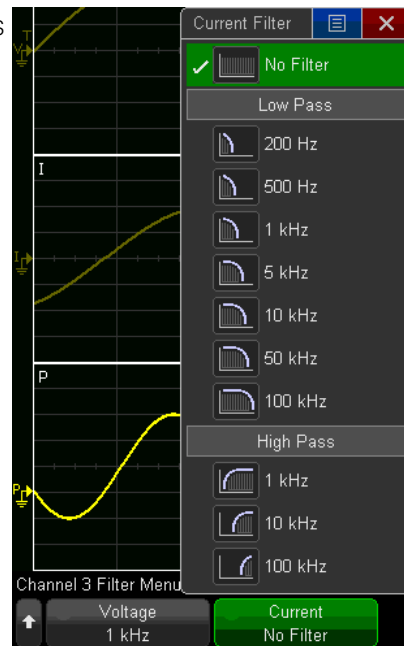

If you have applied a voltage filter, current filter, or both, the word ON appears on the softkey label:



The filter values appear in the bottom of each channel's sidebar:

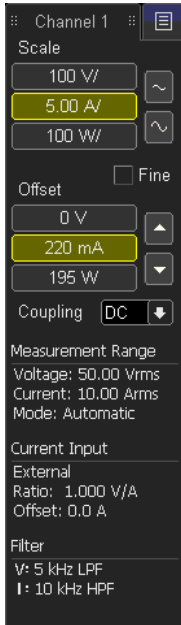

Horizontal Controls



The horizontal controls include:

- The horizontal scale and position knobs
- The [Horiz] key for accessing the Horizontal Menu
- The zoom key - functionality reserved for future release
- The [Navigate] keys for navigating search events

This figure shows the Horizontal Menu that appears after you press [Horiz].

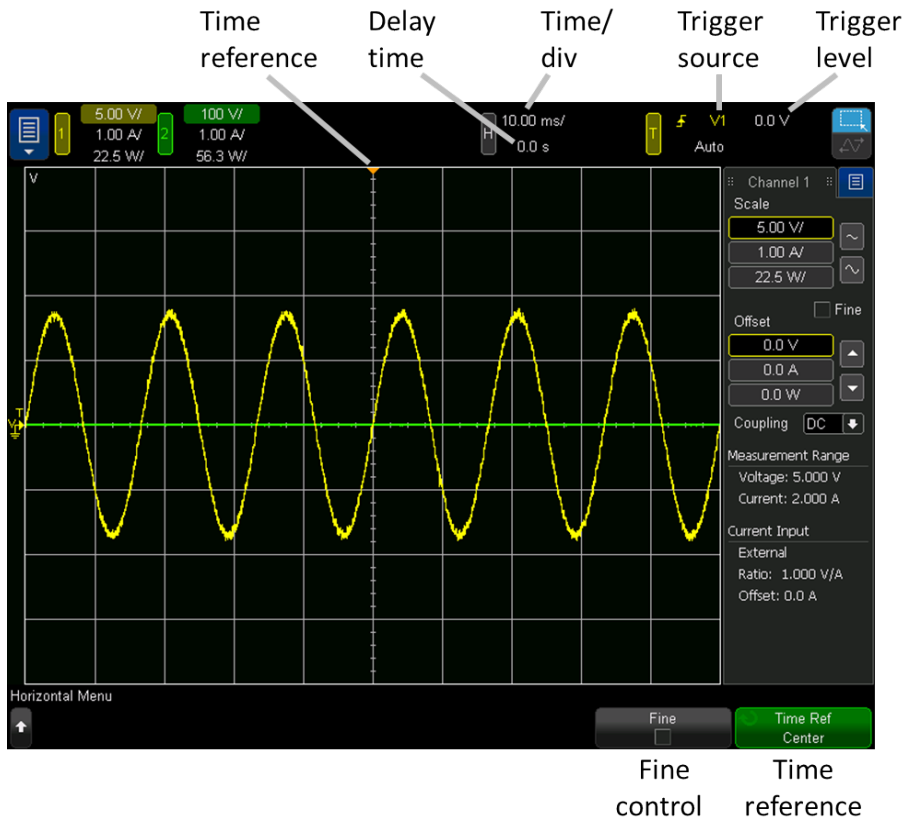

Fine control Time reference

To adjust the horizontal (time/div) scale

Turn the large knob marked  to change the horizontal time/div (sweep speed) setting. You can also make this adjustment using the touchscreen. For example, in the image below, the user touched the **200.0 us/** indicator to open the horizontal scale and delay dialog. The time/div information in the status line changes when you adjust the scale.

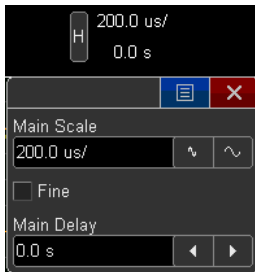

The horizontal scale knob works with both running and stopped acquisitions. When running, adjusting the horizontal scale knob changes the sample rate. When stopped, adjusting the horizontal scale knob lets you zoom into acquired data.

To adjust the horizontal delay (position)

Turn the horizontal delay (position) knob () to set a nonzero delay, or push the horizontal delay knob to reset the delay to zero. The trigger point moves horizontally, pausing at 0.00 s (mimicking a mechanical detent), and the delay value is displayed in the status line. You can also make this adjustment by dragging the waveform horizontally on the touchscreen or by entering the Main Delay as shown in the previous section.

Changing the delay time moves the trigger point (solid inverted triangle) horizontally and indicates how far it is from the time reference point (hollow inverted triangle). These reference points are indicated along the top of the display grid.

Events to the left of the trigger point happened before the trigger and are called pretrigger events. Everything to the right of the trigger point is posttrigger information. The range of permissible delay values depends on the time/div selected.

The horizontal position knob works with both running and stopped acquisitions.

To pan and zoom acquisitions

When the instrument is stopped, use the horizontal scale and position knobs to pan and zoom the most recent acquisition. Waveform memory is limited to the display.

The ability to pan (move horizontally) and scale (expand or compress horizontally) an acquired waveform is important because it can reveal insight about the captured waveform by displaying the waveform at different levels of abstraction. You may view both the big picture and details.

The instrument allows you to examine an acquired waveform. You can measure with cursors or print the screen. You can also further examine the acquired signal's details by panning through the waveform and changing the horizontal scale.

There is no limit on the scaling ratio between the time/div used to acquire the data and the time/div used to view the data. There is, however, a useful limit, which depends on the signal itself. Remember that you can only make automatic measurements on displayed data.

To change the horizontal scale knob's coarse/fine adjustment setting

Push the horizontal scale knob (or press **[Horiz] > Fine**) to toggle between fine and coarse adjustment. When **Fine** is enabled, the Horizontal scale knob changes the time/div (shown at the top of the display) in smaller increments. The time/div remains fully calibrated when Fine is on. When **Fine** is disabled, the Horizontal scale knob changes the time/div setting in a 1-2-5 step sequence.

To position the time reference (left, center, right)

Time reference is the reference point on the display for delay time (horizontal position). To adjust the time reference, press **[Horiz] > Time Ref**. Then select **Left**, **Center**, or **Right**.

A small hollow triangle (∇) at the top of the display grid marks the position of the time reference. When delay time is set to zero, the trigger point indicator (\blacktriangledown) overlays the time reference indicator.

The time reference position sets the initial position of the trigger event within acquisition memory and on the display, with delay set to 0. Turning the Horizontal scale (sweep speed) knob expands or contracts the waveform about the time reference point (∇).

Turning the Horizontal position ($\blacktriangleleft\blacktriangleright$) knob moves the trigger point indicator (\blacktriangledown) to the left or right of the time reference point (∇).

Auto Scale

Overview

The **[Auto Scale]** key is located in the Run Control section of the front panel.

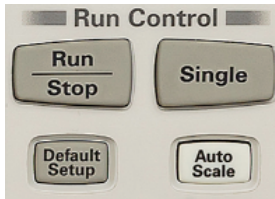

Press **[Auto Scale]** to best display all voltage, current, and power signals that are currently displayed.

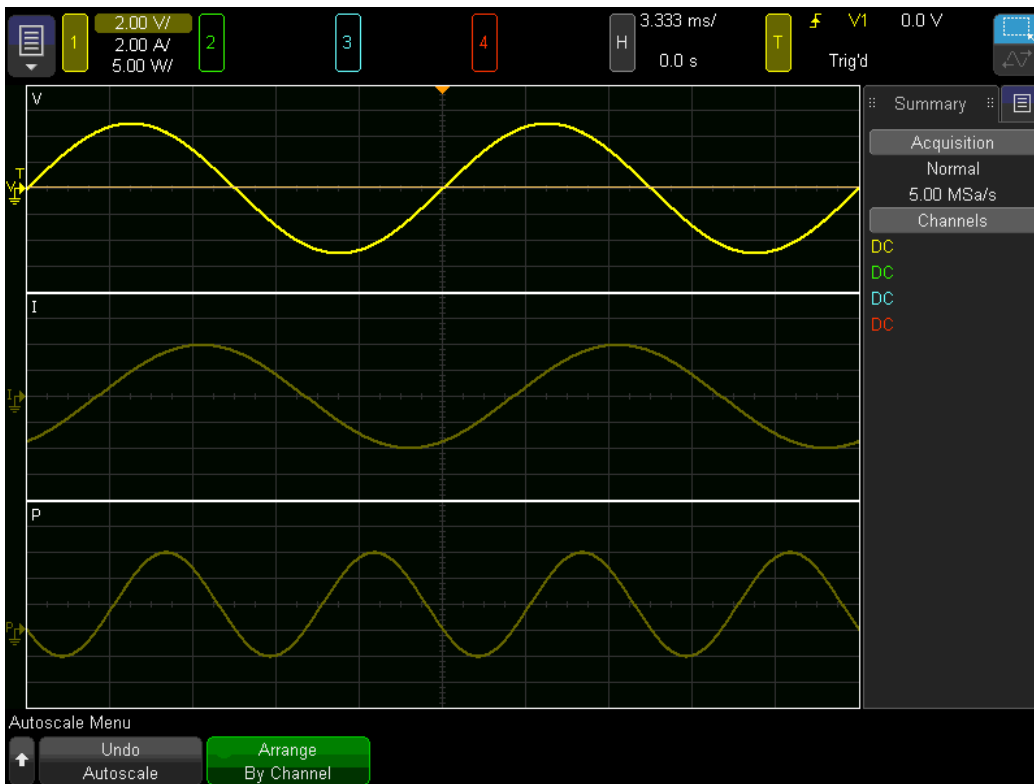

Press **Undo Autoscale** to return to the instrument's previous settings.

Use the second softkey to choose how traces for signals in wiring groups are arranged and automatically perform an autoscale. The image below shows traces arranged by channel.



The image below shows the traces arranged by group. Note that all voltages are set to the same vertical scale, based on the largest voltage. This scaling principle also applies to current and power, and it enables you to quickly detect imbalances across channels. If a signal is relatively small, you always have the option to select the appropriate channel and adjust its scale individually.

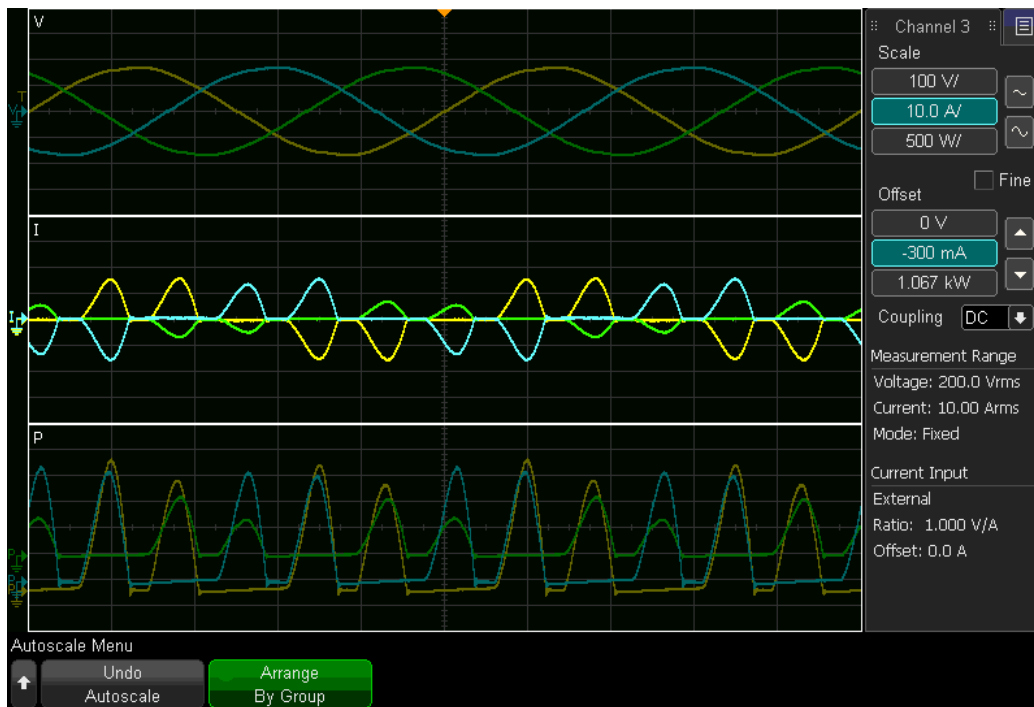

How [Auto Scale] Works

The **[Auto Scale]** key turns off all math waveforms, reference waveforms, and power analyses. It then executes the following procedure to autoscale only those waveforms currently showing on the display:

1. The instrument selects the appropriate hardware measurement range for each signal.
2. The instrument selects the vertical scale and offset for each signal.
3. The instrument analyzes the signals in the following order to determine whether they have frequency content: V1, V2, I1, I2, P1, P2. If one or more of these signals is displayed and has frequency content, the instrument sets the horizontal timebase to display approximately two cycles of the first displayed signal with frequency content.
4. If a signal with frequency content was identified in the previous step, the instrument configures the trigger to use the signal that defined the timebase to also define the trigger level. The trigger level is set halfway between the signal's minimum and maximum values. If no such signal was identified, the instrument sets the trigger mode to Autotrigger.
5. The instrument sets the horizontal offset (delay) to 0.

After all of these steps have completed, the instrument sets the CWA Sync Offset for V1, V2, I1, and I2, regardless of whether these signals are displayed.

The results of autoscaling are shown below.

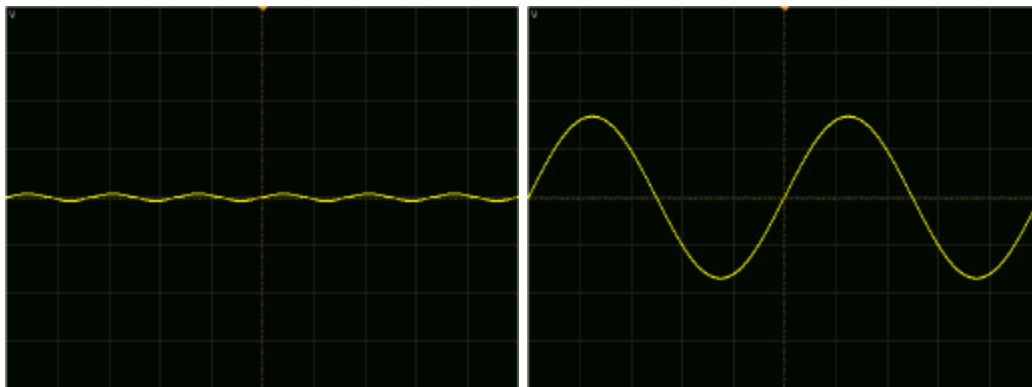

Before Autoscale

After Autoscale

Channel Skew

Your test setup may introduce signal propagation delays. For example, a current transducer or cable length differences may cause a delay. To compensate for these delays, you can set a skew value up to $\pm 10 \mu\text{s}$ with 1-ns resolution for the current and voltage on each channel.

The value you enter for skew indicates the amount by which you wish to move the signal in time. For example, suppose you wish to align the signals shown below. You could either enter a positive skew for the bottom signal or a negative skew for the top.

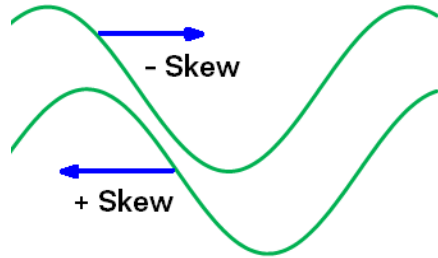

To specify channel skew:

1. Press **[Wiring] > Channel Skew**.

This opens the Channel Skew menu, below.



2. Press the **Channel** softkey and select the channel to adjust.
3. Press **Voltage Skew** and set the skew for the channel's voltage signal.
4. Press **Current Skew** and set the skew for the channel's current signal.

Repeat this process for each channel that you wish to adjust.

Note that the **Reset Skew** softkey resets the skew values to 0 only on the selected channel. The skew setting is not affected by **[Default Setup]** or **[Auto Scale]**.

Channel Grouping

You can group adjacent channels together for various applications, including three-phase measurements. Press **[Wiring]** to open the menu shown below.



Each softkey has a value of the form #P-#W-#M, where the # symbols indicate the numbers of phases (1 or 3), wires (2, 3, or 4), and meters (1, 2, or 3). For example, 1P-2W-1M indicates the default value of one phase, two wires, and one meter.

When you group channels, the scale and offset values at the top of the display indicate the grouping. For example, in the image below, channels 1, 2, and 3 are in group A. Note that you can still set scale and offset values for individual channels within a group.



From the Wiring Menu, press a softkey for a particular channel to open the popup menu shown here. Then choose a wiring group from the list.

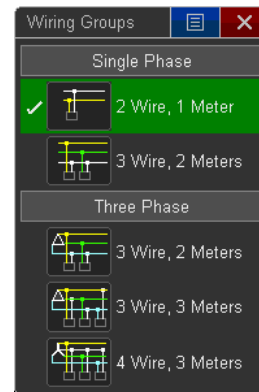

Note that the 3 Wire, 3 Meters and 4 Wire, 3 Meters choices are not available on the PA2201A.

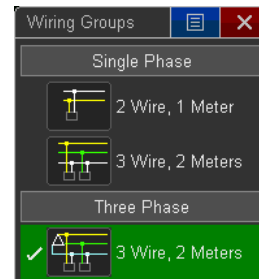

Here, the second softkey is 3P-4W-3M. Channels 2 through 4 are L1, L2, and L3, respectively.

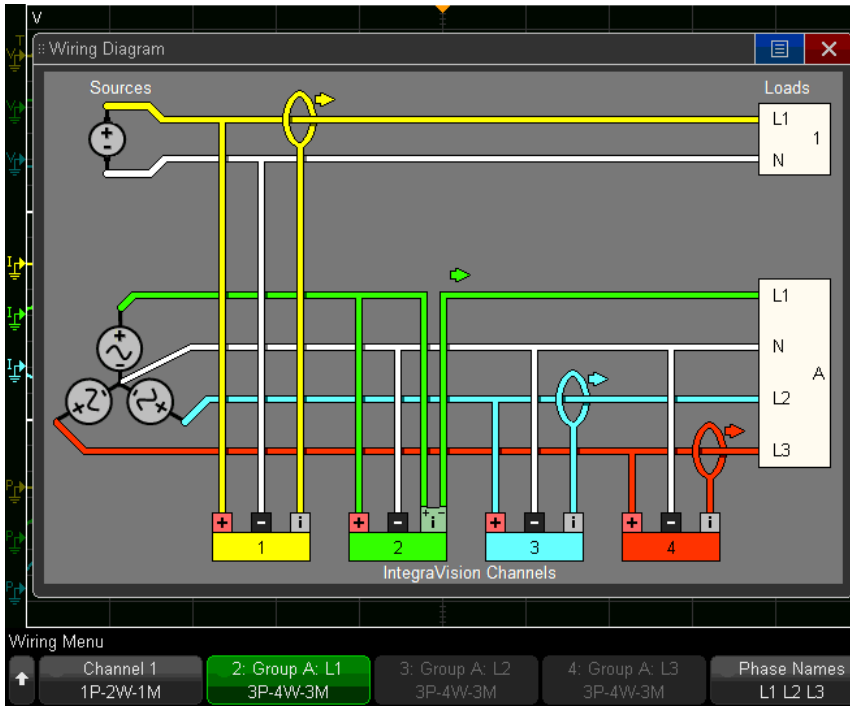

If, instead, the softkey for channel 1 had been set to 3P-4W-3M, then channels 1 through 3 would equate to lines 1 through 3, respectively, as shown below.

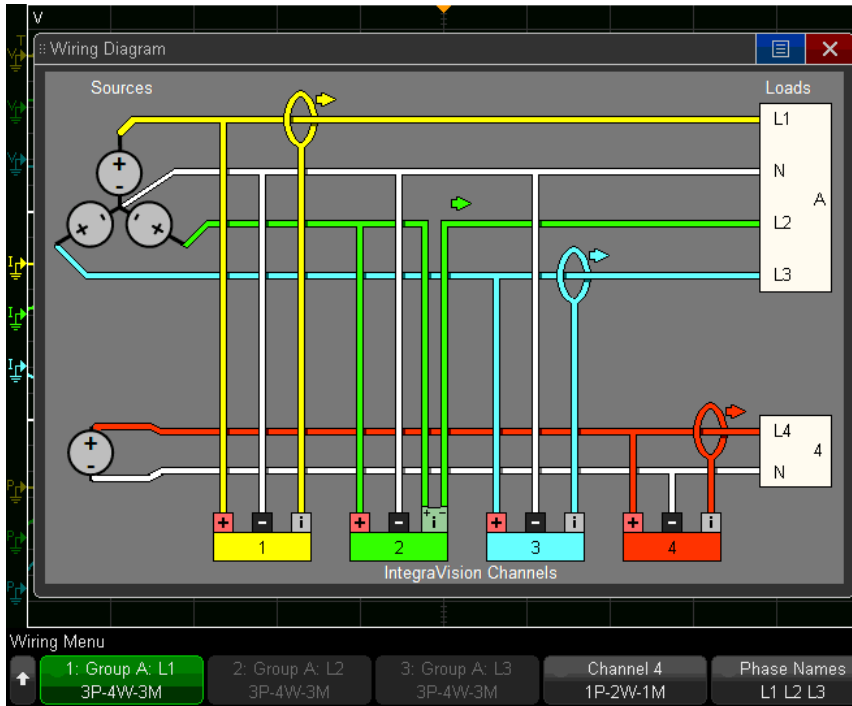

On the PA2201A, the wiring diagram only shows two channels, as shown below.

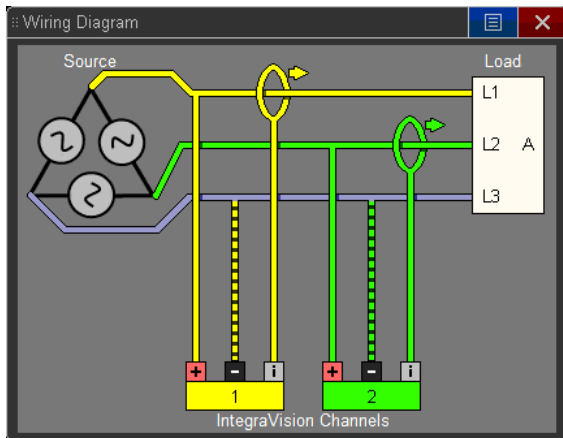

Phase Names

Some users prefer not to use the L1/L2/L3 terminology. You can press the **Phase Names** softkey to choose the naming convention that you prefer.

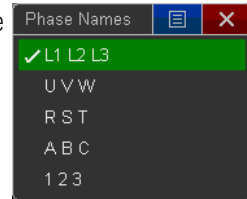

The wiring diagram below uses the R/S/T convention.

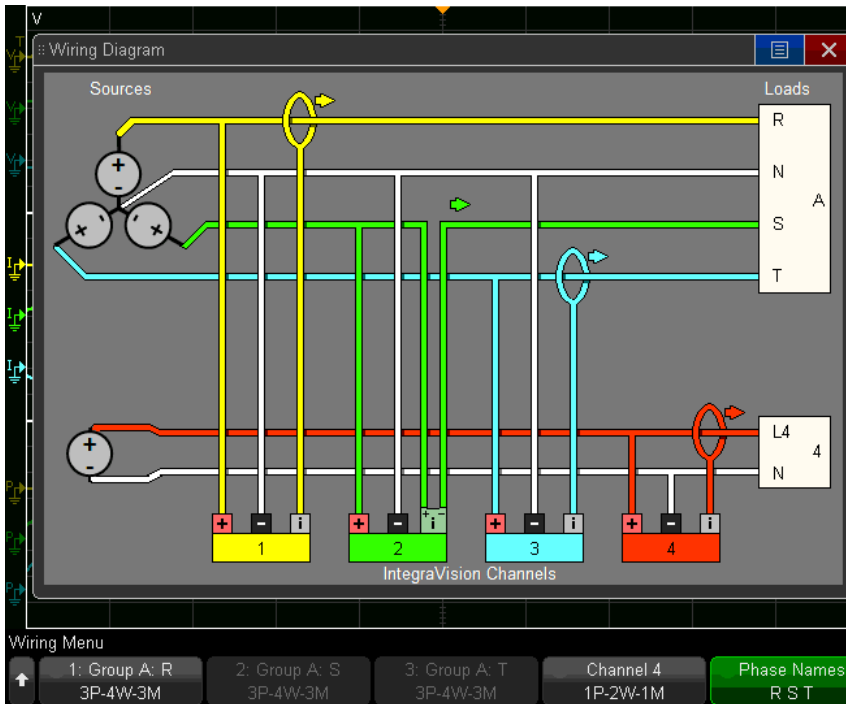

3 Customizing the Display

Display Settings

Labels and Annotations

Phasor Diagram

Display Settings

To specify which signals are displayed

To specify which signals are displayed, press [1] or [2] (or [3] or [4] on the PA2203A) and then press the **Signals** softkey. Then use the checkboxes to select which signals you want to display.

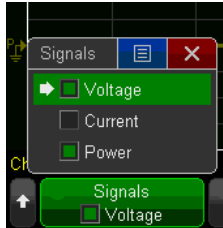

Press [Display] > **Screen Layout** to select one of eight ways to position the signals.

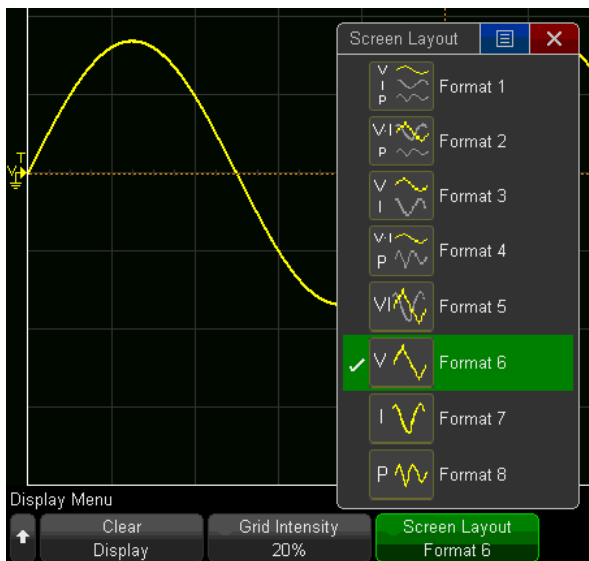

To clear the display

To clear the display, press [Clear Display], or press [Display] > **Clear Display**.

To adjust the waveform intensity

Press the very small circular [Intensity] key in the lower left corner of the Waveform section.



Use the knob above it to adjust the waveform intensity on a scale from 0 to 50.

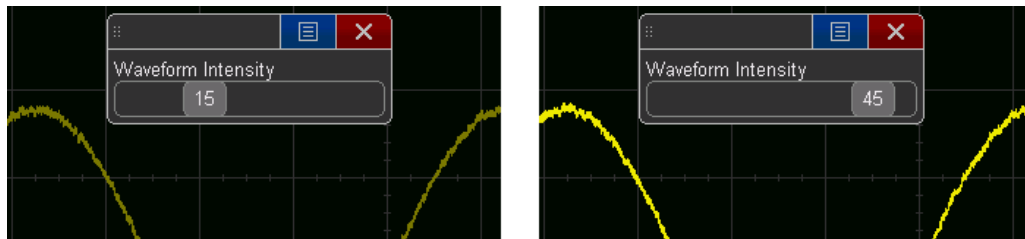

To adjust the grid intensity

To adjust the display grid intensity from 0 to 100%, press [Display] > Grid Intensity and turn the Entry knob. The images below show the grid intensity at 20% and 70%.

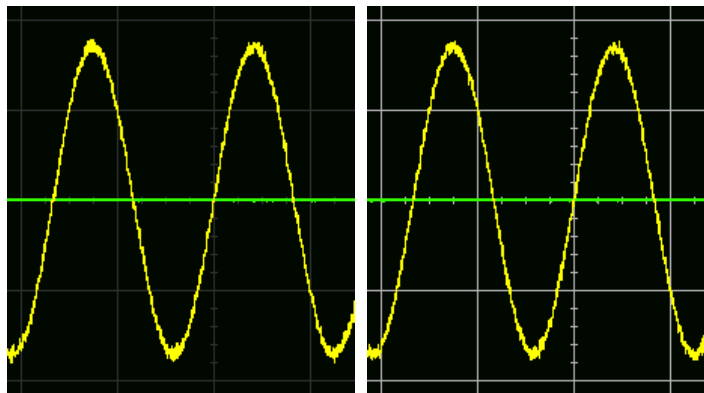

The grid lines correspond to the vertical and horizontal sensitivity settings shown at the top of the display. As shown below, the signal channels may have different vertical scales, but there is just one horizontal scale.



Labels and Annotations

You can create and display labels for each voltage, current, and power channel. Press **[Label]** to show or hide the channel labels at the left.

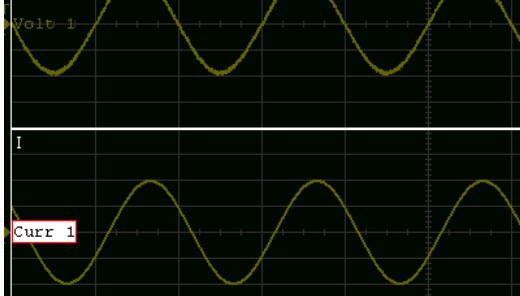

To assign a label to a channel

1. Press **[Label]** > **Channel** and select a channel to label. The default channel labels are shown below. The channel does not have to be turned on to have a label assigned, but if the channel is turned on, its label will be highlighted.

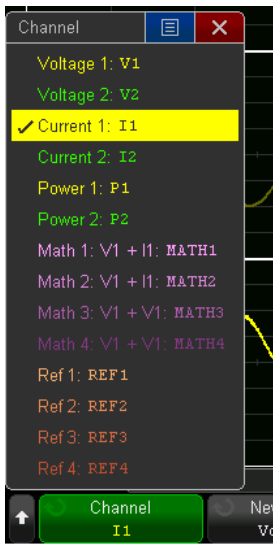

2. To select an existing label, press **Library**, then turn the **Entry** knob or repeatedly press **Library** to select a label. To create a new label (and add it to the library), press **New Label**, enter the label text, and press **OK**.
3. Press **Apply New Label** to assign the label to the selected channel.

Label Assignment Auto-Increment

New labels are added to the nonvolatile label list. When you assign a label ending in a digit, such as VOLT1 or Power_1, the instrument automatically increments the digit and displays the modified label in the "New label" field after you press **Apply New Label**. Therefore, you only need to select a new channel and press **Apply New Label** again to assign the label to the channel. Only the original label is saved in the label list.

To load a list of labels from a text file

You can load up to 75 labels from a text file into the instrument. Labels are added to the beginning of the instrument's list; if more than 75 labels are loaded, only the first 75 are stored.

1. Use a text editor to create a list of labels up to ten characters long, one label per line.
2. Save the file on a USB drive as `labellist.txt`.
3. Press **[Utility] > File Explorer**, select the file, and press **Load** to load the list into instrument.

NOTE Label List Management

Press **Library** for a list of the last 75 labels used (not counting duplicates). Labels can end in trailing digits, and if the base string matches an existing label, the new label will not be put in the library. For example, if label A0 exists, you cannot create a new label called A123.

A new label replaces the oldest (least recently assigned to a channel) label in the list. Over time, your user-defined labels will predominate over the instrument's default labels.

Resetting the label library (see below), permanently deletes all of your custom labels and returns the label list to its factory configuration.

To reset the label library to the factory default

To delete all user-defined labels and set the labels in the library back to the factory default, press **[Label] > Reset Library**. This does not default the labels currently assigned to the channels appearing in the waveform area.

NOTE Defaulting labels without erasing the default library

Pressing **[Default Setup]** sets all channel labels back to the default labels but does not erase the list of user-defined labels in the library. The **Factory Default** softkey under the **[Default Setup]** menu does erase the user-defined labels in the library.

To add an annotation

You can add annotations to the display for documentary purposes before capturing screens.

1. Press **[Label] > Annotation**.
2. In the Annotation Menu, press **Annotation** to enable the annotation. Then use the touchscreen to drag the annotation as desired.
3. Press **Edit** and enter text using the touch screen or the **Entry** knob.

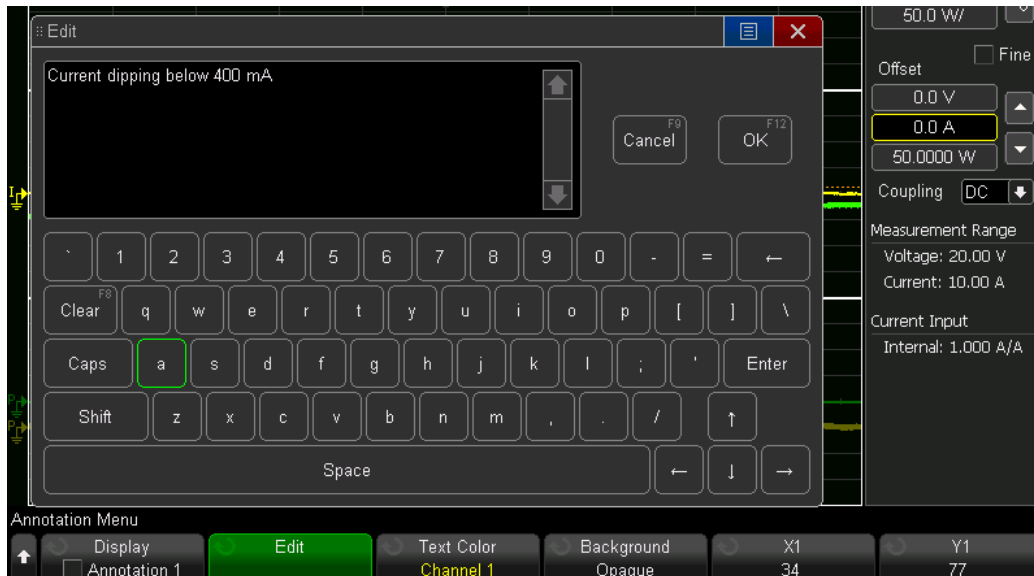

4. Select the dialog's **Enter** or **OK** key again. The annotation text appears in the softkey as shown below.



5. Press **Text Color** and select the annotation color. You can choose white, red, or colors that match channels 1 and 2, math waveforms, or reference waveforms.
6. Press **Background** and select the annotation background (opaque or inverted).

See Also

[Saving Setups, Screen Images, or Data](#)

[Print \(Screens\)](#)

Phasor Diagram

The instrument's phasor diagram can show various measurements and phase relationships.

Displaying the phasor diagram

On the PA2203A, press the **[Phasor]** key (between channels 3 and 4 on the front panel) to display the phasor diagram.

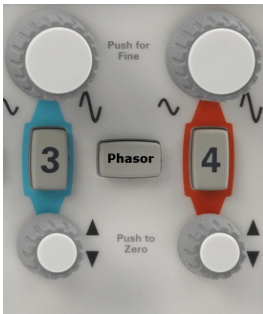

On the PA2201A or the PA2203A, you can press **[Display] > Phasor**, or you can use the blue menu symbol in the upper left corner of the display.

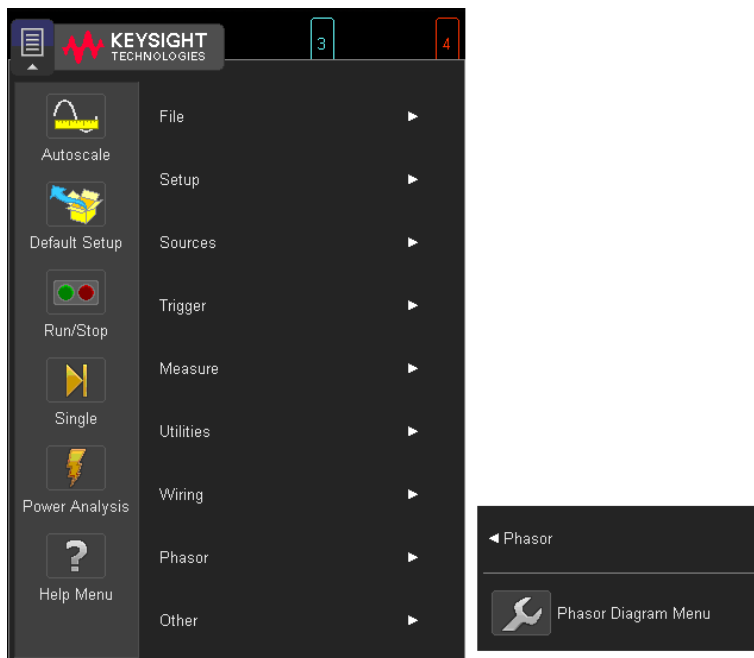

Phasor diagram interpretation

The phasor diagram appears as shown below. Here, the **Source** softkey is set to Group A.

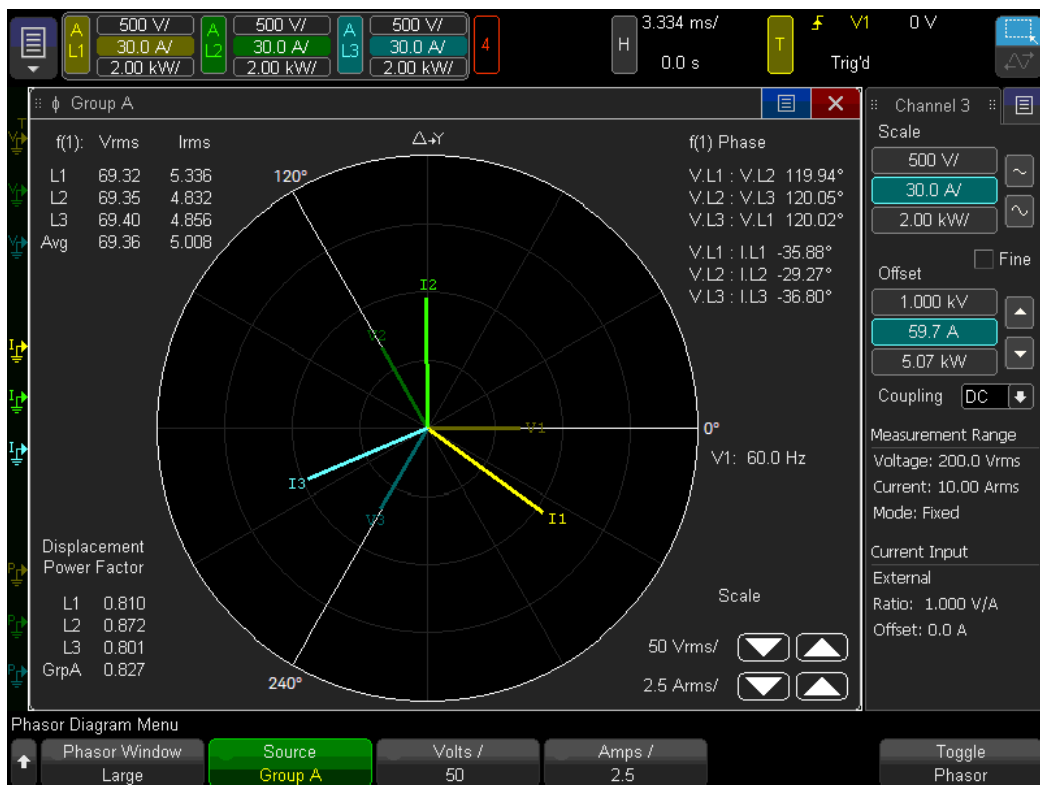

The horizontal axis of the phasor diagram (0 degrees) is defined as the phase of the voltage signal in the first channel in a wiring group, or the voltage signal of the selected channel if that channel is not part of a wiring group. All other phasors are shown in relationship to that.

The phasor diagram is based on FFT analysis, which provides the fundamental frequency of the voltage that defines 0 degrees. This frequency is displayed to the right of the plot. The magnitude and phase shift of the other voltage and current signals are then computed at this fundamental frequency to derive the phasors shown on the plot and the calculated values surrounding it. If the current phasor is found clockwise from the voltage phasor, the current lags the voltage, indicating a primarily inductive circuit. If the current phasor is found counterclockwise from the voltage phasor, current leads voltage, indicating a capacitive circuit.

NOTE When a channel is grouped into a delta wiring group (3P-3W-3M or 3P-3W-2M), the instrument uses the line to neutral voltage of that channel for the phasor diagram.

Calculated values

The calculated values surrounding the polar circle vary by Source, but all of them are similar to, or simpler than, the shown above. The upper left corner shows the rms values of the fundamental (first harmonic) of the current and voltage on each line. The upper right shows the phase angle between each line pair and the angle between voltage and current on each line. The lower left shows the displacement power factor for each line. This is the cosine of the angle between the voltage and current at the fundamental frequency.

Phasor diagram configuration

The softkeys associated with the phasor diagram allow you to specify the source for the phasor diagram and to configure the appearance of the phasor diagram.



Phasor Window

Use the Phasor Window softkey to adjust the size of the phasor diagram on the screen.

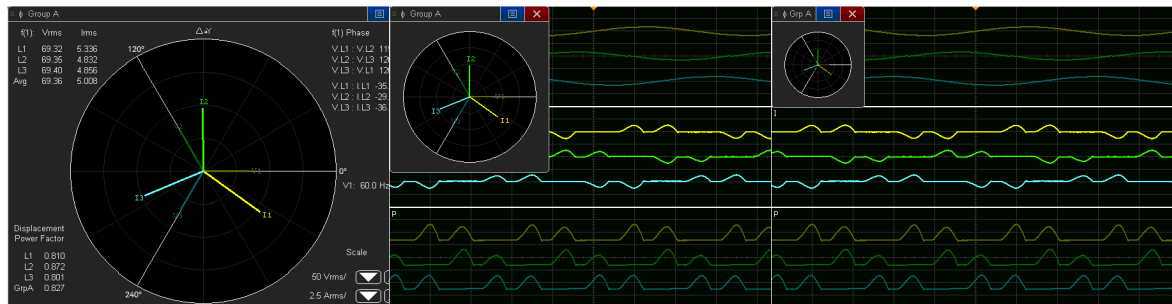

Phasor Window Large

Phasor Window Medium

Phasor Window Small

Use the **Volts /** and **Amps /** softkeys or the arrows in the lower right corner of the phasor diagram to lengthen or shorten the phasors. If the phasor would extend beyond the polar circle, the phasor will end at the circle, so it is a good practice to leave a small bit of margin at the end to verify that the phasor does not exceed the circle.

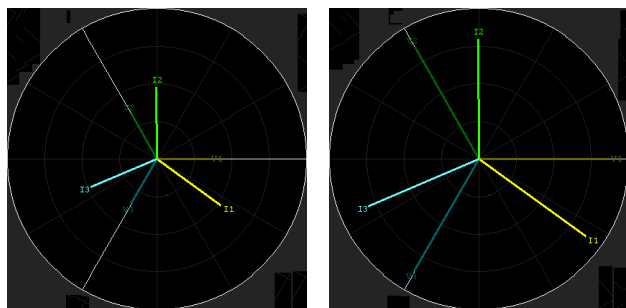

50 Volts / and
2.5 Amps /

20 Volts / and
1.5 Amps /

4 Configuring the Instrument

I/O Interface Settings

Web Interface

User Options

The **[Quick Action]** Key

I/O Interface Settings

You can communicate with the instrument via its rear-panel LAN port or USB device port. There are no USB configuration settings, and LAN configuration is described below. Both interfaces are always enabled, and you can control the instrument via both interfaces simultaneously.

Configuring the LAN Connection

After you connect the instrument with a LAN cable, you can configure the LAN connection and set up network printers. You can also use the instrument's **Web interface** to view its network configuration.

Automatic LAN Configuration

1. Press **[Utility] > I/O > LAN Settings > Config**.
2. Turn the **[Entry]** knob to select Automatic, and press the softkey again to enable it.

If your network supports DHCP or AutoIP, enabling Automatic lets the instrument use those services to get its LAN configuration settings.

3. If your network provides Dynamic DNS, you can enable the Dynamic DNS option to let the instrument register its hostname and use the DNS server for name resolution.
4. You can enable the Multicast DNS option to let the instrument use Multicast DNS for name resolution on small networks without a conventional DNS server.
5. Connect a LAN cable between the LAN and the rear-panel LAN port.

If the instrument does not automatically connect to the network within a few moments, press **[Utility] > I/O > LAN Reset**. In a few moments the instrument will connect to the network.

Manual Configuration

1. Obtain the instrument's network parameters (hostname, IP address, subnet mask, gateway IP, DNS IP, etc.) from your network administrator.
2. Press **[Utility] > I/O > LAN Settings > Config**.
3. Turn the **[Entry]** knob to select Automatic, and press the softkey again to disable it.

If Automatic is not enabled, the instrument's LAN configuration must be set up manually using the Modify and Host name softkeys

4. Configure the instrument's LAN interface:
 - a. Use the **Modify** softkey (and the other softkeys and keypad entry dialogs) to enter the IP Address, Subnet Mask, Gateway IP, and DNS IP values.
 - b. Press the **Host name** softkey and use the keypad entry dialog to enter the Host name.
 - c. Press **Apply**.

NOTE

Modifying the host name breaks the instrument's LAN connection. You must re-establish communication using the new host name.

5. Connect a LAN cable between the LAN and the rear-panel LAN port.

Standalone (Point-to-Point) Connection to a PC

To establish a point-to-point (standalone) connection between the instrument and a PC:

1. Press **[Utility] > I/O > LAN Settings > Config**.
2. Enable the **Automatic** checkbox.
3. Connect your PC to the instrument with a standard LAN cable.
4. Cycle instrument power. Then press **[Utility] > I/O** and wait until the LAN status shows "configured." The instrument is now connected to the PC.

Web Interface

When the instrument is on the LAN, you can use its built-in Web server to:

- View information such as model number, serial number, host name, IP address, and VISA (address) connect string.
- Control the instrument using the Remote Front Panel.
- Capture screen images from the browser.
- Identify an instrument via a displayed message or a blinking front-panel light.
- Print any page in the Web interface from the Print Page tab.
- Save files to your PC and recall files from your PC to your power analyzer.

The Web interface provides help for each of its pages. Microsoft Internet Explorer is recommended for running the Web interface, and other Java-enabled browsers may also work.

To access the Web interface

1. Connect the instrument to your LAN or connect directly to your PC (see [I/O Interface Settings](#)).
2. Type the instrument's hostname or IP address into the Web browser's address bar. The Welcome Page appears.

Welcome to your

Web-Enabled Power Analyzer PA2201A

Information about this Web-Enabled Instrument

Instrument	PA2201A Power Analyzer
Serial Number	LP2VMSI129
Description	Keysight PA2201A IntegraVision - LP2VMSI129
DNS Hostname	156.140.95.80
NetBIOS Name	k-pa2201a-52778
Multicast DNS Hostname	mDNS Disabled
IP Address	156.140.95.80
VISA TCP/IP Connect String	TCPIP0::156.140.95.80::INSTR

Advanced information Identification: off on

Navigation Tabs: Welcome Page, Browser Web Control, Get Image, Print Page, Help with this Page

Identification Function

The Welcome page includes an **Identification on** radio button, shown in the lower right corner of the image above. This feature can help you locate a specific instrument in a group or rack.

When the Identification on radio button is selected, the instrument displays An IDENTIFY message, as shown below. To proceed, either select Identification off radio button on the Welcome Page or press the red X on the displayed message box.

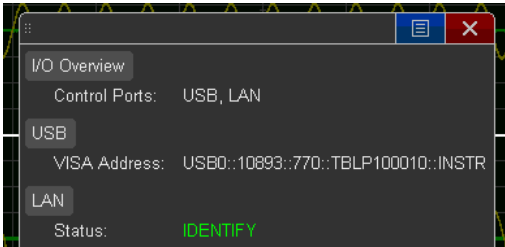

Browser Web Control

The web interface's Browser Web Control page lets you access the Remote Front Panel, shown below. Be sure to read and understand the warning on the screen.

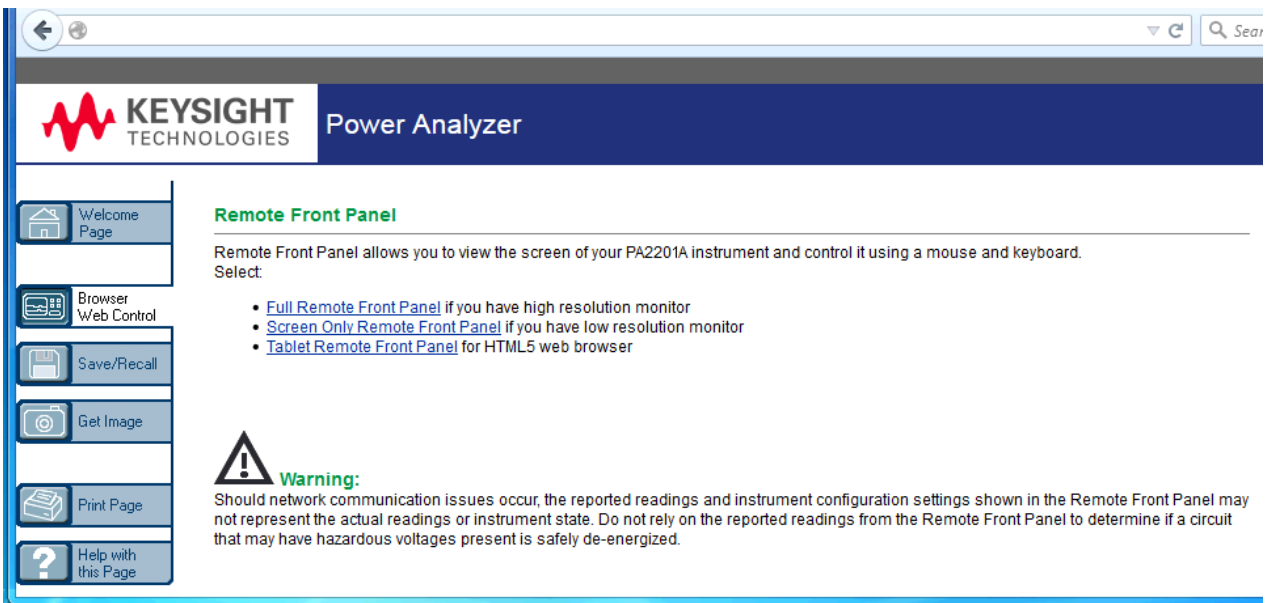

The Full Remote Front Panel option opens a window that contains an image of the front panel, including the knobs and keys. You can click on the keys, knobs, and display elements to run the instrument just as you would from the front panel. The PA2201A version is shown below; the PA2203A version also has channels 3 and 4 and the [Filter] and [Phasor] keys.

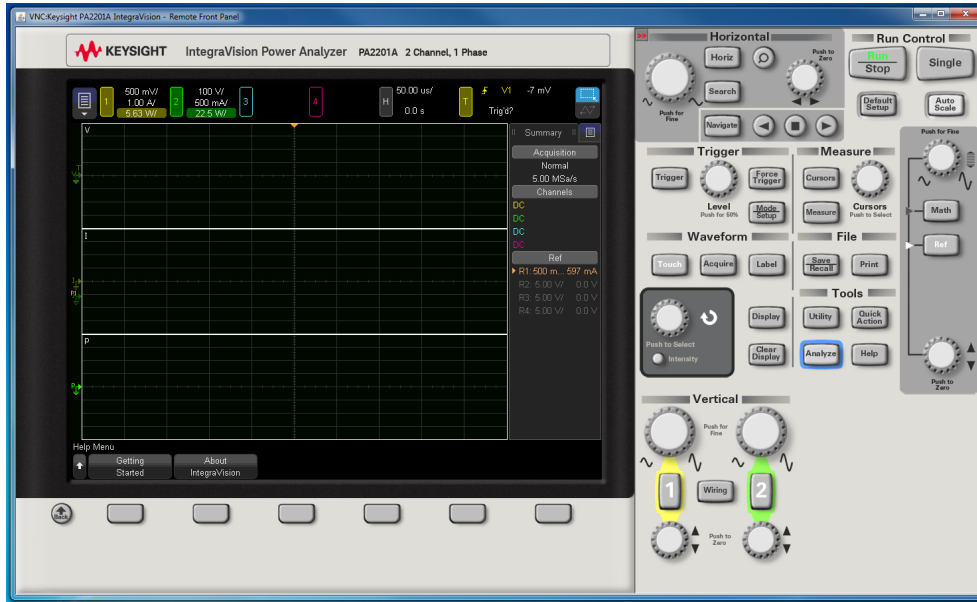

The Screen Only Remote Front Panel and Tablet Remote Front Panel also open in a separate window. You can operate the instrument just as you would using the touchscreen.

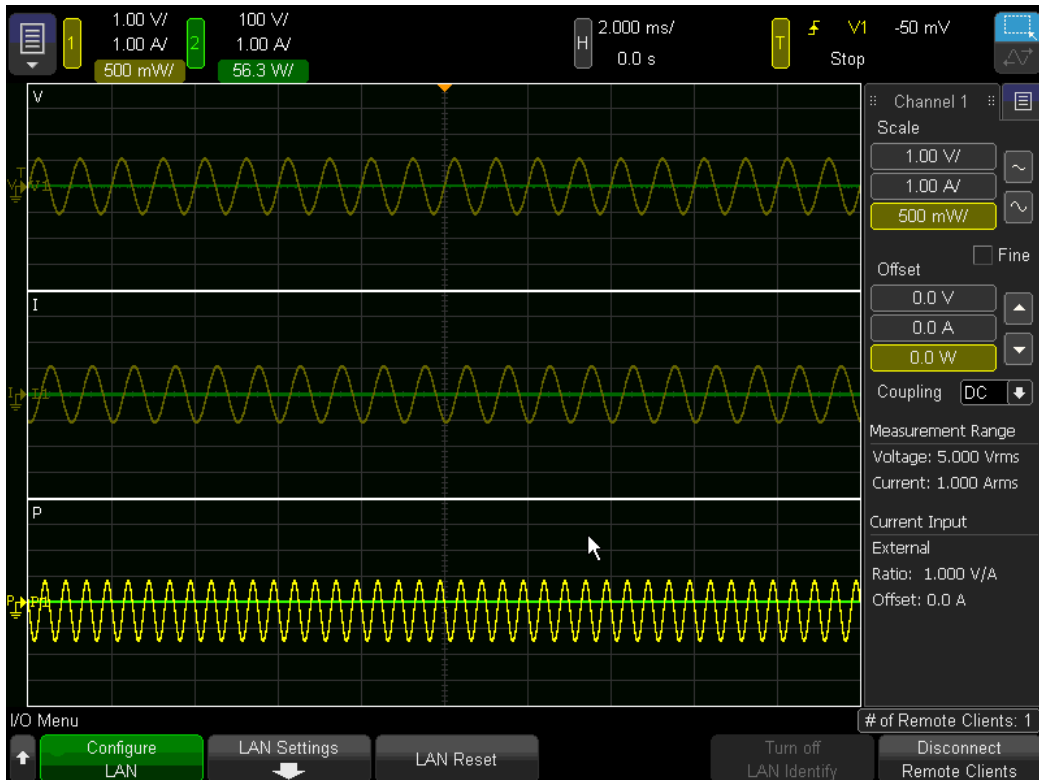



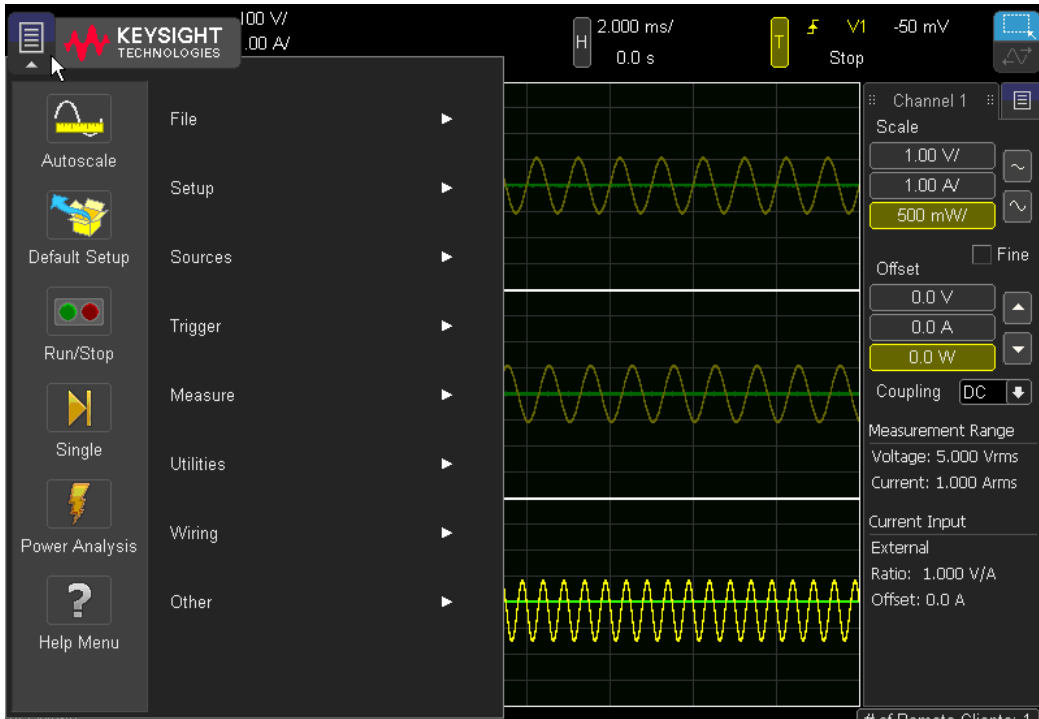























Click the blue menu icon in the upper left corner to access functions that you would normally perform with the front-panel keys.



The items in this menu are shown below.

Menu	Functions	Key Equivalents
File	Save Menu	[Save/Recall]
	Recall Menu	[Utility] > File Explorer
	File Explorer Menu	[Print]
	Email Menu	[Default Setup]
	Print Menu	
	Defaults Menu	

Menu	Functions	Key Equivalents
Setup	 Acquire Menu  Horizontal Menu  Display Menu  Waveform Intensity <input type="checkbox"/>  Channel Labels	[Acquire] [Horiz] [Display] [Intensity] [Label]
Sources	<input checked="" type="checkbox"/>  Channel 1 <input type="checkbox"/>  Channel 2	[1] [2] (PA2203A also includes channels 3 and 4)
Trigger	 Trigger Menu  Trigger Mode Setup Menu  Force Trigger	[Trigger] [Mode/Setup] [Force Trigger]
Measure	<input type="checkbox"/>  Measurements <input type="checkbox"/>  Statistics <input type="checkbox"/>  Cursors	[Measure] [Measure] > Statistics [Cursors]
Utilities	 Utility Menu  I/O Menu  File Explorer Menu <input checked="" type="checkbox"/>  User Options Menu  Service Menu  Quick Action Menu	[Utility] [Utility] > File Explorer [Utility] > I/O [Utility] > User Options [Utility] > Service [Utility] > Quick Action

Menu	Functions	Key Equivalents
Wiring	 Channel Skew  Filters  Wiring Configuration	[Wiring] [Filters]
Phasor	 Phasor Diagram Menu	[Phasor]
Other	<input type="checkbox"/>  Waveform Math <input type="checkbox"/>  Reference Waveforms <input type="checkbox"/>  Waveform Search <input type="checkbox"/>  Navigate Menu	[Math] [Ref] [Search] [Navigate]

Get Image

To save (or print) the instrument's display from the web interface:

1. Select the Get Image tab from the left side of the Welcome screen. After a delay of several seconds, the screen image will be displayed.
2. Right-click on the image and select **Save Picture As...** (or **Print Picture...**).
3. Select a storage location for the image file and click **Save**.

You can also print any page of the Web interface from the Print Page tab.

User Options

Press **[Utility] > User Options > Preferences** to set instrument preferences. The **Autoscale** softkey allows you to undo an Autoscale operation.

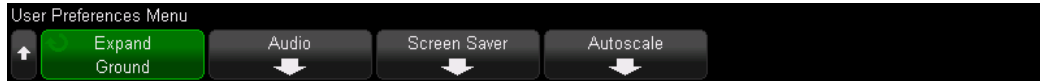

To choose "expand about" center or ground

You can specify how the waveform expands or compresses when you change a channel's vertical scale. Press **[Utility] > User Options > Preferences > Expand** and select:

Ground (default) – The displayed waveform will expand about the channel's ground, identified by the ground level (⚡) icon at far left. The ground level will not move when you adjust the vertical scale. If the ground level is off screen, the waveform will expand about the display's top or bottom edge.

Center – The displayed waveform will expand about the center of the display.

To set up the audio preferences

To configure audio, press **[Utility] > User Options > Preferences > Audio**. Then set the volume (0 to 100, default 50) and the events that will cause the instrument to beep.

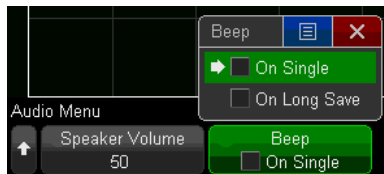

A "Long Save" is a file save operation that takes longer than 20 seconds, and a "Single" is the completion of a single acquisition.

To set up the screen saver

You can configure the instrument to turn on a screen saver after a specified idle time.

1. Press **[Utility]** > **User Options** > **Preferences** > **Screen Saver**.

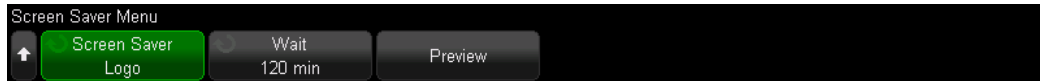

2. Press **Screen Saver** and choose whether you want the screen save to be off (disabled), a blank screen, a Keysight logo, or custom text (press the **Text** softkey that appears to specify that text.)

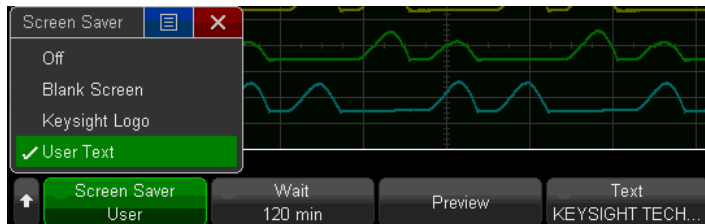

3. Press **Wait** to select the idle time before the screen saver activates. The default is 120 minutes.
4. Press **Preview** to see the screen saver. When finished, press any key or turn any knob.

To set the instrument's clock

You can set the instrument's real-time clock for the date/time stamp that appears on printouts and file attributes. The clock uses a 24-hour format, which means that 1:00 PM is 13:00.

1. Press **[Utility]** > **User Options** > **Date/Time**.
2. Press the **Year**, **Month**, **Day**, **Hour** or **Minute** softkey. Then rotate the **Entry** knob to set to the desired number. Repeat as necessary until the date and time are correct.

If a day is selected and the month or year is changed so the day is invalid, the day is automatically adjusted.

To Use the Rear-Panel Reference Clock

To use an external clock signal on the rear-panel Ref In connector (10 MHz, 0 to 3.3 V) instead of the instrument's internal clock, press **[Utility]** > **User Options** > **Rear Panel** > **Ref In Clock** and choose **Use**. The default is **Ignore**.

The [Quick Action] Key

The [Quick Action] key performs a specific action when you press it. To specify the action that is performed, press [Utility] > Quick Action > Action.

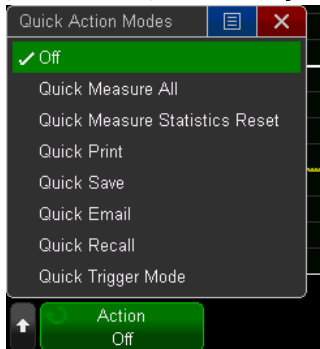

Off	Disables the [Quick Action] key.
Quick Measure All	Displays a window with all single waveform measurements associated with a specific voltage, current, or power signal.

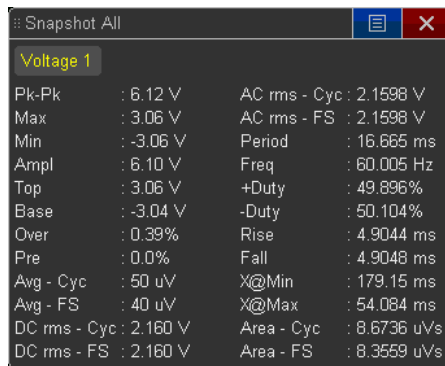

The Source softkey specifies this waveform source, which also becomes the Source in the Measurement Menu.

Quick Measure Statistics Reset	Resets all measurement statistics and the measurement count to 0.
Quick Print	Prints the current screen image.
Quick Save	Saves the current image, waveform data, or setup.
Quick Email	E-mails the current setup, screen image, or data file.
Quick Recall	Recalls an instrument setup or reference waveform.
Quick Trigger Mode	Toggles the trigger mode between Auto Trigger and Wait for Trigger.

The Quick Print, Quick Save, Quick Email, and Quick Recall options produce a **Settings** softkey for configuring additional parameters.

5 Triggers and Acquisitions

Triggering

Acquisition Control

Datalogging

Triggering

Triggers - general information

To adjust the trigger level

To force a trigger



The instrument uses edge triggers to acquire and display data. If the trigger signal is noisy, stabilize it as much as possible by removing sources of noise from the trigger path.

You can press **[Auto Scale]** to configure triggers automatically, or you can manually configure an edge trigger as follows :

1. Press **[Trigger]** > **Source** and choose the desired voltage, current, or power signal on which to trigger. You can also use an external trigger signal or the line power to the instrument.
2. Press **Slope** and specify whether to trigger on a rising edge, falling edge, or either edge. The Either edge mode is useful when you want to trigger on any activity of a selected source. All modes operate up to the instrument's bandwidth except Either edge mode, which has a limitation. Either edge mode will trigger on constant wave signals up to 1 MHz, but can trigger on isolated pulses down to one-half of the instrument's bandwidth.

CAUTION

Maximum voltage at instrument external trigger input

The external trigger input operates with edges that rise and fall between 0 and 3.3 V.

The trigger can actually operate properly from 0 to 5 V, but it will sink current for voltages above 4.0 V or below -0.7 V.

To adjust the vertical level for edge detection on channels 1 and 2, turn the **Trigger Level** knob. This knob does not affect the Line or External trigger.

If the instrument is stopped when you change a trigger setup, the instrument uses the new setup when you press **[Run/Stop]** or **[Single]**. If the instrument is running when you change a trigger setup, it uses the new trigger setup when it starts the next acquisition.

Press **[Force Trigger]** to acquire and display data when triggers are not occurring.

Press **[Mode/Setup]** to set additional trigger options. See **Trigger Mode/Setup** for details.

Trigger setups are saved with the instrument setup. See **Save/Email/Recall (Setups, Screens, Data)** for details.

Triggers - general information

A triggered waveform is one in which the instrument begins tracing (displaying) the waveform, from the left side of the display to the right, each time a particular trigger condition is met. This provides stable display of periodic signals such as sine waves and square waves. The trigger event divides acquisition memory into pretrigger and posttrigger buffers, as shown below. The position of the trigger event in acquisition memory is defined by the time reference point and the delay (horizontal position) setting. See **To adjust the horizontal delay (position)** for details.

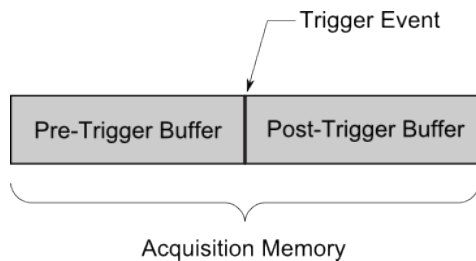

To adjust the trigger level

You can adjust the trigger level for a selected signal with the **[Trigger Level]** knob or by dragging the trigger level indicator on the touchscreen.

Push the **[Trigger Level]** knob to set the level of each displayed signal to its 50% value. If AC coupling is used, pushing the **[Trigger Level]** knob sets the trigger level to about 0 V.

Each displayed signal's trigger level is indicated by the trigger level icon (T) at the far left side of the display. The trigger level is displayed in the upper-right corner of the display.

The line trigger level is not adjustable. This trigger is synchronized with the power line supplied to the instrument. The external trigger level is also not adjustable.

To force a trigger



The **[Force Trigger]** key causes a trigger and displays the acquisition. This is useful in the Wait for Trigger mode, where acquisitions are made only when the trigger condition is met. In this mode, if no triggers are occurring (the "Trig'd?" indicator is displayed), press **[Force Trigger]** to view the input signals.

In Auto Trigger mode, when the trigger condition is not met, triggers are forced and the "Auto?" indicator is displayed.

Trigger Mode/Setup

To access the Trigger Mode/Setup Menu, press **[Mode/Setup]** in the Trigger section of the front panel.

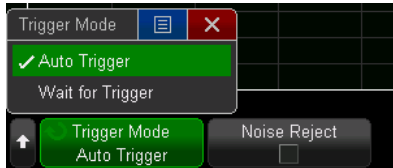

In Auto Trigger mode (the default), triggers are forced and acquisitions are made so that signal activity is displayed. In Wait for Trigger mode, triggers and acquisitions only occur when the specified trigger conditions are found. To select the trigger mode, press **[Mode/Setup] > Mode**, then select either **Auto** or **Wait for Trigger**.

Use the Auto Trigger mode with DC signals or signals with unknown activity levels. You should also use Auto Trigger when trigger conditions occur often enough that forced triggers are unnecessary.

Use the Wait for Trigger mode when you only want to acquire specific events, you are triggering on a signal that arrives in bursts, or you are making single-shot acquisitions with the **[Single]** key. The Wait for Trigger mode lets you stabilize the display by preventing the instrument from autotriggering.

With single-shot acquisitions, you often must initiate some action in the device under test, and you do not want to autotrigger too soon. Before initiating the action in the circuit, wait for the trigger condition indicator Trig'd? to display (this tells you the pretrigger buffer is filled).

You can also make this selection using the upper right corner of the touchscreen.



To configure the **[Quick Action]** key to toggle between the Auto and Wait for Trigger modes, press **[Utility] > Quick Action > Action** and select Quick Trigger Mode.

Triggering and the Pretrigger and Posttrigger Buffers

After the instrument starts running (after pressing **[Run]** or **[Single]** or changing the trigger condition), the instrument first fills the pretrigger buffer. Then, after the pretrigger buffer is filled, the instrument waits for a trigger, and sampled data continues to flow data through the pretrigger buffer, first-in/first-out.

When a trigger occurs, the pretrigger buffer contains the events that occurred just before the trigger. Then, the instrument fills the posttrigger buffer and displays the acquisition memory. If the acquisition was initiated by **[Run/Stop]**, the process repeats. If the acquisition was initiated by **[Single]**, the acquisition stops and you can pan and zoom the waveform.

In either Auto Trigger or Wait for Trigger mode, a trigger may be missed if the event occurs while the pretrigger buffer is being filled. This may be more likely, for example, when the horizontal scale knob is set to a slow time/div setting, such as 500 ms/div.

Trigger Indicator

The instrument always shows a trigger indicator at the top right corner of the display.

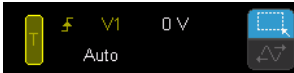

There are five possible values for this indicator:

In Auto Trigger Mode	Auto?	The instrument is in Auto Trigger mode, the trigger condition is not found (after the pretrigger buffer has filled), and forced triggers and acquisitions are occurring.
	Auto	The instrument is in Auto Trigger mode, the trigger condition is found (or the pretrigger buffer is being filled).
In Wait for Trigger Mode	Trig'd?	The trigger condition is not found (after the pretrigger buffer has filled), and no acquisitions are occurring.
	Trig'd	The trigger condition is found (or pretrigger buffer is being filled).
In Either Mode	Stop	The instrument is not running.

External Trigger Input

You can use the external trigger as a trigger source. This rear-panel input is labeled EXT TRIG IN. You can set the external trigger input's slope, but not its trigger level.

CAUTION

Maximum voltage at instrument external trigger input
 The external trigger input operates with edges that rise and fall between 0 and 3.3 V.
 The trigger can actually operate properly from 0 to 5 V, but it will sink current for voltages above 4.0 V or below -0.7 V.

Acquisition Control

NOTE

Whenever you turn a knob or press a button that affects the waveform measurement or display during a running acquisition, the acquisition re-starts. Be sure to configure everything associated with your measurement before you acquire data.

The **[Run/Stop]** and **[Single]** keys start and stop the instrument's acquisition system.

When **[Run/Stop]** is green, the instrument is running and acquiring data when trigger conditions are met. To stop acquiring data, press **[Run/Stop]**. When **[Run/Stop]** is red, data acquisition is stopped and the last acquired waveform is displayed. To start acquiring data, press **[Run/Stop]**.

To capture and display one acquisition (whether the instrument is running or stopped), press **[Single]**. The **[Single]** key is yellow until the instrument triggers. The **[Single]** key lets you view single-shot events without subsequent waveform data overwriting the display. It also provides maximum memory depth for pan and zoom.

When you press **[Single]**, the trigger mode is temporarily set to Wait for Trigger (to keep the instrument from auto-triggering immediately), the trigger circuitry is armed, the **[Single]** key is illuminated, and the instrument waits until a trigger condition occurs before it displays a waveform.

When the instrument triggers, the single acquisition is displayed and the instrument stops (**[Run/Stop]** is illuminated in red). Press **[Single]** again to acquire another waveform.

If the instrument does not trigger, press **[Force Trigger]** to trigger on anything and make a single acquisition.

Datalogging

You can log data to a USB drive connected to the front panel for durations up to 31,536,000 seconds (365 days). The instrument configuration is locked during datalogging, so be sure to configure the instrument properly before logging. If you are logging multiple channels and they have the same sync source, the instrument will produce one datalog output file. However, if each channel or wiring group has a different sync source, you will get multiple data files.

To log data:

1. Press **[Acquire] > Datalog**.

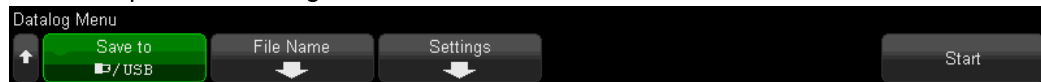

2. Press **Save to** and select the USB directory for the log file. Press **OK** when done.
3. Press **File Name** and specify the datalog file name. Press **OK** and **Back** when done.
4. Press **Settings**.



5. Press **[Channels]** and select the channels to be logged.
6. Press **Duration** and enter the total length of time over which data should be logged (in seconds). Note that there are 3,600 seconds in one hour, and 86,400 seconds in one day.
7. Press **Interval** and specify the period at which data is to be recorded. The interval can be from 50 ms to 86,400 seconds (one day).

CAUTION

Large File Sizes

The Datalog sidebar contains the datalog configuration and an estimated file size. Before you begin a lengthy datalog, ensure that you have more than enough free space on your USB drive. To reduce the file size, you can decrease the duration, increase the interval, or choose not to log one or more channels.



8. Press **CWA Setup** and configure the CWA parameters for the measurements. Note that you can specify a different sync source for each channel or wiring group.
9. Press **[Start]**. The datalog progress will appear in the sidebar.

6 Measurements

Measurement Basics

Cursors

CWA Measurements - Theory and Operation

Mathematics of CWA Measurements

Measurement Basics

The **[Measure]** key lets you configure and make automatic waveform measurements. You can display up to 10 added measurements in the Meas sidebar, which can be selected from the sidebar menu at the right side of the display, as shown below. Added measurements appear at the bottom of the Meas sidebar, and cursors indicating the portion of the waveform being measured are displayed.

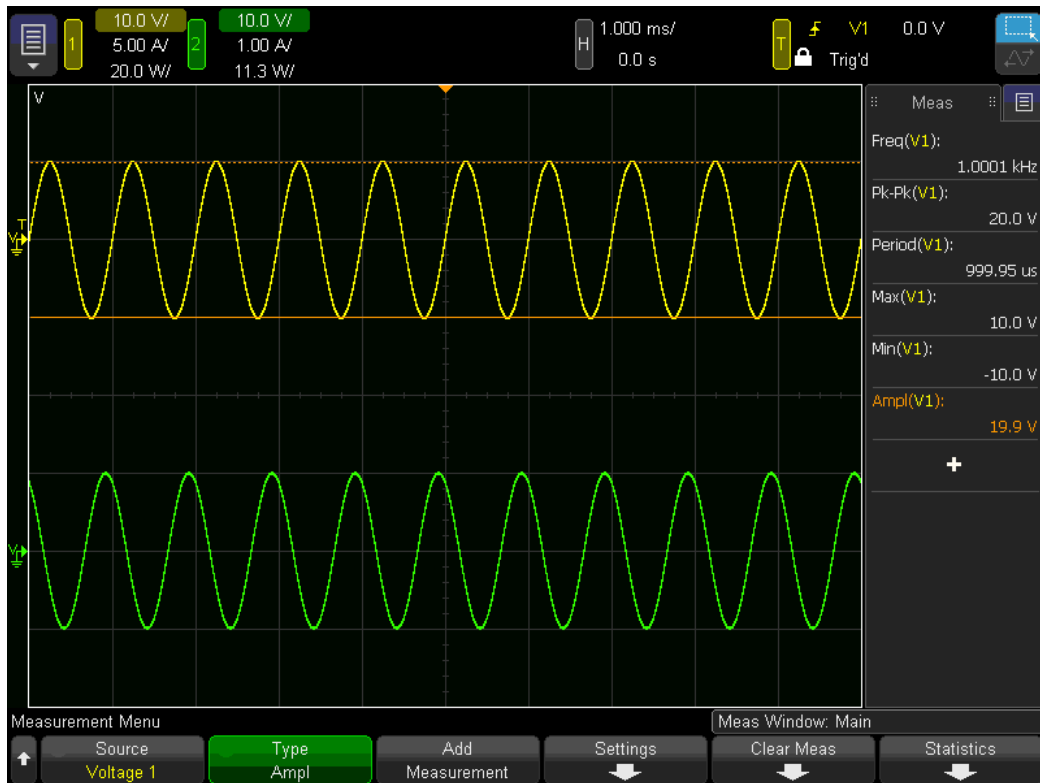

You can change the measurement for which cursors are displayed by touching the measurement in the list and choosing **Track With Cursors** or by selecting the measurement in the Cursors Menu.

Post Acquisition Processing

In addition to changing display parameters after the acquisition, you can perform all measurements and math functions after the acquisition. Measurements and math functions will be recalculated as you pan and zoom and turn channels on and off. As you adjust the vertical and horizontal scale, you affect the display resolution. Because measurements and math functions are performed on displayed data, you affect the math and measurement resolution.

To make automatic measurements

1. Press **[Measure] > Source**.
2. Select the signal, math waveform, or reference waveform to measure. Only those waveforms that are displayed can be measured.

If a portion of the waveform required for a measurement is not displayed or does not display sufficient resolution to make the measurement, the result will display "No Edges", "Clipped", "Low Signal", "< value", or "> value", or a similar message to indicate that the measurement may not be reliable.

3. Press the **Type** softkey and select a measurement to be made. You can also touch the "+" in the Measurements sidebar dialog to open the measurement type menu.
4. The **Settings** softkey will be available to make additional measurement settings on some measurements.
5. Press the **Add Measurement** softkey or push the **Entry** knob to display the measurement.

Cursors are turned on to show the portion of the waveform being measured for the most recently added measurement (bottom of the display). You can change the measurement for which cursors are displayed by touching the measurement in the list and choosing **Track With Cursors** or by selecting the measurement in the Cursors Menu.

6. To turn off measurements, press the **[Measure]** key again. Measurements are erased from the display.
7. To stop making a measurement, press **Clear Meas > Select Measurement**, choose the measurement to clear, and press **Clear Selected Measurement**. To stop making all measurements, press **Clear All**.

After all measurements have been cleared, pressing **[Measure]** will return to the default measurements of Frequency and Peak-Peak.

Voltage, Current, and Power Measurements

The following figure shows the measurement points for voltage, current, and power measurements.

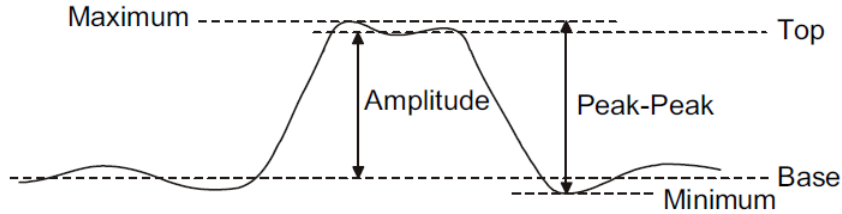

Measurement	Description	Cursors
Peak-Peak	The difference between Maximum and Minimum values.	The Y cursors show the value or values being measured.
Maximum and Minimum	The highest and lowest values.	
Amplitude	The difference between the Top and Base values.	
Top and Base	Modes (most common values) of the upper and lower parts of the waveform. If a mode is not well defined, these are set to the Maximum and Minimum.	
Overshoot and preshoot	Distortions that follow (overshoot) or precede (preshoot) an edge transition, expressed as the difference between the Minimum or Maximum and the Top or Base as a percentage of Amplitude.	The X cursors show which edge is being measured (edge closest to the trigger reference point).
	<p>The top diagram shows a rising edge. A dashed line labeled 'Top' is above the waveform's peak, and a dashed line labeled 'Base' is below the waveform's trough. The peak is labeled 'local Maximum' and the trough is labeled 'local Minimum'. Arrows indicate the 'Overshoot' (distance from Top to local Maximum) and 'Overshoot' (distance from local Minimum to Base).</p> <p>The bottom diagram shows a falling edge. A dashed line labeled 'Top' is above the waveform's peak, and a dashed line labeled 'Base' is below the waveform's trough. The peak is labeled 'local Maximum' and the trough is labeled 'local Minimum'. Arrows indicate the 'Preshoot' (distance from local Maximum to Top) and 'Preshoot' (distance from Base to local Minimum).</p>	
Average	The arithmetic mean of the samples.	The X cursors show what interval of the waveform is being measured.
DC RMS	The root-mean-square value over one or more full periods.	
AC RMS	The root-mean-square value with the DC component removed. This is useful, for example, for measuring power supply noise.	

Measurement Intervals

Some measurements allow you to specify an interval on which the measurement is performed.

Setting	Meaning
Full Screen	Measures the value on all displayed data points.
N Cycles	Measures the value on an integral number of periods. If fewer than three edges are present, the measurement shows "No edges."
Full Screen (Std Deviation)	Performs an RMS measurement across the full screen with the DC component removed and shows the standard deviation of the displayed voltage values.

Time Measurements

The following figure shows time measurement points.

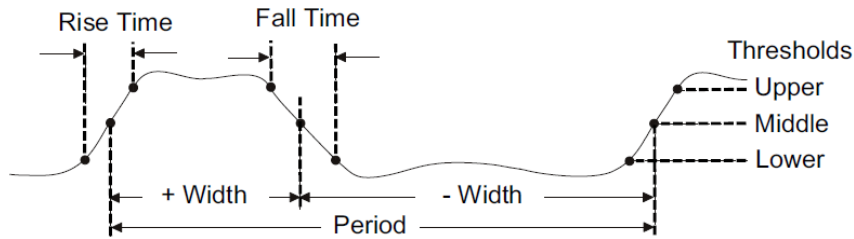

The default lower, middle, and upper measurement thresholds are 10%, 50%, and 90% of the way between Top and Base values.

Period and Frequency

Period is the time between the middle threshold points of two consecutive, like-polarity edges of a complete waveform cycle; frequency is its reciprocal. A middle threshold crossing must also travel through the lower and upper threshold levels to eliminate runt pulses. The X cursors show the portion of the waveform being measured. The Y cursor shows the middle threshold point.

Duty Cycle

The duty cycle of a pulse train is the pulse divided by the period, expressed as a percentage. The X cursors show the time period being measured. The Y cursor shows the middle threshold point.

Rise Time and Fall Time

The rise time of a signal is the time difference between the crossing of the lower threshold and the crossing of the upper threshold for a rising edge; fall time is the analogous value for a falling edge. The X cursor shows the edge being measured. For maximum measurement accuracy, set the horizontal time/div as fast as possible while leaving the complete rising edge of the waveform on the display. The Y cursors show the lower and upper threshold points.

Delay

Delay measures the time from the middle threshold of the Source 1 edge closest to the center of the screen to the middle threshold of the nearest Source 2 edge. Negative delay values indicate that the Source 1 edge occurred after the Source 2 edge. To measure delay:

1. Press **[Measure]** > **Source** and select the first source.
2. Press **Type** > **Delay**.
3. Press **Settings** to select the second source and the slopes for the measurement. The default Delay settings measure from the rising edge of channel 1 to the rising edge of channel 2.
4. Press  to return to the Measurement Menu.
5. Press **Add Measurement** to make the measurement.

The example below shows a delay measurement between the rising edges of Voltage 1 and Voltage 2. Because Voltage 2 (the signal at the bottom) is leading Voltage 1, the delay is a negative value.

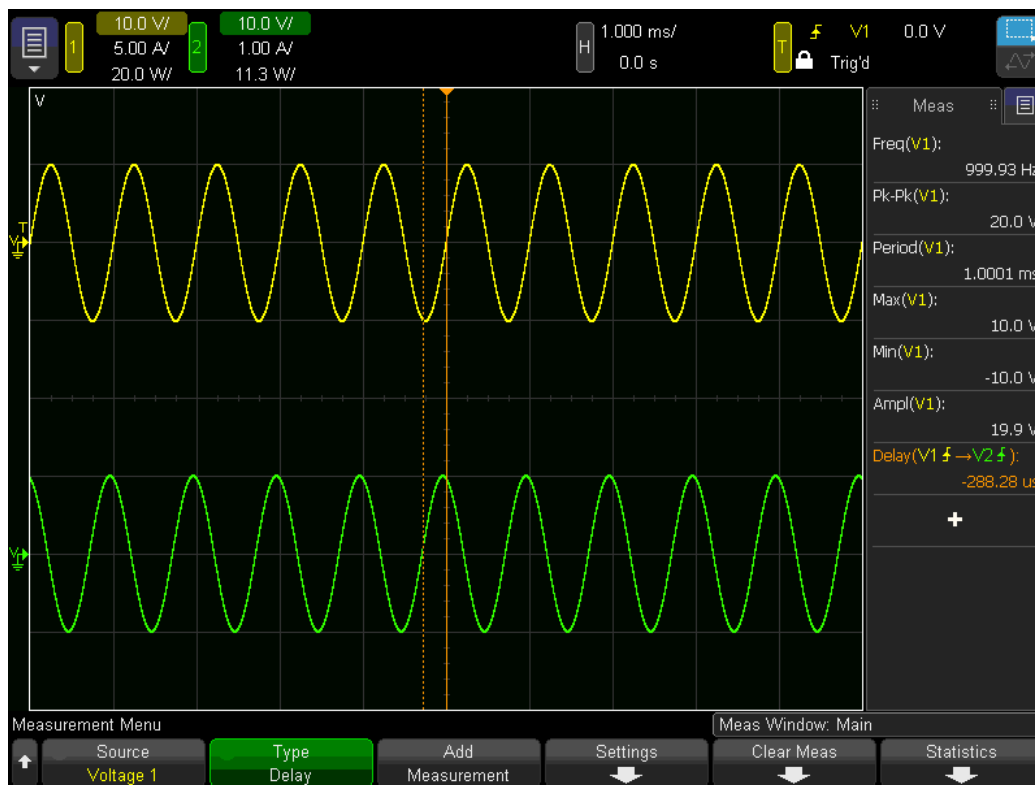

Phase

Phase is identical to Delay, but the result is reported in degrees of cycle, not in seconds of time.

X at Min Y / X at Max Y

X at Min Y and X at Max Y are the X axis values (usually time) at the leftmost displayed occurrence of the waveform Minimum or Maximum. For periodic signals, the position of the minimum and may vary throughout the waveform. The X cursor shows where the current X at Min Y or X at Max Y value is being measured.

To measure the peak of an FFT

1. Select **FFT** as the Operator in the Waveform Math Menu.
2. Choose **Math N** as the source in the Measurement Menu.
3. Choose **Maximum** and **X at Max Y** measurements.

Maximum units are in dB and X at Max Y units are in Hertz for FFT.

Area

Area measures the area between the waveform and the ground level. Area below the ground level is subtracted from area above the ground level.

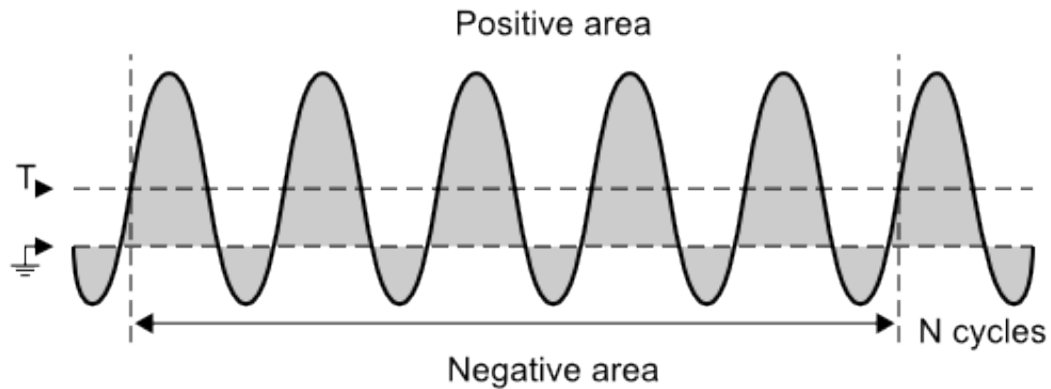

The Full Screen measurement interval variation measures the value on all displayed data points. The N Cycles measurement interval variation measures the value on a whole number of periods. If fewer than three edges are present, the measurement shows "No edges."

The X cursors indicate the interval of the waveform being measured.

Measurement Thresholds

Measurement thresholds define the vertical levels where measurements are taken.

NOTE Changing default thresholds may change measurement results

The default lower, middle, and upper threshold values are 10%, 50%, and 90% of the range between Top (0%) and Base (100%). Changing these threshold definitions from the default values may change the returned measurement results for Average, Delay, Duty Cycle, Fall Time, Frequency, Overshoot, Period, Phase, Preshoot, Rise Time, +Width, and -Width.

1. Press **[Measure]** > **Settings** > **Thresholds** > **Source** to select the signal, math waveform, or reference waveform for which you want to change measurement thresholds. Each waveform has its own thresholds.



2. Press the **Lower** softkey, then turn the **[Entry]** knob to set the lower measurement threshold value. Increasing the lower value beyond the set middle value will automatically increase the middle value to be more than the lower value.
3. Press the **Middle** softkey; then, turn the **[Entry]** knob to set the middle measurement threshold value, which is bounded by the lower and upper thresholds.
4. Press the **Upper** softkey; then, turn the **[Entry]** knob to set the upper measurement threshold value.

Decreasing the upper value below the set middle value will automatically decrease the middle value to be less than the upper value.

Measurement Statistics

To display measurement statistics, press **[Measure] > Statistics > Display On**. By default frequency and peak-to-peak voltage are measured on channel 1.

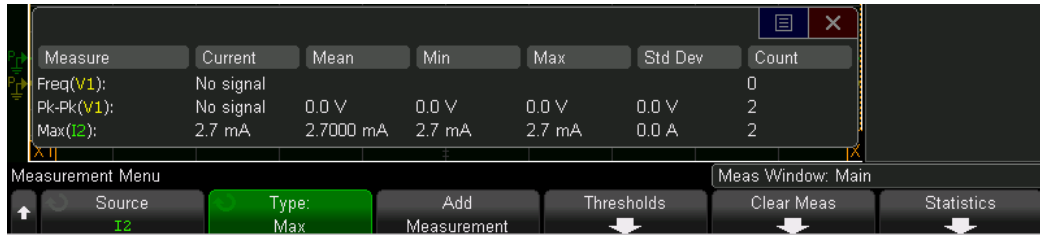

Measure	Current	Mean	Min	Max	Std Dev	Count
Freq(V1):	No signal					0
Pk-Pk(V1):	No signal	0.0 V	0.0 V	0.0 V	0.0 V	2
Max(I2):	2.7 mA	2.7000 mA	2.7 mA	2.7 mA	0.0 A	2

The source channel of the measurement is shown in parenthesis after the measurement name. For example: "**Freq(V1)**" indicates a frequency measurement on voltage channel 1. Statistics are based on the number of captured waveforms (count).

The Measurement Statistics Menu

Pressing **[Measure] > Statistics** opens the Measurement Statistics Menu:



Press **Reset Statistics** to reset all statistics and begin recording statistical data again. Adding a new measurement (for example: frequency, period, or amplitude) resets statistics and begins accumulating statistical data again.

Press **Relative σ** to divide each standard deviation by its associated mean.

Press **Max Count** to specify the number of values used when calculating measurement statistics. For a limitless count, press **MAX** on the popup keypad.

Additional facts about measurement statistics

Pressing **[Single]** resets statistics and performs one measurement. Successive **[Single]** acquisitions accumulate statistical data and increment the count.

The **Increment Statistics** softkey only appears when the acquisition is stopped. Press **[Single]** or **[Run/Stop]** to stop the acquisition. Use the horizontal position control (in the Horizontal control section of the front panel) to pan through the waveform. Active measurements will stay on screen, allowing you to measure various aspects of the captured waveforms. Press **Increment Statistics** to add the currently measured waveform to the collected statistical data.

Cursors

Cursors are horizontal and vertical markers that indicate X- and Y-axis values on a waveform in order to allow you to make custom measurements. Cursor information is displayed on the right side of the screen. Cursors are not always limited to the visible display. If you pan or zoom until a cursor is off screen, the cursor remains in its original location.

The cursor values are displayed near the softkeys, and the ΔX and ΔY values and their reciprocals are displayed in the sidebar on the right.

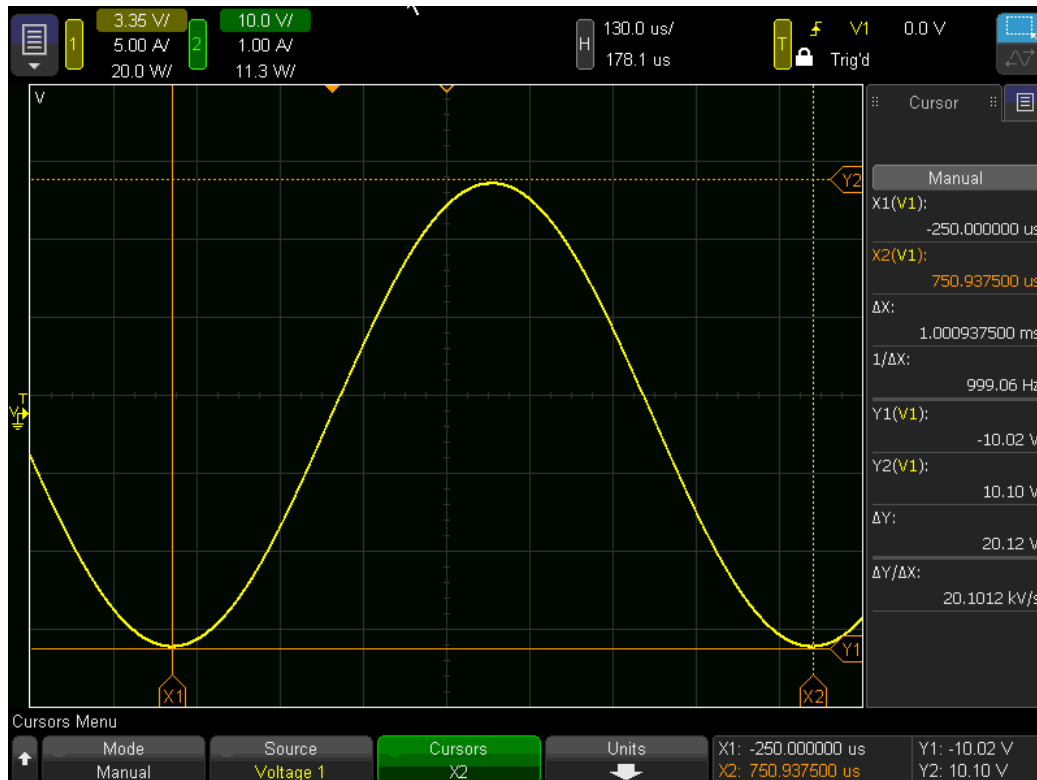

X and Y Cursors

X cursors are vertical dashed lines that measure in the horizontal domain. The X1 cursor is the solid vertical line, and the X2 cursor is the dashed vertical line. When used with the FFT math function as a source, the X cursors indicate frequency.

Y cursors are horizontal dashed lines that can measure signals or math functions along the vertical axis. The Y1 cursor is the solid horizontal line and the Y2 cursor is the dashed horizontal line. The Y cursors typically indicate values relative to the waveform's ground point, except in FFT, where values are relative to 0 dB.

To make cursor measurements

1. Press **[Cursors]**. The Cursors sidebar appears at the right side of the display, indicating that you pressed the **[Cursors]** key to enable cursors. (Press **[Cursors]** again to turn cursors off.)
2. In the Cursors Menu, press **Mode**; then, select the desired mode:

Manual – AX, 1/ Δ X, and Δ Y values are displayed.



Track Waveform – As you move a marker horizontally, the vertical amplitude of the waveform is tracked and measured. The time and voltage positions are shown for the markers. The vertical (Y) and horizontal (X) differences are shown as AX and Δ Y.

Measure – When measurements are displayed, this shows the cursor locations used to make the measurement. When you add a measurement, it becomes the one that cursors are displayed for. Use the Measurement softkey or touch in the Meas sidebar dialog to select the measurement whose cursor locations are displayed.



Manual and Track Waveform modes can be used on voltage, current, and power signals, math waveforms, and reference waveforms.

3. Press Source (or X1 Source, X2 Source in the Track Waveform mode); then, select the input source for cursor values.
4. To select the cursor(s) to be adjusted, push the **[Cursors]** knob, turn it,
 - Push the **[Cursors]** knob, then turn it. To finish, push the knob again.
 - Press the **Cursors** softkey; then, turn the **[Entry]** knob.

The X1 X2 linked and Y1 Y2 linked selections let you adjust both cursors at the same time, while the delta value remains the same. This can be useful, for example, for checking pulse width variations in a pulse train. The currently selected cursor(s) display brighter than the other cursors.

- To change the cursor units, press **Units**.

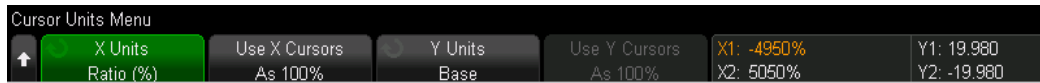

You can press the X Units softkey to select Seconds (s), Hz (1/s), Phase (°), or Ratio (%). When Phase (°) is selected, use the Use X Cursors softkey to set the current X1 location as 0 degrees and the current X2 location as 360 degrees. When Ratio (%) is selected, use the Use X Cursors softkey to set the current X1 location as 0% and the current X2 location as 100%.

You can press the Y Units softkey to select Base or Ratio (%). Selecting Base means the Y cursors use the same units as the source waveform. When Ratio (%) is selected, use the Use Y Cursors softkey to set the current Y1 location as 0% and the current Y2 location as 100%.

For phase or ratio units, once the 0 and 360 degree or 0 and 100% locations are set, adjusting cursors will display measurements relative to the set locations.

- Adjust the selected cursor(s) by turning the **Cursors** knob or by dragging the cursors on the touchscreen.

Cursor Examples

The picture below shows cursors measuring the time for a sine wave to rise to its peak.

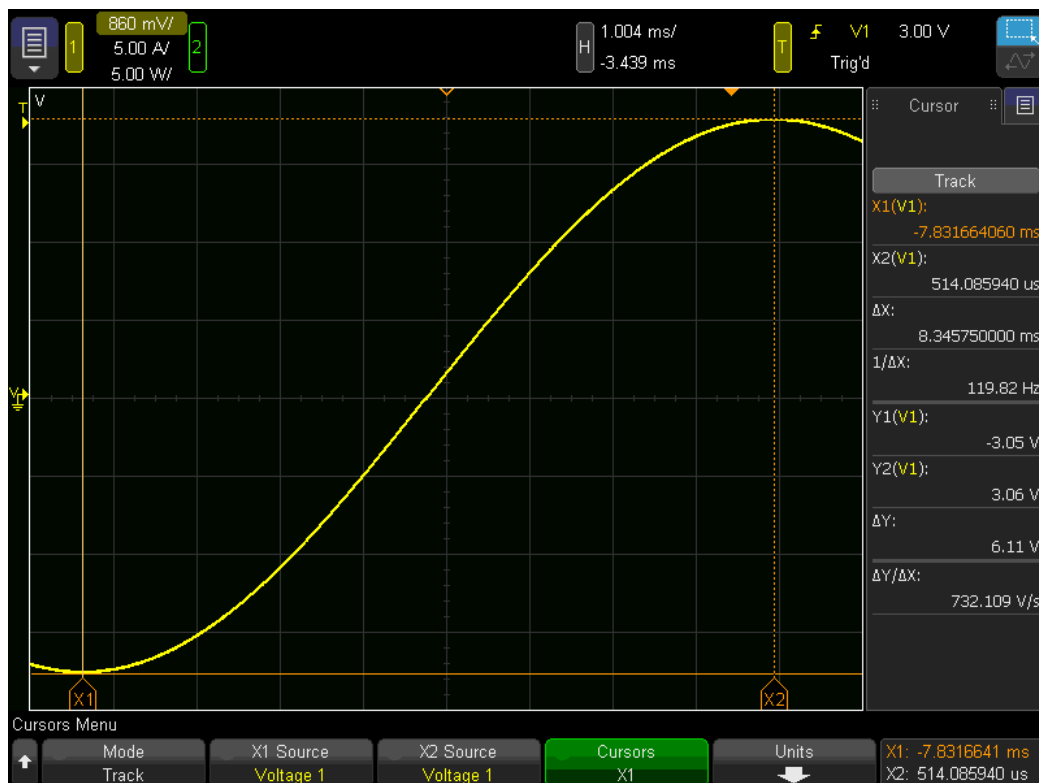

The following picture shows cursors measuring the square of a sinusoidal current pulse as part of an I^2t measurement. The purple line is the integral of the square of the current.



CWA Measurements - Theory and Operation

Continuous Whole-Cycle Analysis (CWA) is a gapless measurement technique. This section covers theory, configuration, and troubleshooting, and the following section covers the mathematics of CWA measurements.

Theory of Operation

Oscilloscopes traditionally measure signals based on what is shown on the screen. These measurements often have gaps, meaning data between measurements that do not get measured. Furthermore, the accuracy of such measurements is determined by what is on the screen. Users often want guaranteed accuracy specifications, and having specifications change based on the horizontal scale is inconvenient for power analysis. To avoid these limitations, the IntegraVision PA2200 Series power analyzers include a new type of data analysis called Continuous Whole-Cycle Analysis (CWA).

Only gapless measurements guarantee accurate power consumption measurement, and some IEC standards require continuous, gapless power measurement. For an AC signal, this analysis must be performed over an integer number of waveform cycles. In many cases, such as efficiency measurements or 3-phase power analysis, the user must analyze multiple signals over a consistent time period. These different signals are often out of phase, so it is helpful to use one signal to determine the time frame of the analysis. In CWA, the user selects one signal as the synchronization (sync) source, and the CWA measurement is performed on all signals simultaneously, based on the sync source's zero crossings. The time frame starts and ends on rising zero crossings, so that measurements are always performed over an integer number of sync source cycles. Note that the CWA feature includes a Sync Offset parameter to vertically offset the zero crossing for sync sources that contain a DC offset.

The CWA feature uses a measurement window to specify how many sync source cycles are included in each measurement. Longer windows reduce noise, but miss brief signal events. Shorter windows reveal brief events, but increase measurement noise and limit the lowest frequency signal that can be analyzed (a full cycle must fit in the window). Some measurements use a fixed measurement window, and others allow you to select a window duration.

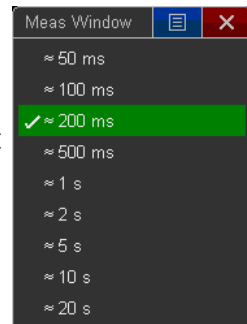

The actual window will be slightly longer than the nominal duration so that the instrument always measures the same number of cycles per window at typical power frequencies, such as 50 and 60 Hz. For example, suppose you have a nominal 50-Hz signal that is sometimes 49.99 Hz and sometimes 50.01 Hz. A 200-ms window would fit 10 whole cycles of a 50.01-Hz signal, but only 9 whole cycles of a 49.99-Hz signal. Therefore, the 200-ms window is made slightly longer than 200 ms to accommodate 10 whole cycles of frequencies slightly lower than 50 Hz.

The diagram below shows a measurement window starting when the sync source rises through zero and ending at the sync source's last rising zero crossing within the measurement window. The measurement's period is the number of cycles that fit into the measurement window multiplied by the sync source period. The next CWA measurement begins at the end of the previous measurement. The portion of the waveform after the last zero crossing is thus included in the following measurement window, ensuring gapless measurement. Therefore, the periodicity of results is shorter than the measurement window. For example, a 200-ms window produces data every 192.3 ms for a 52-Hz signal.

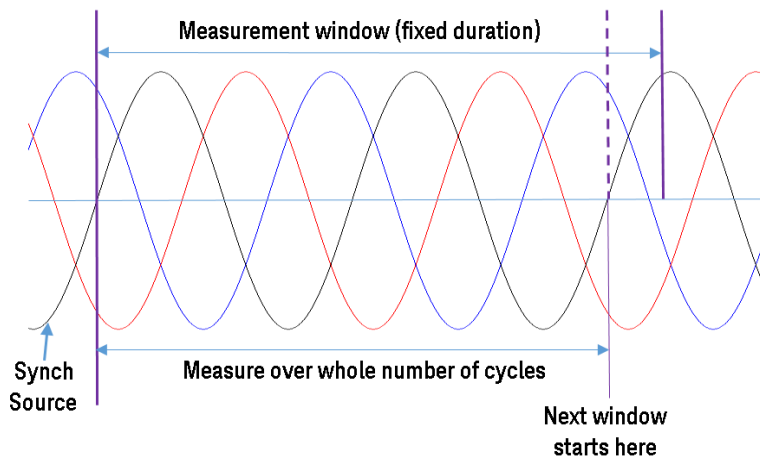

The sync source determines the measurement period. The other signals will be measured over an integer number of cycles if their frequencies match the sync source. This is important for 3-phase measurements, as all three phases must be measured simultaneously to properly calculate total power. Furthermore, accurate efficiency analysis requires simultaneous measurement of input and output power.

This measurement window is used to compute point by point power, RMS voltage and current, and average (arithmetic mean) voltage and current. These three quantities become inputs for all other CWA power measurements. The frequency of the signals is measured by counting zero crossings and dividing the number of cycles by the time used to complete those cycles.

A good sync source is essential. In a system that generates a low frequency AC voltage output by switching at a high frequency to DC rails, zero crossings may be hard to detect. In this case, you might synchronize on the current, which will often have much lower frequency content and a more sinusoidal appearance. Contrarily, consider a rectified circuit with small current pulses at the voltage peaks and zero current otherwise. In this case, the voltage signal would be the sync source.

The CWA feature includes a noise reject setting to improve zero crossing detection on noisy sync sources by changing the hysteresis level applied to zero crossing detection. Higher noise reject settings lead to higher positive and negative edge thresholds for sync source zero crossing detection. Therefore, a very small signal, say 1% of range, may not cross these thresholds for a high noise reject setting, but may cross them at a lower setting. For a very noisy signal, use high noise rejection unless the signal is small relative to its measurement range.

If the measured frequency is too high, you are finding too many edges and should increase the Noise Rejection level. If the measured frequency is too low or nonexistent, decrease the measurement range. In either case, it is preferable to select the lowest fixed measurement range that can still measure the signal.

CWA Configuration

This section describes typical CWA configuration. To configure CWA (usually after pressing a **CWA Setup** softkey):

1. Press the **Sync Source** key and select the channel whose zero crossings will define cycles for CWA.
2. Press **Noise Rejection** and select the amount of hysteresis to add in order to prevent the signal from falsely counting extra edges on a noisy or distorted signal.
3. If your signal is raised or lowered by a DC offset, press the **Sync Offset** softkey and enter the amount by which the signal is offset.
4. Press the **Meas Mode** softkey. Choose AC to measure the AC content of the signal, DC for the DC content, and AC+DC for the combined AC and DC content. This applies only to power measurements, such Apparent Power and Real Power.
5. Press **Meas Window** and specify the length of the CWA measurement window. The actual window will be slightly longer, as described in the Theory of Operation, above.
6. If necessary, Increase the CWA Window to measure low frequencies, as shown below.

	CWA Window	Min. Measurable Freq.
	50 ms	200 Hz
	100 ms	100 Hz
Default	200 ms	45 Hz
	500 ms	20 Hz
	1 s	10 Hz
	2 s	5 Hz
	5 s	2 Hz
	10 s	1 Hz
	20 s	0.5 Hz

CWA in Analyses

Power Quality CWA Setup

For the most accurate CWA frequency measurements, configure the CWA settings correctly for each signal. Enter the **CWA Setup** menu, iterate through each sync source, and set the Noise Rejection level and Sync Offset for each source. Then select the signal to use as the sync source.

Harmonics CWA Setup

The CWA measurement window is fixed at 200 ms in the Harmonics Analysis. To configure other CWA settings, within Harmonics Analysis, press **Settings > CWA Setup**. Be sure the sync source and its settings are appropriate for the harmonics source that is being analyzed.

Energy CWA Setup

The Energy Analysis duration can be selected in increments of the CWA window. Ensure that the Sync Source is a signal that will be present throughout the analysis. If the Sync Source signal is lost during the Energy Analysis, the analysis will be stopped.

Efficiency CWA Setup

The Input and Output sources for the Efficiency Analysis must be configured correctly. For best results, ensure that the Input and Output use the same CWA Sync Source. This ensures that the power measurements are taken over the same time interval.

Datalog CWA Setup

The Datalog Interval sets the CWA measurement window as shown:

Interval	CWA Meas Window
50 ms	50 ms
100 ms	100 ms
≥ 200 ms (THD logged)	200 ms

For each channel selected for datalogging, use the **CWA Setup** menu to configure the **Noise Reject** and **Sync Offset** for voltage, current, and the channel's **Sync Source**.

The Status column in each datalog file provides insight into any issues the instrument may have during each measurement interval, using the abbreviations shown below:

Status	Meaning
NS	No sync source
MS	Some measurement windows in the measurement interval are missing the sync source
OV <channel(s)>	Overload on indicated channels

Troubleshooting

This following table indicates solutions for various CWA issues.

Issue	Solution
The analysis panel says 'No Sync Src.'	The CWA Setup is incorrect. Verify that the Source, Noise Reject, and Sync Offset are all valid.
The analysis panel says 'Window > T.'	The single shot measurement was taken over a timescale that was shorter than the CWA window. Increase the horizontal timescale and try again.
The analysis panel says 'Overload.'	The voltage signal or current signal (or both signals) associated with the measurement source is overloading the system. Ensure that the signal level and hardware ranges are set properly.
The analysis panel rapidly switches between 'Gathering'/'No Sync Src' and valid measurements.	The Sync Offset and Noise Rejection is on the edge of being triggered properly. Adjust the Sync Offset and Noise Rejection for the chosen Sync Source.
The analysis panel says 'Gathering' for a long time.	Ensure that the CWA measurement window is set properly for your application.
The message 'Energy Test Stopped, Lost CWA sync Source' appears.	If the CWA Sync Source is ever lost during the Energy Analysis, the energy test stops. Ensure the Sync Settings are set properly and that the Sync Signal amplitude and frequency are not changing in a way that prevents triggering. Use Line Trigger as the Sync Source if the Energy Source is unpredictable.
The message 'Energy data questionable due to high signal(s) during test' shows after the Energy Analysis completes.	There was an overload condition on the voltage signal or current signal (or both signals) associated with the Energy Source. Autorange is disabled during the Energy Analysis to prevent measurement disruptions. Ensure that the hardware ranges chose for all channels involved in the Analysis are chosen correctly.
Some instrument settings cannot be changed during datalogging and Energy Analysis.	Changing most settings in the instrument resets the acquisition engine. To keep measurements gapless during datalogging or Energy Analysis, these settings are locked out. Configure these settings correctly before starting a datalog or Energy Analysis.
Efficiency Analysis sidebar says '* Sync Sources Differ.'	See Efficiency CWA Setup earlier in this document.

Mathematics of CWA Measurements

The instrument supports several dozen types of measurements based on Continuous Whole-Cycle Analysis. Some of these are basic measurements of voltage, current, and power, and others are measurements of grouped signals. This section specifies what measurements are available in various configurations, and how those measurements are computed.

Basic Voltage and Current Measurements

The Type softkey on the Measurement Menu includes eight voltage or current measurements based on Continuous Whole-cycle Analysis (CWA). The icons are shown in the blue color that is used throughout the user interface to indicate CWA measurements.

Note that the items in the image above all refer to voltage in this case. This means that the selected source is a voltage signal. If the selected source is a current signal, all eight items will refer to current instead of voltage.

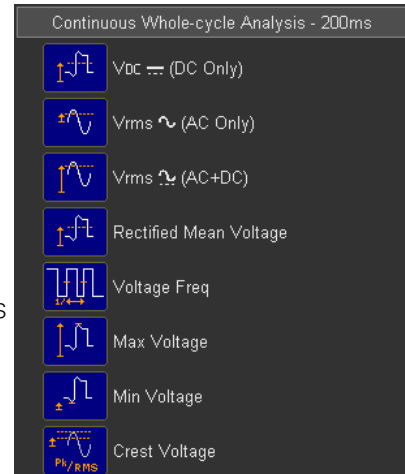

Basic Power Measurements

If the selected source is a power signal, you can choose from the following CWA measurements.

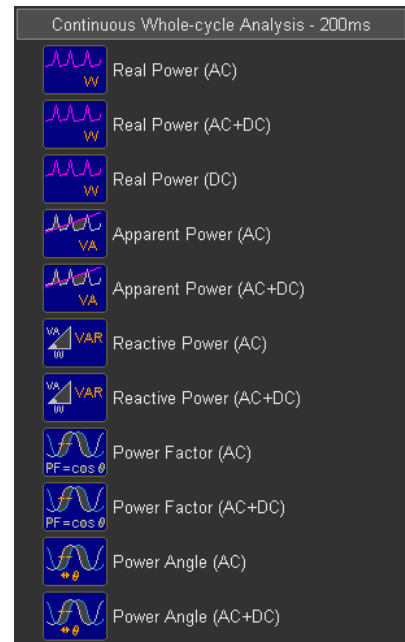

Group Measurements

The following measurements are available for wiring groups, as shown below.

Measurement	1P-3W-2M	3P-3W-2M	3P-3W-3M	3P-4W-3M
VDC (DC Only)	•	•	•	•
ADC (DC Only)	•	•	•	•
Vrms (AC Only)	•	•	•	•
Arms (AC Only)	•	•	•	•
Vrms (AC+DC)	•	•	•	•
Arms (AC+DC)	•	•	•	•
Real Power (AC)	•	•		•
Real Power (AC+DC)	•	•	•	•
Real Power (DC)	•	•		•
Rectified Mean Voltage	•	•	•	•
Rectified Mean Current	•	•	•	•
Apparent Power (AC)	•	•		•
Apparent Power (AC+DC)	•	•	•	•
Reactive Power (AC)	•	•		•
Reactive Power (AC+DC)	•	•	•	•
Power Factor (AC)	•	•		•
Power Factor (AC+DC)	•	•	•	•
Max Voltage	•	•	•	•
Min Voltage	•	•	•	•
Max Current	•	•	•	•
Min Current	•	•	•	•
Power Angle (AC)	•	•		•
Power Angle (AC+DC)	•	•	•	•

Group Measurements - Delta-Wye and Wye-Delta

The following Delta-Wye and Wye-Delta measurements are available for wiring groups, as shown below.

Measurement	1P-3W-2M	3P-3W-2M	3P-3W-3M	3P-4W-3M
Delta-Wye, Wye-Delta				
Differential Voltage (AC+DC)	•			
Differential Voltage (AC)	•			
Differential Voltage (DC)	•			
Differential Current (AC+DC)	•			
Neutral Current (AC+DC)	•		•	•
Neutral Current (AC)	•			
Neutral Current (DC)	•			
Unmeasured Voltage (AC+DC)		•		
Unmeasured Current (AC+DC)		•		
Delta-Wye Voltage L1 (AC+DC)		•	•	
Delta-Wye Voltage L2 (AC+DC)		•	•	
Delta-Wye Voltage L3 (AC+DC)		•	•	
Delta-Wye Power L1 (AC+DC)		•	•	
Delta-Wye Power L2 (AC+DC)		•	•	
Delta-Wye Power L3 (AC+DC)		•	•	
Delta-Wye Apparent Power L1 (AC+DC)		•	•	
Delta-Wye Apparent Power L2 (AC+DC)		•	•	
Delta-Wye Apparent Power L3 (AC+DC)		•	•	
Delta-Wye Reactive Power L1 (AC+DC)		•	•	
Delta-Wye Reactive Power L2 (AC+DC)		•	•	
Delta-Wye Reactive Power L3 (AC+DC)		•	•	
Wye-Delta Voltage L1 > L2 (AC+DC)				•
Wye-Delta Voltage L2 > L3 (AC+DC)				•
Wye-Delta Voltage L3 > L1 (AC+DC)				•

Equations for single-phase wiring groups

	1P-2W-1M or 1P-2W-3M	1P-2W-3M only
Voltage	$V_x = RMS(v_x)$	$V_{avg} = (V_1 + V_2) / 2$ $V_{diff} = RMS(v_1 - v_2)$
Current	$I_x = RMS(i_x)$	$I_{avg} = (I_1 + I_2) / 2$ $I_n = RMS(i_1 + i_2)$
Power	$P_x = AVG(v_x * i_x)$	$P_{sum} = P_1 + P_2$
Apparent Power	$S_x = V_x * I_x$	$S_{sum} = S_1 + S_2$
Reactive Power*	$Q_x = \pm \sqrt{S_x^2 - P_x^2}$	$Q_{sum} = Q_1 + Q_2$
Power Factor	$\lambda_x = P_x / S_x$	$\lambda_{sum} = P_{sum} / S_{sum}$
Power Angle	$acos(\lambda_x)$	
Rectified Mean Voltage	$V_{rect} = AVG(v_x)$	
Rectified Mean Current	$I_{rect} = AVG(i_x)$	
Crest Voltage	$V_{crest} = MAX(V_{max} , V_{min}) / RMS(v_x)$	
Crest Current	$I_{crest} = MAX(I_{max} , I_{min}) / RMS(i_x)$	

* For Reactive Power, the sign in front of the square root is + for lagging current and -1 for leading current. The Voltage and Current CWA frequency must be within 5% to detect leading or lagging.

Equations for three-phase wiring groups

In the following table, subscript numbers refer to the channel number in the wiring group. For example, V_2 is the voltage on leg 2. The subscript "n" means "neutral." For example, V_{1n} is the voltage from leg 1 to neutral.

Equations in table are shown for AC+DC meas mode and calculate RMS using the formula:

$$RMS(x) = \sqrt{\frac{1}{N} \sum_{n=0}^{N-1} x_n^2}$$

	3P-3W-2M	3P-3W-3M	3P-4W-3M
Voltage as Wye	$V_{1n} = RMS\left(v_1 - \frac{v_1 + v_2}{3}\right)$	$V_{1n} = RMS\left(v_1 - \frac{v_1 - v_2}{3}\right)$	$V_x = RMS(v_x)$
	$V_{2n} = RMS\left(v_2 - \frac{v_1 + v_2}{3}\right)$	$V_{2n} = RMS\left(-\frac{v_1 - v_2}{3}\right)$	
	$V_{3n} = RMS\left(-\frac{v_1 + v_2}{3}\right)$	$V_{3n} = RMS\left(-v_2 - \frac{v_1 - v_2}{3}\right)$	
	$V_{avg} = (V_{1n} + V_{2n} + V_{3n}) / 3$		$V_{avg} = (V_1 + V_2 + V_3) / 3$
Voltage as Delta	$V_{13} = RMS(v_1)$	$V_{12} = RMS(v_1)$	$V_{12} = RMS(v_1 - v_2)$
	$V_{23} = RMS(v_2)$	$V_{23} = RMS(v_2)$	$V_{23} = RMS(v_2 - v_3)$
	$V_{12} = RMS(v_1 - v_2)$	$V_{31} = RMS(v_3)$	$V_{31} = RMS(v_3 - v_1)$
	$V_{avg} = (V_{13} + V_{23}) / 2$	$V_{avg} = (V_{12} + V_{23} + V_{31}) / 3$	
Current		$I_1 = RMS(i_1)$	
		$I_2 = RMS(i_2)$	
	$I_3 = RMS(-i_1 - i_2)$	$I_3 = RMS(i_3)$	
	$I_{avg} = (I_1 + I_2) / 2$	$I_{avg} = (I_1 + I_2 + I_3) / 3$	
	$I_n = RMS(i_1 + i_2 + i_3)$		
Power	$P_x = AVG(v_x * i_x)$	$P_1 = AVG(v_{1n} * i_1)$	$P_x = AVG(v_x * i_x)$
		$P_2 = AVG(v_{2n} * i_2)$	
		$P_3 = AVG(v_{3n} * i_3)$	
	$P_{sum} = P_1 + P_2$	$P_{sum} = P_1 + P_2 + P_3$	

	3P-3W-2M	3P-3W-3M	3P-4W-3M
Apparent Power	$S_x = V_x * I_x$	$S_1 = V_{1n} * I_1$ $S_2 = V_{2n} * I_2$ $S_3 = V_{3n} * I_3$	$S_x = V_x * I_x$
	$S_{sum} = \frac{\sqrt{3}}{2} (S_1 + S_2)$		$S_{sum} = S_1 + S_2 + S_3$
Reactive Power*	$Q_x = \pm \sqrt{S_x^2 - P_x^2}$	$Q_1 = \sqrt{S_1^2 - P_1^2}$ $Q_2 = \sqrt{S_2^2 - P_2^2}$ $Q_3 = \sqrt{S_3^2 - P_3^2}$	$Q_x = \pm \sqrt{S_x^2 - P_x^2}$
	$Q_{sum} = Q_1 + Q_2$	$Q_{sum} = \sqrt{S_{sum}^2 - P_{sum}^2}$	$Q_{sum} = Q_1 + Q_2 + Q_3$
Power Factor		$\lambda_x = P_x / S_x$ $\lambda_{sum} = P_{sum} / S_{sum}$	

* For Reactive Power, the sign in front of the square root is + for lagging current and -1 for leading current. The Voltage and Current CWA frequency must be within 5% to detect leading or lagging.

For AC and DC measurement modes, adjust the formulas as shown below.

Measurement Mode	Replace	Real Power
DC	Replace RMS(x) with AVG(x): $AVG(x) = \sqrt{\frac{1}{N} \sum_{n=0}^{N-1} x_n^2}$	Real power is DC power only: $P_x = AVG(v_x) * AVG(i_x)$
AC	Replace RMS(x) with RMS_AC(x): $RMS_AC(x) = \sqrt{RMS(x)^2 - AVG(x)^2}$	Real power has DC component subtracted out: $P_x = AVG(v_x * i_x) - AVG(v_x) * AVG(i_x)$

7 Power Analysis

[Analysis Mode Overview](#)

[Power Quality](#)

[Harmonics](#)

[Energy](#)

[Efficiency](#)

[I²t](#)

Analysis Mode Overview

The power analyzer support four power analysis applications. Before you run any power analysis, be sure that the current channel or channels are configured correctly. To access these applications, press **[Analyze]** > **Analysis** to open the menu shown below. Then choose the analysis to perform.

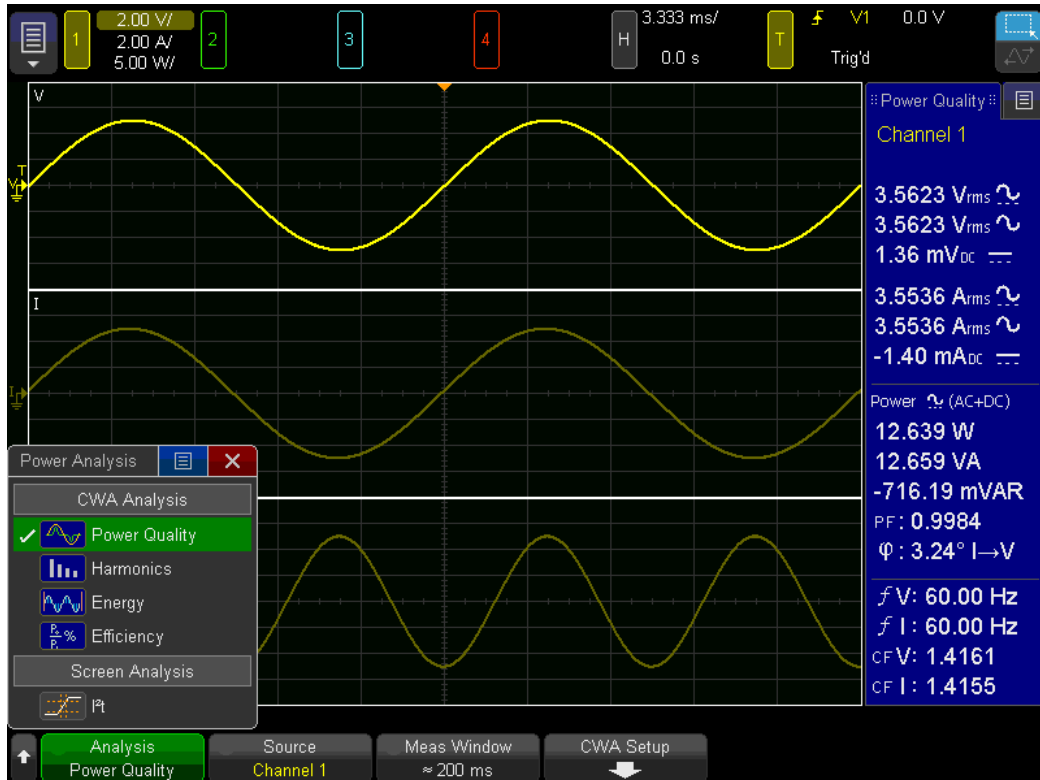

Power Quality

The Power Quality analysis shows the quality of AC power. Some AC current may flow into and back out of the load without delivering energy. This current, called reactive or harmonic current, gives rise to an "apparent" power that is larger than the actual power consumed. Power quality is gauged by power factor, apparent power, true power, reactive power, crest factor, and phase angle of the current and voltage of the AC line.

Power Factor – Ratio of the actual power to the apparent power.

Real (Actual) Power – The portion of power flow that, averaged over a complete cycle of the AC waveform, results in net transfer of energy in one direction.

Apparent Power – The portion of power flow due to stored energy, which returns to the source in each cycle.

Reactive Power – The difference between apparent power and real power due to reactance.

Crest Factor – Crest factor is the ratio between the instantaneous peak current/voltage required by the load and the RMS current/voltage.

Phase Angle – In the power triangle ($\text{apparent_power}^2 = \text{real_power}^2 + \text{reactive_power}^2$), phase angle is the angle between the apparent and real power, indicating the amount of reactive power.

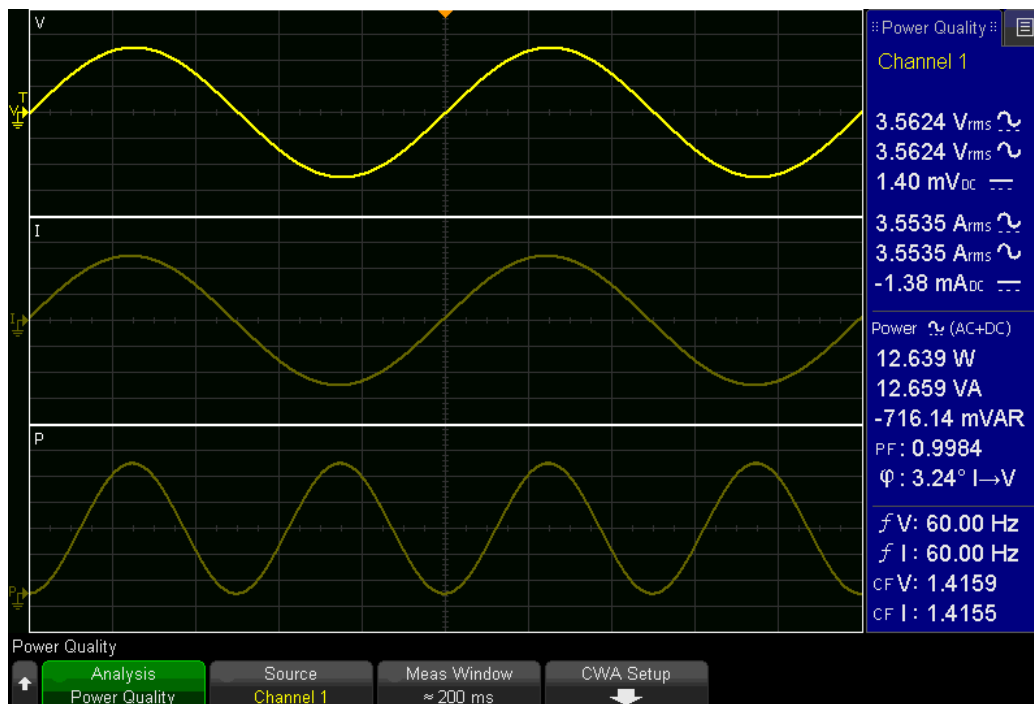

After selecting the Power Quality analysis, choose the Source (Channel 1 or Channel 2) to measure, and then configure CWA as usual. Note that you can also modify the CWA measurement window from either the main Power Quality menu or under the CWA Setup menu.

Power Quality Sidebars

The values in the Power Quality sidebar vary by wiring configuration and are described below. For details regarding the mathematical formulas, see [Mathematics of CWA Measurements](#).

Sidebar for 1P-2W-1M wiring

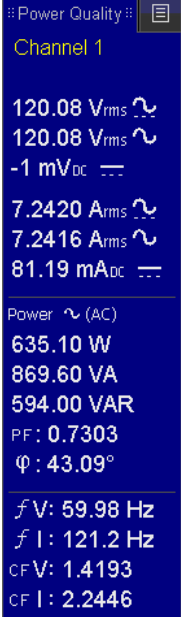
	From top to bottom, the values reported are:
	– Voltage: RMS, AC, and DC offset
	– Current: RMS, AC, and DC offset
	– Real, apparent, and reactive power
	– Power factor
	– Phase angle by which voltage leads current
	– Voltage and current frequency
	– Voltage and current crest factor

Sidebar for 1P-3W-2M wiring

Power Quality

Group A

1P-3W-2M

120.15 V_{rms avg}
 L1: 120.08 Vrms
 L2: 120.21 Vrms
 L1→L2: 208.09 Vrms

5.0834 A_{rms avg}
 L1: 7.2420 Arms
 L2: 2.9247 Arms
 N: 9.2435 Arms

892.46 W_{sum}
 L1: 635.10 W
 L2: 257.35 W

1.2212 kVA_{sum}
 L1: 869.65 VA
 L2: 351.59 VA

833.63 VAR_{sum}
PF: 0.7308_{avg}

f_{V_{Li}}: 59.98 Hz
f_{I_{Li}}: 121.2 Hz

From top to bottom, the values reported are:

- Vrms: Avg, L1, L2, and L1→L2
- Arms: Avg, L1, L2, and N
- Power (W): Total, L1, and L2
- Power (VA): Total, L1, and L2
- Reactive power (total)
- Power factor (avg)
- Voltage and current frequency, L1

Sidebar for 3P-3W-2M wiring

Power Quality

Group A

3P-3W-2M - as Δ

120.15 V_{rms avg}
 L1→L2: 120.08 Vrms
 L2→L3: 120.21 Vrms
 L3→L1: 208.09 Vrms*

6.6442 A_{rms avg}
 L1: 7.2420 Arms
 L2: 6.0464 Arms*
 L3: 6.0464 Arms

892.46 W_{sum}
 L1: 547.68 W
 L2: 215.53 W

1.0576 kVA_{sum}
 L1: 767.14 VA
 L2: 309.95 VA

567.53 VAR_{sum}
PF: 0.8438_{avg}

f_{V_{Li}}: 59.98 Hz
f_{I_{Li}}: 121.2 Hz

From top to bottom, the values reported are:

- Vrms: Avg and between each pair
- Arms: Avg, L1, L2, and L3
- Power (W): Total, L1, and L2
- Power (VA): Total, L1, and L2
- Reactive power (total)
- Power factor (avg)
- Voltage and current frequency, L1

Sidebar for 3P-3W-3M wiring

Power Quality	
Group A	
3P-3W-3M - as Δ	
120.47 V_{rms} avg	- Vrms: Avg and each pair
L1→L2: 120.08 Vrms	- Arms: Avg and each line
L2→L3: 120.21 Vrms	
L3→L1: 121.11 Vrms	- Power (W): Total and each line
5.6380 A_{rms} avg	- Power (VA): Total and each line
L1: 7.2420 Arms	- Reactive power (total)
L2: 2.9247 Arms	- Power factor (avg)
L3: 6.7473 Arms	- Voltage and current frequency, L1
<hr/>	
698.39 W sum	
L1: 299.13 W	
L2: 129.75 W	
L3: 269.51 W	
1.1734 kVA sum	
L1: 502.18 VA	
L2: 202.86 VA	
L3: 468.38 VA	
942.96 VAR sum	
PF: 0.5952 avg	
f_{V_{Li}}: 59.98 Hz	
f_{I_{Li}}: 121.2 Hz	

Sidebar for 3P-4W-3M wiring

Power Quality	
Group A	
3P-4W-3M - as Y	
120.47 V_{rms} avg	- Vrms: Avg and each line to neutral
L1→N: 120.08 Vrms	- Arms: Avg and each line (including neutral)
L2→N: 120.21 Vrms	
L3→N: 121.11 Vrms	- Power (W): Total and each line
5.6380 A_{rms} avg	- Power (VA): Total and each line
L1: 7.2420 Arms	- Reactive power (total)
L2: 2.9247 Arms	- Power factor (avg)
L3: 6.7473 Arms	- Voltage and current frequency, L1
N: 3.9506 Arms	
<hr/>	
1.4748 kW sum	
L1: 635.10 W	
L2: 257.35 W	
L3: 582.37 W	
2.0384 kVA sum	
L1: 869.65 VA	
L2: 351.59 VA	
L3: 817.17 VA	
1.4071 kVAR sum	
PF: 0.7235 avg	
f_{V_{Li}}: 59.98 Hz	
f_{I_{Li}}: 121.2 Hz	

Single channels in a wiring group

If the source for your sidebar is a single channel of a wiring group (Channel 2 in the image below), you can view the voltages as line-to-neutral (Y) or line-to-line (Δ) values. Use the **Show Volts As** softkey to specify your preference.

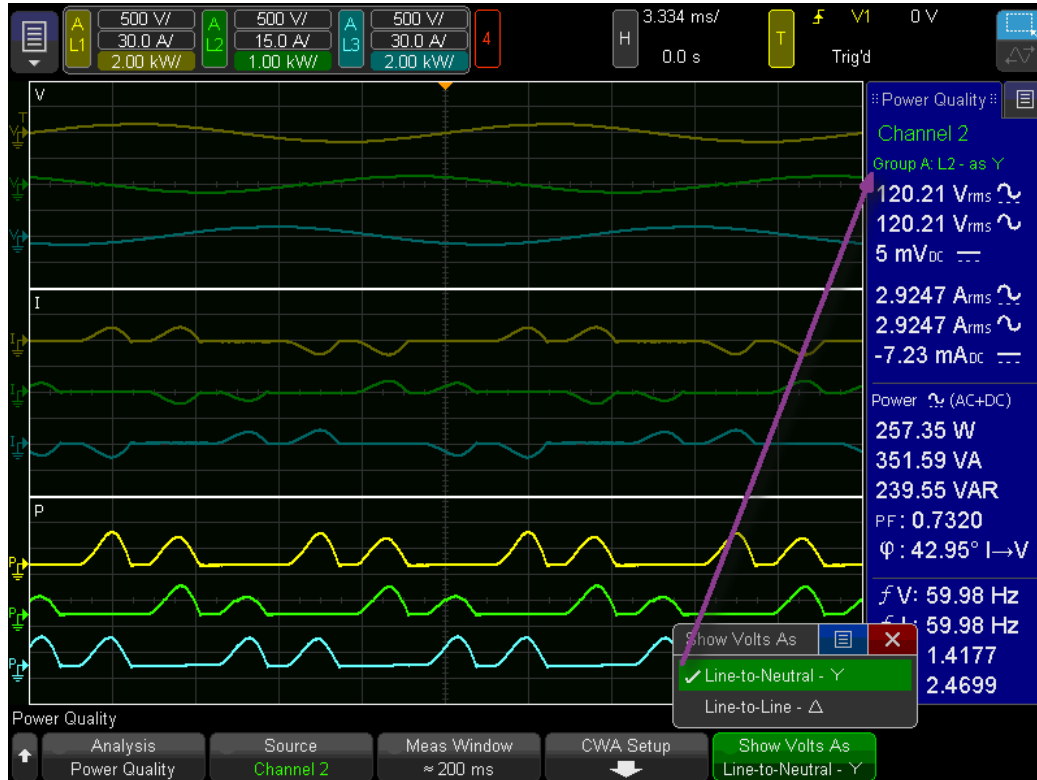

Harmonics

The Harmonics analysis measures total harmonic distortion (THD) and the RMS values of multiple harmonics of a fundamental frequency.

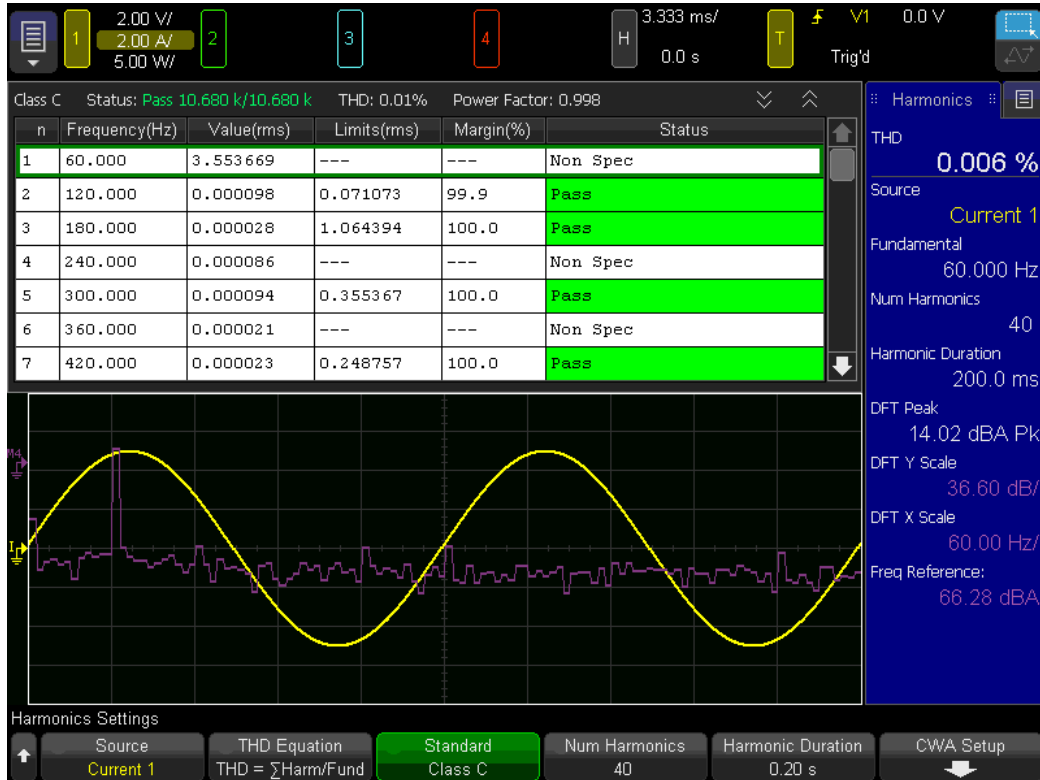

To configure Harmonics analysis:

1. Press the **Source** softkey and choose the source to analyze.
2. Press the **Fundamental** softkey and specify the fundamental frequency.
3. Press the **Settings** softkey and use the softkeys to specify the number of harmonics to measure and the time period (**Harmonic Duration**) over which to measure the harmonics, as shown below.



By default, the harmonics results are displayed in a table, as shown above. You can scroll through this table either by using the table's scroll bar or by pressing the **Scroll** softkey and turning the **Entry** knob.

In addition to the displaying the table, you can press the Display softkey and choose from three other display options:

Off

(Neither the table nor the bar chart is displayed)

Bar Chart

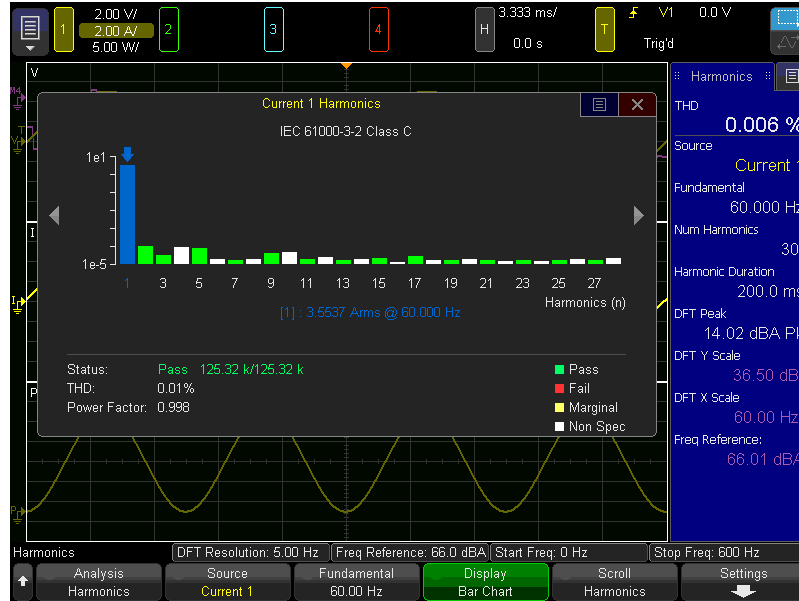
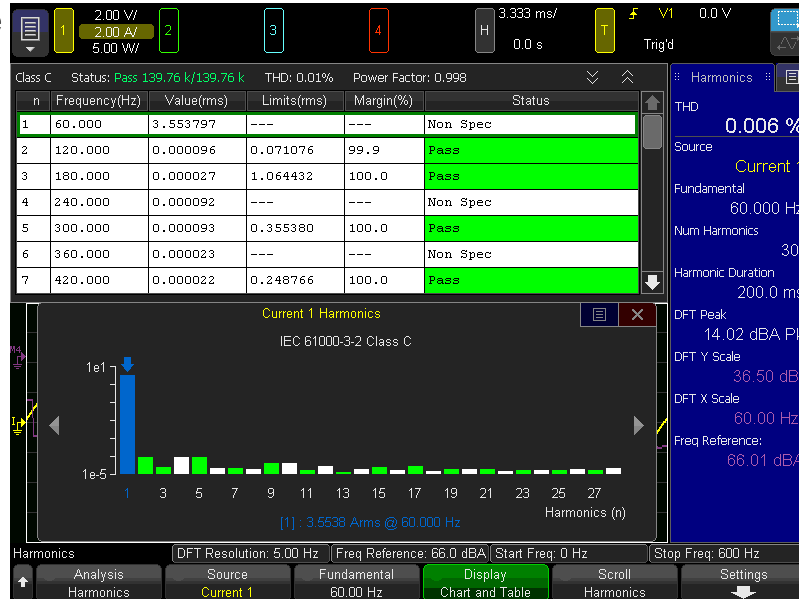

Chart and Table



You can use the arrows on both sides of the bar chart to scroll through the chart, or you can press the **Scroll** softkey and turn the **Entry** knob. The table and chart always scroll together; if row 3 in the table is highlighted, the bar for harmonic 3 will turn blue, as shown below.



Discrete Fourier Transform (DFT) Configuration

The Harmonics sidebar contains several DFT values near the bottom. To configure the DFT during a Harmonics analysis, press **[Math]** to display the following softkeys.



The DFT is automatically configured as Math waveform 4, and you can use the remaining softkeys to configure the source, X-axis span and center, and vertical units (Decibels or RMS). For example, a span of 3 kHz with a center of 2 kHz would go from 0.5 to 3.5 kHz.

You can also use the fourth and fifth softkeys in this menu to specify the X-axis as start and stop frequencies if you prefer.

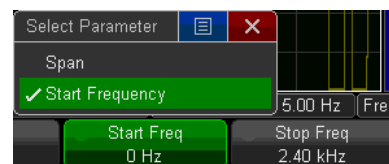

Precompliance Testing for IEC 61000-3-2, Classes A through D

Switching power supplies draw a range of harmonics from the AC mains. Standard limits are set for these harmonics because these harmonics can return to the supply grid and cause problems with other devices on the grid.

Use the Current Harmonics analysis to test a switching power supply's current harmonics to precompliance standard of IEC61000-3-2 (Class A, B, C, or D). The analysis presents up to 40 harmonics.

To perform precompliance testing:

1. Press **[Analyze]** > **Analysis** > **Harmonics**.
2. Press **Settings** > **Source** and choose a current channel.
3. Press **Fundamental** and specify the fundamental frequency of the signal.
4. Press **Standard** and select the appropriate IEC standard to test against.

Standard	Applications
IEC 61000-3-2 Class A	Balanced three-phase equipment, household appliances (except equipment identified as Class D), tools excluding portable tools, dimmers for incandescent lamps, and audio equipment.
IEC 61000-3-2 Class B	Portable tools.
IEC 61000-3-2 Class C	Lighting equipment.
IEC 61000-3-2 Class D	Personal computers, personal computer monitors, and television receivers with a specified power less than or equal to 600 W.

5. Press **Num Harmonics** and specify the number of harmonics to analyze.
6. Press **CWA Setup** and configure CWA as usual. In most cases, the Sync Source will be the same as the current source chosen above.

Energy

The Energy analysis provides several energy consumption measurements, and it always uses fixed ranging for both voltage and current.

For optimal results, press [1] or [2] (or [3] or [4] on the PA2203A), and then press **Ranging > Ranging Mode > Fixed** and select the smallest appropriate fixed voltage and current measurements ranges for your signal. If either fixed measurement range is too small, you will see an error message saying, "Energy data questionable due to high signal(s) during test."

To configure and run the analysis:

1. Press **[Analyze] > Analysis > Energy**.
2. Press the **Source** softkey and select the source channel to analyze.
3. Press the **Duration** softkey and specify the length of time to make the measurements.
4. Press the **Strip Chart** softkey and configure the three strip chart parameters:
 - a. Press the **Strip Chart Type** softkey and choose the units for your results.

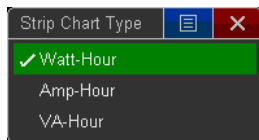

You can always change the units during or after the analysis, so this is actually an optional step.

- b. Use the **X1** and **X2** softkeys to specify the horizontal positions of the measurement markers (in seconds). Again, you can change these values when the analysis is complete, so this is also optional.
5. Press the **CWA Setup** softkey and configure CWA as usual.
6. Press the **Start Meas** softkey to start measuring the Energy analysis parameters.

While the analysis is running, the measurements in the sidebar update. You can press the **Reset Meas** softkey to stop the analysis without clearing the measurements.

Once the measurements have run for the specified duration, the numbers in the blue panel remain at their final values and the rightmost softkey once again becomes **Start Meas**. Note that the Duration reported is likely to be longer than the specified duration because the CWA measurement technique always measures a whole number of measurement cycles in each CWA measurement window.

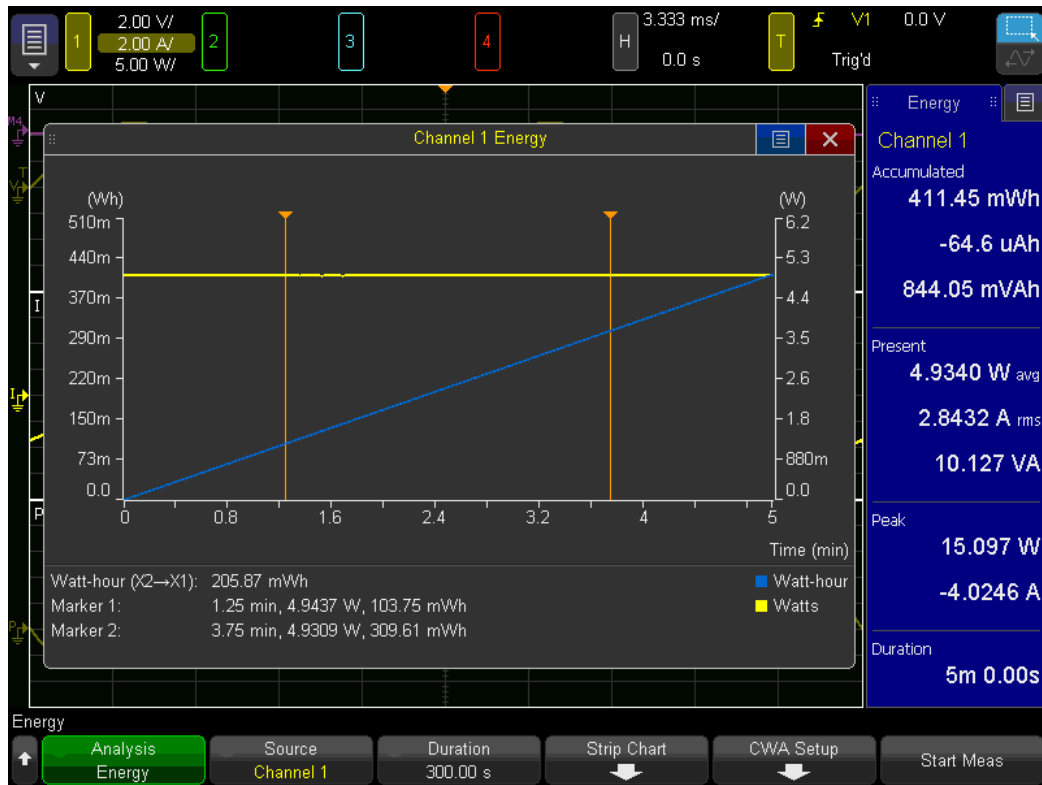

As mentioned above, you can press **Strip Chart > Strip Chart Type** to change the units. For example, the image below shows the strip chart with VA-Hour units. Note that the blue sidebar is not affected by this setting.

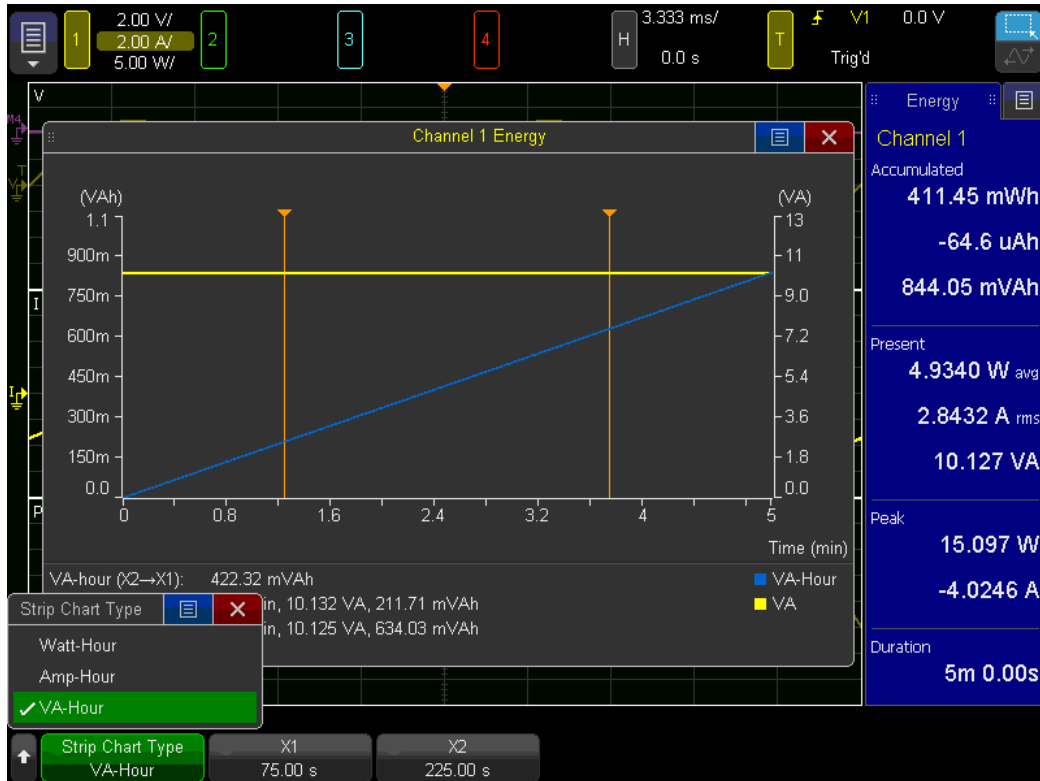

Also as mentioned above, you can change the cursor positions. The cursors in the previous image are 25% and 75% of the way through a 300-s analysis. The image below shows the cursors spread out to capture the middle four minutes of the analysis.

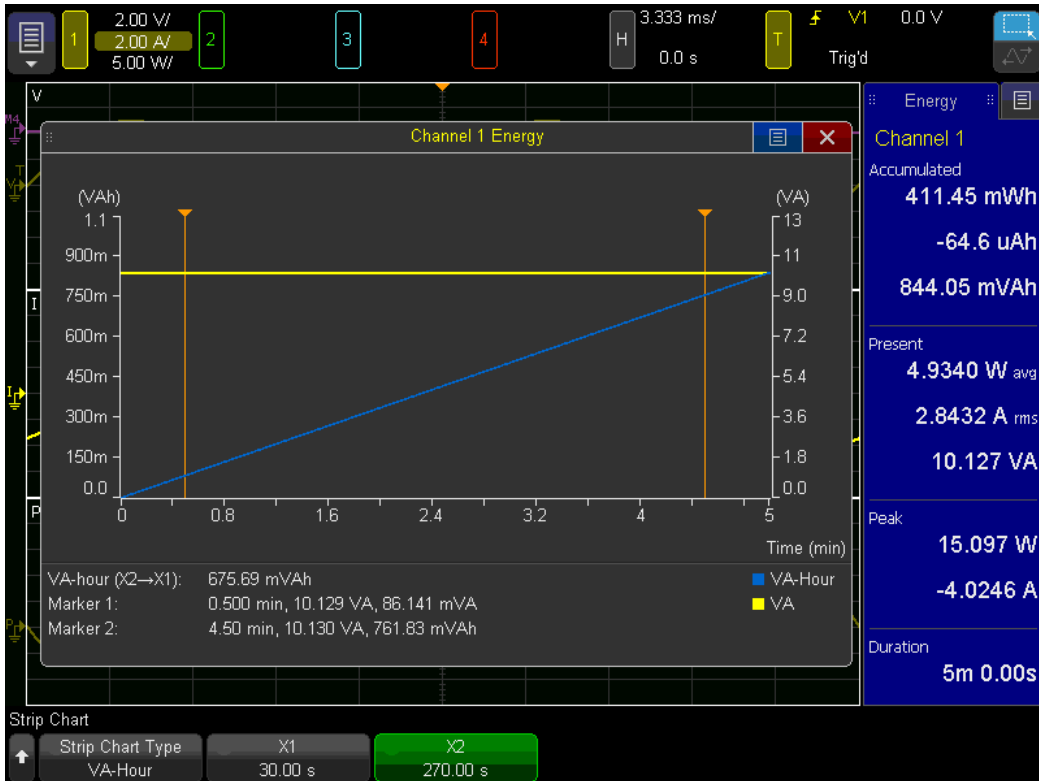

Efficiency

The Efficiency analysis measures the overall efficiency of a power supply, inverter, or converter by dividing the output power by the input power. The Efficiency feature on the PA2203A is similar to that on the PA2201A, but the PA2203A can perform two Efficiency analyses simultaneously.

A sample result from the PA2201A is shown at right.

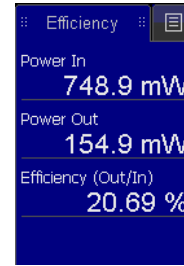

Efficiency Analysis on the PA2201A

To run the Efficiency analysis on the PA2201A:

1. Press **[Analyze]** > **Analysis** > **Efficiency**.



2. Press the **Source In** softkey to select the input power channel.
3. Press the **CWA Setup In** softkey and configure Continuous Whole-Cycle Analysis (CWA) for the input power channel. For details, push and hold the **CWA Setup In** softkey.
4. Press the **Source Out** softkey to select the output power channel.
5. Press the **CWA Setup Out** softkey and configure Continuous Whole-Cycle Analysis (CWA) for the output power channel. For details, push and hold the **CWA Setup Out** softkey.

For best results, ensure that the Source In and Source Out use the same CWA Sync Source. Using the same Sync Source for the input and output ensures that the power measurements are taken over the same time interval, which provides the most accurate efficiency measurement.

Note that there is only one Meas Window parameter for Efficiency on the PA2201A. You can access it under either **CWA Setup** softkey or at the level that contains the two **CWA Setup** softkeys. All three softkeys modify the same parameter.

The Noise Rejection, Sync Offset, and Meas Mode parameters are set independently for the input and output power channels.

Efficiency Analysis on the PA2203A

The PA2203A can perform two efficiency analyses simultaneously. To run an Efficiency analysis on the PA2203A:

1. Press **[Analyze]** > **Analysis** > **Efficiency**.



2. Press the **Efficiency Set** softkey and choose the efficiency set (1 or 2) to configure.
3. Press the **Input** softkey to select the input power channel.
4. Press the **CWA Setup In** softkey and configure Continuous Whole-Cycle Analysis (CWA) for the input power channel. For details, push and hold the **CWA Setup In** softkey.
5. Press the **Output** softkey to select the output power channel.
6. Press the **CWA Setup Out** softkey and configure Continuous Whole-Cycle Analysis (CWA) for the output power channel. For details, push and hold the **CWA Setup Out** softkey.

For best results, ensure that the input and output for a given analysis use the same CWA Sync Source. Using the same Sync Source for the input and output ensures that the power measurements are taken over the same time interval, which provides the most accurate efficiency measurement.

Note that there is only one Meas Window parameter that applies to both Efficiency Set 1 and Efficiency Set 2. You can access it under either **CWA Setup** softkey for either efficiency set. All four softkeys modify the same parameter.

The Noise Rejection, Sync Offset, and Meas Mode parameters are set independently for the input and output power channels.

I^2t

The I^2t analysis integrates the square of the current over time when a device under test is turned on. This relates to the rate at which a circuit heats, which is critical for applications such as sizing a circuit's fuse.

Interpreting an I^2t analysis

An example of an I^2t analysis is shown below:



The bright horizontal yellow line is the current signal (I). It is yellow in this case because the Current Source is Channel 1. The bumpy, bright magenta line is a math function, the square of the current (I^2). The rising purple line is the integral of the I^2 signal over time (I^2t). The orange vertical and horizontal lines are the cursors delimiting the calculations shown in the sidebar.

Performing an I^2t analysis

To configure and run an I^2t analysis:

1. Press **[Analyze]** > **Analysis** > I^2t .

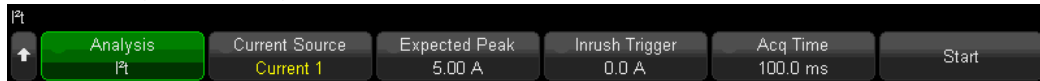

2. Press **Current Source** and select the current channel to measure.
3. Press **[Expected Peak]** and specify the peak current value. The instrument uses this value to select the current measurement range and vertical resolution.
4. Press **Inrush Trigger** and specify the current level at which the analysis will begin. You may want to set this close to the expected peak to avoid falsely triggering on a small transient of current. You can always move the first cursor to the left after running the test, if necessary.
5. Press **Acq Time** and specify the duration of the analysis. It is better to set this a bit too long, rather than too short.
6. Press **Start** and follow the on-screen instructions. These instructions will tell you to turn off the power supply, press **Next**, turn on the power supply, and press **Next** again. The screen will display the result, using a default distance between the cursors as shown below.



7. Position the cursors and read the sidebar to complete the analysis.

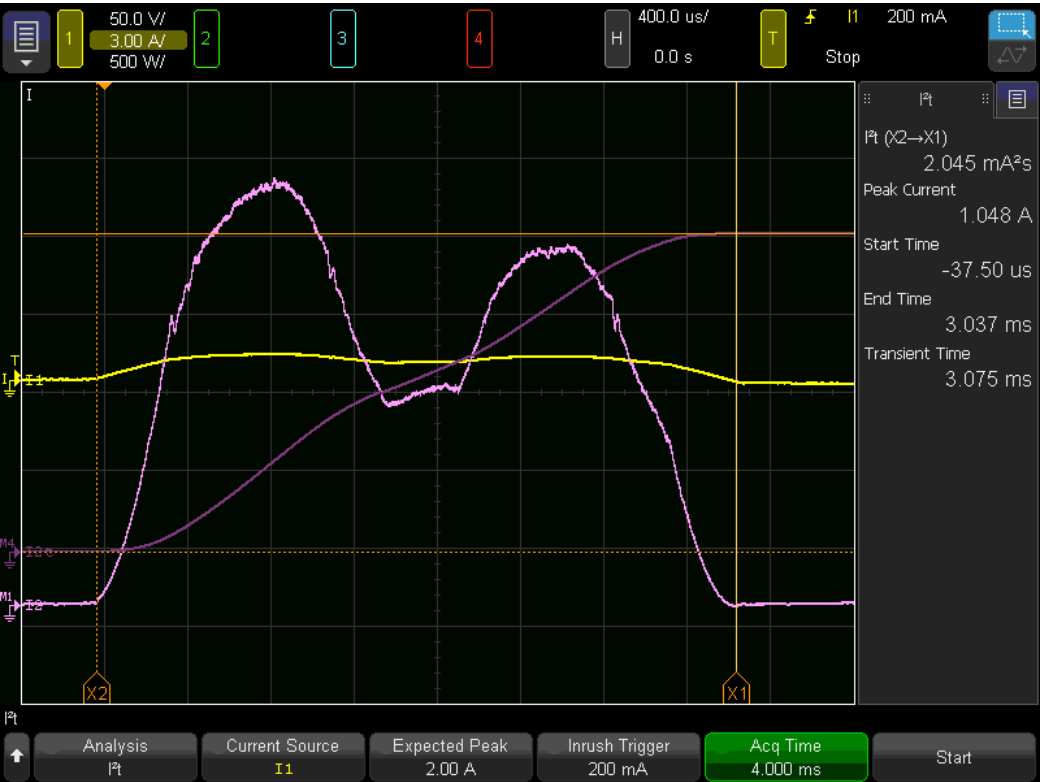

More about setting the Expected Peak

Because the instrument uses the Expected Peak to select the current measurement range and vertical resolution, you should choose a value large enough to accommodate the signal, but not so large that it makes the measurement range or vertical resolution too large.

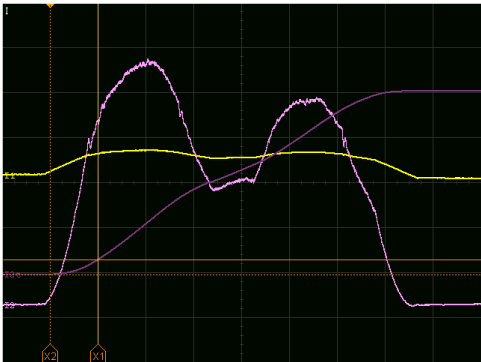

Expected Peak yields appropriate vertical resolution

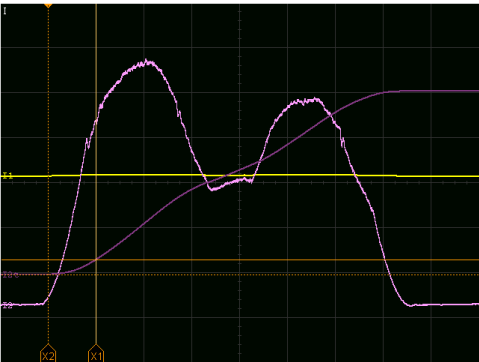

Expected Peak yields vertical resolution too large to show detail

8 Math and Reference Waveforms

[Math Waveform Basics](#)

[Math Operators](#)

[Math Transforms](#)

[FFT Measurement](#)

[Reference Waveforms](#)

Math Waveform Basics

You can define up to four math functions, one of which can be displayed at a time (always in light purple). You can use math operators (add, subtract, multiply, and divide) on voltage, current, and power signals, and you can perform math transforms (integral, derivative, FFT, $Ax+B$, square, and square root) on voltage, current, and power signals and math waveforms.

To display math waveforms

1. Press **[Math] > Display Math** and turn the **Entry** knob to select a math function to display. Then push the **Entry** knob or function.

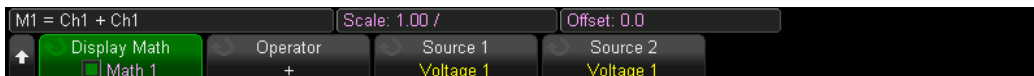

2. Use the **Operator** softkey to select a math operator or transform.
3. Use the **Source 1** softkey to select the signal (or lower math function) on which to perform math. You can rotate the Entry knob or repetitively press the **Source 1** softkey to make your selection.

Higher math functions can operate on lower math functions when using operators other than the simple arithmetic operations (+, -, *, /). For example, if Math 1 is set up as a subtract operation between channels 1 and 2, the Math 2 function could be set up as an FFT operation on the Math 1 function. These are called cascaded math functions.

To cascade math functions, select the lower math function using the **Source 1** softkey.

NOTE For the most accurate results with cascaded math functions, be sure to vertically scale lower math functions so that their waveforms take up the full screen without being clipped.

4. If you selected an arithmetic operator for the math function, use the **Source 2** softkey to select the second source for the arithmetic operation.

You can adjust the vertical scaling and offset of each math function for ease of viewing and measurement considerations. You can also measure the math waveform with **[Cursors]** and/or **[Measure]**.

To adjust the math waveform scale and offset

1. Make sure the scale and position knobs above and below the **[Math]** key are selected for the math waveform. If the arrow to the left of the **[Math]** key is not illuminated, press the key.
2. Use the scale and position knobs above and below the **[Math]** key to resize and reposition the math waveform.

NOTE Math Scale and Offset are Set Automatically

Any time the currently displayed math function definition is changed, the function is automatically scaled for optimum vertical scale and offset. If you manually set scale and offset for a function, select a new function, then select the original function, the original function will be automatically rescaled.

Units for math waveforms

Math function units are shown below.

Math Function Units	
add or subtract	V, A, or W
multiply	V^2 , A^2 , W^2 , W, AW, or VW
divide	Ω , A, V, Ω^{-1} , A^{-1} , or V^{-1}
d/dt	V/s, A/s, or W/s
$\int dt$	Vs, As, or Ws
FFT	dBV, dBI, dBW, V_{rms} , I_{rms} , or W_{rms}
$\sqrt{\text{square root}}$	$V^{1/2}$, $A^{1/2}$, or $W^{1/2}$

A scale unit of **U** (undefined) is displayed for math functions when two source channels are set to a combination of units cannot be resolved, such as current plus voltage.

Math Operators

There are four Math operators, and they operate on voltage, current, and power signals.

Add or Subtract

The Add and Subtract operators add Source 1 and Source 2 point by point and display the result. You can use Subtract to make a differential measurement or to compare waveforms. The image below shows two signals added.

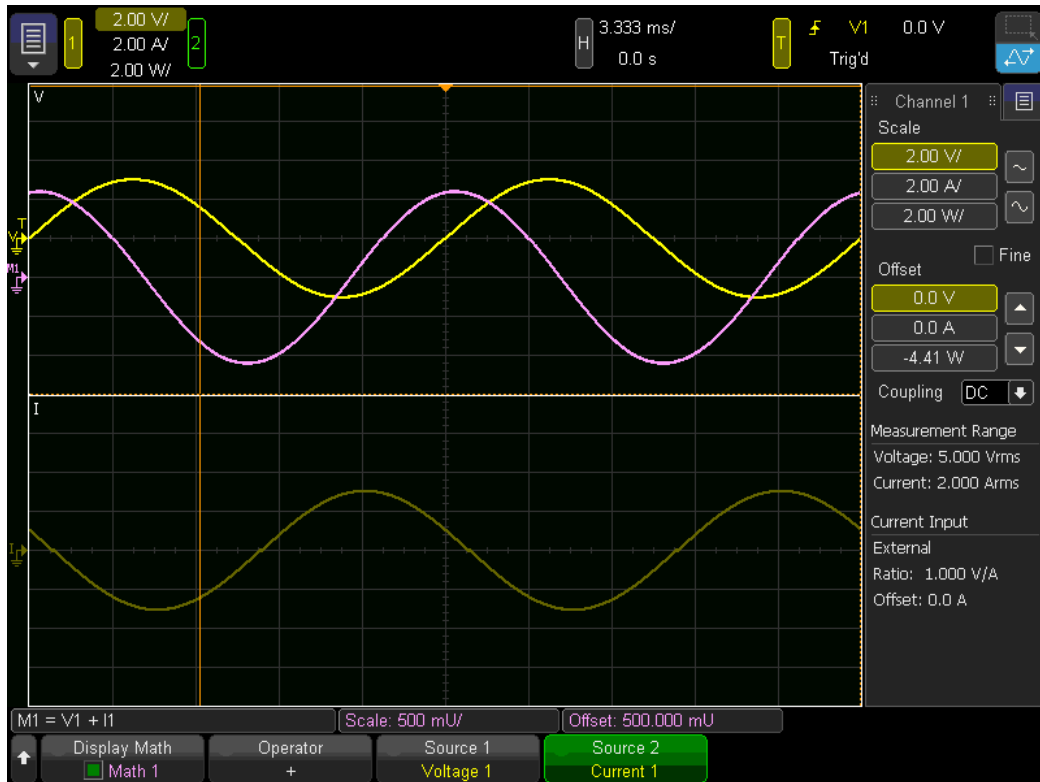

Multiply or Divide

The Multiply and Divide operators multiply or divide Source 1 by Source 2 point by point, and display the result. When the divisor (Source 2) waveform is zero, the math waveform will have holes (zero values). The image below shows two signals multiplied.

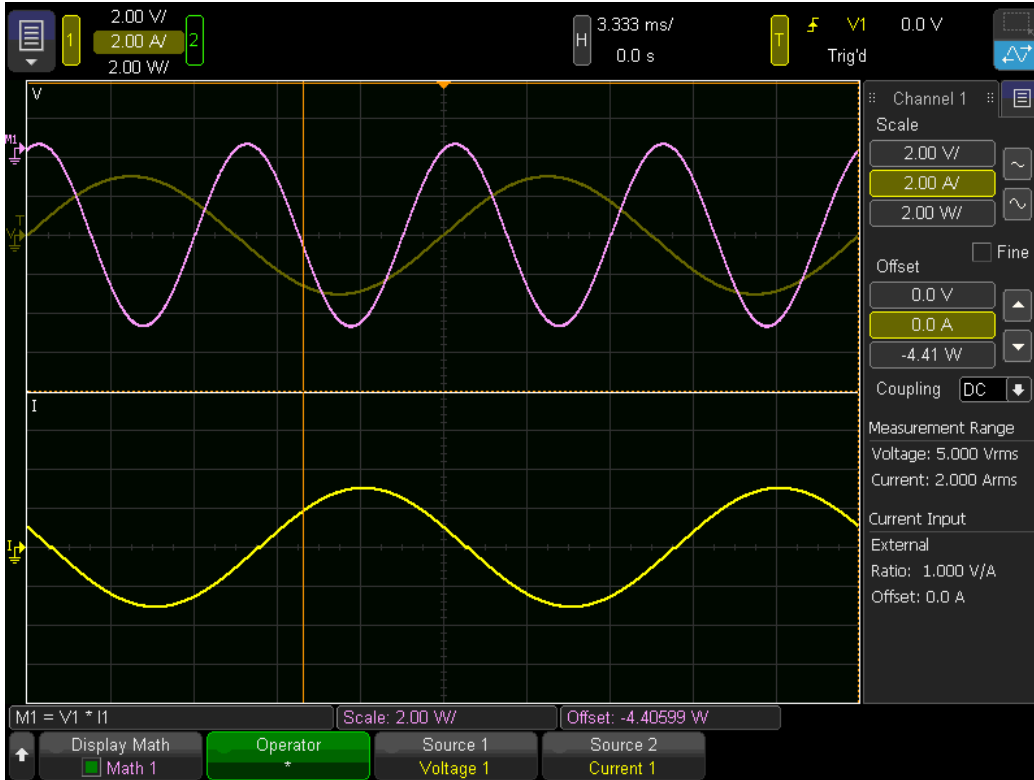

Math Transforms

Math transforms perform a transform function (like differentiate, integrate, FFT, or square root) on a voltage, current, or power signal or on an add, subtract, multiply, or divide math waveform.

Differentiate

Integrate

Square and Square Root

Ax + B

FFT Measurement

Differentiate

The **d/dt** (differentiate) transform calculates the discrete time derivative of the selected source. You can use differentiate to measure the instantaneous slope of a waveform.

The d/dt transform plots the derivative of the selected source using the "average slope estimate at 4 points" formula:

$$d_i = \frac{y_{i+4} + 2y_{i+2} - 2y_{i-2} - y_{i-4}}{8 \Delta t}$$

Where:

d = differential waveform

y = Channel or Math data points

i = data point index

Δt = point-to-point time difference

Integrate

$\int dt$ (integrate) calculates the integral of the selected source. You can use integrate to calculate the energy of a pulse in volt-seconds or measure the area under a waveform.

$\int dt$ plots the integral of the source using the trapezoidal rule:

$$I_n = c_o + \Delta t \sum_{i=0}^n y_i$$

Where:

I = integrated waveform

Δt = point-to-point time difference

y = Channel or Math data points

c_o = arbitrary constant

i = data point index

The Offset softkey lets you enter a DC offset correction for the input signal.



A small DC offset in the integrate function input or a small calibration error can cause the integrate transform output to "ramp" as shown below. Use the **Offset** softkey to remove the offset and prevent ramping.

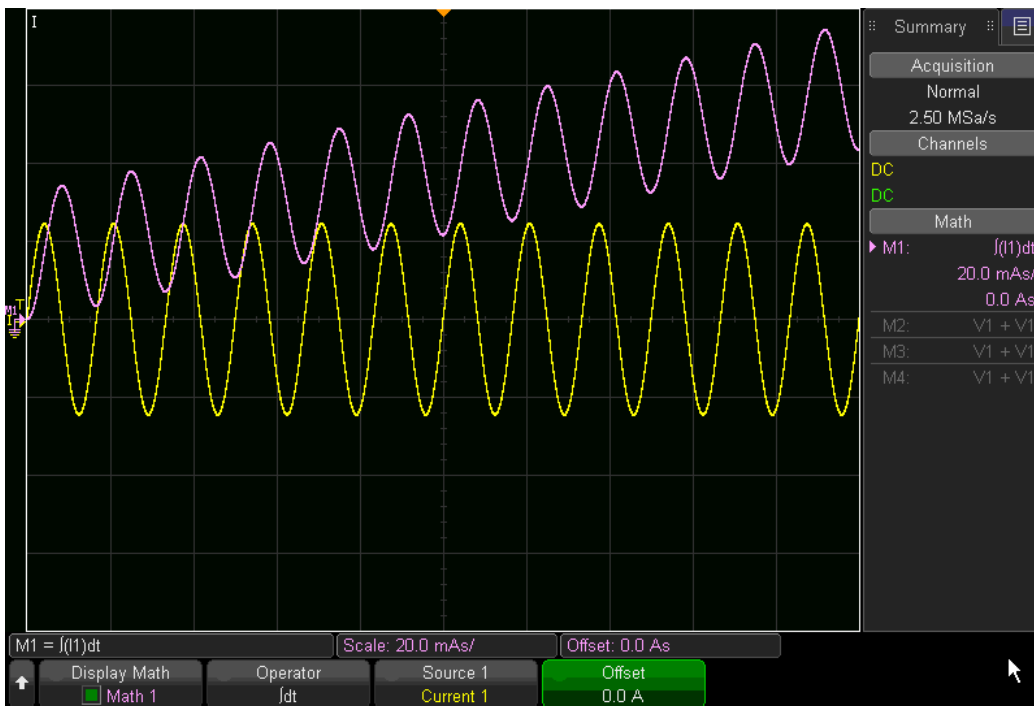

Square and Square Root

The Square and Square Root transforms operate on the selected source, point by point, and display the result. Where the square root is undefined for a particular input, holes (zero values) appear in the function output.

Press the **Source** softkey to select Squared or Square Root ($\sqrt{\quad}$).

To use the Squared transform to calculate I^2t

NOTE You can also calculate I^2t using the **[Analyze]** key. For details, see [I²t](#)

One important use of the Squared function is to calculate I^2t , an important measure in calculating heat generation. Begin by configuring Math 1 with a Current source and Squared as the Operator, as shown below.

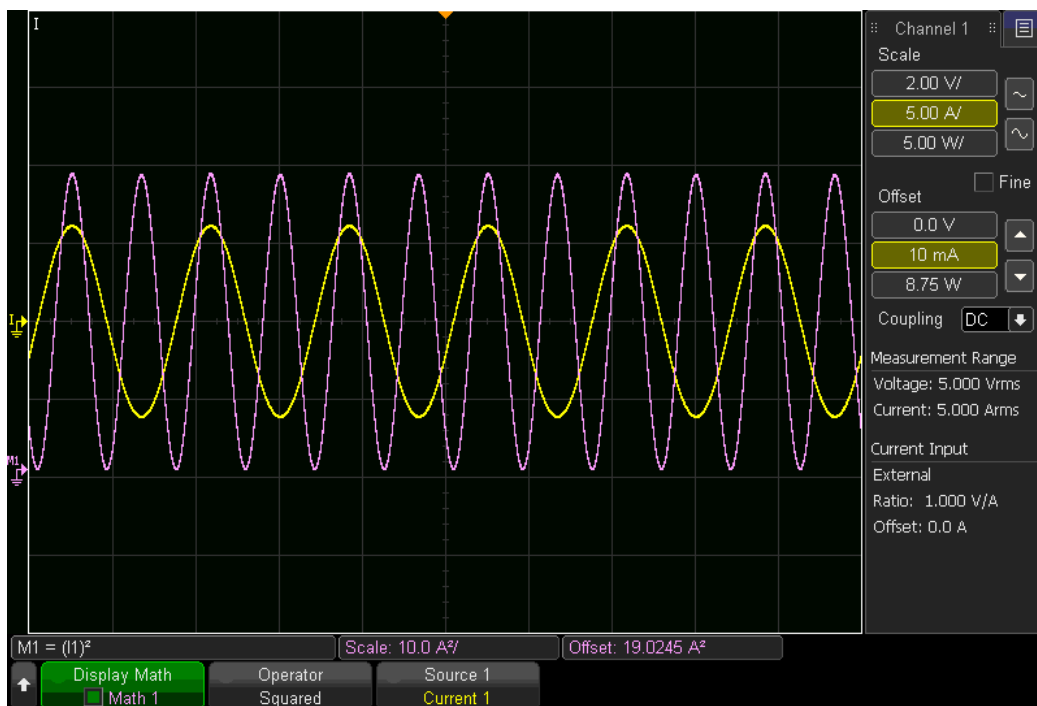

Then configure and display Math 2 with Math 1 as the source and Integrate as the Operator.

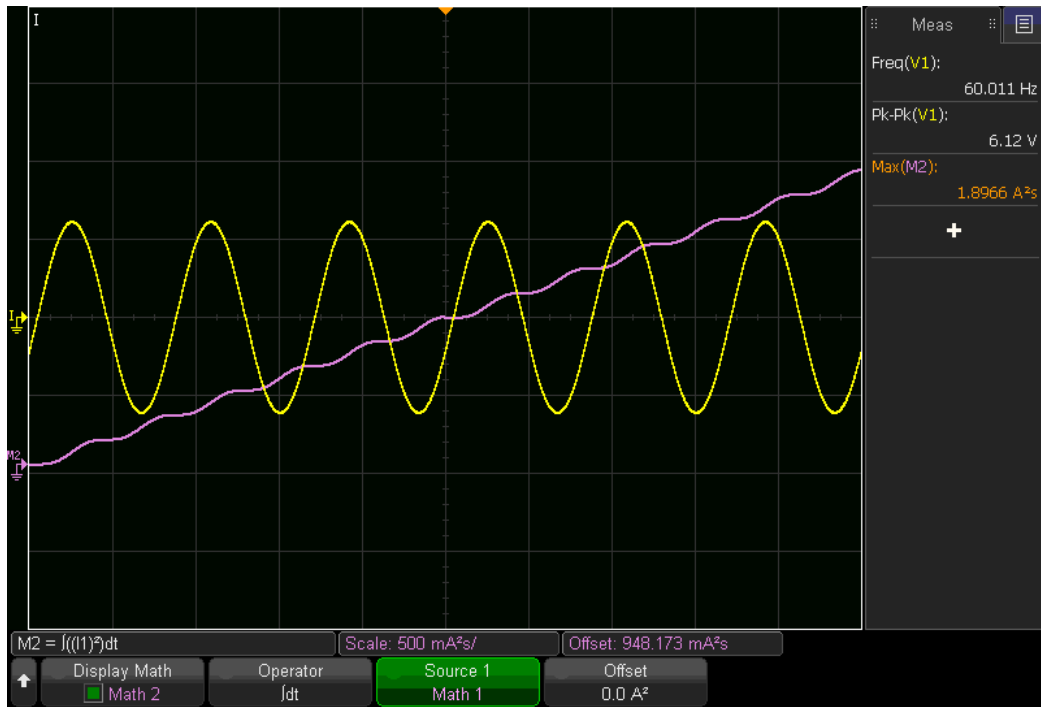

Ax + B

The Ax + B transform applies a gain (A) and offset (B) to an input source. For example, the image below shows an Ax+B transform applied to a sine wave, with A=1 and B=0 (the default values). Note that the Offset indicator of 7.00000 A displayed above the **Gain (A)** softkey refers to the waveform's display offset and not the offset of the math transform.

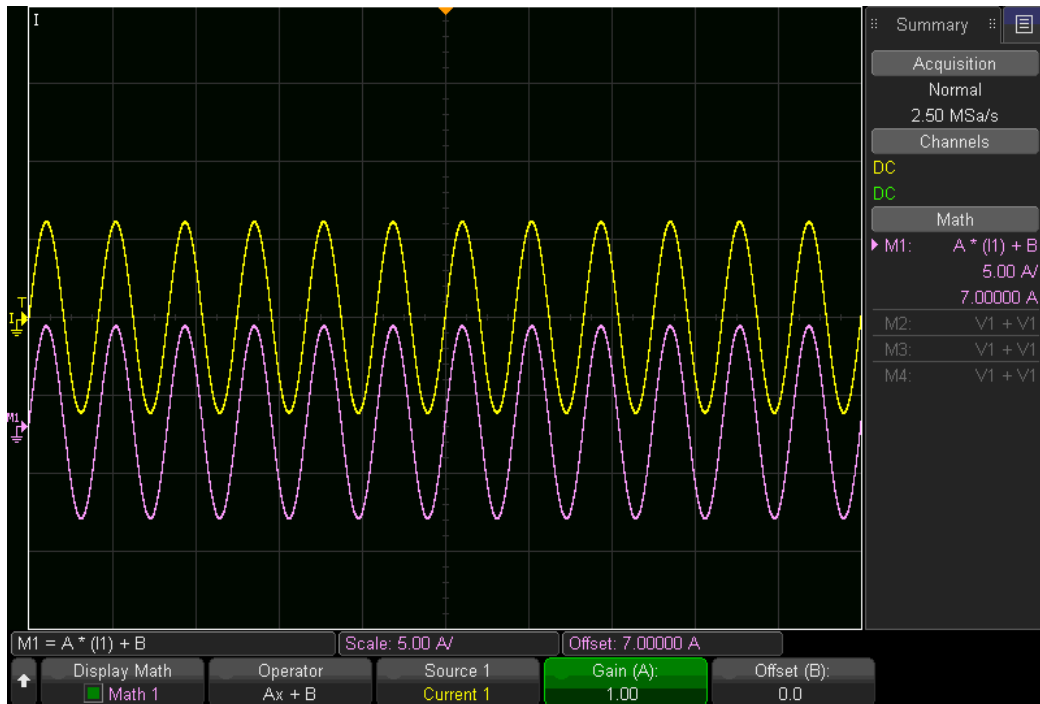

The instrument automatically scales the $Ax+B$ waveform to keep the same relative size and position on the waveform; otherwise, a large or small gain in the transform might make the waveform unreadable. For example, in the image below, the waveform's gain of 20 has caused the display scale and offset to change to 100 A and 140 A, respectively.

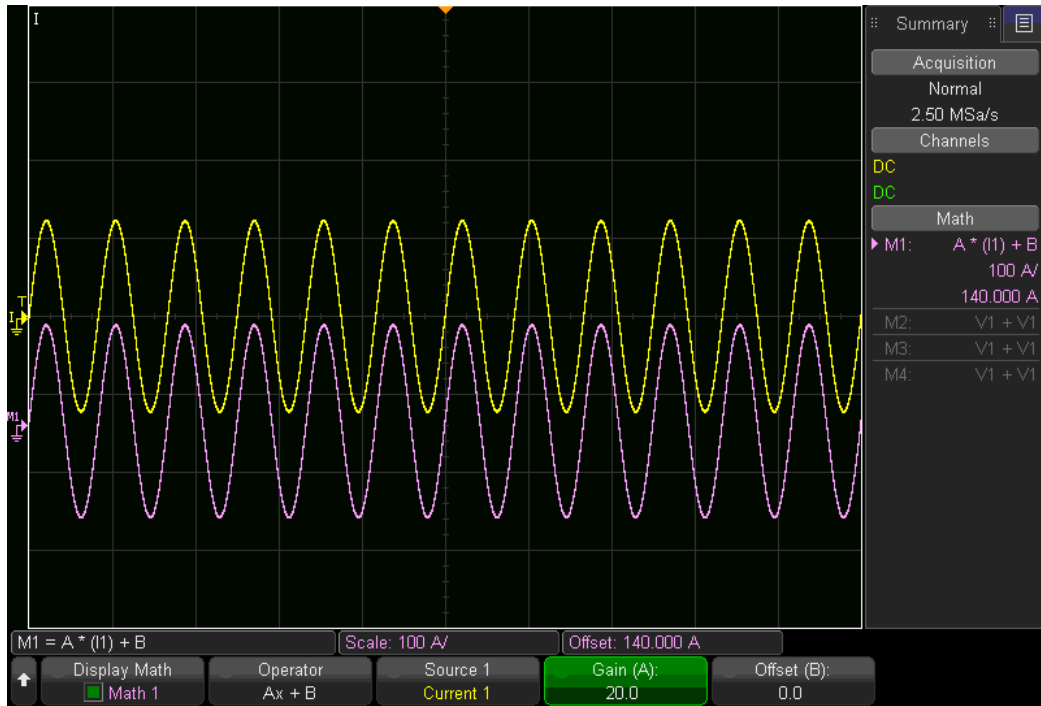

If the instrument had kept the display scale and offset at their original values of 5 and 7 A, the $Ax+B$ waveform would have appeared as nothing more than an unreadable set of nearly vertical lines, as shown below.

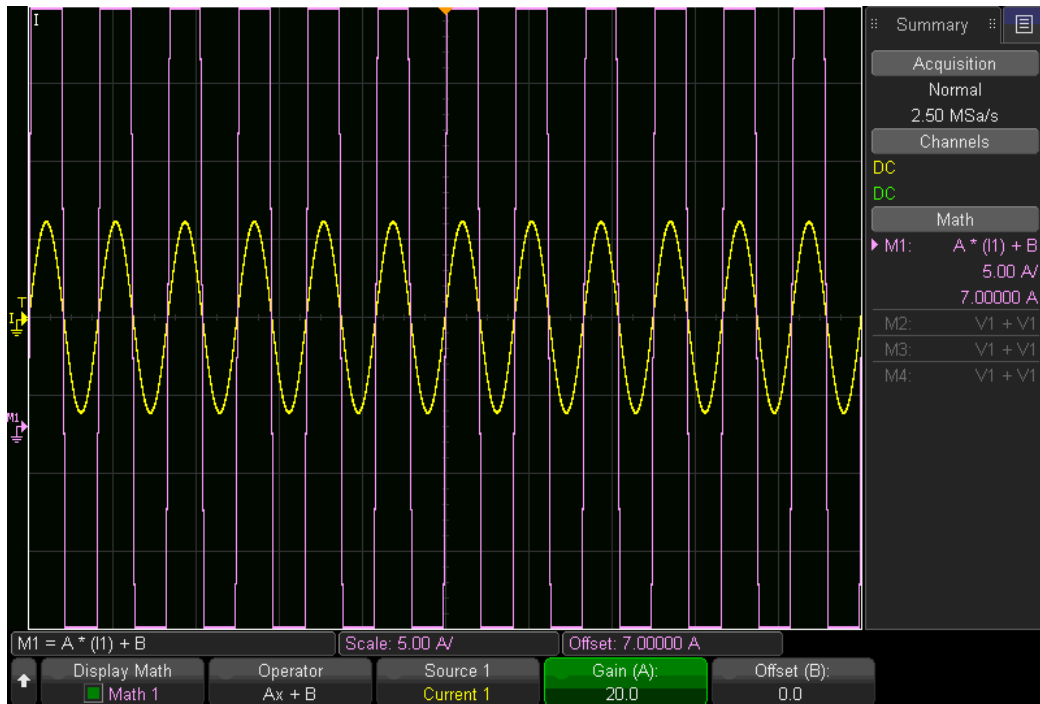

FFT Measurement

Use FFT to compute the fast Fourier transform on voltage, current, power, or math channels. The FFT transform takes the digitized time record of the specified source and transforms it to the frequency domain. When the FFT function is selected, the FFT spectrum is plotted on the display as magnitude versus frequency. The readout for the horizontal axis changes from time to frequency (Hertz) and the vertical readout changes from volts to dB.

To display an FFT waveform:

1. Press **[Math] > Display Math** and select the math function to display.
2. Press the **Operator** softkey and select the FFT Transform.
3. Press **Source 1** and select the source for the FFT.
4. Press **Span** and set the horizontal width of the FFT spectrum to display. If you set this above the maximum available frequency, the displayed spectrum will not take up the whole screen.

5. Press **Center** and specify the FFT spectrum frequency at the display's center vertical grid line. If this is not in the center of span, the displayed spectrum will not take up the whole screen.

You can also change the **Span** and **Center** softkeys to **Start Freq** and **Stop Freq** if you prefer that approach. For example, a span of 200 kHz centered on 150 kHz is equivalent to start and stop frequencies of 50 and 250 kHz.

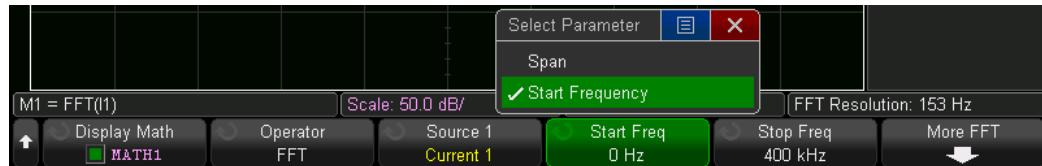

You can also press **More FFT > Auto Setup** to set the **Span** and **Center** to values that will display the entire available spectrum.

6. Press **More FFT** to go to the second page of FFT parameters.



7. Press **Window** and select the window to apply to the FFT input signal:

Hanning — accurate frequency measurements and resolving two close frequencies.

Flat Top — accurate amplitude measurements of frequency peaks

Rectangular — good frequency resolution and amplitude accuracy, but use only where there will be no leakage effects. Use on self-windowing waveforms such as pseudo-random noise, impulses, sine bursts, and decaying sinusoids

Blackman-Harris — reduced time resolution compared to a rectangular window, but improved capacity to detect smaller impulses due to lower secondary lobes

8. Press **Vertical Units** and choose Decibels or V RMS.

To make cursor measurements, press **[Cursors] > Source > Math N**. Use the X1 and X2 cursors to measure frequency values and difference between two frequency values (AX). Use the Y1 and Y2 cursors to measure amplitude and amplitude difference (ΔY).

To make other measurements, press **[Measure] > Source > Math N**. You can make peak-to-peak, maximum, minimum, and average dB measurements on the FFT waveform. You can also find the frequency value at the first occurrence of the waveform maximum by using X at Max Y.

FFT Measurement Hints

Up to 65,536 points may be acquired for the FFT record, and when frequency span is at maximum, all points are displayed. Once the FFT spectrum is displayed, the frequency span and center frequency controls are used much like the controls of a spectrum analyzer to examine the frequency of interest in greater detail. Place the desired part of the waveform at the center of the screen and decrease frequency span to increase the display resolution. As frequency span is decreased, the number of points shown is reduced, and the display is magnified.

While the FFT spectrum is displayed, use the **[Math]** and **[Cursors]** keys to switch between measurement functions and frequency domain controls in FFT Menu.

Decreasing the effective sampling rate by selecting a greater time/div setting will increase the low frequency resolution of the FFT display and also increase the chance that an alias will be displayed. The resolution of the FFT is the effective sample rate divided by the number of points in the FFT. The actual resolution of the display will not be this fine as the shape of the window will be the actual limiting factor in the FFTs ability to resolve two closely spaced frequencies. A good way to test the ability of the FFT to resolve two closely spaced frequencies is to examine the sidebands of an AM sine wave.

For the best vertical accuracy on peak measurements, use the Flat Top window and:

- Configure the input signal to be near full screen, but not clipped.
- Set the FFT vertical resolution to a sensitive range, such as 2 dB/division.

For best frequency accuracy on peaks, use the Hanning window, and:

- Use Cursors to place an X cursor on the frequency of interest.
- Adjust frequency span for better cursor placement.
- Return to the Cursors Menu to fine tune the X cursor.

FFT DC Value

The FFT computation produces an incorrect DC value. It does not take the offset at center screen into account. The DC value is not corrected to accurately represent frequency components near DC.

FFT Aliasing

When using FFTs, it is important to be aware of frequency aliasing. This requires that the user to have some knowledge as to what the frequency domain should contain, and also consider the sampling rate, frequency span, and instrument vertical bandwidth when making FFT measurements. The FFT resolution (the quotient of the sampling rate and the number of FFT points) is displayed directly above the softkeys when the FFT Menu is displayed.

NOTE**Nyquist Frequency and Aliasing in the Frequency Domain**

The Nyquist frequency is the highest frequency that an instrument can acquire without aliasing. This frequency is half of the sample rate. Frequencies above the Nyquist frequency will be under sampled, which causes aliasing. The Nyquist frequency is also called the folding frequency because aliased frequency components fold back from that frequency when viewing the frequency domain.

Aliasing happens when there are frequency components in the signal higher than half the sample rate. Because the FFT spectrum is limited by this frequency, any higher components are displayed at a lower (aliased) frequency.

Because the frequency span goes from approximately 0 to the Nyquist frequency, the best way to prevent aliasing is to make sure that the frequency span is greater than the frequencies of significant energy present in the input signal.

To accurately measure the frequency of higher frequency signals, turn off the checkbox in the **Antialiasing** softkey on the associated Channel Menu, which appears after you press [1] or [2].

FFT Spectral Leakage

The FFT operation assumes that the time record repeats. Unless there is an integral number of cycles of the sampled waveform in the record, a discontinuity is created at the end of the record. This is referred to as leakage. In order to minimize spectral leakage, windows that approach zero smoothly at the beginning and end of the signal are employed as filters to the FFT. The FFT Menu provides four windows: Hanning, Flat Top, Rectangular, and Blackman-Harris.

Reference Waveforms

Voltage, current, power, and math waveforms can be saved to four nonvolatile reference waveform locations, or to a USB drive. You can display one reference waveform at a time and compare it against other waveforms. To scale and position the displayed reference waveform, press **[Ref]** to light the LED to its left and use the knobs above and below the **[Ref]** key. You can also adjust waveform skew, and you can optionally display scale, offset, and skew information.

To save a reference waveform

1. Press **[Ref]** > **Display Ref**. Turn the **Entry** knob to select a reference waveform location. Then, either push the **[Entry]** knob or press **Display Ref** again.
2. Press **Source** and turn the **[Entry]** knob to select the source waveform.
3. Press **Save to R1/R2/R3/R4** to save the waveform.

To clear a reference waveform

1. Press **[Ref]** > **Display Ref**. Turn the **Entry** knob to select a reference waveform location.
2. Press **Clear R1/R2/R3/R4**.

Reference waveforms are also cleared by a Factory Default.

To display a reference waveform and associated information

1. Press **[Ref]** > **Display Ref**. Turn the **Entry** knob to select a reference waveform location.
2. Press **[Ref]** to enable/disable the reference waveform display.
3. Press **[Ref]** > **Display Info** to display a box summarizing the reference waveforms.

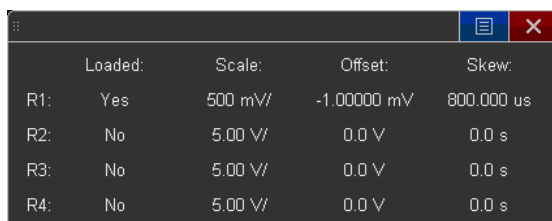

	Loaded:	Scale:	Offset:	Skew:
R1:	Yes	500 mV/	-1.00000 mV	800.000 us
R2:	No	5.00 V/	0.0 V	0.0 s
R3:	No	5.00 V/	0.0 V	0.0 s
R4:	No	5.00 V/	0.0 V	0.0 s

To scale and offset a reference waveform

1. Make sure the scale and position knobs above and below the **[Ref]** key are selected for the reference waveform. If the arrow to the left of the **[Ref]** key is not illuminated, press **[Ref]**.
2. Upper (scale) and lower (position) knobs adjust the reference waveform.

To adjust reference waveform skew

1. Press **Skew** and turn the **[Entry]** knob to adjust the reference waveform skew.

To save a reference waveform to USB

1. Press **[Save/Recall] > Save > Format**.
2. Turn the **Entry** knob to select Reference Waveform data (*.h5).
3. Press **Source** and turn the **[Entry]** knob to select the source waveform.
4. Press the second softkey and use the **Entry** knob to select a save location.
5. Press **Press to Save**.

To recall a reference waveform

1. Press **[Save/Recall] > Recall > Recall**.
2. Turn the **Entry** knob to select Reference Waveform data (*.h5).
3. Press **To Ref:** and turn the **[Entry]** knob to select the reference waveform location.
4. Press the second softkey and use the **[Entry]** knob to select the file to recall.
5. Press **Press to Recall**.

To clear the display of everything except the reference waveform, press **Clear Display**.

To navigate storage locations

When saving or recalling files, use the second softkey of the Save Menu or Recall Menu, along with the **[Entry]** knob, to navigate to storage locations. The storage locations may be internal storage locations (for setup files) or they can be external storage locations on a connected USB drive.

The second softkey can have these labels:

Press to go – when you can push the **[Entry]** knob to navigate to a new folder or storage location.

Location – when you have navigated to the current folder location (and are not saving files).

Save to – when you can save to the selected location.

Load from – when you can recall from the selected file.

When saving files, the proposed file name is shown in the Save to file = line above the softkeys. To overwrite a file, browse to that file and select it. To create a new file, follow the procedure below.

To enter file names

To create a new file name:

1. In the Save Menu, press the **File Name** softkey.
2. In the File Name Menu, press the **File Name** softkey.
3. Enter the file name using the touch screen keyboard (when active) or the **[Entry]** knob.
4. Press OK in the dialog, or press **File Name** again. The file name appears in the softkey.
5. Selecting the **Increment** softkey adds a numeric suffix to your file name and increments the number with each save. It truncates characters as necessary when the file name length is at maximum and more digits are required.

9 File Operations

[Save and Recall Files](#)

[Binary \(BIN\) File Format](#)

[File Explorer](#)

[Printing Screens](#)

[Updating Firmware](#)

Save and recall files

You can save Instrument setups and reference waveforms to internal instrument memory or to a USB storage device for later recall. You can also recall default or factory default setups. You can save screen images to USB storage in BMP or PNG formats. Acquired waveform data can be saved to a USB drive in comma-separated values or binary formats.

USB Storage Devices

Most USB mass storage devices that do not identify themselves as hardware type "CD" are compatible with the instrument. When the USB mass storage device is connected to the instrument's front or rear USB host port, a small circle icon may be displayed briefly as the USB device is read. Use your PC to create directories on a USB storage device. If two USB mass storage devices are connected, the first is designated "\usb" and the second is "\usb2."

You do not need to "eject" the USB drive; simply ensure that any file operation is done, and remove the USB drive. Many USB drives have lights that flicker or illuminate to indicate that an operation is taking place. If your drive has such a light, refer to it to ensure that a save operation has completed before removing the flash drive. Otherwise, wait a few seconds after the instrument displays a completion message to ensure that the flash drive has completed processing the received data.

Saving Setups, Screen Images, or Data

1. Press **[Save/Recall]** > **Save** > **Format**.
2. Then, turn the **[Entry]** knob to select the type of file you want to save:

Setup (*.ipa)	The horizontal timebase, vertical sensitivity, trigger settings, measurements, cursors, and math function settings that tell the instrument how to make a particular measurement.
8-bit or 24-bit Bitmap image (*.bmp)	The screen image in full-color (24-bit) or reduced-color (8-bit) bitmap format.
24-bit image (*.png)	The screen image in 24-bit color PNG format. Files are losslessly compressed to be much smaller than the BMP format.
CSV data (*.csv)	A file of comma-separated values of all displayed channels and math waveforms. This format is suitable for spreadsheet analysis.
Binary data (*.bin)	A binary file, with a header, and data in the form of time and voltage pairs.
Reference Waveform data (*.h5)	Waveform data in a format that can be recalled to one of the instrument's reference waveform locations.
Power Harmonics data (*.csv)	A file of comma-separated values with harmonics power analysis results.
Analysis Results (*.csv)	A file of comma-separated values with power analysis results for any analysis other than harmonics.

You can also configure the **[Quick Action]** key to save setups, screen images, or data. See [Configuring the \[Quick Action\] Key](#) for details.

To save setup files

You can save setup files to one of 10 internal locations or to an external USB drive.

1. Press **[Save/Recall]** > **Save** > **Format**. Then, turn the **[Entry]** knob to select Setup (*.ipa).
2. Press the second softkey and use the **Entry** knob to select a save location. See [To navigate storage locations](#).
3. Press **Press to Save**.

To save BMP or PNG image files

Image files can be saved to an external USB storage device.

1. Press **[Save/Recall]** > **Save** > **Format**. Then, turn the **[Entry]** knob to select 8-bit Bitmap image (*.bmp), 24-bit Bitmap image (*.bmp), or 24-bit image (*.png).
2. Press the second softkey and use the **Entry** knob to select a save location. See [To navigate storage locations](#).
3. Press the Settings softkey. You will see these softkeys and options:

Setup Info Setup information (vertical, horizontal, trigger, acquisition, math, and display settings) is also saved in a separate file with a TXT extension.

Invert Gr White or black screen background.

Palette Color or grayscale images.

4. Press **Press to Save**.

NOTE When saving screen images, the instrument uses the last menu visited before pressing **[Save/Recall]**. This lets you save any relevant information within the softkey menu area.

To save a screen image showing the Save/Recall Menu at the bottom, press **[Save/Recall]** twice before saving the image.

You can also save the display image using the Web interface. See [Web Interface](#) for details.

See Also

- [To add an annotation](#)

To save CSV or BIN data files

Data files can be saved to an external USB storage device.

1. Press **[Save/Recall]** > **Save** > **Format**. Then turn the **Entry** knob to select CSV data (*.csv) or Binary data (*.bin).
2. Press the second softkey and use the **Entry** knob to select a save location. See **To navigate storage locations**.
3. Press the **Settings** softkey and configure these options:
 - **Setup Info** – when enabled, setup information (vertical, horizontal, trigger, acquisition, math, and display settings) is also saved in a separate file with a TXT extension.
 - **Length** – sets the maximum number of data points to be saved (see **Length Control**), below.
4. Press **Press to Save**.

CSV Data

A CSV data file saves comma-separated values for each displayed waveform as multiple columns in one file. Math FFT waveforms, whose values are in the frequency domain, are appended at the bottom. Waveform labels are used as column headers. This format is suitable for spreadsheet analysis. For CSV data, length "N" value-at-time measurements are performed across the entire screen (using measurement data) for each active signal. Interpolation between data points is performed as needed.

Length Control

The Length control sets the number of displayed data points saved to a CSV or BIN file. Enabling Max Length saves the maximum number of waveform data points, depending on these things:

Whether acquisitions are running: When stopped, data comes from the raw acquisition record. When running, data comes from the smaller measurement record.

Whether the instrument was stopped using [Stop] or [Single]: Running acquisitions split memory to provide fast waveform updates. Single acquisitions use full memory.

Whether reference waveforms are on: Displayed reference waveforms consume acquisition memory.

The horizontal time/div setting: At faster settings, fewer data points appear on the display.

When saving to a CSV format file, the maximum number of data points is 64K.

When necessary, the Length control performs a "1 of n" decimation of the data . For example: if the Length is set to 1000, and you are displaying a record that is 5000 data points in length, four of each five data points will be decimated, creating an output file 1000 data points in length.

When saving waveform data, remember that saving a BIN file is faster than saving a CSV.

To navigate storage locations

When saving or recalling files, use the second softkey of the Save Menu or Recall Menu, along with the **[Entry]** knob, to navigate to storage locations. The storage locations may be internal storage locations (for setup files) or they can be external storage locations on a connected USB drive.

The second softkey can have these labels:

Press to go – when you can push the **[Entry]** knob to navigate to a new folder or storage location.

Location – when you have navigated to the current folder location (and are not saving files).

Save to – when you can save to the selected location.

Load from – when you can recall from the selected file.

When saving files, the proposed file name is shown in the Save to file = line above the softkeys. To overwrite a file, browse to that file and select it. To create a new file, follow the procedure below.

To enter file names

To create a new file name:

1. In the Save Menu, press the **File Name** softkey.
2. In the File Name Menu, press the **File Name** softkey.
3. Enter the file name using the touch screen keyboard (when active) or the **[Entry]** knob.
4. Press OK in the dialog, or press **File Name** again. The file name appears in the softkey.
5. Selecting the **Increment** softkey adds a numeric suffix to your file name and increments the number with each save. It truncates characters as necessary when the file name length is at maximum and more digits are required.

To recall a setup file

You can recall an instrument setup file from one of 10 internal locations or from a USB drive.

To recall a setup file with the [Save/Recall] key

1. Press **[Save/Recall] > Recall > Recall**. Then, turn the **[Entry]** knob to select Setup (*.ipa).
2. Press the second softkey and use the **[Entry]** knob to select the file to recall. See **To navigate storage locations**.
3. Press **Press to Recall**.

To recall a setup file with the File Explorer

1. Press **[Utility] > File Explorer**.
2. Press the softkey in the first position, navigate to the file to recall, and press **Load File**.

You can also configure the **[Quick Action]** key to recall setups or reference waveforms. See **Configuring the [Quick Action] Key** for details.

Recall Default Instrument Setups

Press **[Default Setup]** to restore the instrument's default settings. You can also press **[Save/Recall] > Default** to get to the Defaults Menu:



Undo Default Setup – undoes the recall of default settings.

Default Setup – recalls the instrument's default setup (equivalent to pressing **[Default Setup]**). Some user settings are not changed by recalling the default setup.

Default GUI Layout – recalls the default way that the graphical user interface (GUI) windows are positioned.

Factory Default – recalls the instrument's factory default settings. The instrument provides a Yes/No confirmation because all user settings are affected and this cannot be undone.

Secure Erase – Erases all user data per the National Industrial Security Program Operating Manual (NISPOM) standard and reboots the instrument. The instrument responds with a Yes/No confirmation to prevent unintentional erasing.

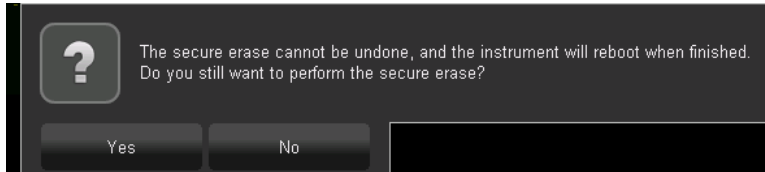

The Default Setup settings are:

Category	Parameter	Default Setup
Channels	Channel	Channel, Voltage, Current, Power all Enabled
	Vertical resolution	100 V, 1 A, 100 W, Fine Off
	Offsets	0 V, 0 A, 0 W
	Coupling	DC
	Ranging	Autorange On, Default Ranges 50 V, 5 A
CWA	Sync Source	Voltage 1
	Noise Reject	Medium
	Sync Offset	0
	Measurements:	Mode: AC + DC, Window: <= 200 ms
Horizontal and Search	Horizontal	Fine Off, Time Ref Center, Scale 10 ms/div, Delay 0 s
	Search	Enabled Off, Type Edge, Slope Rising, Source Voltage 1
	Search Thresholds	10% Lower, 50% Middle, 90% Upper
Trigger	Type	Rising Edge, Voltage 1 Source
	Mode	Auto
	Noise Reject	Disabled
Cursors	Enabled	Off
	Mode	Manual
	Source	Voltage 1
	Selected	X1
	Units	Seconds (X), Base (Y)
Measure	Type	Frequency, Peak to Peak, Enabled Off
	Thresholds	10% Lower, 50% Middle, 90% Upper
Other	Analyze	Enabled Off, Analysis Power Quality, Source Channel 1
	Acquire Mode	Normal
	Display	Grid Intensity 20%, Waveform Intensity 50%, Layout Format 1
	Math	Enabled Off, Display Math 1 (not selected), Operator +
	Reference Waveform	Enabled Off, Display Ref R1 (not selected), Display Info On

The Factory Default operation includes all of the changes caused by a Default Setup operation. It also changes the following items.

Parameter	Factory Default
Reference clock in	Ignore
Datalog channel enable	All channels enabled
Voltage and current skew	0 V and 0 A
Cursors	Mode Manual, Source Voltage 1, Cursors X1
Energy duration	10 s
Expand about	Ground
Screen saver selection	Logo
Screen saver timeout	120 mins
Screen saver text	KEYSIGHT TECHNOLOGIES
Quick Action setting	Off
Waveform drag mode	Off (area selection enabled)
Speaker volume	50%
Network print settings	Print to NETPRT0, not configured
Email settings	Format Setup, all e-mail fields blank, Attachment name: file
Touch screen state	On (enabled)
Current Ratio	1 V/A (external) and 1 A/A (internal)
Probe Offset	0
Statistics Display	Off

In addition, a Factory Default changes most things in the file save and load area, including folder paths, save format, auto increment, and so on.

Binary Data File Format (.BIN)

The binary data format stores waveform data, including headers that describe that data. The file size is small, relative to the CSV file format. All displayed sources and math waveforms are saved. In BIN file format, data are presented as follows (voltage, current, and power channels 3 and 4 do not exist on the PA2201A)

- Voltage 1
- Voltage 2
- Voltage 3
- Voltage 4
- Current 1
- Current 2
- Current 3
- Current 4
- Power 1
- Power 2
- Power 3
- Power 4
- Math 1
- Math 2
- Math 3
- Math 4

Keysight provides the .m files, which need to be copied into the work directory for MATLAB.

Binary Header Format

File Header

The header in a binary file comprises the following information.

Cookie	Two byte characters, KT, indicating the Keysight Binary Data file format.
Version	Two bytes that represent the file version.
File Size	A 32-bit integer indicating the number of bytes in the file.
Number of Waveforms	A 32-bit integer indicating the number of waveforms stored in the file.

Waveform Header

Each waveform in the file has a waveform header describing the waveform data.

Header Size	A 32-bit integer that is the number of bytes in the header.
Waveform Type	A 32-bit integer that is the type of waveform stored in the file: 0 = Unknown, 1 = Normal.
Number of Waveform Buffers	A 32-bit integer indicating the number of waveform buffers required to read the data.
Points	A 32-bit integer that is the number of waveform points in the data.
(Reserved)	A 32-bit integer equal to 0. Reserved for future use.
X Display Range	A 32-bit floating point number that is the X-axis duration of the waveform that is displayed. For time domain waveforms, it is the duration of time across the display. If the value is zero, no data has been acquired.
X Display Origin	A 64-bit, double-precision, floating-point number that is the X-axis value at the left edge of the display. For time domain waveforms, it is the time at the start of the display. If the value is zero, no data has been acquired.
X Increment	A 64-bit double that is the duration between data points on the X axis. For time domain waveforms, this is the time between points. If the value is zero, no data has been acquired.
X Origin	A 64-bit, double-precision, floating-point number that is the X-axis value of the first data point in the data record. For time domain waveforms, it is the time of the first point. If the value is zero, no data has been acquired.
X Units	A 32-bit integer that identifies the units for X values in the data: 0 = Unknown, 1 = Volts, 2 = Seconds, 3 = Constant, 4 = Amps, 5 = dB, 6 = Hz
Y Units	A 32-bit integer that identifies the unit of measure for Y values in the acquired data. The possible values are listed above under X Units.
(Reserved)	A 16-byte character array. Reserved for future use.
(Reserved)	A 16-byte character array. Reserved for future use.
Frame	A 24-byte character array that is the instrument's model number and serial number in the format: MODEL#:SERIAL#.
Waveform Label	A 16-byte character array that contains the label assigned to the waveform.
(Reserved)	A 64-bit double. Reserved for future use.
(Reserved)	A 32-bit unsigned integer. Reserved for future use.

Waveform Data Header

Each waveform data set will have a waveform data header that contains information about the waveform data set. This header is stored immediately before the data set.

Waveform Data Header Size	A 32-bit integer that is the size of the waveform data header
Buffer Type	A 16-bit short indicating the type of waveform data: 0 = Unknown data, 1 = Normal 32-bit float data.
Bytes Per Point	A 16-bit short that is the number of bytes per data point.
Buffer Size	A 32-bit integer that is the size of the buffer required to hold the data points.

Example of a Binary File

This table describes a binary file of an acquisition with two voltage, one current, and two power channels.

File Header	12 bytes	Number of Waveforms = N
Waveform Header 1	140 bytes	Number of Waveform Buffers = 1
Waveform Data Header 1	12 bytes	Buffer Type = 1 (float), Bytes per Point = 4
Voltage 1 Data	Buffer size	
Waveform Header 1	140 bytes	Number of Waveform Buffers = 1
Waveform Data Header 2	12 bytes	Buffer Type = 1 (float), Bytes per point = 4
Voltage 2 Data	Buffer size	
Waveform Header 3	140 bytes	Number of Waveform Buffers = 1
Waveform Data Header 3	12 bytes	Buffer Type = 1 (float), Bytes per Point = 4
Current 1 Data	Buffer size	
Waveform Header 4	140 bytes	Number of Waveform Buffers = 1
Waveform Data Header 4	12 bytes	Buffer Type = 1 (float), Bytes per Point = 4
Power 1 Data	Buffer size	
Waveform Header 5	140 bytes	Number of Waveform Buffers = 1
Waveform Data Header 5	12 bytes	Buffer Type = 1 (float), Bytes per Point = 4
Power 2 Data	Buffer size	

File Explorer

The File Explorer navigates the instrument's internal file system and connected USB storage devices. You can load setup files from 10 locations in the internal file system. From a USB storage device, you can load and delete setup files (*.ipa), firmware update (*.kup) files, label files, and so on.

NOTE You can connect USB flash memory devices to the front-panel USB ports. The square receptacle on the rear panel labeled "USB" is for controlling the instrument over USB.

To use the File Explorer, press **[Utility] > File Explorer**. Then press the first softkey and use the **Entry** knob to navigate. You can also use the touchscreen to navigate through the directory structure and select files.

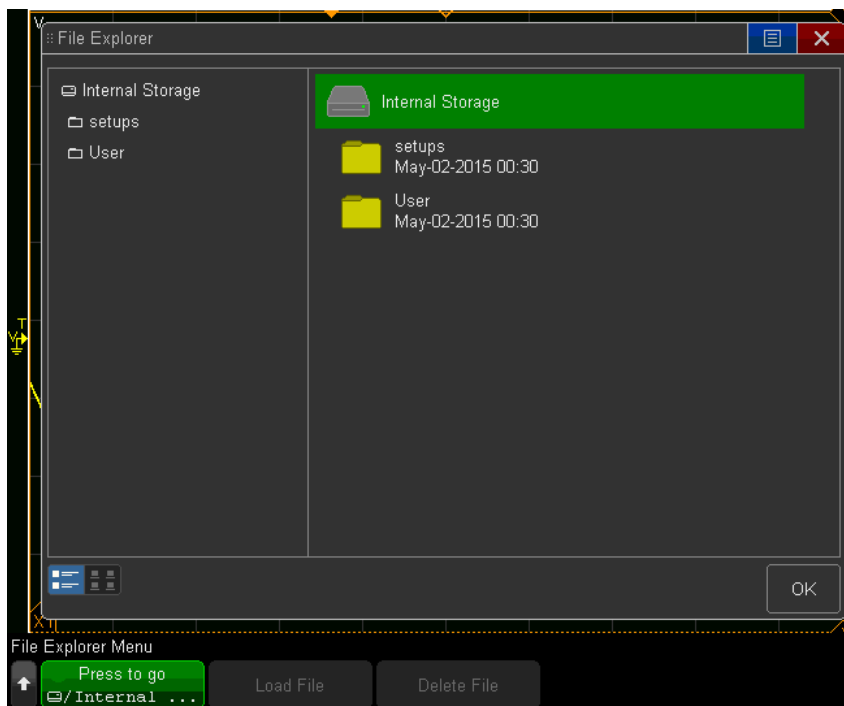

The first softkey can have these labels:

- **Press to go** – when you can push the **[Entry]** knob to navigate to a new folder or storage location.
- **Location** – when pointing to a directory that is currently selected.
- **Selected** – when pointing to a file that can be loaded or deleted. Press **Load File** or **Delete File** to take action. Pushing the **[Entry]** knob is the same as pressing **Load File**.

Once you have selected a file, you can press the **Load File** or **Delete File** softkeys to perform the corresponding actions. If you load a firmware update (*.kup) file, the instrument will reboot.

The instrument cannot recover a deleted file.

USB Storage Devices

Most USB mass storage devices that do not identify themselves as hardware type "CD" are compatible with the instrument. When the USB mass storage device is connected to the instrument's front or rear USB host port, a small circle icon may be displayed briefly as the USB device is read. Use your PC to create directories on a USB storage device. If two USB mass storage devices are connected, the first is designated "\usb" and the second is "\usb2."

You do not need to "eject" the USB drive; simply ensure that any file operation is done, and remove the USB drive. Many USB drives have lights that flicker or illuminate to indicate that an operation is taking place. If your drive has such a light, refer to it to ensure that a save operation has completed before removing the flash drive. Otherwise, wait a few seconds after the instrument displays a completion message to ensure that the flash drive has completed processing the received data.

Printing screens

NOTE The instrument prints the screen as shown before you pressed **[Print]**. Any measurements showing on the display before you press **[Print]** will be shown on the printout. To print the display showing the Print Configuration Menu at the bottom, press **[Print]** > **[Print]** > **Press to Print**.

To print the display, including the softkeys, to a printer on the LAN:

1. Press **[Print]** > **Network Setup** > **Address**, enter the printer's address, and press **Apply**.

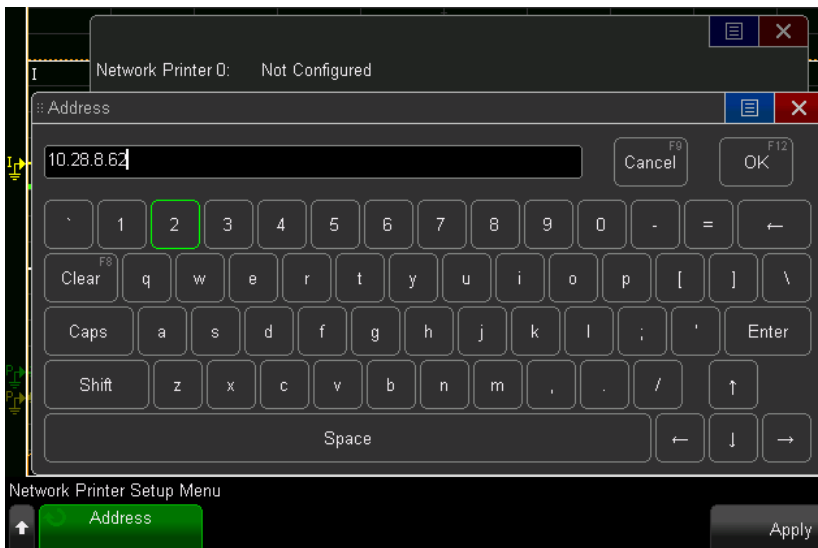

2. Press **[Print]** to display the Print Configuration Menu. Note that the print option softkeys and the **Press to Print** softkey are not available until a printer is connected.
3. Press **Print to**, then turn the **Entry** knob to select the desired printer.

4. Press **Options** to select the print options as described below.

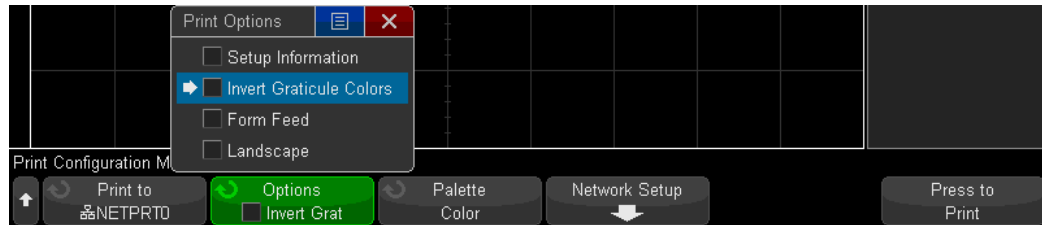

- **Setup Information** – prints instrument setup information, including vertical, horizontal, trigger, acquisition, math, and display settings.
 - **Invert Graticule Colors** – saves ink or toner by printing background in white; on by default.
 - **Form Feed** – prints the Setup Information (when selected) on a separate page after the waveform. Turn this off to print setup information on the same page as the waveform. If the setup information will not fit on the same page, it will on a new page regardless of the Form Feed setting.
 - **Landscape** – prints horizontally on the page.
5. Press **Palette** and select the Color or Grayscale print palette.
 6. Press **Press to Print**. You can stop printing by pressing **Cancel Print**.

Updating Firmware

From time to time, Keysight Technologies may release firmware updates for the instrument. To see the instrument's currently installed firmware version, press **[Help] > About IntegraVision**.

CAUTION Before updating instrument firmware, remove power from the power channel inputs. You may leave the connectors in place, but there should be no current or voltage signals going into the power analyzer.

To perform the firmware update:

1. Put the USB flash drive with the *.KUP file into one of the front-panel USB ports.
2. Press **[Utility] > File Explorer**.
3. Use the first softkey and the **Entry** knob to browse to the *.KUP file on the USB drive.
4. Press the **Load File** softkey.

The firmware update utility will run, and the instrument will cycle power to start running the new firmware.