

Rx 1000/500 Operation Manual

Software Release 9.05

Manual Revision 8



About this Manual

Notice

The information in this document has been produced by PHABRIX Ltd with care and is believed to be accurate. PHABRIX Ltd does not assume responsibility for loss or damage resulting from errors, omissions or inaccuracies herein. This document is subject to change and revisions may be made and issued to include such changes.

No part of this document may be reproduced, stored in a retrieval system or transmitted in any form or by any means, electronic, mechanical, recorded or otherwise without the prior written consent of PHABRIX Ltd.

Copyright © PHABRIX Ltd. All rights reserved. Software products licensed are owned by PHABRIX Ltd and are protected by international treaty provisions and national copyright laws.

HDMI® is the registered trademark of HDMI Licensing and is used within the document for identification purposes only.

Revision

This manual is a revision controlled document. Any changes to any page content will be reflected in the overall revision status of the whole manual.

Revision	Date	Software Version	Comment
1	21/10/2013	0.08.0018	First release of manual
2	29/04/2014	0.09.0024	Dolby Decoder & High res Waveforms
3	08/09/2014	9.01.12565	Dolby Generator Option
4	28/11/2014	9.02.13137	
5	06/02/2015	9.02.13417	Frame Grab
6	01/07/2015	9.03.13798	AV Delay
7	26/06/2017	9.05	2K over HD-SDI & Closed Caption Error Logging
8	06/07/2017	9.05	Loudness enhancements

PHABRIX® Limited

Acknowledgements

 **DOLBY** *The Dolby Decoder module available on the Rx range is Manufactured under license from Dolby Laboratories.*

Getting Started

Package Contents

The shipping box should contain the following

- PHABRIX Rx unit
- Power Supply Unit
- Mains lead
- CD Manual

The shipping box will also contain this Manual on a CD, note that the Web Site always contains the latest version of the manual. The version of software that this manual supports is on the front page.

General Safety

Avoiding Personal Injury



This instrument is designed for use by qualified personnel only.

No user serviceable parts are provided. Units should be returned to your local PHABRIX agent for servicing.

The Operator should NOT remove the case from the unit.

Do not spill any liquid onto the unit or its power adaptor.

Power Supply

Make sure that the unit is connected to the correct power supply voltage. A power supply adaptor is supplied with the unit which may be connected to any AC power supply between 100 and 240VAC at 50-60Hz. Only the supplied power adaptor should be used with the unit. Do not use a damaged AC cable with the unit as it may cause a shock or fire hazard. Replacement AC cables are available from your local PHABRIX agent.

Installation Environment

Operating Temperature



The unit should only be operated between 0 and 40 °Centigrade. If the unit is operated at a higher temperature there is a possibility of a fire hazard. If the temperature is changed rapidly from a cold environment to a hot environment, moisture can be created internally which can cause malfunction or damage the unit. Allow the unit to sit for 30 minutes without power applied to reduce any possibility of condensation. If the temperature rises above 60° Centigrade a warning dialog will be given. If the temperature rises above 65° Centigrade the unit will be turned OFF. Under both conditions, an event will be added to the event log to show what happened.

Input/Output Terminals

Do not connect the input or output BNC connectors to external power as this can damage the internal circuitry and cause the unit to work incorrectly.

The BNC connectors fitted on this unit are 75Ω type which are not compatible with 50Ω plugs.



The use of 50Ω plugs will permanently damage the connectors on the unit. The use of 50Ω plugs is considered to be misuse of the equipment and will therefore invalidate the unit's warranty.

When Not In Use

Disconnect the unit from the power supply and AC power source when not in use.

Maintenance

Wipe the case, and knobs gently with a soft cloth, lightly dampened with a neutral cleaning agent. A screen cleaning cloth may be used to clean the LCD. Do not apply force to the LCD when cleaning or it may be damaged.



Remove the power supply from the unit and turn OFF before cleaning. Do not allow any water or other liquid to enter the unit while cleaning.

RoHS Compliance

PHABRIX products are designed and manufactured using only RoHS compliant components and materials. Therefore based on information provided by our suppliers, PHABRIX certifies that ALL products that it manufactures are “RoHS-5” compliant and that they do not exceed the designated levels of lead, cadmium, mercury, hexavalent chromium, polybrominated biphenyl (PBB) and polybrominated diphenyl ether flame retardants (PBDE) legislated under the provisions of the “European Parliament and Council Directive” on the “Restriction of the Use of Certain Hazardous Substances in Electrical and Electronic Equipment (2011/65/EC)” and associated regulations collective known as the “RoHS Regulations”.

Disposal of Equipment



This product is subject to the European WEEE (Waste Electrical and Electronic Equipment) directive and should be disposed of according to the regulations of each country.

Contents

Acknowledgements	ii
Getting Started	iii
Package Contents.....	iii
General Safety.....	iii
<i>Avoiding Personal Injury</i>	iii
<i>Power Supply</i>	iii
Installation Environment	iv
<i>Operating Temperature</i>	iv
<i>Input/Output Terminals</i>	iv
<i>When Not In Use</i>	iv
<i>Maintenance</i>	iv
RoHS Compliance.....	iv
Disposal of Equipment	iv

Description

Rx Platform	1–3
Overview.....	1–3
Rx 1000 Rasteriser.....	1–4
<i>Description</i>	1–4
<i>Front Panel</i>	1–4
<i>Rear Panel</i>	1–4
<i>Specifications</i>	1–4
Rx 500 Rasteriser.....	1–5
<i>Description</i>	1–5
<i>Front Panel</i>	1–5
<i>Rear Panel</i>	1–5
<i>Specifications</i>	1–5
Rx Modules.....	1–6
Overview.....	1–6
CPU Module.....	1–6
<i>Single Analyzer, Dual Input</i>	1–7
<i>Single Analyzer, Dual Input, Physical Layer Measurement</i>	1–7
<i>Single Analyzer, Single Generator</i>	1–7
<i>AES Digital Audio Input / Output</i>	1–8
<i>Single Analyzer, Single Generator, Physical Layer Measurement</i>	1–8
<i>Dual Output Generator Module</i>	1–8
Rx Software Options	1–9
Overview.....	1–9
<i>3G-SDI and advanced formats upgrade for Rx chassis</i>	1–9
<i>HD/SD-SDI Data Analyzer and Ancillary Packet analyzer</i>	1–9
<i>Advanced physical layer analysis</i>	1–10
<i>Dolby Metadata Generator</i>	1–10
<i>Dolby analysis</i>	1–11
<i>Enhanced remote control</i>	1–11
<i>SDI-2K Formats</i>	1–12
<i>4 Channel Loudness</i>	1–12
<i>4 Channel Closed Caption</i>	1–12

Front Panel

Front Panel Control	2-3
Turning on and off the instrument	2-3
Navigation	2-3
Preset Menu	2-3
Inputs Menu.....	2-4
DHCP Mode Menu	2-4
Network Name.....	2-4
IP Address Menu.....	2-5
Gateway Menu	2-5
Sub Net Mask Menu	2-6
DNS Server Menu	2-6
GEN Type Menu	2-6
GEN Lines Menu	2-6
GEN Rate Menu	2-6
GEN Pattern Menu.....	2-7
HDMI Output Menu.....	2-7
HDMI Rate Menu.....	2-7
Brightness Menu.....	2-7
Screensaver Menu.....	2-7
Software Version Menu	2-7
Remote Control Menu.....	2-7

Monitor Output

Overview	3-3
HDMI Output.....	3-3
Display Area.....	3-3
Locking Reference VITC and LTC	3-4
Instrument Panel Re-sizing.....	3-4
Managing the Monitor Output.....	3-5
<i>Closing Open Panels (Windows)</i>	3-5
<i>Working with Multiple Analyzers</i>	3-5
<i>Working with Multiple Generators</i>	3-6
<i>Saving Monitor Display Layouts</i>	3-6
<i>Contextual Menus</i>	3-6
Generator Panels	3-7
Overview.....	3-7
Generator Video.....	3-8
<i>Output On</i>	3-8
<i>Standard</i>	3-8
<i>Colour Format</i>	3-8
<i>Pattern</i>	3-9
<i>EDH</i>	3-13
<i>Errors</i>	3-13
<i>SMPTE 352</i>	3-13
<i>Ident</i>	3-13
<i>Frame Grab Playout</i>	3-14
Generator Reference	3-15
<i>Source</i>	3-15
<i>Delay</i>	3-15

Generator Output Audio Menu.....	3-16
Group n.....	3-16
Source.....	3-16
Inv.....	3-16
Link.....	3-17
Master.....	3-17
4AES Module.....	3-17
Analyzer Panels	3-19
Overview.....	3-19
Picture.....	3-20
Timecode Display.....	3-20
Safe Area Generator.....	3-21
Sample, Line and Field Selection.....	3-21
Cursors and Zoom.....	3-21
Closed Caption / Subtitle Display.....	3-22
Gamut Error Indication.....	3-23
Native Resolution Picture Display.....	3-23
AFD/WSS and V-Chip Monitoring.....	3-23
Frame Grab.....	3-24
Data View / Signal Data.....	3-26
Type.....	3-26
Waveform Monitor.....	3-27
Waveform Type.....	3-27
Waveform Scale.....	3-27
Cursors.....	3-28
All, Line and Sample.....	3-29
Setup Button Dialogue.....	3-29
Vectorscope.....	3-30
Eye.....	3-31
Overview.....	3-31
Causes of Jitter.....	3-31
Eye Display.....	3-32
Jitter Filters.....	3-33
Jitter Meter Ranges.....	3-33
Advanced Jitter Analysis (Option).....	3-34
Jitter.....	3-35
Video Status.....	3-36
EDH/CRC ERRORS.....	3-36
EDH DATA.....	3-36
Cable Length.....	3-37
Active Picture CRC.....	3-37
Misc Status.....	3-38
Payload ID – SMPTE 352.....	3-38
Video Format.....	3-38
Video Timing.....	3-39
ANC Status (SDI Analysis Option).....	3-40
ANC Inspector (SDI Analysis Option).....	3-43
ANC Inspector Setup.....	3-44
Error Triggers.....	3-44
SFP Information.....	3-45

Audio Meters	3-46
<i>Audio Phase Meters</i>	3-46
<i>Meter Setup</i>	3-47
<i>Audio Mix Mode</i>	3-47
<i>4AES Module</i>	3-48
<i>Dolby Metadata Analysis</i>	3-48
<i>Dolby Decoder module</i>	3-48
SDI Audio Status	3-49
Lissajous	3-49
Loudness Meters	3-50
<i>Loudness Logging</i>	3-50
<i>Mode</i>	3-51
<i>Input and Source</i>	3-51
<i>Options</i>	3-51
<i>Confidence Check</i>	3-52
Dolby Meta-data (Dolby Analyzer Option)	3-53
<i>Overview</i>	3-53
<i>Dolby E</i>	3-53
<i>Dolby Digital</i>	3-53
<i>Dolby Digital Plus</i>	3-53
<i>Analyser Reference</i>	3-54
<i>Source selection</i>	3-54
<i>Dolby Framing Values</i>	3-54
<i>Dolby E Programme configuration</i>	3-55
<i>Dolby Digital Programme configuration</i>	3-55
<i>Dolby Digital Plus Programme configuration</i>	3-56
<i>Programme Metadata</i>	3-56
<i>Peak Metering</i>	3-57
System Panels	3-59
Overview	3-59
Network	3-60
<i>Network Setup</i>	3-60
<i>Remote Control of Rx Instrument</i>	3-61
Engineer	3-62
<i>Clear Memories</i>	3-62
<i>Default Settings</i>	3-62
<i>Rear Audio Calibration</i>	3-62
<i>Software Upgrade</i>	3-62
HDMI/CPU SDI Setup / HDMI/SDI Output	3-64
<i>HDMI Output</i>	3-64
<i>CPU SDI Output</i>	3-64
<i>Using SDI output as Test Pattern Generator</i>	3-65
<i>Using HDMI over SDI</i>	3-65
<i>External Locking Reference</i>	3-65
System Info	3-66
<i>Setting User Language</i>	3-66
<i>Changing Options Security Code</i>	3-66
<i>Software Upgrade</i>	3-66
Board Status	3-68
<i>Board (Module)</i>	3-68
<i>Hardware Status</i>	3-68
<i>System Temperature</i>	3-68
<i>Voltages</i>	3-68
<i>SFP</i>	3-68

Date/Time Setup	3-69
<i>Changing The Date/Time</i>	3-69
<i>Changing the Date Format</i>	3-69
<i>Daylight saving Time</i>	3-69
<i>Network Time Protocol</i>	3-69
Audio Monitoring Setup	3-70
<i>Speaker / Headphone</i>	3-70
<i>Rear Panel Audio</i>	3-70
Dolby Decoder Setup	3-71
Surround Channel Setup	3-72
Time Code Setup.....	3-72
Default Window Size.....	3-73
Dolby Generator Setup (Dolby Generator Option)	3-74
<i>Overview</i>	3-74
<i>Dolby E</i>	3-74
<i>Dolby Digital</i>	3-75
<i>Dolby Digital Plus</i>	3-75
<i>Dolby E Synchronisation - Generator Reference</i>	3-75
<i>Editing Program Information</i>	3-76
<i>Program Meta Data Editing</i>	3-76
<i>Default Program Meta Data</i>	3-78
<i>Embedding Dolby on SDI Stream</i>	3-78
<i>Embedding Dolby Signals on AES Stream</i>	3-78
Logging Panels	3-79
<i>Overview</i>	3-79
<i>Event Log</i>	3-79
<i>Log Setup</i>	3-80
<i>Audio Thresholds</i>	3-80
<i>Video Status</i>	3-80
<i>AES Status</i>	3-81
<i>Dolby E Status (Requires Dolby E Analysis Option)</i>	3-81
<i>Logging</i>	3-81
<i>Log Time Limit</i>	3-81
<i>Eye Log Setup / Log Eye Jitter</i>	3-82
<i>Jitter Thresholds</i>	3-82
<i>Eye Timings</i>	3-82
<i>Eye Amplitude</i>	3-82
<i>Log ANC Status</i>	3-83
Preset Memories	3-85
<i>Overview</i>	3-85
<i>Defining Preset Content</i>	3-85
<i>Generator Section</i>	3-85
<i>Analyser Section</i>	3-86
<i>Misc Section</i>	3-86
<i>GPIO Section</i>	3-86
<i>Saving Presets</i>	3-86
<i>Recalling Presets</i>	3-87
<i>Renaming Presets</i>	3-87
<i>Adding Additional Presets</i>	3-87
<i>Clearing Presets</i>	3-87
<i>Exporting Presets</i>	3-88
<i>Disk Space Considerations</i>	3-88

System Reference	3–89
Overview	3–89
Admin Menus	3–91
USB Disk Connected Window	3–91

Browser Control

Browser Control	4–3
Overview	4–3
HDMI Link	4–3
Event Log Link	4–3
Status Link	4–4
Screen Dumps Link	4–4

Glossary

Glossary of Terms	A–3
-------------------	-----

Specification

Rx Platform	B–3
Overview	B–3
Rx1000 Rasteriser	B–5
Description	B–5
Environmental Requirements	B–5
Dimensions	B–6
<i>Front Panel Dimensions</i>	B–6
<i>Top Panel Dimensions</i>	B–6
<i>Side Panel Dimensions</i>	B–6
Front Panel	B–7
<i>Front Panel Display</i>	B–7
Rear Panel	B–7
<i>Power Connection</i>	B–7
<i>External Locking Reference</i>	B–7
<i>AES Input</i>	B–8
<i>SDI Out</i>	B–8
<i>HDMI</i>	B–8
<i>Local Control</i>	B–8
<i>Networking</i>	B–8
<i>GPIO</i>	B–9
Rx500 Rasteriser	B–11
Description	B–11
Environmental Requirements	B–11

Dimensions	B-12
<i>Front Panel Dimensions</i>	B-12
<i>Top Panel Dimensions</i>	B-12
<i>Side Panel Dimensions</i>	B-12
Front Panel	B-13
<i>Front Panel Display</i>	B-13
Rear Panel	B-13
<i>Power Connection</i>	B-13
<i>External Locking Reference</i>	B-13
<i>AES Input</i>	B-14
<i>SDI Out</i>	B-14
<i>HDMI</i>	B-14
<i>Local Control</i>	B-14
<i>Networking</i>	B-14
<i>GPIO</i>	B-15
Rx Modules	B-17
Single Analyzer, Dual Input	B-17
<i>Analyzer SDI Inputs</i>	B-17
<i>Analyzer SDI Outputs</i>	B-17
<i>Analyzer Optical Inputs</i>	B-17
<i>Analyzer Functionality</i>	B-17
Single Analyzer, Dual Input, Physical Layer Measurement	B-18
<i>Analyzer SDI Inputs</i>	B-18
<i>Analyzer SDI Outputs</i>	B-18
<i>Analyzer Optical Inputs</i>	B-18
<i>Analyzer Functionality</i>	B-19
Single Analyzer, Single Generator	B-20
<i>Analyzer SDI Input</i>	B-20
<i>Analyzer SDI Output</i>	B-20
<i>Analyzer Optical Input</i>	B-20
<i>Generator Optical Output</i>	B-20
<i>Analyzer Functionality</i>	B-21
<i>Generator Functionality</i>	B-21
Single Analyzer, Single Generator, Physical Layer Measurement	B-22
<i>Analyzer SDI Input</i>	B-22
<i>Analyzer SDI Output</i>	B-22
<i>Analyzer Optical Input</i>	B-22
<i>Generator Optical Output</i>	B-22
<i>Generator Functionality</i>	B-23
<i>Analyzer Functionality</i>	B-23
Dual Output Generator Module	B-24
<i>Generator Optical Outputs</i>	B-24
<i>Generator Functionality</i>	B-24
AES Digital Audio Input / Output	B-25
Supported Video Formats	B-27
<i>SD 270 Mb/s</i>	B-27
<i>HD 1.485 Gb/s (SMPTE 292M)</i>	B-27
<i>Dual Link 1.485 Gb/s (SMPTE 327M)</i>	B-28
<i>3G Level-A 2.97 Gb/s (SMPTE 425M-A)</i>	B-30
<i>3G Level-B 2.97 Gb/s (SMPTE 425-B)</i>	B-31
<i>Built-in Generator Formats (CPU Module)</i>	B-32

Maintenance

Warranty	C-3
Overview	C-3
Warranty Exceptions	C-3
Product Registration	C-3
Maintenance	C-5
General Maintenance	C-5
Preventative Maintenance	C-5
Software Maintenance	C-7
Installing New Software	C-7
<i>Using a USB Pen Drive</i>	C-7
<i>Software Download from Internet</i>	C-9
Reverting to a Earlier Version of Software	C-9
FTP Connection	C-10
Rx File Structure	C-10
<i>Backups</i>	C-10
<i>Patterns</i>	C-10
<i>Scripts</i>	C-11
<i>Setup</i>	C-11
<i>Idents</i>	C-11
<i>Fonts</i>	C-11
<i>Loudness</i>	C-11
<i>FCAP</i>	C-11

Applications

Audio Configuration	D-3
Overview	D-3
Audio Channel Selection for Measurement and Analysis	D-3
<i>Embedded Audio Input</i>	D-3
<i>AES Audio Input</i>	D-4
<i>Decoded Dolby Audio (Dolby Decoder module)</i>	D-5
Audio Monitoring	D-6
<i>Speaker / Headphone Audio monitoring</i>	D-6
<i>Rear Panel monitoring</i>	D-7
<i>HDMI output monitoring</i>	D-7
<i>HDMI over SDI monitoring</i>	D-7
Audio Routing	D-8
<i>AES Audio Output</i>	D-8
<i>Generator SDI Audio Output</i>	D-8



PHABRIX[®]
broadcast excellence

1 Description

Description

Rx Platform

Overview

The 'Rx platform' has been designed to serve the varied test and measurement needs of the broadcast industry. PHABRIX has developed not a single product in the traditional sense but a modular system from which specific broadcast client requirements can be satisfied.



The Rx platform allows a flexible approach to test and measurement on a new technological platform designed for longevity. The system has been created to allow broadcast engineers to specify features according to the complexity of the required test and measurement application by simply adding additional modules and software licenses to their chosen core chassis.

Adding modules is like adding independent new instruments, each module providing a dedicated set of instruments for the task required.

The Rx Platform is available in a choice of chassis types:

Rx2000 – a unique audio video monitoring solution combining front panel instrumentation, via dual TFT screens, and integrated full range stereo speakers. Unique 2U tapered 'tilt-in-bay' engineering with four Rx module bays.

Rx1000 rasterizer – a compact 1U 19" rack-mount chassis with OLED display interface with four Rx module bays.

Rx500 rasterizer – a compact 1U ½ rack width chassis with OLED display interface with two Rx module bays.

Rx 1000 Rasteriser

Description

The Rx 1000 is a 1U rack mounted instrument that provides the following:

OLED display to allow the monitoring inputs and the selection of Monitor display, Analyzer and Generator presets.

Rasterised HDMI/SDI outputs to allow up to 16 individual instrument panels (windows) to be displayed on a single DVI 1920 x 1080 resolution monitor. Ideal for outside broadcast facilities and engineering bays where space is at a premium.

Control via front panel controls, for in-bay use and remotely via a network connection using a web browser.

Front panel audio monitoring, provided by high quality speakers and/or a head phone socket, to allow the monitoring of the selected Audio channel.

4 Module slots allowing the installation of Analyzer and Generator modules.

Front Panel



The front panel provides access to the OLED Display and menu system to allow the instrument to be configured and preset Monitor display, Analyzer and Generator settings to be recalled.

Rear Panel



The rear panel provides the Rx instrument's connections via the CPU module and the installed Analyzer or Generator modules. See the "Modules" section for details of the different module types.

The power for the Rx instrument is provided by a separate PSU unit that connects to the 4-pin male XLR connector at the left of the instrument.

Specifications

See Appendix B for specifications

Rx 500 Rasteriser

Description

The Rx 500 is a 1U, half rack width instrument (available with optional rack mount kit) that provides the following:

- OLED display to allow the monitoring inputs and the selection of Monitor display, Analyzer and Generator presets.

- Rasterised HDMI/SDI outputs to allow up to 16 individual instrument panels (windows) to be displayed on a single DVI 1920 x 1080 resolution monitor. Ideal for outside broadcast facilities and engineering bays where space is at a premium.

- Control via front panel controls, for in-bay use and remotely via a network connection using a web browser.

- Front panel head phone socket to allow the monitoring of the selected Audio channel.

- 2 Module slots allowing the installation of Analyzer and Generator modules.

Front Panel

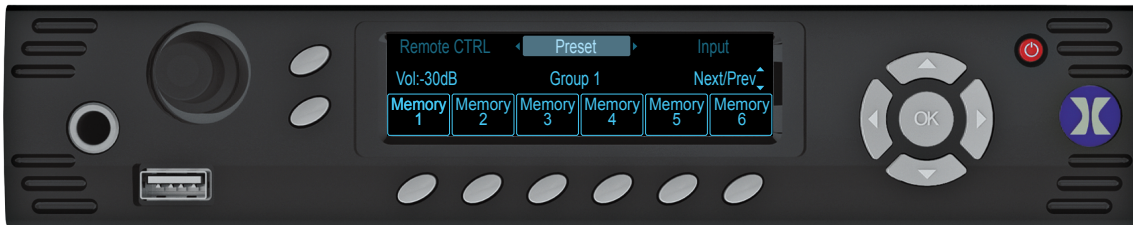

The front panel provides access to the OLED Display and menu system to allow the instrument to be configured and preset Monitor display, Analyzer and Generator settings to be recalled.

Rear Panel

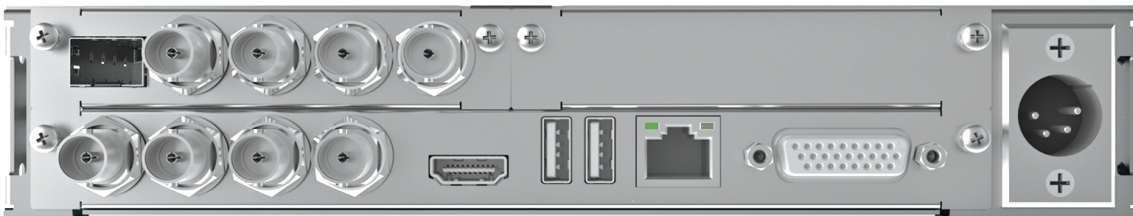

The rear panel provides the Rx instrument's connections via the CPU module and the installed Analyzer or Generator modules. See the "Modules" section for details of the different module types.

The power for the Rx instrument is provided by a separate PSU unit that connects to the 4-pin male XLR connector at the left of the instrument.

Specifications

See Appendix B for specifications

Rx Modules

Overview

The Rx range can be configured with a range of plug-in modules (printed circuit boards with dedicated hardware for specific functions) that enable functionality in the software and allow different menus to be selected on the front panel (Rx2000) and allow different Instrument panels (windows) to be created on the Monitor output.

Note that the Monitor Output - “System Status” menu can be used to inspect which Modules have been installed in the Rx instrument. See the “Monitor Output” section for details.

CPU Module

At the heart of every Rx product is the CPU module. Here signals from each installed instrument module are processed to provide a variety of instrument displays. Unhindered by stacked processing restraints, the CPU board creates an output display at an industry leading 1920 x 1080 pixels with perfect scaling via simultaneous HDMI and/or SDI outputs. In practice the Rx acts like a Test & Measurement multi-viewer providing scaled instruments from any selected video/audio input.

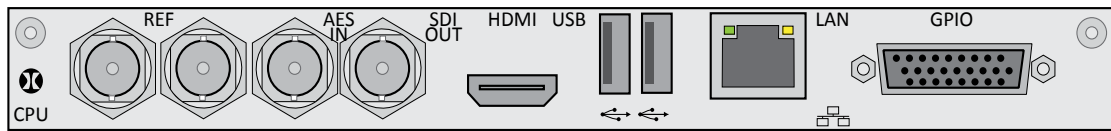

The CPU board also provides AES input, Bi/Tri level looping reference, 8 channel GPI, LTC input and stereo analogue audio output. Dual USB ports are provided for mouse and keyboard control. Ethernet provides remote access via web browser and is also the method for updating firmware and software from PHABRIX’s dedicated server.

REF	Bi/Tri level looping reference that allows the Rx instrument to be locked to a studio reference.
AES IN	Is an AES audio input
SDI OUT	Is an SD-SDI or HD-SDI signal generator output that provides test signals generated by the on-board Generator module on the CPU board. This output can also be used to provide an SDI monitor output tied to the HDMI® monitor output.
HDMI	Is a DVI 1920 x 1080 resolution monitor output that allows up to 16 individual instrument panels (or windows) to be displayed. Note that on some HDMI® monitors this output may appear too sharp causing ringing on the edges of text and menus. This can be resolved by reducing the monitor’s image sharpness setting.
USB	Are standard USB 2 connections provided for connection of a keyboard and mouse to control the HDMI® monitor output.
LAN	10/100-base-T connection allowing the Rx instrument to be connected into a network and accessed via TCP/IP so that it can be controlled remotely.
GPIO	Provides a GPI (general purpose input), LTC control and analogue audio connections.

Single Analyzer, Dual Input

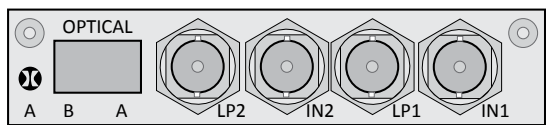

The PHRXM-A module allows 2 connected SDI or Optical video signals to be present continuously and switched for analysis or display by the single analyzer channel as required.

- IN1 - LP1 SD-SDI or HD-SDI signal, high impedance loop through that allows the Rx instrument to analyse the connected input.
- IN2 - LP2 Is a second SD-SDI or HD-SDI signal, high impedance loop through that allows the Rx instrument to analyse the connected input.
- OPTICAL Allows a Video Transceiver (SFP Optical) module to be installed.

Note that for Dual Link analysis the Link 1 signal must be connected to “IN1” BNC connector and the Link 2 signal must be connected to “IN2” BNC connector on the same Analyzer module. Likewise if Fibre is being used Link 1 should connect to “OPTICAL A” and Link 2 should connect to “OPTICAL B”.

Single Analyzer, Dual Input, Physical Layer Measurement

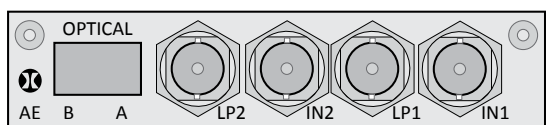

The PHRXM-AE module allows 2 connected SDI or Optical video signals to be present continuously and selected for analysis or display as required.

- IN1 - LP1 Is an SD-SDI or HD-SDI signal, high impedance loop through that allows the Rx instrument to analyse the connected input.
- IN2 - LP2 Is a second SD-SDI or HD-SDI signal, high impedance loop through that allows the Rx instrument to analyse the connected input.
- OPTICAL Allows a Video Transceiver (SFP Optical) module to be installed.

Note that for Dual Link analysis the Link 1 signal must be connected to “IN1” BNC connector and the Link 2 signal must be connected to “IN2” BNC connector on the same Analyzer module. Likewise if Fibre is being used Link 1 should connect to “OPTICAL A” and Link 2 should connect to “OPTICAL B”.

Single Analyzer, Single Generator

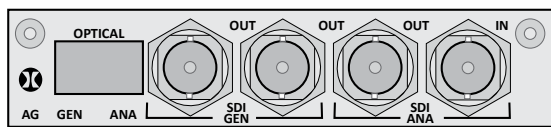

The PHRXM-AG module allows a single connected SDI or Optical video signal to be monitored continuously and allows the generation of a single SDI or Optical video test signal.

- SDI ANA IN Is an SD-SDI or HD-SDI signal, high impedance loop through to “SDI ANA OUT” that allows the Rx instrument to analyse the input.
- SDI GEN OUT Are 2 identical SD-SDI or HD-SDI generator output that provide a test signal generated by the PHRXM-AG module.
- OPTICAL Allows a Video Transceiver (SFP Optical) module to be installed.
- GEN - provides a test signal generated by the PHRXM-AG module.
- ANA - allows the Rx instrument to analyse the connected input.

AES Digital Audio Input / Output

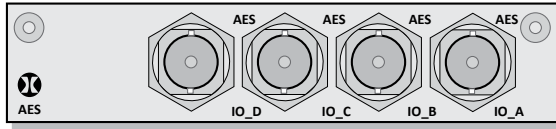

The PHRXM-4AES module allows 4 x AES digital audio pairs to be routed to the Audio Meter and Loudness instruments. It also allows AES audio to be used by Generator modules and allows Embedded SDI audio channels to be output as AES audio

- AES IO_A Is an AES digital audio pair input/output.
- AES IO_B Is an AES digital audio pair input/output.
- AES IO_C Is an AES digital audio pair input/output.
- AES IO_D Is an AES digital audio pair input/output.

Single Analyzer, Single Generator, Physical Layer Measurement

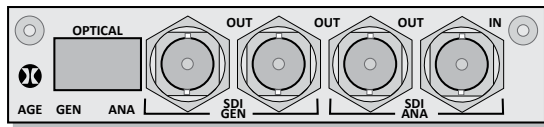

The PHRXM-AGE module allows a single connected SDI or Optical video signal to be monitored continuously and allows the generation of a single SDI or Optical video test signal.

- SDI ANA IN Is an SD-SDI or HD-SDI signal, high impedance loop through to “SDI ANA OUT” that allows the Rx instrument to analyse the input.
- SDI GEN OUT Are 2 identical SD-SDI or HD-SDI generator output that provide a test signal generated by the PHRXM-AG module.
- OPTICAL Allows a Video Transceiver (SFP Optical) module to be installed.
- GEN - provides a test signal generated by the PHRXM-AG module.
- ANA - allows the Rx instrument to analyse the connected input.

Dual Output Generator Module

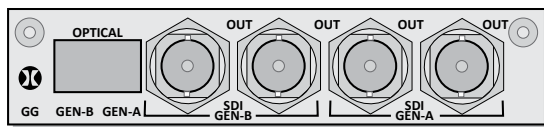

The PHRXM-GDL module allows the generation of a two independent SDI or Optical video test signals with the same video format, colour space and frame rate for Dual link use.

- SDI GEN-A OUT Are 2 identical SD-SDI or HD-SDI generator output that provide a test signal generated by the PHRXM-GDL module.
- SDI GEN-B OUT Are 2 identical SD-SDI or HD-SDI generator output that provide a test signal generated by the PHRXM-GDL module.
- OPTICAL Allows a Video Transceiver (SFP Optical) module to be installed.
- GEN-A - provides a test signal generated by the PHRXM-GDL module.
- GEN-B - provides a test signal generated by the PHRXM-GDL module.

Note that for Dual Link test pattern generation both Output 1 and Output 2 must be enabled on the Generator. The Link 1 signal is produced on the module’s “GEN A” output and the Link 2 signal is produced on the module’s “GEN B” output. Likewise if a Fibre connection is being used the Link 1 signal is produced on “OPTICAL GEN A” and the Link 2 signal is produced on “OPTICAL GEN B”.

Rx Software Options

Overview

The Rx range has a range of software options that can enhance the Rx functionality for specific applications.

3G-SDI and advanced formats upgrade for Rx chassis

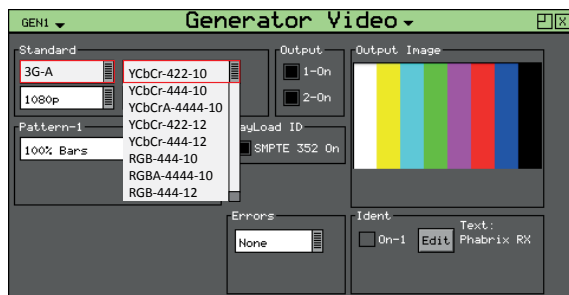

This option (PHRXO-3G) provides advanced formats include 4:2:2 YUV, 4:4:4 RGB and 4:4:4 YUV at 10/12 bit and 3G level A and B. For broadcast manufacturers this option allows rigorous testing of many more formats beyond the standard signals used in traditional broadcasting.

Among the support for 3G level B is the ability to analyse signals such as SMPTE 425-B carrying 1 x SMPTE 372M Dual-Link payload. Generation of these signals is activated if the generator is present.

HD/SD-SDI Data Analyzer and Ancillary Packet analyzer

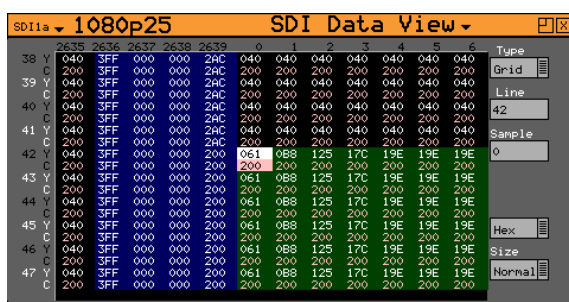

The SDI analysis option (PHRXO-SD) provides the engineer with a detailed view of the data words contained within the SDI stream. This allows the analysis of complex faults and is particularly useful when determining compatibility issues between equipment and when debugging new product developments particularly in a R&D environment.

Detail within the active SDI stream can be viewed with continuous update.

The SDI Analysis option provides the following functional areas:

- Grid displays the SDI data in the form of an array.
- Stream allows the SDI continuous data stream to be viewed.
- Component allows the video components to be displayed in separate columns.
- Splt allows the video components to be display individually.
- Ancillary Data allows the user to capture whole Ancillary data packets identified by their data id (DID).
- Ancillary Status allows additional 'user defined' selections with the appropriate DID or SDID code.

Access to the SDI analysis functionality is via the Analyzer - Signal Data menu. See the "Analyzer - Signal Data" section in chapter 2 for full details.

Advanced physical layer analysis

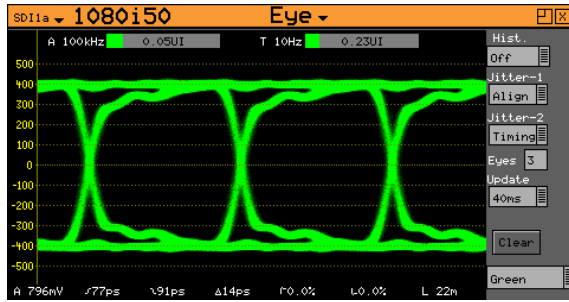

The analysis option (PHRXO-EA) for the Rx range adds an additional jitter screen, plus enhancements to the eye display. The extra features added to the eye and jitter module are focussed toward broadcast manufacturers who have a need for high end analysis tools. Histograms, decade filters, multiple eye display, full screen jitter display and alignment and timing thermometers are all available with comprehensive logging.

The Advanced physical layer analysis option provides the following functional areas:

Multi eye display enables analysis when serialiser jitter is present: Products process video in either a 10 or 20 bit parallel data domain which is subsequently transmitted as a single bit serial data stream. By triggering every 10 or 20 eyes you can reveal repetitive parallel/serial clock domain jitter in equipment being analysed.

Histograms give statistical information which can be used to accurately measure rise time, fall time and amplitude. These automatic accurate measurements can then be logged for extended periods of time. Measurements like rise time and fall time are notoriously difficult to make with SDI signals.

In addition to the standard timing and alignment jitter filters, decade filters are provided allowing an engineer to analyse the frequency content of any jitter present. The number of eyes displayed is adjustable from one eye up to one frame of eyes.

Decade filters are provided allowing an engineer to analyse the frequency content of any jitter present. The number of eyes displayed is adjustable from one eye up to one frame of eyes.

Jitter display the separate full screen jitter analysis display incorporated into the advanced option enables the engineer to analyse the nature of jitter present using a graph of jitter versus time. Again, the decade filters are present and the time base can be adjusted from 1 line through to 1 frame. By analysing jitter in this detailed way an engineer can determine if a signal is in or out of specification and also get a feel for where any problems lie.

Dolby Metadata Generator

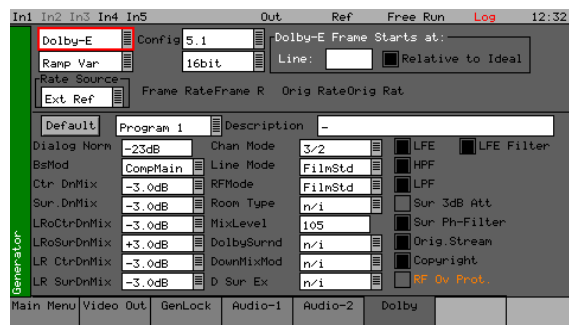

The Dolby Metadata Generator software option allows generation of Dolby-E, Dolby Digital and Dolby Digital Plus pre-encoded test signals to check that they are transferred transparently through the broadcast chain unaffected by routers / switchers, satellite links, etc.

Dolby analysis

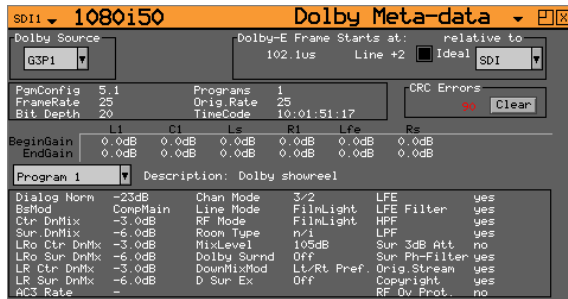

The Dolby-analysis option (PHBRO-BDA) displays Dolby E, Dolby Digital and Dolby Digital Plus metadata present in a selected audio stream and determines whether a Dolby-E packet is timed correctly on the SDI video stream. The Dolby audio may be monitored from any of the SDI input embedded audio channel pairs or AES input.

Peak metadata audio levels metering is also displayed for Dolby E.

Enhanced remote control

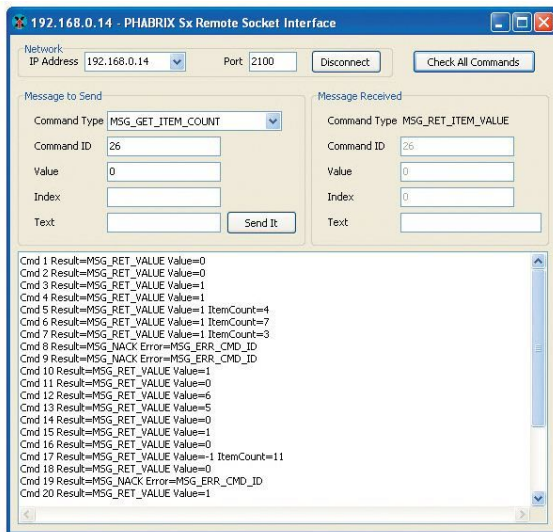

The Enhanced remote control option gives users full remote control of the unit via TCP/IP Sockets to allow any aspect of the unit to be modified or queried.

This allows complex applications to be created to perform test and measurement functions such as automated testing of routers or other broadcast equipment.

The Rx instrument can act as a server and listen on a port waiting for incoming requests from clients such as a PC. Using this method of communication the Rx range can provide a variety of information to the control device it is connected to and be controlled in specified areas of the product using the command details included. All visual controls on the product have an associated command.

Messages may be sent to 'set' or 'get' data from a command ie if you 'set' a value the unit will be configured accordingly and a reply returned and if you 'get' a value from the PHABRIX unit it will reply with that value. All messages are acknowledged to increase the security of the interface ie closed loop communication.

The control structure can be selected as Passive or Active. Passive control allows simple remote control where the host PC is in control and sends commands when it wants to change data or get information. It is this method which is the most popular use for remote control.

Active control is when the Rx unit synchronizes with the host PC. Any changes on the Rx unit will result in a message being sent to the host PC. This method is useful for controlling a Rx unit from another unit or via the PC simulator software. It requires more complex software on the host to respond to the returned messages.

The option provides a programming guide with command information and examples on a CD. A Windows™ application for testing the interface is also provided as part of this option.

See the Remote Control Guide for details

SDI-2K Formats

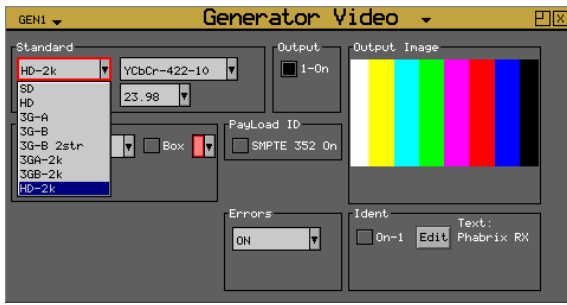

This option (PHRXO-2K) supports the new SDI practice for HD and 3G Level A and Level B signal transfer of 2K advanced formats including 4:2:2 Y'CbCr, 4:4:4 R'G'B' and 4:4:4 Y'CbCr at 10/12 bit.

4 Channel Loudness

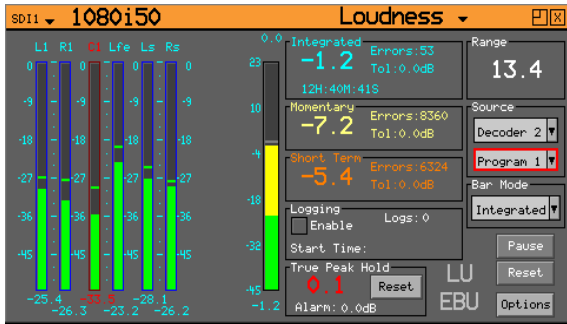

This option (PHRXO-4LOU) allows up to 4 channels of loudness metering and monitoring to be performed by the Rx unit (1 loudness channel per analyser module).

The tools provided in the “Loudness” window allow the loudness of the selected stereo audio pair or 5.1 surround audio group to be monitored and measured. The Rx system provides a single Loudness meter as standard and an additional 3 Loudness meters are available as an option. The Loudness meters are access via the Analyser module menu on the HDMI® monitor output.

The Loudness Setup allows the meter scale (LU, LUFS or LKFS), measurement standard (EBU or ITU) and Meter Range as well as user-defined threshold values for Integrated, Momentary and Short Term loudness.

4 Channel Closed Caption



This option (PHRXO-4CAP) allows up to 4 channels of closed caption to be displayed. This is allocated as 1 channel per analyser module.

This supports WTS/OP42/OP47, EIA 608 and EIA 708 closed caption / subtitle formats.



PHABRIX[®]
broadcast excellence

2 Front Panel

Front Panel

Front Panel Control

Turning on and off the instrument

To turn on your PHABRIX Rx1000 or Rx500 instrument, press the button at the top right hand corner of the front panel.



Once the system has started, pressing the button again will turn it off. If for some reason the instrument stops responding, pressing and holding the button for a few seconds will turn it off.

Navigation

The left and right cursor buttons can be used to move through the main menus. The currently selected menu being the one in the centre of the display between the left and right arrow symbols.

The down cursor button can be used to edit numeric fields and the up cursor button can be used to save the changes made.

The six buttons below the OLED display control the selection of the options within the currently selected menu.

The “Input” button to the left of the screen selects the Inputs menu and the “Preset” button selects the Presets menu.

Preset Menu

The Preset menu can be selected either using the “Preset” button or by using the left and right cursor buttons to scroll through the menus.

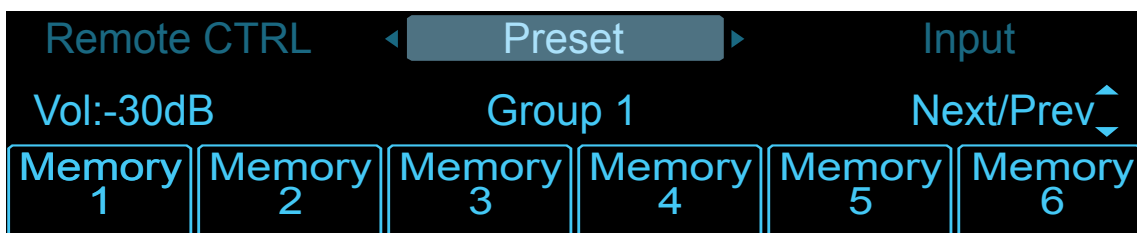

The Presets menu allows pre-defined system presets to be loaded. The buttons below the LED screen can be used to select the presets (for example “Memory 1”, “Memory 2”, etc) currently stored on the Rx instrument.

See the “Monitor Output” section for details about to create presets.

Inputs Menu

The Input menu can be selected either using the “Preset” button or by using the left and right cursor buttons to scroll through the menus.



The Inputs menu allows the video signals connected to the Rx instrument to be selected for analysis. The buttons below the LED screen can be used to select the inputs such as “SDI1 a”, “SDI1 b”, “SDI2a”, “SDI2b”, etc. The options that are displayed here depend on the number and type of Rx modules that are installed.

DHCP Mode Menu

The DHCP Mode menu is used to turn on and off the unit’s network Dynamic Host Configuration Protocol mode.

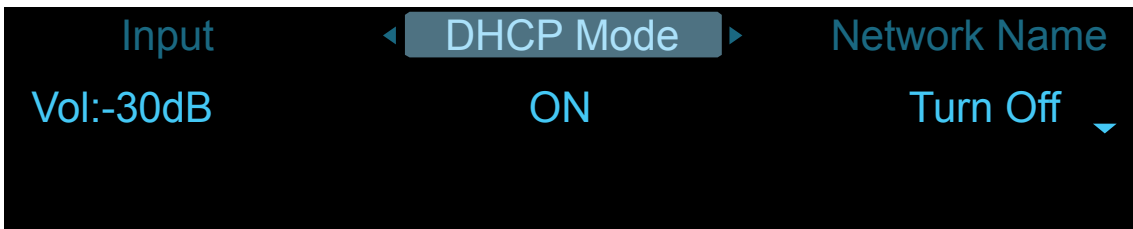

When DHCP is turned on, then the Rx instrument will automatically attempt to obtain an IP address for the instrument from your organisation’s DHCP server. In this mode it will not be possible to manually change the IP Address, Subnet mask, etc.

To turn off the DHCP mode use the down cursor button. With DHCP turned off the unit’s IP address, subnet mask and gateway details will have to be entered manually.

Network Name

Network Name is a read-only menu that displays the host name given to the Rx instrument, ie “PhabrixRx”. This Network name can be setup on the Network Setup menu of the HDMI® monitor output.

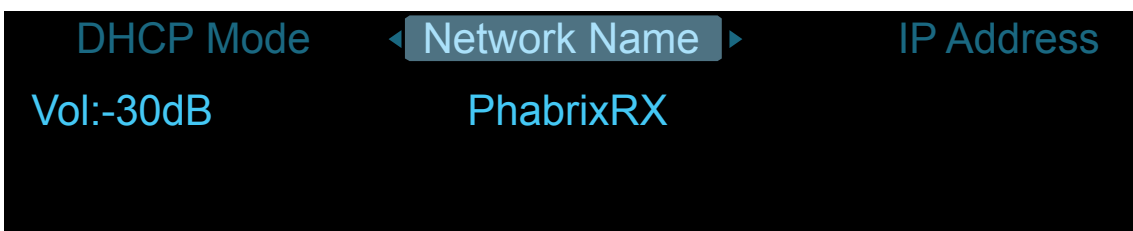

IP Address Menu

The IP Address menu allows the IP address for the Rx instrument to be viewed and setup. Note that if DHCP mode is turned on, then the address will be populated automatically and this will be read-only.

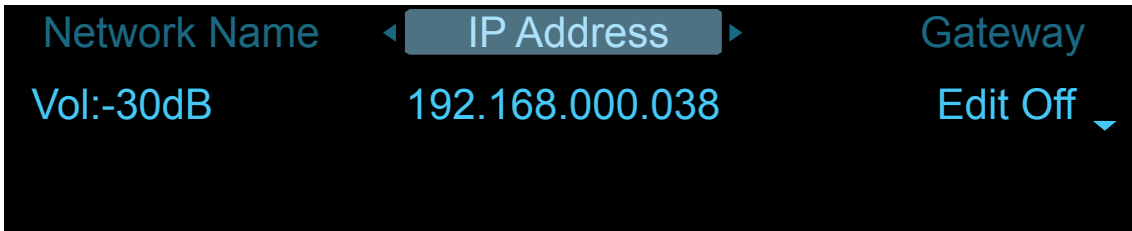

To enter or change the address press the down cursor button to enter edit mode :



The first number bank will be selected automatically. Use the buttons below the screen to change the number or select any of the buttons below the LED screen (-1, +1, -10, +10, -100, +100) to increment the value accordingly.

Select the right-hand cursor button to move to the next number bank

Repeat this process until the required address has been entered then select the up cursor button to exit edit mode.

Gateway Menu

The Gateway menu allows the network gateway address to be setup. To enter or change the address:

Press the down cursor button to enter edit mode and to select the first number bank.

Use the buttons below the screen to change the number or select any of the buttons below the LED screen (-1, +1, -10, +10, -100, +100) to increment the value accordingly.

Select the right-hand cursor button to move to the next number bank

Repeat this process until the required address has been entered then select the up cursor button to exit edit mode.

Note that if DHCP mode is turned on, then the address will be populated automatically and this will be read-only.

Sub Net Mask Menu

The Sub Net Mask menu allows the network Subnet mask address to be setup. To enter or change the address:

Press the down cursor button to enter edit mode and to select the first number bank.

Use the buttons below the screen to change the number or select any of the buttons below the LED screen (-1, +1, -10, +10, -100, +100) to increment the value accordingly.

Select the right-hand cursor button to move to the next number bank

Repeat this process until the required address has been entered then select the up cursor button to exit edit mode.

Note that if DHCP mode is turned on, then the address will be populated automatically and this will be read-only.

DNS Server Menu

The DNS Server menu allows the address of your organisation's DNS (Domain Name Service) server to be entered. To enter or change the address:

Press the down cursor button to enter edit mode and to select the first number bank.

Use the buttons below the screen to change the number or select any of the buttons below the LED screen (-1, +1, -10, +10, -100, +100) to increment or decrement the value accordingly.

Select the right-hand cursor button to move to the next number bank

Repeat this process until the required address has been entered then select the up cursor button to exit edit mode.

Note that if DHCP mode is turned on, then the address will be populated automatically and this will be read-only.

GEN Type Menu

The GEN Type menu allows the SD-SDI format for the CPU generator output to be selected. The buttons below the LED screen allow the SDI output to be turned on.

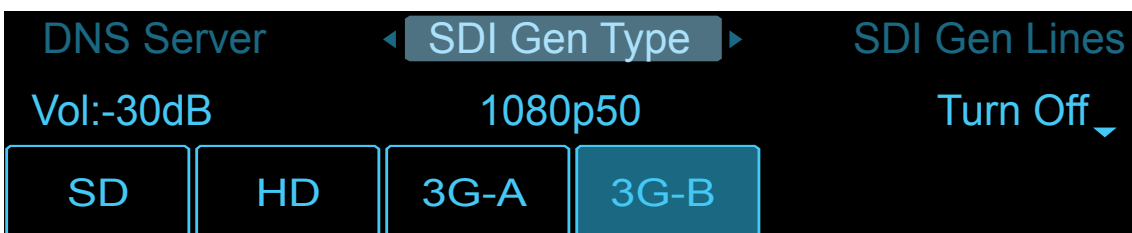

GEN Lines Menu

The GEN Lines menu allows the line standard of the test pattern to be selected. To select a line standard, press the button beneath the screen for the standard you require.

GEN Rate Menu

The GEN Rate menu allows the frame rate of the test pattern to be selected. To select a frame rate, press the button beneath the screen for the frame rate you require.

GEN Pattern Menu

The GEN Pattern menu allows the test pattern on the CPU generator output to be selected. To select a pattern, press the button beneath the screen for the pattern you require.



HDMI Output Menu

The HDMI Output menu allows the HDMI® monitor to be turned on and off. Use the up and down cursor buttons to turn on and off the HDMI® monitor output.

HDMI Rate Menu

The HDMI Rate menu allows the frame rate of the HDMI® monitor to be selected. To select a frame rate, press the button beneath the screen for the frame rate you require.

Brightness Menu

The Brightness menu allows the OLED screen brightness to be setup. The buttons below the screen can be used to increment or decrement the value.

Screensaver Menu

The Screensaver menu allows the OLED screen saver to be turned on or off and allows the wait time to be setup. The buttons below the screen can be used to select the value.

Software Version Menu

The Sw Version displays the current version of software that is installed on the Rx1000 or Rx500 instrument.

Remote Control Menu

The Remote Control menu allows the Rx remote control to be turned on or off. Use the up and down cursor buttons to turn on and off the remote control mode.

Front Panel

Monitor Output

Overview

HDMI Output

The Rx range of products provide a Monitor output in the form of an HDMI output that can display up to 16 instrument windows at 1920 x 1080 resolution. This Monitor output display can display the pre-sets selected by the “Pre-set Buttons” and can be controlled by a USB mouse and keyboard connected to the Rx instrument.

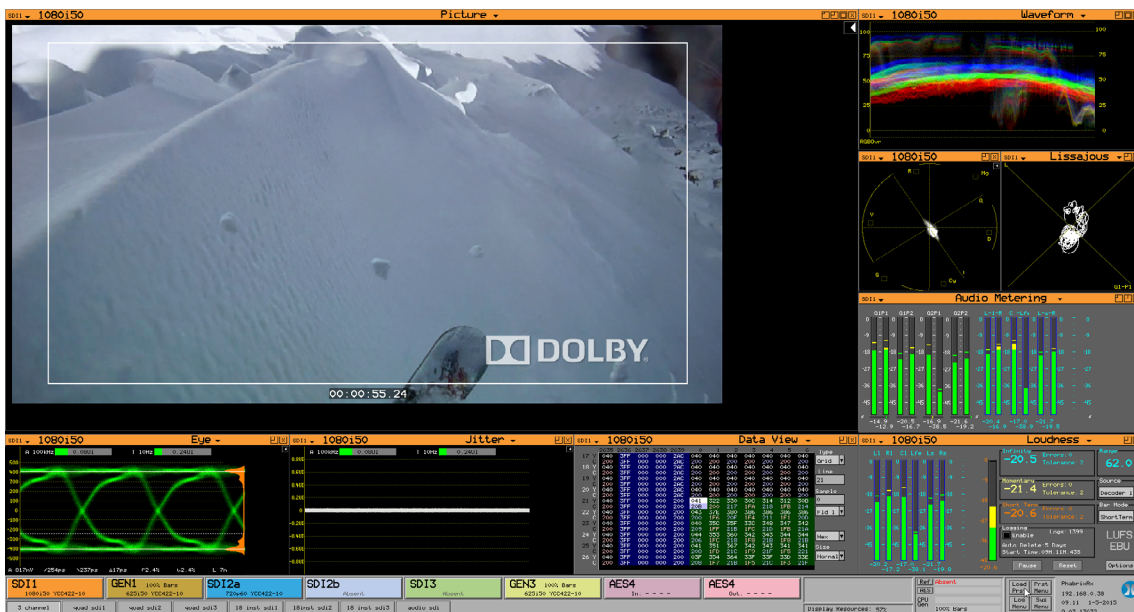

Note that on the Rx 500 and Rx 1000 instruments, the Monitor Output is always enabled. But on the Rx 2000 instrument, however, the Monitor output can be enable/disable in the “HDMI/SDI Output” menu that is available from the Instrument Display on the front of the instrument.

When an HDMI or SDI monitor is connected to the Rx instrument, it will display a Task Bar along the bottom of the screen that shows the currently installed Analyzer and Generator modules. These are colour coded to match the instrument panels allocated to the selected input/output and module. All of the instruments that share the same Analyzer or Generator resource have the same colour coding.

Module Slot 1		Module Slot 2		Module Slot 3	
(Analyzer 1 + Generator 1)		(Analyzer 2)		(Analyzer 1 + Generator 3)	
Input	Output	Input a	Input b	Input	Output
SD11 1080150 YCC422-10	GEN1 100% Bars 625150 YCC422-10	SD12a 720p60 YCC422-10	SD12b absent	SD13 1080160 YCC422-10	GEN3 100% Bars 625150 YCC422-10
3 channel	quad sdi1	quad sdi2	quad sdi3	18 inst sdi1	18inst sdi2
				18 inst sdi3	audio sdi

Clicking on the Input of an Analyser module will allow different analyser instruments windows to be selected for that input. Clicking on the Output of a Generator module will allow different generator windows to be displayed for that output. Clicking on the System, Logging and Presets menus will corresponding windows to be displayed.

Display Area

The display area above the “Task Bar” can display any of the instrument panels that are available with the installed hardware modules and software options. The instrument panels that are display can be selected from pre-configured, already saved and/or New instrument panels (or windows) created by right-clicking using the mouse.

Locking Reference VITC and LTC

Vertical Interval Timecode (VITC) and Longitudinal Timecode (LTC) present on the analogue (625i/50 and 525i/59.94) locking reference signal connected to the “REF” connection on the rear of the Rx unit can be displayed on the Task Bar of the HDMI® monitor output.

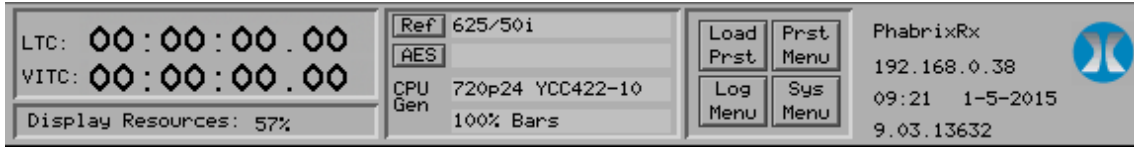

The locking reference can be selected by pressing the “Ref” button. This offers Free Run, External Reference (analogue locking reference signal) and SDI inputs

The “System” - “Time Code Setup” menu allows the system’s locking reference input LTC and VITC to be displayed on the HDMI® monitor output. The line number where the VITC is located on the analogue locking reference signal can be selected using the “Line Number” field.



Instrument Panel Re-sizing

Instrument panels are created and displayed at sixteenth screen size by default. Specific instruments such as Picture, Waveform, Vectorscope and Eye waveform can be displayed at quarter screen size. The Picture and Waveform instruments can also be displayed a 3/4 screen and at native resolution (with 1080i this will be full screen 1920 x 1080)



Instrument panels of different sizes can be assembled on screen in any combination and these can be saved as memory presets.

The icon buttons in the top right corner of the instrument panel control the size of the panel:

-  1/16th size panel
-  1/4 size panel
-  Close panel

Note that the window panel size can also be changed by double clicking in the instrument area using the left-hand mouse button.

Note to create 3/4 size Picture and Waveform, start with a 1/4 size window and drag the bottom right corner of the window until it is approximately 3/4 size then let go.

Managing the Monitor Output

Closing Open Panels (Windows)

Any open panels can be closed using the “X” button in the top right corner of each panel. The currently selected panel (the one with the blue bar) can be closed by left-clicking the mouse on the System menu and selecting the “Close Window”. The “Close ALL Windows” function will remove all of the instrument panels from the display area.

The functions within each Instrument panel on the Monitor Output display can be selected using the mouse rather than the “Navigation Buttons” used with the front panel Instrument Display.

Working with Multiple Analyzers

The analyzer channel that is used for the instrument panels is directly locked to the input of the Analyzer module itself. Clicking on the Input of an Analyser module on the task bar will allow different analyser instruments windows to be selected for that input. The input to be analyzed can also be selected from a drop-down list (“SDI1a”, “FIB1a”, “SDI1b”, “FIB1b”, “SDI2a”, etc).

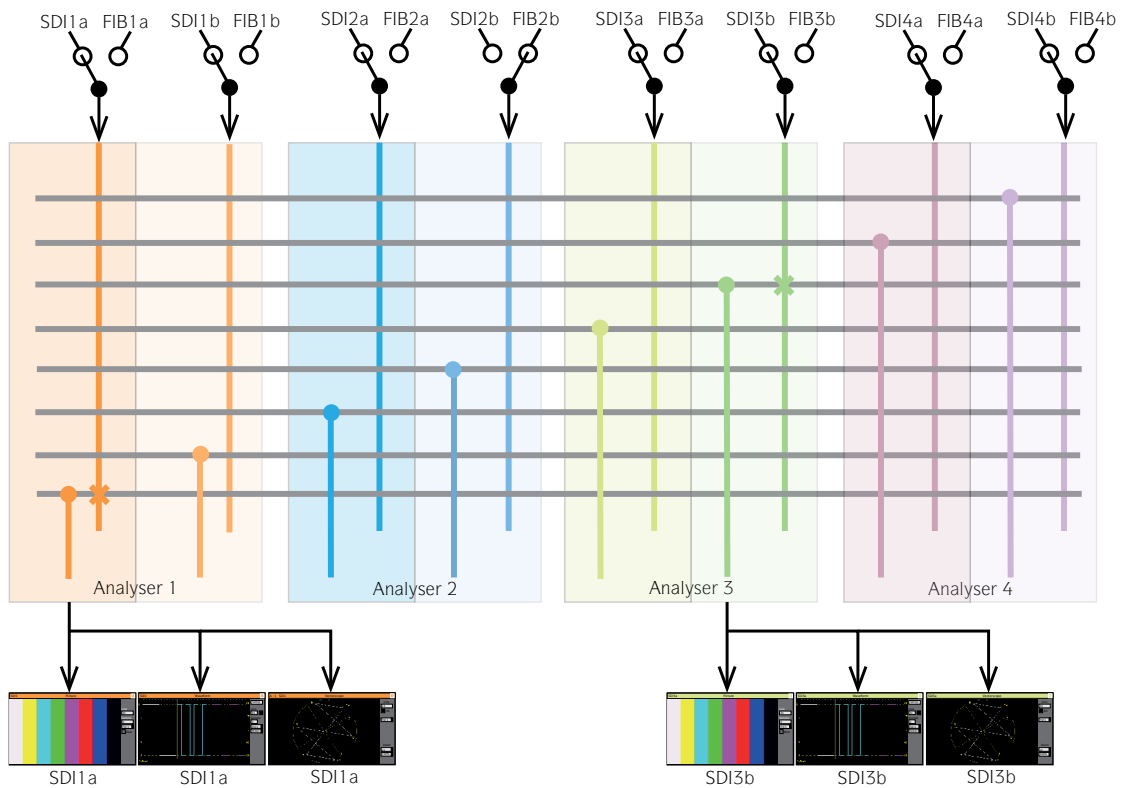

Note that Analyzer 1 is used by the Front Panel on the Rx2000 instrument so if the input to analyzer 1 is changed on the Front Panel it will also change the HDMI® monitor output.

Note that changing an input that has already be assigned to an analyzer will re-assigned the input to all of the instrument panels that share the same analyzer.

Note also that an input can only be monitored by one analyzer channel at a time.

Note that for Dual Link analysis the Link 1 signal must be connected to “IN1” BNC connector and the Link 2 signal must be connected to “IN2” BNC connector on the same Anayzer module. Likewise if Fibre is being used Link 1 should connect to “OPTICAL A” and Link 2 should connect to “OPTICAL B”

Working with Multiple Generators

When the Rx instrument contains multiple Generator modules, the generator to be controlled can be selected from the drop-down list in the corner of the panel (GEN1, GEN2, etc). Note that the PHRXM-GG module has 2 outputs (GEN-A and GEN-B) but this is treated as a single Generator as the outputs are locked together.

Saving Monitor Display Layouts



Elements of the currently displayed Instrument Panels can be saved as presets using the “Prst Menu” button on the Task Bar.



The “System Presets” panel then allows “HDMI Layout” check box to be chosen, a name given to the preset before it is saved. Stored presets can then be recalled at a later time either using the Load Preset menu or via the front panel controls of the Rx instrument.

Contextual Menus

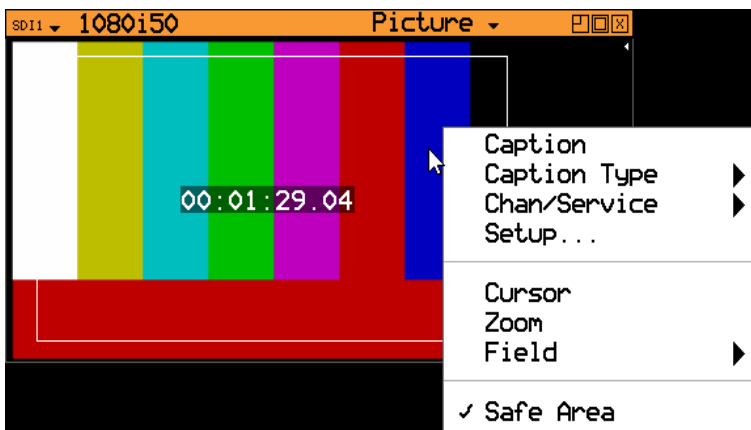

Right-clicking on the Picture, Waveform, Vectorscope, Lissajous, Eye and Jitter windows will display context sensitive menus that can be used to control the functions of these instruments.

Generator Panels

Overview

Clicking on the Output of a Generator module will allow different generator windows to be displayed for that output.

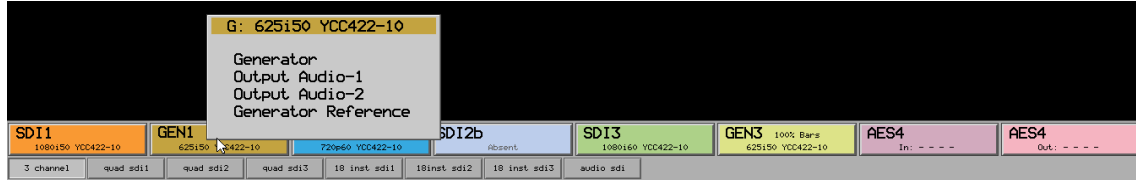

Clicking on instrument type title (Generator, Generator Audio 1-4, Generator Audio 5-8, Generator Reference) allows the generator type to be changed.

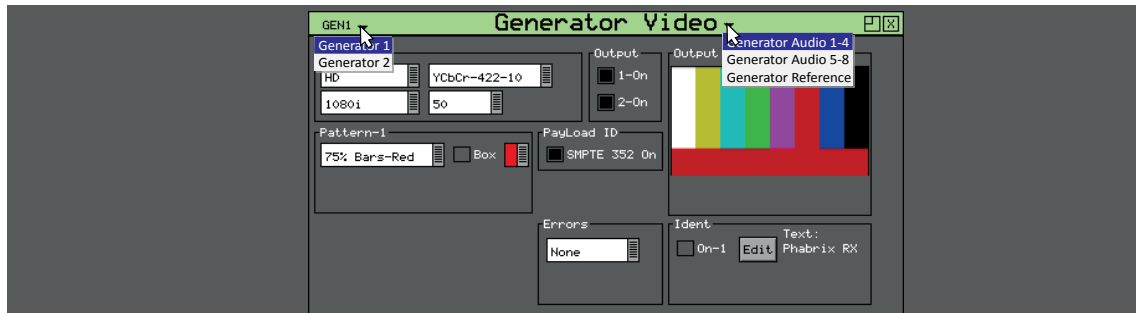

Generator Video

The Rx instrument with a Generator Module installed can create video test signals for all supported SD and HD SDI output standards including the 3GHz standards at 1080p/50/59/60. It will support Y,Cr,Cb formats as well as RGB formats.

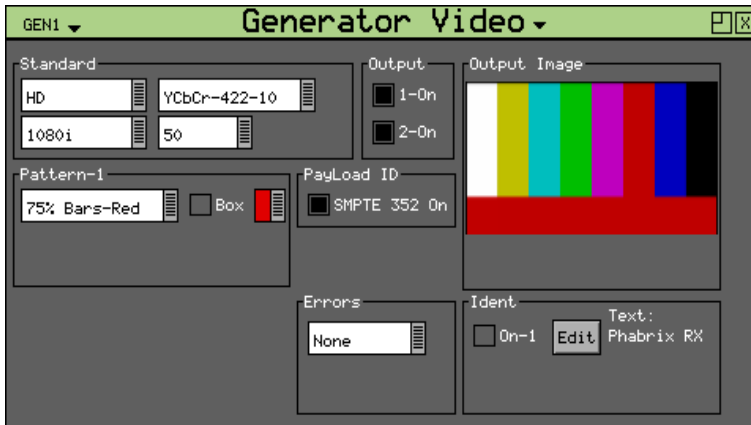

The Generator Video window is accessed by clicking on a Generator output slot on the monitor output task bar and selecting "Generator". This will create a new window panel for the selected output.

Output On

The Output On function turns ON the output circuitry. On Rx instruments that have dual generator modules, there is the option to turn on output 1 and output 2 which correspond to the 2 generator outputs.

Note that for Dual Link test pattern generation both Output 1 and Output 2 must be enabled. The Link 1 signal is produced on the module's "GEN A" output and the Link 2 signal is produced on the module's "GEN B" output. Likewise if a Fibre connection is being used the Link 1 signal is produced on "OPTICAL GEN A" and the Link 2 signal is produced on "OPTICAL GEN B".

Standard

The menus in the Standard section are used to select the desired video output format. The top-left box selects the basic mode of the Rx instrument and determines whether it is generating normal SD/HD video or 3G level A or level B video. Dual streams refer to the ability of the Rx instrument to generate two separate pictures when transmitting 3G-level B in some formats. Which mode is selected determines which formats are available. Only valid frame rates for the output standard may be selected.

Colour Format

Currently only YCbCr 4:2:2 10 bit picture formats are supported by the standard product but an Option may be purchased to enable other colour formats. The following colour modes may be selected dependent on line standard selected:

- YCbCr 422 10bit
- YCbCr 444 12bit
- YCbCr 444 10bit
- YCbCrA 4444 10bit
- YCbCr 422 12bit
- RGB 444 10bit
- RGBA 4444 10bit
- RGB 444 12bit

Pattern

This selects the video pattern that is output by the generator. Many standard patterns are provided by the Rx instrument. You may also upload your own test patterns to the Rx instrument into the 'Patterns' directory and then select them using the 'User File' option in this field. See the 'File Structure - Patterns' section for file formats supported. If a 'User File' has been selected, the 'i' button beside the file can be selected to get information on the file properties. Unsupported file types will be displayed as a black image. If the video standard is changed while a user file is loaded and there is no file for the new standard present, a black image will be loaded and the User File blanked.

A bouncing Box may be overlaid on the current test pattern by selecting the Box check box field.

Colour Bars test patterns are used to check that the colour gamut of the television system and to ensure the correct luminance and chrominance levels.



The "100% Colour bars" test pattern is produced by using combinations of the Red, Green and Blue primary colours:

White (100% R, 100% G, 100% B)
 Yellow (100% R, 100% G, 0% B)
 Cyan (0% R, 100% G, 100% B)
 Green (0% R, 100% G, 0% B)
 Magenta (100% R, 0% G, 100% B)
 Red (100% R, 0% G, 0% B)
 Blue (0% R, 0% G, 100% B)
 Black (0% R, 0% G, 0% B)



The "75% Colour bars" and "75% Colour bars + Red" test patterns are produced by using combinations of the Red, Green and Blue primary colours:

White (100% R, 100% G, 100% B)
 Yellow (75% R, 75% G, 0% B)
 Cyan (0% R, 75% G, 75% B)
 Green (0% R, 75% G, 0% B)
 Magenta (75% R, 0% G, 100% B)
 Red (75% R, 0% G, 0% B)
 Blue (0% R, 0% G, 75% B)
 Black (0% R, 0% G, 0% B)

Note that for consistency 75% colour bars should always be used when measuring or comparing jitter levels.



The "Tartan bars" test pattern is a chequerboard pattern of 75% colour bar colours that produces every combination of colour vector change.



The "SMPTE Colour bars" test pattern was developed for the NTSC analogue video standard and produced by using the combinations of the Red, Green and Blue primary colours as used in 75% colour bars.



The "SMPTE ARIB STD-B28 Colour bars" test pattern is an updated version of SMPTE colour bars (developed by the Japanese Association of Radio Industry and Businesses) and standardized as SMPTE RP 219-2002 and is used to test both 4 × 3 standard definition and 16 × 9 high-definition video signals.

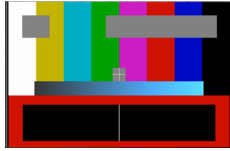

The AV Delay Test pattern and audio tone provided by the Generator module can be used to check any delay between the video and audio. This animated test pattern provides a constantly moving Clapper board and corresponding AV Delay tone when the clapper board reaches the centre of the test pattern.



The “Multi-burst” test pattern is used to check the frequency response of the video path and check that it has not been affected by digital processing such as resizing, standards conversion or colour grading. The frequency of each burst will depend on the video format selected. For example:

For SD 720 pixels:

0.5MHz 1.75MHz 2.5MHz 3.5MHz 4.5MHz 5.5MHz

For HD 1920 Pixels:

5MHz 7.25MHz 15MHz 20MHz 25MHz 30MHz

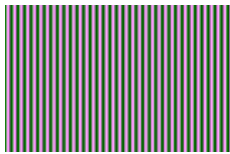

The “Bowtie” test pattern is used to check the alignment of the luminance and chrominance components through television equipment.

The Ramps and Steps test patterns are used to check the linearity of television equipment to ensure that there have been no digital bit level artefacts such as rounding errors introduced that may cause banding on the television pictures.



The “Luma Ramp” test pattern is used to check the linearity of the luminance component. This test pattern exercises all of the discrete digital video levels including illegal values below video black and above peak white.



The “Legal Ramp” test pattern is used to check the linearity of the luminance component. This test pattern exercises all of the discrete digital video levels from video black to video white, excluding illegal values.



The “Valid Ramp” test pattern is used to check the linearity of the Y (luminance), Cr (R-Y) and Cb (B-Y) components. This test pattern exercises all of the discrete digital video levels of these components, excluding illegal values.



The “Grey Bar - 5” test pattern is used to check for non linear distortion in the luminance component. The bars range from 100% white to 0% black in 20% steps. Typically non linearity will be seen as a loss of grey-scale distinction.



The “Grey Bar - 11” test pattern is used to check for non linear distortion in the luminance component. The bars range from 100% white to 0% black in 10% steps.



The “Grey Bar - 5 Vertical” test pattern is used to check for differential gain distortion in the luminance component line by line. The bars range from 100% white to 0% black in 20% steps. Typically non linearity will be seen as a loss of grey-scale distinction.



The “Grey Bar - 11 - Vertical” test pattern is used to check for differential gain distortion in the luminance component line by line. The bars range from 100% white to 0% black in 10% steps.



The “Pluge” (picture line-up generation equipment) test pattern is used to adjust the black level and contrast of a video monitor. The pattern consists of vertical luminance bars for white, mid grey, black and super black.

The Colour Field test patterns are used to provide primary colours (such as 100% red, green, blue, cyan, magenta and yellow) and monochrome luminance levels to check for calibration and banding effects caused by encoding/decoding processes.

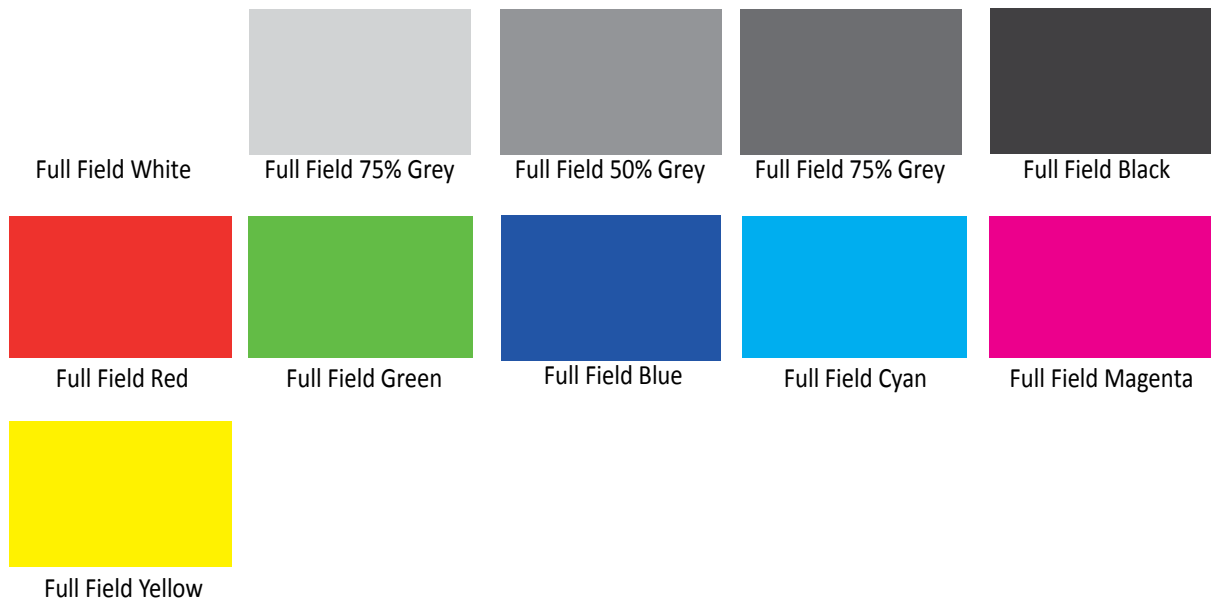

If colour field is the selected test pattern, another control selects which colour to generate. Three user definable custom colours may be defined using the “->” button. Custom colours are edited using the Red-Green-Blue sliders. When setting the colour using the RGB sliders, the YCbCr values will show the values for the current colour space. When setting the colour using the YCbCr sliders, the RGB values will show the values for the current colour space.

The Zone Plate is a 2 dimensional linear frequency sweep test pattern used to check the affect of filtering, sub-Nyquist, sampling, processing standards conversion and display. Whenever an image is re-sized or re-sampled there is a strong probability that the resultant image will suffer from one or more of the artefacts such as aliasing / moire, softening (caused by reduced frequency response) and ringing / halos.

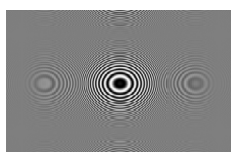

The “Zone Plate” test patterns are used to check that the horizontal and vertical frequency response of the video path is not affected by television equipment.

The zone plate selector will contain 3 user customisable zone plates as well as several pre-determined zone plates. The ‘->’ button displays a dialogue which allow the parameters of the zone plate to be adjusted for the custom zone plates. Any of the preset zone plates may be

copied to the custom zone plates to act as a starting point for a new zone plate. As the zone plate settings are stored in user memories a large number of custom zone plates are available:

Moving Zone-2H - A moving zone plate centred on the screen.

Static Zone-2H - A static zone plate centred on the screen from DC to the nyquist frequency at left/right edges.

Static Zone-2V - A static zone plate centred on the screen from DC to the nyquist frequency at top/bottom edges.

Sweep-Horiz - A horizontal sweep from DC to nyquist frequency horizontally.

Sweep-Vert - A vertical sweep from DC vertically.

Grating-50kHz - A 50kHz frequency sine wave when using an HD output.

Grating-1MHz@HD - A 1MHz frequency sine wave when using an HD output.

Grating-5MHz@HD - A 5MHz frequency sine wave when using an HD output

Custom allows editing of Custom zone plate settings. Three custom zone plates can be set up and can be copied from an existing presets using the 'Copy To' button.

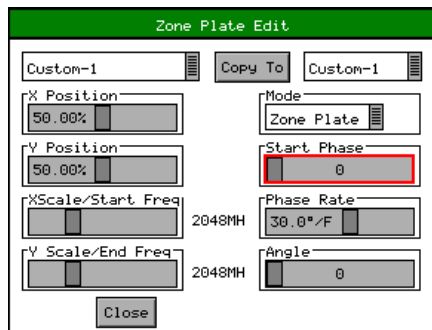

Mode - sets which type of Zone Plate is being produced. It may be Zone Plate (circular pattern) Grating (Linear horizontal or vertical grid) Sweep (Frequency sweeps from start to end Frequency)

Start Phase - sets the start phase of the sine wave generated by the zone plate generator and is set in degrees from 0-360

Phase Rate - is used to set the rate of change of phase of the sine wave and thus changes the speed that the zone plate moves at. It is specified in degrees per frame.

Angle - changes the angle of the zone plate and thus can change a horizontal sweep into a vertical sweep or rotate an elliptical zone plate pattern.

XScale/Start Freq - sets the horizontal scale of grating patterns or the start value of the zone plate sweep frequency.

Yscale/End Freq - sets the vertical scale of grating patterns or the end value of the zone plate sweep frequency.

The Pathological test patterns are used to check that the phase locked loop circuitry used to decode SDI data can recover/regenerate the SDI sample clock under worst case conditions.



EQ Test is a pathological signal that generates long run-lengths of 1s or 0s (for example 19 samples of 0 followed by a single 1) to test the accuracy of phase lock loop circuitry that recovers/the sample clock from the SDI data.



PLL Test is a pathological signal that generates a pattern of 2 consecutive 1s followed by 2 consecutive 0s repeated for the whole pattern. This is the worst-case to test phase lock loop circuitry that recovers/regenerates the sample clock from the SDI data.



Check Field is a pathological signal that generates long run-lengths of 1s or 0s to test the accuracy of phase lock loop circuitry that recovers/regenerates the sample clock from the SDI data. This is a combination of the EQ Test pattern and the PLL Test Pattern.



If Check field/Pathological is selected when a dual stream format has been selected, BOTH outputs will be forced to check field due to internal hardware limitations. If another pattern is selected, the Check field pattern will be de-selected. The exceptions to this are when Colour Field or Zone Plate are selected as test patterns.

The Check field/Pathological/PLL Check/EQ Check patterns will only look like the picture above when a YCbCr 422 10 bit colour mode is selected. Other colour modes will have different pictures but still create the SDI data stream required by SMPTE.

EDH

If the output signal is SD (PAL-625 or NTSC-525) the insertion of EDH information may be turned on or off.

Errors

This field enables the insertion of CRC or EDH errors into the video signal. This allows checking of third party error detection circuitry. In SD there is one EDH ancillary packet per field. When errors are being inserted every EDH value gets deliberately corrupted. This creates one error count per field. (Actually one AP error and one FF error). In HD there is a CRC value calculated for each line. When errors are being inserted the CRC value on line number 1 gets deliberately corrupted. This creates one CRC error count per frame. There is also the option to generate CRC errors (not SD EDH errors) on only the switching line in field 1 which can be used to check that any downstream equipment ignores errors on switching lines.

SMPTE 352

This check box allows the SMPTE 352 Payload ID field to be inserted into the video output stream. The state of this check box is stored separately for SD, HD and HD-3G line standards. Note that for HD-3G line standards the Payload ID should be turned ON.

Ident

An picture or text 'Ident' may be set to identify an SDI source. This Ident can be turned on/off from this page but changing the text/font/bitmap is performed by selecting the Edit button to bring up the Ident Dialog. An overview of what the Ident is can be seen beside the Edit button. Note: If zone plate or colour field are selected, text cannot be overlaid over them. A smaller version of the video output signal is displayed on this page with any overlaid ident.

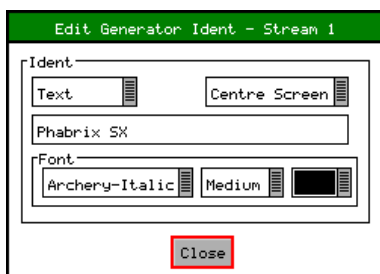

This dialogue allows selection of either a user defined bitmap picture which has been downloaded into the 'Idents' directory of the Rx instrument or user defined text.

For both types, the position of the ident can be set to one of Top-Left, Top-Centre, Top-Right, Left-Centre, Centre-Screen, Right Centre, Bottom-Left, Bottom-Centre, Bottom-Right. When text ident is used, the font, font size and colour can be specified. Several fonts are built in to the Rx instrument, other true-type (.ttf) fonts may be downloaded as required.

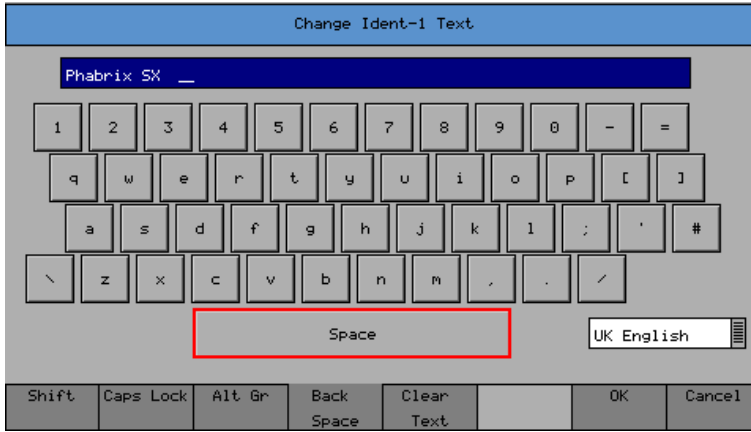

When editing text, the keyboard above is displayed to allow easy editing. Move the cursor to select the key to 'press' and then press 'Ok' to 'press' it. The Shift menu key causes the next keyboard to change to shift mode for the next key press.

The Caps Lock menu key locks the keyboard in all capitals mode. The Alt Gr. key shows any language dependent alternate keys that may be pressed. Several country keyboard styles are provided. Note that not all fonts support all non-English characters.

Frame Grab Playout

Each Generator module within the system can play-out a video clip captured and saved using the Picture Frame Grab function. This can be used to playout generated test clips as well as video clips captured when an error condition occurred.

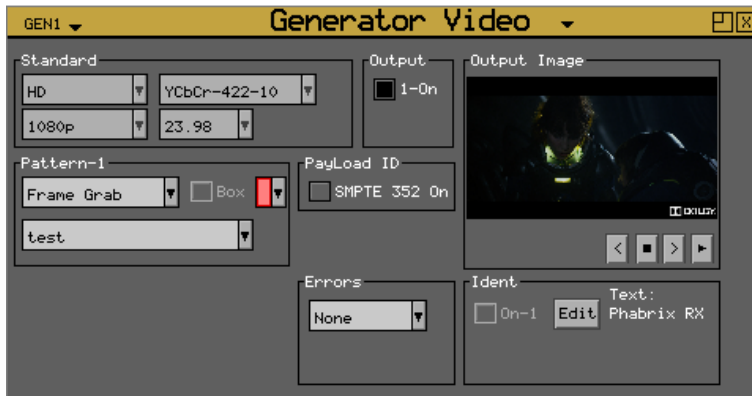

The Frame Grab playout mode can be enabled by selecting Frame Grab from the test patterns drop down list.

Any video clip recorded using Frame Grab will appear in the drop down list.

Once a video clip has been selected and loaded the transport controls can be used to play, stop, step forwards and set backwards.

- < - steps backwards through the selected video clip frame by frame.
- - stops the playing video clip.
- > - steps forwards through the selected video clip frame by frame.
- ▶ - plays the video clip repeatedly.

The displayed video clip will be output via the Generator video output connection along with its audio and SMPTE 352 payload.

Note that the Generator video format and frame rate will automatically be set to that of the video clip being played.

Note also that Box and Indent cannot be used when a video clip is selected for playout.

Generator Reference

The Rx instrument with a Generator Module installed can create video test signals that are either free-running or locked to a studio reference signal. The Genlock menu is used to select an external locking reference or set the instrument to free run.

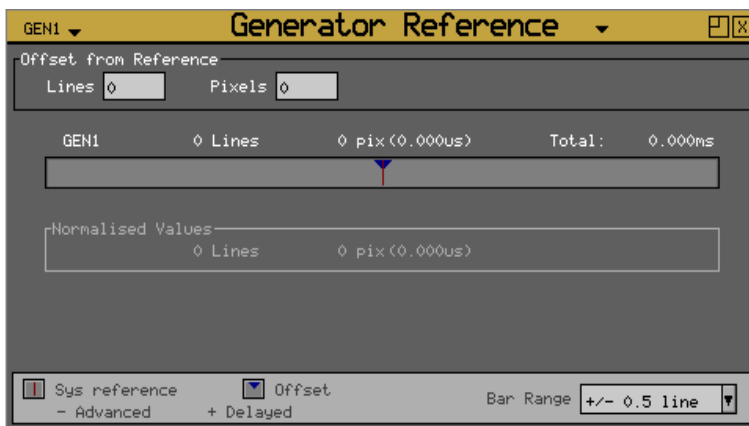

The Generator Reference window is accessed by clicking on a Generator slot on the monitor output task bar and selecting “Generator Reference”. This will create a new window panel for the selected output.

When using an external locking reference signal, the Rx system will provide the best possible locking regardless of the locking reference frame rate and the generated frame rate.

When the frame rate of the locking reference is exactly the same as the generated frame rate, there will be an exact lock vertical and horizontal between them.

When the frame rate of the locking reference and the generated frame rate are divisible (for example 50/25, 60/30, 59.94/23.98) there will be an exact lock vertical and horizontal between them.

When there is no relationship between the frame rate of the locking reference and that of the generated frame rate (for example a 625/50 locking reference and a 23.98 generated test pattern) then there will be a static lock between them but this will not be consistent.

Source

The generator may be locked to an input reference which may be either the reference input which is a Bi-Level/Tri-Level sync or may be locked to the video input. Alternatively, the generator may free run.

Delay

The test patterns generated by the Generator module can be delayed or advanced with respect to the locking reference input using the Lines and Pixel values.

Generator Output Audio Menu

The Rx instrument with a Generator Module installed can embed an audio signal on all 16 embedded audio outputs. The Output Audio 1 and 2 menus control which audio channels, pairs or groups have test tones applied and the type of tone.

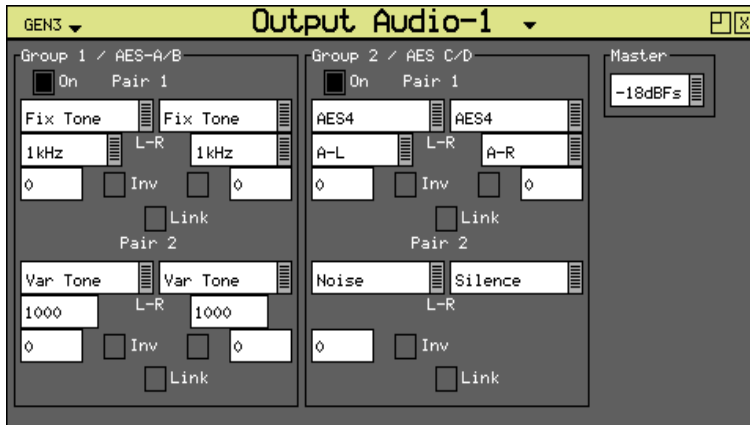

The Output Audio 1 window is accessed by clicking on a Generator output slot on the monitor output task bar and selecting “Output Audio 1”. This will create a new window panel for the selected output.

Group *n*

Each of the four groups may be separately enabled. When enabled, the source and level of each channel in a pair can be selected.

Source

The source for each channel may be set to any of the following:

Silence - digital silence at -144 dB with 24-bit

Fixed tone - a range of fixed frequencies from 100Hz up to 20kHz

Variable tone - where the frequency can be set on 1Hz steps from 1Hz to 23.99kHz)

Noise - white noise

A/V Delay - providing a 1 kHz pulse tone centred about the clapper board animation of the the AV Delay Test pattern

AES In - routing the audio from the CPU AES input if present.

DolbyGen - if the Dolby Generation option has been purchased, the source may be set to “DolbyGen” at which time the other channel in the audio pair is also set to “DolbyGen” and gain control disabled. The generated Dolby metadata is defined in the System - Dolby Generator menu.

DolbyDecode1 - if the Dolby Decoder module is installed, the decoded Dolby audio channels “Dolby-1” to “Dolby-8” from Decoder 1.

DolbyDecode2 - if the Dolby Decoder module is installed, the decoded Dolby audio channels “Dolby-1” to “Dolby-8” from Decoder 2.

AES - if a 4AES module is installed along with a Generator module then the AES audio from the AES module can be routed to the Generator module SDI output. The specific 4AES module input channels can be selected from the source drop down list in the form “A-L” where “A” indicates input AES Input A and “L” indicates the left channel.

Inv

This check-box phase-inverts the audio signal to allow checking of third-party audio mixing.

Link

This links the left and right channels of a pair so that changing the level on the left hand channel changes the level on the right hand channel.

Master

The master level sets the 0dB level for all the embedded audio channels. Thus if the Master level is set to -18dB and group 1 pair 1 output is set to -2dB, the actual level output on that pair is -20dB. This feature allows all embedded outputs to be adjusted together as well as giving a simple method to change from -18dB to -20dB based standard levels. The Master level will not adjust the level of an AES input signal selected for embedding on SDI output.

4AES Module

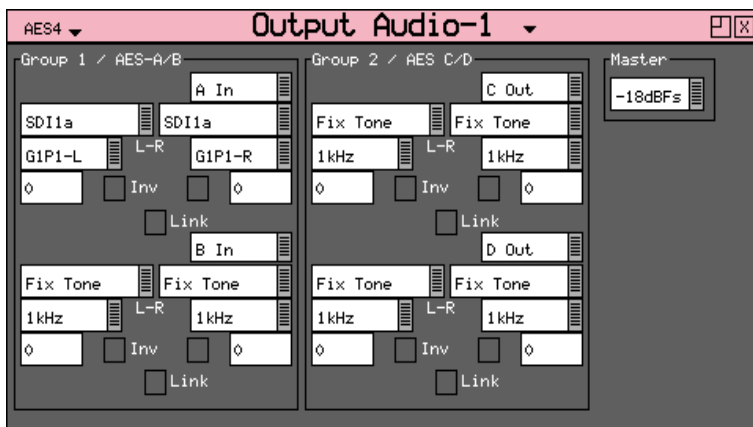

The Output Audio window is accessed by clicking on a 4AES Module Generator slot on the monitor output task bar and selecting “Output Audio 1”. This will create a new window panel for the selected output.

The PHRXM-4AGE module has 4 bi directional AES digital audio pairs (“IO_A”, “IO_B”, “IO_C” and “IO_D”).

When configured as inputs this allows the audio pairs to be routed to the Audio Meter, Lissajous and Loudness instruments for the 4AES module.

When configured as outputs the audio pairs can be audio tones (including Fixed Tone, Variable Tone, Silence or Noise) or selected embedded audio channels from an Analyser SDI video input or loop through copies from another AES input.

The mode of operation can be selected from the Generator Audio Groups menu the for each audio pair using the drop down list (displaying “A Out”, “A In” or “B Loop”).

When “# Out” is selected the chosen AES pair will be configured as an output. The type of output is selectable from the drop down list (displaying Fixed Tone, Variable Tone, Noise, etc). The embedded audio from any Analyser SDI video can be selected from the source drop down list to allow it to be routed to the AES module output. Each audio channel that is output by the 4AES module can be selected from a specific SDI input, audio group and left/right channel.

When “# In” is selected the chosen AES pair will be configured as an input and therefore allow the audio from the AES connector to be viewed on the Audio Meter, Lissajous display or Loudness meter.

When “# Loop” is select the chosen AES pair will be configured as an output with a copy of the corresponding AES input.



If DolbyGen is selected as the Source for any AES output, the Dolby Generator in the System menu needs to be set to External reference otherwise the Dolby audio packet may not be embedded into the AES stream in the correct place.

Monitor Output

Analyzer Panels

Overview

Clicking on the Analyser module button on the task bar will allow different analyser instruments windows to be selected for that input.

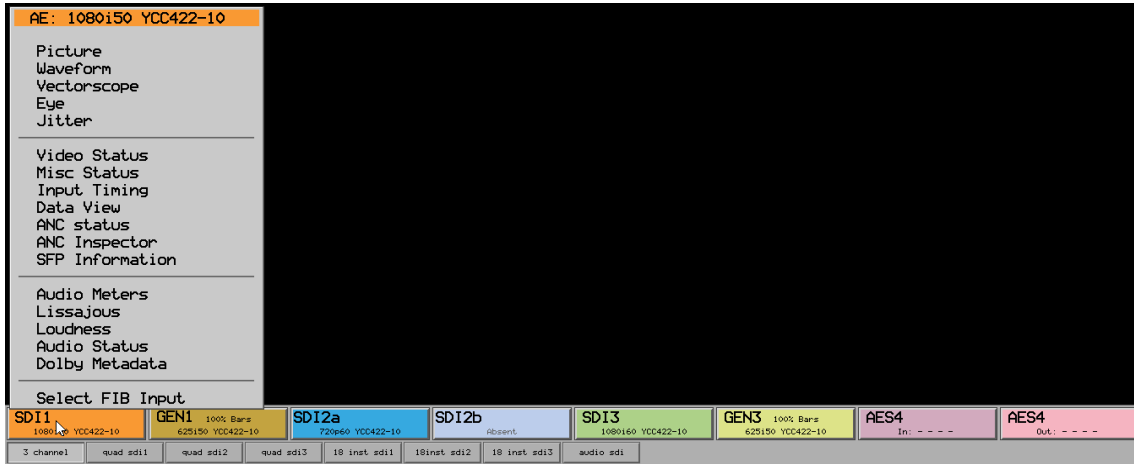

Clicking on instrument type title (Picture, Waveform, Vectorscope etc) allows the waveform type to be changed. Clicking on the input allows the input to the analyzer to be changed.



The 4AES module provides audio-only analysis tools and audio-only generation tools. Pressing the left-hand AES button (input) will display the analyser functions that are available and pressing on the right-hand AES button (output) will display the Output audio configuration menu.

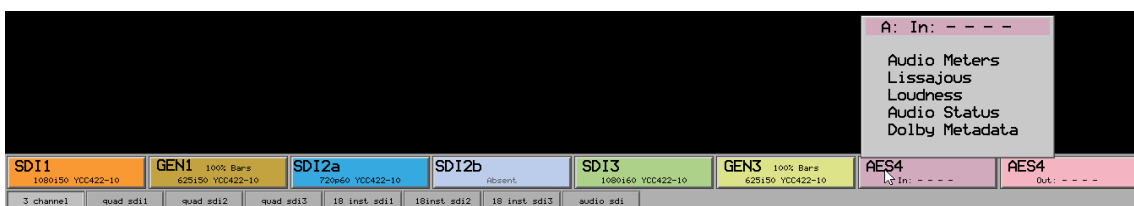

Picture

The Rx Instrument with an Analyzer Module installed can display the selected input in the form of a picture monitor.

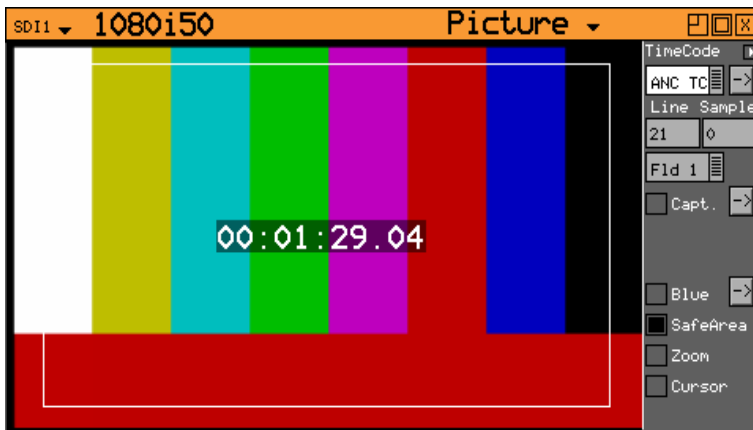

The Picture window is accessed by clicking on an Analyzer slot on the monitor output task bar and selecting “Picture”. This will create a new window panel for the selected input.

Selecting the white arrow in the top corner of the window will show/hide the menu controls. Right-clicking on the image will also allow menus to be selected.

The picture displayed is down-converted from the video source. The picture will automatically view the horizontal or vertical blanking areas if the line or sample values are in the blanking.

Blue: Show only the Blue colour component of the picture.

Aspect Ratio: The aspect ratio of PAL (625 lines) may be set to be either 4:3 or 16:9 as required for the source signal. NTSC (525) signals are always 4:3 aspect ratio and HD signals are always 16:9.

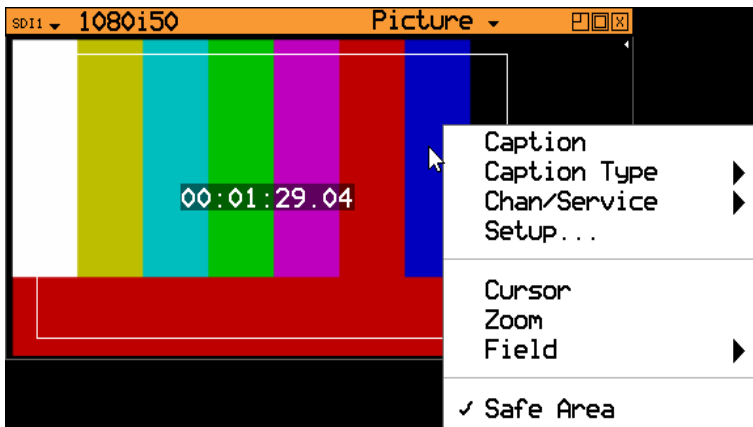

Right-clicking with the mouse in the image area will display contextual menus that can be used to select and setup the different functions on the Picture window.

Timecode Display

ANC time code can be displayed in the active picture area when turned on. Selecting the arrow to the right of the Time Code field allows This window allows it to be displayed in 3 different positions and 3 different sizes.

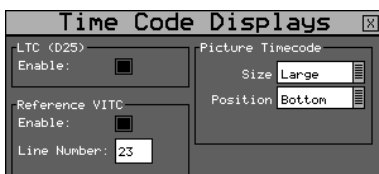

The Time Code Displays window also controls display of time code information on the HDMI® monitor output. Time code is available on the locking reference input and on each video input that is analysed.

Safe Area Generator

The Picture instrument includes 4 independent safe area generators that can be selected for “Safe Action Area-1”, “Safe Title Area-1”, “Safe Action Area-2” and “Safe Title Area-2”. Selecting the arrow to the right of the Safe Area check box allows the required safe areas to be setup and selected.

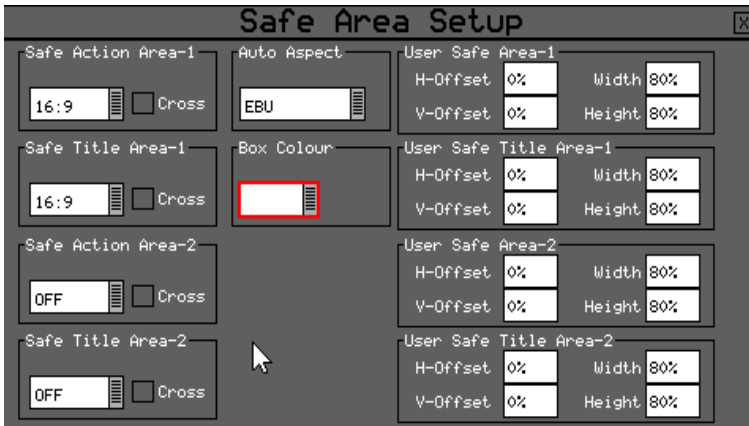

These can be selected from standard SMPTE, ARIB TR-B.4, EBU or ITU templates for 4:3, 14:9, 16:9 or aspect ratios or can be user-defined.

Sample, Line and Field Selection

- Sample: Specify the current sample for analysis.
- Line: Specify the current line for analysis.
- Field: (Only for interlaced formats) This control selects the field for analysis. If the current line is in Field 1, changing the field will change to the same line in field 2. The field number will change to show the correct field for the current line number.

Cursors and Zoom

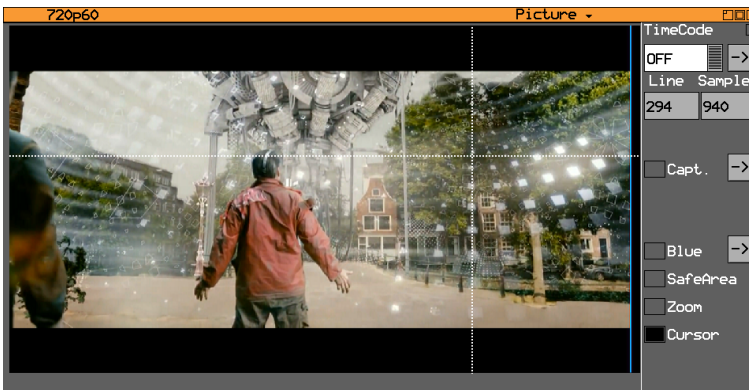

If the “Cursor” check box is selected, then clicking anywhere on the picture will place a cross-hair cursor to identify a specific line and pixel.

The selected line and pixel value will automatically be entered into the Line and Sample fields of the Waveform monitor. If the Waveform All check box is turned off then the selected line will be displayed.

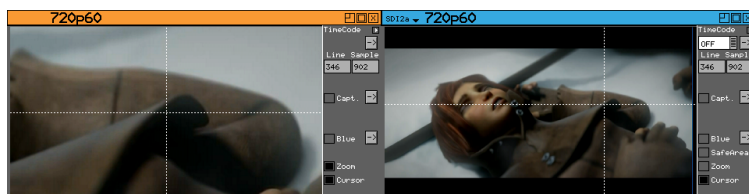

Selecting the Zoom function will expand the displayed image (within a 16th or quarter sized instrument window) to native resolution.

If the Cursor is used then the expanded image will be placed about the selected cursor position. Clicking and dragging on the image will move the zoomed image.

Closed Caption / Subtitle Display

If the closed caption option is installed, the Caption Options menu allows the selection of WST/OP42/OP47, EIA 608 and EIA 706 subtitles.



Closed caption text will be displayed in the image area as defined by the closed caption formatting information relevant to the closed caption type.

Closed caption is the name given to text-based, encoded and hidden information that is optionally displayed on screen by the user in America, Canada and Australia. In Europe this information is called subtitles. Europe and Australia use systems based on the standard WST (World System Teletext) format although they are named differently. The Closed Caption system used in America and Canada is technically a completely different system to WST.

The IEA 608 closed caption system (used in the USA and Canada for standard definition video) embeds a data packet on line 21/284 of the SDI 525i video framework and allows up to 32 characters per video frame and up to 4 different caption streams (called channels in this system).

The EIA 708 closed caption system (used in the USA and Canada for HD video) embeds information in the VANC area of the HD-SDI video framework and uses DID 61 for the Caption Distribution Packet (CDP). Typically this supports up to 6 different closed caption streams (called services in this system) although theoretically this system supports up to 63 services.

The WST subtitle system (used in Europe for HD-SDI) embeds information in the VANC area of the SDI video framework, typically on line 21/334. This system theoretically supports up to 2047 (0x7FF Hex pages) different closed caption pages. Typically, however, the number of pages is limited to those numbered 100 to 199, 200 to 299, etc up to 800 to 899. In Europe the common practice is to use pages 888, 889 and 890. In Australia however page 801 is used.

The OP42 closed caption system (used in Australia for analogue 625i standard definition video) is a specific subset of the functionality of the WST system and embeds information on line 21/334. This system supports only a few different closed caption pages with page 801 is used as the first page.

The OP47 closed caption system (used in Australia for HD-SDI) is basically a wrapper around the WST system that allows it to be embedded in the VANC area of the SDI-HD video framework using DID 43. This system theoretically supports up to 2047 (0x7FF Hex pages) different closed caption pages. Typically, however, the number of pages is limited. In Australia page 801 is used as the first page.

When configuring an Rx instrument with closed caption option the first thing to do is establish what closed caption system is being used or is present on the video signal. The ANC Status display (available with the HD/SD-SDI Data Analyser and Ancillary Packet Analyser option) will show IEA 608, IEA 708 and OP47 data packets that appear in the vertical ancillary area of the SDI framework. The corresponding closed caption can then be selected from the Closed Caption setup menu.

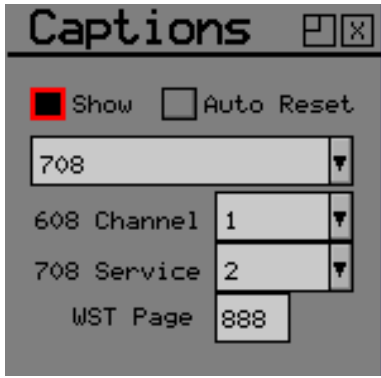

The Show check box, when enabled, displays the chosen closed caption type on the image.

The Auto Reset check box is for test purposes.

The 608 Channel numeric value allows the specific 608 closed caption channel to be selected.

The 708 Service numeric value allows the specific 708 service to be selected.

The WST Page value allows the appropriate World Subtitle page to be selected.

Gamut Error Indication

The Rx provides gamut error indication on the Picture instrument. Gamut errors can be shown on the picture by right clicking in the image area and then selecting “Gamut” – “Show”. The type of display can be selected from the “Gamut” – “Colour” menu.

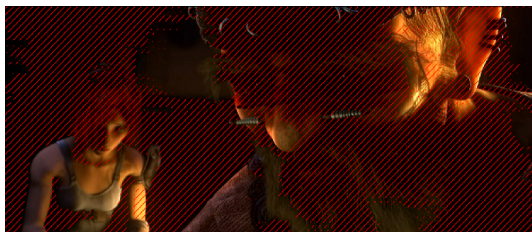

Colour BG Errors Red – this shows the errors overlaid as a red hash pattern on the image.

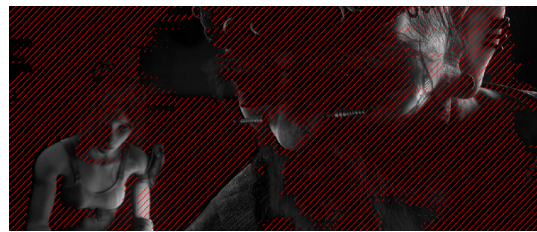

Gray BG Errors Red - this shows the errors overlaid as a red hash pattern on a monochrome image.

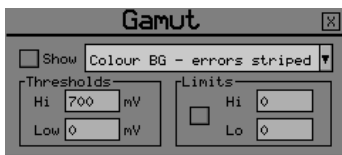

Gamut errors are displayed if the luminance level or individual Red, Green or Blue levels exceed 100% amplitude or if they go below 0% (absolute black). These are represented by the values Hi 940 decimal, 700 mV or 100% and Lo 64 decimal, 0mV or 0% in the Gamut setup menu

The Limits check box, when selected, ensures that out of gamuts colours on the HDMI output menu are replaced by legal values of RGB.

If the Picture cursor is used to select an out of gamut area, the corresponding line and pixel can be displayed on the Waveform monitor and Data View to measure the value.

Native Resolution Picture Display

The Picture instrument can now be displayed on the HDMI monitor at native resolution up to 1920x1080. A 1920x1080 image source will be displayed at full screen size. Smaller images formats such as SD (720x625 or 720x525) and HD image formats such as 1280x720 will be displayed at actual pixel size on the HDMI monitor.

The Picture can be displayed as full size by clicking on the image or by selecting the icon in the top right corner of the window. When expanded it will cover the underlying instruments and when it is reduced the underlying instruments will be displayed. The Picture can also be displayed at 3/4 screen size by dragging the bottom right corner of a 1/16th or 1/4 Picture.

AFD/WSS and V-Chip Monitoring

Both AFD/WSS and V-Chip monitoring is displayed in the top right corner of the image to allow quality control of programme material to be performed prior and during transmission. These can be enabled by using the Picture contextual menu (mouse right click in image area).

Frame Grab

Each Analyser module allows a video clip to be captured for analysis and playback. The video clip contains the full SDI data frame including video data, metadata and audio data. The video clip can be recorded manually or can be triggered by a number of different events such as EDH and CRC errors. When Frame Grab record mode is selected a rolling record buffer (holding approximately 70 SD frames or 13 HD frames) is started so that the full SDI data frames before and after the trigger point are available for analysis. When a trigger is received the record buffer is frozen to provide a video clip.

Once a video clip has been captured it can be played-back and navigated frame by frame using the transport controls within the image area of the Picture instrument. The Rx instruments can be used to analyse the SDI data frame by frame to display errors at the trigger point and the status of the SDI frames before and after the trigger point.

The captured video clip can be saved for future reference and previously saved clips can be restored.

To manually capture a video clip, select the record button to start the record buffer ("RECORDING") and then press the T button to stop the record buffer ("CAPTURED").

To capture a video clip from a trigger event, setup the event to be captured in the setup menu, press the record button to start the record buffer ("RECORDING"). As soon as the trigger event has occurred, "CAPTURED" is displayed to indicate that event has been captured as a video clip. The play, step forward and step backwards buttons can then be used to navigate through the SDI data frames.

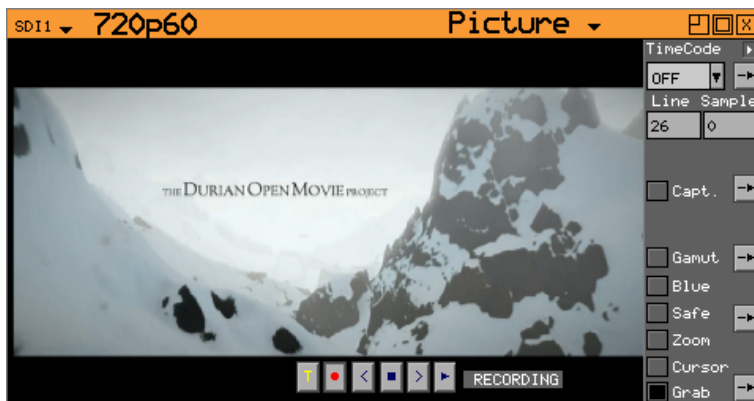

The Frame Grab controls are displayed by selecting the "Grab" check box in the Picture instrument menu.

The arrow box to the right of the "Grab" check box is used to setup triggers and save video clips.

- T - manual trigger for video clip capture
- - starts record buffer
- < steps backwards through the captured video clip frame by frame.
- stops the playing the captured video clip.
- > steps forwards through the captured video clip frame by frame.
- ▶ plays the captured video clip repeatedly.

The text box to the right of the transport controls displays the current status of the record buffer:

BUFFERING - indicates that the record buffer is filling up.

RECORDING – indicates that the record buffer is actively recording the SDI data stream.

CAPTURED - indicates that a video clip has been captured

PLAYING – indicates that the current contents is being played as a video clip

13/13 (T:7) – indicates the current frame/total number of frames and the trigger frame number. This text will turn red when the currently displayed frame is the trigger frame.

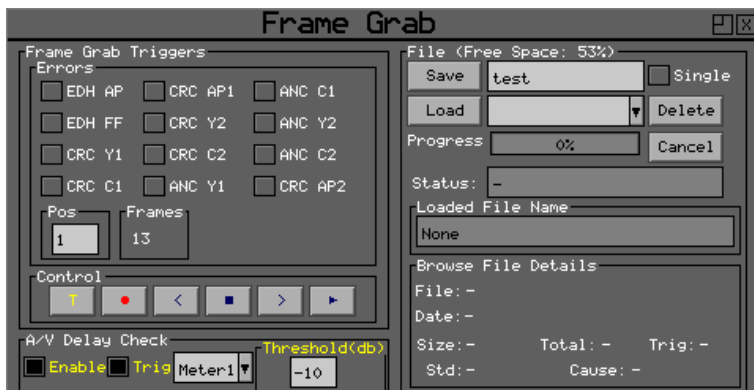

Selecting the arrow box to the right of the Grab check box in the Picture menu will display the Frame Grab Setup menu.

Within the Setup menu, the Frame Grab Triggers section allows the events that trigger the video clip capture to be selected.

EDH AP – will trigger when the SD-SDI Error Data Handling Active Picture flag status changes.

EDH FF - will trigger when the SD-SDI Error Data Handling Full Field flag status changes.

CRC Y1 – will trigger when the cyclic redundancy check for link 1 luminance data is set.

CRC C1 – will trigger when the cyclic redundancy check for link 1 chrominance data is set.

CRC Y2 – will trigger when the cyclic redundancy check for link 2 luminance data is set.

CRC C2 – will trigger when the cyclic redundancy check for link 2 chrominance data is set.

CRC AP1 – will trigger when the cyclic redundancy check for link 1 active picture changes.

CRC AP2 – will trigger when the cyclic redundancy check for link 2 active picture changes.

ANC Y1 – will trigger when the link 1 luminance ANC stream checksum error flag is set.

ANC C1 – will trigger when the link 1 chrominance ANC stream checksum error flag is set.

ANC Y2 – will trigger when the link 2 luminance ANC stream checksum error flag is set.

ANC C2 – will trigger when the link 2 chrominance ANC stream checksum error flag is set.

The Pos value is used to position the trigger point in the required position within the rolling record buffer to select the proportion of frames before and after the trigger point.

The Control section of the setup menu is a repeat of the transport controls available in the Picture instruments.

The File section of the setup menu allows the current video clip in the record buffer to be saved to the Rx file system (“\FCAP” folder) and allows previously saved video clips to be restored into the record buffer.

Save – saves the current video clip in the record buffer in the “\FCAP” folder use the name entered in the text box to the right of the “Save” button. The “Single” check box, if enabled, will cause on the current frame of the video clip to be saved.

Load – allows a previously saved video clip to be restored in to the record buffer. The drop down list box to the right of the “Load” buttons allows the required video clip to be selected. As video clips are selected in this list, their details will be displayed at the bottom of the menu.

Delete – allows the currently selected video clip in the drop down list to be deleted.

The current progress of the Save or Load operation is display in the Progress thermometer.

Note that video clips can be exported and imported using the USB copy menu.

Data View / Signal Data

The Rx Instrument with an Analyzer Module installed and SDI analysis option can display the selected input in the form of a data array.

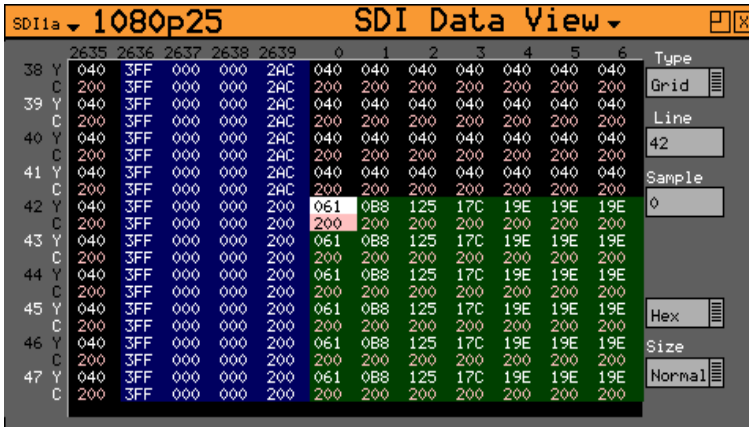

The SDI Data window is accessed by clicking on an Analyzer slot on the monitor output task bar and selecting "Data View". This will create a new window panel for the selected input.

This page shows the video signal as a data stream in several formats as described below. In each mode, the data may be displayed in hexadecimal, decimal or binary formats. In each mode, the data may be displayed in hexadecimal, decimal or binary formats. The binary format is not available in grid mode. The data may also be displayed as 10-bit or 8-bit format.



Note that the line number of a line of video changes at the end of active video. This gives the strange side effect that the line number for pixels in horizontal blanking is the same as the line number for the active picture after that line.

Type

Grid: In this mode the data is shown in an X-Y format with lines and samples at the same time. Thus this is a representation of the picture but in data format. If the cursor keys are used to select the grid window and 'OK' pressed, the cursor keys will scroll around the window. The luma (Y) channel is shown in white whilst the Cr and Cb channels are shown in with a red or blue tint respectively.

Strm: This is one of 3 modes for displaying the samples on the current line only. The cursor keys may be used to scroll the sample number when 'OK' has been pressed. The 'info' column shows the type of data being displayed.

- AP - Active picture
- VBL - Vertical blanking
- HBL - Horizontal blanking

Comp: This is a similar to the Strm mode above but in a component mode with Cr and Cb in different columns. See Strm mode above for the info column description.

Split: This mode shows the 2 streams split into 4 parts to show Y, Y', Cr and Cb in separate columns. See Strm mode above for the info column description.



Note that when in Colour modes other than YCbCr 422 10 bit, the pixel RGB or YCbCr values are packed into 10 bit values across the different streams and thus will give unfamiliar values. When the 'UnPack' check box is checked the values in the active picture are unpacked to RGB or YCbCr values.

Waveform Monitor

The Rx Instrument with an Analyzer Module installed can display the selected input in the form of a waveform monitor.

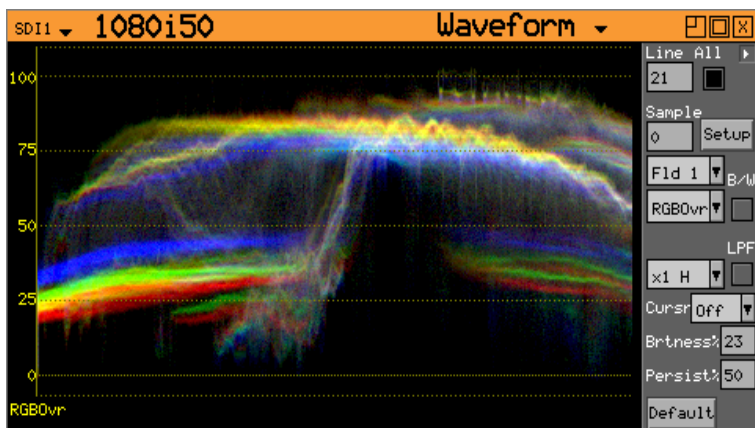

The Waveform window is accessed by clicking on an Analyzer slot on the monitor output task bar and selecting “Waveform”. This will create a new window panel for the selected input.

Selecting the white arrow in the top corner of the window will show/hide the menu controls.

Waveform Type

The waveform display format is set using the ‘Setup’ button. The waveform monitor displays the selected signal in one of the following formats as set by the Mode control:

YCbCr	The Y, Cr and Cb waveforms are shown as three separate waveforms in a Parade format
Y	Only the luminance channel is shown
Cb	Only the blue chroma channel is shown
Cr	Only the red chroma channel is shown
GBR	The Green, Blue and Red waveforms are shown as three separate waveforms in a Parade format
Red	Only the red channel is shown
Green	Only the blue chroma channel is shown
Blue	Only the red chroma channel is shown
RGBOvr	The Red, Green and Blue waveforms are shown overlaid on the same waveform
YCCOvr	The Luminance, Cr and Cb waveforms are shown overlaid on the same waveform.

Waveform Scale

The horizontal scale (x1 H) of the waveform (at 16th window size on the HDMI output) can be selected to view the left, right and centre areas of the waveform display.

The vertical scale (x1 V) of the waveform (at 16th window size on the HDMI output) can be selected to view the high, middle and low areas of the waveform display.

Cursors

Cursors are available on the Waveform monitor to measure amplitude and timing:

- Pict: The Picture cursor displays the currently selected cursor on the Picture window. If all is turned off this will automatically select the line and sample on the Waveform monitor.
- Time: The Time cursors allow the difference between two points (Cursor A and Cursor B) to be measured.
- Ampl: The Amplitude cursor allows the level between 2 different levels (Cursor C and Cursor D) to be measured.
- Both: This allows both the Amplitude and Time cursors to be selected at the same time.

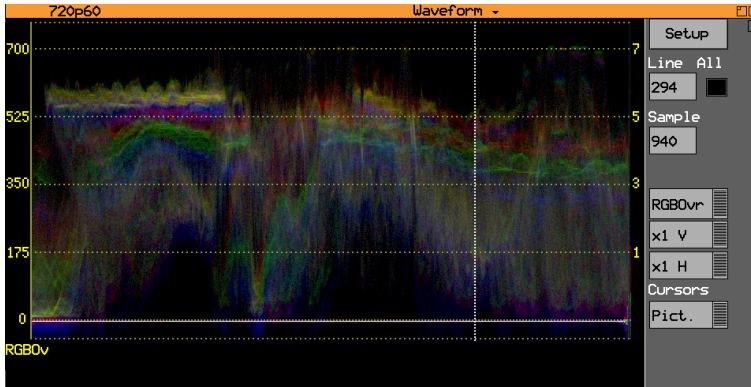

If the Waveform Pict (Picture) cursor is selected, then a vertical cursor will be also be displayed on the waveform at the corresponding pixel sample.

The Waveform monitor provides both amplitude cursors, to measure the amplitude of the waveform, and time cursors to measure the time between 2 selected points on the waveform.

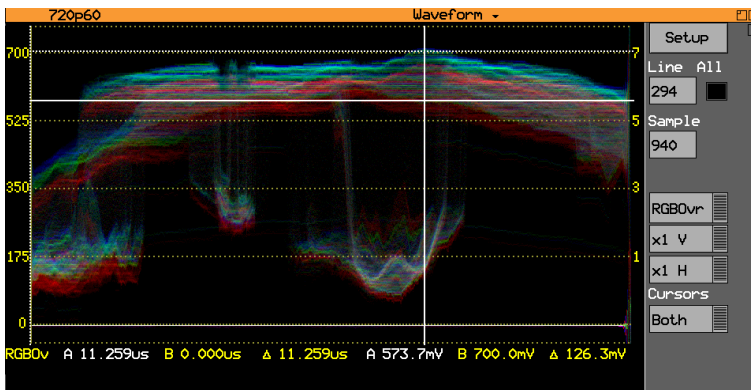

With the Time cursor selected, then clicking on the waveform will place a vertical cursor (Cursor A) on the waveform and the time (in pixels or microseconds) from the start of picture will be displayed. Clicking a second time in a different place on the waveform will place a second cursor (Cursor B).

The difference between the Cursor A and Cursor B will be displayed in pixels or microseconds. Clicking on the vertical dotted cursor and then clicking a different horizontal position will move the cursor there.

With the Ampl (Amplitude) cursor selected, then clicking on the waveform will place a horizontal cursor (Cursor C) on the waveform and the amplitude at that point will be displayed at the bottom of the waveform prefixed by "C" either as a percentage or in millivolts. Clicking on the horizontal dotted cursor and then clicking a different vertical position will move the cursor there.

All, Line and Sample

The display may be restricted to a single line or all lines may be displayed at the same time. The display can be formatted as all streams (Luma and Chroma) or just a single stream.

The streams may be in YCbCr or GBR formats. The line, sample and field controls all track the related controls on other pages.

The 'All' check box forces the waveform monitor to display all lines, overlaid on each other. Otherwise the specified line is displayed.

Setup Button Dialogue

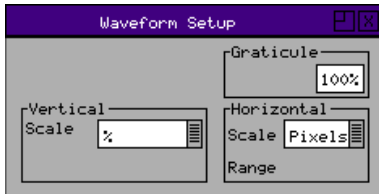

The Waveform Setup menu allows the vertical and horizontal scale of the waveform display to be setup.

- Graticule: The brightness of the display graticule can be adjusted between 100% (full brightness) and 0% (not displayed)
- Vertical Scale: The axes and measurements for the waveform monitor can be displayed either in percentages or in hex or decimal values as required.
- Horizontal Scale: The timing measurements may be set in either pixels or micro-seconds (us)

Vectorscope

The Rx Instrument with an Analyzer Module installed can display the selected input in the form of a vectorscope.

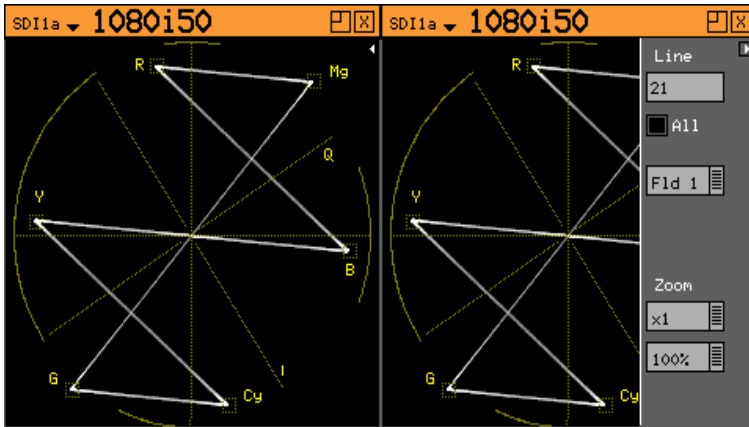

The Vectorscope window is accessed by clicking on an Analyzer slot on the monitor output task bar and selecting “Waveform”. This will create a new window panel for the selected input.

Selecting the white arrow in the top corner of the window will show/hide the menu controls.

The display graticule may be set to show either the 100% bar positions or 75% positions. The colour bar position boxes will change according to the colour space for the current input video standard.

- Line allows a specific video line to be displayed. This is useful when test patterns are transmitted as part of a programme on specific video lines.
- All the All check box forces the waveform monitor to display all lines, overlaid on each other. Otherwise the specified line is displayed.
- Field the Fld 1 and Fld 2 modes allow specific video fields to be displayed.
- Zoom allows the vector scope display to be zoomed-in to the Centre, Cyan, Yellow, Green, Magenta, Red or Blue positions at x1, x2, x5 or x10 magnifications.
- 100% / 75% selects the graticule scale to match the colour bars being analyzed.

Eye

Overview

The Rx Instrument with an Analyzer Eye Module installed can display the selected input in the form of an Eye Pattern. This allows the jitter of the selected input video signal to be monitored using an Eye Pattern display.

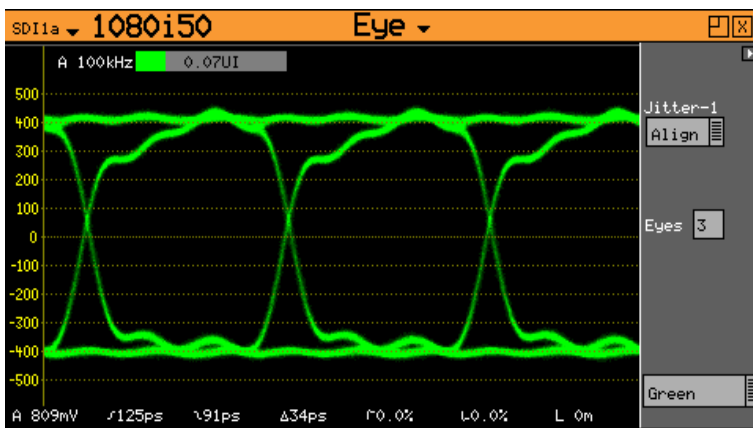

The Eye window is accessed by clicking on an Analyzer Eye slot on the monitor output task bar and selecting “Eye”. This will create a new window panel for the selected input.

Selecting the white arrow in the top corner of the window will show/hide the menu controls.

The name Eye Pattern is given to the measurement of SDI clock jitter display that forms the shape of an eye due to the 2 superimposed clock cycles. The ‘open eye’ is displayed when monitoring a jitter free SDI signal and the eye closes increasingly with the severity of the jitter.



The Eye Pattern is formed by sampling the SDI signal at specific points in a progressive manner and displaying each sample taken on a persistent screen until the waveform is complete.

Causes of Jitter

Jitter can be caused by a range of different things and the artefacts displayed in the Eye waveform are typically due to combinations of these at different frequencies and amplitudes:

- Transmission jitter caused by the equipment generating the video signal. This could include clock phase jitter, amplitude jitter and wander.

- Receiver phase lock loop errors in equipment decoding an SDI datastream. For example when video sources are switched and the circuitry of the equipment need time to establish phase lock or when the signal is distorted by long cable lengths.

- Data dependent jitter due to the actual data content that, even after randomisation, that contains sequences of zeros long enough for the clock regeneration to loose phase lock.

- Thermal and Shot Noise caused by the integrated circuits used within equipment. Integrated Circuits can contain 10s of thousands of discrete transistors that can all cause random errors, increasing in number as the temperature of the equipment rises.

- Electromagnetic interference in Long cable lengths that may be susceptible to interference from the power grid and from power switching.

- Distorted waveform shape, created by equipment, by long cable runs, by poorly terminated, un-equalised cables, poor cable frequency response of or poor return-loss.

Problems occur when these errors cause a level of jitter outside the specified acceptable parameters. The different types of jitter are classified as follows:

Timing Jitter	refers to a short-term time interval error above a low frequency threshold of 10 Hz (as defined in the SMPTE standards for SDI signals).
Alignment Jitter	refers to artefacts above the specified threshold frequencies of (1 kHz for SD-SDI signals and 100 kHz for HD-SDI signals). Typically video equipment cannot tolerate Alignment Jitter which cause decoding errors due to incorrect sampling of the data stream because the SDI Clock transition occurs on the edge of the data sample instead of in the centre of the data sample.
Wander	refers to a long-term time interval error, ie artefacts below 10 Hz. Typically all video equipment has the tendency to cause wander over a long period, the display of these artefacts are not easily displayed in a meaningful way but are better logged as errors that exceed tolerances over a long period.
Random Jitter	refers to artefacts caused by random events or processes such as thermal or shot noise that cause small amplitude variations in the clock edge position or could cause large signal amplitude variations, though these typically would be infrequent.



Note that if an Rx Generator modules is being used as the test pattern generator then the System Reference should be set to Free Run to avoid the introduction of jitter caused by the Rx locking circuitry.

Eye Display

The “Eye and Jitter” display shows the Eye Pattern against a vertical graticule of +500mV to -500mV. Four horizontal cursor lines show the 100%, 80%, 20% and 0% measurement positions on the waveform. Along the bottom of the display are continuous automatic measurements for:

Amplitude – measured in mV

Rise time – measured in Pico seconds. The rise time measurement is specified as the time between the 20% and 80% points on the eye waveform.

Fall time - measured in Pico seconds. The fall time measurement is specified as the time between the 20% and 80% points on the eye waveform.

Rise/fall difference - measured in Pico seconds

Rising edge overshoot – measured as a percentage of the overall signal amplitude.

Falling edge overshoot – measured as a percentage of the overall signal amplitude.

Cable length – measured in Metres. The cable length display is only an approximate value with 10m resolution thus a 5m cable will be shown as 0m long. The cable type affects the length displayed which has been calibrated for Belden 1694A cables.

Any measurements which exceed the specification of the SDI signal are indicated in RED whilst valid parameters are displayed in WHITE.



Note that if jitter values are too large, the automated measurements cannot be made accurately and should NOT be relied on.

The eye display is only accurate when connected via a 1 m cable, if a longer cable is used the eye will begin to ‘close up’ and measurements will become harder to perform. Note that the eye display is of the signal pre-equaliser, the equalizer in a system being used to compensate for long cable lengths. There is no method for the Rx instrument to view the signal post-equaliser.

Jitter Filters

The “Jitter 1” filter allow the specific type of jitter to be applied to the waveform and the thermometers displays. The options are:

- Timing as determined by the SMPTE standard for the specific video standard (ie jitter above the 10 Hz threshold)
- Align as determined by the SMPTE standard for the specific video standard (ie jitter above 1 kHz threshold for SD-SDI signals and 100 kHz for HD-SDI signals)
- 10Hz jitter above a 10Hz threshold
- 100 Hz jitter above a 100Hz threshold
- 1KHz jitter above a 1KHz threshold
- 10KHz jitter above a 10KHz threshold
- 100KHz jitter above a 100KHz threshold

Jitter filter selection affects both the jitter thermometer and eye pattern displays. Timing and Alignment jitter filters are defined in the relevant SMPTE publication. The thermometer automatically calibrates to the specification of the video standard and chosen filter. When reading is in specification the thermometer bar is GREEN, when close to specification it is YELLOW, and when out of specification it's RED.

	3G-SDI (2.97Gbps)	HD-SDI (1.485Gbps)	SD-SDI (270Mbps)
Alignment Jitter	SD-SDI (270Mbps)	100 KHz high pass	1 KHz high pass
Alignment Jitter	10 Hz high pass	10 Hz high pass	10 Hz high pass
Upper limit	-3 dB at 9.5 MHz low pass	-3 dB at 4.75 MHz low pass	-3 dB at 0.86 MHz low pass

On screen horizontal cursors indicate where on the eye the rise time measurements are being made.

Please note that the Rx instrument takes a little time to stabilise when the SDI input standard changes.

Jitter Meter Ranges

	3G-SDI (2.97Gbps)	HD-SDI (1.485Gbps)	SD-SDI (270Mbps)
Alignment Full-Scale	0.52UI	0.34UI	0.34UI
Alignment (Red Threshold)	0.3UI	0.2UI	0.2UI
Alignment (Yellow Threshold)	0.2UI	0.14UI	0.14UI
Timing Full Scale	3.4UI	1.7UI	0.34UI
Timing (Red Threshold)	2UI	1 UI	0.2UI
Timing (Yellow Threshold)	1.4UI	0.7UI	0.14UI

Eye Colour The eye colour may be set to green or blue and may also be adjusted in gain to allow the eye display to show ‘hot spots’ where the majority of the signal data is found.

Advanced Jitter Analysis (Option)

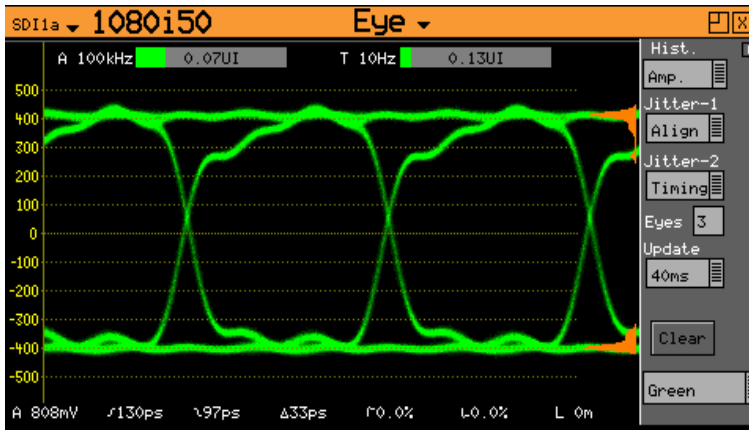

The Advanced Jitter Analysis option provides the user with additional tools on the Eye display to help determine the nature of jitter present in SDI signals.

Histogram: Amp/Timing/Both. Histograms enable the operator to observe the distribution of samples in both amplitude (Amp) and time (Time). The amplitude histogram shows the distribution of samples over the complete visible eye picture. The time histogram shows the distribution of samples at the zero point of the eye waveform for two thirds of the visible time period.

Note that the time histogram overlays some of the automatic measurement display. The measurements may still be read by Remote Control if purchased.

Jitter-2: This is a second jitter measurement thermometer and may be set to Timing, Align, 10Hz, 100Hz, 1KHz, 10KHz or 100KHz. This filter operates on just the right hand jitter thermometer. When in Timing or Alignment modes, the meter range is set to show appropriate ranges for the SMPTE specification at the current video input standard. When in other filter modes, the meter ranges are expanded so that larger ranges may be viewed.

Update: This allows selection of the update rate to allow longer display persistence. This may be set to 40ms (normal use) or infinite. When set to infinite, the Run and Clear buttons are enabled.

Run: This check box stops the display from updating so that a waveform may be investigated in more detail. It is only enabled when the update mode is set to infinite update mode.

Clear: This button clears the eye display. It is only enabled when the update mode is set to infinite update mode.

Eyes: Adjusts the number of eyes visible on the eye display. The 10 and 20 modes are useful for observing serial-parallel conversion jitter.

Jitter

The Rx Instrument with an Analyzer Eye Module installed and Advanced Jitter Analysis option can display the selected input in the form of an Jitter waveform.

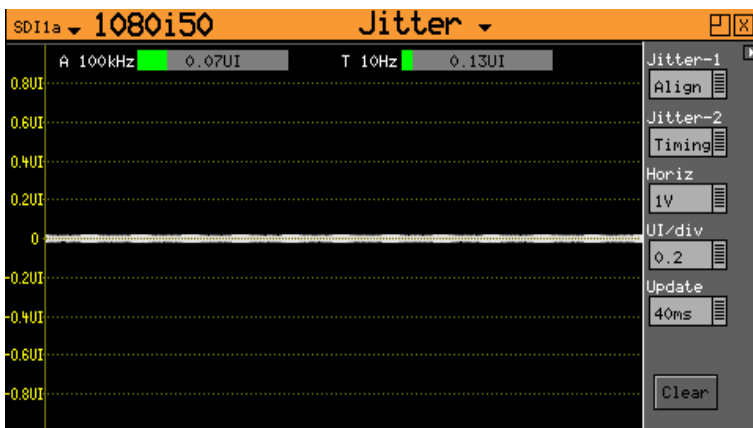

The Jitter window is accessed by clicking on an Analyzer Eye slot on the monitor output task bar and selecting “Jitter”. This will create a new window panel for the selected input.

Selecting the white arrow in the top corner of the window will show/hide the menu controls.

This screen shows a trace of jitter amplitude versus time along with two jitter thermometers and has the following controls:

- Jitter-1: Timing, Align, 10Hz, 100Hz, 1KHz, 10KHz or 100KHz. This filter operates on both the left hand jitter thermometer and the jitter trace.
- Jitter-2: Timing, Align, 10Hz, 100Hz, 1KHz, 10KHz or 100KHz. This filter operates on just the right hand jitter thermometer.
- Horiz: H, 2H, V or Frame – horizontal sweep control for jitter trace.
- UI/div: 0.1/0.2/0.5/1.0 – vertical gain control for the sweep trace.
- Update: This allows selection of the update rate to allow longer display persistence. This may be set to 40ms (normal use) or infinite. When set to infinite, the Run and Clear buttons are enabled.
- Run: This check box stops the display from updating so that a waveform may be investigated in more detail. It is only enabled when the update mode is set to infinite update mode.
- Clear: This button clears the eye display. It is only enabled when the update mode is set to infinite update mode.

Video Status

The Rx Instrument with an Analyzer Module installed can monitor the selected input and display any EDH (error detection and handling) or CRC (cyclic redundancy check) errors detected in the data stream.

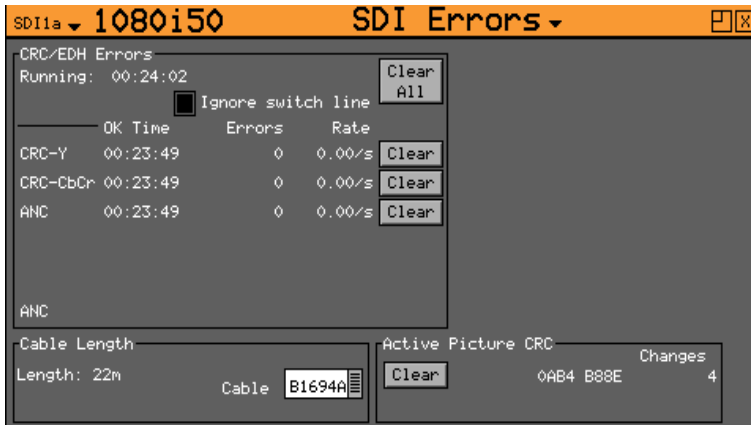

The Video Status window is accessed by clicking on an Analyzer slot on the monitor output task bar and selecting “SDI Errors”. This will create a new window panel for the selected input.

Selecting Video will display the EDH or CRC status of the analyzer input as appropriate for the video standard being monitored. The status of each EDH/ CRC count is displayed as the number of seconds since an error occurred.

EDH/CRC ERRORS

This displays the EDH or CRC status of the analyzer input as appropriate for the video standard being monitored. The status of each EDH/ CRC count is displayed as the number of seconds since an error occurred. The individual CRC fields may be reset individually or together. The ‘running time’ field shows the time since the last error reset occurred. The error rate field shows the number of errors per second. The running time will also be affected by the input being lost or being intermittent. CRC errors are ignored on the switching line if the ‘Ignore switch line’ check box is checked.

ANC checksum errors are also detected and counted and may be logged.

When analysing a 3G-Level B signal, the CRC status is displayed for each link or stream present according to the input video format. On an RX instrument with a Dual-Link module with 2 video inputs, only one 3G-Level B may be analysed for CRC status at a time.

EDH DATA

If the signal is SD (PAL-625 or NTSC-525) the EDH values for both active picture (AP) and full-field (FF) are displayed for each field. To enable engineers checking EDH integrity, the EDH values calculated for active picture and full-field are also displayed.

Under normal conditions, the EDH-AP values should be constant, the full-field values may change if audio or other ancillary data is embedded in the SDI signal.

The EDH flags for active picture, full-field and ancillary data are also displayed for diagnostic purposes.

Edh: Error Detected Here - This is set to 1 if a SDI error was detected. In the case of ancillary data, this means that one or more ANC data packets had an incorrect checksum.

Eda: Error Detected Already - This is set to 1 if a SDI error was detected in the signal received by the previous device.

Idh: Internal error Detected Here - This is set to 1 if a hardware error was detected in the previous device.

Ida: Internal error Detected Already - This is set to 1 if an idh flag was received by the previous device.

Ues: unknown error status: This is set to 1 if the previous device received an SDI signal from a device not supporting EDH.

Note that there is only one EDH detector which is connected to the input currently being analysed. On an Rx instrument with multiple video inputs, only the current input being analysed can check for EDH errors.

Cable Length

The Rx instrument measures the cable length connected to the SDI input BNC and the measurement is only an approximate value.

The cable type may be set to one of the following:

Belden 8282, 1694A, 1505, 1855A.

Canare L-5CFB

Image 1000

The selected cable type will affect the cable length measurement.

Active Picture CRC

16-bit CCITT CRCs are calculated for the active picture data of the received signal. This can be used to give a known value for known static picture content and allows the user to determine if the active picture content is as expected.

CRCs are calculated independently upon each 10-bit stream (luminance and chrominance) of the interface.

For example the generated 1920x1080, 100% bars in YCC422-10 should always produce a luminance CRC of 0x0AB4 and a chrominance CRC of 0xB88E, no matter what scanning mode (interlaced, segmented frame or progressive) or frame rate is used.



Note: when using 4:4:4, 4:4:4:4 or 12-bit video formats (in dual-link or 3Gbps) the CRCs are calculated for each of the packed 10-bit virtual interfaces and will therefore generate different values from those for YCC422-10.

See the “Active Picture CRC Technical Information” section at the end of the manual for details of CRC calculation.

Misc Status

The Rx Instrument with an Analyzer Module installed can monitor the selected input and display the content of any SMPTE 352 packets detected in the data stream.

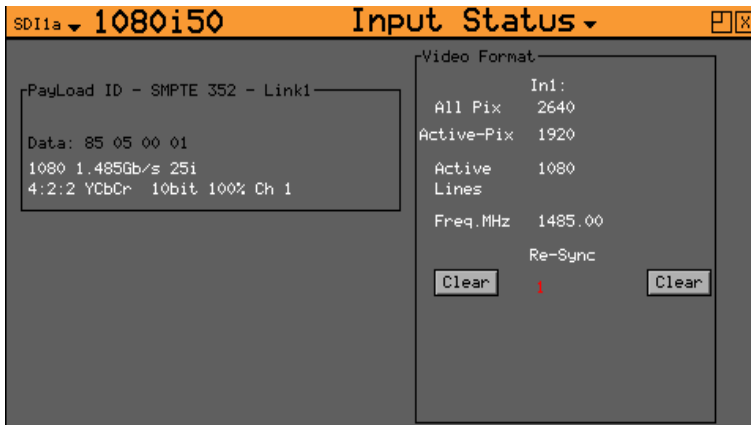

The Misc Status window is accessed by clicking on an Analyzer slot on the monitor output task bar and selecting “Input Status”. This will create a new window panel for the selected input.

Payload ID – SMPTE 352

If the Rx instrument has detected a SMPTE 352 ancillary packet, it will be displayed here in hex and decoded format.

The display shows the transport media, frame rate and interlaced/progressive/segmented frame mode, as well as colour format, bit depth, dynamic range and channel number. See the SMPTE 352 specification for further details.

When analysing a 3G-Level B signal, the SMPTE 352 status is displayed for each link or stream present according to the input video format. On an RX instrument with Dual-Link with 2 video inputs, only one 3G-Level B may be analysed for 352 status at a time.

Video Format

This displays the currently detected line length for both active video and full line including blanking as well as the number of active lines for the inputs present.



Note that the video frequency displayed is only correct if the Rx instrument has been calibrated and free running or has been connected to an accurate reference input.

If the input signal is not a known signal (i.e. the line count or pixel count is not recognised) The input status on the top line will show “Invalid” but the values in this section will be updated every few seconds.

The Re-sync counter displays the number of times the SDI data has been re-synchronised and can help detect intermittent SDI signal problems.

Video Timing

The Rx Instrument with an Analyzer Module installed can monitor the selected input and display its timing relationship with the locking reference.

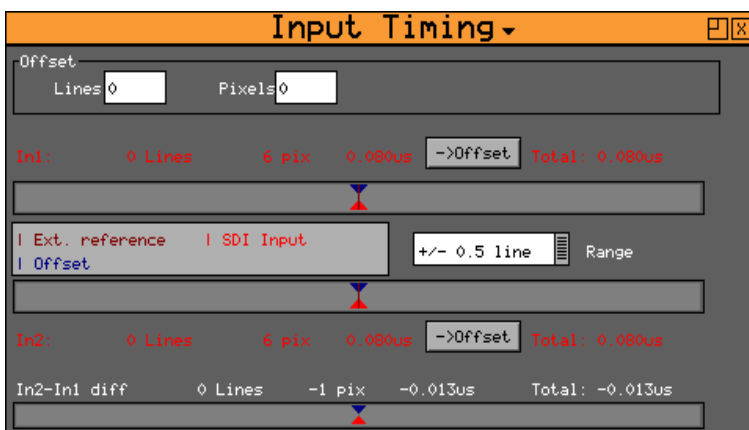

The Input Timing window is accessed by clicking on an Analyzer slot on the monitor output task bar and selecting "Input Timing". This will create a new window panel for the selected input.

The timing of SDI input signals is displayed relative to the external reference. If no reference is present then an error message is displayed. If the signal is timed to within +/- 2 samples the values are displayed in black in lines and samples (spl) If mistimed, then they will be displayed in red. A bar graph also displays the timing value which may either be line timing (+/- 0.1 lines or +/- 0.5 lines) or frame timing (+/- 0.5 frame). The total timing value is also displayed in micro seconds.

The RED arrow on the bar shows the SDI input timing and the BLUE arrow shows the current target timing point. The BROWN line shows the timing of the reference signal.

To compare timings of different signals, connect the signal to be compared to the SDI input and select the "Offset" button to make this the current offset. All future timings will be relative to this offset value.

To clear the current offset, move the focus to the 2 offset fields, press OK to edit them and then press default.



Note that all timing measurements are relative to line 1 on the SDI signal and line 1 on the reference signal. This can lead to different values to other test and measurement instruments that include an SD (PAL/NTSC) offset in their calculations. By comparing line 1 timings, the Rx instrument can be used to accurately measure time delays through up/down/cross converters.

ANC Status (SDI Analysis Option)

The Rx Instrument with an Analyzer Module installed and SDI analysis option can monitor the selected input and display details of any Ancillary packets within the SDI data stream.

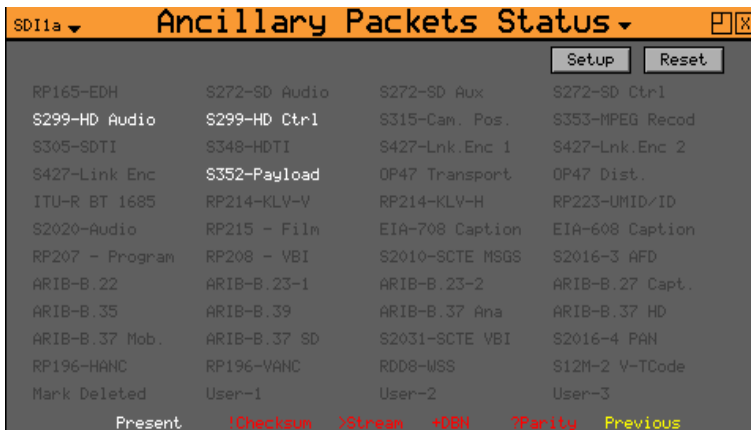

The Ancillary Packet Status window is accessed by clicking on an Analyzer slot on the monitor output task bar and selecting “ANC Status”. This will create a new window panel for the selected input.

The ANC status menu shows which ANC packets are present on the SDI input and whether they have any errors.

Each field is colour coded according to whether the ANC packet is present (White), missing (Grey), has errors (Red), or has previously had errors (yellow).

If the field has errors then a symbol beside the field shows which error type it is. The bottom of the page shows the symbol for each type of error. The Reset button resets the “Previous Errors” state.

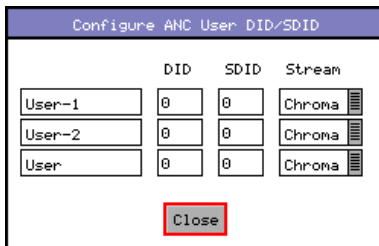

The Setup button and dialog allows user defined ANC packets to be configured.

The packet name, data ID (DID) and SDID may be specified for up to 3 user-defined ancillary packets. The stream field specifies whether the packet should be on the chroma stream, the luminance stream or both.

The data packets that can be trapped by the ANC Status are as follows:

- RP165-EDH** this is the SMPTE RP165-EDH packet containing EDH (error data handling) and CRC (cyclic redundancy counts). This only appears on SD-SDI signals.
- S272-SD Audio** this is the SMPTE 291M defined SD audio data in HANC space.
- S272-SD Aux** this is the SMPTE 291M defined SD auxiliary data in HANC space.
- S272-SD Ctrl** this is the SMPTE 291M defined SD control data in HANC space.
- S299-HD Audio** this is the SMPTE 291M defined HD audio data in HANC space.
- S299-HD Ctrl** this is the SMPTE 291M defined HD control data in HANC space.
- S315-Cam. Pos** this is the SMPTE 291M defined camera position data in HANC and VANC space.
- S353-MPEG Recod** this is the SMPTE 291M defined MPEG recoding data in HANC and VANC space.

S305-SDTI	this is the SMPTE 291M defined SDTI transport data packet in active frame space.
S348-HDTI	this is the SMPTE 291M defined HD-SDTI transport in active frame space.
S427-Lnk. Enc 1	this is the SMPTE S427 defined link encryption data packet.
S427-Lnk. Enc 2	this is the SMPTE S427 defined link encryption data packet.
S427-Link Enc	this is the SMPTE S427 defined link encryption data packet.
S352-Payload	this is the SMPTE 291M defined Payload Identification data packet in VANC space.
OP47 Transport	this is the Free TV Operational Practice OP-47 defined transport of Closed Caption/Subtitling data in the VANC space.
OP47 Dist.	this is the Free TV Operational Practice OP-47 defined distribution of Closed Caption/Subtitling data in the VANC space.
ITU-R BT 1685	this is the ITU-R BT 1685 defined Structure of inter-station control data packets.
RP214-KLV-V	this is the SMPTE defined KLV Metadata transport in VANC space.
RP214-KLV-H	this is the SMPTE defined KLV Metadata transport in HANC space.
RP233-UMID/ID	this is the SMPTE defined UMID (Unique Material Identifier) in VANC space
S2020-Audio	this is the SMPTE S2020 defined standardized data packet defining the encoding for a Dolby stereo or a multi-channel surround group of audio channels.
RP215 – Film	this is the SMPTE defined recommended practice data packe for film codes in VANC space.
EIA-708 Caption	this is the EIA standard defined closed caption data for HD-SDI in VANC space.
EIA-608 Caption	this is the EIA standard defined closed caption data for SD SDI 525i (NTSC) in VANC space.
RP207 Program	this is the SMPTE RP207 defined program description data packet in VANC space.
RP208 – VBI	this is the SMPTE defined recommended practice VBI Data (vertical blanking interval data) in VANC space.
S2010-SCTE MSGS	this is the SMPTE S2010 defined standardized API message data in VANC space.
S2016-3 AFD	this is the SMPTE S2016 defined standardized AFD (active format description) and Bar data packet (defining active area of image).
ARIB-B.22	this is the ARIB defined Sub information data packet in the VANC space.
ARIB-B.23-1	this is the ARIB defined user data 1 packet in the VANC space.
ARIB-B.23-2	this is the ARIB defined user data 2 packet in the VANC space.
ARIB-B.27 Capt.	this is the ARIB defined caption data in the VANC space.

ARIB-B.35	this is the ARIB defined trigger signal data packet for data broadcasting.
ARIB-B.39	this is the ARIB defined inter-stationary control data packet in the VANC space.
ARIB-B.37	this is the ARIB defined analogue signal data in the VANC space.
ARIB-B.37 HD	this is the ARIB defined HD data packet in the VANC space.
ARIB-B.37 Mob	this is the ARIB defined closed captioning information data packet.
ARIB-B.37 SD	this is the ARIB defined SD data packet in the VANC space.
S2031-SCTE VBI	this is the SCTE S2031 standard defined VBI (vertical blanking interval) data packet for closed captioning.
S2016-4 PAN	this is the SCTE S2016 standard defined pan and scan data packet.
RP196-HANC	this is the SMPTE defined recommended practice Time Code data packet in HANC space.
RP196-VANC	this is the SMPTE defined recommended practice Vertical Timecode data packet in VANC space.
RDD8-WSS	this is the SMPTE defined wide screen switching data packet in the VANC space.
S12M-2 V-Tcode	this is the SMPTE S12M defined standardized frame timecode data packet in VANC space.
Mark Deleted	this is a user defined data packet used to mark other data packets for deletion (ie to be ignored by down-stream processes).
User-1	this is a user defined data packet.
User-2	this is a user defined data packet.
User-3	this is a user defined data packet.

ANC Inspector (SDI Analysis Option)

The Rx Instrument with an Analyzer Module installed and SDI analysis option can monitor the selected input and display the contents of selected Ancillary packets within the SDI data.

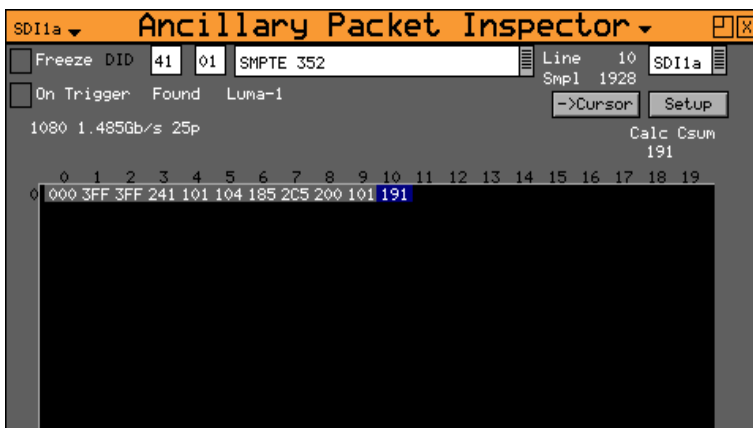

The Ancillary Inspector window is accessed by clicking on an Analyzer slot on the monitor output task bar and selecting “ANC Inspector”. This will create a new window panel for the selected input.

The packet type can be selected using either the drop down list of known packets or the DID/SDID (Data Identifier/ Secondary Data Identifier) number fields (for example RP165 – EDH, S272 – SD Audio Group 1, S272 – SD Audio Group 2, etc). If the DID/SDID values match a known type, then that type will be selected in the drop down list. This may be further filtered using the Check Boxes on the Setup dialogue.

Note that the settings of the Setup dialogue affect the currently displayed data. For example if any trigger parameters (such as DID or SubDID set to specific values that don't actually appear in the data) are set this may prevent data being displayed.

When searching for specific data events it is advisable to turn off the Trigger parameters such as “DID”, “SubDID”, “Checksum”, “DBN” (Data Block Number), “Parity” and “ANC Gaps” first to ensure that you are actually seeing data for the selected ANC packet. Only when the ANC Inspector is displaying streaming data, should you introduce the specific trigger parameters required to trap the data packet that you are looking for.

The Line and sample number of the detected packet is displayed to facilitate debugging of generation equipment. The complete data packet is displayed as a hexadecimal grid at the bottom of the page and may also be decoded into text above the grid.

If an error occurs in the packet, the header and checksum are displayed in red.

The display of data may be frozen by pressing the Freeze check box.

The ‘Found’ description shows in which stream the ANC packet was detected, Chroma or Luma and what kind of trigger was detected. This may be:

- C Checksum Error
- D DBN (Data block number) Error
- P Parity Error
- G ANC Gap error

Several of the above flags may be displayed at the same time.

The ANC packets detected may be filtered using the Setup dialogue. This allows a great deal of freedom in setting when the display will be triggered.

If the On Trigger check box is checked the data packet will cause the display to be frozen and the Freeze check box will turn red when a trigger condition is met. See the section on the ANC Inspector setup dialogue below. Un-checking the freeze button will restore normal operation.

The “->Cursor” button will copy the Line and Sample numbers to the SDI data view cursors to simplify navigation to the ANC packet under investigation.

ANC Inspector Setup

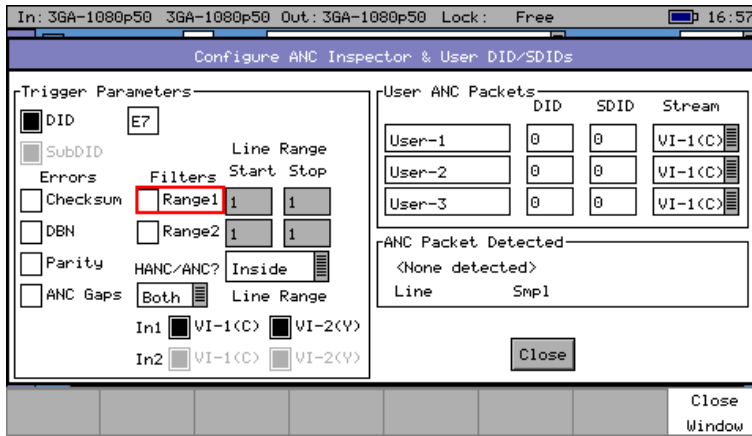

If the Setup button is pressed a dialogue box is shown to allow the ANC packet trigger parameters to be set. The trigger parameters allow only selected lines to be checked or excluded when checking for the presence of packets.

Line Range Filter If either of the Line Range Filter check boxes are checked then the range of lines that the ANC inspector will check is limited to that range. If the Selection below the range is set to "Inside" then it will only check ANC packets inside the range (including the start and end lines). If it is set to "Outside" then it will only check ANC packets outside the specified range.

HANC/VANC Filter This is another filter for simpler selection of where to search for packets. It may be selected to search the HANC (Horizontal Ancillary Data) area, the VANC (Vertical Ancillary Data) area or both areas.

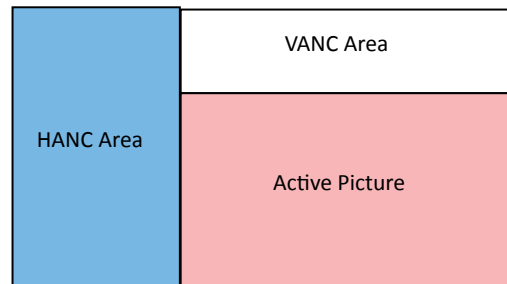

Error Triggers

If any of the "Errors" check boxes are checked, then the ANC packet data will only be displayed if an error occurs. The error states detected are:

- Checksum:** A checksum error in a packet was detected. ie Sum of data between DID and final UDW (User Data Words).
- DBN:** A Data Block number error was detected in an audio packet. The DBN field (in the same place as the SDID) of an audio packet should either be 0 and never change OR increment from 1...255 and then start at 1 again.
- Parity:** A parity error was detected for the DID, SDID and DataCount words in a packet. (Even Parity used and bit 9 is inverse of bit 8)
- ANC Gaps** The ANC packets were separated by a gap containing video blanking data. EDH (DID = 0xf4) packets are ignored. Note that if an EDH packet is marked for deletion, this will result in an ANC GAP error.

The Setup dialogue also shows when an ANC packet has been detected and where it was found. This makes changing a filter simpler as the effect of the filter can be determined without closing the dialogue.

This dialogue also allows the user defined ANC packets to be configured.

SFP Information

SFP Information					
SFP Type	OPT Tx+Rx	Tx Power	0.6449mW	Rx Power	0.0001mW
Temp	64.30 C				
ID	85h	Ext. ID	04h	Connector	07h
StdsCompl	41h	TxRxCod-1	00000000h	TxRxCod-2	00000003h
Encoding	03h	NonBitRate	3000Mbps	Len 9um	30000m
Len 50um	0m	Len 62.5um	0m	Len Copper	0m
Vendor	GENNUM	Vendor OUI	00h	Part Code	G02929-31C7
Vendor Rev	00h	Wavelength	1310	CC Base	6ah
Options	1ah	UprBitRate	5%	LwrBitRate	95%
SerialNo	Z112308MJ	MfgDateCod	110622	CC Ext	47h
Res-13	00h	Res-19	00h	Res-36	00h
Res-62	00h	Res-92-94	68f00547h		

The SFP Info menu displays details of the currently installed SFP module.

Along with the manufacturer's details of the SFP's parameters, this displays the transmitted and received power which can indicate optical losses in the infrastructure (optical fibre type, distance and connection quality)

Audio Meters

The Rx Instrument with an Analyzer Module installed can monitor the selected input audio and graphically display the audio level for each audio channel.

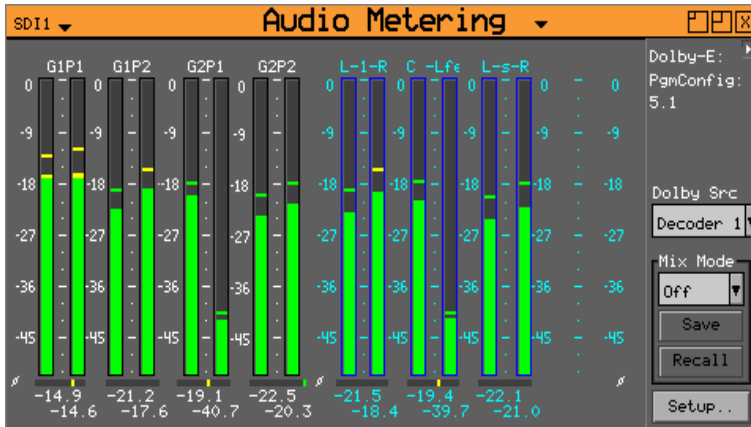

The Audio Metering window is accessed by clicking on an Analyzer slot on the monitor output task bar and selecting "Audio Meters". This will create a new window panel for the selected input.

Note that where the Meters are displaying Dolby encoded audio data this will be labelled.

This window shows up to 16 audio channels. The source for each meter pair may be independently set to allow simultaneous metering of 8 different meter pairs associate to the Analyser or all 16 channels in an embedded SDI stream. This is selected using the Setup menu at the right of the window.

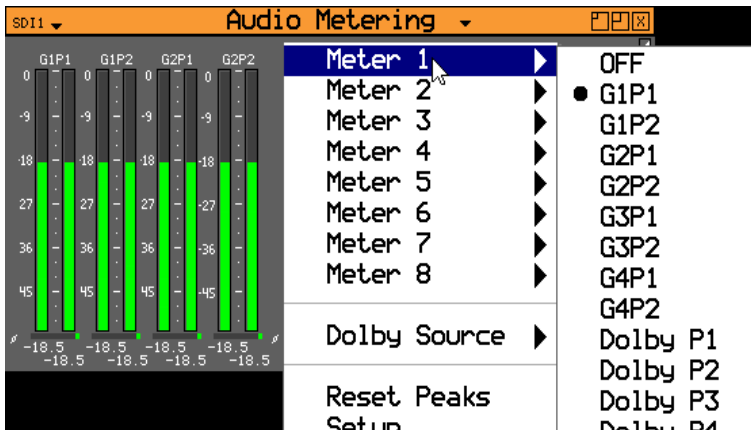

Right-clicking on the individual meters or on the window will display context sensitive menus that can be used to control the functions of these instruments.

Audio Phase Meters

At the bottom of each pair of audio PPMs are displayed the signal amplitudes and the stereo pair phase meters.

If the phase indicator is green and aligned to the right then the stereo pair is fully in phase. ie the signal on both left and right are exactly the same which only normally occurs when a mono signal is on both channels.

If the phase indicator is yellow and aligned in the centre this indicates that the stereo pair is 'in phase'. ie the normal position for a stereo pair.

If the phase indicator is red and aligned to the left then the stereo pair is fully out of phase. ie the signal on the left and right channels are 180 degrees out of phase.

Meter Setup

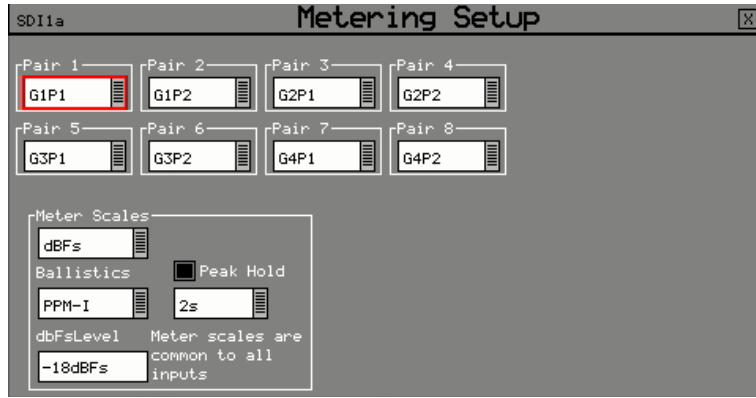

The source for each pair of audio meters can be selected from the drop down lists for each pair. These choice can be SDI embedded audio channels, AES audio pairs or decoded Dolby audio channels.

The scale and peak program meter ballistics can also be selected from the drop down menus.

The scale used by the meters may be set to -18dB, -20dB, BBC, BBCM, DIN45406 or NordicN9 according to the standard operating level used. The graticule and audio levels displayed will change to match the selected scale. The meters ballistics can be set to:

PPM I - emulating the performance of IEC 60268-10 Type I PPM style audio meters typically used by German broadcasters.

PPM II - emulating the performance of IEC 60268-10 Type II PPM style audio meters typically used by UK broadcasters.

Vu - emulating the performance of IEC 60268-17 style audio meters typically used by American and Australian broadcasters.

Vu-Fr - emulating the performance of ITU-R Rec. BS.645 style audio meters typically used by French broadcasters.

Fast - displaying the meters without any ballistics applied. Primarily for automated measurement purposes where readings can be taken without waiting for levels to settle.

These settings affect the response of the meter display to dynamic changes in audio level.

The peak hold bars can be displayed if the check box is selected and the decay time can be setup using the drop down list. The scale and peak program meter ballistics can also be selected from the drop down menus.

Audio Mix Mode

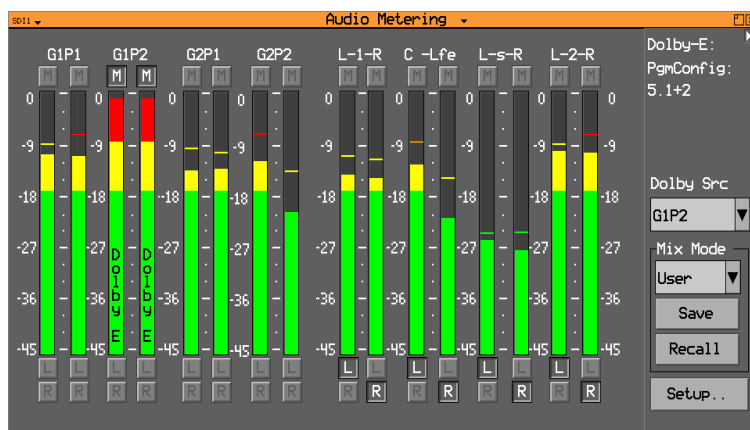

The Mix Mode function allows selected channels to be assigned to the left and right channels of the Audio Monitoring output when “Analyser” - “Downmix” is selected.

The drop down menu allows Mix Mode to be set to User defined, 5.1A or 5.1B to use mappings defined in the System - Surround Channel Setup

The Mix Mode channel mappings can be saved as an audio preset using the “Save” button and recalled using the front panel preset controls.

4AES Module

The Rx Instrument with an 4AES Module installed can monitor the selected AES input audio pairs and graphically display the audio level for up to 4 pairs of AES audio channels.

Dolby Metadata Analysis

If the metadata Dolby analyzer option is installed, selecting Metadata from the drop down list on the meter window will display the encoded Dolby metadata levels for up to 8 Dolby channels within the specified embedded audio pair or AES input.

If AES inputs are present then these may also be metered. At the bottom of each meter is the current audio level for that channel in dBFs (decibels relative to 0dB full-scale).



Note that Dolby audio cannot be heard on the speaker if the Dolby Decoder module is not present.

Dolby Decoder module

If the Dolby Decoder module is installed, the levels of the decoded baseband audio channel pairs can be monitored using the Audio Meters. To do this “Dolby P1”, “Dolby P2”, “Dolby P3”, etc needs to be selected using the Setup menu.

The Decoder 1 and Decoder 2 selections from the drop down list on the meter window will display the levels for the decoded Dolby audio channels. With Decoder 1 or 2 selected the meter display will turn blue to indicate that decoded Dolby audio is in use and channels can be selected as part of a down mix.

SDI Audio Status

The Rx Instrument with an Analyzer Module installed can monitor the selected input audio and detail its audio encoding details.

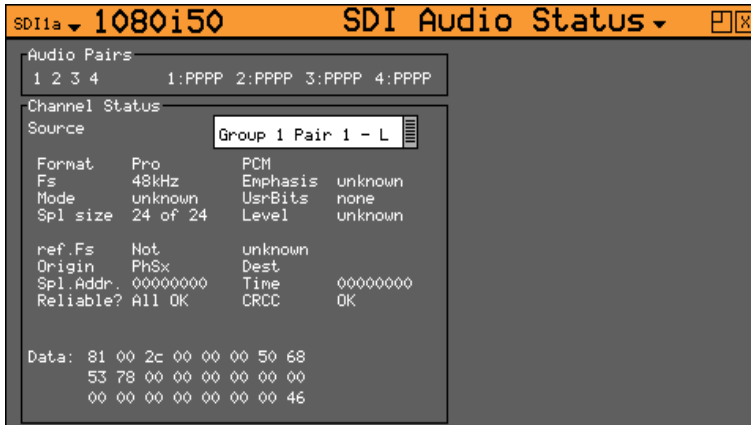

The SDI Audio Status window is accessed by clicking on an Analyzer slot on the monitor output task bar and selecting "Audio Status". This will create a new window panel for the selected input.

The Audio Status menu shows the Channel Status for the selected audio channel is displayed in decoded form as well as a hexadeciml dump of the bytes.

Lissajous

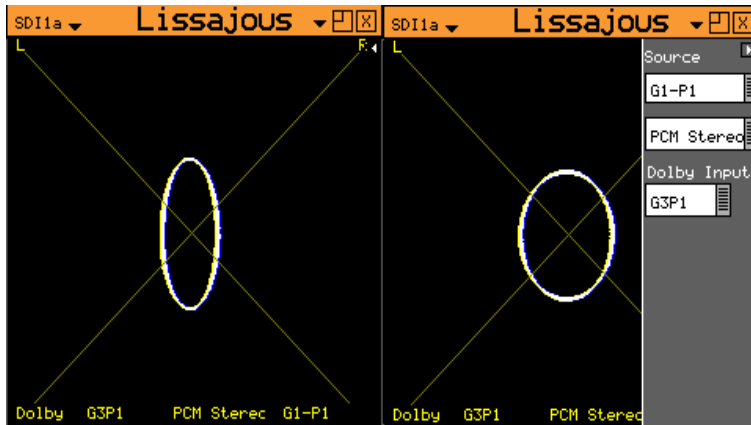

The Lissajous window is accessed by clicking on an Analyzer slot on the monitor output task bar and selecting "Lissajous". This will create a new window panel for the selected input.

Selecting the white arrow in the top corner of the window will show/hide the menu controls.

The stereo audio pair to be monitored can be selected from the drop down list.

If a Dolby Decoder module is installed then a mixed-down version of the decoded Dolby digital audio channels can be displayed.

Loudness Meters

The tools provided in the “Loudness” window allow the loudness of the selected source stereo audio pair, 5.1 surround sound audio group or decoded Dolby program (from the Dolby Decoder module) to be monitored and measured. The Rx system provides a single Loudness meter as standard and an additional 3 Loudness meters are available as an option and allocated as 1 loudness channel per analyser module. The Loudness meters are access via the Analyser module menu on the HDMI® monitor output.

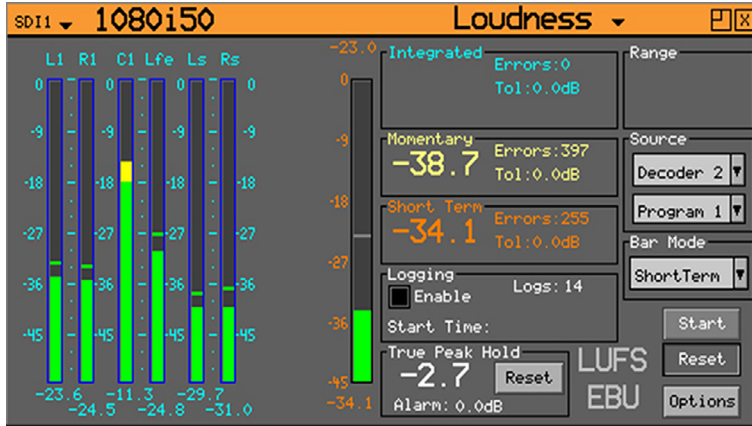

Loudness is measured in accordance with ITU 1770 and EBU Recommendation 128 which define the measurement in terms of Loudness Units (LU), Loudness Units Full Scale (LUFS), Loudness K-weighted Full Scale (LKFS) over different time periods.

The Loudness display allows the required mode (Integrated, Momentary or Short Term), input (SDI, Fibre or AES) and (in the case of a Dolby Decoder audio source,) Dolby program to be selected.

The left hand part of the window displays the actual audio values of the select audio channels numerically and graphically. The right hand part of the window provides the current Integrated, Momentary and Short Term loudness values, a loudness bar graphically displaying the selected loudness mode value, input and source selection and loudness logging controls.

The right hand part of the window also provides a True Peak Hold indicator showing the highest perceived loudness level measured. The value will be displayed in red if it exceeds the True Peak Alarm threshold level shown. The Alarm level is configurable in “Options”. The True Peak Hold indicator can be reset.

Loudness Logging

If the “Enable” check box is selected in the “Logging” section, the system will log loudness continuously and save CSV files every 30 minutes.

As defined in the EBU Recommendation 128, the loudness meter provides the following functions:

Start - starts the integrated loudness measurement.

Pause - pauses the current integrated loudness logging process. Re-selecting this button will resume the loudness logging process from the point where it was paused.

Reset clears the current Infinitely integrated loudness session.

Loudness logs are stored automatically each time the pre-set duration is reached. The duration can be defined in the “Export Time” setting found in “Options”, to be between 1 minute and 3 hours long; although 30 minute intervals are more practical. These logs will be individual, time-stamped CSV (comma separated value) files which are held in the “loudness” folder within the Rx operating system (See the “Rx File Structure” section in the “Maintenance” chapter for details).

Log files can be saved manually at any time by selecting the “Save” button in the “Loudness Options” window; which can be accessed by selecting the “Options” button. Selecting the “Save Name” text box will bring-up an on-screen keyboard to allow the CSV file to be named

appropriately. These logs can be copied onto a USB pen drive if it inserted in to the front panel and selected using from the loudness folder.

Mode

The loudness is measured simultaneously with three different time periods:

- M (momentary) covering the shortest timescale of 400ms
- S (short term) covering the intermediate timescale of 3 seconds
- I (integrated) covering the duration of a program or segment

The M, S and I values are displayed for the selected audio pair or 5.1 surround sound audio channels.

Input and Source

The SDI input with the embedded audio channels to be monitored is selected using the “Input” drop-down list. The audio channels within the selected input are then selectable from the “Source” drop-down list. The loudness meter can display and log the loudness of stereo pairs (for example “G1-P1”), 5.1 surround sound audio channels.

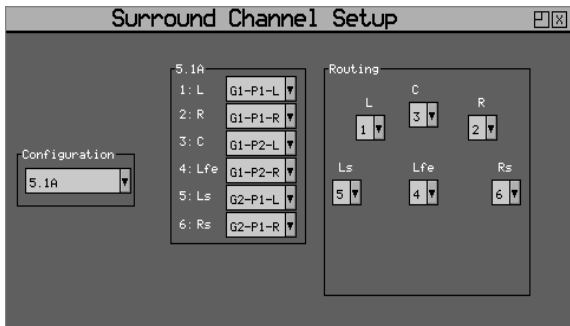

Note that the channel mapping for the 5.1 surround sound channels is defined in the “System” - “Surround Channel Setup” window.

This allows the individual audio channels from the selected SDI input(s) to be mapped to the L (left), R (right), C (centre), Lfe (low frequency effects), Ls (left surround), Rs (right surround), Bsl (back surround left) and Bsr (back surround right)

Options



The Options menu allows the selection of meter scale (LU, LUFS or LKFS), measurement standard (EBU or ITU) and Meter Range as well as user-defined threshold values for Integrated, Momentary and Short Term loudness.

This menu also allows the manual or automatic deletion of Loudness logs

The mode drop down allows the selection of the displayed scale of LU (Loudness Unit), LUFS (Loudness Unit Full Scale) or LKFS (Loudness K-weighted Full Scale). These affect the loudness values measured. Note that LUFS and LKFS have a -23 dB weighting to standardise broadcast loudness measurement and prevent digital clipping. So if a -23 dB test tone is measured it will give 0 LUFS or 0 LKFS.

The Standard drop down menu allows the EBU RP128 or ITU 1770 loudness measurement standard to be selected. These affect the loudness values measured.

The Audio and dBFS drop downs in the Scales section allows the scales of the audio channel meters to be selected. The actual scale of the Loudness meter is defined by the loudness mode selection.

The “Integrated” (Infinity), “Momentary” and “Short Term” target values define the level, above which, a loudness error is logged as exceeding the defined upper limits. The errors count is displayed on the Loudness window. If Targets - Enable is selected in the “Local Options” section, cursors will be displayed on the meter bar and the loudness values will flash red when the target level is exceeded. The dB values next to the “Integrated” (Infinity), “Momentary” and “Short Term” values allow a guard band to be set above the target value.

In the “True Peak” section, the True Peak Alarm threshold can be set.

Selecting the OK button will save the current changes and the Cancel button will discard any changes made.

Loudness logs that have been manually or automatically saved can be deleted manually using the Delete and Delete all buttons. When continuously logging program loudness, the Auto Delete function can be used to delete log files older than 1 to 10 days. To narrow down the search when looking for existing log files, enable the Filter check box and then enter file name text in the Filter text box.

Confidence Check

These different measure modes can give unpredictable results dependent on the type of program and the combination of narrative, music and loud audio events such as explosions. The actual values measured are also affected by the meter scale.

As a simple confidence check, use a stereo sine wave, 1000 Hz, -23.0 dBFS (per-channel peak level), in phase as the test tone applied to both channels simultaneously for 20 second duration. This should give the following results:

$$M, S, I = -23.0 \pm 0.1 \text{ LUFS} \text{ or } M, S, I = 0.0 \pm 0.1 \text{ LU}$$

Dolby Meta-data (Dolby Analyzer Option)

The Rx Instrument with an Analyzer Module installed and Dolby Analyzer Option can monitor the selected input audio and provide details of its Dolby E , Dolby Digital or Dolby Digital Plus audio encoding.

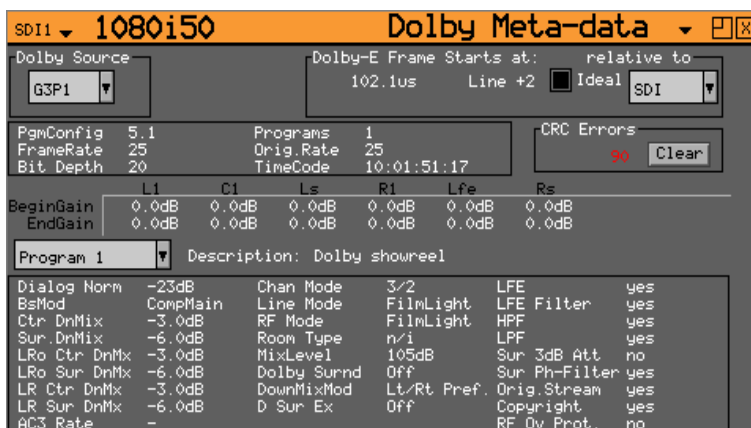

The Dolby Meta-data window is accessed by clicking on an Analyzer slot on the monitor output task bar and selecting “Dolby MetaData”. This will create a new window panel for the selected input.

The Dolby Metadata window allows display of the Dolby metadata present in the selected audio stream.

This window also allows the correct timing of the Dolby E packets within the SDI signal to be checked at all stages in a broadcast chain. Checks can be made to see that the Dolby E has been created correctly and transferred transparently through the broadcast chain unaffected by routers/switchers, satellite links, etc.

Overview

Dolby E, Dolby Digital and Dolby Digital Plus digital audio standards can be transported as audio data over an SMPTE 337M AES carrier with a 48kHz sample rate.

These standards can be used to transport mono, stereo, 5.1 and 7.1 audio programmes:

Dolby 5.1 - involves five channels for normal-range speakers (20 Hz – 20,000 Hz) (right front, centre, left front, rear right, rear left) and one channel (20 Hz – 120 Hz allotted audio) for the subwoofer driven low-frequency effects.

Dolby E

Dolby E is a production audio encoding and decoding technology developed by Dolby Laboratories that allows up to 8 channels of audio (mono, stereo, 5.1 or 7.1) that for a primary programme (Programme 1) and optional ancillary programs. These 8 channels are compressed (low loss) into a digital stream that can be transferred between compatible devices and stored on a standard stereo pair of audio tracks.

This format is video frame based and allows switching a further processing/compression.

Dolby Digital

Dolby Digital (AC-3) is a ‘perceptual audio’ system for digital audio that allows the reduction of data needs to deliver high-quality sound. This system was developed primarily for DTV, DVD and HDTV. This format allow up to six channels of sound (mono, stereo or 5.1) in the form of a single ‘program’ that can be delivered at different bit rates. These 6 channels are compressed (lossy) into a digital stream that can be broadcast. The most elaborate mode in common use is Dolby 5.1 with uses all six channels to provide surround sound.

Dolby Digital Plus

Dolby Digital Plus (E-AC-3) is a more advanced version of Dolby Digital that provides a more efficient encoding algorithm that provide enough bandwidth that allows up to 20 channels of audio (mono, stereo, 5.1, 7.1 up to 13.1) that for a primary programme (Programme 1) and optional ancillary programs that can be delivered at much lower bit rates than Dolby Digital. These 20 channels are compressed (lossy) into an independent digital data stream plus up to

8 dependent sub stream that can be transferred between compatible devices and stored on a standard stereo pair of audio tracks.

Analyser Reference

In order for the Dolby E data to be decoded correctly, the internal audio circuitry requires a reference that is synchronized to the input SDI signal for embedded audio and the external system reference for AES audio. The Generator Reference MUST NOT be set to Free-Run or Dolby errors may be detected. Note that the description field will display “Invalid Reference” if an incorrect reference is selected.

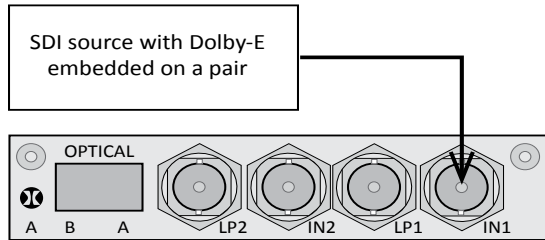

In this example, the SDI signal contains embedded audio with Dolby E, Dolby Digital or Dolby Digital Plus present on one or more audio pairs. The Rx instrument needs to lock its internal audio clock to the SDI signal and the Rx needs to be configured to select the specific audio channels containing the Dolby audio

In the example below, the AES signal contains a Dolby digital audio stream. The Rx instrument needs to lock its internal audio clock to the external reference signal. This can be done from the “Ref” menu on the HDMI task bar, the Rx2000 “Dolby Metadata” and the Rx2000 “Generator” - “Genlock” menus.

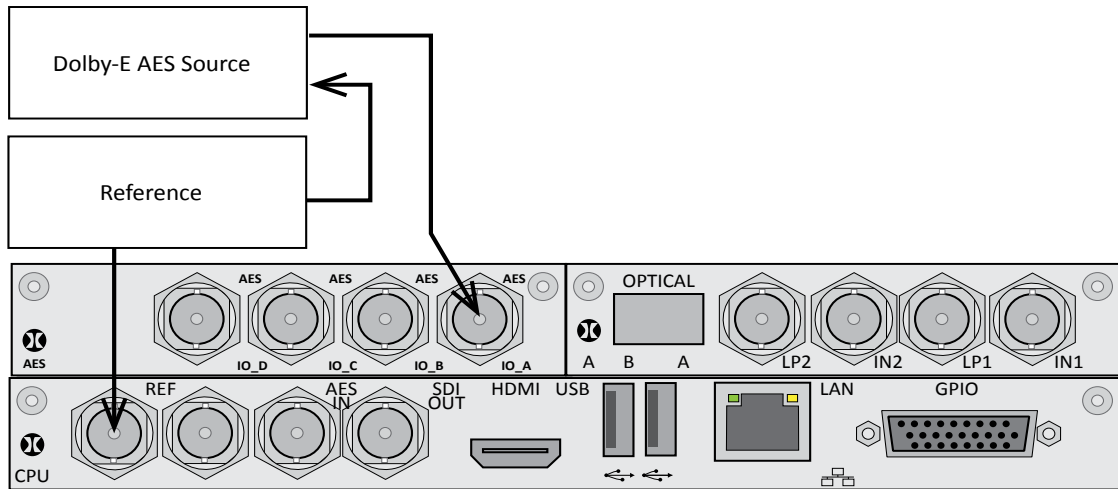

In the Dolby Meta-Data window, the Dolby Timing source should be set to Ext Ref.

The AES source MUST be locked to the same reference as the Rx.

Source selection

The Dolby E may be monitored from any of the SDI input embedded audio channel pairs or the AES input. The two drop down lists in this section allow the module input and specific audio channels to be selected.

Dolby Framing Values

It is important for the Dolby E packet to be positioned well away from the video switching line so that Dolby E packets are not corrupted by downstream switchers. At all places in the signal chain where audio can be delayed by a different value to the video, the Dolby E packet needs to be re-timed to make sure that this timing specification is met. The position of the Dolby E packet in the video frame is displayed in lines and micro-seconds (us).

Dolby E Timing source

Dolby E timing may be measured relative to the SDI input or the External reference. If the 'Ideal' check box is checked, the Dolby E Frame timing is relative to the normal position that it should be, ie it should be as close to 0 as possible. Each video standard has a specified 'Ideal' line number that the Dolby E packet should start on. If the Dolby E timing line is outside the valid range of lines it will be displayed in red. If it is outside the ideal range it will be displayed in dark green – this is still a valid Dolby E position but not recommended by Dolby. The timing measurement is always displayed in terms of the SDI input lines and thus if an AES input is used as the Dolby E source, the line position will NOT be displayed.

If you do not have the same reference as the SDI source, you will have to set the Reference Source and Dolby Timing Source to be the SDI input.

IMPORTANT: If Dolby E is present on a fast frame rate signal (50p, 59p or 60p) then it should always be referenced to a interlaced reference at the same field rate as the packet length is longer than a single frame and must start at the beginning of an even numbered frame.

Dolby E Programme configuration

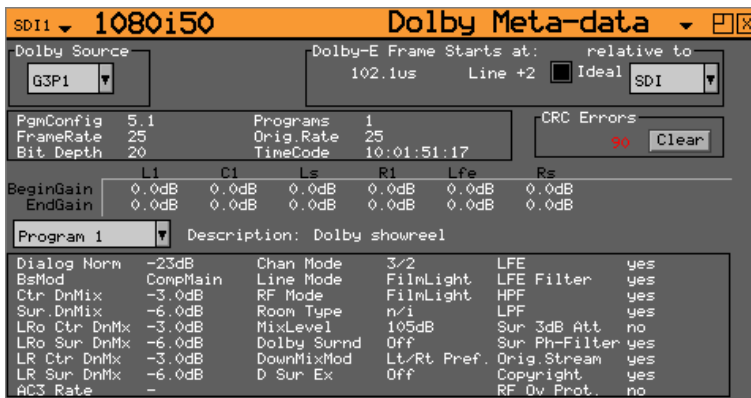

This displays the Program configuration (5.1 etc), the number of programs in the meta-data, the frame rates and bit depths and time-code if any present.

CRC Errors: This displays the number of CRC errors detected in the Dolby E meta-data.

Begin Gain: These fields indicate the gain to be applied to the specified channel at the beginning of the audio frame when decoding.

End Gain: These fields indicate the gain to be applied to the specified channel at the end of the audio frame when decoding.

Program selection: Selects which set of program meta-data is shown. Up to 8 programs can be encoded in the Dolby E packet dependent on the Program Configuration.

Program description: User defined description for the selected program.

Dolby Digital Programme configuration

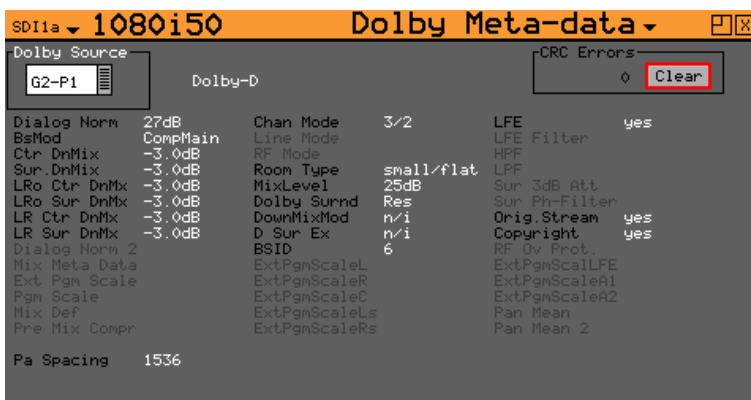

When Dolby Digital metadata is analysed this displays channel configuration and limited metadata that is sent with Dolby Digital.

Dolby Digital Plus Programme configuration

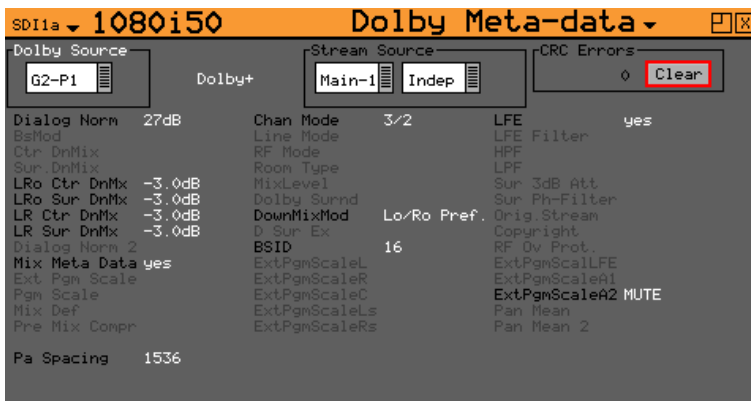

When Dolby Digital Plus metadata is analysed this displays the Main, Dependent and Independent program stream configuration and limited metadata that is sent with Dolby Digital Plus.

Programme Metadata

Programme metadata is created as part of Dolby authoring process. The following metadata is typically provided with a Dolby E Program. Dolby Digital and Dolby Digital Plus will use a subset of this metadata:

- Dialogue Norm is the normal audio level for dialogue. Ideally all transmitted programs would have the same value.
- BsMod (Bitstream Mode) indicates the type of audio service that the bitstream contains. Complete Main (CM) is the normal mode of operation and contains a complete audio program including dialog, music, and effects.
- Ctr DnMix (centre down-mix) is a weighting value used in the encoding and decoding of surround sound mixes for a Dolby 5.1 Independent Substream.
- Sur DnMix (surround down-mix) is a weighting value used in the encoding and decoding of surround sound mixes for a Dolby 5.1 Independent Substream.
- LROctrDnMix (left/right/stereo/centre down-mix) is a weighting value used in the encoding and decoding of surround sound mixes for a Dolby 7.1 Dependent Substream.
- LROsurDnMix (left/right/stereo/surround down-mix) is a weighting value used in the encoding and decoding of surround sound mixes for a Dolby 7.1 Dependent Substream.
- LR CtrDnMix (left/right/centre down-mix) is a weighting value used in the encoding and decoding of surround sound mixes for a Dolby 5.1 Independent Substream.
- LR SurDnMix (left/right/surround down-mix) is a weighting value used in the encoding and decoding of surround sound mixes for a Dolby 5.1 Independent Substream.
- Chan Mode defines the channel configuration for Program 1 (ie mono, stereo, 5.1).
- Line Mode this is an Operational Mode / Dynamic Compression Mode that is used by consumer and professional decoder products that simplifies the implementation of Dialogue Normalization, Dynamic Range Control, and down mixing functions, all of which are necessary in Dolby Digital products.
- RFMode this is an Operational Mode / Dynamic Compression Mode that is used by consumer and professional decoder products that simplifies the implementation of Dialogue Normalization, Dynamic Range Control, and down mixing functions, all of which are necessary in Dolby Digital products.
- Room Type this informational parameter indicates the type and calibration of the mixing room used for the final audio mixing session.

MixLevel	the Surround Down mix Level parameter indicates the nominal Lo/Ro down mix level of the Surround channel(s) with respect to the Left and Right channels
DolbySurnd	the Dolby Surround Mode parameter indicates whether or not a two-channel Dolby Digital bitstream is conveying a Dolby Surround encoded program.
DownMixMod	this controls the Down Mix Mode which is used by the content creator to optimise Centre and Surround channel levels for use in stereo down mix mode for any two-channel programmes.
D Sur Ex	this controls the Dolby Surround Ex channel that provides an extra audio channel for Dolby 5.1. The extra surround channel of the Dolby Surround Ex system is matrix-encoded onto the discrete left-surround and right-surround channels of the 5.1 mix.

The following control bits can also be viewed:

LFE	the LFE Channel parameter enables or disables the Low-Frequency Effects (LFE) channel.
HPF	this parameter can be used to activate the DC High pass filter for all input channels.
LPF	the LFE Low pass Filter parameter can be used to activate a 120 Hz low-pass filter applied to the LFE input channel.
Sur 3dB Alt	the Surround Channel 3 dB Attenuation function is use to apply a 3 dB attenuation to the Surround channels of a multichannel soundtrack created in a room with film style calibration, when encoding it for consumer home theatre playback.
Sur Ph + Filter	the Surround Channel 90-Degree Phase-Shift feature is used for generating multichannel Dolby Digital bitstreams that can be down-mixed in an external two channel decoder to create a true Dolby Surround compatible output.
Org Stream	the Original Bitstream informational parameter sets the value of a single bit within the Dolby Digital bitstream. This bit has a value of 1 (box checked) if the bitstream is an original. If it is a copy of an original bitstream, it has a value of 0.
Copyright	the Copyright Bit informational parameter sets the value of a single bit within the Dolby Digital bitstream. If this bit has a value of 1 (box checked), the information in the bitstream is indicated as protected by copyright. If it has a value of 0, it is not copyright protected.
RF 0v Prot	the RF Over-modulation Protection parameter determines whether or not an RF pre-emphasis filter is used in the overload protection algorithm to prevent RF over-modulation in set-top box decoders.

Peak Metering

The peak audio levels are included in the Dolby E metadata packet and may be displayed on the Audio - Meters page. Select the appropriate set of meters to display Dolby levels and then they will follow the selected Dolby E source.



Note that audio cannot be decoded by the Rx range of products and so you will NOT be able to listen to the Dolby E signal. Note also that the LFE channel audio levels do not seem to be metered by current Dolby encoding modules.

See the logging section for details on which changes of Dolby E status may be logged.

Monitor Output

System Panels

Overview

Clicking on the System menu will allow the following window panels to be displayed.

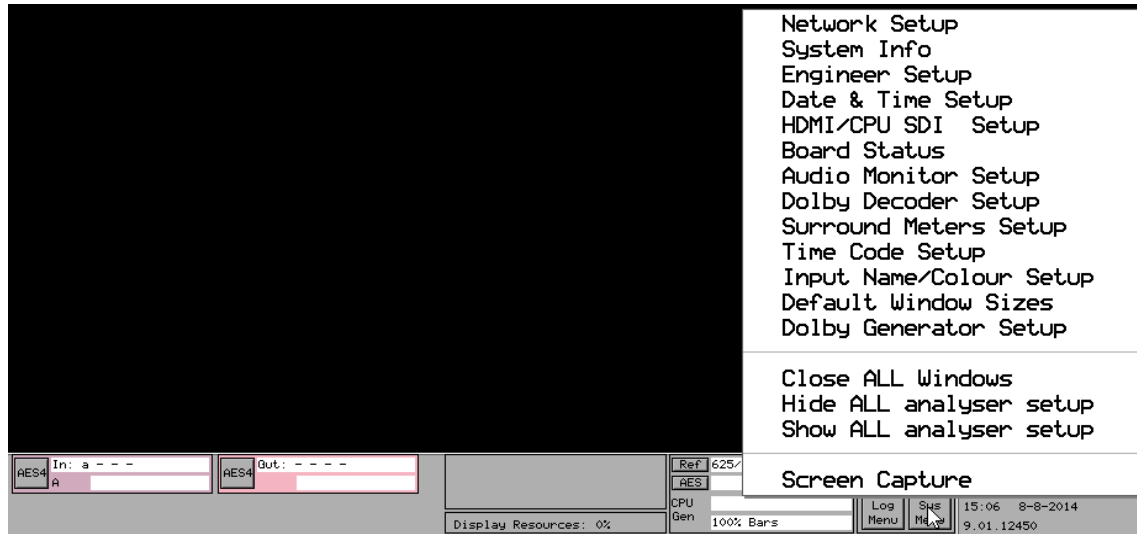

Network

The Rx Instrument is fully network compatible and has a complete network interface to allow control of any Rx instrument from any other unit. The Network menu allows the Rx instrument to be configured as part of a network

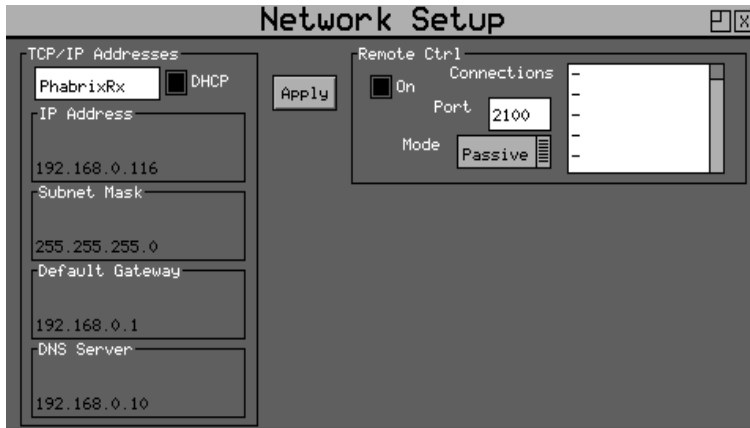

The Network Setup window is accessed by clicking on the System menu on the monitor output task bar and selecting “Network Setup”.

Network Setup

On all Rx instruments the network addressing can be setup using the HDMI® monitor output. On the Rx2000 instrument the IP Address can be setup using the Front Panel menus.



Note that if the Rx instrument is turned on without the network connected, you will have to select the “Re-connect” button to set networking up correctly. This is because the Ethernet connection auto senses whether it has to swap the cable over which means that you can use any Ethernet cable with the Rx instrument but it also requires the Ethernet connection to be present when starting up.

The IP Address for the Rx instrument can be setup using the “Network Setup” window on the HDMI® monitor output. A new “Network Setup” window can be created by right-clicking with a mouse in the display area and selecting the “Network Setup” option.

If the DHCP check box is enabled, then the Rx instrument will attempt to automatically request an IP Address from any network it is connected to. This will only work if there is a DHCP server on network.

If your network has ‘static’ (non changing) addresses, you will need to see your network administrator to get an address assigned to your instrument and to get the Subnet mask and default gateway address. These details can then be entered in the corresponding boxes in the menu. Select each numeric box in turn and use the up and down cursors to pick the required value.

When the IP Address, Subnet Mask, Default Gateway and DNS Server values have been setup, use the Apply button to attach the Rx instrument to the network.

On the Rx2000 instrument, select the “System” - “Network” menu to access the IP Address, Subnet Mask, Default Gateway and DNS Server values. Select the “Setup” button and edit the settings. Note that if the DHCP check box is enabled, you will not be able to change these values. Once the network addressing has been setup, select the “Apply” button to attach the Rx instrument to the network.

Remote Control of Rx Instrument

To allow remote control of an Rx instrument, you must have the TCP/IP address of the instrument set and the Remote Control 'On' check box must be checked.

The list box shows a list of current connections made to the instrument. This includes the web browser connection (127.0.0.1) which may be seen intermittently as the web browser connects every few seconds and then disconnects again. See the remote control documentation available for download for more information on the protocol and method of control.

The Rx instrument uses a default Port Number of 2100 for remote control access (See Remote Control SDK documentation on Download section of PHABRIX Web Site) This port number may now be changed if it conflicts with other applications in your system.

Engineer

The Engineer menu is used to manage the Rx instrument and allows user access to be setup and the installation of new versions of software.

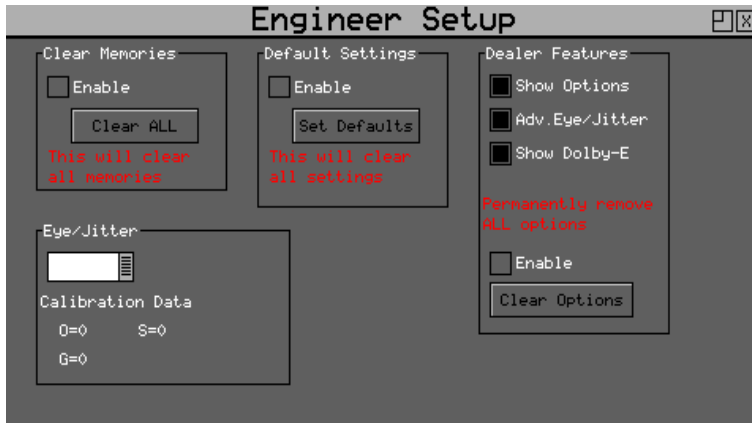

The Engineer Setup window is accessed by clicking on the System menu on the monitor output task bar and selecting “Engineer Setup”.

Clear Memories

This section of the menu allows the defined users who can access the Rx instrument to be cleared. To use this function, select the ‘Enable’ check box and press the ‘Clear ALL’ button. This will clear all of the user memories will be deleted.

Default Settings

This section of the menu allows you to reset the Rx instrument back to its default settings. To do this, select the ‘Enable’ check box and press the ‘Set Defaults’ button and the factory defaults will be recalled. This will not affect the system Security Code or Free Run frequency.

Rear Audio Calibration

The “Cal” value is use to calibrate the analogue circuitry on the CPU Module to ensure that analogue audio signal level matches the digital audio level being produced by the Generator module.

Software Upgrade

This section of the menu allows new software versions to be installed. The Rx instrument may download and install new versions of software when available. This process is a two stage process: Download the software and then install it.

Note that on the HDMI® monitor output this controlled from the System Info menu.

1. To download the latest software version, make sure that the network settings are correct and that the Rx instrument is connected to the internet via the Ethernet connection.

Pressing the Download button will cause the current release of software to be downloaded from the Phabrix Web Site. This will take a short time dependent on the connection to the Internet. Once the download has completed, the software will be checked for errors before being stored on the Rx instrument for future installation. If the latest software is already present on the Rx instrument, no software will be downloaded and a message will be shown.



Note that multiple releases of software may be stored on the Rx instrument so a previous release can be re-installed if required.

2. To install the downloaded software on the Rx instrument, select the release using the field with releases listed. The largest number is the latest release. Select the 'Install' button and a confirmation dialogue will be shown. Press "Yes" and the installation will start. This process takes several minutes to decompress the software, extract the files and then reprogram the hardware. If an error is given during the installation, retry the installation and or download. Do NOT turn the Rx instrument off until an installation has completed correctly.

Once the installation has completed, if "Reboot after Install" is checked the Rx instrument will re-start with the new software installed. If not checked then the instrument should be turned off and on again manually.



Note that as part of the installation procedure, all memories are archived to a backup file and then deleted. They can be restored from the System-Memories page using the Restore button and selecting the '_Before_Upgrade' archive.

The software release notes can be viewed by selecting the Changes button.

HDMI/CPU SDI Setup / HDMI/SDI Output

HDMI Output

The Rx range of products provide a Monitor output in the form of an HDMI output that can display up to 16 instrument windows at 1920 x 1080 resolution. This menu also controls the use of the SDI output on the CPU board and allows the built-in generator to be used

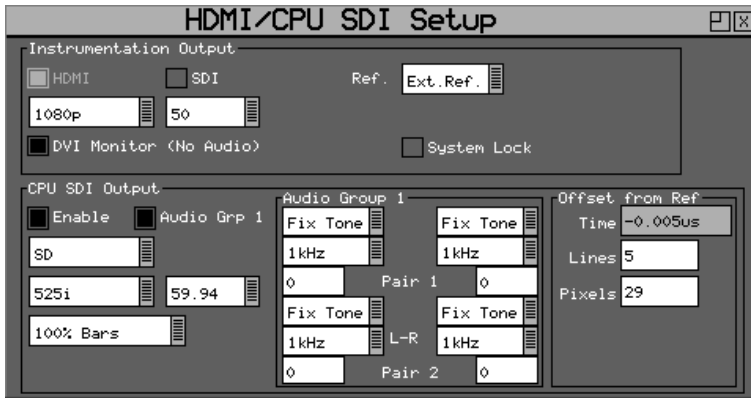

The HDMI/CPU SDI Output Setup window is accessed by clicking on the System menu on the monitor output task bar and selecting “HDMI/CPU SDI Output Setup”.

The Monitor output display can display the pre-sets selected by the “Pre-set Buttons” and can be controlled by a USB mouse and keyboard connected to the Rx instrument



Note that on the Rx 500 and Rx 1000 instruments, the Monitor Output is always enabled. But on the Rx 2000 instrument, however, the Monitor output can be enable/disable in the “HDMI/SDI Output” menu that is available from the Instrument Display on the front of the instrument.

The HDMI® monitor output can only be in the following formats:

1080p, 50, 59.94 or 60

1080i, 50, 59.94 or 60

If the “System Lock” check box is enabled the HDMI output will be locked to the system’s locking reference input signal. See the “External Locking Reference” section.

CPU SDI Output

The built-in video signal Generator on the CPU board (standard on all Rx instruments) provides an SDI test output. This is tied to the HDMI® monitor output and can only produce test signals in a range of video formats matching those of the HDMI output. If an unrestricted range of test signal video formats is needed, then either the HDMI out needs to be disabled or an additional Generator module is required.

With the HDMI output enabled (always enabled on the Rx 500 and Rx 1000 instruments and configurable on the Rx 2000 instrument) then the frame rate of the SDI output is limited to be match to the HDMI output. The HDMI standard and frame rate combo-boxes will be limited to 1080p 50/59/60. If the HDMI output is disabled (Rx 2000 only), the SDI output may be any frame rate.

Using SDI output as Test Pattern Generator

The SDI output on the CPU module can be used as a test pattern and audio tone generator. This output is limited to specific test patterns and can only provide audio tones for Audio Group 1

Select the required video format, line rate and frame rate from the drop down menus in the “CPU SDI Output” section then select “100% Bars”, “75% Bars” or “CheckField” as the test pattern.

The audio source for each channel may be Silence, Fixed tone (a range of fixed frequencies), variable tone (set in 1 Hz steps from 1 Hz to 23.99kHz) or white noise.

If the “Lock to Ref” check box is enabled the test pattern will be locked to the system’s locking reference input signal. See the “External Locking Reference” section.

Using HDMI over SDI

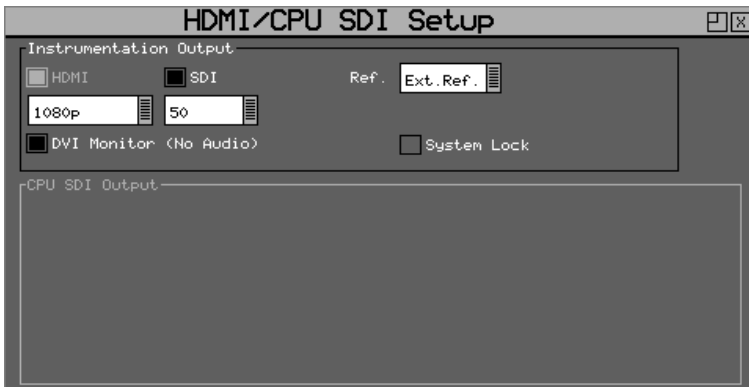

Select the “SDI” check box in the “Instrumentation Output” section if you wish to route the HDMI® monitor output over SDI.

This will disable the on-board test pattern generator.

External Locking Reference

When using an external locking reference signal, the Rx system will provide the best possible locking regardless of the locking reference frame rate and the generated frame rate.

When the frame rate of the locking reference is exactly the same as the generated frame rate, there will be an exact lock vertical and horizontal between them.

When the frame rate of the locking reference and the generated frame rate are divisible (for example 50/25, 60/30, 59.94/23.98) there will be an exact lock vertical and horizontal between them.

When there is no relationship between the frame rate of the locking reference and that of the generated frame rate (for example a 625/50 locking reference and a 23.98 generated test pattern) then there will be a static lock between them but this will not be consistent.

System Info

The System Info window displays the system software status and options that are installed on the HDMI® monitor output.

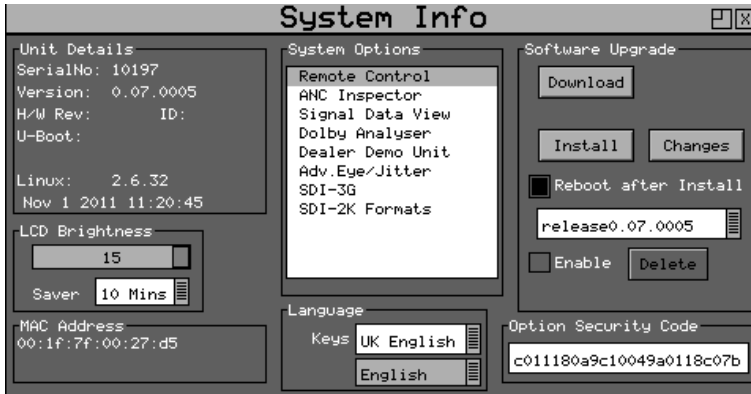

The System Info window is accessed by clicking on the System menu on the monitor output task bar and selecting "System Info".

Setting User Language

The language used to display the menus may be changed to one of the supported languages. (Currently only English is supported)

Changing Options Security Code

When new options are purchased for the Rx instrument a new Security Code will be supplied. This is specific to this instrument and cannot be used on other units. The security code is entered using the Edit field below the System Option list and is edited by pressing OK and using the menu function keys. If an incorrect Security code is entered a dialogue will be displayed. The new Security code will only be saved if it is valid, the old code will be used until a valid code is entered. Once a valid new code has been entered, the list of options provided by that code will be displayed. The options code is stored independently to memories and system settings.

Software Upgrade

This section of the menu allows new software versions to be installed. The Rx instrument may download and install new versions of software when available. This process is a two stage process: Download the software and then install it.

1. To download the latest software version, make sure that the network settings are correct and that the Rx instrument is connected to the internet via the Ethernet connection.

Pressing the Download button will cause the current release of software to be downloaded from the Phabrix Web Site. This will take a short time dependent on the connection to the Internet. Once the download has completed, the software will be checked for errors before being stored on the Rx instrument for future installation. If the latest software is already present on the Rx instrument, no software will be downloaded and a message will be shown.



Note that multiple releases of software may be stored on the Rx instrument so a previous release can be re-installed if required.

2. To install the downloaded software on the Rx instrument, select the release using the field with releases listed. The largest number is the latest release. Select the 'Install' button and a confirmation dialogue will be shown. Press "Yes" and the installation will start. This process takes several minutes to decompress the software, extract the files and then reprogram the hardware. If an error is given during the installation, retry the installation and or download. Do NOT turn the Rx instrument off until an installation has completed correctly.

Once the installation has completed, if "Reboot after Install" is checked the Rx instrument will re-start with the new software installed. If not checked then the instrument should be turned off and on again manually.



Note that as part of the installation procedure, all memories are archived to a backup file and then deleted. They can be restored from the System-Memories page using the Restore button and selecting the '_Before_Upgrade' archive.

The software release notes can be viewed by selecting the Changes button

Board Status

The Board Status window displays the current status of the hardware modules on the HDMI® monitor output. This can then be used to inspect which Modules have been installed in the Rx instrument.

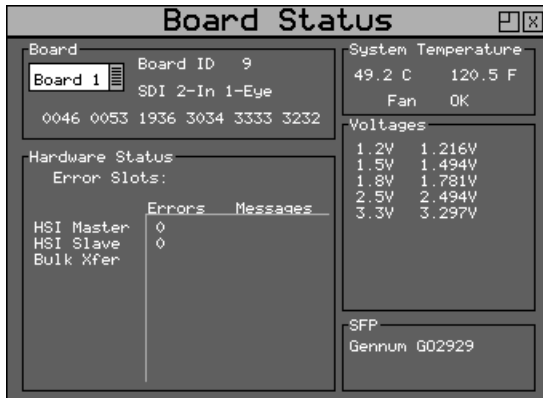

The Board Status window is accessed by clicking on the System menu on the monitor output task bar and selecting “Board Status”.

Board (Module)

This section of the menu details the Modules that are currently installed in the Rx chassis.

- Front if this is selected will display the hardware details of the front panel board.
- CPU if this is selected will display the hardware details of the CPU Board.
- Board 1 if this is selected will display the hardware details of the Module fitted in chassis slot 1.
- Board 2 if this is selected will display the hardware details of the Module fitted in chassis slot 2.
- Board 3 if this is selected will display the hardware details of the Module fitted in chassis slot 3.
- Board 4 if this is selected will display the hardware details of the Module fitted in chassis slot 4.

Hardware Status

This section of the menu shows any hardware errors that have been recorded by the Rx instrument. If the error count is greater than 0, contact your local dealer for advice.

System Temperature

This section of the menu displays the current Rx instrument temperature. This information is provided for diagnostics purposes only.

Voltages

This section of the menu displays the current voltages for the currently selected board in the “Board” section of the menu. This information is provided for diagnostics purposes only.

SFP

This section of the menu displays the type of SFP (Small Form Factor Package) module installed in the board currently selected board in the “Board” section of the menu. This information is provided for diagnostics purposes only.

Date/Time Setup

The Date/Time Setup window displays the current status of the hardware modules on the HDMI® monitor output. This can then be used to set the date and time of the Rx instrument.

The Date/Time Setup window is accessed by clicking on the System menu on the monitor output task bar and selecting “Date & Time Setup”.

This menu can also be displayed by clicking on the date displayed in the bottom right of the Monitor Output display.

Changing The Date/Time

Check the ‘Enable Change’ check box under the date and time fields and then use the cursor to move around the date and time. Press ‘OK’ to edit a field and again to complete the change. When all fields have been edited, uncheck the ‘Enable Change’ check box and the new date and time will be set.

Changing the Date Format

The date format used on logging screens etc may be set using the Format selection control. Three formats are available: Date-Month-Year, Month-Date-Year and Year-Month-Date.

Daylight saving Time

Daylight saving times can be implemented as well as the introduction of a fixed time offset with respect to GMT. Select the “Apply Daylight Saving Time” check box and set daylight saving time start and end dates in the “DST Start” and “DST End” sections. If there is a fixed time offset between local time and Greenwich Mean Time this can also be applied.

Un-check the “Change” check box to action the Date and Time change.

Network Time Protocol

The Date and Time Setup window allows the selection of Network Time Protocol to control the Rx system time. Select the “Set Time Automatically” check box and enter primary and secondary addresses for the network time then select the “Apply” button to apply these changes.

The primary and secondary address fields can be populated with IP addresses or with a web address (for example pool.ntp.org).

Note that if the Rx network is set to a static IP address, then the network “Default Gateway” address and “DNS Server” address must have valid addresses.

The system will automatically try and retry the primary and secondary addresses until local system time can be synchronised to network time. The system will check every 24 hours to ensure that the system time is synchronised.

Un-check the “Change” check box to action the Date and Time change.

Audio Monitoring Setup

The Speaker menu controls which audio pair that can be heard on the loud speakers and headphone output of the Rx instrument.

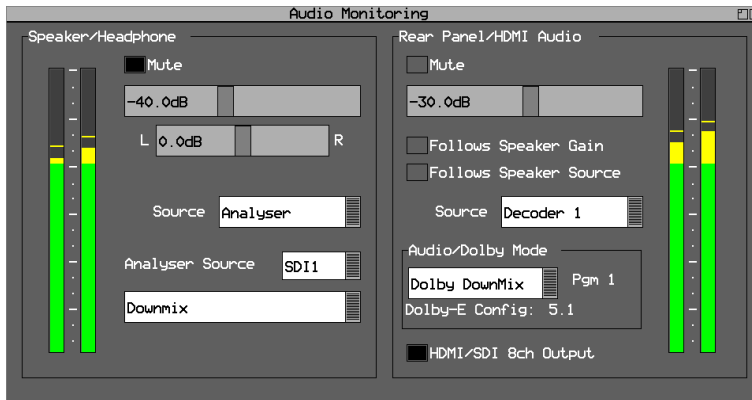

The Audio Monitoring Setup window is accessed by clicking on the System menu on the monitor output task bar and selecting “Audio Monitor Setup”.

Speaker / Headphone

The Rx 2000 instrument contains stereo loud speakers and associated stereo headphone socket which can be connected to any of the audio input or output channels or pairs. The Rx 1000 and Rx 500 instruments only have a stereo headphone socket.

The “Mute” check box allows both signals to be muted.

A volume control is provided to adjust the level to headphones and speaker together. The balance control can be used to adjust the Left-Right balance for the source being monitored.

The monitored source can be set to the input or output of the Rx instrument and the input and output sources can be set independently to either a stereo pair or single audio channel.

The “Source” drop down is used to select Analyser, AES Input or Dolby Decoder output as the audio source. The “Analyzer Source” is used to select the specific channels of the source that is to be heard.

The speaker can be muted when headphones are plugged in by checking the “Mute” box.

Note that when listening to an audio source, the Rx system needs to be locked to the same reference as the audio otherwise audio ‘clicks’ may be heard on the speaker.

Rear Panel Audio

The controls in the Rear Panel Audio section of the menu are used to setup the audio levels of the unbalanced analogue audio available on the D-type connector on the CPU module.

The “Follows Speaker Gain” check box if enabled will cause the audio level of the analogue signal follow the level set by the volume control on the front panel of the Rx unit. If the check box is not enabled the analogue audio level will remain the same regardless of the front panel volume control.

The “Follow Speaker Source” check box if enabled make the rear panel audio the same as the Speaker/Headphone selection.

The volume slider below the “Follows Speaker Gain” check box can be adjusted to set the nominal output volume of the analogue output signal.

The “Source” drop down is used to select Analyser, AES Input or Dolby Decoder output as the audio source. The “Analyzer Source” is used to select the specific channels that is to be routed through to rear panel and HDMI audio.

The “HDMI/SDI 8ch Output” check box if enabled allows 8 audio channels to be routed to the rear panel / HDMI audio instead of a stereo pair.

Dolby Decoder Setup

If the Dolby Decoder module is installed in the Rx system, it can be configured to decode specific SDI or AES inputs of Analyser or 4AES modules.

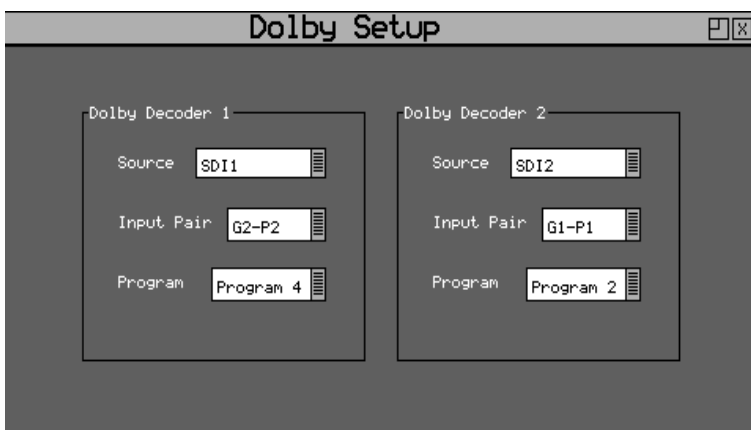

The Dolby Decoder Setup window is accessed by clicking on the System menu on the monitor output task bar and selecting "Dolby Decoder Setup".

Source defines the specific Analyser input channel or 4AES module to use.

Input Pair defines the specific SDI audio pair or 4AES module input to use.

Program defines the specific Dolby program to decode.



Note that the 2 Dolby Decoders cannot be assigned to the same Analyser or 4AES module.

Throughout the Rx system audio instruments, the decoded output of these 2 Dolby Decoders can be selected so that the individual decoded Dolby channels, pairs of channels or a mixed-down version can be selected.

Note that the Dolby Decoder settings are stored as part of the system configuration and cannot be saved in presets.

Surround Channel Setup

Throughout the Rx instrument wherever 5.1 surround sound audio is used the actual physical audio channel mapping that is used is defined in the Surround Channel Setup menu.

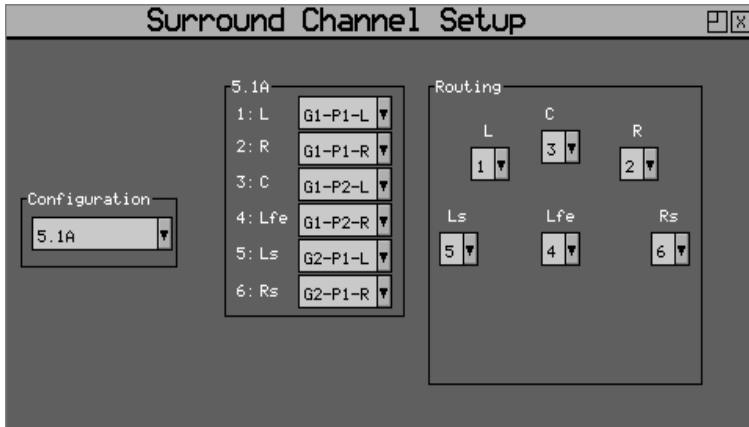

The Surround Channel Setup window is accessed by clicking on the System menu on the monitor output task bar and selecting "Surround Channel Setup".

This menu is used to route specific embedded SDI audio channels to the 5.1 channels these are stored as 2 different configurations, 5.1A and 5.1B which can be selected from the Configuration drop down menu.

The centre section of the menu displays a table of meter channels against SDI input channel. These can be setup to match the 5.1 channels of the SDI inputs to the corresponding meter labels so that Loudness measurements can be made correctly.

The right hand section of the menu show the routing of these meter channels.

Typically for Dolby E 5.1 configuration is as follows:

- AES 1/2 - G1P1 - Front left / Front right
- AES 3/4 - G1P2 - Centre / LFE (low frequency effects)
- AES 5/6 - Rear left / Rear right

Time Code Setup

The Time Code Displays window controls display of time code information on the HDMI® monitor output. Time code is available on the locking reference input and on each video input that is analysed.

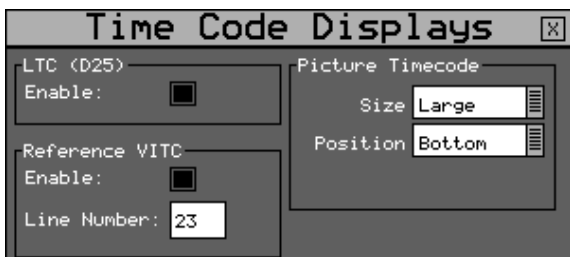

The Time Code Displays window is accessed by clicking on the System menu on the monitor output task bar and selecting "Time Code Displays". This window is also display when selected on the Picture instrument.

The Time Code Displays window allows Vertical Interval Timecode (VITC) present on the analogue (625i/50 and 525i/59.94) locking reference signal connected to the "REF" connection on the rear of the Rx unit, and Longitudinal Timecode (LTC) present on the "GPIO" D-type connector, to be displayed on the Task Bar of the HDMI® monitor output.

The line number where the VITC is located on the analogue locking reference signal can be selected using the "Line Number" field.

This window also allows the ANC Timecode from the video input to be displayed in 3 different positions and 3 different sizes on the picture window.

Default Window Size

The Default Window Sizes window controls how instrument windows are added to the HDMI® monitor output and their starting size.

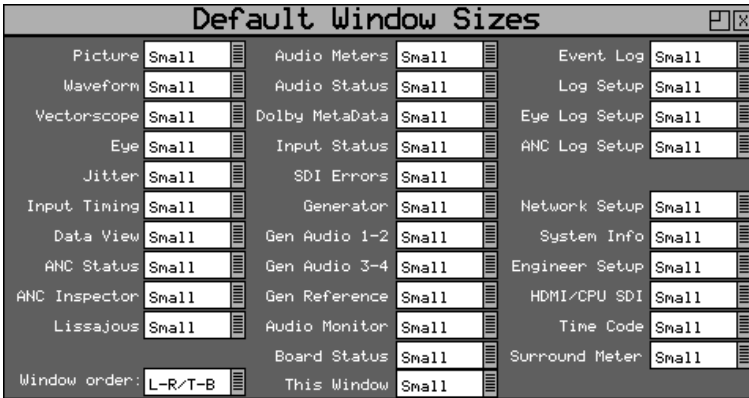

Instrument windows can be automatically assembled on screen either left to right or top to bottom.

The default size of Picture, Waveform, Vectorscope, Eye and Jitter windows can be set as small (1/16 screen size) or Quad (1/4 screen size). The default size of the Picture and Waveform windows can also be set to Large (3/4 screen size) or Full (full screen native video format display).

Dolby Generator Setup (Dolby Generator Option)

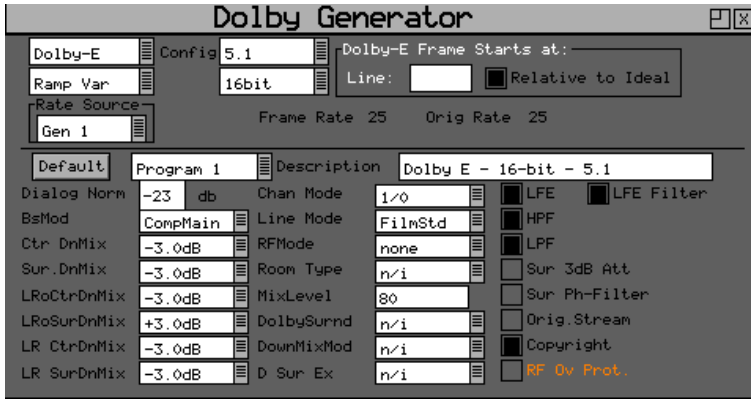

The Dolby Metadata Generator software option allows generation of Dolby-E, Dolby Digital and Dolby Digital Plus pre-encoded test signals to check that they are transferred transparently through the broadcast chain unaffected by routers/switchers, satellite links, etc.



Caution with this software version Dolby E can be embedded within 50, 59.94 and 60 frames per second progressive video formats but this mode of working has not been supported by Dolby since 2008. This mode of operation of Dolby Generator is only provided to support legacy Dolby equipment produced prior to 2008.

For high progressive frame rates an external locking reference must be used.



Note that with this software version Non-Keyed signals are generated which may be incompatible with certain VTRs.

Overview

There are a number of Dolby broadcast digital audio standards that transport audio data over an SMPTE 337M AES carrier with a 48kHz sample rate. The type of Dolby to be generated can be selected from the drop down list in the top left corner of the menu:

- Dolby E
- Dolby Digital
- Dolby Digital Plus

These standards can be used to transport mono, stereo, 5.1 and 7.1 audio programmes:

Dolby 5.1 - involves five channels for normal-range speakers (20 Hz – 20,000 Hz) (right front, centre, left front, rear right, rear left) and one channel (20 Hz – 120 Hz allotted audio) for the subwoofer driven low-frequency effects.

Dolby 7.1 uses six channels in the primary program (Independent Substream) for a standard 5.1 surround sound mix and then the 2 remaining 2 channels in an ancillary programme (Dependent Substream) to provide the additional down-mix.

Dolby E

Dolby E is an audio encoding and decoding technology developed by Dolby Laboratories that allows up to 8 channels of audio (mono, stereo, 5.1 or 7.1) that for a primary programme (Programme 1) and optional ancillary programs. These 8 channels are compressed (lossless) into a digital stream that can be transferred between compatible devices and stored on a standard stereo pair of audio tracks.

Dolby Digital

Dolby Digital (AC-3) is a ‘perceptual audio’ system for digital audio that allows the reduction of data needs to deliver high-quality sound. This system was developed primarily for DTV, DVD and HDTV. This format allow up to six channels of sound (mono, stereo or 5.1) in the form of a single ‘program’ that can be delivered at different bit rates. These 6 channels are compressed (lossy) into a digital stream that can be broadcast. The most elaborate mode in common use is Dolby 5.1 with uses all six channels to provide surround sound.

Dolby Digital Plus

Dolby Digital Plus (E-AC-3) is a more advanced version of Dolby Digital that provides a more efficient encoding algorithm that provide enough bandwidth that allows up to 20 channels of audio (mono, stereo, 5.1, 7.1 up to 13.1) that for a primary programme (Programme 1) and optional ancillary programs that can be delivered at much lower bit rates than Dolby Digital. These 20 channels are compressed (lossy) into an independent digital data stream plus up to 8 dependent sub stream that can be transferred between compatible devices and stored on a standard stereo pair of audio tracks.

Dolby E Synchronisation - Generator Reference

The Dolby audio test signal produced by the Rx instrument is common to all generator modules within the system and is locked to either one of the generator video formats or to the System Reference (typically external reference).

If the Dolby Generator is locked to an external signal, the reference signal **MUST** have a compatible frame rate. See the table below for examples.

Video Output Format	Valid Reference Formats
1080i50	1080i50, 625i50(PAL)
1080i59	1080i59, 525i59(NTSC)
1080p25	1080p25, 1080i50, 625i50(PAL)
1080p29	1080p29, 1080i59, 525i59(NTSC)
720p50	1080p25, 720p25, 1080i50, 625i50(PAL) – due to length of packet being over 1 frame long
720p59	1080p29, 720p29, 1080i59, 525i59(NTSC) – due to length of packet being over 1 frame long
1080p50	1080p25, 720p25, 1080i50, 625i50(PAL) – due to length of packetbeing over 1 frame long
1080p59	1080p29, 720p29, 1080i59, 525i59(NTSC) – due to length of packet being over 1 frame long



Note that for high frame rate progressive video formats being generated the Rx chassis **MUST HAVE** a compatible frame rate locking reference and the Dolby Generator **MUST BE** set to External Reference.

Editing Program Information

- Stream type: Dolby-E, Dolby Digital and Dolby Digital Plus streams can be generated.
- Config, Bit Depth: The program configuration and Bit Depth can be changed to load the pre-encoded file.
- Stream contents: The tones generated are of a fixed predefined frequency. Four sets of pre-encoded streams are provided:
 - Ramp Var - Each channel has a different frequency to allow checking of channels. The levels are ramped so that different channels have different levels.
 - 3dB Fixed - All the tones are at -3dB co-phased / timed and are at the same frequency.
 - 18dB Fixed - All the tones are at -3dB co-phased / timed and are at the same frequency.
 - 20dB Fixed - All the tones are at -3dB co-phased / timed and are at the same frequency.

Fixed Frequency values for "Fixed level" streams above:

Frame Rate	Normal Frequency	LFE Frequency
23.98	4.8kHz	211Hz
24	6kHz	240Hz
25/50	6kHz	240Hz
29.97/59.84	6kHz	133Hz
30/60	6kHz	240Hz

- Dolby-E start line: The start line can be used to set valid or invalid ranges to allow checking of the Dolby-E guard band on downstream equipment. If the start line is set outside the valid range specified by Dolby, the line number will be displayed in RED.
- Relative to Ideal: If this check box is checked, the line number displayed is relative to the Dolby specified ideal line. A value of '0' therefore starts the Dolby-E packet on the 'Ideal Line' for that video format.
- Frame Rate: This is set by default to the currently generated frame rate but may be modified by the user to test downstream equipment.
- Original rate: This is set by default to the currently generated frame rate but may be modified by the user to test downstream equipment.



Note that if generating a progressive fast rate video standard such as 720p50, 720p59 or 720p60 etc. the Dolby-E signal will always be generated at the related slower rate. This is a Dolby restriction as the packets are over 1 frame in length for these video formats.

Program Meta Data Editing

Many of the metadata fields may be edited to test downstream equipment. The Channel Mode field may be edited to invalid settings but they will be shown in RED to show that they are invalid. The settings currently being edited are for the selected program but multiple program metadata values can be modified and the settings for all programs are stored in memories.

Metadata changes and line changes will happen cleanly so that no corruption to the Dolby signal will occur.

A maximum of 30 characters may be used for program description text. If the text is longer than this, extra characters will be ignored.

The “Generator” – “Dolby” menu allows the metadata for a Dolby E data stream to be setup for testing purposes. The main purpose of setting these metadata fields is to check that they are transferred transparently through the broadcast chain unaffected by routers/switchers, satellite links, etc. For any programme this metadata would be created as part of Dolby E authoring process. Using the Dolby generator, the following metadata can be setup for Program 1:

Dialogue Norm	is the normal audio level for dialogue. Ideally all transmitted programs would have the same value.
BsMod	(Bitstream Mode) indicates the type of audio service that the bitstream contains. Complete Main (CM) is the normal mode of operation and contains a complete audio program including dialog, music, and effects.
Ctr DnMix	(centre down-mix) is a weighting value used in the encoding and decoding of surround sound mixes for a Dolby 5.1 Independent Substream.
Sur DnMix	(surround down-mix) is a weighting value used in the encoding and decoding of surround sound mixes for a Dolby 5.1 Independent Substream.
LROctrDnMix	(left/right/stereo/centre down-mix) is a weighting value used in the encoding and decoding of surround sound mixes for a Dolby 7.1 Dependent Substream.
LROsurDnMix	(left/right/stereo/surround down-mix) is a weighting value used in the encoding and decoding of surround sound mixes for a Dolby 7.1 Dependent Substream.
LR CtrDnMix	(left/right/centre down-mix) is a weighting value used in the encoding and decoding of surround sound mixes for a Dolby 5.1 Independent Substream.
LR SurDnMix	(left/right/surround down-mix) is a weighting value used in the encoding and decoding of surround sound mixes for a Dolby 5.1 Independent Substream.
Chan Mode	defines the channel configuration for Program 1 (ie mono, stereo, 5.1 channels).
Line Mode	this is an Operational Mode / Dynamic Compression Mode that is used by consumer and professional decoder products that simplifies the implementation of Dialogue Normalization, Dynamic Range Control, and down mixing functions, all of which are necessary in Dolby Digital products.
RFMode	this is an Operational Mode / Dynamic Compression Mode that is used by consumer and professional decoder products that simplifies the implementation of Dialogue Normalization, Dynamic Range Control, and down mixing functions, all of which are necessary in Dolby Digital products.
Room Type	this informational parameter indicates the type and calibration of the mixing room used for the final audio mixing session.
MixLevel	the Surround Down mix Level parameter indicates the nominal Lo/Ro down mix level of the Surround channel(s) with respect to the Left and Right channels
DolbySurnd	the Dolby Surround Mode parameter indicates whether or not a two-channel Dolby Digital bitstream is conveying a Dolby Surround encoded program.
DownMixMod	this controls the Down Mix Mode which is used by the content creator to optimize Center and Surround channel levels for use in stereo down mix mode for any two-channel programmes.

D Sur Ex	this controls the Dolby Surround Ex channel that provides an extra audio channel for Dolby 5.1. The extra surround channel of the Dolby Surround Ex system is matrix-encoded onto the discrete left-surround and right-surround channels of the 5.1 mix.
The following control bits can also be set:	
LFE	the LFE Channel parameter enables or disables the Low-Frequency Effects (LFE) channel.
HPF	this parameter can be used to activate the DC High pass filter for all input channels.
LPF	the LFE Low pass Filter parameter can be used to activate a 120 Hz low-pass filter applied to the LFE input channel.
Sur 3dB Alt	the Surround Channel 3 dB Attenuation function is use to apply a 3 dB attenuation to the Surround channels of a multichannel sound track created in a room with film style calibration, when encoding it for consumer home theatre playback.
Sur Ph + Filter	the Surround Channel 90-Degree Phase-Shift feature is used for generating multichannel Dolby Digital bitstreams that can be down-mixed in an external two channel decoder to create a true Dolby Surround compatible output.
Org Stream	the Original Bitstream informational parameter sets the value of a single bit within the Dolby Digital bitstream. This bit has a value of 1 (box checked) if the bitstream is an original. If it is a copy of an original bitstream, it has a value of 0.
Copyright	the Copyright Bit informational parameter sets the value of a single bit within the Dolby Digital bitstream. If this bit has a value of 1 (box checked), the information in the bitstream is indicated as protected by copyright. If it has a value of 0, it is not copyright protected.
RF Ov Prot	the RF Over-modulation Protection parameter determines whether or not an RF pre-emphasis filter is used in the overload protection algorithm to prevent RF over-modulation in set-top box decoders.

Default Program Meta Data

Pressing the “Default” button will return program meta-data settings to their default values.

Embedding Dolby on SDI Stream

To embed Dolby signals on an SDI stream, the Audio source for that channel should be set to ‘Dolby’. These source selections are found on the Generator – Audio Group 1,2,3,4 pages. Selecting one channel of an audio pair to “DolbyGen” will force the other channel in the pair to select “DolbyGen” also. As the Dolby streams are data, the volume and phase controls are disabled. Changing a channel from Dolby to another source will cause the other channel in the pair to select silence.

Embedding Dolby Signals on AES Stream

To embed Dolby signals on the AES output, the Audio source for the AES output should be set to “DolbyGen”. This selection is found on the right hand side of the Generator – Audio Group 1,2,3,4 pages.



If DolbyGen is selected as the Source for any AES output, the Dolby Generator in the System menu needs to be set to External reference otherwise the Dolby audio packet may not be embedded into the AES stream in the correct place.

Logging Panels

Overview

Clicking on the Logging menu will allow the following window panels to be displayed.

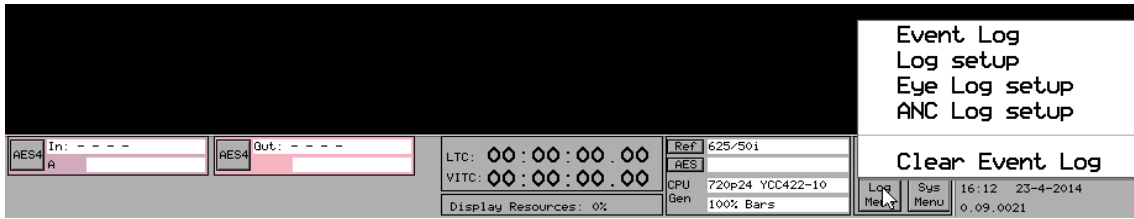

Logging allows events to be detected and recorded for future examination. The events to be logged can be specified so that unwanted events do not appear in the event log. If a system has a problem with intermittent signals, the Rx instrument can be connected to that source and can be left for several days to log any errors. At the end of that period the log can be examined and the time and date of each error noted.

Event Log

The Event Log is where events, that have triggers setup in the Log Setup menu, are recorded.

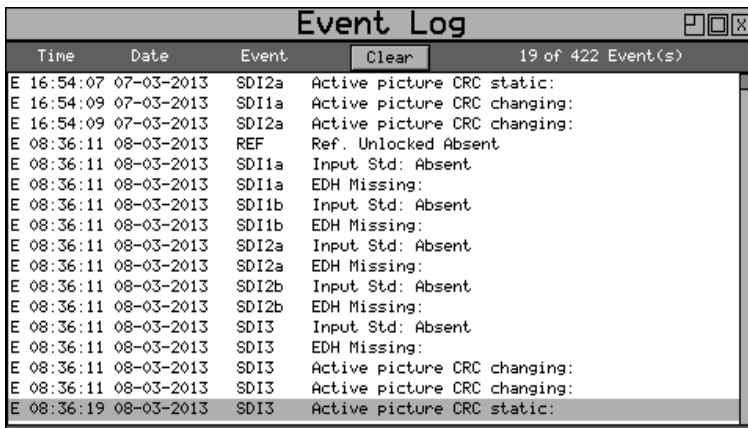

The Event Log window is accessed by clicking on the Logging menu on the monitor output task bar and selecting "Event Log".

The event log may be cleared by pressing 'Clear Log' button; a dialogue will be shown asking the user to confirm the action. A date stamped 'mark' may be inserted into the event log to allow users to see when a test started or when a significant event happened using the 'Add Mark in log' button.



Note that the event log only shows changes in status, so if the input is always in error and never good, an event will not be shown. To get the full state of the instrument will require looking at the current status as well as the event log.

Log Setup

The Log Setup menu allows specific events to be tracked by the Rx instrument. The events to be logged are set up on this page by checking the appropriate 'Log' check boxes.

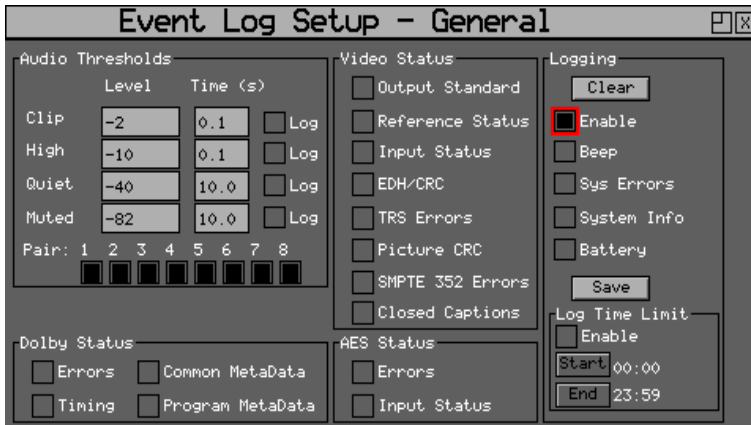

The Log Setup window is accessed by clicking on the Logging menu on the monitor output task bar and selecting "Log Setup".

Audio Thresholds

This section allows the thresholds for audio events to be set. If the audio level for a channel is higher than that specified for the Clip or High fields for the number seconds specified then an event will be added to the event log. If the audio level for a channel is lower than that specified for the Quiet or Muted fields, then an event will be added to the event log. Logging may be limited to specified audio pairs.

Video Status

This section allows specific video status events to be logged:

Output Standard A log event will be added whenever the generator video standard changes.

Reference Status A log event will be added whenever the external reference standard changes or the external reference input is lost or re-appears.

Input Status A log event will be added whenever the input video standard changes or if the input is lost or re-appears.

EDH/CRC A log event will be added whenever a EDH/CRC error state changes. If the EDH/CRC state is correct, the event will show OK, else it will show FAIL. Separate Luma and Chroma CRC events may be shown. Note that EDH/CRC events may occur when an SDI signal is connected or removed.

TRS Errors If the number of lines changes or line length changes during a frame, the input video will be detected as the TRS changing and an event logged. If the signal stays changing only a single event will be logged. If the SDI signal has a static line count and line length for 5 seconds, a TRS OK event will be added to the log. This reduces the number of log events for a bad SDI signal.

Picture CRC This should only be used for static single frame test patterns (do not use for Zone Plate, dynamic broadcast signals or CheckField/Pathological test patterns which are two frames long at HD). This can be used to log changes in the CRC for the active picture (a value which is unique for each test pattern). If the CRC changes and was previously OK an error is added to the event log. If the CRC is the same as the last frame for 5 seconds an OK event will be added to the event log. Thus, if the active picture CRC is continuously changing there will only be one event in the log until the picture remains static when an OK event will be added.

AES Status

This section allows AES audio errors to be logged:

Errors	A log event will be added whenever the embedded audio error status changes. This may be due to a Data Block Number error, ECC error or phase error status change. The event entry will detail which state has changed.
Input Status	A log event will be added if the AES signal disappears or appears.

Dolby E Status (Requires Dolby E Analysis Option)

This section allows Dolby E errors to be logged.

Errors	will add an event to the event log when a Dolby E input stream is detected or lost. An event will also be added if a CRC error is detected in the Dolby E meta-data stream. If an error is detected in the Dolby E stream, it may mean that the Dolby E stream has not been synchronised with the embedded audio clocks.
Timing	will log if the Dolby E frame timing is outside the Dolby specified 'Ideal' range. A Warning event will be given if the signal is OK but slightly outside the range and an Error event if it is on an invalid line.
Common Metadata	will log any changes of the common meta-data (Program Configuration, Bit Depth, Frame Rates)
Program Metadata	will log any changed program meta-data. This can be useful for following changes to a program stream over a long period of transmission.

Logging

This section controls ALL logging events

Clear	clears all entries in the event log.
Enable	enables the logging process. If this is not checked, no events will be added to the log. This is a simple method of turning off ALL logging temporarily.
Beep	causes the Rx will emit a short tone when an Event is added to the log. Note that the beep will happen even if the Speaker is set to Mute.
SYS Errors	allows system errors to be displayed in the Event Log if they happen. If you are having problems with your Rx, checking this box can add events that can help PHABRIX determine the nature of the problem.
System Info	allows system to report additional internal messages in the Event Log if they happen. If you are having problems with your Rx instrument, checking this box can add events that can help PHABRIX determine the nature of the problem.
Save	saves the current event log to a text file in the currently specified language. The log file created, logfile.txt may be downloaded using a FTP connection.

Log Time Limit

The time when logging is enabled may be limited by time of day. Logging will start at the specified start time and end at the specified end time. The specified times must be after the current time. Un-check the box to log at all times. Logging must be enabled using the check box above for this to work.

Eye Log Setup / Log Eye Jitter

The Eye Log Setup menu allows specific Eye and Jitter events to be tracked by the Rx instrument. The events to be logged are set up on this page by checking the appropriate 'Log' check boxes.

The Eye/Jitter Logging window is accessed by clicking on the Logging menu on the monitor output task bar and selecting "Eye Log Setup".

Jitter Thresholds

The jitter level at which an event is added may be set independently for each meter. (Only one meter provided as standard) This allows you to set the maximum allowed jitter level and then test for invalid values over a period of time.

A different jitter threshold may be set for each of the 3 SDI data rates (SD/HD/3G) for both Jitter1 and Jitter2. The defaults are the maximum values specified by the SMPTE standard.

Jitter errors are detected within 200ns and so intermittent peak errors can be detected.

Eye Timings

If checked, these controls will enable logging of invalid timing values. An event will be logged if the value exceeds the valid SMPTE range and an event will be logged when the signal becomes valid again.

Eye measurements are performed using statistical calculations on the waveforms and are thus performed at a slower rate than jitter measurements. Measurements can take a few seconds to stabilise and this should be taken into account.

Eye Amplitude

If checked, these controls will enable logging of invalid amplitude or over-shoot/undershoot values. An event will be logged if the value exceeds the valid SMPTE range and an event will be logged when the signal becomes valid again.

Eye measurements are performed using statistical calculations on the waveforms and are thus performed at a slower rate than jitter measurements. Measurements can take a few seconds to stabilise and this should be taken into account.

Log ANC Status

The Log ANC Status menu allows specific ANC data events to be tracked by the Rx instrument. The events to be logged are set up on this page by checking the appropriate 'Log' check boxes.

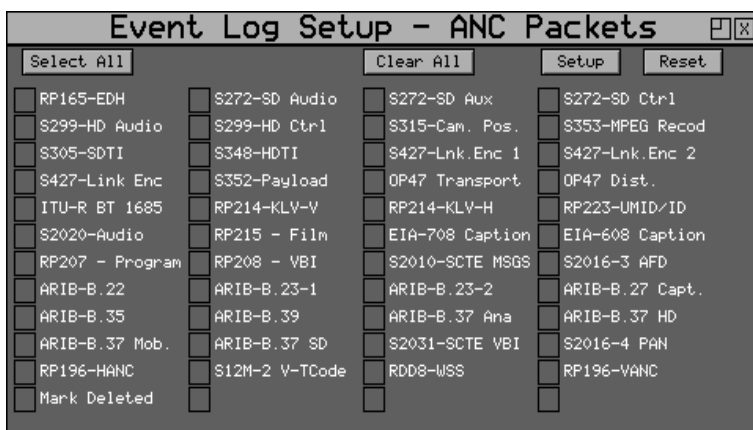

The ANC Packet Logging window is accessed by clicking on the Logging menu on the monitor output task bar and selecting "ANC Log Setup".

The Log ANC Status menu allows you to select which ANC packets to log when changes in status occur (eg Present, Checksum Error, Missing, Parity Error). Individual check-boxes are provided to determine which packet DID/SDID combinations are logged.

See the Ancillary Packet Status section for definitions of these check boxes.

- Select All Pressing this causes the check boxes for all packets to be checked.
- Select Active Pressing this causes the check boxes for all packets currently present to be checked.
- Select All Pressing this causes the check boxes for all packets to be un-checked.
- Setup This allows the user to define and name their own DID/SDID values for an ANC packet type.

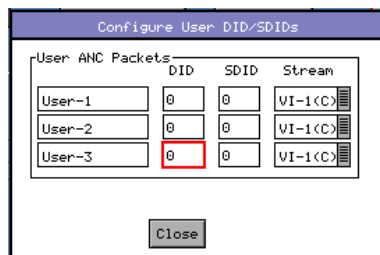

- Reset Clears the state for all packet types and thus a packet that was displayed as previously in error is shown as OK.

Monitor Output

Preset Memories

Overview

The Rx Instrument settings for Generator, Analyser and HDMI® monitor output can be saved and recalled as required.

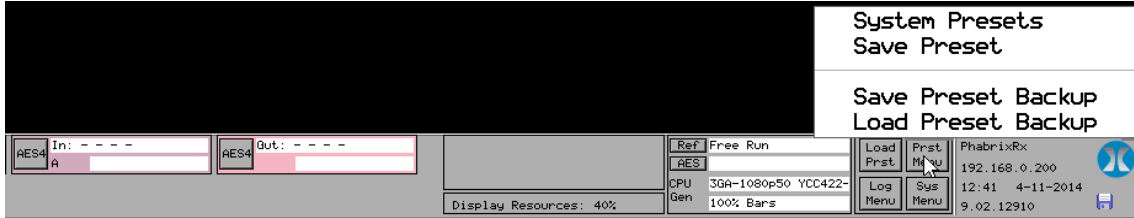

Selecting the Save Preset function will allow the current analyser, generator and HDMI settings to be saved using a named preset

Selecting the System Preset function displays the System Presets window to allow presets to be edited.

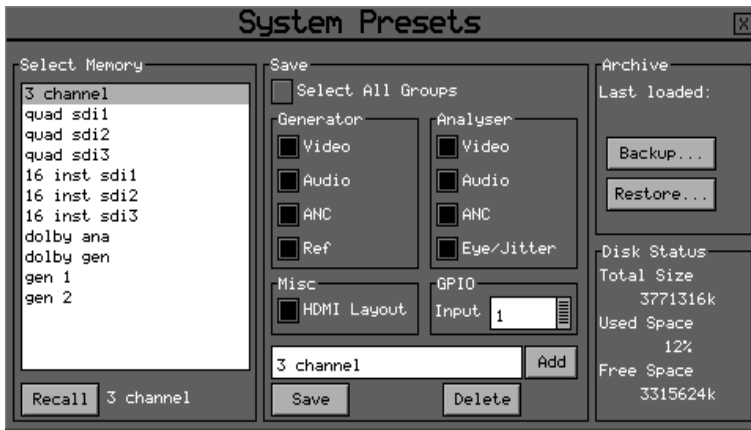

The System Preset menu displays the current settings in the Rx instrument that may be saved for future recall.

Defining Preset Content

The check boxes on the right-hand side determine what is saved in the memory. Non overlapping presets may then be combined together. For example saving generator settings or HDMI setting separately without affecting analyser settings.

Generator Section

The Generator section controls the settings of all Generator modules installed in the system, but does not include the on board test pattern generator which is considered a system-wide function with only its current state saved:

Video - if this check box is selected then the Generator video format, line rate and frame rate settings for all Generator modules will be saved as part of the preset.

Audio - if this check box is selected then the Generator Audio tone settings for Group 1, 2, 3 and 4 for all Generator modules (including 4AES modules) will be saved as part of the preset. This also covers any Dolby metadata settings.

ANC - not currently used.

Ref - if this check box is selected then the Generator Genlock settings for all Generator modules will be saved as part of the preset.

Analyser Section

The Analyser section controls the settings of all Analyser modules installed in the system:

Video - if this check box is selected then the configuration of the Picture, Waveform, Vectorscope and Video Timing instruments for all modules will be saved as part of the preset. This also saves the System Reference selection.

Audio - if this check box is selected then the configuration of the Audio Meters, Loudness Meters, Dolby Metadata Analyser, Lissajous display instruments will be saved for all Analyser modules (including 4AES modules) as part of the preset.

ANC - if this check box is selected then the configuration of the ANC Inspector and ANC Logging setup for all Analyser modules will be saved as part of the preset.

Eye / Jitter - if this check box is selected then the configuration of the Eye and Jitter instruments and Eye Log Setup settings for all Eye modules is saved as part of the preset.

Misc Section

The Misc section, HDMI check box if selected will save the screen layout as part of the preset.

GPIO Section

The drop down menu in the GPIO section allows one of fourteen different values to be allocated to the Presets. The values are a decimal representation of the 4 GPIO inputs 0, 1, 2 and 3 (rear panel 26-way D-type connection) which if taken low (0 volts or logical zero) will automatically select and display the corresponding preset.

GPIO 0 = 1

GPIO 1 = 2

GPIO 2 = 4

GPIO 3 = 8

Saving Presets

Select the memory to save settings to by moving the cursor to the 'Select Memory' list and pressing 'OK'. Use the up/down cursor keys to select the memory and then press 'OK'. The name edit field next to the memory list will be updated with the name of the selected memory.

Specify which aspects of the Rx instrument are to be saved in the memory using the check boxes on the right hand side. If you want to change the name of the memory see the section 'Renaming Memories' below before saving.

Move the cursor to the 'Save' button and press 'OK'. The text field under the Memory list will change to show the last Saved or Recalled memory.

Recalling Presets

Presets can be recalled in a range of different ways depending on which part of the Rx control system you are using:

Using the System Presets menu:

Select the memory to be recalled by moving the cursor to the 'Select Memory' list and pressing 'OK'. Use the up/down cursor keys to select the memory and then press 'OK'. The name edit field next to the memory list will be updated with the name of the selected memory.

Move the cursor to the 'Recall' button and press 'OK'. The text field under the Memory list will change to show the last Saved or Recalled memory.

Using the "Load Prst" button in the bottom left corner of the HDMI output display.

Using the preset buttons along the bottom of the HDMI output display.

Module Slot 1 (Analyzer 1 + Generator 1)				Module Slot 2 (Analyzer 2)				Module Slot 3 (Analyzer 1 + Generator 3)			
Input		Output		Input a		Input b		Input		Output	
SDI1 1080i50 YCC422-10	GEN1 100% Bars 625i50 YCC422-10	SDI2a 720p60 YCC422-10	SDI2b Absent	SDI3 1080i60 YCC422-10	GEN3 100% Bars 625i50 YCC422-10						
3 channel	quad sdi1	quad sdi2	quad sdi3	18 inst. sdi1	18inst. sdi2	18 inst. sdi3	audio sdi				

Using the Rx front panel controls.

Renaming Presets

Select the memory to be renamed by moving the cursor to the 'Select Memory' list and pressing 'OK'. Use the up/down cursor keys to select the memory and then press 'OK'. The name edit field next to the memory list will be updated with the name of the selected memory.

Move the cursor to the edit field and press 'OK'. The menu keys at the bottom of the screen will change to show text keys similar to a mobile phone. Pressing a key repeatedly will cycle through the characters for that key. Pressing a different key will move the cursor to the next position and insert the first key value for that key. The cursor left and right keys can be used to move the position of the text cursor which is where the next character will be inserted. The 'Back Space' key will delete the key to the left of the cursor. The 'Cancel' key will cancel edit mode and restore the original text. Once you have finished editing the name, press 'OK' to rename the memory.

Adding Additional Presets

To add a new memory, press the ADD button. This will use the current memory name and settings.

Clearing Presets

Select the memory to be cleared by moving the cursor to the 'Select Memory' list and pressing 'OK'. Use the up/down cursor keys to select the memory and then press 'OK'. The name edit field next to the memory list will be updated with the name of the selected memory.

Move the cursor to the 'Clear' button and press 'OK'. The memory list will show the default name for that memory. A cleared memory cannot be recalled.

Exporting Presets

Presets can be exported to a single file for backup purposes and re-imported into the internal format. This allows different sets of memories to be used for different tasks, such as command scripts. Exported memories are in a text format and so may be edited on a PC and downloaded to/from the backups directory on the Rx instrument via FTP or USB.

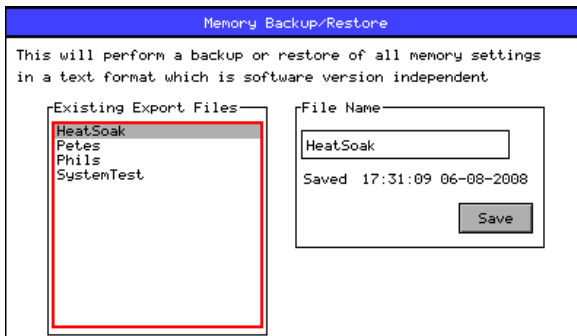

To export memories, select the Backup... button which will open a window to select the file to create. Existing files are shown and a new filename may be selected using the File Name edit box. Select the Save button to create the backup file. The filename created will have a .mem file extension.

To import memories, select the Restore... button which will open a window to select the file to import. Existing files are shown and one should be selected before the Load button is pressed. Select the Load button to import the backup file.



Note that when importing a backup file, all existing memories are deleted before the backup file is loaded so make sure that they are backed up first.

Disk Space Considerations

The disk space section shows total size of the internal flash disk and how much is used as a percentage and how much is free.

System Reference

Overview

Pressing the “Ref” button on the HDMI monitor task bar allows the Rx System Reference source to be selected.

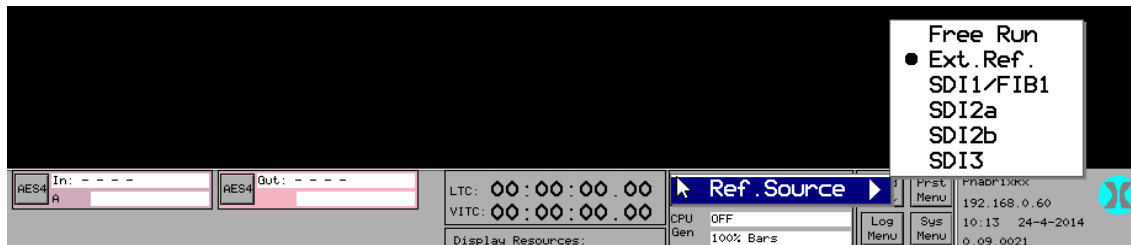

The System Reference defines the video source that the Rx system is synchronised to and affects all of the Rx outputs:

- the on-board test pattern generator output from the CPU SDI connector,
- the Generator module SDI outputs,
- the HDMI monitor output,
- the AES audio outputs,

The System Reference can be set to one of the following depending on the type of modules installed within the Rx chassis:

- Free Run - where the Rx system uses its own internal locking reference.
- Ext. Ref - where the Rx system is locked to an analogue studio reference signal connected to the “Ref” input on the CPU module.
- SDI1 - where the Rx system is locked to the SDI input on a single input Analyser module fitted in module slot 1.
- FIB1 - where the Rx system is locked to SFP optical input on a single input Analyser module fitted in module slot 1.
- SDI2a - where the Rx system is locked to the SDI “a input” on a dual input Analyser module fitted in module slot 2.
- SDI2a - where the Rx system is locked to the SDI “b input” on a dual input Analyser module fitted in module slot 2.



Note that System Reference selection can be saved as part of a preset. To do this ensure that the “Video” check box is selected in the “Analyser” section of the “System Presets” menu.

Ideally the Rx system should be locked to an external studio reference all analyser inputs should be of the same frame rate as the locking reference and synchronous to the locking reference.

External Reference can be used in most applications where a studio locking reference is available and is used to ensure that all outputs from the system are locked to the studio itself.

In applications where Dolby E, Dolby Digital or Dolby Digital Plus is being analysed or decoded, the System Reference should be set to external reference unless one is not available in which case the System Reference should be set to the specific SDI input where the Dolby digital audio is embedded.

In situations where there is no studio reference or when the SDI input is asynchronous and when decoding Dolby audio or routing embedded SDI audio channels to the AES output (4AES module) then the System Reference should be set to the SDI input containing the Dolby audio or embedded audio channels.

Note that the level of Generator jitter produced by the Rx is determined by the System Reference being used. If the Rx is locked to an SDI or SFP Fibre input, while jitter measurements are being made, then the measured jitter will include the Rx chassis's own input locking jitter plus SDI output jitter. This mode of operation may produce out of specification jitter.

Free Run should be used when using Analyser / Generator modules to perform closed loop testing especially if Eye and Jitter measurements are being made.

Admin Menus

USB Disk Connected Window

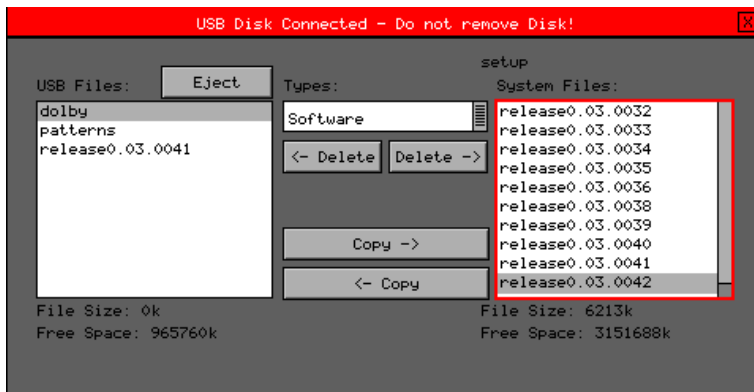

If a USB pen drive is plugged into the Rx unit, the “USB Disk Connected” window will be displayed. This allows items to be copied between the USB route directory and specific Rx folders.

The left-hand pane show the files in the route directory of the USB pen drive and the right-hand pane shows the files in the currently selected Rx folder.

The Types drop down box allows the selection of the following Rx folders:

- Software - System operating software (.ZIP)
- Screen Captures - HDMI screen captures (.BMP)
- Archives - system archive files (.MEM)
- Loudness - program audio loudness logs (.CSV)
- Pattern NTSC - 720 x 525 test patterns (.PAT)
- Pattern PAL - 720 x 625 test patterns (.PAT)
- Pattern 720 YCC - 1280 x 720 YCrCb test patterns (.YC4)
- Pattern 720 RGB - 1280 x 720 RGB test patterns (.RGB)
- Pattern 1080 YCC - 1920 x 1080 YCrCb test patterns (.YC4)
- Pattern 1080 RGB - 1920 x 1080 RGB test patterns (.RGB)
- Pattern 1035 YCC - 1920 x 1035 YCrCb test patterns (.YC4)
- Fonts - Generator Ident fonts (.TTF)
- Grabs - Video clips or frames captured using Frame Grab (.GRB)

Files can be deleted from either the USB route directory or the currently selected Rx folder using the two delete buttons:

- < - Delete permanently deletes the selected/highlighted file in the USB route directory.
- Delete -> permanently deletes the selected/highlighted file in the USB route directory.

Great care must be taken not to delete files use by the Rx operating system.

Files can be copied between the USB route directory or the currently selected Rx folder using the two copy buttons:

- Copy -> copies the currently selected/highlighted file in the USB route directory to the currently selected Rx folder.
- <-Copy copies the currently selected/highlighted file in the selected Rx folder to the USB route directory.

Before the USB pen drive is removed from the Rx unit, select the Eject button to close the session. This will prevent accidental damage or corruption of the files on the USB pen drive.

Monitor Output

Browser Control

Browser Control

Overview

The Rx 1000 and Rx 500 instruments can be controlled via a web browser that accesses the built-in web server. To connect to the Rx instrument, find out the IP address (displayed in the bottom right corner of the Monitor output and in the System - Network menu) and Enter it into the web browser.



Rx 500/1000 Downloads

[HDMI](#)

Remotely control and view HDMI output here.

[Event Log](#)

Event Log is stored here.

[Status](#)

Status is stored here.

[Screen Dumps](#)

Screen dump images are stored here.

Browser operation has been tested using Firefox, Opera, Safari, Chrome and Internet Explorer but should work with any browser which allows JavaScript.

HDMI Link

The “HDMI” link displays a copy of the HDMI output in the browser window.

Clicking on the position where a menu box appears on the browser HDMI display will control the corresponding menu on the actual Rx HDMI menu. This browser display will take a few seconds to update.

See chapter 3 for full details of each of the menus.

Event Log Link

The “Event Log” link on the right hand side may be selected to fetch the current Event Log from the Rx instrument.

Status Link

The “Status” link on the right hand side may be selected to fetch the current instrument status in XML format. It can be saved to a local PC for further processing. The control IDs displayed in the XML file are determined by the file “/mnt/mmc/xmlformat.ini” which may be edited by the user although note that it should be backed up as it will be over-written when software updates take place.

Screen Dumps Link

The “Screen Dumps” link displays a further page allowing screen dumps and report files (Command script option) to be viewed.



PHABRIX[®]
broadcast excellence

A Glossary

Glossary

Glossary of Terms

3G-SDI	is a single 2.970 Gbit/s serial link (standardized in SMPTE 424M) that will replace the dual link HD-SDI (is standardized in SMPTE 372M).
Advanced EyeMonitoring	is the Eye Monitoring functionality provided by the Rx Range.
AES	Audio Engineering Society
AES3-2003	standard for digital audio — Digital input-output interfacing —Serial transmission format for two channel linearly represented digital audio data.
AFD	(Active Format Description) is a standard set of codes that can be sent in the MPEG video stream or in the baseband SDI video signal that carries information about their aspect ratio and active picture characteristics as defined by SMPTE S2016.
Alignment Jitter	refer to artefacts above the specified threshold frequencies of (1 kHz for SD-SDI signals and 100 kHz for HD-SDI signals). Typically video equipment cannot tolerate Alignment Jitter which cause decoding errors due to incorrect sampling of the data stream because the SDI Clock transition occurs on the edge of the data sample instead of in the centre of the data sample.
ANC	(Ancillary Data) refers to a means which by non-video information (such as audio, EDH and other forms of essence and metadata) are embedded within the serial digital interface. There are 2 types if Ancillary Data, HANC (Horizontal Ancillary Data) and VANC (Vertical Ancillary Data). See SMPTE 291M: Ancillary Data Packet and Space Formatting.
ARIB-B.22	this is the ARIB defined Sub information data packet in the VANC space.
ARIB-B.23-1	this is the ARIB defined user data 1 packet in the VANC space.
ARIB-B.23-2	this is the ARIB defined user data 2 packet in the VANC space.
ARIB-B.27 Capt.	this is the ARIB defined caption data in the VANC space.
ARIB-B.35	this is the ARIB defined trigger signal data packet for data broadcasting.
ARIB-B.39	this is the ARIB defined inter-stationary control data packet in the VANC space.
ARIB-B.37	this is the ARIB defined analogue signal data in the VANC space.
ARIB-B.37 HD	this is the ARIB defined HD data packet in the VANC space.
ARIB-B.37 Mob	this is the ARIB defined closed captioning information data packet.
ARIB-B.37 SD	this is the ARIB defined SD data packet in the VANC space.
ASI	(Asynchronous Serial Interface) is a streaming data format which often carries an MPEG Transport Stream (MPEG-TS). An ASI signal can carry one or multiple SD, HD or audio programs that are already compressed.
Audio Jack	this is the front panel ¼ inch head phone socket used for local audio monitoring.
Bar Data	defines the extent of the image within the coded frame as part of the AFD (active format description as defined by SMPTE S2016).

Chassis	is the physical enclosure of the Rx range that is used to mount various hardware modules.
CPU	Central Processor Unit
CRC	(cyclic redundancy check) is an error-detecting code commonly used in digital networks and storage devices to detect accidental changes to raw data. Blocks of data entering these systems get a short check value attached, based on the remainder of a polynomial division of their contents; on retrieval the calculation is repeated, and corrective action can be taken against presumed data corruption if the check values do not match.
DBN	(Data Block Number) is a data word within the ANC Data. See DID for more information.
DID	(Data Identifier) – is the first data word with in the ANC Data that defines the type of data contained within the packet. This word is followed by either a ‘Secondary Data Identifier (SDID) or a Data Block Number (DBN), followed by a Data Count (DC). After the Data Count word are 0 - 255 (inclusive) User Data Words (UDW), followed by a Checksum (CS) word.
Dolby Digital	(AC-3) is a ‘perceptual audio’ system for digital audio that allows the reduction of data needs to deliver high-quality sound. This system was developed primarily for DTV, DVD and HDTV.
Dolby Digital Plus	(E-AC-3) is a more advanced version of Dolby Digital that provides a more efficient encoding algorithm that provides enough bandwidth that allows up to 20 channels of audio (for a primary programme (Programme 1) and optional ancillary programs that can be delivered at much lower bit rates than Dolby Digital
Dolby E	is an audio encoding and decoding technology developed by Dolby Laboratories that allows up to 8 channels of audio to be compressed into a digital stream that can be transferred between compatible devices and stored on a standard stereo pair of audio tracks.
DVI	Digital Visual Interface
EDH	(Error Detection and Handling) protocol is an optional but commonly used addition to the Standard Definition-Serial Digital Interface (SDI) standard. This protocol allows an SD-SDI receiver to verify that each field of video is received correctly.
EIA-708 Caption	this is the EIA standard defined closed caption data for HD-SDI in VANC space.
EIA-608 Caption	this is the EIA standard defined closed caption data for SD SDI 525i (NTSC) in VANC space.
FPGA	a field-programmable gate array (FPGA) is an integrated circuit designed to be configured by the customer or designer after manufacturing.
Function Buttons	these are the set of 8 buttons below the Instrument Display on the Sx and Rx Ranges that are used to select the Instrument Display menu options.
GPI	General Purpose Input)
Graticule	this is the scale displayed on an oscilloscope, vector scope or waveform monitor that provides a visual indication of the signal amplitude, time base and phase relationship.

HANC	(Horizontal Ancillary Data) is non-video data that is transmitted within the horizontal blanking interval of the video data. See ANC for further information.
HDMI®	(High-Definition Multimedia Interface) is a compact audio/video interface for transferring uncompressed digital audio/video data from a HDMI-compliant device (“the source” or “input”) to a compatible digital audio device, computer monitor, video projector, and digital television.
IEC 60268-10	defining Type I PPM style audio meters typically used by German broadcasters and Type II PPM style audio meters typically used by UK broadcasters.
IEC 60268-17	defining VU style audio meters typically used by American and Australian broadcasters.
Input Status Bar	is the bottom part of the Monitor Output display that shows the format and status of the input signals currently connected to the Rx chassis.
Instrument Display	is the TFT monitor available on the Sx Range of products and on the Rx 2000.
Integrated Loudness	covering the duration of a program or segment as defined in ITU-R Recommendations 128.
ITU-R Rec 128	defining the measurement in terms of Loudness Units (LU) and Loudness Units Full Scale (LUFS) over different time periods.
ITU-R Rec. BS.645	defining VU style audio meters typically used by French broadcasters.
ITU-R BT 1685	this is the ITU-R BT 1685 defined Structure of inter-station control data packets.
LTC/GPIO/Analogue	(Longitudinal Time Code/General Purpose Input Output)
MADI	(Multichannel Audio Digital Interface) or AES10 is an Audio Engineering Society (AES) standard electronic communications protocol that defines the data format and electrical characteristics of an interface that carries multiple channels of digital audio.
Module	this is a factory fitted hardware component for the Rx series chassis.
Momentary Loudness	covering the shortest timescale of 400ms as defined in ITU-R Recommendations 128.
Monitor Output	The Rx range of products provide an HDMI (and optional SDI) monitor output that can display up to 16 instrument panels at 1920 x 1080. This Monitor output display can display the pre-sets selected by the “Pre-set Buttons” and can be controlled by a USB mouse and keyboard connected to the Rx unit.
Navigation Buttons	These are the up, down, left, right arrow buttons available on the Sx and Rx Ranges.
OLED	Organic Light-Emitting Diode
OP47 Transport	this is the Free TV Operational Practice OP-47 defined transport of Closed Caption/Subtitling data in the VANC space.
OP47 Dist.	this is the Free TV Operational Practice OP-47 defined distribution of Closed Caption/Subtitling data in the VANC space.
PHRXKT1	is the rack mounting kit for the RX 1000 unit.
PHRXKT2	s the rack mounting kit for the RX 2000 unit.

PHRXM-A	is the Dual Input, single Analyser module.
PHRXM-AE	is the Dual Input, single Analyser module with eye/jitter functionality.
PHRXM-AG	is the single input Analyser module + Generator module.
PHRXM-AGE	is the single input Analyser module with eye/jitter functionality + Generator module.
PHRXM-DD	Dolby-E decode module
PHRXO-3G	3G-SDI software option providing support for SMPTE 424M
PHRXO-EA	advance eye pattern analyser software option
PHRXO-SD	SDI Data viewer software option
PHRXO-BD-A	basic Dolby analysis software option
PHRXO-BD-G	Dolby Generator software option
PHRXO-4LOU	4 channel loudness Monitor software option
PHABRIX Rx 500	is a 1U height half rack mount Rasteriser which is small and light enough to fit a variety of applications from camera shading in OB environments or studio editing suites as well as manufacturing R&D departments. The Rx 500 has two input slots with 4 simultaneous inputs. All inputs are switchable and each can be independently controlled as picture or analysis instruments on an HDMI® monitor Output.
PHABRIX Rx 1000	is a 1U height 19" (482cm) rack mount Rasterizer with the ability to monitor up to 8 simultaneous inputs with loop through and is powerful enough to support simultaneous display of instruments across each module on HDMI® monitor Output. All inputs are switchable and each can be independently controlled as picture or analysis instruments with central control and report logging.
PHABRIX Rx 2000	is a 2U height 19" (482cm) rack mount Rasterizer with 2 on-board displays and the ability to monitor up to 8 simultaneous inputs with loop through and is powerful enough to support simultaneous display of instruments across each module on HDMI® monitor Output. All inputs are switchable and each can be independently controlled as picture or analysis instruments with central control and report logging.
PHABRIX SxA	is a 3G-SDI , HD-SDI and SD-SDI handheld SDI test signal generator, analyser and monitor supporting AES audio.
PHABRIX SxD	is a 3G-SDI , HD-SDI and SD-SDI handheld SDI test signal generator, analyser and monitor supporting dual link.
PHABRIX SxE	is a 3G-SDI , HD-SDI and SD-SDI handheld SDI test signal generator, analyser and monitor supporting eye and jitter measurement.
Pre-set Buttons	These are the set of 8 buttons below the Video Confidence display on the Rx 2000 that are used to select pre-defined inputs for display.
PSU	Power Supply Unit
Random Jitter	refers to artefacts caused by random events or processes such as thermal or shot noise that cause small amplitude variations in the clock edge position or could cause large signal amplitude variations, though these typically would be infrequent.

Rasteriser	is an electronic device used to display (either as picture or waveform) the video/audio data in a 3G-SDI, HD-SDI and SD-SDI stream. Typically a Rasteriser will display multiple output forms of the same input data stream.
RDD8-WSS	this is the SMPTE defined wide screen switching data packet in the VANC space.
RP165-EDH	this is the SMPTE RP165-EDH packet containing EDH (error data handling) and CRC (cyclic redundancy counts). This only appears on SD-SDI signals.
RP196-HANC	this is the SMPTE defined recommended practice Time Code data packet in HANC space.
RP196-VANC	this is the SMPTE defined recommended practice Vertical Timecode data packet in VANC space.
RP207 Program	this is the SMPTE RP207 defined program description data packet in VANC space.
RP208 – VBI	this is the SMPTE defined recommended practice VBI Data (vertical blanking interval data) in VANC space.
RP214-KLV-V	this is the SMPTE defined KLV Metadata transport in VANC space.
RP214-KLV-H	this is the SMPTE defined KLV Metadata transport in HANC space.
RP215 – Film	this is the SMPTE defined recommended practice data packe for film codes in VANC space.
RP233-UMID/ID	this is the SMPTE defined UMID (Unique Material Identifier) in VANC space
S272-SD Audio	this is the SMPTE 291M defined SD audio data in HANC space.
S272-SD Aux	this is the SMPTE 291M defined SD auxiliary data in HANC space.
S272-SD Ctrl	this is the SMPTE 291M defined SD control data in HANC space.
S299-HD Audio	this is the SMPTE 291M defined HD audio data in HANC space.
S299-HD Ctrl	this is the SMPTE 291M defined HD control data in HANC space.
S305-SDTI	this is the SMPTE 291M defined SDTI transport data packet in active frame space.
S348-HDTI	this is the SMPTE 291M defined HD-SDTI transport
S315-Cam. Pos	this is the SMPTE 291M defined camera position data in HANC and VANC space.
S353-MPEG Recod	this is the SMPTE 291M defined MPEG recoding data in HANC and VANC space.
S427-Lnk. Enc 1	this is the SMPTE S427 defined link encryption data packet.
S427-Lnk. Enc 2	this is the SMPTE S427 defined link encryption data packet.
S427-Link Enc	this is the SMPTE S427 defined link encryption data packet.
S2010-SCTE MSGS	this is the SMPTE S2010 defined standardized API message data in VANC space.
S2016-3 AFD	this is the SMPTE S2016 defined standardized AFD (active format description) and Bar data packet (defining active area of image).
S2016-4 PAN	this is the SCTE S2016 standard defined pan and scan data packet.

S2020-Audio	this is the SMPTE S2020 defined standardized data packet defining the encoding for a Dolby stereo or a multi-channel surround group of audio channels.
S2031-SCTE VBI	this is the SCTE S2031 standard defined VBI (vertical blanking interval) data packet for closed captioning.
SDI	(Serial Digital Interface) capable of transferring SD or HD broadcast video and broadcast audio between compatible devices.
SDID	(Secondary Data Identifier) is a data word within the ANC Data packet. See DID for more details.
Short Term Loudness	covering the intermediate timescale of 3 seconds as defined by ITU-R Recommendations 128.
SMPTE	(Society of Motion Picture & Television Engineers)
SMPTE RP211	Implementation of 24P, 25P and 30P Segmented Frames for 1920 x 1080 Production Format
SMPTE 259M	Implement a SMPTE 259M Serial Digital Interface Using SMPTE HOTLink™ and CY7C9235/9335
SMPTE 260M	Television - 1125/60 High-Definition Production System - Digital Representation and Bit-Parallel Interface
SMPTE 274M	High Definition (HD) Image Formats for Television Production
SMPTE-276M	Television - Transmission of AES-EBU Digital Audio Signals Over Coaxial Cable
SMPTE 292M	Bit-Serial Digital Interface for High-Definition Television Systems
SMPTE 296M	1280 × 720 Scanning, Analogue and Digital Representation and Analogue Interface
SMPTE 297-2006	Serial Digital Fiber Transmission System for SMPTE 259M, SMPTE 344M, SMPTE 292 and SMPTE 424M Signals
SMPTE 352	Payload Identification Codes for Serial Digital Interfaces — Amendment 1
SMPTE 424M	3 Gb/s Signal/Data Serial Interface
SMPTE 425-B	Mapping of 2 x SMPTE 292M HD SDI interfaces. Level-B can carry a Dual Link 1.485 Gb/s payload or two HD 1.485 Gb/s payloads..
SMPTE 425M-A	Direct mapping of source image formats
SMPTE 428-9	D-Cinema Distribution Master – Image Characteristics
TFT	(Thin Film Transistor) is a type of LCD (Liquid Crystal Display) monitor.
Timing Jitter	refers to a short-term time interval error above a low frequency threshold of 10 Hz (as defined in the SMPTE standards for SDI signals).
UDW	(User Data Words) contains the actual “payload” data of the ANC Data package. See DID for more information.
UI	(Unit Interval) is time between consecutive clock cycles used to sample the SDI data stream. The UI measurement is used for Eye Pattern measurement.
UMID	(Unique Material Identifier) is a special code that is used to identify audio-visual (AV) materials.

- VANC (Vertical Ancillary Data) is non-video data that is transmitted within the vertical blanking interval of the video data. See ANC for further information.
- Video Confidence Display is the TFT monitor available on the Rx 2000 that allows the picture to be displayed for the selected input.
- Wander refers to a long-term time interval error, ie artefacts below 10 Hz. Typically all video equipment has the tendency to cause wander over a long period, the display of these artefacts are not easily displayed in a meaningful way but are better logged as errors that exceed tolerances over a long period.

Glossary



PHABRIX[®]
broadcast excellence

B Specification

Specification

Rx Platform

Overview

The 'Rx platform' has been designed to serve the varied test and measurement needs of the broadcast industry. PHABRIX has developed not a single product in the traditional sense but a modular system from which specific broadcast client requirements can be satisfied.



The Rx platform allows a flexible approach to test and measurement on a new technological platform designed for longevity. The system has been created to allow broadcast engineers to specify features according to the complexity of the required test and measurement application by simply adding additional modules and software licenses to their chosen core chassis.

Adding modules is like adding independent new instruments, each module providing a dedicated set of instruments for the task required.

The Rx Platform is available in a choice of chassis types:

Rx2000 – a unique audio video monitoring solution combining front panel instrumentation, via dual TFT screens, and integrated full range stereo speakers. Unique 2U tapered 'tilt-in-bay' engineering with four Rx module bays.

Rx1000 rasterizer – a compact 1U, 19" rack-mount chassis with OLED display interface with four Rx module bays.

Rx500 rasterizer – a compact 1U, ½ rack width chassis with OLED display interface with two Rx module bays.

Specification

Rx 1000 Rasteriser

Description

The Rx1000 is a 1U rack mounted instrument that provides the following:

OLED display to allow the monitoring inputs and the selection of Monitor display, Analyzer and Generator presets.

Rasterised HDMI/SDI outputs to allow up to 16 individual instrument panels (windows) to be displayed on a single DVI 1920 x 1080 resolution monitor. ideal for outside broadcast facilities and engineering bays where space is at a premium.

Individual input selection, for instant confidence and monitoring of feeds, using dedicated source selection buttons.

Control via front panel controls, for in-bay use and remotely via a network connection using a web browser.

Front panel audio monitoring, provided by high quality speakers and/or a head phone socket, to allow the monitoring of the selected Audio channel.

4 Module slots allowing the installation of Analyzer and Generator modules.

Environmental Requirements

Operating Temperature	0-40 °C
Operating Humidity	<85% RH (no condensation)
Power Requirements	AC 90-250V 50/60Hz 16W max
Height	1U, 1.75inch, 4.4cm
Width	19inch, 48.2cm
Depth	6.7inch, 17cm
Weight	3.75lbs, 1.7kg

Dimensions

Front Panel Dimensions

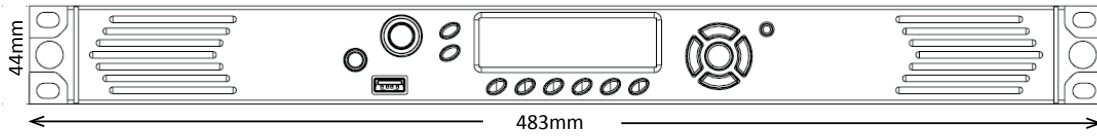

Top Panel Dimensions

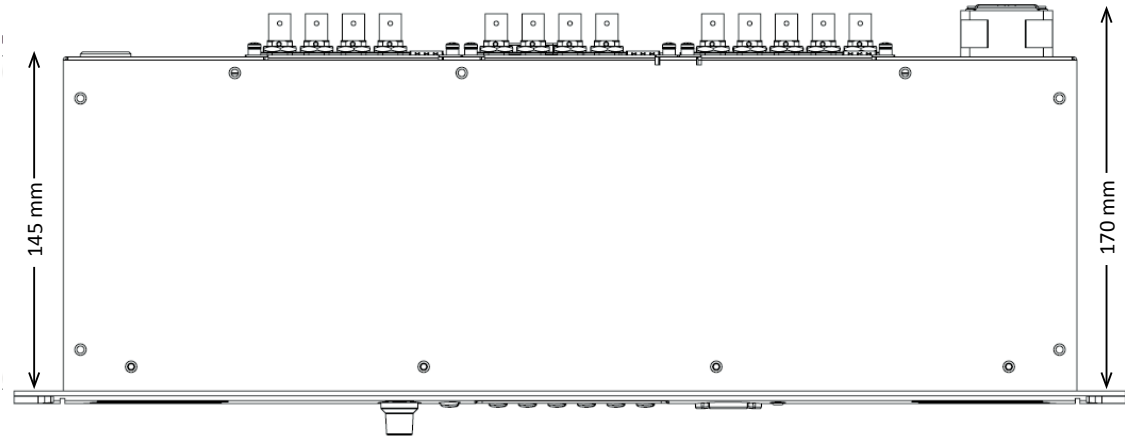

Side Panel Dimensions

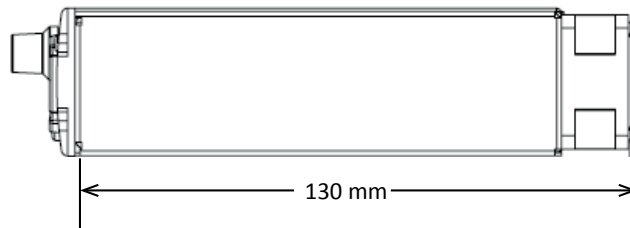

Front Panel



The front panel provides access to the OLED Display and menu system to allow preset Monitor display, Analyzer and Generator settings to be recalled.

Front Panel Display

Display Type	OLED display
Quantity	1
Backlight	Variable brightness
Screen Saver	Reduces brightness after user adjustable time.

Headphone Output

Connector	1/4 Inch Stereo Jack
Level	Adjustable
Quantity	1 (front mounted)
Purpose	Local monitoring of audio

Rear Panel



The rear panel provides the Rx instrument's connections via the CPU module and the installed Analyzer or Generator modules. See the "Modules" section for details of the different module types.

Power Connection

Connector	4-pin XLR, Male
Voltage	12V +/- 5% AC. (DC Power adapter provided)

External Locking Reference

Label	REF
Purpose	This allows the Rx instrument to be locked to a studio reference.
Input Signal	Tri-level or Bi-Level (black burst) syncs 50/59.94/60Hz
Connector	BNC
Input Impedance	75 Ω terminated
Input Return Loss	> 40dB to 6MHz (typical)
Maximum Input voltage	+/- 2V
Specification	Tri-level syncs (SMPTE 274M and SMPTE 296M) 600 mV pk-pk PAL Black Burst (ITU 624-4/SMPTE 318) 1V pk-pk, Composite NTSC (SMPTE 170M) 1V pk-pk

AES Input

Label	AES IN
Connector	BNC
Input Impedance	75 Ω terminated
Max Input Voltage	+/- 2V
Sample Rates	The input has a sample rate converter and so will accept any sample rate from 32kHz to 192kHz.
Specification	Conforming to AES3-2003 and SMPTE-276M

SDI Out

Label	SDI OUT
Purpose	Is an basic SD-SDI or HD-SDI signal generator output that provides test signals generated by the on-board Generator. This output can also be used to provide an SDI monitor output tied to the HDMI® monitor output.
Connector	BNC
Input Impedance	75 Ω terminated
Output Level	+/- 400mV
Test Signals	100% Colour Bars, 75% Colour Bars. or Check Field Pathological

HDMI

Connector	Type A
Purpose	Monitor output that allows up to 16 individual instrument panels (or windows) to be displayed.
Video Format	1920 x 1080 RGB 4:4:4
Audio Format	4 x PCM stereo audio at 48 KHz

Local Control

USB	USB 2
Purpose	Keyboard and mouse control of the HDMI® monitor output of instrument and software installation.
Connector	USB Type A
Quantity	3 (1 x front mounted, 2 x rear mounted)

Networking

Ethernet	IEEE 802.3 10/100Mb/s (10/100-base-T connection)
Purpose	Browser control of instrument and FTP access to system files and allowing the Rx instrument to be connected into a network and accessed via TCP/IP so that it can be controlled remotely.
Connector	RJ-45

GPIO

Connector 26-way D-type
 Purpose Provides a GPI (general purpose input), LTC control and analogue audio connections.

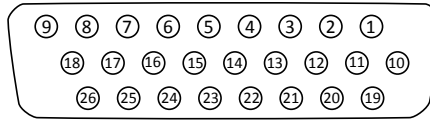

- 1 Data Terminal Equipment - Transmit (TX) (RS-232 compatible)
- 2 Data Terminal Equipment - Receive (RX) (RS-232 compatible)
- 3 Data Terminal Equipment - Request to Send (RTS)
- 4 Data Terminal Equipment - Clear to Send (CTS)
- 5 Longitudinal Timecode (LTC) - Receive (RX) P (RS-422 compatible)
- 6 Longitudinal Timecode (LTC) - Receive (RX) N (RS-422 compatible)
- 7 Audio Line Out - Right (1V peak-to-peak analogue, full scale 0dBFS)
- 8 Audio Line Out - Left (1V peak-to-peak analogue, full scale 0dBFS)
- 9 5 Volt, current-limited GPIO supply for 'open drain' input/outputs.
- 10-18 Signal ground / 0 Volt
- 19 GPIO - 0 (open drain with 10K ohm pull-up to +5 Volts)
- 20 GPIO - 1 (open drain with 10K ohm pull-up to +5 Volts)
- 21 GPIO - 2 (open drain with 10K ohm pull-up to +5 Volts)
- 22 GPIO - 3 (open drain with 10K ohm pull-up to +5 Volts)
- 23 GPIO - 4 (open drain with 10K ohm pull-up to +5 Volts)
- 24 GPIO - 5 (open drain with 10K ohm pull-up to +5 Volts)
- 25 GPIO - 6 (open drain with 10K ohm pull-up to +5 Volts)
- 26 GPIO - 7 (open drain with 10K ohm pull-up to +5 Volts)

Note that GPIO 0, 1, 2 & 3 can be used to select specific system memory presets, for example to remotely control the Rx unit using contact closure or logic levels. See the "Preset" section in chapter 3 for details.

GPIO 0	GPIO 1	GPIO 2	GPIO 3	
low	high	high	high	Preset 1
high	low	high	high	Preset 2
low	low	high	high	Preset 3
high	high	low	high	Preset 4
low	high	low	high	Preset 5
high	low	low	high	Preset 6
low	low	low	high	Preset 7
high	high	high	low	Preset 8
low	high	high	low	Preset 9
high	low	high	low	Preset 10

Note also that GPIO 4, 5, 6 & 7 output tally is set low when an error state occurs on an analyser (4 = Analyser 1, 5 = Analyser 2, 6 = Analyser 3 and 7 = Analyser 4).

GPIO 4	GPIO 5	GPIO 6	GPIO 7	
low	high	high	high	Analyser Slot 1
high	low	high	high	Analyser Slot 2
high	high	low	high	Analyser Slot 3
high	high	high	low	Analyser Slot 4

Specification

Rx500 Rasteriser

Description

The Rx500 is a 1U, half rack width instrument (available with optional rack mount kit) that provides the following:

- OLED display to allow the monitoring inputs and the selection of Monitor display, Analyzer and Generator presets.

- Rasterised HDMI/SDI outputs to allow up to 16 individual instrument panels (windows) to be displayed on a single DVI 1920 x 1080 resolution monitor. ideal for outside broadcast facilities and engineering bays where space is at a premium.

- Individual input selection, for instant confidence and monitoring of feeds, using dedicated source selection buttons.

- Control via front panel controls, for in-bay use and remotely via a network connection using a web browser.

- Front panel head phone socket to allow the monitoring of the selected Audio channel.

- 2 Module slots allowing the installation of Analyzer and Generator modules.

Environmental Requirements

Operating Temperature	0-40 °C
Operating Humidity	<85% RH (no condensation)
Power Requirements	AC 90-250V 50/60Hz 16W max
Height	1U, 1.75inch, 4.4cm
Width	8.5 inch, 24.1 cm
Depth	6.7inch, 17cm
Weight	1.65lbs, 0.75kg

Dimensions

Front Panel Dimensions

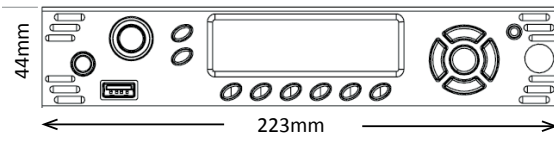

Top Panel Dimensions

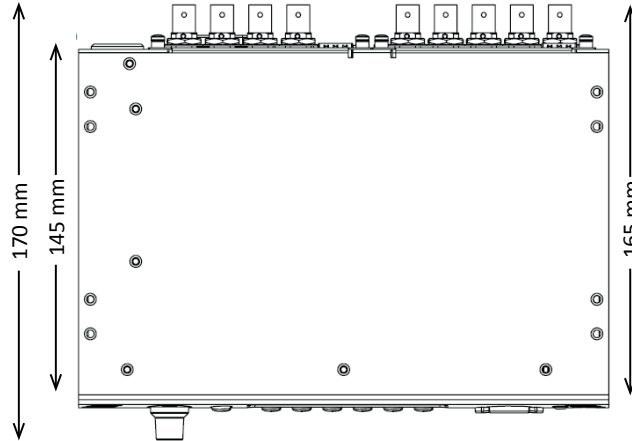

Side Panel Dimensions

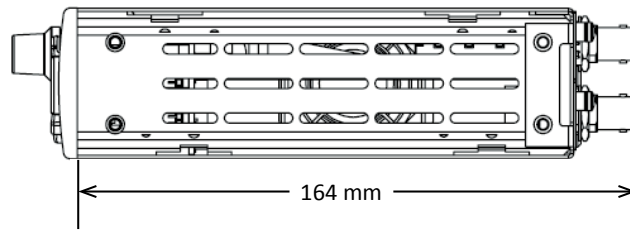

Front Panel

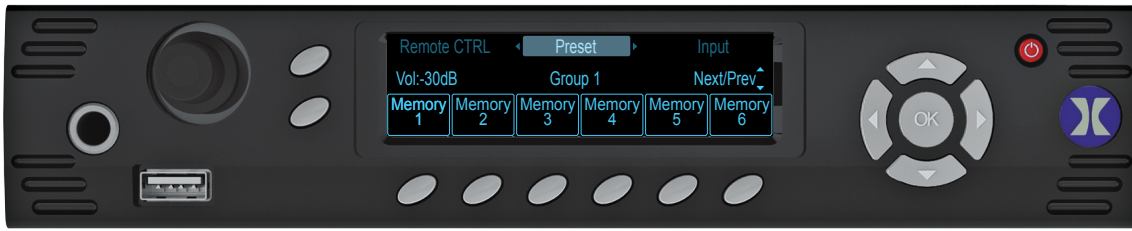

The front panel provides access to the LCD Display and menu system to allow preset Monitor display, Analyzer and Generator settings to be recalled.

Front Panel Display

Display Type	LED display
Quantity	1
Backlight	Variable brightness
Screen Saver	Reduces brightness after user adjustable time.

Headphone Output

Connector	1/4 Inch Stereo Jack
Level	Adjustable
Quantity	1 (front mounted)
Purpose	Local monitoring of audio

Rear Panel

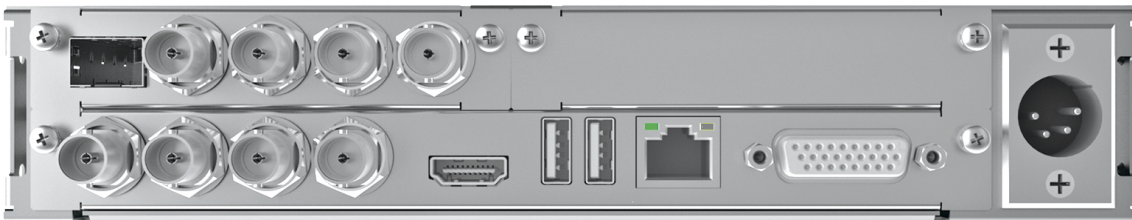

The rear panel provides the Rx instrument's connections via the CPU module and the installed Analyzer or Generator modules. See the Modules section for details of the different module types.

Power Connection

Connector	4-pin XLR, Male
Voltage	12V +/- 5% AC. DC Power adapter provided

External Locking Reference

Label	REF
Purpose	This allows the Rx instrument to be locked to a studio reference.
Input Signal	Tri-level or Bi-Level (black burst) syncs 50/59.94/60Hz
Connector	BNC
Input Impedance	75 Ω terminated
Input Return Loss	> 40dB to 6MHz (typical)
Maximum Input voltage	+/- 2V
Specification	Tri-level syncs (SMPTE 274M and SMPTE 296M) 600 mV pk-pk PAL Black Burst (ITU 624-4/SMPTE 318) 1V pk-pk, Composite NTSC (SMPTE 170M) 1V pk-pk

AES Input

Label	AES IN
Connector	BNC
Input Impedance	75 Ω terminated
Max Input Voltage	+/- 2V
Sample Rates	The input has a sample rate converter and so will accept any sample rate from 32kHz to 192kHz.
Specification	Conforming to AES3-2003 and SMPTE-276M

SDI Out

Label	SDI OUT
Purpose	Is an basic SD-SDI or HD-SDI signal generator output that provides test signals generated by the on-board Generator. This output can also be used to provide an SDI monitor output tied to the HDMI® monitor output.
Connector	BNC
Input Impedance	75 Ω terminated
Output Level	+/- 400mV
Test Signals	100% Colour Bars, 75% Colour Bars. or Check Field Pathological

HDMI

Connector	Type A
Purpose	Monitor output that allows up to 16 individual instrument panels (or windows) to be displayed.
Video Format	1920 x 1080 RGB 4:4:4
Audio Format	4 x PCM stereo audio at 48 KHz

Local Control

USB	USB 2
Purpose	Keyboard and mouse control of the HDMI® monitor output of instrument and software installation.
Connector	USB Type A
Quantity	3 (1 x front mounted, 2 x rear mounted)

Networking

Ethernet	IEEE 802.3 10/100Mb/s (10/100-base-T connection)
Purpose	Browser control of instrument and FTP access to system files and allowing the Rx instrument to be connected into a network and accessed via TCP/IP so that it can be controlled remotely.
Connector	RJ-45

GPIO

Connector

26-way D-type

Purpose

Provides a GPI (general purpose input), LTC control and analogue audio connections.

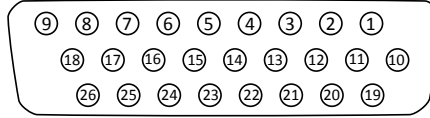

- 1 Data Terminal Equipment - Transmit (TX) (RS-232 compatible)
- 2 Data Terminal Equipment - Receive (RX) (RS-232 compatible)
- 3 Data Terminal Equipment - Request to Send (RTS)
- 4 Data Terminal Equipment - Clear to Send (CTS)
- 5 Longitudinal Timecode (LTC) - Receive (RX) P (RS-422 compatible)
- 6 Longitudinal Timecode (LTC) - Receive (RX) N (RS-422 compatible)
- 7 Audio Line Out - Right (1V peak-to-peak analogue, full scale 0dBFS)
- 8 Audio Line Out - Left (1V peak-to-peak analogue, full scale 0dBFS)
- 9 5 Volt, current-limited GPIO supply for 'open drain' input/outputs.
- 10-18 Signal ground / 0 Volt
- 19 GPIO - 0 (open drain with 10K ohm pull-up to +5 Volts)
- 20 GPIO - 1 (open drain with 10K ohm pull-up to +5 Volts)
- 21 GPIO - 2 (open drain with 10K ohm pull-up to +5 Volts)
- 22 GPIO - 3 (open drain with 10K ohm pull-up to +5 Volts)
- 23 GPIO - 4 (open drain with 10K ohm pull-up to +5 Volts)
- 24 GPIO - 5 (open drain with 10K ohm pull-up to +5 Volts)
- 25 GPIO - 6 (open drain with 10K ohm pull-up to +5 Volts)
- 26 GPIO - 7 (open drain with 10K ohm pull-up to +5 Volts)

Note that GPIO 0, 1, 2 & 3 can be used to select specific system memory presets, for example to remotely control the Rx unit using contact closure or logic levels. See the "Preset" section in chapter 3 for details.

Specification

Rx Modules

Single Analyzer, Dual Input

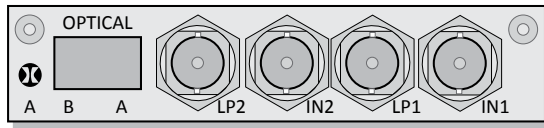

The PHRXM-A module allows 2 connected SDI or Optical video signals to be present continuously and switched for analysis or display by the single analyzer channel.

Analyzer SDI Inputs

Label	IN1 and IN2
Supported standards	SD-SDI or HD-SDI. See Supported formats
Connector	BNC
Input Impedance	75 Ω terminated
Input Return Loss	Better than 15dB (5MHz-1485MHz) and 10dB (1485MHz-2970MHz)
Maximum Input Voltage	+/- 2V

Analyzer SDI Outputs

Label	LP1 and LP2
Purpose	Loop through of IN1 and IN2
Connector	BNC
Output Impedance	75 Ω terminated

Analyzer Optical Inputs

Label	OPTICAL A and B
Purpose	To provide 2 optical video/audio inputs
Type	SFP Optical Dual Receiver Module (option PHSFP-2R30-1310)
Specifications	SMPTE 424M, SMPTE 292M, and SMPTE 259M

Analyzer Functionality

With the module installed the Analyzer menu (see chapter 2 for details) allows the follow monitoring to be displayed:



The Picture viewer is provided to allow you to monitor the selected input to give confidence that the signal is present, is the correct subject (or feed), it is moving and looks OK.

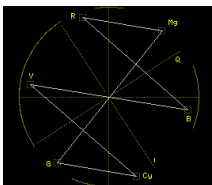

The Vectorscope allows you to check the hue, saturation and phase of the selected input. Controls are provided to allow you to select the line (s) to be monitored (ideal for checking any embedded test pattern in the selected feed), the field to be checked and the graticule scale.

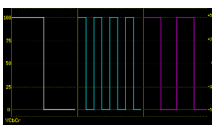

The Waveform Monitor allows you to check the levels of the video content are correct. Controls are provided to allow you to select the waveform (YCbCr, Y, Cb, Cr, GBR, Red, Green or Blue), the horizontal and vertical scale and the line(s) to be monitored.

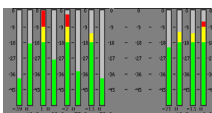

The Audio monitor (16 embedded audio channels, 48 kHz, 20-bit (SD-SDI) 24-bit (HD-SDI)) allows you to check the audio levels of the selected input. In addition to the visual display, the selected audio channel can be monitored via the front panel loud speakers or head phone jack.

Single Analyzer, Dual Input, Physical Layer Measurement

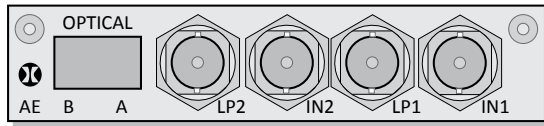

The PHRXM-AE module allows 2 connected SDI or Optical video signals to be present continuously and selected for analysis or display by the single analyzer channel.

Analyzer SDI Inputs

Label	“IN1” and “IN2”
Purpose	Analyzer Inputs
Supported standards	SD-SDI or HD-SDI. See Supported formats
Connector	BNC
Input Impedance	75 Ω terminated
Input Return Loss	Better than 15dB (5MHz-1485MHz) and 10dB (1485MHz-2970MHz)
Maximum Input Voltage	+/- 2V

Analyzer SDI Outputs

Label	LP1 and LP2
Connector	BNC
Output Impedance	75 Ω terminated
Purpose	Loop through of IN1 and IN2

Analyzer Optical Inputs

Label	OPTICAL A and B
Purpose	To provide 2 optical video/audio inputs
Type	SFP Optical Dual Receiver Module (option PHSFP-2R30-1310)
Specifications	SMPTE 424M, SMPTE 292M, and SMPTE 259M

Analyzer Functionality

With the module installed the Analyzer menu (see chapter 2 for details) allows the following monitoring to be displayed:



The Picture viewer is provided to allow you to monitor the selected input to give confidence that the signal is present, is the correct subject (or feed), it is moving and looks OK.

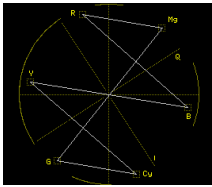

The Vectorscope allows you to check the hue, saturation and phase of the selected input. Controls are provided to allow you to select the line (s) to be monitored (ideal for checking any embedded test pattern in the selected feed), the field to be checked and the graticule scale.

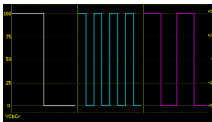

The Waveform Monitor allows you to check the levels of the video content are correct. Controls are provided to allow you to select the waveform (YCbCr, Y, Cb, Cr, GBR, Red, Green or Blue), the horizontal and vertical scale and the line(s) to be monitored.

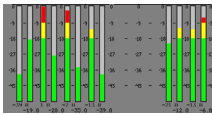

The Audio monitor (16 embedded audio channels, 48 kHz, 20-bit (SD-SDI) 24-bit (HD-SDI)) allows you to check the audio levels of the selected input. In addition to the visual display, the selected audio channel can be monitored via the front panel loud speakers or head phone jack.

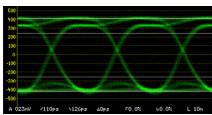

The Eye Pattern monitor allows you to check the level of jitter present in the selected source. Controls are provided to allow you to isolate specific frequencies of jitter to ensure that they are within acceptable tolerances.

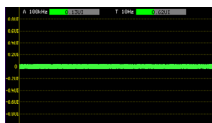

The Jitter monitor allows you to measure the amplitude of jitter present in the selected source against time. Controls are provided for scaling and filtering to isolate specific jitter types.

Single Analyzer, Single Generator

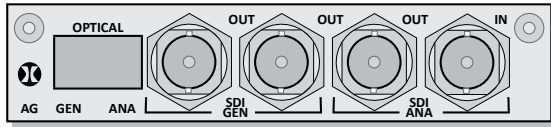

The PHRXM-AG module allows a single connected SDI or Optical video signal to be monitored continuously and allows the generation of a single SDI or Optical video test signal.

Analyzer SDI Input

Label	SDI ANA IN
Supported standards	SD-SDI or HD-SDI. See Supported formats
Connector	BNC
Input Impedance	75 Ω terminated
Input Return Loss	Better than 15dB (5MHz-1 485MHz) and 10dB (1 485MHz-2970MHz)
Maximum Input Voltage	+/- 2V

Analyzer SDI Output

label	SDI ANA OUT
Purpose	Loop through of SDI ANA IN
Connector	BNC
Output Impedance	75 Ω terminated

Analyzer Optical Input

Label	OPTICAL ANA
Type	SFP Optical Single Receiver Module/Single Transmitter (option PHSFP-RT30-1 310)
Specifications	SMPTE 424M, SMPTE 292M, and SMPTE 259M

Generator SDI Outputs

label	SDI GEN OUT
Supported standards	SD-SDI or HD-SDI. See Supported formats
Connector	BNC x 2
Output Impedance	75 Ω terminated
Output Level	+/- 400mV

Generator Optical Output

Label	OPTICAL GEN
Type	SFP Optical Single Receiver Module/Single Transmitter (option PHSFP-RT30-1 310)
Specifications	SMPTE 424M, SMPTE 292M, and SMPTE 259M

Analyzer Functionality

The PHRXM-AG module provides analyzer functionality for two concurrently connected SD-SDI, HD-SDI or Optical inputs. With the module installed the Analyzer menu (see chapter 2 for details) allows the follow monitoring to be displayed:



The Picture viewer is provided to allow you to monitor the selected input to give confidence that the signal is present, is the correct subject (or feed), it is moving and looks OK.

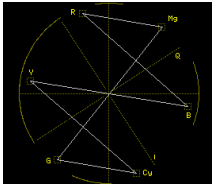

The Vectorscope allows you to check the hue, saturation and phase of the selected input. Controls are provided to allow you to select the line (s) to be monitored (ideal for checking any embedded test pattern in the selected feed), the field to be checked and the graticule scale.

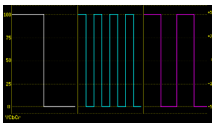

The Waveform Monitor allows you to check the levels of the video content are correct. Controls are provided to allow you to select the waveform (YCbCr, Y, Cb, Cr, GBR, Red, Green or Blue), the horizontal and vertical scale and the line(s) to be monitored.

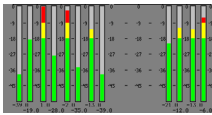

The Audio monitor (16 embedded audio channels, 48 kHz, 20-bit (SD-SDI) 24-bit (HD-SDI)) allows you to check the audio levels of the selected input. In addition to the visual display, the selected audio channel can be monitored via the front panel loud speakers or head phone jack.

Generator Functionality

The PHRXM-AG module provides a single video/audio signal generator functionality. The Generator menu (see chapter 2 for full details) allows the following test signals to be generated. The Generator provides:

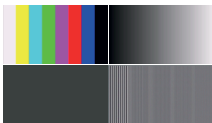

32, 10-bit Line-based video test patterns such as colour bars, ramp, colour plate, multiburst and user defined (DPX, YUV, TGA, BMP) that can be used to check video levels, linearity, saturation, hue, colour phase and frequency response.



Pathogenic video test patterns such as Bars + Red, SMPTE Bars, Check Field that can be used to check that decoding, encoding and transmission processes are correct.

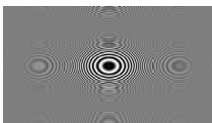

Zone Plate generator test patterns are provided and allow the selection of several predetermined zone plates as well as 3 user customisable zone plates.

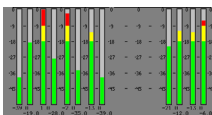

17 fixed Audio test tones (fixed 100Hz to 20kHz), variable tones (1Hz-24Khz in 1Hz steps), intermittent tone, white noise or silence on audio pairs and audio groups. Audio level variable (0 to -100dB in 1dB steps).

Single Analyzer, Single Generator, Physical Layer Measurement

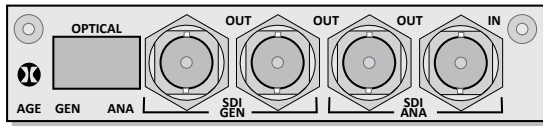

The PHRXM-AGE module allows a single connected SDI or Optical video signal to be monitored continuously and allows the generation of a single SDI or Optical video test signal.

Analyzer SDI Input

Label	SDI ANA IN
Supported standards	SD-SDI or HD-SDI. See Supported formats
Connector	BNC
Input Impedance	75 Ω terminated
Input Return Loss	Better than 15dB (5MHz-1 485MHz) and 10dB (1 485MHz-2970MHz)
Maximum Input Voltage	+/- 2V

Analyzer SDI Output

Label	SDI ANA OUT
Purpose	Loop through of SDI ANA IN
Connector	BNC
Output Impedance	75 Ω terminated

Analyzer Optical Input

Label	OPTICAL ANA
Purpose	To provide 1 optical video/audio input
Type	SFP Optical Single Receiver Module/Single Transmitter (option PHSFP-RT30-1 310)
Specifications	SMPTE 424M, SMPTE 292M, and SMPTE 259M

Generator SDI Outputs

label	SDI GEN OUT
Purpose	Generator Output
Supported standards	SD-SDI or HD-SDI. See Supported formats
Connector	BNC x 2
Output Impedance	75 Ω terminated
Output Level	+/- 400mV

Generator Optical Output

Label	OPTICAL GEN
Type	SFP Optical Single Receiver Module/Single Transmitter (option PHSFP-RT30-1 310)
Specifications	SMPTE 424M, SMPTE 292M, and SMPTE 259M

Generator Functionality

The PHRXM-AGE module provides a single video/audio signal generator functionality. The Generator menu (see chapter 2 for full details) allows the following test signals to be generated. The Generator provides:



32, 10-bit Line-based video test patterns such as colour bars, ramp, colour plate, multiburst and user defined (DPX, YUV, TGA, BMP) that can be used to check video levels, linearity, saturation, hue, colour phase and frequency response.



Pathogenic video test patterns such as Bars + Red, SMPTE Bars, Check Field that can be used to check that decoding, encoding and transmission processes are correct.

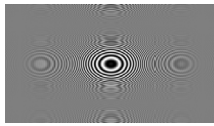

Zone Plate generator test patterns are provided and allow the selection of several predetermined zone plates as well as 3 user customisable zone plates.

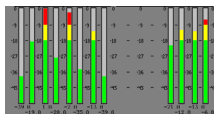

17 fixed Audio test tones (fixed 100Hz to 20kHz), variable tones (1Hz-24Khz in 1Hz steps), intermittent tone, white noise or silence on audio pairs and audio groups. Audio level variable (0 to -100dB in 1dB steps).

Analyzer Functionality

The PHRXM-AGE module provides analyzer functionality for two concurrently connected SD-SDI, HD-SDI or Optical inputs. With the module installed the Analyzer menu (see chapter 2 for details) allows the follow monitoring to be displayed:



The Picture viewer is provided to allow you to monitor the selected input to give confidence that the signal is present, is the correct subject (or feed), it is moving and looks OK.

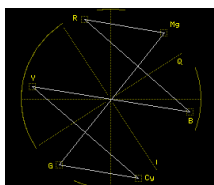

The Vectorscope allows you to check the hue, saturation and phase of the selected input. Controls are provided to allow you to select the line (s) to be monitored (ideal for checking any embedded test pattern in the selected feed), the field to be checked and the graticule scale.

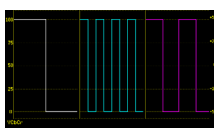

The Waveform Monitor allows you to check the levels of the video content are correct. Controls are provided to allow you to select the waveform (YCbCr, Y, Cb, Cr, GBR, Red, Green or Blue), the horizontal and vertical scale and the line(s) to be monitored.

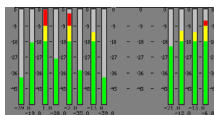

The Audio monitor (16 embedded audio channels, 48 kHz, 20-bit (SD-SDI) 24-bit (HD-SDI)) allows you to check the audio levels of the selected input. In addition to the visual display, the selected audio channel can be monitored via the front panel loud speakers or head phone jack.

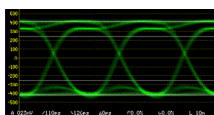

The Eye Pattern monitor allows you to check the level of jitter present in the selected source. Controls are provided to allow you to isolate specific frequencies of jitter to ensure that they are within acceptable tolerances.

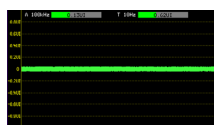

The Jitter monitor allows you to measure the amplitude of jitter present in the selected source against time. Controls are provided for scaling and filtering to isolate specific jitter types.

Dual Output Generator Module

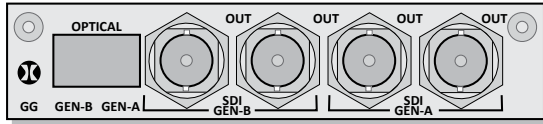

The PHRXM-GDL module allows the generation of a two independent SDI or Optical video test signals with the same video format, colour space and frame rate for Dual link use.

Generator SDI Outputs

Label	SDI GEN-A OUT and SDI GEN-B OUT
Supported standards	SD-SDI or HD-SDI. See Supported formats
Connector	BNC x 4
Output Impedance	75 Ω terminated
Output Level	+/- 400mV
Purpose	Generator Outputs

Generator Optical Outputs

Label	OPTICAL GEN-A and OPTICAL GEN-B
Type	SFP Optical Dual Transmitter Module (option PHSFP-2T30-1310)
Specifications	SMPTE 424M, SMPTE 292M, and SMPTE 259M
Purpose	To provide 2 optical video/audio outputs

Generator Functionality

The PHRXM-GG module provides a dual video/audio signal generator functionality. The Generator menu (see chapter 2 for full details) allows the following test signals to be generated. The Generator provides:



32, 10-bit Line-based video test patterns such as colour bars, ramp, colour plate, multiburst and user defined (DPX, YUV, TGA, BMP) that can be used to check video levels, linearity, saturation, hue, colour phase and frequency response.



Pathogenic video test patterns such as Bars + Red, SMPTE Bars, Check Field that can be used to check that decoding, encoding and transmission processes are correct.

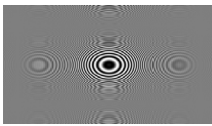

Zone Plate generator test patterns are provided and allow the selection of several predetermined zone plates as well as 3 user customisable zone plates.

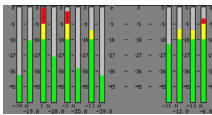

17 fixed Audio test tones (fixed 100Hz to 20kHz), variable tones (1Hz-24Khz in 1Hz steps), intermittent tone, white noise or silence on audio pairs and audio groups. Audio level variable (0 to -100dB in 1dB steps).

AES Digital Audio Input / Output

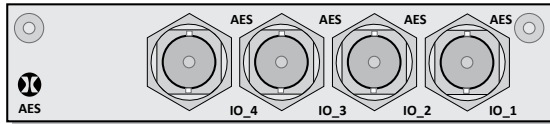

The PHRXM-4AGE module allows 4 x AES digital audio pairs to be routed to the Audio Meter and Loudness instruments.

Label	AES IO_1 TO AES IO_4
Connector	4 x BNC
Standard	AES3-4-2009 Annex D "Coaxial transmission"
Input Impedance	75 Ω terminated
Input Return Loss	Better than 15dB (5MHz-1485MHz)
Maximum Input Voltage	+/- 2V
Input Sample Rate	32kHz to 192kHz
Output Sample Rate	48kHz
Input Bit Depth	20bit or 24bit
Output Bit Depth	24bit
Purpose	AES digital audio pair Input and Output

Specification

Supported Video Formats

SD 270 Mb/s

Standard	Resolution	Colour Space	Rate
EBU Tech. 3267-E	720 x 576	4:2:2 (Y'C'BC'R')/10-bit	I 50.00
SMPTE 259M	720 x 483	4:2:2 (Y'C'BC'R')/10-bit	I 59.94

HD 1.485 Gb/s (SMPTE 292M)

Standard	Resolution	Colour Space	Rate
SMPTE 296M	1280 x 720	4:2:2 (Y'C'BC'R')/10 bit	P 23.98
			P 24.00
			P 25.00
			P 29.97
			P 30.00
			P 50.00
			P 59.94
			P 60.00
SMPTE 260M	1920 x 1035	4:2:2 (Y'C'BC'R')/10 bit	I 59.94
			I 60.00
SMPTE 274M	1920 x 1080	4:2:2 (Y'C'BC'R')/10 bit	I 50.00
			I 59.94
			I 60.00
SMPTE 274M	1920 x 1080	4:2:2 (Y'C'BC'R')/10 bit	P 23.98
			P 24.00
			P 25.00
			P 29.97
			P 30.00
SMPTE RP211	1920 x 1080	4:2:2 (Y'C'BC'R')/10 bit	sF 23.98
			sF 24.00
			sF 25.00
			sF 29.97
			sF 30.00
SMPTE 2048-2	2048 x 1080	4:2:2 (Y'C'BC'R')/10 bit	P 23.98
			P 24.00
			P 25.00
			P 29.97
			P 30.00

Dual Link 1.485 Gb/s (SMPTE 327M)

Standard	Resolution	Colour Space	Rate
SMPTE 274M	1920 x 1080	4:2:2 (Y'CB'R')/10 bit	P 50.00
			P 59.94
			P 60.00
	1920 x 1080	4:4:4 (R'G'B'), 4:4:4:4 (R'G'B' + A)/10-bit	P or sF 23.00
			P or sF 24.00
			P or sF 25.00
			P or sF 29.97
			P or sF 30.00
			I 50.00
			I 59.94
			I 60.00
SMPTE 274M	1920 x 1080	4:4:4 (R'G'B')/12-bit	P or sF 23.00
			P or sF 24.00
			P or sF 25.00
			P or sF 29.97
			P or sF 30.00
			I 50.00
			I 59.94
			I 60.00
SMPTE 274M	1920 x 1080	4:4:4 (Y'CB'R'), 4:4:4:4 (Y'CB'R' + A)/10-bit	P or sF 23.00
			P or sF 24.00
			P or sF 25.00
			P or sF 29.97
			P or sF 30.00
			I 50.00
			I 59.94
			I 60.00
SMPTE 274M	1920 x 1080	4:4:4 (Y'CB'R')/12 bit	P or sF 23.00
			P or sF 24.00
			P or sF 25.00

			P or sF 29.97
			P or sF 30.00
			I 50.00
			I 59.94
			I 60.00
SMPTE 274M	1920 x 1080	4:2:2 (Y'CbCr)/12 bit	P or sF 23.00
			P or sF 24.00
			P or sF 25.00
			P or sF 29.97
			P or sF 30.00
			I 50.00
			I 59.94
			I 60.00
SMPTE 428-9	2048 x 1080	4:4:4 (X'Y'Z)/12 bit	P or sF 23.98
			P or sF 24.00

3G Level-A 2.97 Gb/s (SMPTE 425M-A)

Standard	Resolution	Colour Space	Rate
SMPTE 274M	1920 x 1080	4:2:2 (Y'CB'R')/10 bit	P 50.00
			P 59.94
			P 60.00
SMPTE 296M	1280 x 720	4:4:4 (R'G'B'), 4:4:4:4 (R'G'B' + A)/10-bit	P 23.00
			P 24.00
			P 25.00
			P 29.97
			P 30.00
			P 50.00
			P 59.94
SMPTE 296M	1280 x 720	4:4:4 (Y'CB'R'), 4:4:4:4 (Y'CB'R' + A)/10-bit	P 23.00 *
			P 24.00 *
			P 25.00 *
			P 29.97 *
			P 30.00 *
			P 50.00 *
			P 59.94 *
SMPTE 274M	1920 x 1080	4:4:4 (R'G'B'), 4:4:4:4 (R'G'B' + A)/10-bit	P or sF 23.00 *
			P or sF 24.00 *
			P or sF 25.00 *
			P or sF 29.97 *
			P or sF 30.00 *
			I 50.00 *
			I 59.94 *
SMPTE 274M	1920 x 1080	4:4:4 (Y'CB'R'), 4:4:4:4 (Y'CB'R' + A)/10-bit	P or sF 23.00 *
			P or sF 24.00 *
			P or sF 25.00 *
			P or sF 29.97 *
			P or sF 30.00 *
			I 50.00 *
			I 59.94 *
			I 60.00

SMPTE 274M	1920 x 1080	4:4:4 (R'G'B')/12-bit	P 23.00 *
			P 24.00 *
			P 25.00 *
			P 29.97 *
			P 30.00 *
			I 50.00 *
			I 59.94 *
			I 60.00 *
SMPTE 274M	1920 x 1080	4:4:4 (Y'C'BC'R')/12 bit	P 23.00 *
			P 24.00 *
			P 25.00 *
			P 29.97 *
			P 30.00 *
			I 50.00 *
			I 59.94 *
			I 60.00 *
SMPTE 428-9	2048 x 1080	4:4:4 (X'Y'Z')/12 bit	P or sF 23.98 *
			P or sF 24.00 *
SMPTE 274M	1920 x 1080	4:2:2 (Y'C'BC'R')/12 bit	P or sF 23.98 *
			P or sF 24.00 *
			P or sF 25.00 *
			P or sF 29.97 *
			P or sF 30.00 *
			I 50.00 *
			I 59.94 *
			I 60.00 *

* Advance Format Option required

3G Level-B 2.97 Gb/s (SMPTE 425-B)

Payload type
1 x SMPTE 372M dual-link payload
2 x SMPTE 292M HD 720 payloads
2 x SMPTE 292M HD 1080 payloads

Built-in Generator Formats (CPU Module)

The following test patterns are available:

100% Colour Bars

75% Colour Bars

Check Field

Standard	Resolution	Colour Space	Rate
EBU Tech. 3267-E	720 x 576	4:2:2 (Y'C'BC'R')/10-bit	I 50.00
SMPTE 259M	720 x 483	4:2:2 (Y'C'BC'R')/10-bit	I 59.94
SMPTE 296M	1280 x 720	4:2:2 (Y'C'BC'R')/10 bit	P 23.98
			P 24.00
			P 25.00
			P 29.97
			P 30.00
			P 50.00
			P 59.94
			P 60.00
SMPTE 274M	1920 x 1080	4:2:2 (Y'C'BC'R')/10 bit	I 50.00
			I 59.94
			I 60.00
SMPTE 274M	1920 x 1080	4:2:2 (Y'C'BC'R')/10 bit	P 23.98
			P 24.00
			P 25.00
			P 29.97
			P 30.00
3G-A SMPTE 274M	1920 x 1080	4:2:2 (Y'C'BC'R')/10 bit	P 50.00
			P 59.94
			P 60.00
3G-B SMPTE 274M	1920 x 1080	4:2:2 (Y'C'BC'R')/10 bit	P 50.00
			P 59.94
			P 60.00



PHABRIX[®]
broadcast excellence

C Maintenance

Maintenance

Warranty

Overview

The Rx range benefits from a 1 year warranty including telephone and email support. Each Rx leaves our UK factory with its own unique list of quality controlled settings which are recorded by our manufacturing department. Should the Rx require calibration, these settings are compared with its pre- calibration state to ensure consistency and traceability.

The product has been designed and manufactured to be of the highest quality. However, should the instrument develop a fault during the warranty period, please return to your local PHABRIX agent for repair.

Calibration services are available throughout the PHABRIX network of distributors.

Warranty Exceptions

PHABRIX are not responsible for free service during the warranty period under the following conditions:

- Incorrect voltage applied to instrument.
- Incorrect power adaptor used.
- Fire, natural disaster.
- Repair of instrument by non PHABRIX approved agent
- Repair of damage caused by third party products.
- Repair of damage caused by improper use.
- Repair without proof of purchase.



99 Washington Street
Melrose, MA 02176
Phone 781-665-1400
Toll Free 1-800-517-8431



Maintenance

Maintenance

General Maintenance

The Rx2000, Rx1000 and Rx500 instruments have been designed to need minimum maintenance. The use of low power components means that there is not need for large amounts of cooling and therefore there are is not need to clean fan filters.

The case can be cleaned by wiping gently with a soft cloth, lightly dampened with a neutral cleaning agent. A screen cleaning cloth may be used to clean the LCD. Do not apply force to the LCD when cleaning or it may be damaged.



Warning always remove the power supply from the instrument and turn OFF before cleaning. Do not allow any water or other liquid to enter the instrument while cleaning.

Preventative Maintenance

For long reliable use of the Rx instrument please take the following precautions:

Install the Rx instrument in a position which has adequate air flow and is not in direct sun light.

Ensure that connecting cables are tied back so that they do not put strain on the rack mounts and that the do not obstruct air flow.

Ensure that the fan grills are not obstructed.

Avoid installations where there are dramatic changes in temperature, high humidity and areas contaminated by dust, smoke or construction debris.

Avoid installations that may be affected by vibration.

Do not exceed the rated operation of the Rx instrument, ie temperature and signal levels.



The instrument should only be operated between 0 and 40 °Centigrade. If the instrument is operated at a higher temperature there is a possibility of a fire hazard. If the temperature is changed rapidly from a cold environment to a hot environment, moisture can be created internally which can cause malfunction or damage the instrument. Allow the instrument to sit for 30 minutes without power applied to reduce any possibility of condensation. If the temperature rises above 60°Centigrade a warning dialog will be given. If the temperature rises above 65°Centigrade the instrument will be turned OFF. Under both conditions, an event will be added to the event log to show what happened.

Maintenance

Software Maintenance

Installing New Software

New software can be installed on the Rx instrument using 3 different techniques that take into account the location of the Rx instrument, the type of network access that the Rx instrument has and you company's IT policy.

Note that during the installation process the instrument will not be available for use.



Note also that any existing Presets stored will be archived and will need to be restored if they are required. See the "System"- "Memories" section in chapter 2 for details about how to restore presets archived by the installation of an new version of software.

Using a USB Pen Drive

If you have direct access to the equipment bay where the Rx instrument is housed, place a new version of software into the root directory of a USB pen drive and then simply plug the pen drive into the front of the Rx instrument:

1. Download the latest Rx software version from the PHABRIX website and un-zip the software file in the root directory of a USB pen drive.
2. Plug the USB pen drive into the USB socket on the front panel of the Rx instrument.

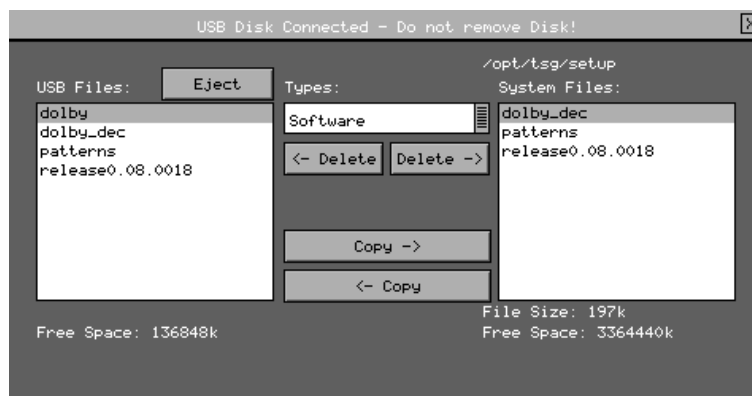

After about 30 seconds a copy utility will be displayed on the HDMI output monitor.

3. Using the copy utility copy the new software zip file (release 0.08.0018) displayed in the left panel to the system.

Once the copy process as completed, remove the USB pen drive from the front of the Rx instrument.

4. To install the new software, select it from the drop down list in the System Info menu on the HDMI output monitor. The largest number is the latest release. Select the 'Install' button and a confirmation dialogue will be shown. Press "Yes" and the installation will start.

"Loading new software if found"

"Program CPU FPGA"

"Program FPGA Slot 1"

"Program FPGA Slot 2"

"Program FPGA Slot 3"

"Program FPGA Slot 4"

During this time the software will be decompressed, files will be extracted and the hardware (FPGAs) will be reprogrammed. If an error is given during the installation, retry the installation and or download. Do NOT turn the instrument off until an installation has completed correctly.

Wait for the new software to be installed (up to 10 minutes depending on the number and type of Rx Modules that are installed). The progress will be indicated on the front panel screen and on the Monitor output:



Warning do not use a USB hard drive as the Rx instrument cannot support this and it will damage the Rx instrument.

Software Download from Internet

If you have access to the Rx instrument's Monitor output or access via a web browser (see chapter 1 for details), and the Rx instrument has Internet network access, you can download and install directly into the Rx instrument from the browser:

This process is a two stage process, first the new software needs to be Downloaded then the new software needs to be installed.

1. In the System - Network menu (Network window on Monitor Output) check that the network settings are correct and that the instrument is connected to the internet via the Ethernet connection.
2. From the System Info menu, select the Download button to download the current release of software from the PHABRIX Web Site.

This will take about 5 minutes dependent on the connection to the Internet. Once the download has completed, the software will be checked for errors before being stored on the instrument for future installation. If the latest software is already present on the Rx instrument, no software will be downloaded and a message will be shown.



Note that multiple releases of software may be stored on the Rx instrument so a previous release can be re-installed if required.

4. To install the new software, select it from the drop down list in the System Info menu on the HDMI output monitor. The largest number is the latest release. Select the 'Install' button and a confirmation dialogue will be shown. Press "Yes" and the installation will start.

During this time the software will be decompressed, files will be extracted and the hardware (FPGAs) will be reprogrammed. If an error is given during the installation, retry the installation and or download. Do NOT turn the instrument off until an installation has completed correctly.

Once the installation has completed, if "Reboot after Install" is checked the instrument will re-start with the new software installed. If not checked then the instrument should be turned off and on again manually.



Note that as part of the installation procedure, all memories are archived to a backup file and then deleted. They can be restored from the System-Memories page using the Restore button and selecting the '_Before_Upgrade' archive.

The software release notes can be viewed by selecting the Changes button.

Reverting to a Earlier Version of Software

If you need to revert to an earlier version of software:

Use the "System Info" menu find the version of software you require in the "Software Upgrade" section of the menu then select "Install".

Wait for the old software to be installed (up to 10 minutes depending on the number and type of Rx Modules that are installed). The progress will be indicated on the front panel screen and on the Monitor output.

During this time the software will be decompressed, files will be extracted and the hardware (FPGAs) will be reprogrammed. If an error is given during the installation, retry the installation and or download. Do NOT turn the instrument off until an installation has completed correctly.

FTP Connection

Files may be uploaded or downloaded from/to the PHABRIX Rx by a remote PC using the Ethernet connection.

To connect to the instrument you will need to use a FTP client which may be a GUI based one such as FileZilla or that built into windows. Other FTP applications are available for other computer platforms.

Hostname This is the IP address that the Rx instrument is using.

Username "sxuser"

Password: "phabrixsx"

Once you have connected to the instrument, you should be able to see the instrument file structure below. When downloading software revisions to the Rx, instrument you must ensure that your FTP application is set to transfer binary files without corrupting them.

Some FTP clients, such as FileZilla, this requires you to go to the "Edit - Settings" menu and select the Transfers – File Types page. Make sure that the "Treat files without extension as ASCII file" check box is NOT checked or corruption will occur.

Rx File Structure

The Rx instrument uses Linux as its operating system and a number of directories within the file system are provided for user-specific files.

Backups

The memory/presets that are backup-up using the "System Presets" - "Backup" function are saved as .mem files within the "Backups" folder. These can be copied to other Rx units and restored to copy presets from one Rx unit to another.

Patterns

The Patterns directory contains several sub-directories for the related video standards. Test pattern files should be placed in the correct directory for the video standard in use. i.e. if a 720p video standard is being used, only the test patterns in the 720yuv directory will be available. You may have a test pattern with the same name in different pattern directories but they should have the correct size and colour type (rgb/yuv) for the directory that they are in or they will be converted and may lose colour accuracy.

Patterns that are too large for the current standard will be clipped to fit; patterns that are too small will gain a black border and will be centred on the output image.

Test patterns are .pat files for the standard line based pattern files or user files. Supported user file formats are:

Windows bitmap files (.bmp). We support 24bit uncompressed bitmap formats only.

10 bit video files (.dpx) We support 10bit RGB/YUV formats only in Left to Right orientation.

Yuv and qnt files (8/10 bit packed yuv only)

targa (.tg) files which are compressed or uncompressed 8bit RGB files. We support Left to Right orientation only.

Phabrix specific .pat, .rgb, .yc4 files generated by the Phabrix pattern editor/convertor.

Note that bitmap files which are RGB will be converted to YUV internally as appropriate to the output standard. This will mean that not all valid YUV values can be output. If dpx YUV files are used then all valid values may be output.

Scripts

Command scripts may be downloaded into this directory. See File Formats-Command Scripts for more details.

Setup

The Setup directory contains the installer files for different releases of the software. Each release is comprised of a .tar.gz file and is self contained. If a release of software is copied onto the instrument, the list of available releases will be updated within a minute.

Idents

The Idents directory contains bitmap idents as used by the generator. Supported user file formats are:

- .bmp (Windows bitmap files: 24bit only)
- .dpx files (10 bit video files)
- .yuv files (8/10 bit packed yuv)
- .tga (targa files)

Note that bitmap files are RGB and will be converted to YUV internally as appropriate to the output standard. This will mean that not all valid YUV values can be output. If YUV files are used(.dpx), then all valid values may be output.

Fonts

The fonts available for use by the generator to add text idents may be enhanced by downloading new True Type fonts (.ttf) into this directory.

Loudness

The loudness logs recorded by the system will be saved as CSV (comma separated value) files that can be used to plot loudness graphs over time.

These CSV files have the following columns:

Integrated	holding the integrated loudness values
Integrated Threshold	the level above which alarms are logged in the “Integrated Alarms” column.
Integrated Alarm	holding the integrated loudness values above the “Integrated Threshold” value.
Momentary	holding the momentary loudness values
Momentary Threshold	the level above which alarms are logged in the “Momentary Alarms” column.
Momentary Alarm	holding the integrated loudness values above the “Momentary Threshold” value.
Short Term	holding the short term loudness values
Short Term Threshold	the level above which alarms are logged in the “Short Term Alarms” column.
Short Term Alarm	holding the integrated loudness values above the “Short Term Threshold” value.

FCAP

Frame Grab video clips with the .GRB extension will be saved into this directory.

Maintenance



PHABRIX[®]
broadcast excellence

D Applications

Applications

Audio Configuration

Overview

The Rx instruments use a module-wide, high speed data bus to transfer video, audio and control data between the installed modules and the CPU module. The bidirectional audio data bus allows audio data (originating as SDI embedded audio or AES audio) to be processed by the system. This bus also allows the routing of audio data to output as embedded SDI audio, AES audio and HDMI audio.

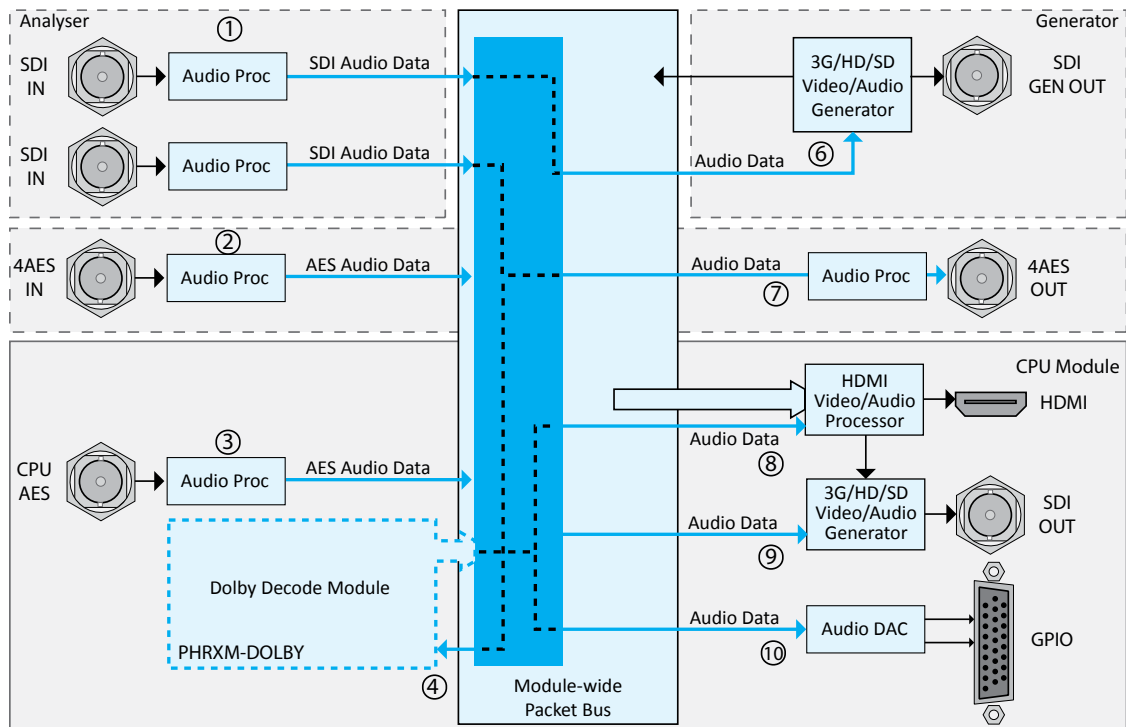

Simplified audio block diagram of Rx instrument

Audio Channel Selection for Measurement and Analysis

Embedded Audio Input

The Analyser module to which the SDI signal is connected will predetermine which instruments that can have access to the embedded audio channels of the SDI signal. Audio channel selection is made on each instrument ①

The levels of the embedded audio channels for the selected input can be viewed using the Audio Meters for that specific Analyser module. The Meters window can display the levels all 16 embedded audio channels at the same time. The actual channel pairs to be displayed can be selected using the Setup menu.

The Lissajous display allows the phase relationship of a selected stereo audio pair from the embedded audio channels to be seen.

The loudness levels of the embedded audio channels can be monitored and logged using the Loudness window. The Loudness window allows a stereo pair, a 5.1 channel group to be selected (defined in the Surround Meters Setup window) or the Decoded Dolby audio channels from the Dolby Decoder module to be used.

The Audio Status and Dolby Meta-Data (Dolby Metadata Analysis option) windows allow the selection of an individual stereo pair from the embedded audio for analysis.

AES Audio Input

The 4AES module provides audio-only analysis tools and audio-only generation tools.

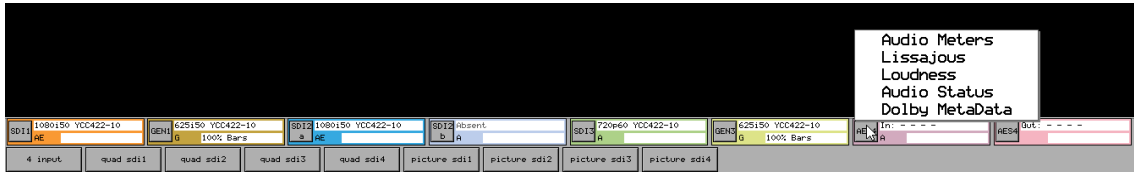

The 4AES module provides 4 configurable input (analyser) /output (generator) pairs.

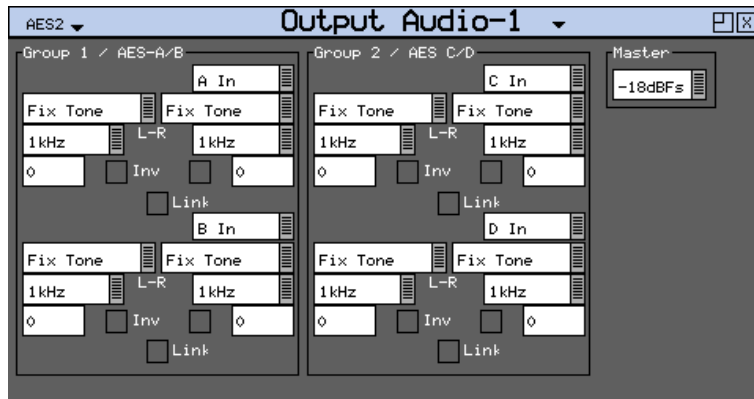

②

The Generator - Output Audio window of the 4AES module is used to assign the connectors as inputs or outputs. The inputs (A In, B In, C In and D In) can be monitored using the instruments available with the module.

The Audio Meters display allows the levels of the AES audio channels to be viewed. The Meters window can display a maximum of 8 AES audio channels at the same time. The actual channel pairs to be displayed can be selected using the Setup menu.

The Lissajous display allows the phase relationship of a selected stereo AES audio pair (A In, B In, C In or D In) to be seen.

The loudness levels of the selected AES audio pair (A In, B In, C In or D In) can be monitored and logged using the Loudness window.

The Audio Status and Dolby Meta-Data (Dolby Metadata Analysis option) windows allow the selection of an individual AES audio pair for analysis.

Decoded Dolby Audio (Dolby Decoder module)

The Dolby audio source to be decoded into baseband audio channels can be selected from a pair of audio channels from an Analyser module SDI input, from the AES input on the CPU module or from a pair of AES audio channels from the 4AES module.

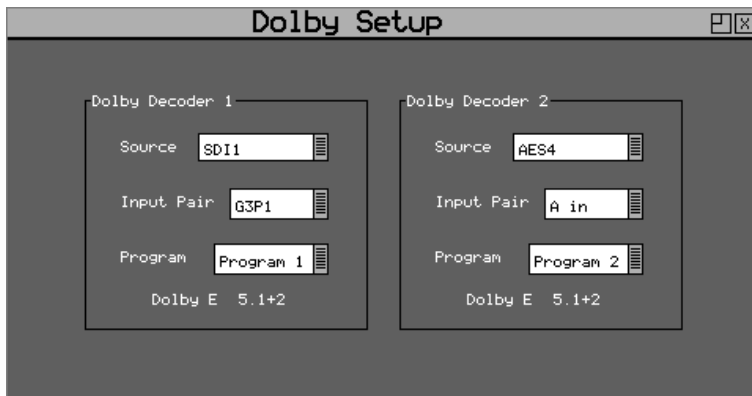

④

The selection of which audio pair that is decoded is made in the System - Dolby Decoder Setup window. The Source drop down allows the selection of either Analyser (ie Analyser module) or AES In (CPU module).

The Analyser Source allows the selection of the SDI input holding the Dolby audio data or the 4AES module. The discrete audio pair can then be selected from the drop-down list (for example G1P1 for SDI input or A In for AES input). Where the Dolby digital audio contains more than one program, the require one can be selected.



To ensure that the Dolby audio is decoded correctly, the System Reference locking frame rate must be the same as the SDI input video being decoded.

The levels of the decoded Dolby audio channels can be viewed using the Audio Meters of the corresponding Analyser module. The Meters window can displays the levels all 8 of the decoded audio channels at the same time. The actual channel pairs to be displayed can be selected using the Setup menu.

The Lissajous display allows the phase relationship of a selected stereo audio pair from the decoded Dolby audio channels to be viewed on the corresponding Analyser module.

Audio Monitoring

The Audio Monitoring window allows the selection of any Analyser input any audio group and any audio pair from the selected embedded audio group.

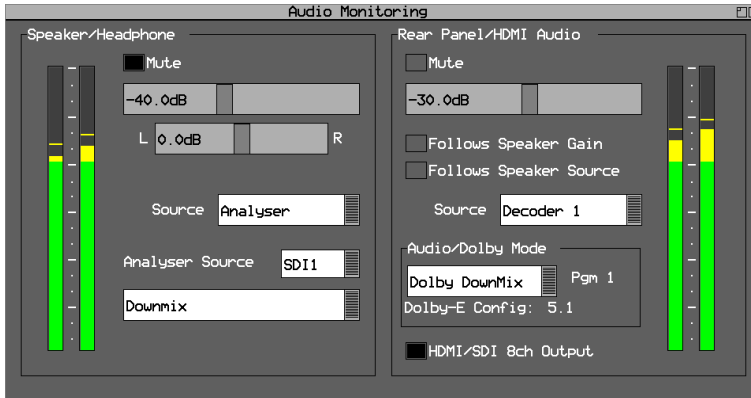

⑩

The Audio Monitoring window allows the selection of the headphone/speaker audio and the separate selection of the rear connection audio.

The audio level and source for the rear panel can be made to follow the headphone/speaker source.



③

The Source drop down list allows the selection of the audio channels from an Analyser module, the CPU AES In audio stereo pair or the Dolby Decoder module output.



④

If the Dolby Decoder module is installed, the embedded Dolby audio pair to be decoded is also selected as a Source.

The Audio Mode/Dolby Decode section controls whether PCM audio or a Dolby Down mix is output. Where the Dolby audio contains multiple programs, the specific program to be decoded can be selected here.

Speaker / Headphone Audio monitoring

The Rx range provides a headphone socket on the front panel. In addition to this the Rx 2000 provides front panel loudspeakers. The audio to be monitored on the Speakers/Headphones is controlled by the Speaker/Headphone section of the Audio Monitoring window.

Rear Panel monitoring

The Rx range provides an unbalance audio pair on the CPU module GPIO connector. This can be used to monitor the pair of audio channels selected in the “Rear Panel Audio” section of the Audio Monitoring window.

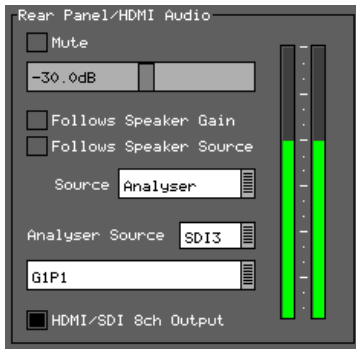

⑩

The Source drop down list allows the selection of either Analyser (ie Analyser module), AES In (CPU module) Decoder 1, Decoder 2 (Dolby Decoder module). The Analyser Source allows the selection of the SDI input holding the Dolby audio data or the 4AES module.

The discrete audio pair can then be selected from the drop-down list (for example G1P1 for SDI input or A In for AES input).

HDMI output monitoring

The currently selected Rear Panel Audio pair in the “Speaker/Headphone” section of the Audio Monitoring window is routed via the HDMI output when the “DVI Monitor” check box is disabled.

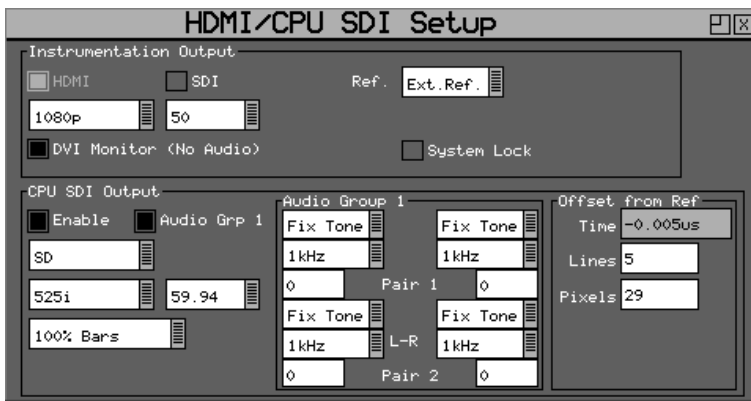

⑧

This is done using the HDMI/CPU SDI Setup window.

The audio level on the HDMI output is controlled by the Speaker/Headphone level in the Audio Monitoring window.

HDMI over SDI monitoring

If the HDMI Monitor output is routed via the CPU SDI output then the currently selected Speaker/Headphone audio pair is output as Group 1, Pair 1 of the embedded SDI audio.

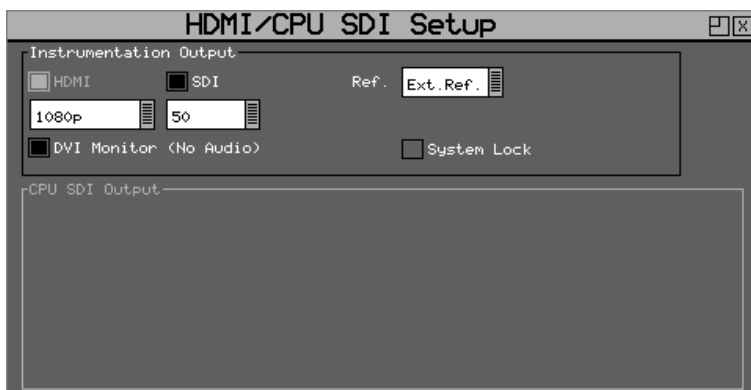

⑨

This is done using the HDMI/CPU SDI Setup window.

Note that the audio level of the SDI audio output is the same level as the currently selected audio pair in the Audio Monitoring window.

Audio Routing

The Rx system allows SDI embedded audio and AES audio to be routed from input connection to output connection.

AES Audio Output

Individual embedded audio channels from and SDI Analyser input can be output as AES audio via the 4AES module (option) using the Output Audio window.

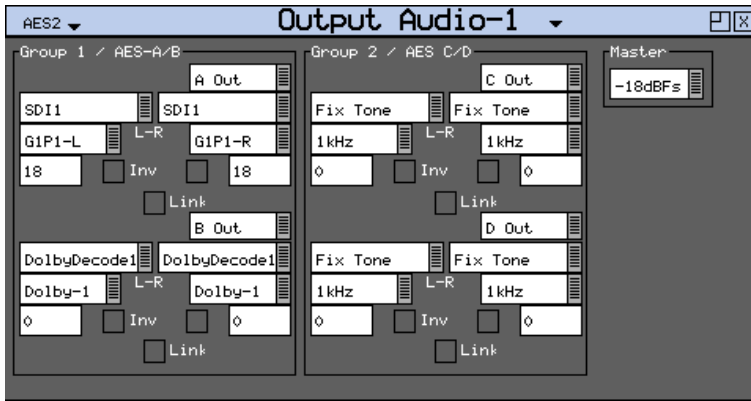

⑦

This can be setup in the Output Audio window for the 4AES module.

When outputting SDI as AES audio it may be necessary to adjust the levels. This can be done using the Master level or the individual channel levels.



To ensure that the SDI audio is synchronous with the AES output, the System reference locking frame rate must be the same as the SDI output video being generated. This can be done from the "Ref" menu on the HDMI task bar.

Generator SDI Audio Output

Discrete AES audio channels, from the CPU AES input or 4AES module input, can be embedded into the Generator SDI output signal instead of audio test tones.

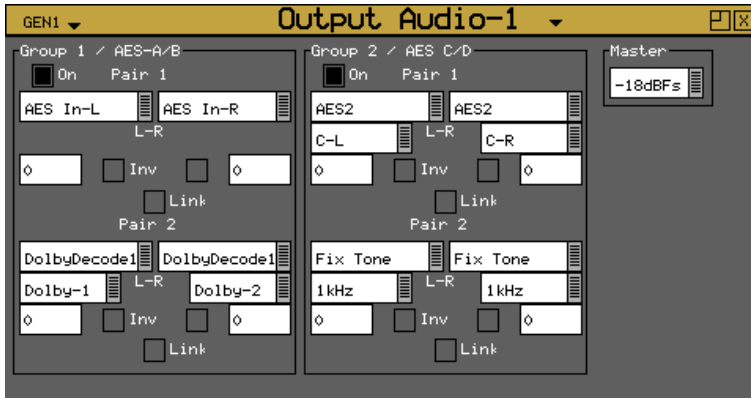

⑥

This is done using the Generator Audio Output window.

When embedding AES sourced audio into the SDI signal it may be necessary to adjust the levels. This can be done using the Master level or the individual channel levels.

If the Dolby Decoder module is installed Decoded Dolby audio channels can also be embedded into the Generator SDI output signal.



1-800-517-8431

99 Washington Street
Melrose, MA 02176
Phone 781-665-1400
Toll Free 1-800-517-8431

Visit us at www.TestEquipmentDepot.com