

# PowerClear<sup>™</sup> Drain Cleaning Machine



## Table of Contents

<b>Recording Form for Machine Serial Number</b> .....	1
<b>Safety Symbols</b> .....	2
<b>General Power Tool Safety Warnings</b>	
Work Area Safety .....	2
Electrical Safety .....	2
Personal Safety .....	3
Power Tool Use and Care .....	3
Service .....	3
<b>Specific Safety Information</b>	
Drain Cleaner Safety Warnings .....	3
<b>Description and Specifications</b>	
Description .....	4
Specifications .....	5
Switch Icons .....	5
<b>Machine Assembly</b> .....	5
Configuring Guide Hose/AUTOFEED Assembly .....	6
<b>Pre-Operation Inspection</b> .....	6
<b>Machine and Work Area Set-Up</b> .....	7
<b>Operating Instructions</b> .....	9
Feeding the Cable into the Drain .....	9
Passing Through Traps or Other Transitions .....	10
Cleaning the Drain .....	10
Working the Blockage .....	10
Handling a Stuck Tool .....	11
Freeing a Stuck Tool .....	11
Retrieving the Cable .....	11
Draining the Machine .....	11
Preparing for Transport .....	11
<b>Maintenance Instructions</b>	
Opening Drain Cleaner/Removing Drum .....	12
Cleaning .....	12
Replacing the Cable .....	12
<b>Optional Equipment</b> .....	13
<b>Machine Storage</b> .....	13
<b>Service and Repair</b> .....	13
<b>Disposal</b> .....	13
<b>Troubleshooting</b> .....	14
<b>EC Declaration of Conformity</b> .....	Inside Back Cover
<b>Lifetime Warranty</b> .....	Back Cover

\*Original Instructions - English

# Drain Cleaner

# PowerClear™ Drain Cleaning Machine



## **⚠ WARNING!**

Read this Operator's Manual carefully before using this tool. Failure to understand and follow the contents of this manual may result in electrical shock, fire and/or serious personal injury.

### **PowerClear™ Drain Cleaning Machine**

Record Serial Number below and retain product serial number which is located on name plate.

Serial  
No.

--	--

## Safety Symbols

In this operator's manual and on the product, safety symbols and signal words are used to communicate important safety information. This section is provided to improve understanding of these signal words and symbols.

 This is the safety alert symbol. It is used to alert you to potential personal injury hazards. Obey all safety messages that follow this symbol to avoid possible injury or death.

 **DANGER** DANGER indicates a hazardous situation which, if not avoided, will result in death or serious injury.

 **WARNING** WARNING indicates a hazardous situation which, if not avoided, could result in death or serious injury.

 **CAUTION** CAUTION indicates a hazardous situation which, if not avoided, could result in minor or moderate injury.

 **NOTICE** NOTICE indicates information that relates to the protection of property.

 This symbol means read the operator's manual carefully before using the equipment. The operator's manual contains important information on the safe and proper operation of the equipment.

 This symbol means always wear safety glasses with side shields or goggles when handling or using this equipment to reduce the risk of eye injury.

 This symbol indicates the risk of hands, fingers or other body parts being caught, wrapped or crushed in the drain cleaning cable.

 This symbol indicates the risk of electrical shock.

## General Power Tool Safety Warnings\*

 **WARNING**  
**Read all safety warnings, instructions, illustrations and specifications provided with this power tool. Failure to follow all instructions listed below may result in electric shock, fire, and/or serious injury.**

### **SAVE ALL WARNINGS AND INSTRUCTIONS FOR FUTURE REFERENCE!**

The term "power tool" in the warnings refers to your mains-operated (corded) power tool or battery-operated (cordless) power tool.

### Work Area Safety

- **Keep work area clean and well lit.** Cluttered or dark areas invite accidents.
- **Do not operate power tools in explosive atmospheres, such as in the presence of flammable liquids, gases, or dust.** Power tools create sparks which may ignite the dust or fumes.
- **Keep children and by-standers away while operating a power tool.** Distractions can cause you to lose control.

## Electrical Safety

- **Power tool plugs must match the outlet. Never modify the plug in any way. Do not use any adapter plugs with earthed (grounded) power tools.** Unmodified plugs and matching outlets will reduce risk of electric shock.
- **Avoid body contact with earthed or grounded surfaces such as pipes, radiators, ranges and refrigerators.** There is an increased risk of electrical shock if your body is earthed or grounded.
- **Do not expose power tools to rain or wet conditions.** Water entering a power tool will increase the risk of electrical shock.
- **Do not abuse the cord. Never use the cord for carrying, pulling or unplugging the power tool. Keep cord away from heat, oil, sharp edges or moving parts.** Damaged or entangled cords increase the risk of electric shock.
- **When operating a power tool outdoors, use an extension cord suitable for outdoor use.** Use of a cord suitable for outdoor use reduces the risk of electric shock.
- **If operating a power tool in a damp location is unavoidable, use a ground fault circuit interrupter (GFCI) protected supply.** Use of a GFCI reduces the risk of electric shock.

\* The text used in the General Power Tool Safety Warnings section of this manual is verbatim, as required, from the applicable UL/CSA 62841 edition standard. This section contains general safety practices for many different types of power tools. Not every precaution applies to every tool, and some do not apply to this tool.

## Personal Safety

- **Stay alert, watch what you are doing and use common sense when operating a power tool. Do not use a power tool while you are tired or under the influence of drugs, alcohol, or medication.** A moment of inattention while operating power tools may result in serious personal injury.
- **Use personal protective equipment. Always wear eye protection.** Protective equipment such as dust mask, non-skid safety shoes, hard hat, or hearing protection used for appropriate conditions will reduce personal injuries.
- **Prevent unintentional starting. Ensure the switch is in the OFF position before connecting to power source and/or battery pack, picking up or carrying the tool.** Carrying power tools with your finger on the switch or energizing power tools that have the switch ON invites accidents.
- **Remove any adjusting key or wrench before turning the power tool ON.** A wrench or a key left attached to a rotating part of the power tool may result in personal injury.
- **Do not overreach. Keep proper footing and balance at all times.** This enables better control of the power tool in unexpected situations.
- **Dress properly. Do not wear loose clothing or jewelry. Keep your hair, and clothing away from moving parts.** Loose clothes, jewelry, or long hair can be caught in moving parts.
- **If devices are provided for the connection of dust extraction and collection facilities, ensure these are connected and properly used.** Use of dust collection can reduce dust-related hazards.
- **Do not let familiarity gained from frequent use of tools allow you to become complacent and ignore tool safety principles.** A careless action can cause severe injury within a fraction of a second.

## Power Tool Use and Care

- **Do not force power tool. Use the correct power tool for your application.** The correct power tool will do the job better and safer at the rate for which it is designed.
- **Do not use power tool if the switch does not turn it ON and OFF.** Any power tool that cannot be controlled with the switch is dangerous and must be repaired.
- **Disconnect the plug from the power source and/or the battery pack from the power tool before making any adjustments, changing accessories, or**

**storing power tools.** Such preventive safety measures reduce the risk of starting the power tool accidentally.

- **Store idle power tools out of the reach of children and do not allow persons unfamiliar with the power tool or these instructions to operate the tool.** Power tools are dangerous in the hands of untrained users.
- **Maintain power tools. Check for misalignment or binding of moving parts, breakage of parts and any other condition that may affect the power tool's operation. If damaged, have the power tool repaired before use.** Many accidents are caused by poorly maintained power tools.
- **Keep cutting tools sharp and clean.** Properly maintained cutting tools with sharp cutting edges are less likely to bind and are easier to control.
- **Use the power tool, accessories and tool bits etc. in accordance with these instructions, taking into account the working conditions and the work to be performed.** The use of the power tool for operations different from those intended could result in a hazardous situation.
- **Keep handles and grasping surfaces dry, clean and free from oil and grease.** Slippery handles and grasping surfaces do not allow for safe handling and control of the tool in unexpected situations.

## Service

- **Have your power tool serviced by a qualified repair person using only identical replacement parts.** This will ensure that the safety of the power tool is maintained.

## Specific Safety Information

### **WARNING**

**This section contains important safety information that is specific to this tool.**

**Read these precautions carefully before using the PowerClear Drain Cleaning Machine to reduce the risk of electrical shock or other serious injury.**

### **SAVE ALL WARNINGS AND INSTRUCTIONS FOR FUTURE REFERENCE!**

Keep this manual with machine for use by the operator.

## Drain Cleaner Safety

- **Before using the tool, test the ground fault circuit interrupter (GFCI) provided with the power supply**

- cord to insure it is operating correctly. A properly operating GFCI reduces the risk of electrical shock.
- **Only use extension cords that are protected by a GFCI.** The GFCI on the machine power cord will not prevent electrical shock from extension cords.
  - **Only grasp the rotating cable with gloves recommended by the manufacturer.** Latex or loose fitting gloves or rags can become wrapped around the cable and may result in serious personal injury.
  - **Do not allow the cutter to stop turning while the cable is turning.** This can overstress the cable and may cause twisting, kinking or breaking of the cable and may result in serious personal injury.
  - **One person must control both the cable and the switch.** If the cable end stops rotating, the operator must be able to turn the machine motor OFF to prevent twisting, kinking and breaking of the cable.
  - **Use latex or rubber gloves inside the gloves recommended by the manufacturer, goggles, face shields, protective clothing, and respirator when chemicals, bacteria or other toxic or infectious substances are suspected to be in a drain line.** Drains may contain chemicals, bacteria and other substances that may cause burns, be toxic or infectious or may result in other serious personal injury.
  - **Practice good hygiene. Do not eat or smoke while handling or operating the tool. After handling or operating drain cleaning equipment, use hot, soapy water to wash hands and other body parts exposed to drain contents.** This will help reduce the risk of health hazards due to exposure to toxic or infectious material.
  - **Only use the drain cleaner for the recommended drain sizes.** Using the wrong size drain cleaner can lead to twisting, kinking or breaking of the cable and may result in personal injury.
  - **Keep gloved hand on the guide hose/AUTOFEED® unit whenever the machine is running.** This provides better control of the cable and helps prevent twisting, kinking and breaking of the cable and may result in serious personal injury.
  - **Position machine so that the AUTOFEED unit is within 6" (15 cm) of the drain inlet or properly support exposed cable when the distance exceeds 6" (15 cm).** Greater distances can cause control problems leading to twisting, kinking or breaking of the cable. Twisting, kinking or breaking cable may cause striking or crushing injuries.
- **Do not operate the machine in REV (reverse) rotation except as described in this manual.** Operating in reverse can result in cable damage and is used to back the cable end out of blockages.
  - **Keep hands away from rotating drum and guide tube.** Do not reach into drum unless machine is unplugged. Hand may be caught in the moving parts.
  - **Do not wear loose clothing or jewelry. Keep your hair and clothing away from moving parts.** Loose clothing, jewelry or hair can be caught in moving parts.
  - **Do not operate this machine if operator or machine is standing in water.** Operating machine while in water increases the risk of electrical shock.

## Description and Specifications

### Description

The RIDGID® PowerClear™ Drain Cleaning machine is designed to clean 3/4" (20mm) to 1 1/2" (40mm) drain lines in sinks, tubs and showers. It is equipped with a 30' (9m) cable.

The PowerClear Drain Cleaner features a 2-way AUTO-FEED® cable feed mechanism, which advances and retrieves the cable with a push of a lever at a rate of 18' per minute. A configurable guide hose, in conjunction with the AUTOFEED unit allows the cable to be directly fed into the drain which minimizes mess and helps to protect fixtures.

A FOR/OFF/REV switch controls drum and cable rotation and a pneumatic foot switch provides ON/OFF control of the motor. An integral Ground Fault Circuit Interrupter (GFCI) is built into the line cord.

The drain cleaner has a clear front housing to allow monitoring of cable.

The PowerClear Drain Cleaner is not recommended for use with toilets.



99 Washington Street  
Melrose, MA 02176  
Phone 781-665-1400  
Toll Free 1-800-517-8431

 Visit us at [www.TestEquipmentDepot.com](http://www.TestEquipmentDepot.com)

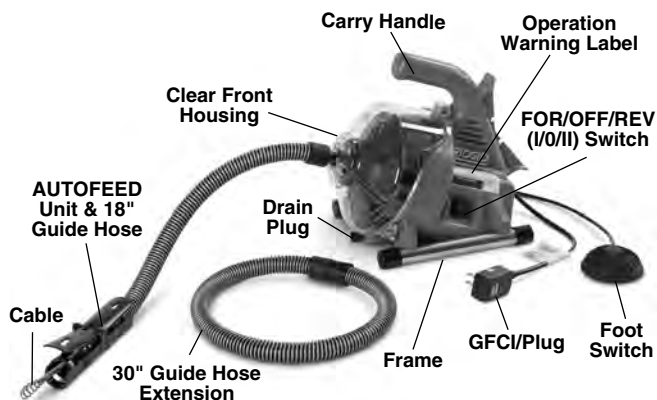

Figure 1 – PowerClear Drain Cleaning Machine

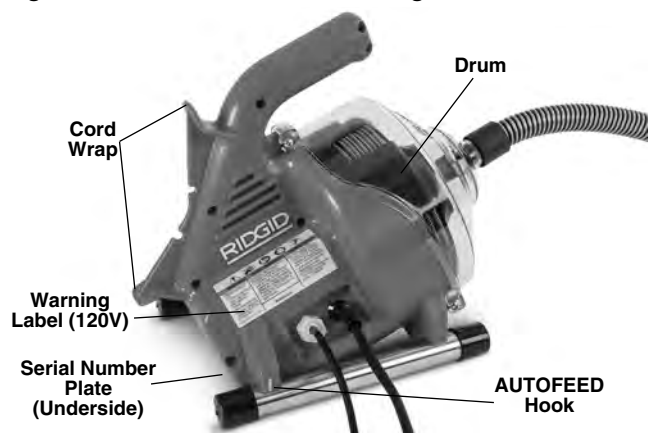

Figure 2 – PowerClear Drain Cleaning Machine

**Specifications**

- Line Capacity .....¾" – 1½" (20mm - 40mm)
- Drum Capacity .....30' (9.1m) of ¼" (6mm) Diameter Cable
- Cable.....¼" x 30' (6mm x 9.1m) MAXCORE™ 50 Cable
- Motor Type .....Universal
- Motor Ratings.....120V                    230V  
     ¼ HP                                    120W  
     0.9 Amp, 60Hz    0.5 Amp, 50Hz
- See Serial Plate for Machine Specification Information.
- No Load Speed (no)...450 RPM
- AUTOFEED  
 Unit Feed Rate.....18 feet/min (5.5 m/min)
- Controls.....Forward/OFF/Momentary Reverse Rotation Direction Control  
     ON/OFF Pneumatic Foot Switch  
     Motor Control  
     Advance/Retrieve Cable  
     AUTOFEED Unit with  
     Configurable Guide Hose

- Operating Temperature.....20° - 120°F (-7° - 49°C)
- Weight.....12 lbs (5,44 kg)
- Dimension LxWxH.....14" x 9" x 11.5"  
     (356 mm x 229 mm x 292 mm)
- Sound Pressure (L<sub>PA</sub>)\* ...70 dB(A), K=3
- Sound Power (L<sub>WA</sub>)\* .....79 dB(A), K=3

\* Sound measurements are measured in accordance with a standardized test per Standard EN 62481-1.  
 - Sound emissions may vary due to your location and specific use of these tools.  
 - Daily exposure levels for sound need to be evaluated for each application and appropriate safety measures taken when needed. Evaluation of exposure levels should consider the time a tool is switched off and not in use. This may significantly reduce the exposure level over the total working period.

**Switch Icons**

- Forward Rotation (FOR)
- Power OFF
- Reverse Rotation (REV)

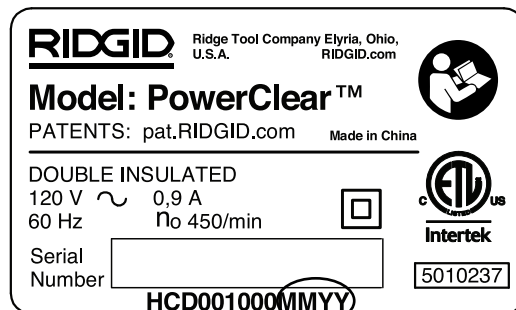

Figure 3 – Machine Serial Number

The machine serial number is located on the underside of the housing. The last 4 digits indicate the month and year of manufacture. (MM = month, YY = year).

**NOTICE** This machine is made to clean drains. If properly used it will not damage a drain that is in good condition and properly designed, constructed and maintained. If the drain is in poor condition, or has not been properly designed, constructed and maintained, the drain cleaning process may not be effective or could cause damage to the drain. The best way to determine the condition of a drain before cleaning is through visual inspection with a camera. Improper use of this drain cleaner can damage the drain cleaner and the drain. This machine may not clear all blockages.

**Machine Assembly**

**⚠ WARNING**  
**To reduce the risk of serious injury during use, follow these procedures for proper assembly. FOR/OFF/REV switch should be OFF and machine unplugged before assembly.**

## Configuring Guide Hose/AUTOFEED Assembly

The AUTOFEED guide hose can be assembled either as an 18" guide hose or as a 48" guide hose, depending on how far the PowerClear will sit from the drain opening in use. The 18" guide hose can work well when the machine can sit directly next to a sink, such as a kitchen or bathroom counter. The 48" guide hose may be appropriate when the machine will sit on the floor outside of a bathtub. Regardless of guide hose length used, the AUTOFEED assembly must be within 6" (15 cm) of the drain inlet. Do not extend the guide hose longer than 48".

1. If desired, connect the 18" and 30" guide hose sections. The connection is a friction fit - Insert the male fitting into the female fitting and confirm secure.
2. Remove and discard cable end cap (New machine). Pull enough cable from the drum to feed through the guide hose and AUTOFEED unit.
3. Feed cable through the guide hose. Lift the ADVANCE and RETRIEVE levers to allow the bulb head of the cable to feed through the AUTOFEED unit. (Figure 5).

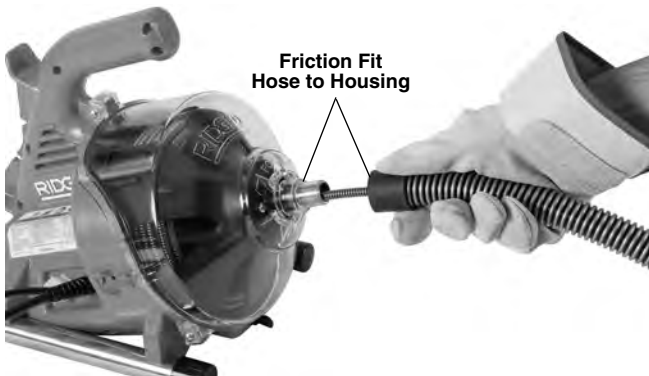

Figure 4 – Feeding Cable into Guide Hose



Figure 5 – Feeding Cable Through AUTOFEED® Assembly

4. Release the ADVANCE and RETRIEVE levers.

5. Attach the guide hose to the machine by pushing the hose over the nose of the front housing (Figure 4). Reverse process to remove.

## Pre-Operation Inspection

### ⚠ WARNING



**Before each use, inspect your drain cleaning machine and correct any problems to reduce the risk of serious injury from electric shock, twisted or broken cables, chemical burns, infections and other causes and prevent drain cleaner damage.**

**Always wear safety glasses, leather work gloves, and other appropriate protective equipment when inspecting your drain cleaner.**

1. Inspect the leather work gloves. Make sure they are in good condition with no holes, tears or loose sections that could be caught in the rotating cable. It is important not to wear improper or damaged gloves. The gloves protect your hands from the rotating cable and drain contents. If the gloves are not leather work gloves or are damaged or worn out, do not use machine until proper gloves are available.
2. Make sure that the drain cleaning machine is unplugged and inspect the power cord, Ground Fault Circuit Interrupter (GFCI) (if provided) and plug for damage. If the plug has been modified, or if the cord is damaged, to avoid electrical shock, do not use the machine until the cord has been replaced by a qualified repair person.
3. Clean the drain cleaner, including handles and controls. This aids inspection and helps prevent the machine or control from slipping from your grip. Clean and maintain the machine per the maintenance instructions.
4. Inspect the drain cleaning machine for the following items:
  - Proper assembly and completeness.
  - Any broken, worn, missing, misaligned or binding parts.
  - Make sure the foot switch is attached to the drain cleaning machine. Do not operate the machine without the foot switch.
  - Presence and readability of the warning label (See Figure 1 and 2).
  - Smooth and free movement of the AUTOFEED unit levers (Figure 9).
  - Any condition which may prevent safe and normal operation.



If any problems are found, do not use the drain cleaner until the problems have been repaired.

5. Clean any debris from the cable. Inspect cable for wear and damage. Inspect for:
  - Obvious flats worn into the outside of the cable (cable is made from round wire and the profile should be round).
  - Multiple or excessively large kinks (slight kinks up to 15 degrees can be straightened).
  - Space between cable coils indicating that the cable has been deformed by stretching, kinking, or running in reverse (REV).
  - Excessive corrosion from storing wet or exposure to drain chemicals.

All of these forms of wear and damage weaken the cable and make cable twisting, kinking or breaking more likely during use. Replace worn and damaged cable before using drain cleaner.

Make sure the cable is fully retracted with no more than 6" (150mm) of cable outside of the machine. This will prevent whipping of the cable at start up.

6. Make sure that the FOR/OFF/REV (I/O/II) switch is set to the OFF position.
7. With dry hands, plug cord into properly grounded outlet. Test the GFCI (if provided) in the electrical cord to insure that it is operating correctly. When the test button is pushed in, the red button marked "RESET" should pop up slightly and the machine will not operate. Reactivate by pushing the red RESET button in. If GFCI is not functioning properly, unplug the cord and do not use the drain cleaning machine until the GFCI has been repaired.
8. Move the FOR/OFF/REV switch into the FOR position. Press the foot switch and note the direction of rotation of the drum. If the foot switch does not control the machine operation, do not use the machine until the foot switch has been repaired. The drum should rotate counter-clockwise when viewed from the front of the drum, and will match the drum direction shown on the front housing (*Figure 10*).
 

Release the foot switch and let the drum come to a complete stop. Hold the FOR/OFF/REV switch in the REV position, and repeat above testing to confirm that the drain cleaner operates properly in reverse. If the rotation is not correct, do not use the machine until it has been repaired.
9. With the inspection complete, move the FOR/OFF/REV switch into the OFF position and, with dry hands, unplug the machine.

## Machine and Work Area Set-Up

### ⚠ WARNING

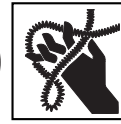

**Set up the drain cleaning machine and work area according to these procedures to reduce the risk of injury from electric shock, fire, machine tipping, twisted or broken cables, chemical burns, infections and other causes, and prevent drain cleaner damage.**

**Always wear safety glasses and other appropriate protective equipment when setting up your drain cleaner.**

1. Check work area for:
  - Adequate lighting.
  - Flammable liquids, vapors or dust that may ignite. If present, do not work in area until sources have been identified and corrected. The drain cleaner IS not explosion proof and can cause sparks.
  - Clear, level, stable, dry location for all equipment and operator. Do not use machine while standing in water. If needed, remove water from the work area.
  - Properly grounded electrical outlet of the correct voltage. Check machine serial plate for required voltage. A three-prong or GFCI outlet may not be properly grounded. If in doubt, have outlet inspect-ed by a licensed electrician.
  - Clear path to electrical outlet that does not contain any potential sources of damage for the power cord.
2. Inspect the drain to be cleaned. If possible, determine the access point(s) to the drain, the size(s) and length(s) of the drain, distance to tanks or mainlines, the nature of the blockage, presence of drain cleaning chemicals or other chemicals, etc. If chemicals are pre-sent in the drain, it is important to understand the specific safety measures required to work around those chemicals. Contact the chemical manufacturer for required information.
3. Determine the correct equipment for the application. *See Specifications.*

The PowerClear Drain Cleaner is not recommended for use with toilets.

Make sure all equipment has been properly inspected.
4. If needed, place protective covers in the work area. The drain cleaning process can be messy.

6. If needed, take appropriate steps to access the drain to be cleaned.
  - For many drains, the cable can be threaded through the cross hairs in the drain (*Figure 6A*).
  - For a sink with a pop up drain plug: Remove lift rod and drain plug. Be sure to place a container under the clean out or trap to catch any water that may come out. (*Figure 6B*).
  - For other sinks a clean out plug or trap may need to be removed. Be sure to place a container under the clean out or trap to catch any water that may come out. (*Figure 6C*).
  - Bathtub overflow: For bathtubs, never try to go through the drain, this will damage the cable. Remove the overflow plate and any mechanism to access the drain (*Figure 6D*).

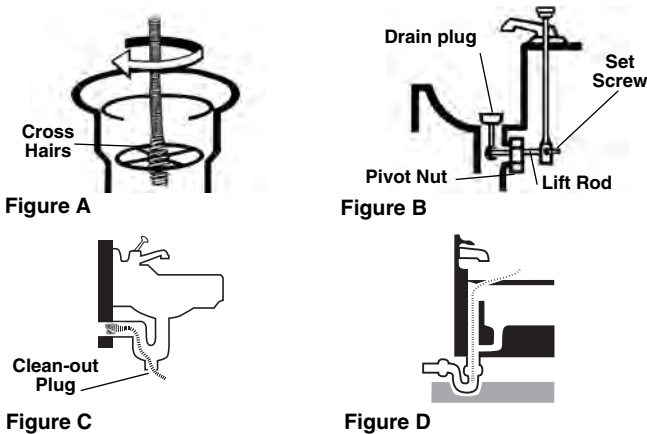

**Figure 6 – Drain Access**

7. Position the drain cleaning machine so it sits squarely and firmly on the rubber feet. Do not place the machine on carpet or other surfaces that could block the air vents on the underside of the machine. The end of the AUTOFEED unit must reach within 6" (15cm) of the drain access. The guide hose should not be pulled tight or kinked to reach this position. Greater distances from the drain access increases the risk of the cable twisting or kinking. If the machine cannot be placed with the drum opening within 6" (15cm) of the drain access, extend the drain access with similar sized pipe and fittings (*See Figure 7*). Improper cable support can allow the cable to kink and twist and can damage the cable or injure the operator.

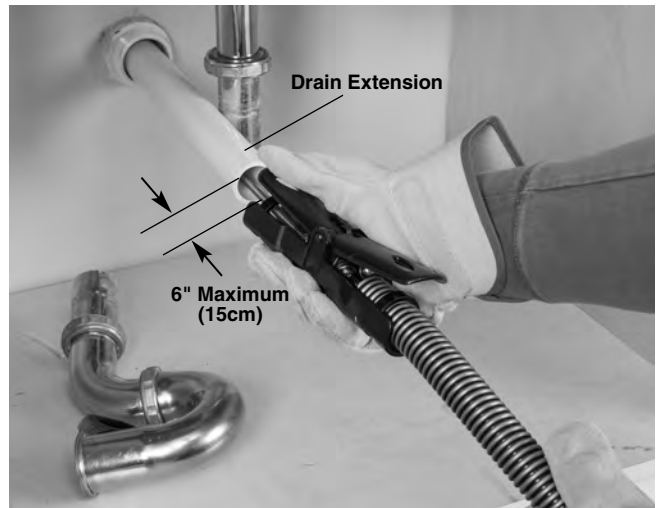

**Figure 7 – Example of Extending Drain to within 6" (15cm) of AUTOFEED Unit.**

8. Evaluate the work area and determine if any barriers are needed to keep bystanders away from the drain cleaner and work area. The drain cleaning process can be messy and bystanders can distract the operator.
9. Position the foot switch for easy accessibility. You must be able to hold and control the guide hose and AUTOFEED levers, control the foot switch, and reach the FOR/OFF/REV switch.
10. Confirm that the FOR/OFF/REV switch is in the OFF position.
11. Run the cord along the clear path. With dry hands, plug the drain cleaner into a properly grounded outlet. Keep all connections dry and off the ground. If the power cord is not long enough, use an extension cord that:
  - Is in good condition.
  - Has a plug similar to that supplied on the drain cleaner.
  - Is rated for outdoor use and contains a W or W-A in the cord designation (i.e. SOW), or complies with H05VV-F, H05RN-F types or IEC type design (60227 IEC 53, 60245 IEC 57).
  - Has sufficient wire size. For extension cords up to 50' (15,2 m) long use 16 AWG (1,5mm<sup>2</sup>) or heavier. For extension cords 50'-100' (15,2m – 30,5m) long use 14 AWG (2,5mm<sup>2</sup>) or heavier

When using an extension cord, the GFCI on the drain cleaner does not protect the extension cord. If the outlet is not GFCI protected, it is advisable to use a plug in type GFCI between the outlet and the extension cord to reduce the risk of shock if there is a fault in the extension cord.

## Operating Instructions

### ⚠ WARNING



**Always wear eye protection to protect your eyes against dirt and other foreign objects.**

**Always wear leather work gloves in good condition. Latex or loose fitting gloves or rags can become wrapped around the cable and may result in serious personal injury. Only wear latex or rubber gloves under leather work gloves. Do not use damaged drain cleaning gloves.**

**Always use appropriate personal protective equipment while handling and using drain cleaning equipment. Drains may contain chemicals, bacteria and other substances that may be toxic, infectious, cause burns or other issues. Appropriate personal protective equipment always includes safety glasses and leather work gloves, and may include equipment such as latex or rubber gloves, face shields, goggles, protective clothing, respirators and steel-toed footwear.**

**Do not allow the cable end to stop turning while the machine is running. This can overstress the cable and may cause twisting, kinking or breaking of the cable. Twisting, kinking or breaking cable may cause striking or crushing injuries.**

**Keep gloved hand on the guide hose/AUTOFEED unit whenever the machine is running. This provides better control of the cable and helps prevent twisting, kinking and breaking of the cable. Twisting, kinking or breaking cable may cause striking or crushing injuries.**

**Position the machine so the AUTOFEED unit is within 6" (15cm) of the drain inlet or properly support exposed cable when the distance exceeds 6". Greater distances can cause control problems leading to twisting, kinking or breaking of the cable. Twisting, kinking or breaking cable may cause striking or crushing injuries.**

**One person must control both the cable and the foot switch. If the cable end stops rotating, the operator must be able to turn the machine motor OFF to prevent twisting, kinking and breaking of the cable. Twisting, kinking or breaking cable may cause striking or crushing injuries.**

**Follow operating instructions to reduce the risk of injury from twisted or broken cables, cable ends whipping around, machine tipping, chemical burns, infections and other causes.**

1. Make sure that machine and work area is properly set-up and that the work area is free of bystanders and other distractions.
2. Pull cable out of machine and feed into drain. At least one foot (.3m) of cable must be in drain so that the end of the cable will not come out of the drain and whip around when the machine is started.

Directly route the cable from the outlet of the machine to the drain opening, minimizing exposed cable and changes in direction. Do not tightly bend the cable – this can increase the risk of twisting or breaking.

3. Assume a proper operating position to help maintain control of the cable and machine (see Figure 9):
  - Be sure you can control the foot switch. Do not press foot switch yet. In case of emergency, you must be able to release the foot switch.
  - Be sure that you have good balance, do not have to overreach, and cannot fall on the foot switch, drain cleaning machine, the drain or other hazards.
  - You must be able to control and support the guide hose and AUTOFEED unit levers as the cable feeds into the drain and blockage.
  - You must be able to reach the FOR/OFF/REV switch.



Figure 8 – In Operating Position

4. Move the FOR/OFF/REV switch to the FOR position. Do not depress the foot switch yet. Do not rotate the cable in reverse except as specifically described in these instructions. Running the drain cleaner in REV can damage the cable.

### Feeding the Cable into the Drain

Grasp the AUTOFEED unit with one hand and hold it so that the end of the unit is within 6" (15cm) of the drain

opening (See Figure 7). The guide hose helps to protect the fixture from damage and contain the liquid thrown off the cable as it is retrieved from the drain. If the AUTOFEED unit is not kept within 6" (15cm) of the drain opening, the cable will not be properly supported and may allow the cable to twist, kink or break.

Pay attention to how the guide hose feels in your hand. Because the guide hose is over the cable, there is less sensitivity to the loading of the cable, and it can be hard to tell if the cable end is rotating or not. If the cable end is not rotating, the drain is not being cleaned.



**Figure 9 – Advance/Retrieve Feed Lever**

Confirm at least one foot of cable is in drain and end of AUTOFEED unit is less than 6" (15cm) from drain opening. Press on the foot switch to start the machine. To advance the cable into the drain, depress the ADVANCE feed lever (Figure 9). The rotating cable will work its way into the drain.

### Passing Through Traps or Other Transitions

If it is hard to get the cable through a trap, the following methods or combination of methods can be used.

- First, sharp downward thrusts on the cable/guide hose, both with and without the cable rotating, can help to get the cable through a trap.
- A second method is to run the drain cleaner in REV (REVERSE) for several seconds while pushing down on the cable/guide hose. Only do this long enough to get the cable started through the trap. Running the cable in reverse can damage the cable. With the cable rotating in REV, the ADVANCE feed lever retrieves the cable and the RETRIEVE feed lever advances the cable.

If these options do not work, consider using a smaller diameter or more flexible cable, or a different RIDGID drain cleaner.

### Cleaning the Drain

Always keep at least one hand on the guide hose/AUTOFEED unit. Pay attention how the guide hose feels in your hand and watch the drum rotation.

As you feed the cable into the drain, you may feel and see the cable/drum slow down and feel the guide hose start to load or wind up (this will feel like the guide hose is starting to twist or squirm). This may be a transition in the drain line (trap, elbow, etc.) build up in the drain (grease, etc.), or the actual blockage. Feed the cable slowly and carefully. Do not let cable build up outside drain. This can cause the cable to twist, kink or break. Keep end of AUTOFEED unit within 6" (15cm) of drain opening.

Pay attention to the amount of cable that has been fed into the drain. Feeding cable into a larger drain line or similar transition may cause the cable to kink or knot and prevent removal from the drain. Minimize the amount of cable fed into the transition to prevent problems. The amount of cable in the drum can be monitored through the clear front housing (Figure 10).

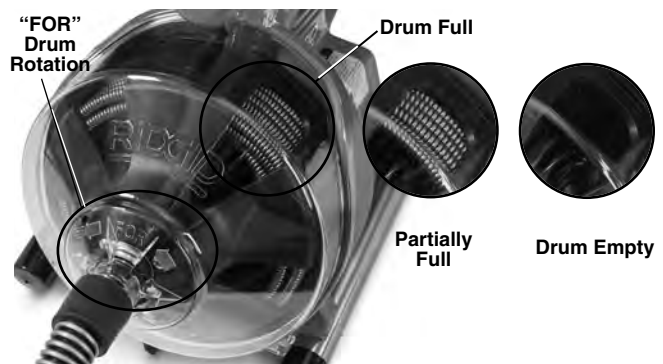

**Figure 10 – Monitoring Cable in Drum**

### Working the Blockage

If the end of the cable stops turning, it is no longer cleaning the drain. If the cable end becomes lodged in the blockage and power is maintained to the drain cleaner, the cable will start to wind up (this may feel like the guide hose is starting to twist or squirm) or buildup outside the drain. Having a hand on the guide hose can allow you to feel this wind up and control the cable. As you feel the cable wind up or if the cable end stops turning, immediately release the ADVANCE feed and depress the RETRIEVE feed lever to free the cable end from the blockage. Do not keep the cable rotating if the cable end is stuck in a blockage. If the cable end stops turning and the drum keeps rotating, the cable can twist, kink or break.

Once the cable end is free of the blockage and the cable end is turning again, you can slowly feed the rotating cable end back into the blockage. Let the spinning cable end "dwell" in the blockage to completely break it up. Do not try to force the cable end through the blockage. Work the cable end in this manner until it has moved completely past the blockage (or blockages), and the drain is flowing.

While working the blockage, the cable end may become clogged with debris and cuttings from the blockage. This can prevent further progress. The cable needs to be retrieved from the drain and the debris removed. See section on “Retrieving the Cable”.

If the cable end continues to get hung up in the blockage, a different RIDGID drain cleaner may need to be used.

### Handling a Stuck Tool

If the cable end stops turning and the cable cannot be pulled back from the blockage, release the foot switch, maintain a firm grip on the AUTOFEED unit and guide hose and release the feed lever. Do not remove your hand from guide hose or the cable may kink, twist and break. The motor will stop and the cable and drum will turn backwards until the energy stored in the cable is relieved. Do not remove hand from the AUTOFEED unit and guide hose until the tension is released. Place FOR/OFF/REV switch in the OFF position.

### Freeing a Stuck Tool

If the cable is stuck in the blockage, hold the FOR/OFF/REV switch in the REV position. With both AUTOFEED levers released press the foot switch for several seconds until it is free of the blockage. Do not operate the machine in the REV position any longer than required to free the cable end from the blockage or cable damage can occur. Place the FOR/OFF/REV switch in the FOR position and continue cleaning the drain.



Figure 11 – Retrieving Cable

### Retrieving the Cable

1. Once the drain is open, if possible start a flow of water down the drain to flush the debris out of the line and help clean the cable as it is retrieved. This can be done by turning on a faucet in the system or other methods. Pay attention to the water level, as the drain could plug again.
2. The FOR/OFF/REV switch should be in the FOR position – do not retrieve the cable with the switch in the REV position, this can damage the cable. As with feeding the cable into the drain, cables can be caught while being retrieved.  
Depress the RETRIEVE feed lever to retrieve the cable (Figure 11). Keep hands firmly on the AUTOFEED unit and guide hose for control. The cable end can become caught while being retrieved. Continue retrieving the cable until the tool is just inside the drain opening. Release the feed lever.
3. Release the foot switch, allowing the drum to come to a complete stop. Do not pull the end of the cable from the drain while the cable is rotating. The tool can whip around and could cause serious injury.
4. Place the FOR/OFF/REV in the OFF position and with dry hands unplug the machine. Pull the remaining cable from the drain by hand and feed into the drain cleaner. If needed, continue cleaning following the above process. Several passes through a line are recommended for complete cleaning.

### Draining the Machine

If the machine needs to be drained, turn machine OFF, and with dry hands, unplug the machine. Remove the drain plug (See Figure 1) and drain. The back end of the machine can be elevated if necessary.

### Preparing for Transport

Wrap cord and foot switch hose on cord wrap. Secure as shown in Figure 12. Secure AUTOFEED on hook.



Figure 12 – Preparing For Transport

## Maintenance Instructions

### **⚠ WARNING**

**FOR/OFF/REV switch should be OFF and machine unplugged before performing any maintenance.**

**Always wear safety glasses and other appropriate protective equipment when performing any maintenance.**

### Opening Drain Cleaner/Removing Drum

To open the machine to clean or change cable:

1. If needed, drain the machine. Remove guide hose (see *Assembly section*).
2. Feed cable into drum.
3. Loosen (but don't remove) the three (3) cover screws. (see *Figure 13*).
4. Pull front housing straight off.
5. Remove drum by pulling straight forward.
6. Reverse the process to reassemble. Drum may need to be rotated to seat onto the drive. Make sure drum washer is properly placed on drum.



**Figure 13 – Opening Drain Cleaner**

### Cleaning

After each use, clean the machine. Remove the guide hose and drum/cable from the machine. A mild detergent or antibacterial solution can be used if desired. Do not use solvents, abrasives or other harsh cleaning agents.

**Machine** – use a damp, soft cloth to wipe off the machine and wipe out the drum cavity. Do not submerge or flush the machine with water. Do not allow water to enter motor or other electrical components. Make sure unit is completely dry before plugging in and using.

**Front Housing** – Remove from machine, flush with water and wipe clean with a damp, soft cloth.

**Drum and Cable** – Flush drum and cable with water after every use to prevent damaging effects of sediment and drain cleaning compounds. Allow to dry before installing drum to reduce cable corrosion.

**AUTOFEED Unit** – Flush AUTOFEED assembly with water and lubricate with lightweight machine oil.

**Guide Hose** – Flush with water and drain.

### Replacing the Cable

1. Remove the guide hose (see *Assembly section*) and the front housing/drum (*Figure 13*).
2. Pull the cable out of the front of the drum.
3. Remove five (5) screws holding back of the drum (*Figure 14*).
4. Disconnect the cable end from the drum back (*Figure 15*). Completely remove cable from drum.
5. Feed the end of the new cable through the outlet of the drum. Attach end to the drum back as shown in *Figure 15*.

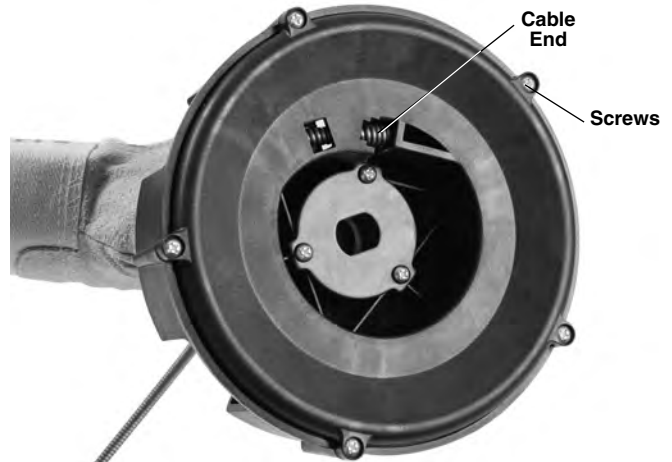

**Figure 14 – Removing Drum Back**

6. Place the drum on back and manually feed the new cable into the drum.

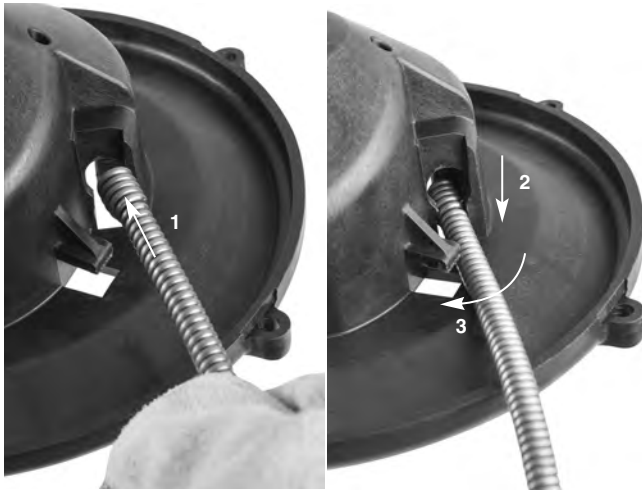

Figure 15 – Attaching Cable To Inner Drum

- Place the drum into the machine (Figure 16). Rotate the drum until it seats into place.



Figure 16 – Inserting Drum Into Machine

- Install the front housing and guide hose.

## Optional Equipment

### **⚠ WARNING**

To reduce the risk of serious injury, only use accessories specifically designed and recommended for use with the RIDGID PowerClear Drain Cleaning Machine, such as those listed below.

	Catalog No.	Model No.	Description
	41937	—	RIDGID Drain Cleaning Gloves, Leather
	55983	—	1/4" x 30' (6mm x 9.1m) MAXCORE™ 50 Cable

Further information on equipment available for PowerClear Drain Cleaning Machine can be found in the RIDGID Catalog and online at RIDGID.com.

## Machine Storage

**⚠ WARNING** The drain cleaner must be kept dry and indoors or well covered if kept outdoors. Store the machine in a locked area that is out of reach of children and people unfamiliar with drain cleaners. This machine can cause serious injury in the hands of untrained users.

## Service and Repair

### **⚠ WARNING**

Improper service or repair can make the machine unsafe to operate.

The *Maintenance Instructions* will take care of most of the service needs of this machine. Any problems not addressed by this section should only be handled by an authorized RIDGID service technician.

Tool should be taken to a RIDGID Independent Service Center or returned to the factory. Use only RIDGID service parts.

For information on your nearest RIDGID Independent Service Center or any service or repair questions.

## Disposal

Parts of the PowerClear Drain Cleaning Machine contain valuable materials and can be recycled. There are companies that specialize in recycling that may be found locally. Dispose of the components in compliance with all applicable regulations. Contact your local waste management authority for more information.



**For EC Countries:** Do not dispose of electrical equipment with household waste!

According to the European Guideline 2012/19/EU for Waste Electrical and Electronic Equipment and its implementation into national legislation, electrical equipment that is no longer usable must be collected separately and disposed of in an environmentally correct manner.

## Troubleshooting

<b>PROBLEM</b>	<b>POSSIBLE REASONS</b>	<b>SOLUTION</b>
<b>Cable kinking or breaking.</b>	Cable is being forced. Cable used in incorrect pipe diameter. Motor switched to reverse. Cable exposed to acid. Cable worn out. Cable not properly supported.	Do Not Force Cable! Let the auger do the work. Use correct cable for pipe. Use reverse only if cable gets caught in blockage. Clean cables routinely. If cable is worn, replace it. Support cable properly, see instructions.
<b>Cable stops rotating while foot switch is depressed. Restarts when foot switch is re-depressed.</b>	Hole in foot switch or hose. Hole in diaphragm switch.	Replace damaged component. If no problem found with pedal or hose, replace diaphragm switch.
<b>Cable turns in one direction but not the other.</b>	Faulty FOR/OFF/REV switch.	Replace switch.
<b>Ground Fault Circuit Interrupter trips when machine is plugged in or when foot pedal is depressed.</b>	Damaged power cord. Short circuit in motor. Faulty Ground Fault Circuit Interrupter. Moisture in motor, switch box or on plug.	Replace cord set. Take motor to your nearest RIDGID Independent Service Center. Replace cord set. Take drain cleaner to your nearest RIDGID Independent Service Center.
<b>AUTOFEED unit doesn't work.</b>	AUTOFEED unit full of debris. AUTOFEED unit needs lubrication.	Clean the AUTOFEED unit. Lubricate the AUTOFEED unit with lightweight machine oil.
<b>Machine wobbles or moves while cleaning drain.</b>	Cable not evenly distributed. Bumpers are not on ground. Ground not level.	Pull all cable out and feed again, evenly distribute. Place on level stable surface. Place on level stable surface.



**What is covered**

RIDGID® tools are warranted to be free of defects in workmanship and material.

**How long coverage lasts**

This warranty lasts for the lifetime of the RIDGID® tool. Warranty coverage ends when the product becomes unusable for reasons other than defects in workmanship or material.

**How you can get service**

To obtain the benefit of this warranty, deliver via prepaid transportation the complete product to RIDGE TOOL COMPANY, Elyria, Ohio, or any authorized RIDGID® INDEPENDENT SERVICE CENTER. Pipe wrenches and other hand tools should be returned to the place of purchase.

**What we will do to correct problems**

Warranted products will be repaired or replaced, at RIDGE TOOL'S option, and returned at no charge; or, if after three attempts to repair or replace during the warranty period the product is still defective, you can elect to receive a full refund of your purchase price.

**What is not covered**

Failures due to misuse, abuse or normal wear and tear are not covered by this warranty. RIDGE TOOL shall not be responsible for any incidental or consequential damages.

**How local law relates to the warranty**

Some states do not allow the exclusion or limitation of incidental or consequential damages, so the above limitation or exclusion may not apply to you. This warranty gives you specific rights, and you may also have other rights, which vary, from state to state, province to province, or country to country.

**No other express warranty applies**

This FULL LIFETIME WARRANTY is the sole and exclusive warranty for RIDGID® products. No employee, agent, dealer, or other person is authorized to alter this warranty or make any other warranty on behalf of the RIDGE TOOL COMPANY.

©2016, 2018 RIDGID, Inc.

The Emerson logo and RIDGID logo are registered trademarks of Emerson Electric Co. or RIDGID, Inc. in the U.S. and other countries. All other trademarks belong to their respective holders.

999-995-082.10  
REV. C

Printed 3/18  
EC43372

**RIDGID**

**Test Equipment  
Depot**  
1-800-517-8431

99 Washington Street  
Melrose, MA 02176  
Phone 781-665-1400  
Toll Free 1-800-517-8431



Visit us at [www.TestEquipmentDepot.com](http://www.TestEquipmentDepot.com)

  
**EMERSON**