

## User Guide

# 3-Phase Power Analyzer/Datalogger

## MODEL PQ3450

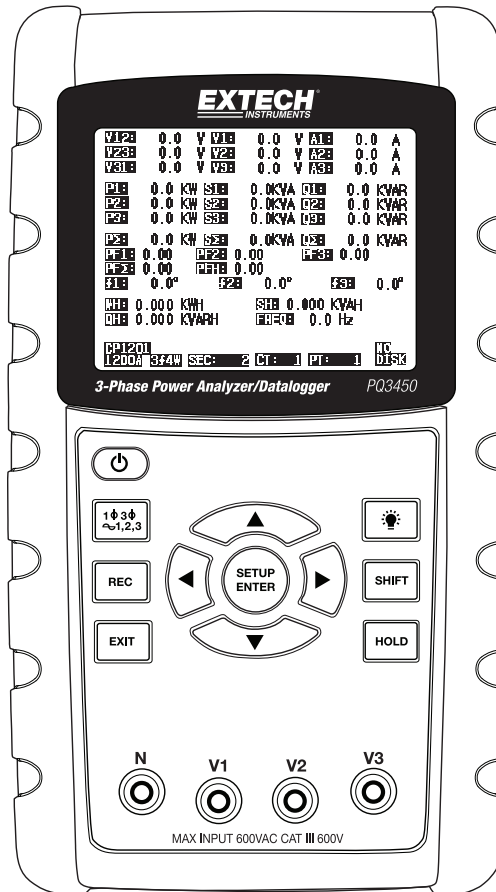

# Table of Contents

---

|  |          |
|--|----------|
| <b>1.0 INTRODUCTION</b>                                    |          |
| 1-1 Features .....   | 3        |
| 1-2 Safety .....   | 4        |
| <b>2.0 SPECIFICATIONS</b>                                  |          |
| 2-1 General Specifications .....                           | 5        |
| 2-2 Electrical Specifications.....                         | 6        |
| <b>3.0 METER DESCRIPTION.....</b>                          | <b>7</b> |
| <b>4.0 METER BASICS AND THE SETUP MODE</b>                 |          |
| 4-1 Initialization Screen .....                            | 8        |
| 4-2 Measurement Screen Example .....                       | 8        |
| 4-3 Keypad Summary.....                                    | 9        |
| 4-4 Setup Mode Basics .....                                | 9        |
| 4-5 Setup Mode In Detail.....                              | 11       |
| <b>5.0 POWER MEASUREMENT PROCEDURES</b>                    |          |
| 5-1 1 $\Phi$ 2W (single phase two wire) measurement .....  | 17       |
| 5-2 1 $\Phi$ 3W (single phase three wire) measurement..... | 18       |
| 5-3 3 $\Phi$ 3W (three phase three wire) measurement.....  | 19       |
| 5-4 3 $\Phi$ 4W (three phase four wire) measurement.....   | 20       |
| 5-5 CT and PT measurement .....                            | 21       |
| 5-6 Data Logger.....                                       | 22       |
| 5-7 Data Hold .....  | 23       |
| 5-8 Display Backlight key .....                            | 23       |
| 5-9 LOWBAT (Low Battery) screen .....                      | 23       |
| 5-10 Measurement Definitions.....                          | 24       |
| 5-11 Reset Button.....                                     | 24       |
| 5-12 Watt-Hour ZERO Function .....                         | 24       |
| <b>6.0 MAINTENANCE</b>                                     |          |
| 6-1 Cleaning .....   | 25       |
| 6-2 Battery Replacement.....                               | 25       |
| <b>7.0 PC INTERFACE</b>                                    |          |
| 7-1 Download Data from SD Card.....                        | 26       |

# 1.0 Introduction

---

Congratulations on your purchase of the Model PQ3450 Power Analyzer/datalogger. This instrument is fully tested and calibrated prior to delivery; proper use and care of this meter will provide years of reliable service.

## 1.1 Features

- Large dot-matrix, numerical, backlit LCD
- Full system analysis with more than 30 parameters:
  - Voltage (phase-to-phase) and Voltage (phase-to-ground)
  - Current (Amps) phase-to-ground
  - KW / KVA / KVAR / PF (phase)
  - KW / KVA / KVAR / PF (system)
  - KWH / KVAH / KVARH / PFH (system)
  - Phase angle
- 600.0VAC input with CAT III-600V safety rating
- Adjustable Current Transformer (CT) and Potential Transformer (PT) ratio for high power distribution systems
- Log up to 30,000 reading on removable SD memory card in Excel® format
- Wide sampling rate range (from 2 seconds up to 2 hours)
- Easy-to-use onscreen menu
- Easy-to-hold rugged over-molded housing

## 1.2 Safety

- CAUTION: Risk of electric shock. Do not attempt to open or disassemble the meter while taking measurements
- CAUTION: Do not attempt to measure Voltage or Current that exceeds specified limits
- Do not operate this instrument in wet or dusty environments.
- Do not operate this instrument in the presence of combustible or explosive gas
- Do not touch exposed metal parts or unused terminals.
- Consider the use of rubber gloves in operation.
- Do not operate in excess of AC 500V (Phase to Neutral), or AC 600V (Phase to Phase)
- Do not operate this instrument if it appears to be malfunctioning
- Remove the test leads from the meter before opening the battery compartment cover
- When cleaning, use only a dry cloth to wipe the meter housing. Do not use liquids of any kind to clean the meter
- Safety Symbols:

CAUTION



DOUBLE INSULATION



RISK OF ELECTRIC SHOCK



### Environmental Conditions

- Installation Category III 600V
- Pollution Degree 2
- Altitude limit: 2000m
- Indoor use only
- Relative Humidity maximum: 80%

## 2.0 Specifications

### 2.1 General Specifications

|                          |  |              |
|--------------------------|--|--------------|
| Circuit                  | Custom single-chip microprocessor LSI circuit  |              |
| Display                  | LCD Size: 81.4 X 61 mm (3.2 X 2.4")<br>Dot Matrix backlit LCD (320 X 240 pixels)   |              |
| Measurements             | V (voltage phase to phase)<br>V (voltage phase to ground)<br>A (Current Phase to ground)<br>KW / KVA/ KVAR / PF (Phase)<br>KW / KVA/ KVAR / PF (System)<br>Power factor<br>Phase angle<br>Frequency  |              |
| Wire configurations      | 1P/2W, 1P/3W, 3P/3W, 3P/4W   |              |
| Voltage ranges           | 10 ACV to 600 ACV (Auto Range)   |              |
| Current ranges           | Current probe input signal voltage (ACV):<br>200mV(120mV) /2.25V/300mV/500mV/1V/2V/3V<br>Current probe input current range (ACA):<br>20A/200A/2000A(1200A)/150A/1500A/30A/300A/3000A/60A/600A/6000A<br>Note that the meter has universal probe compatibility |              |
| Safety standard          | IEC1010 CAT III 600 V  |              |
| ACV input impedance      | 10M ohms   |              |
| Range select             | ACV  | Auto Range   |
|                          | ACA  | Manual Range |
| Clamp frequency response | 40 Hz to 1 KHz   |              |
| Over-load protection     | ACV  | 720 ACV RMS  |
| Over-range               | "OL" is displayed; Data on SD card will read '9999' or '999' for over-range data   |              |
| Under-range              | "UR" is displayed  |              |
| Data Hold                | Freezes displayed reading  |              |
| Data Recording           | SD memory card   |              |
| SD Card size limits      | SD Cards up to 2G; SDHC Cards up to 16G  |              |
| Sampling Time            | Approx. 1 second (LCD) / 2000 samples per period   |              |

|                             |   |
|-----------------------------|---|
| Datalogger                  | Real time data logger saves data to SD memory card for download to PC (data files open directly to spreadsheet) |
|                             | Sampling rate: From 2 seconds to 7200 seconds (2 hours)   |
|                             | Max. File capacity: 30,000 records  |
| Data Output                 | RS232 port  |
| Operating Temperature       | 0 to 50°C (32 to 122°F)   |
| Operating Relative Humidity | 80% Relative Humidity max.  |
| Power Supply                | Eight (8) 'AA' 1.5VDC batteries or AC 9V power adapter  |
| Meter Power Consumption     | 250 mA DC   |
| Weight                      | 975g (2.1 lbs.) with batteries  |
| Dimensions                  | 225 X 125 X 64 mm (8.86 X 4.92 X 2.52")   |

## 2.2 Electrical Specifications (45 to 65Hz; 23±5°C)

| Function  | Range            | Resolution                 | Accuracy* (of reading)      |
|---|------------------|----------------------------|-----------------------------|
| <b>AC Voltage</b>   | 10.0V to 600.0V  | 0.1V                       | ± (0.5% + 0.5V + 5 digits)  |
| <b>AC Current</b>   | <20.0A           | 0.001 < 10 A<br>0.01 ≥ 10A | ± (0.5% + 0.1A + 5 digits)* |
|   | 20.01A to 200.0A | 0.01 < 100 A<br>0.1 ≥ 100A | ± (0.5% + 0.5A + 5 digits)* |
|   | >200.0A          | 0.1 < 1000A<br>1 ≥ 1000A   | ± (0.5% + 5A + 5 digits)*   |
| <b>Power Factor</b>   | 0.00 to 1.00     | 0.01                       | ± 0.04                      |
| <b>Φ Phase Angle</b>  | -180° to 180°    | 0.1°                       | ± 1° *ACOS(PF)              |
| <b>Frequency</b>  | 45 to 65Hz       | 0.1Hz                      | 0.1Hz                       |
| <b>Power</b>  | 0.0 to 3.6MW     | 0.001k to 0.001M           | ± (1% + 8 digits)           |
|   | 0.0 to 3.6MVA    |                            |                             |
|   | 0.0 to 3.6MVAR   |                            |                             |
| <b>Watt Hour</b>  | 0.0 to 3.6MWH    | 0.001k to 0.001M           | ± (1% + 8 digits)           |
|   | 0.0 to 3.6MVAH   |                            |                             |
|   | 0.0 to 3.6MVARH  |                            |                             |
| *Meter accuracy only. For system accuracy add the accuracy of the clamp used. |                  |                            |                             |

\*PF $\Sigma$  :

For 3Φ4W, 3Φ3W, 1Φ3W

$$PF\Sigma = P\Sigma / S\Sigma$$

For 1Φ2W

$$PF1 = P1 / S1$$

## 3.0 Meter Description

### Meter Front

- 3-1 LCD Display
- 3-2 ◀ Left arrow navigation
- 3-3 Power ON-OFF
- 3-4 Phase / Wire setup
- 3-5 REC datalogger memory
- 3-6 Exit button
- 3-7 Setup/Enter button
- 3-8 Measurement input terminals
- 3-9 ▼ Down arrow navigation
- 3-10 HOLD (freeze display)
- 3-11 Shift button
- 3-12 Display Backlight ON-OFF
- 3-13 ▶ Right arrow navigation
- 3-14 ▲ Up arrow navigation

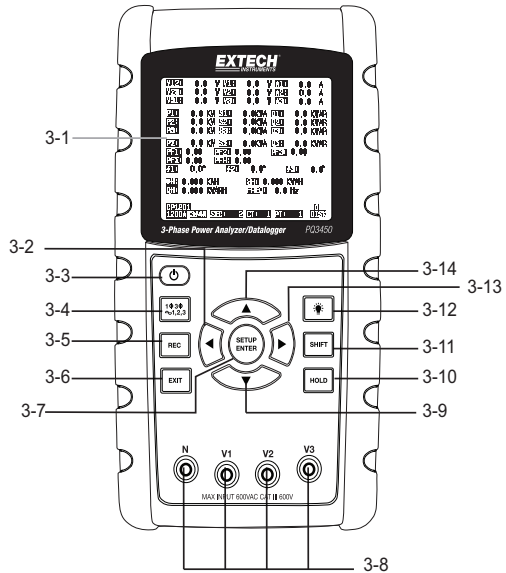

### Meter Top

- 3-15 Clamp positive input jacks
- 3-16 Clamp negative input jacks
- 3-17 Clamp power lead connections

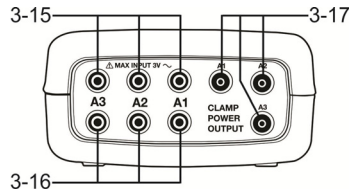

### Meter Right Side

- 3-18 9V power adaptor jack
- 3-19 SD memory card socket
- 3-20 RS232 PC interface socket
- 3-21 Reset button
- 3-22 Screw fastener for protective cap

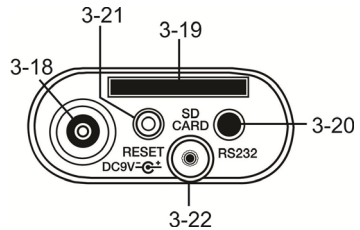

Note: The Battery compartment and Tilt Stand are located on the rear of the instrument

## 4.0 Meter Basics and Setup Mode

### 4-1 Initialization Screen

1. When the meter is switched ON the initialization screen appears.

Start-up Initialization Screen

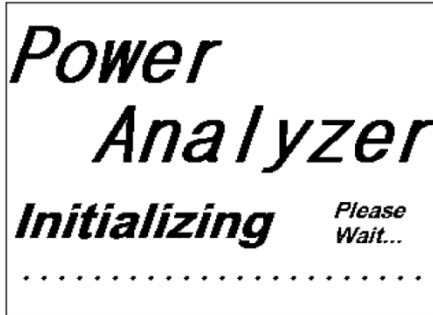

2. The meter will also check for an inserted SD memory card. 'SD check' will appear on the lower right side of the display. If an SD card is inserted, the blinking display will switch off after several seconds. When no card is inserted the display will show 'No disk'.

### 4-2 Measurement Screens



After the initialization screen, the meter displays one of the measurement screen configurations. The meter reverts to the screen that was displayed at the last power down and may not be the screen shown below. Other screen configurations are shown later in this User Guide.

Measurement Screen Example

|              |             |               |              |              |              |
|--------------|-------------|---------------|--------------|--------------|--------------|
| <b>V12:</b>  | 0.0 V       | <b>V1:</b>    | 0.0 V        | <b>A1:</b>   | 0.00 A       |
| <b>V23:</b>  | 0.0 V       | <b>V2:</b>    | 0.0 V        | <b>A2:</b>   | 0.00 A       |
| <b>V31:</b>  | 0.0 V       | <b>V3:</b>    | 0.0 V        | <b>A3:</b>   | 0.00 A       |
| <b>P1:</b>   | -0.000 KW   | <b>S1:</b>    | 0.000KVA     | <b>Q1:</b>   | -0.000 KVAR  |
| <b>P2:</b>   | -0.000 KW   | <b>S2:</b>    | 0.000KVA     | <b>Q2:</b>   | -0.000 KVAR  |
| <b>P3:</b>   | -0.000 KW   | <b>S3:</b>    | 0.000KVA     | <b>Q3:</b>   | -0.000 KVAR  |
| <b>PΣ :</b>  | -0.000 KW   | <b>SΣ :</b>   | 0.000KVA     | <b>QΣ :</b>  | -0.000 KVAR  |
| <b>PF1:</b>  | -0.00       | <b>PF 2:</b>  | -0.00        | <b>PF 3:</b> | -0.00        |
| <b>PFΣ :</b> | 0.00        | <b>PF H:</b>  | 0.00         |              |              |
| <b>Φ 1:</b>  | - 0.0°      | <b>Φ 2:</b>   | - 0.0°       | <b>Φ 3:</b>  | - 0.0°       |
| <b>WH:</b>   | 0.000 KWH   | <b>SH:</b>    | 0.000KVAH    |              |              |
| <b>QH:</b>   | 0.000 KVARH | <b>FREQ:</b>  | 0.0 Hz       |              |              |
| <b>1201</b>  |             |               |              |              | <b>SD</b>    |
| 20A          | <b>3Φ4W</b> | <b>SEC: 2</b> | <b>CT: 1</b> | <b>PT: 1</b> | <b>Check</b> |



## 4.3 Keypad Summary

- **POWER**  : Press and hold to power ON/OFF
- **1Φ 3Φ** (phase/wire) : Select (1P/2W, 1P/3W, 3P/3W, 3P/4W) measurement function
- **REC** : Data record key for use with the SD Memory Card
- **HOLD** : Freeze the displayed reading
- **BACKLIGHT**  : Switch LCD backlight ON/OFF
- **SETUP/ENTER** : Enter the Setup mode. Also used as an Enter key to confirm entries
- **EXIT** : Exit a screen when programming
- **SHIFT** ( : Programming key for use in the Setup Mode
- **Up arrow** ▲ : Generally, press to move the cursor up or to change a parameter value, however use varies with each particular function
- **Down arrow** ▼ : Generally, press to move the cursor down or to change a parameter value, however use varies with each particular function
- **Left arrow** ◀ : Use varies according to a particular function
- **Right arrow** ▶ : Use varies according to a particular function

## 4.4 Setup Mode

### 4.4.1 Setup Mode Basics

1. Press the SETUP button to access the Setup Mode. The screen shown below will appear on the meter's LCD.
2. Use the up and down arrow keys to scroll through the parameters.
3. Press the SHIFT key to open a particular parameter for editing (the 'SHIFT 1' display icon will be visible on the upper right hand corner of the LCD).
4. Once a parameter is opened for editing (parameter variable highlighted), use the up and down arrow keys to edit the setting.
5. When the SHIFT key is pressed on the FILE NAME parameter, the user can select the first half of the file name which is the configuration (3P4, for example). When the SHIFT keys is pressed again, the SHIFT 2 icon appears on the display and the user can select the second half of the file name (10001.XLS, for example). This applies only to the FILENAME parameter.
6. Press the SHIFT key to continue scrolling through the other parameters using the up and down arrow keys.
7. To exit the Setup Mode press the EXIT key.
8. Detailed instructions for each parameter are provided in the next section.

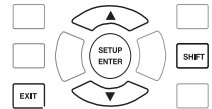

## Setup Mode Screen

|                       |              |                     |                       |               |               |              |
|-----------------------|--------------|---------------------|-----------------------|---------------|---------------|--------------|
| <b>Folder Name:</b>   |              | WTA01               |                       |               |               | <b>SETUP</b> |
| <b>File Name:</b>     |              | 3P401001.XLS        |                       |               |               |              |
| <b>REC Date:</b>      |              | 2008-11-28 00:03:17 |                       |               |               |              |
| <b>Sampling Time:</b> |              | 2                   |                       |               |               |              |
| <b>Delete File:</b>   |              | 0 %                 | <b>Decimal:</b>       |               | USA (.)       |              |
| <b>SD Format:</b>     |              | 0 %                 | <b>Clamp Type:</b>    |               | Other         |              |
| <b>Use Size:</b>      |              | 388 KB              | <b>A</b>              | <b>Range:</b> |               | 20A          |
| <b>Free Size:</b>     |              | 1946 MB             | <b>V</b>              | <b>Range:</b> |               | 200mV        |
| <b>Total Size:</b>    |              | 1946 MB             | <b>RS232 Out Sel:</b> |               |               |              |
| <b>PT:</b>            |              | 1 : 1               | <b>V1</b>             | <b>I1</b>     | <b>P1</b>     |              |
| <b>CT:</b>            |              | 1 : 1               | <b>S1</b>             | <b>Q1</b>     | <b>PF1</b>    |              |
| <b>Beep:</b>          |              | ON                  | <b>EX1</b>            | <b>WH</b>     | <b>FREQ</b>   |              |
| <b>Year</b>           | <b>Month</b> | <b>Date</b>         | <b>Hour</b>           | <b>Minute</b> | <b>Second</b> |              |
| 2010                  | 11           | 13                  | 14                    | 37            | 25            |              |

### 4.4.2 The Setup Mode Parameter Menu

- **Folder Name:** Select a file name on the SD CARD; the range is WTA01 to WTA10
- **File Name:** Set a file name on the SD CARD (50 filenames are permitted)
- **REC Date:** Show a file's date-time stamp (Year / Month / Date / Hour / Min / Sec)
- **Sampling Time:** Set the datalogger sampling rate from 2 to 7200 seconds
- **Delete File:** Delete an existing data file from the SD CARD
- **SD Format:** Format the SD CARD
- **PT:** Set Potential Transformer ratio (1 to 1000); **CT:** Set Current Transformer ratio (1 to 600)
- **Audible Tone:** Set the beeper ON or OFF
- **Clamp Type:** Select the clamp type from the menu list
- **A (Amps):** Set the Current range; **V (Volts):** Set the Voltage range
- **RS232 Out Select:** RS232 output function (up to nine items can be output)
- **Year, Month, Date, Hour, Minute, Second:** Set the current date and time

## 4.5 Setup Mode in Detail

Press SETUP to enter the Setup Mode, selected items will appear highlighted (reverse video). Use the up and down arrow keys to move through the available parameters and use the Shift key to open a parameter for editing. Once a parameter is opened for editing, the up and down arrow keys are used again to change a parameter's setting. The SHIFT key is then used to return to Setup Mode editing where the arrow keys are used again for scrolling. Use the EXIT key to leave the Setup Mode.

### 4.5.1 Folder name: Set a Folder Name on the SD Memory Card

1. Scroll to the FOLDER NAME field using the up and down arrow keys if necessary
2. The Folder Name range is "WTA01" to "WTA10"
3. Press Shift to open the Folder Name parameter for editing
4. Use the arrow keys ▲ ▼ to select a folder number; the available numbers are "01 to 10" (Note: Press and hold ▲ or ▼ continuously for at least two seconds to scroll quickly).
5. Press SHIFT when done

#### Folder Name Screen 1

|                |                     |             |          |        |        |       |
|----------------|---------------------|-------------|----------|--------|--------|-------|
| Folder Name:   | WTA01               |             |          |        |        | SETUP |
| File Name:     | 3P401001.XLS        |             |          |        |        |       |
| REC Date:      | 2008-11-28 00:03:17 |             |          |        |        |       |
| Sampling Time: | 2                   |             |          |        |        |       |
| Delete File:   | 0 %                 | Decimal:    | USA (.)  |        |        |       |
| SD Format:     | 0 %                 | Clamp Type: | Other    |        |        |       |
| Use Size:      | 388 KB              | A           | Range:   | 20A    |        |       |
| Free Size:     | 1946 MB             | V           | Range:   | 200mV  |        |       |
| Total Size:    | 1946 MB             | RS232       | Out Sel: |        |        |       |
| PT:            | 1 : 1               | V1          | I1       | P1     |        |       |
| CT:            | 1 : 1               | S1          | Q1       | PF1    |        |       |
| Beep:          | ON                  | EX1         | WH       | FREQ   |        |       |
| Year           | Month               | Date        | Hour     | Minute | Second |       |
| '2010          | '11                 | '13         | '14      | '37    | '25    |       |

#### Folder Name Screen 2

|                |                     |             |          |        |        |       |
|----------------|---------------------|-------------|----------|--------|--------|-------|
| Folder Name:   | WTA01               |             |          |        |        | SETUP |
| File Name:     | 3P401001.XLS        |             |          |        |        | SHIFT |
| REC Date:      | 2008-11-28 00:03:17 |             |          |        |        |       |
| Sampling Time: | 2                   |             |          |        |        |       |
| Delete File:   | 0 %                 | Decimal:    | USA (.)  |        |        |       |
| SD Format:     | 0 %                 | Clamp Type: | Other    |        |        |       |
| Use Size:      | 388 KB              | A           | Range:   | 20A    |        |       |
| Free Size:     | 1946 MB             | V           | Range:   | 200mV  |        |       |
| Total Size:    | 1946 MB             | RS232       | Out Sel: |        |        |       |
| PT:            | 1 : 1               | V1          | I1       | P1     |        |       |
| CT:            | 1 : 1               | S1          | Q1       | PF1    |        |       |
| Beep:          | ON                  | EX1         | WH       | FREQ   |        |       |
| Year           | Month               | Date        | Hour     | Minute | Second |       |
| '2010          | '11                 | '13         | '14      | '37    | '25    |       |

#### 4.5.2 File name: Set a file name in the SD Memory Card

1. In the Setup Mode, scroll down to the FILE NAME parameter using the up and down arrow keys
2. The screen will show the "NO FILE" indicator in the REC Date option area when the selected file is new .
3. The screen will show the recording date and time in the REC Date option area for existing data files .

**File Name Screen1**

|                |               |             |          |        |        |               |
|----------------|---------------|-------------|----------|--------|--------|---------------|
| Folder Name:   | WTA01         |             |          |        |        | <b>SETUP</b>  |
| File Name:     | 3P4 01001.XLS |             |          |        |        | <b>SHIFT1</b> |
| REC Date:      | NO File       |             |          |        |        |               |
| Sampling Time: | 2             |             |          |        |        |               |
| Delete File:   | 0 %           | Decimal:    | USA (.)  |        |        |               |
| SD Format:     | 0 %           | Clamp Type: | Other    |        |        |               |
| Use Size:      | 388 KB        | A           | Range:   | 20A    |        |               |
| Free Size:     | 1946 MB       | V           | Range:   | 200mV  |        |               |
| Total Size:    | 1946 MB       | RS232       | Out Sel: |        |        |               |
| PT:            | 1 : 1         | V1          | I1       | P1     |        |               |
| CT:            | 1 : 1         | S1          | Q1       | PF1    |        |               |
| Beep:          | ON            | EX1         | WH       | FREQ   |        |               |
| Year           | Month         | Date        | Hour     | Minute | Second |               |
| 2010           | '11           | '13         | '14      | '37    | '25    |               |

**File Name Screen 2**

|                  |                     |             |          |        |        |              |
|------------------|---------------------|-------------|----------|--------|--------|--------------|
| Folder Name:     | WTA01               |             |          |        |        | <b>SETUP</b> |
| <b>File Name</b> | 3P401001.XLS        |             |          |        |        |              |
| REC Date:        | 2008-11-28 00:03:17 |             |          |        |        |              |
| Sampling Time:   | 2                   |             |          |        |        |              |
| Delete File:     | 0 %                 | Decimal:    | USA (.)  |        |        |              |
| SD Format:       | 0 %                 | Clamp Type: | Other    |        |        |              |
| Use Size:        | 388 KB              | A           | Range:   | 20A    |        |              |
| Free Size:       | 1946 MB             | V           | Range:   | 200mV  |        |              |
| Total Size:      | 1946 MB             | RS232       | Out Sel: |        |        |              |
| PT:              | 1 : 1               | V1          | I1       | P1     |        |              |
| CT:              | 1 : 1               | S1          | Q1       | PF1    |        |              |
| Beep:            | ON                  | EX1         | WH       | FREQ   |        |              |
| Year             | Month               | Date        | Hour     | Minute | Second |              |
| 2010             | '11                 | '13         | '14      | '37    | '25    |              |

4. Press the SHIFT button. The "SHIFT 1" icon will appear on the upper right side of the screen and the first half of the File Name which represents the number of wires and phases (3P4, for example) will be highlighted and ready for editing. Use the arrow keys to select the desired configuration. Select 1P/2W (1P2), 1P/3W (1P3), 3P/3W (3P3), or 3P/4W (3P4).

5. Press SHIFT again and the “SHIFT 2” icon will appear on the upper right side of the screen and the second half of the File Name, which the user can customize as needed, will be highlighted. Use the arrow keys to select a number between 001 and 0050 inclusive. .
6. File Name Examples:
  - a. **1P201001**: 1P2 is one phase by two wires, 01 is the folder number, and 001 is the file number
  - b. **1P301001**: 1P3 is one phase by three wires, 01 the folder number, and 001 the file number
  - c. **3P301001**: 3P3 is three phases by three wires, 01 the folder number, and 001 the file number.
  - d. **3P401001**: 3P4 is three phases by four wires, 01 the folder number, and 001 the file number.
7. Press the SHIFT key again to continue with the Setup Mode editing.

### File Name Screens

|                                 |                   |               |
|---------------------------------|-------------------|---------------|
| Folder Name: WTA01              |                   | <b>SETUP</b>  |
| File Name: <b>3P4</b> 01001.XLS |                   | <b>SHIFT1</b> |
| REC Date: NO File               |                   |               |
| Sampling Time: 2                |                   |               |
| Delete File: 0 %                | Decimal: USA (.)  |               |
| SD Format: 0 %                  | Clamp Type: Other |               |
| Use Size: 388 KB                | A Range: 20A      |               |
| Free Size: 1946 MB              | V Range: 200mV    |               |
| Total Size: 1946 MB             | RS232 Out Sel:    |               |
| PT: 1 : 1                       | V1 I1 P1          |               |
| CT: 1 : 1                       | S1 Q1 PF1         |               |
| Beep: ON                        | EX1 WH FREQ       |               |
| Year                            | Month             | Date          |
| 2010                            | '11               | '13           |
|                                 |                   | Hour          |
|                                 |                   | '14           |
|                                 |                   | Minute        |
|                                 |                   | '37           |
|                                 |                   | Second        |
|                                 |                   | '25           |

|                                 |                   |               |
|---------------------------------|-------------------|---------------|
| Folder Name: WTA01              |                   | <b>SETUP</b>  |
| File Name: 3P4 <b>01001.XLS</b> |                   | <b>SHIFT2</b> |
| REC Date: NO File               |                   |               |
| Sampling Time: 2                |                   |               |
| Delete File: 0 %                | Decimal: USA (.)  |               |
| SD Format: 0 %                  | Clamp Type: Other |               |
| Use Size: 388 KB                | A Range: 20A      |               |
| Free Size: 1946 MB              | V Range: 200mV    |               |
| Total Size: 1946 MB             | RS232 Out Sel:    |               |
| PT: 1 : 1                       | V1 I1 P1          |               |
| CT: 1 : 1                       | S1 Q1 PF1         |               |
| Beep: ON                        | EX1 WH FREQ       |               |
| Year                            | Month             | Date          |
| 2010                            | '11               | '13           |
|                                 |                   | Hour          |
|                                 |                   | '14           |
|                                 |                   | Minute        |
|                                 |                   | '37           |
|                                 |                   | Second        |
|                                 |                   | '25           |

#### 4.5.3 Set the Sampling Time (datalogging rate) for recording onto the SD Memory Card

1. In the Setup Mode, use the up and down arrow keys to scroll to the SAMPLING TIME field.
2. Press the SHIFT key and the symbol "SHIFT1" will switch ON.
3. Use the arrow keys to adjust the sampling time; the range is 2 to 7200 seconds.
4. Press the SHIFT key again to return to Setup Mode editing.

#### 4.5.4 Delete a file on the SD Memory Card

1. In the Setup Mode, scroll to the DELETE FILE field using the up and down arrow keys.
2. Press and hold the SETUP/ENTER key for at least 2 seconds and the indicators “Y” and “N” will appear next to the DELETE FILE field. Use the right and left arrow keys to highlight “Y” for YES or “N” for NO and then momentarily press the SETUP/ENTER key.
3. If “Y” is selected, the current file will be erased. If “N” is selected, the delete process will be aborted. When a file is deleted the field next to DELETE FILE will show 100%. When a delete is aborted, the field shows 0%.

#### 4.5.5 Formatting an SD Memory Card

1. In the Setup Mode, use the arrow keys to scroll to the SD FORMAT field
2. Press and hold the SETUP/ENTER button for at least 2 seconds and the “Y” and “N” indicators will appear next to the SD FORMAT field
3. Use the right and left arrow buttons to highlight the desired letter: “Y” to confirm formatting or “N” to abort the formatting.
4. While formatting, the field next to the SD FORMAT field will show the formatting progress 0 to 100%.
5. Note that the display screen shows USE SIZE (amount of memory currently used on the SD card), FREE SIZE (amount of memory available), and TOTAL SIZE (total size of the SD card memory) below the SD FORMAT field.

#### **4.5.6 Potential Transformer (PT) Setup**

1. In the Setup Mode, use the up and down arrow keys to scroll to the PT field.
2. Press SHIFT, the display "SHIFT1" will switch ON
3. Use the ▲ or ▼ keys to adjust the PT value (the range is 1 to 1000)
4. Press SHIFT again to return to Setup Mode editing or press EXIT to leave the Setup mode.

#### **4.5.7 Current Transformer (CT) Setup**

1. In the Setup Mode, use the up and down arrow keys to scroll to the CT field.
2. Press SHIFT, the display "SHIFT1" will switch ON
3. Use the ▲ or ▼ keys to adjust the CT value (the range is 1 to 600)
4. Press SHIFT again to return to Setup Mode editing or press EXIT to leave the Setup mode.

#### **4.5.8 Audible Beeper ON/OFF**

1. In the Setup Mode, use the up and down arrow keys to scroll to the BEEP field.
2. Press SHIFT, the display "SHIFT1" will switch ON
3. Use the ▲ or ▼ keys to select ON or OFF
4. Press SHIFT again to return to Setup Mode editing or press EXIT to leave the Setup mode.

#### **4.5.9 SD Card Numerical Format (USA or European)**

Note: SD Memory Cards default to the basic numerical format (USA) whereby a period is used to separate units from tenths, for example: 20.00. European formatting uses a comma (for example: 20,00).

1. In the Setup Mode, use the up and down arrow keys to scroll to the DECIMAL field.
2. Press SHIFT, the display "SHIFT1" will switch ON
3. Use the ▲ or ▼ keys to select the desired format USA (.) or EURO (,).
4. Press SHIFT again to return to Setup Mode editing or press EXIT to leave the Setup mode.

#### 4.5.10 Set Clamp type

1. In the Setup Mode, use the up and down arrow keys to scroll to the CLAMP TYPE field.
2. Press SHIFT, the display "SHIFT1" will switch ON
3. Use the ▲ or ▼ keys to select the full scale setting of the clamp used.
4. Press SHIFT again to return to Setup Mode editing or press EXIT to leave the Setup mode.

#### 4.5.11 Set Current Range

**ATTENTION: Ensure that the 'A' range setting matches the attached clamp's rating**

1. In the Setup Mode, use the up and down arrow keys to scroll to the "A RANGE" field.
2. Press SHIFT, the display "SHIFT1" will switch ON.
3. Use the ▲ or ▼ keys to select the current range.
4. Press SHIFT again to return to Setup Mode editing or press EXIT to leave the Setup mode.

#### 4.5.12 Set Voltage Range

1. In the Setup Mode, use the up and down arrow keys to scroll to the "V RANGE" field.
2. Press SHIFT, the display "SHIFT1" will switch ON
3. Use the ▲ or ▼ keys to select the voltage (**Note** that unless the CLAMP TYPE is set to "Other", this value is fixed)
4. Press SHIFT again to return to Setup Mode editing or press EXIT to leave the Setup mode.

#### 4.5.13 Set RS-232 Output Parameters

1. In the Setup Mode, use the up/down arrow keys to scroll to the "RS232 OUT SEL" field.
2. Press the SETUP/ENTER key to access the RS232 Output selection page. Nine output selections maximum can be highlighted on this page.
3. Use all four arrow buttons to navigate the output choices.
4. To select an output type, press the SETUP key (the selection will highlight).
5. To de-select a selected output type, press the SETUP key (the highlight will switch off).
6. Press and hold the SHIFT key for > 2 seconds to clear all RS-232 output selections.
7. Press the EXIT button to exit the RS232 output mode.
8. If nine items are selected the display will show the indicator "full".

#### RS232 – Output Selections

| RS232 OUTPUT SELECT |                |                 |
|---------------------|----------------|-----------------|
| 1. V12              | 12. P3         | 23. PF2         |
| 2. V23              | 13. PΣ         | 24. PF3         |
| 3. V31              | 14. <b>S1</b>  | 25. PFΣ         |
| <b>4.</b> V1        | 15. S2         | 26. PFH         |
| 5. V2               | 16. S3         | 27. <b>Φ 1</b>  |
| 6. V3               | 17. SΣ         | 28. Φ 2         |
| 7. <b>I1</b>        | 18. <b>Q1</b>  | 29. Φ 3         |
| 8. I2               | 19. Q2         | 30. <b>WH</b>   |
| 9. I3               | 20. Q3         | 31. SH          |
| 10. <b>P1</b>       | 21. QΣ         | 32. OH          |
| 11. P2              | 22. <b>PF1</b> | 33. <b>FREQ</b> |

#### **4.5.14 Set Time and Date**

1. In the Setup Mode, use the up and down arrow keys to scroll to the YEAR, MONTH, DATE, HOUR, MINUTE, and SECOND fields.
2. Press SHIFT key when the desired field is selected, the display "SHIFT1" will switch ON
3. Use the ▲ or ▼ keys to change the date or time value
4. Press SHIFT again to return to Setup Mode editing or press EXIT to leave the Setup mode.

#### **4.5.15 Exit the Setup Mode**

When all of the programming has been completed, press the EXIT key to return to the measurement mode of operation.



## 5.0 Power Measurement Procedures

### 5.1 1 $\Phi$ 2W (Single Phase - Two Wire) Measurement

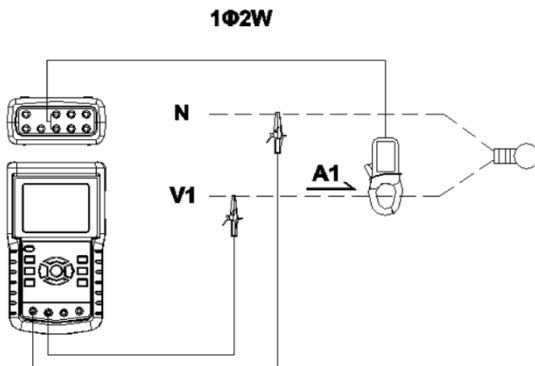

1. Power the instrument ON by pressing the 'Power' key, and then use the '1 $\Phi$  3 $\Phi$ ' key to select the 1 $\Phi$  2W system, the selected name of the system will be shown on the bottom left side of the display
2. Connect the line voltage L1, Vn (Neutral) to V1 and N terminals of the instrument.
3. Connect the Clamp (A1) to the conductor (A1)
4. Connect Clamp 1 (A1) to the A1 terminal of the instrument
5. The related measurement factors will appear on the display
6. Measurement definitions can be found in Section 5-10

#### 1 $\Phi$ 2W Screen

|             |             |                             |               |              |              |
|-------------|-------------|-----------------------------|---------------|--------------|--------------|
| V 1 :       | 0.0         | V                           |               |              |              |
| A 1 :       | 0.00        | A                           |               |              |              |
| P 1 :       | - 0.000KW   |                             | P F 1 :       | - 0.00       |              |
| S 1 :       | 0.000KVA    |                             | P F H :       | 0.00         |              |
| Q 1 :       | - 0.000KVAR |                             | $\Phi$ 1 :    | - 0.0°       |              |
| WH :        | 0.000KWH    |                             |               |              |              |
| SH :        | 0.000KVAH   |                             |               |              |              |
| QH :        | 0.000KVARH  |                             | FREQ :        | 50.1         | Hz           |
| <b>1201</b> | <b>20A</b>  | <b>1<math>\Phi</math>2W</b> | <b>SEC: 2</b> | <b>CT: 1</b> | <b>PT: 1</b> |

## 5.2 1Φ3W (single phase - three wire) Measurement

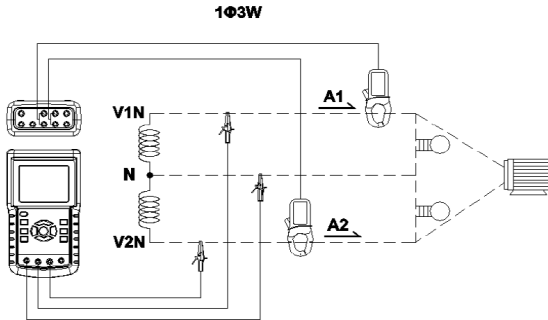

1. Power the instrument ON by pressing 'Power' key, and then press the '1Φ 3Φ' key to select 1Φ 3W, the selected name of the configuration will appear on bottom left hand side of the display.
2. Connect the line voltage L1, L2 and Vn (Neutral) to V1, V2 and N terminals of the instrument
3. Connect the two (2) clamps (A1 and A2) to the conductors (A1) and (A2)
4. Connect Clamp 1 and Clamp 2 (A1 and A2) to the A1 and A2 terminals of the instrument
5. The related measurement factors will appear on the display

### 1Φ3W Screen

|             |             |             |              |            |          |
|-------------|-------------|-------------|--------------|------------|----------|
| V 1 :       | 0.0         | V           | P 1 :        | -          | 0.000KW  |
| V 2 :       | 0.0         | V           | P 2 :        | -          | 0.000KW  |
| A 1 :       | 0.00        | A           | S 1 :        | 0.000KVA   |          |
| A 2 :       | 0.00        | A           | S 2 :        | 0.000KVA   |          |
| Q 1 :       | -           | 0.000KVAR   |              |            |          |
| Q 2 :       | -           | 0.000KVAR   |              |            |          |
| <b>PΣ :</b> | 0.000       | KW          | <b>SΣ :</b>  | 0.000      | KVA      |
| <b>PF1:</b> | -           | 0.00        | <b>PF2:</b>  | -          | 0.00     |
| <b>PFH:</b> | 0.00        |             | <b>Φ 1:</b>  | -          | 0.0°     |
| <b>QΣ :</b> | 0.000       | KVAR        | <b>Φ 2:</b>  | -          | 0.0°     |
| <b>WH:</b>  | 0.000       | KWH         | <b>SH:</b>   | 0.000      | KVAH     |
| <b>QH:</b>  | 0.000       | KVARH       | <b>FREQ:</b> | 50.0       | Hz       |
| <b>1201</b> |             |             |              |            |          |
| <b>20A</b>  | <b>1Φ3W</b> | <b>SEC:</b> | <b>2</b>     | <b>CT:</b> | <b>1</b> |
|             |             | <b>PT:</b>  | <b>1</b>     |            |          |

### 5.3 3Φ3W (three phase - three wire) Measurement

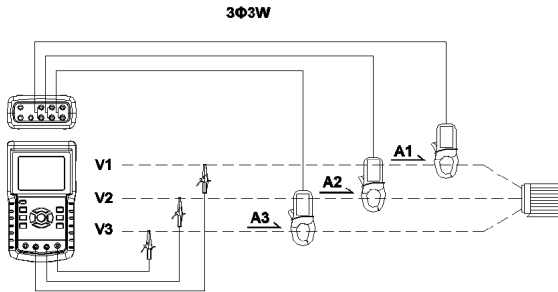

1. Power the instrument ON by pressing the 'Power' key, and then press '1Φ 3Φ' to select 3Φ 3W, the selected configuration name will appear on bottom left hand side of the display.
2. Connect the line voltage L1, L2 and L3 to V1, V2 and V3 terminals of the instrument.
3. Connect the three (3) clamps (A1, A2, A3) to conductors A1, A2 , A3
4. Connect the three (3) Clamps to the meter using the A1, A2, and A3 terminals
5. The related measurement factors will appear on the display

#### 3Φ3W Screen

|             |             |       |               |              |              |
|-------------|-------------|-------|---------------|--------------|--------------|
| V 1 2 :     | 0.0         | V     | A 1 :         | 0.00         | A            |
| V 2 3 :     | 0.0         | V     | A 2 :         | 0.00         | A            |
| V 3 1 :     | 0.0         | V     | A 3 :         | 0.00         | A            |
| P Σ :       | - 0.000     | KW    |               |              |              |
| S Σ :       | 0.000       | KVA   |               |              |              |
| Q Σ :       | 0.000       | KVAR  |               |              |              |
| PFΣ :       | 0.00        |       | P F H :       | 0.00         |              |
| <b>WH:</b>  | 0.000       | KWH   | <b>SH:</b>    | 0.000        | KVAH         |
| <b>QH:</b>  | 0.000       | KVARH | <b>FREQ:</b>  | 50.0         | Hz           |
| <b>1201</b> |             |       |               |              |              |
| <b>20A</b>  | <b>3Φ3W</b> |       | <b>SEC: 2</b> | <b>CT: 1</b> | <b>PT: 1</b> |

## 5.4 3Φ4W (three phase - four wire) Measurement

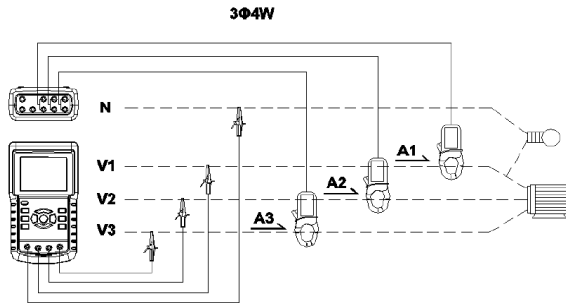

1. Power the instrument ON by pressing the 'Power' key, and then press '1Φ 3Φ' to select the 3Φ 4W system, the selected name of the system will appear on the bottom left hand side of the display.
2. Connect the line voltage L1, L2, L3 and Vn to V1, V2, V3 and N terminals of the instrument.
3. Connect the three (3) Clamps (A1, A2, and A3) to the conductors A1, A2, and A3.
4. Connect the Clamps (A1, A2, and A3) to the meter's A1, A2, and A3 terminals.
5. The related measurement factors will appear on the display.

### 3Φ4W Screen

|                        |                       |                           |
|------------------------|-----------------------|---------------------------|
| <b>V12:</b> 0.0 V      | <b>V1:</b> 0.0 V      | <b>A1:</b> 0.00 A         |
| <b>V23:</b> 0.0 V      | <b>V2:</b> 0.0 V      | <b>A2:</b> 0.00 A         |
| <b>V31:</b> 0.0 V      | <b>V3:</b> 0.0 V      | <b>A3:</b> 0.00 A         |
| <b>P1:</b> - 0.000 KW  | <b>S1:</b> 0.000 KVA  | <b>Q1:</b> - 0.000 KVAR   |
| <b>P2:</b> - 0.000 KW  | <b>S2:</b> 0.000 KVA  | <b>Q2:</b> - 0.000 KVAR   |
| <b>P3:</b> - 0.000 KW  | <b>S3:</b> 0.000 KVA  | <b>Q3:</b> - 0.000 KVAR   |
| <b>PΣ</b> - 0.000 KW   | <b>SΣ</b> : 0.000 KVA | <b>QΣ</b> : - 0.000 KVAR  |
| <b>PF1:</b> - 0.00     | <b>PF2:</b> - 0.00    | <b>PF3:</b> - 0.00        |
| <b>PFΣ</b> : 0.00      | <b>PFH:</b> 0.00      |                           |
| <b>Φ 1:</b> - 0.0°     | <b>Φ 2:</b> 0.0°      | <b>Φ 3:</b> - 0.0°        |
| <b>WH:</b> 0.000 KWH   | <b>SH:</b> 0.000 KVAH |                           |
| <b>QH:</b> 0.000 KVARH | <b>FREQ:</b> 0.0 Hz   |                           |
| <b>1201</b>            |                       |                           |
| <b>20A</b>             | <b>3Φ4W</b>           | <b>SEC: 2 CT: 1 PT: 1</b> |

## 5.5 Current (CT) / Potential (PT) Transformer Measurement

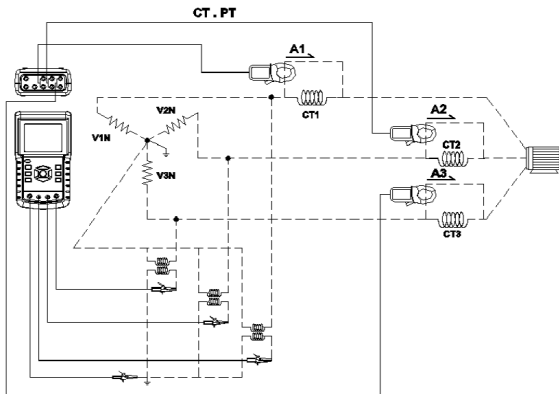

1. Power the instrument ON by pressing the 'Power' key , and then press the '1Φ 3Φ' key to select the 3Φ 4W system, the selected name of the system will appear on the bottom left hand side of the display.
2. Connect the line voltage L1, L2, L3 and Vn to the V1, V2, V3 and N terminals of the instrument
3. Connect the three (3) Clamps (A1, A2, A3) to the conductors A1, A2, A3
4. Connect the Clamps (A1, A2, A3) to the meter's A1, A2, A3 terminals
5. The related measurement factors will appear on the display

|             |             |              |            |               |                           |
|-------------|-------------|--------------|------------|---------------|---------------------------|
| <b>V12:</b> | 0.0 V       | <b>V1:</b>   | 0.0 V      | <b>A1:</b>    | 0.00 A                    |
| <b>V23:</b> | 0.0 V       | <b>V2:</b>   | 0.0 V      | <b>A2:</b>    | 0.00 A                    |
| <b>V31:</b> | 0.0 V       | <b>V3:</b>   | 0.0 V      | <b>A3:</b>    | 0.00 A                    |
| <b>P1:</b>  | - 0.000 KW  | <b>S1:</b>   | 0.000 KVA  | <b>Q1:</b>    | - 0.000 KVAR              |
| <b>P2:</b>  | - 0.000 KW  | <b>S2:</b>   | 0.000 KVA  | <b>Q2:</b>    | - 0.000 KVAR              |
| <b>P3:</b>  | - 0.000 KW  | <b>S3:</b>   | 0.000 KVA  | <b>Q3:</b>    | - 0.000 KVAR              |
| <b>PΣ</b>   | - 0.000 KW  | <b>SΣ</b>    | 0.000 KVA  | <b>QΣ</b>     | - 0.000 KVAR              |
| <b>PF1:</b> | - 0.00      | <b>PF2:</b>  | - 0.00     | <b>PF3:</b>   | - 0.00                    |
| <b>PFΣ</b>  | 0.00        | <b>PFH:</b>  | 0.00       |               |                           |
| <b>Φ1:</b>  | - 0.0°      | <b>Φ2:</b>   | 0.0°       | <b>Φ3:</b>    | - 0.0°                    |
| <b>WH:</b>  | 0.000 KWH   | <b>SH:</b>   | 0.000 KVAH |               |                           |
| <b>QH:</b>  | 0.000 KVARH | <b>FREQ:</b> | 0.0 Hz     |               |                           |
| <b>1201</b> |             |              |            |               |                           |
| <b>20A</b>  |             | <b>3Φ 4W</b> |            | <b>SEC: 2</b> | <b>CT: 1</b> <b>PT: 1</b> |

## 5.6 Datalogger Function

1. Press the REC key once to begin.
2. If the meter displays the "Change Card" message at the bottom right, the SD CARD memory is either full or it is damaged.
3. If the meter displays "NO DISK" an SD card must be inserted.
4. If 'Check SD' appears, wait a few seconds as the meter is reading the SD card.
5. If the SD CARD is functional and it has available space datalogging will begin.

The 'Change Card' display

|                        |                       |                          |
|------------------------|-----------------------|--------------------------|
| <b>V12:</b> 0.0 V      | <b>V1:</b> 0.0 V      | <b>A1:</b> 0.00 A        |
| <b>V23:</b> 0.0 V      | <b>V2:</b> 0.0 V      | <b>A2:</b> 0.00 A        |
| <b>V31:</b> 0.0 V      | <b>V3:</b> 0.0 V      | <b>A3:</b> 0.00 A        |
| <b>P1:</b> - 0.000 KW  | <b>S1:</b> 0.000 KVA  | <b>Q1:</b> - 0.000 KVAR  |
| <b>P2:</b> - 0.000 KW  | <b>S2:</b> 0.000 KVA  | <b>Q2:</b> - 0.000 KVAR  |
| <b>P3:</b> - 0.000 KW  | <b>S3:</b> 0.000 KVA  | <b>Q3:</b> - 0.000 KVAR  |
| <b>PΣ</b> - 0.000 KW   | <b>SΣ</b> : 0.000 KVA | <b>QΣ</b> : - 0.000 KVAR |
| <b>PF1:</b> - 0.00     | <b>PF2:</b> - 0.00    | <b>PF3:</b> - 0.00       |
| <b>PFΣ</b> : 0.00      | <b>PFH:</b> 0.00      |                          |
| <b>Φ1:</b> - 0.0°      | <b>Φ2:</b> - 0.0°     | <b>Φ3:</b> - 0.0°        |
| <b>WH:</b> 0.000 KWH   | <b>SH:</b> 0.000 KVAH |                          |
| <b>QH:</b> 0.000 KVARH | <b>FREQ:</b> 0.0 Hz   |                          |
| <b>1201</b>            |                       | <b>Change</b>            |
| <b>20A</b>             | <b>3Φ4W</b>           | <b>Card</b>              |
| <b>SEC: 2</b>          | <b>CT: 1</b>          | <b>PT: 1</b>             |

6. The display will show the datalogging process by incrementing the data counter on the bottom right side of screen (under the REC display icon).
7. Each file can store up to 30,000 data points. When the number of data points reaches 30,000 the system will create a new file automatically. (For example, WTA01001.XLS will be replaced by WTA01002.XLS)
8. Press the REC key again to stop datalogging. The incrementing counter and the REC display icon will switch off.
9. Instructions are provided later in this User Guide regarding data exporting to a spreadsheet using a PC.

The Datalogger Incrementing Counter display

|                        |                       |                          |
|------------------------|-----------------------|--------------------------|
| <b>V12:</b> 0.0 V      | <b>V1:</b> 0.0 V      | <b>A1:</b> 0.00 A        |
| <b>V23:</b> 0.0 V      | <b>V2:</b> 0.0 V      | <b>A2:</b> 0.00 A        |
| <b>V31:</b> 0.0 V      | <b>V3:</b> 0.0 V      | <b>A3:</b> 0.00 A        |
| <b>P1:</b> - 0.000 KW  | <b>S1:</b> 0.000 KVA  | <b>Q1:</b> - 0.000 KVAR  |
| <b>P2:</b> - 0.000 KW  | <b>S2:</b> 0.000 KVA  | <b>Q2:</b> - 0.000 KVAR  |
| <b>P3:</b> - 0.000 KW  | <b>S3:</b> 0.000 KVA  | <b>Q3:</b> - 0.000 KVAR  |
| <b>PΣ</b> - 0.000 KW   | <b>SΣ</b> : 0.000 KVA | <b>QΣ</b> : - 0.000 KVAR |
| <b>PF1:</b> - 0.00     | <b>PF2:</b> - 0.00    | <b>PF3:</b> - 0.00       |
| <b>PFΣ</b> : 0.00      | <b>PFH:</b> 0.00      |                          |
| <b>Φ1:</b> - 0.0°      | <b>Φ2:</b> - 0.0°     | <b>Φ3:</b> - 0.0°        |
| <b>WH:</b> 0.000 KWH   | <b>SH:</b> 0.000 KVAH |                          |
| <b>QH:</b> 0.000 KVARH | <b>FREQ:</b> 0.0 Hz   |                          |
| <b>1201</b>            |                       | <b>REC</b>               |
| <b>20A</b>             | <b>3Φ4W</b>           | <b>9</b>                 |
| <b>SEC: 2</b>          | <b>CT: 1</b>          | <b>PT: 1</b>             |

## 5.7 Data Hold Function

1. During a measurement, press the HOLD KEY once, the displayed readings will freeze and the display will show the "HOLD" icon on the bottom right side of the screen
2. Press the HOLD key again to release the display and return to the normal operating mode. The HOLD display icon will switch off

### The HOLD display

|                        |                       |   |
|------------------------|-----------------------|---|
| <b>V12:</b> 0.0 V      | <b>V1:</b> 0.0 V      | <b>A1:</b> 0.00 A                       |
| <b>V23:</b> 0.0 V      | <b>V2:</b> 0.0 V      | <b>A2:</b> 0.00 A                       |
| <b>V31:</b> 0.0 V      | <b>V3:</b> 0.0 V      | <b>A3:</b> 0.00 A                       |
| <b>P1:</b> - 0.000 KW  | <b>S1:</b> 0.000 KVA  | <b>Q1:</b> - 0.000 KVAR                 |
| <b>P2:</b> - 0.000 KW  | <b>S2:</b> 0.000 KVA  | <b>Q2:</b> - 0.000 KVAR                 |
| <b>P3:</b> - 0.000 KW  | <b>S3:</b> 0.000 KVA  | <b>Q3:</b> - 0.000 KVAR                 |
| <b>PΣ</b> - 0.000 KW   | <b>SΣ</b> : 0.000 KVA | <b>QΣ</b> : - 0.000 KVAR                |
| <b>PF1:</b> - 0.00     | <b>PF2:</b> - 0.00    | <b>PF3:</b> - 0.00                      |
| <b>PFΣ</b> : 0.00      | <b>PFH:</b> 0.00      |   |
| <b>Φ1:</b> - 0.0°      | <b>Φ2:</b> - 0.0°     | <b>Φ3:</b> - 0.0°                       |
| <b>WH:</b> 0.000 KWH   | <b>SH:</b> 0.000 KVAH |   |
| <b>QH:</b> 0.000 KVARH | <b>FREQ:</b> 0.0 Hz   |   |
| <b>1201</b>            |                       |   |
| <b>20A</b>             | <b>3Φ4W</b>           | <b>SEC: 2 CT: 1 PT: 1</b> <b>HOLD</b> ← |

## 5.8 LCD Backlight Key

Press to turn the backlight ON or OFF. Note: Use of the backlight will place a higher burden on the battery power. The backlight should be turned off when using battery power and especially while datalogging.

## 5.9 Low Battery Indication (LOW BAT)

When the LOW BAT indicator appears, replace the batteries as described in the Battery Replacement section of this manual. Use of weak batteries will compromise measurement accuracy and meter performance.

### Low Battery indication

|                        |                       |                                     |
|------------------------|-----------------------|-------------------------------------|
| <b>V12:</b> 0.0 V      | <b>V1:</b> 0.0 V      | <b>A1:</b> 0.00 A                   |
| <b>V23:</b> 0.0 V      | <b>V2:</b> 0.0 V      | <b>A2:</b> 0.00 A                   |
| <b>V31:</b> 0.0 V      | <b>V3:</b> 0.0 V      | <b>A3:</b> 0.00 A                   |
| <b>P1:</b> - 0.000 KW  | <b>S1:</b> 0.000 KVA  | <b>Q1:</b> - 0.000 KVAR             |
| <b>P2:</b> - 0.000 KW  | <b>S2:</b> 0.000 KVA  | <b>Q2:</b> - 0.000 KVAR             |
| <b>P3:</b> - 0.000 KW  | <b>S3:</b> 0.000 KVA  | <b>Q3:</b> - 0.000 KVAR             |
| <b>PΣ</b> - 0.000 KW   | <b>SΣ</b> : 0.000 KVA | <b>QΣ</b> : - 0.000 KVAR            |
| <b>PF1:</b> - 0.00     | <b>PF2:</b> - 0.00    | <b>PF3:</b> - 0.00                  |
| <b>PFΣ</b> : 0.00      | <b>PFH:</b> 0.00      |                                     |
| <b>Φ1:</b> - 0.0°      | <b>Φ2:</b> - 0.0°     | <b>Φ3:</b> - 0.0°                   |
| <b>WH:</b> 0.000 KWH   | <b>SH:</b> 0.000 KVAH |                                     |
| <b>QH:</b> 0.000 KVARH | <b>FREQ:</b> 0.0 Hz   |                                     |
| <b>1201</b>            |                       |                                     |
| <b>20A</b>             | <b>3Φ4W</b>           | <b>SEC: 2 CT: 1</b> <b>LOWBAT</b> ← |
|                        |                       | <b>PT: 1</b>                        |

## 5.10 Measurement Definitions

- V12, V23, V31 : Line Voltage
- V1, V2, V3 : Phase Voltage
- A1, A2, A3 : Line Current
- P1, P2, P3 : True Power of each phase (W)
- S1, S2, S3 : Apparent Power of each phase. (VA)
- Q1, Q2, Q3 : Reactive Power of each phase (VAR)
- $P\Sigma$  : Total True Power (W)
- $S\Sigma$  : Total Apparent Power (VA)
- $Q\Sigma$  : Total Reactive Power (VAR)
- PF1, PF2, PF3 : Power Factor of each phase
- $PF\Sigma$  : Total Power Factor
- PFH : Long Term Average Power Factor ( WH/SH )
- $\phi_1, \phi_2, \phi_3$  : Phase Angle of each phase
- WH : Watt Hour
- SH : Apparent Power Hour
- QH : Reactive Power Hour
- 1 $\phi$  2W : Single phase/ two wire
- 1 $\phi$  3W : Single phase/ three wire
- 3 $\phi$  3W : Three phase/ three wire
- 3 $\phi$  4W : Three phase/ four wire
- SEC : The sampling rate in seconds for the datalogger
- CT : Current transformer
- PT : Potential transformer

## 5.11 Reset Button

The Reset Button located on the right side of the meter allows the user to reboot the meter if the display or keypad is locked.

## 5.12 Zero Adjustment for the 'Watt Hour' Function

Press and hold the "Exit" key for at least 6 seconds, the measurement values for "WH", "SH", "QH" will reset to a Zero value.



## 6.0 Maintenance

---



CAUTION: Remove test leads before opening the battery cover; Electrical Shock Hazard.

### 6.1 Cleaning



CAUTION: When cleaning, use only a dry cloth. Do not use liquids of any kind to clean the meter.

### 6.2 Battery Replacement

1. When the display shows the LOWBAT indicator, replace the batteries as soon as possible
2. Open the rear Battery Cover and remove the batteries
3. Replace the eight (8) batteries (1.5Vdc 'AA' batteries) and close the battery cover



You, as the end user, are legally bound (**EU Battery ordinance**) to return all used batteries, **disposal in the household garbage is prohibited!** You can hand over your used batteries / accumulators at collection points in your community or wherever batteries / accumulators are sold!

**Disposal:** Follow the valid legal stipulations in respect of the disposal of the device at the end of its lifecycle

## 7.0 SD Card

### 7.1 Download SD Card Data to PC

1. After a Datalogging session, remove the SD card from the SD card socket.
2. Plug the SD card into a PC SD card reader slot or into an SD card reader adaptor.
3. Power the computer and run spreadsheet software. Download the stored data file from the SD Card to the PC (file name examples: 3P401001.XLS, 1P201001.XLS, 1P301001.XLS, 3P301001.XLS).
4. The data files can be opened directly into a spreadsheet program.

Example Data File

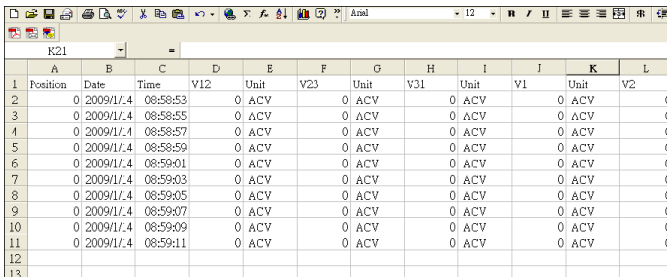

|    | A        | B        | C        | D   | E    | F   | G    | H   | I    | J  | K    | L  |
|----|----------|----------|----------|-----|------|-----|------|-----|------|----|------|----|
| 1  | Position | Date     | Time     | V12 | Unit | V23 | Unit | V31 | Unit | V1 | Unit | V2 |
| 2  | 0        | 2009/1/4 | 08:58:53 | 0   | ACV  | 0   | ACV  | 0   | ACV  | 0  | ACV  | 0  |
| 3  | 0        | 2009/1/4 | 08:58:55 | 0   | ACV  | 0   | ACV  | 0   | ACV  | 0  | ACV  | 0  |
| 4  | 0        | 2009/1/4 | 08:58:57 | 0   | ACV  | 0   | ACV  | 0   | ACV  | 0  | ACV  | 0  |
| 5  | 0        | 2009/1/4 | 08:58:59 | 0   | ACV  | 0   | ACV  | 0   | ACV  | 0  | ACV  | 0  |
| 6  | 0        | 2009/1/4 | 08:59:01 | 0   | ACV  | 0   | ACV  | 0   | ACV  | 0  | ACV  | 0  |
| 7  | 0        | 2009/1/4 | 08:59:03 | 0   | ACV  | 0   | ACV  | 0   | ACV  | 0  | ACV  | 0  |
| 8  | 0        | 2009/1/4 | 08:59:05 | 0   | ACV  | 0   | ACV  | 0   | ACV  | 0  | ACV  | 0  |
| 9  | 0        | 2009/1/4 | 08:59:07 | 0   | ACV  | 0   | ACV  | 0   | ACV  | 0  | ACV  | 0  |
| 10 | 0        | 2009/1/4 | 08:59:09 | 0   | ACV  | 0   | ACV  | 0   | ACV  | 0  | ACV  | 0  |
| 11 | 0        | 2009/1/4 | 08:59:11 | 0   | ACV  | 0   | ACV  | 0   | ACV  | 0  | ACV  | 0  |
| 12 |          |          |          |     |      |     |      |     |      |    |      |    |
| 13 |          |          |          |     |      |     |      |     |      |    |      |    |

Example Graphic Screen

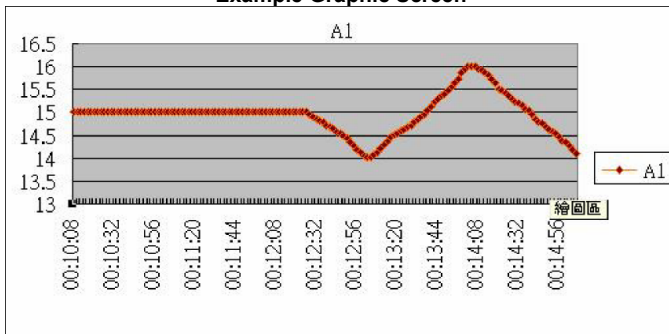

Test Equipment Depot - 800.517.8431 - 99 Washington Street Melrose, MA 02176

TestEquipmentDepot.com

**Copyright © 2014 FLIR Systems, Inc.**

All rights reserved including the right of reproduction in whole or in part in any form.