



Operating Manual

PS 3000 C

DC Power Supply

Elektro-Automatik



Attention! This document is only valid for devices with firmwares "KE: 2.04", "HMI: 2.03" and "DR: 2.0.1" or higher.



Doc ID: PS3EN
Revision: 03
Date: 11/2022



TABLE OF CONTENTS

1 GENERAL

1.1	About this document	4
1.1.1	Retention and use	4
1.1.2	Copyright	4
1.1.3	Validity	4
1.1.4	Symbols and warnings	4
1.2	Warranty	4
1.3	Limit of liability	4
1.4	Disposal of equipment	5
1.5	Product key	5
1.6	Intended usage	5
1.7	Safety	6
1.7.1	Safety notices	6
1.7.2	Responsibility of the user	6
1.7.3	Responsibility of the operator	7
1.7.4	User requirements	7
1.7.5	Alarm signals	8
1.8	Technical data	8
1.8.1	Approved operating conditions	8
1.8.2	General technical data	8
1.8.3	Specific technical data	9
1.8.4	Views	15
1.8.5	Control elements	17
1.9	Construction and function	18
1.9.1	General description	18
1.9.2	Block diagram	18
1.9.3	Scope of delivery	19
1.9.4	Optional accessories	19
1.9.5	The control panel (HMI)	20
1.9.6	USB port (optional)	22
1.9.7	Ethernet port (optional)	22
1.9.8	Analog interface (optional)	23
1.9.9	“Sense” connector (remote sensing)	23

2 INSTALLATION & COMMISSIONING

2.1	Storage	24
2.1.1	Packaging	24
2.1.2	Storage	24
2.2	Unpacking and visual check	24
2.3	Installation	24
2.3.1	Safety procedures before installation and use	24
2.3.2	Preparation	24
2.3.3	Installing the device	24
2.3.4	Connection to DC loads	26
2.3.5	Grounding of the DC output	26
2.3.6	Connection of remote sensing	27
2.3.7	Connecting the analog interface	27
2.3.8	Connecting the USB port	27
2.3.9	Connecting the LAN port	28
2.3.10	Initial commission	28
2.3.11	Commission after a firmware update or a long period of non use	28

3 OPERATION AND APPLICATION

3.1	Personal safety	29
3.2	Operating modes	29
3.2.1	Voltage regulation / Constant voltage	29
3.2.2	Current regulation / constant current / current limitation	30
3.2.3	Power regulation / constant power / power limitation	30
3.3	Alarm conditions	31
3.3.1	Power Fail	31
3.3.2	Overtemperature	31
3.3.3	Overvoltage	31
3.3.4	Overcurrent protection	31
3.3.5	Overpower protection	31
3.4	Manual operation	32
3.4.1	Powering the device	32
3.4.2	Switching the device off	32
3.4.3	Configuration via the Menu	32
3.4.4	Adjustment limits	36
3.4.5	Manual adjustment of set values	36
3.4.6	Switching the main screen view	37
3.4.7	Switching the DC output on or off	37
3.5	Remote control	38
3.5.1	General	38
3.5.2	Controls locations	38
3.5.3	Remote control via a digital interface	38
3.5.4	Remote control via the analog interface (AI)	40
3.6	Alarms and monitoring	44
3.6.1	Device alarm and event handling	44
3.7	Control panel (HMI) lock	45
3.8	Loading and saving a user profile	46
3.9	Other applications	47
3.9.1	Series connection	47
3.9.2	Parallel operation	47
3.9.3	Operation as battery charger	47

4 SERVICE AND MAINTENANCE

4.1	Maintenance / cleaning	48
4.2	Fault finding / diagnosis / repair	48
4.2.1	Replacing a defect mains fuse	48
4.2.2	Firmware updates	48

5 CONTACT AND SUPPORT

5.1	Repairs	49
5.2	Contact options	49

1. General

1.1 About this document

1.1.1 Retention and use

This document is to be kept in the vicinity of the equipment for future reference and explanation of the operation of the device. This document is to be delivered and kept with the equipment in case of change of location and/or user.

1.1.2 Copyright

Modification and partial or complete usage of this PDF document for other purposes as intended are forbidden and breach may lead to legal process.



1.1.3 Validity

This manual is valid for the following equipment, including derived variants.

Model	Article number	Model	Article number
PS 3040-10 C	35 320 208	PS 3200-04 C	35 320 213
PS 3080-05 C	35 320 209	PS 3040-40 C	35 320 214
PS 3200-02 C	35 320 210	PS 3080-20 C	35 320 215
PS 3040-20 C	35 320 211	PS 3200-10 C	35 320 216
PS 3080-10 C	35 320 212		

1.1.4 Symbols and warnings

Warning and safety notices as well as general notices in this document are shown in a box with a symbol as follows:

	Symbol for a life threatening danger
	Symbol for general safety notices (instructions and damage protection bans)
	<i>Symbol for general notices</i>

1.2 Warranty

EA Elektro-Automatik guarantees the functional competence of the device within the stated performance parameters. The warranty period begins with the delivery of free from defects equipment.

Terms of guarantee are included in the general terms and conditions of EA Elektro-Automatik.

1.3 Limit of liability

All statements and instructions in this manual are based on current norms and regulations, up-to-date technology and our long term knowledge and experience. EA Elektro-Automatik accepts no liability for losses due to:

- Usage for purposes other than defined
- Use by untrained personnel
- Rebuilding by the customer
- Technical changes
- Use of non authorized spare parts

The actual delivered device(s) may differ from the explanations and diagrams given here due to latest technical changes or due to customized models with the inclusion of additionally ordered options.

1.4 Disposal of equipment

A piece of equipment which is intended for disposal must, according to European laws and regulations (ElektroG, WEEE) be returned to EA Elektro-Automatik for scrapping, unless the person operating the piece of equipment or another, delegated person is conducting the disposal. Our equipment falls under these regulations and is accordingly marked with the following symbol:



1.5 Product key

Decoding of the product description on the label, using an example:

PS 3080 - 10 C

Construction/Version: C = Third generation
Maximum current of the device in Ampere
Maximum voltage of the device in Volt
Series: 3 = Series 3000
Type identification: PS = Power Supply, usually programmable

1.6 Intended usage

The equipment is intended to be used, if a power supply or battery charger, only as a variable voltage and current source, or, if an electronic load, only as a variable current sink.

Typical application for a power supply is DC supply to any relevant user, for a battery charger the charging of various battery types and for electronic loads the replacement of Ohm resistance by an adjustable DC current sink in order to load relevant voltage and current sources of any type.



- Claims of any sort due to damage caused by non-intended usage will not be accepted.
- All damage caused by non-intended usage is solely the responsibility of the operator.

1.7 Safety

1.7.1 Safety notices

Mortal danger - Hazardous voltage



- **Electrical equipment operation means that some parts will be under dangerous voltage. Therefore all parts under voltage must be covered!**
- **All work on connections must be carried out under zero voltage (output not connected to a load which is also a voltage source) and may only be performed by qualified and informed persons. Improper actions can cause fatal injury as well as serious material damage.**
- **Never touch cables or connectors directly after unplugging from mains supply as the danger of electric shock remains.**
- **Never touch a blank contact on the DC output right after usage of the device, because between DC- and DC+ there is potential against ground (PE) which discharges more or less slowly or not at all!**



- The equipment must only be used as intended
- The equipment is only approved for use within the connection limits stated on the product label.
- Do not insert any object, particularly metallic, through the ventilator slots
- Avoid any use of liquids near the equipment. Protect the device from wet, damp and condensation.
- For power supplies and battery chargers: do not connect loads, particularly such with low resistance, while the DC output is switched on; sparking may occur which can cause burns as well as damage to the equipment and to the user.
- For electronic loads: do not connect power sources to equipment under power, sparking may occur which can cause burns as well as damage to the equipment and to the source.
- ESD regulations must be applied when plugging interface cards or modules into the relative slot
- Interface cards or modules may only be attached or removed after the device is switched off. It'sn't necessary to open the device.
- Do not connect external power sources with reversed polarity to DC inputs or outputs! The equipment will be damaged.
- For power supply devices: avoid where possible connecting external power sources to the DC output, and never those that can generate a higher voltage than the nominal voltage of the device.
- For electronic loads: do not connect a power source to the DC input which can generate a voltage more than 120% of the nominal input voltage of the load. The equipment isn't protected against over voltage and may be irreparably damaged.
- Always configure the various protecting features against overcurrent, overpower etc. for sensitive sources to what the currently used application requires

1.7.2 Responsibility of the user

The equipment is in industrial operation. Therefore the operators are governed by the legal safety regulations. Alongside the warning and safety notices in this manual the relevant safety, accident prevention and environmental regulations must also be applied. In particular the users of the equipment:

- must be informed of the relevant job safety requirements
- must work to the defined responsibilities for operation, maintenance and cleaning of the equipment
- before starting work must have read and understood the operating manual
- must use the designated and recommended safety equipment.

Furthermore, anyone working with the equipment is responsible for ensuring that the device is at all times technically fit for use.

1.7.3 Responsibility of the operator

Operator is any natural or legal person who uses the equipment or delegates the usage to a third party, and is responsible during its usage for the safety of the user, other personnel or third parties.

The equipment is in industrial operation. Therefore the operators are governed by the legal safety regulations. Alongside the warning and safety notices in this manual the relevant safety, accident prevention and environmental regulations must also be applied. In particular the operator has to

- be acquainted with the relevant job safety requirements
 - identify other possible dangers arising from the specific usage conditions at the work station via a risk assessment
 - introduce the necessary steps in the operating procedures for the local conditions
 - regularly check that the operating procedures are current
 - update the operating procedures where necessary to reflect changes in regulation, standards or operating conditions.
 - define clearly and unambiguously the responsibilities for operation, maintenance and cleaning of the equipment.
 - ensure that all employees who use the equipment have read and understood the manual. Furthermore the users are to be regularly schooled in working with the equipment and the possible dangers.
 - provide all personnel who work with the equipment with the designated and recommended safety equipment
- Furthermore, the operator is responsible for ensuring that the device is at all times technically fit for use.

1.7.4 User requirements

Any activity with equipment of this type may only be performed by persons who are able to work correctly and reliably and satisfy the requirements of the job.

- Persons whose reaction capability is negatively influenced by e.g. drugs, alcohol or medication may not operate the equipment.
- Age or job related regulations valid at the operating site must always be applied.



Danger for unqualified users

Improper operation can cause person or object damage. Only persons who have the necessary training, knowledge and experience may use the equipment.

Delegated persons are those who have been properly and demonstrably instructed in their tasks and the attendant dangers.

Qualified persons are those who are able through training, knowledge and experience as well as knowledge of the specific details to carry out all the required tasks, identify dangers and avoid personal and other risks.

1.7.5 Alarm signals

The equipment offers various possibilities for signalling alarm conditions, however, not for danger situations. The signals may be optical (on the display as text) acoustic (piezo buzzer) or electronic (pin/status output of an analog interface). All alarms will cause the device to switch off the DC output.

The meaning of the signals is as follows:

Signal OT (OverTemperature)	<ul style="list-style-type: none">• Overheating of the device• DC output will be switched off• Non-critical
Signal OVP (OverVoltage)	<ul style="list-style-type: none">• Overvoltage shutdown of the DC output occurs due to high voltage being generated by the device or is entering the device from outside• Critical! The device and/or the load could be damaged
Signal OCP (OverCurrent)	<ul style="list-style-type: none">• Shutdown of the DC output due to excess of the preset limit• Non-critical, protects the load from excessive current drain
Signal OPP (OverPower)	<ul style="list-style-type: none">• Shutdown of the DC output due to excess of the preset limit• Non-critical, protects the load from excessive power drain
Signal PF (Power Fail)	<ul style="list-style-type: none">• DC output shutdown due to AC undervoltage or internal auxiliary supply defect• Critical on AC overvoltage! AC mains input circuit could be damaged

1.8 Technical data

1.8.1 Approved operating conditions

- Use only inside buildings and in a dry environment with air polluted in a normal degree
- Ambient temperature 0-50 °C
- Operational altitude: max. 2000 m above sea level
- Maximum 80% humidity, not condensing

1.8.2 General technical data

Display: Colour TFT display, 480pt x 128pt

Controls: 2 rotary knobs with pushbutton functions, 7 pushbuttons

The nominal values for the device determine the maximum adjustable ranges.

1.8.3 Specific technical data

160 W	Model		
	PS 3040-10 C	PS 3080-05 C	PS 3200-02 C
AC supply			
Voltage range	90...264 V AC	90...264 V AC	90...264 V AC
Connection	Wall outlet	Wall outlet	Wall outlet
Frequency	45-65 Hz	45-65 Hz	45-65 Hz
Fusing	MT 4 A	MT 4 A	MT 4 A
Inrush current @ 230 V	≈ 23 A	≈ 23 A	≈ 23 A
Leak current	< 3.5 mA	< 3.5 mA	< 3.5 mA
Power factor	≈ 0.99	≈ 0.99	≈ 0.99
DC output			
Max. output voltage U_{Max}	40 V	80 V	200 V
Max. output current I_{Max}	10 A	5 A	2 A
Max. output power P_{Max}	160 W	160 W	160 W
Overvoltage protection range	0...44 V	0...88 V	0...220 V
Overcurrent protection range	0...11 A	0...5.5 A	0...2.2 A
Overpower protection range	0...176 W	0...176 W	0...176 W
Output capacitance	3225 μ F	1210 μ F	294 μ F
Temperature coefficient for set values Δ/K	Voltage / current: 100 ppm		
Voltage regulation			
Adjustment range	0...40.8 V	0...81.6 V	0...204 V
Accuracy ⁽¹⁾ (at 23 \pm 5°C)	< 0.1% U_{Max}	< 0.1% U_{Max}	< 0.1% U_{Max}
Line regulation at $\pm 10\%$ ΔU_{AC}	< 0.02% U_{Max}	< 0.02% U_{Max}	< 0.02% U_{Max}
Load regulation at 0...100% load	< 0.05% U_{Max}	< 0.05% U_{Max}	< 0.05% U_{Max}
Settling time after load step	< 1.5 ms	< 1.5 ms	< 1.5 ms
Display: Resolution	See section „1.9.5.4. Resolution of the displayed values“		
Display: Accuracy ⁽³⁾	$\leq 0.2\%$ U_{Max}	$\leq 0.2\%$ U_{Max}	$\leq 0.2\%$ U_{Max}
Ripple ⁽²⁾	< 30 mV _{PP} < 3 mV _{RMS}	< 35 mV _{PP} < 4 mV _{RMS}	< 70 mV _{PP} < 13 mV _{RMS}
Remote sensing compensation	Max. 5% U_{Max}	Max. 5% U_{Max}	Max. 5% U_{Max}
Output voltage fall time (at no load) after switching DC output off	-	Down from 100% to <60 V: less than 10 s	
Current regulation			
Adjustment range	0...10.2 A	0...5.1 A	0...2.04 A
Accuracy ⁽¹⁾ (at 23 \pm 5°C)	< 0.2% I_{Max}	< 0.2% I_{Max}	< 0.2% I_{Max}
Line regulation at $\pm 10\%$ ΔU_{AC}	< 0.05% I_{Max}	< 0.05% I_{Max}	< 0.05% I_{Max}
Load regulation at 0...100% ΔU_{OUT}	< 0.15% I_{Max}	< 0.15% I_{Max}	< 0.15% I_{Max}
Ripple ⁽²⁾	< 15 mA _{RMS}	< 7.5 mA _{RMS}	< 3 mA _{RMS}
Display: Resolution	See section „1.9.5.4. Resolution of the displayed values“		
Display: Accuracy ⁽³⁾	$\leq 0.2\%$ I_{Max}	$\leq 0.2\%$ I_{Max}	$\leq 0.2\%$ I_{Max}
Power regulation			
Adjustment range	0...163.2 W	0...163.2 W	0...163.2 W
Accuracy ⁽¹⁾ (at 23 \pm 5°C)	< 1% P_{Max}	< 1% P_{Max}	< 1% P_{Max}
Line regulation at $\pm 10\%$ ΔU_{AC}	< 0.05% P_{Max}	< 0.05% P_{Max}	< 0.05% P_{Max}
Load regulation at 10-90% ΔU_{OUT} * ΔI_{OUT}	< 1% P_{Max}	< 1% P_{Max}	< 1% P_{Max}

(1) Related to the nominal values, the accuracy defines the maximum deviation between an adjusted values and the true (actual) value.

(2) RMS value: LF 0...300 kHz, PP value: HF 0...20MHz

(3) The display error adds to the error of the related actual value on the DC output

160 W	Model		
	PS 3040-10 C	PS 3080-05 C	PS 3200-02 C
Power regulation			
Display: Resolution	See section „1.9.5.4. Resolution of the displayed values“		
Display: Accuracy ⁽¹⁾	≤ 0,5% P _{Nenn}	≤ 0,5% P _{Nenn}	≤ 0,5% P _{Nenn}
Analog interface (optional) ⁽²⁾			
Set value inputs	U, I, P		
Actual value output	U, I		
Control signals	DC on/off, remote control on/off		
Status signals	CV, OVP, OT		
Insulation			
Output (DC) to enclosure (PE)	DC minus: permanent max. ±400 V DC plus: permanent max. ±400V + output voltage		
Input (AC) to output (DC)	Max. 2500 V, short-term		
Miscellaneous			
Cooling	Temperature controlled fan, side inlet, rear exhaust		
Ambient temperature	0..50°C		
Storage temperature	-20...70°C		
Humidity	< 80%, not condensing		
Standards	EN 61010-1:2011-07, EN 61000-6-4:2011-09, EN 61000-6-2:2011-06 Class B		
Overvoltage category	2		
Protection class	1		
Pollution degree	2		
Operational altitude	< 2000 m		
Digital interfaces (optional)			
Available plug-in cards	IF-KE5 USB: 1x USB IF-KE5 USBLAN: 1x USB + 1x LAN IF-KE5 USBANALOG: 1x USB + 1x Analog		
Terminals			
Rear side	AC input, analog interface (optional), USB (optional), Ethernet (optional)		
Front side	DC output, USB-A, remote sensing		
Dimensions			
Enclosure (WxHxD)	260 x 88 x 323 mm		
Total (WxHxD)	308 x min. 103 x min. 359 mm		
Weight	≈ 4 kg	≈ 4 kg	≈ 4 kg
Article number	35320208	35320209	35320210

(1) The display error adds to the error of the related actual value on the DC output

(3) For technical specifications of the analog interface see „3.5.4.4 Analog interface specification“ on page 41

320 W	Model		
	PS 3040-20 C	PS 3080-10 C	PS 3200-04 C
AC supply			
Voltage range	90...264 V AC	90...264 V AC	90...264 V AC
Connection	Wall outlet	Wall outlet	Wall outlet
Frequency	45-65 Hz	45-65 Hz	45-65 Hz
Fusing	MT 4 A	MT 4 A	MT 4 A
Inrush current @ 230 V	≈ 23 A	≈ 23 A	≈ 23 A
Leak current	< 3.5 mA	< 3.5 mA	< 3.5 mA
Power factor	≈ 0.99	≈ 0.99	≈ 0.99
DC output			
Max. output voltage U_{Max}	40 V	80 V	200 V
Max. output current I_{Max}	20 A	10 A	4 A
Max. output power P_{Max}	320 W	320 W	320 W
Overvoltage protection range	0...44 V	0...88 V	0...220 V
Overcurrent protection range	0...22 A	0...11 A	0...4.4 A
Overpower protection range	0...352 W	0...352 W	0...352 W
Output capacitance	3225 μ F	1210 μ F	294 μ F
Temperature coefficient for set values Δ/K	Voltage / current: 100 ppm		
Voltage regulation			
Adjustment range	0...40.8 V	0...81.6 V	0...204 V
Accuracy ⁽¹⁾ (at 23 \pm 5°C)	< 0.1% U_{Max}	< 0.1% U_{Max}	< 0.1% U_{Max}
Line regulation at $\pm 10\%$ ΔU_{AC}	< 0.02% U_{Max}	< 0.02% U_{Max}	< 0.02% U_{Max}
Load regulation at 0...100% load	< 0.05% U_{Max}	< 0.05% U_{Max}	< 0.05% U_{Max}
Settling time after load step	< 1.5 ms	< 1.5 ms	< 1.5 ms
Display: Resolution	See section „1.9.5.4. Resolution of the displayed values“		
Display: Accuracy ⁽³⁾	$\leq 0.2\%$ U_{Max}	$\leq 0.2\%$ U_{Max}	$\leq 0.2\%$ U_{Max}
Ripple ⁽²⁾	< 30 mV _{PP} < 3 mV _{RMS}	< 35 mV _{PP} < 4 mV _{RMS}	< 70 mV _{PP} < 13 mV _{RMS}
Remote sensing compensation	Max. 5% U_{Max}	Max. 5% U_{Max}	Max. 5% U_{Max}
Output voltage fall time (at no load) after switching DC output off	-	Down from 100% to <60 V: less than 10 s	
Current regulation			
Adjustment range	0...20.4 A	0...10.2 A	0...4.08 A
Accuracy ⁽¹⁾ (at 23 \pm 5°C)	< 0.2% I_{Max}	< 0.2% I_{Max}	< 0.2% I_{Max}
Line regulation at $\pm 10\%$ ΔU_{AC}	< 0.05% I_{Max}	< 0.05% I_{Max}	< 0.05% I_{Max}
Load regulation at 0...100% ΔU_{OUT}	< 0.15% I_{Max}	< 0.15% I_{Max}	< 0.15% I_{Max}
Ripple ⁽²⁾	< 20 mA _{RMS}	< 15 mA _{RMS}	< 6 mA _{RMS}
Display: Resolution	See section „1.9.5.4. Resolution of the displayed values“		
Display: Accuracy ⁽³⁾	$\leq 0.2\%$ I_{Max}	$\leq 0.2\%$ I_{Max}	$\leq 0.2\%$ I_{Max}
Power regulation			
Adjustment range	0...326.4 W	0...326.4 W	0...326.4 W
Accuracy ⁽¹⁾ (at 23 \pm 5°C)	< 1% P_{Max}	< 1% P_{Max}	< 1% P_{Max}
Line regulation at $\pm 10\%$ ΔU_{AC}	< 0.05% P_{Max}	< 0.05% P_{Max}	< 0.05% P_{Max}
Load regulation at 10-90% ΔU_{OUT} * ΔI_{OUT}	< 1% P_{Max}	< 1% P_{Max}	< 1% P_{Max}

(1) Related to the nominal values, the accuracy defines the maximum deviation between an adjusted values and the true (actual) value.

(2) RMS value: LF 0...300 kHz, PP value: HF 0...20MHz

(3) The display error adds to the error of the related actual value on the DC output

320 W	Model		
	PS 3040-20 C	PS 3080-10 C	PS 3200-04 C
Power regulation			
Display: Resolution	See section „1.9.5.4. Resolution of the displayed values“		
Display: Accuracy ⁽¹⁾	≤ 0,5% P _{Nenn}	≤ 0,5% P _{Nenn}	≤ 0,5% P _{Nenn}
Analog interface (optional) ⁽²⁾			
Set value inputs	U, I, P		
Actual value output	U, I		
Control signals	DC on/off, remote control on/off		
Status signals	CV, OVP, OT		
Insulation			
Output (DC) to enclosure (PE)	DC minus: permanent max. ±400 V DC plus: permanent max. ±400V + output voltage		
Input (AC) to output (DC)	Max. 2500 V, short-term		
Miscellaneous			
Cooling	Temperature controlled fan, side inlet, rear exhaust		
Ambient temperature	0..50°C		
Storage temperature	-20...70°C		
Humidity	< 80%, not condensing		
Standards	EN 61010-1:2011-07, EN 61000-6-4:2011-09, EN 61000-6-2:2011-06 Class B		
Overvoltage category	2		
Protection class	1		
Pollution degree	2		
Operational altitude	< 2000 m		
Digital interfaces (optional)			
Available plug-in cards	IF-KE5 USB: 1x USB IF-KE5 USBLAN: 1x USB + 1x LAN IF-KE5 USBANALOG: 1x USB + 1x Analog		
Terminals			
Rear side	AC input, analog interface (optional), USB (optional), Ethernet (optional)		
Front side	DC output, USB-A, remote sensing		
Dimensions			
Enclosure (WxHxD)	260 x 88 x 323 mm		
Total (WxHxD)	308 x min. 103 x min. 359 mm		
Weight	≈ 4 kg	≈ 4 kg	≈ 4 kg
Article number	35320211	35320212	35320213

(1 The display error adds to the error of the related actual value on the DC output

(2 For technical specifications of the analog interface see „3.5.4.4 Analog interface specification“ on page 41

640 W	Model		
	PS 3040-40 C	PS 3080-20 C	PS 3200-10 C
AC supply			
Voltage range	90...264 V AC	90...264 V AC	90...264 V AC
Connection	Wall outlet	Wall outlet	Wall outlet
Frequency	45-65 Hz	45-65 Hz	45-65 Hz
Fusing	MT 8 A	MT 8 A	MT 8 A
Inrush current @ 230 V	≈ 23 A	≈ 23 A	≈ 23 A
Leak current	< 3.5 mA	< 3.5 mA	< 3.5 mA
Power factor	≈ 0.99	≈ 0.99	≈ 0.99
DC output			
Max. output voltage U_{Max}	40 V	80 V	200 V
Max. output current I_{Max}	40 A	20 A	10 A
Max. output power P_{Max}	640 W	640 W	640 W
Overvoltage protection range	0...44 V	0...88 V	0...220 V
Overcurrent protection range	0...44 A	0...22 A	0...11 A
Overpower protection range	0...704 W	0...704 W	0...704 W
Output capacitance	4400 μ F	2940 μ F	600 μ F
Temperature coefficient for set values Δ/K	Voltage / current: 100 ppm		
Voltage regulation			
Adjustment range	0...40.8 V	0...81.6 V	0...204 V
Accuracy ⁽¹⁾ (at 23 \pm 5°C)	< 0.1% U_{Max}	< 0.1% U_{Max}	< 0.1% U_{Max}
Line regulation at $\pm 10\%$ ΔU_{AC}	< 0.02% U_{Max}	< 0.02% U_{Max}	< 0.02% U_{Max}
Load regulation at 0...100% load	< 0.05% U_{Max}	< 0.05% U_{Max}	< 0.05% U_{Max}
Settling time after load step	< 1.5 ms	< 1.5 ms	< 1.5 ms
Display: Resolution	See section „1.9.5.4. Resolution of the displayed values“		
Display: Accuracy ⁽³⁾	\leq 0.2% U_{Max}	\leq 0.2% U_{Max}	\leq 0.2% U_{Max}
Ripple ⁽²⁾	< 25 mV _{PP} < 4 mV _{RMS}	< 40 mV _{PP} < 6 mV _{RMS}	< 100 mV _{PP} < 25 mV _{RMS}
Remote sensing compensation	Max. 5% U_{Max}	Max. 5% U_{Max}	Max. 5% U_{Max}
Output voltage fall time (at no load) after switching DC output off	-	Down from 100% to <60 V: less than 10 s	
Current regulation			
Adjustment range	0...40.8 A	0...20.4 A	0...10.2 A
Accuracy ⁽¹⁾ (at 23 \pm 5°C)	< 0.2% I_{Max}	< 0.2% I_{Max}	< 0.2% I_{Max}
Line regulation at $\pm 10\%$ ΔU_{AC}	< 0.05% I_{Max}	< 0.05% I_{Max}	< 0.05% I_{Max}
Load regulation at 0...100% ΔU_{OUT}	< 0.15% I_{Max}	< 0.15% I_{Max}	< 0.15% I_{Max}
Ripple ⁽²⁾	< 60 mA _{RMS}	< 30 mA _{RMS}	< 12 mA _{RMS}
Display: Resolution	See section „1.9.5.4. Resolution of the displayed values“		
Display: Accuracy ⁽³⁾	\leq 0.2% I_{Max}	\leq 0.2% I_{Max}	\leq 0.2% I_{Max}
Power regulation			
Adjustment range	0...652.8 W	0...652.8 W	0...652.8 W
Accuracy ⁽¹⁾ (at 23 \pm 5°C)	< 1% P_{Max}	< 1% P_{Max}	< 1% P_{Max}
Line regulation at $\pm 10\%$ ΔU_{AC}	< 0.05% P_{Max}	< 0.05% P_{Max}	< 0.05% P_{Max}
Load regulation at 10-90% ΔU_{OUT} * ΔI_{OUT}	< 1% P_{Max}	< 1% P_{Max}	< 1% P_{Max}

(1) Related to the nominal values, the accuracy defines the maximum deviation between an adjusted values and the true (actual) value.

(2) RMS value: LF 0...300 kHz, PP value: HF 0...20MHz

(3) The display error adds to the error of the related actual value on the DC output

640 W	Model		
	PS 3040-40 C	PS 3080-20 C	PS 3200-10 C
Power regulation			
Display: Resolution	See section „1.9.5.4. Resolution of the displayed values“		
Display: Accuracy ⁽¹⁾	≤ 0,5% P _{Nenn}	≤ 0,5% P _{Nenn}	≤ 0,5% P _{Nenn}
Analog interface (optional) ⁽²⁾			
Set value inputs	U, I, P		
Actual value output	U, I		
Control signals	DC on/off, remote control on/off		
Status signals	CV, OVP, OT		
Insulation			
Output (DC) to enclosure (PE)	DC minus: permanent max. ±400 V DC plus: permanent max. ±400V + output voltage		
Input (AC) to output (DC)	Max. 2500 V, short-term		
Miscellaneous			
Cooling	Temperature controlled fan, side inlet, rear exhaust		
Ambient temperature	0..50°C		
Storage temperature	-20...70°C		
Humidity	< 80%, not condensing		
Standards	EN 61010-1:2011-07, EN 61000-6-4:2011-09, EN 61000-6-2:2011-06 Class B		
Overvoltage category	2		
Protection class	1		
Pollution degree	2		
Operational altitude	< 2000 m		
Digital interfaces (optional)			
Available plug-in cards	IF-KE5 USB: 1x USB IF-KE5 USBLAN: 1x USB + 1x LAN IF-KE5 USBANALOG: 1x USB + 1x Analog		
Terminals			
Rear side	AC input, analog interface (optional), USB (optional), Ethernet (optional)		
Front side	DC output, USB-A, remote sensing		
Dimensions			
Enclosure (WxHxD)	260 x 88 x 350 mm		
Total (WxHxD)	308 x min. 103 x min. 359 mm		
Weight	≈ 5 kg	≈ 5 kg	≈ 5 kg
Article number	35320214	35320215	35320216

(1 The display error adds to the error of the related actual value on the DC output

(2 For technical specifications of the analog interface see „3.5.4.4 Analog interface specification“ on page 41

1.8.4 Views

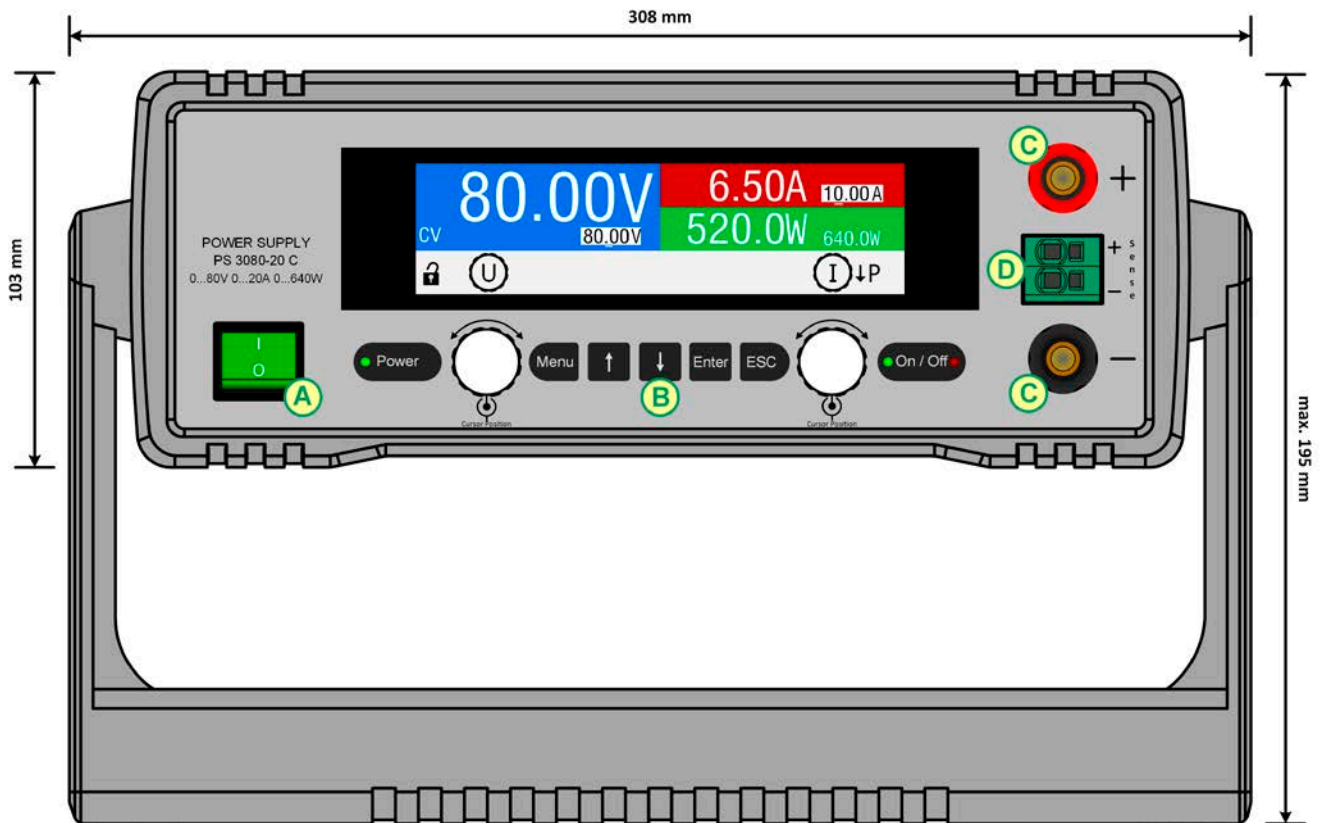

Figure 1 - Front side

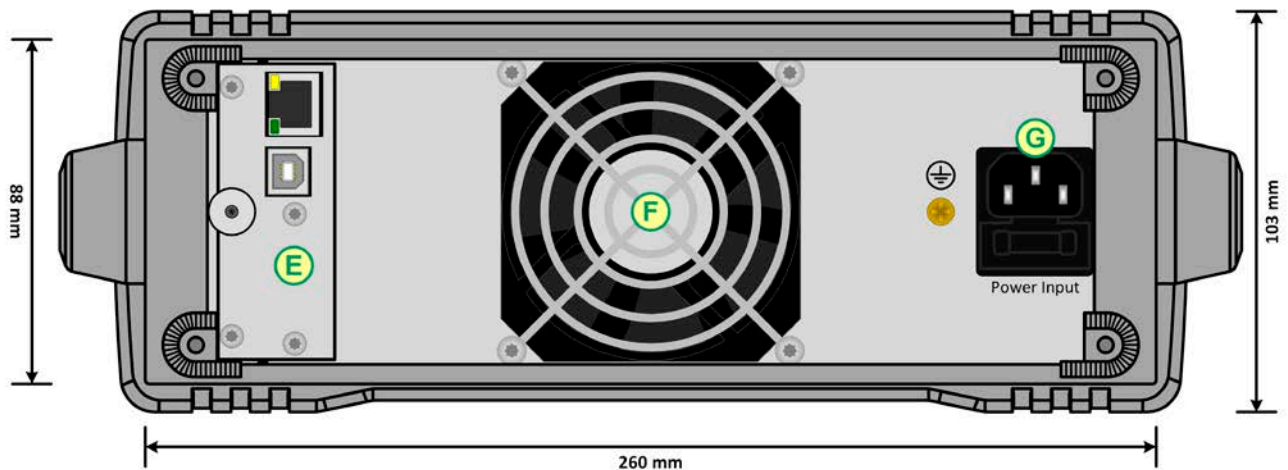

Figure 2 - Rear side (320 W model shown)



Do not loosen the grounding point (brass screw next to AC socket G) in order to connect PE cables! The device is supposed to be grounded via the AC cord, while the grounding point is used to connect the enclosure to PE.

A - Power switch

B - Control panel

C - DC output

D - Remote sensing input

E - Remote control interfaces (optional, USB/Ethernet shown)

F - Air exhaust (models from 320 W with fan)

G - AC socket with fuse holder

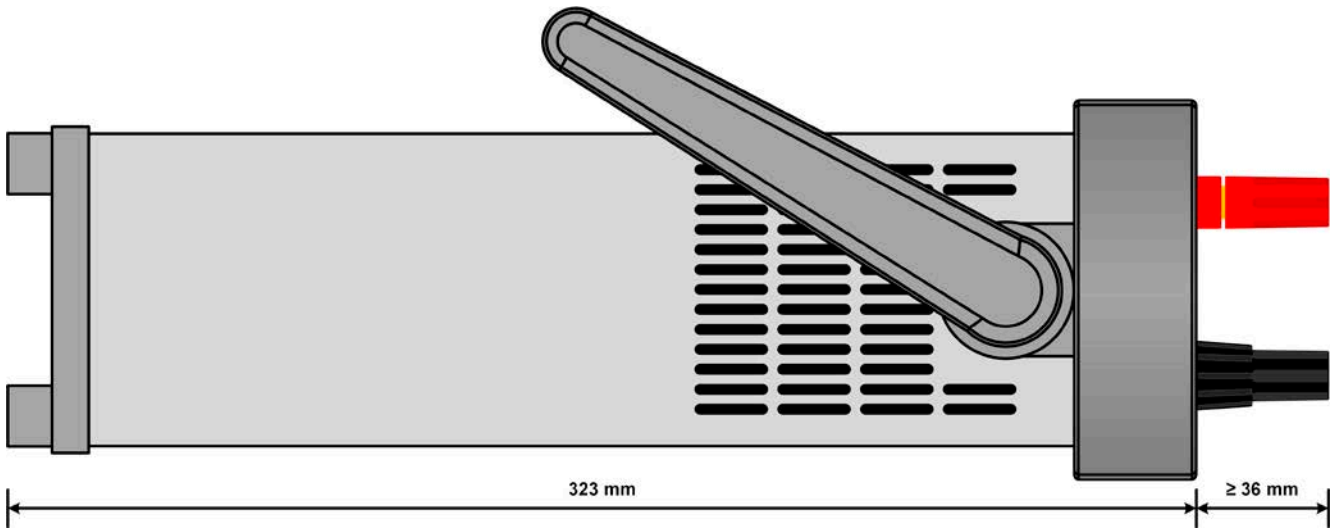

Figure 3 - Side view from left, horizontal position (320 W model shown)

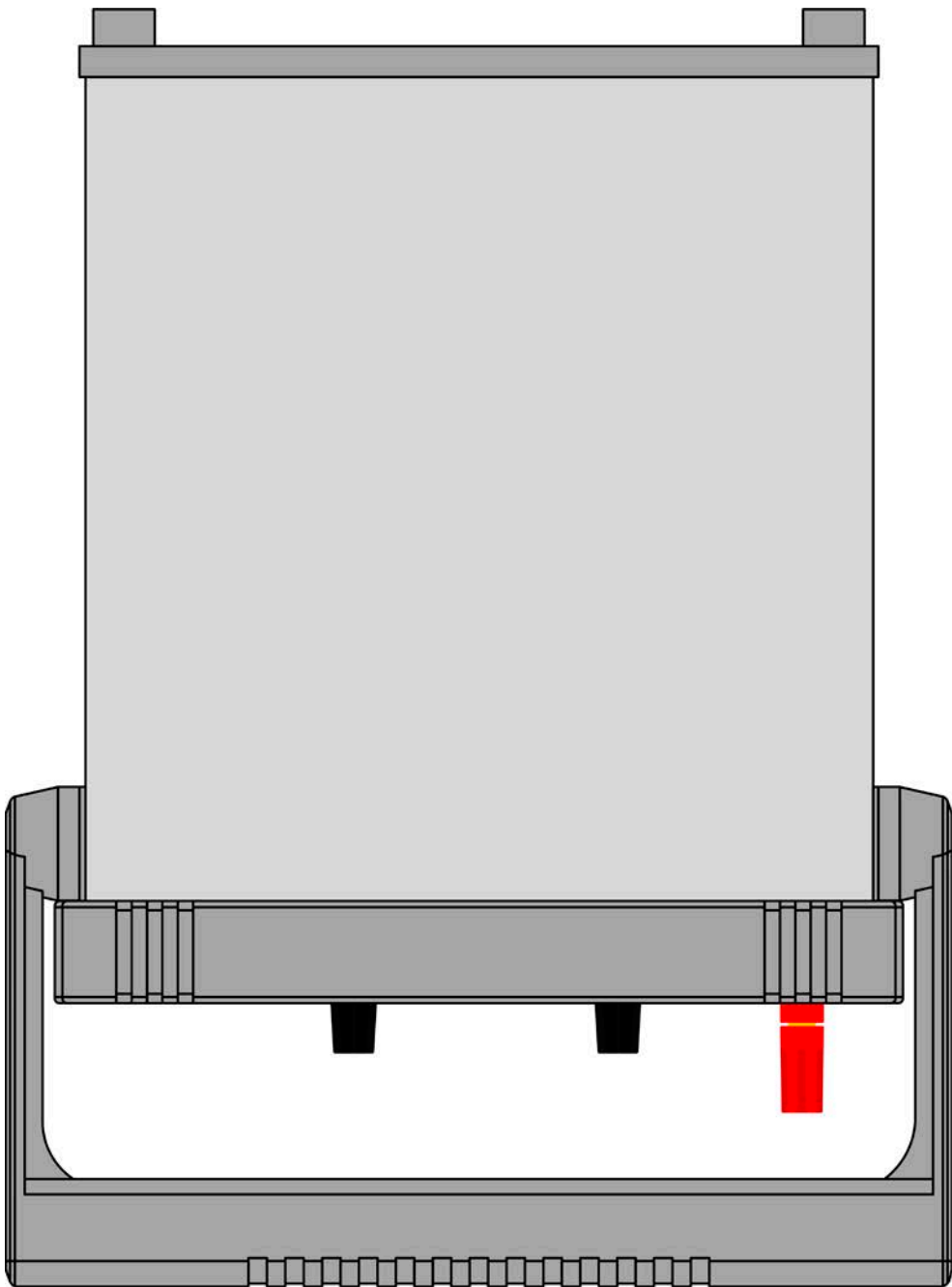

Figure 4 - Top view (320 W model shown)

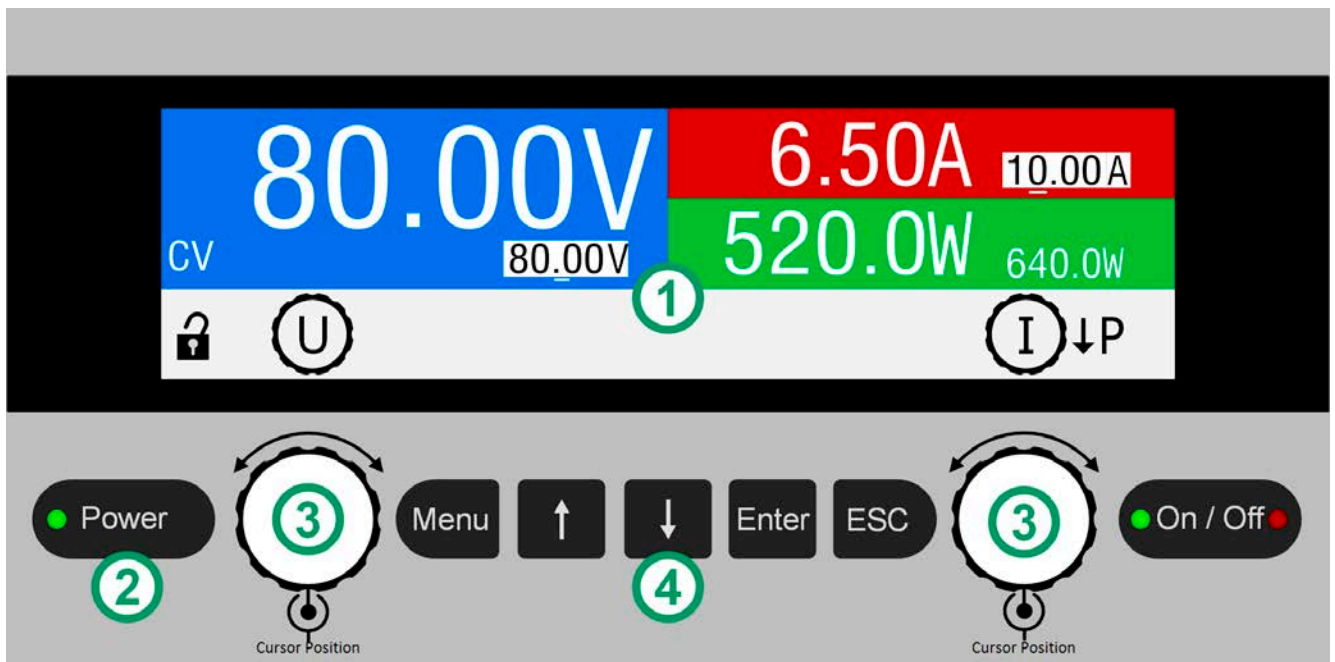

Figure 5 - Control Panel

Overview of the elements on the control panel

For a detailed description see section „1.9.5. The control panel (HMI)“ and „1.9.5.2. Rotary knobs“.

(1)	<p>Colour display Used for display of set values, menus, actual values, status and rotary knob assignment.</p>
(2)	<p>LED “Power” Indicates different colours during the start of the device and once ready for operation, it turns green and remains for the period of operation.</p>
(3)	<p>Rotary knob with push button function Left knob (turn): adjustment of the voltage set value or setting parameter values in the menu Left knob (push): selection of the decimal position (cursor) of the currently assigned value Right knob (turn): adjustment of current or power set value or setting parameter values in the menu Right knob (push): selection of the decimal position (cursor) of the currently assigned value</p>
(4)	<p>Pushbuttons</p>
	<p>Menu Is used to access the device menu (while the DC output is off) or to quick access the HMI lock feature (while the DC output is on)</p>
	<p>↑ ↓ Are used to navigate in the sub menus of the device menu and to switch between parameters and values, as well as to switch the knob assignment in the main screen</p>
	<p>Enter Is used to access sub menus in the device menu, to submit changes of settings and values, as well as to unlock the HMI</p>
	<p>ESC Is uses to exit menu pages and to cancel changes on values and settings</p> <p>● On / Off ● Is used to switch the DC output on or off during manual control. The two LEDs indicate the DC output condition all the time, no matter if during manual or remote control (green = on, red = off)</p>

1.9 Construction and function

1.9.1 General description

The laboratory power supply devices of PS 3000 C series are the third generation of small desktop units in the power class up to 640 W. Due to their compact size they're especially suitable for research laboratories, test applications or educational purposes.

For remote control using a PC the devices can be equipped with an optional, separately available and user-retrofitable interface card. There is a choice of three different types: USB, USB+Ethernet or USB+Analog. All interfaces are galvanically isolated from the device.

The standard carrying handle can serve as tilt stand, allowing for setup of different positions in order to make it easier to read from the display or access the control elements.

All models are controlled by microprocessors.

1.9.2 Block diagram

The block diagram illustrates the main components inside the device and their relationships.

There are digital, microprocessor controlled components (KE, DR, HMI), which can be target of firmware updates. See below (dotted elements are optional components):

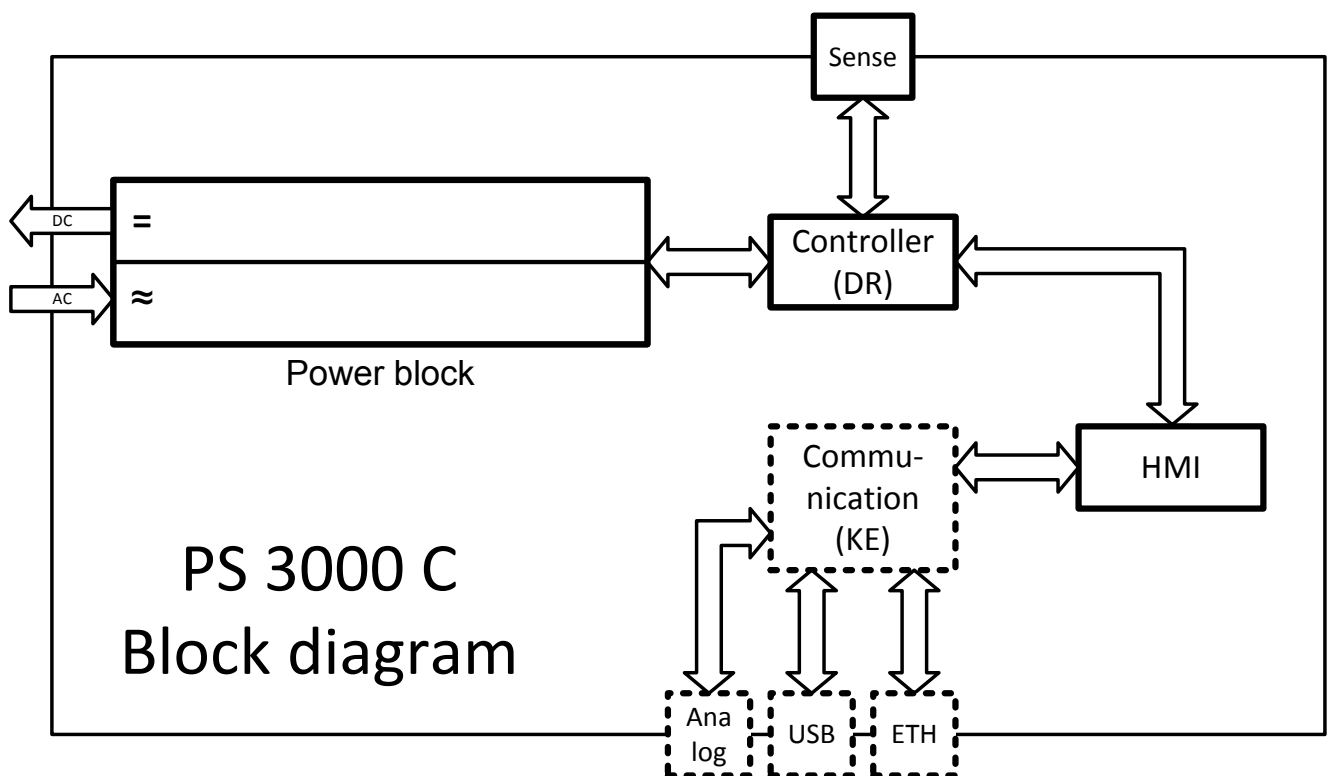

1.9.3 Scope of delivery

- 1 x Power supply device
- 1 x USB stick with documentation and software
- 1 x Mains cord
- 1 x UK wall socket adapter

1.9.4 Optional accessories

For these devices the following accessories are available:

IF-KE5 USB Ordering nr. 33 100 232	Digital interface card with USB port . Can be ordered separately. Simple installation by the user on location. USB cable of 1.8 m length included.
IF-KE5 USB LAN Ordering nr. 33 100 233	Digital interface card with USB port and Ethernet/LAN port . Can be ordered separately. Simple installation by the user on location. USB cable of 1.8 m length included.
IF-KE5 USB Analog Ordering nr. 33 100 234	Digital/analog interface card with USB port and 15 pole analog D-Sub port . Can be ordered separately. Simple installation by the user on location. USB cable of 1.8 m length included.

1.9.5 The control panel (HMI)

The HMI (Human Machine Interface) consists of a display, two rotary knobs and six pushbuttons.

1.9.5.1 Display

The graphic display is divided into a number of areas. In normal operation the upper part ($\frac{2}{3}$) is used to show actual and set values and the lower part ($\frac{1}{3}$) to display status information:

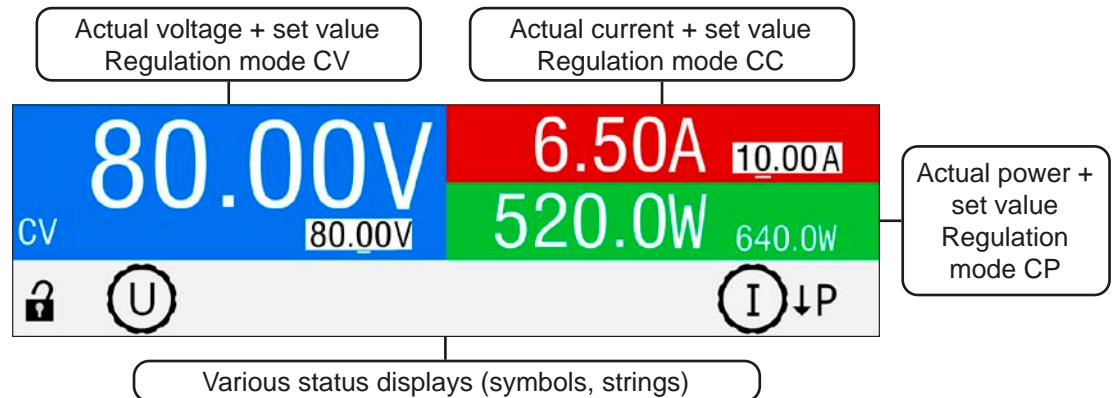

- **Actual / set values area (blue / green / red)**

In normal operation the DC output values (large numbers) and set values (small numbers) for voltage (blue), current (red) and power (green).

While the DC output is switched on, the actual regulation mode of the source being either constant voltage (CV), constant current (CC) or constant power (CP) is displayed in the corresponding area, as exemplary shown in the figure above with **CV**.



The set values can be adjusted by rotating the knobs below the display, whereas pushing the knobs is used to switch the digit to be changed. Logically, the values are increased by clockwise turning and decreased by anti-clockwise turning. The currently active assignment of set a value to a knob is indicated by the corresponding set value being displayed in inverted form and also by the knob depiction in the status area showing the physical sign (U, I or P). In case these are not shown, the values can't be adjusted manually, like when the HMI is lock or the device is in remote control.

General display and setting ranges:

Display	Unit	Range	Description
Actual voltage	V	0.2-125% U_{Nom}	Actual value of DC output voltage
Set value of voltage	V	0-102% U_{Nom}	Set value for limiting the DC output voltage
Actual current	A	0.2-125% I_{Nom}	Actual value of DC output current
Set value of current	A	0-102% I_{Nom}	Set value for limiting the DC output current
Actual power	W	0.2-125% P_{Nom}	Calculated actual value of output power, $P = U_{IN} * I_{IN}$
Set value of power	W	0-102% P_{Nom}	Set value for limiting the DC output power
Adjustment limits	A, W, V	0-102% nom.	U-max, I-min etc., related to the physical values
Protection settings	A, W, V	0-110% nom.	OCP, OVP and OPP, related to the physical values

• **Status display (lower part)**

This area displays various status texts and symbols:

Display	Description
	The HMI is locked
	The HMI is unlocked
Remote:	The device is under remote control from....
Analogthe optional analog interface
USBthe optional USB port
Ethernetthe optional Ethernet port
Local	The device has been locked by the user explicitly against remote control
Alarm:	Alarm condition which has not been acknowledged or still exists.

• **Area for assigning the rotary knobs**

The two rotary knobs below the display screen can be assigned to various functions. The status area in the display area depicts the actual assignments. After the device start and in the main screen the default assignment is voltage (left-hand knob) and current (right-hand knob):



These two values can then be adjusted manually. The decimal place to adjust is underlined, the currently selected value is displayed in inverted format:



There are following possible assignments, whereas the right-hand knob remains assigned to the set value of current:

U I

Left rotary knob: voltage
Right rotary knob: current

U P

Left rotary knob: voltage
Right rotary knob: power

The other set values can't be adjusted directly, until the assignment is changed. This is done using the "arrow down" button, as depicted by this symbol next to the corresponding knob depiction:



. With this being shown, the momentary assignment is to current and it can be changed to power.

1.9.5.2 Rotary knobs



As long as the device is in manual operation the two rotary knobs are used to adjust set values as well as setting the parameters in the "Menu". For a detailed description of the individual functions see section „3.4 Manual operation“ on page 32.

1.9.5.3 Button function of the rotary knobs

The rotary knobs also have a pushbutton function which is used anywhere during value adjustment to shift the cursor as shown:



1.9.5.4 Resolution of the displayed values

In the display, set values can be adjusted with a fixed step width. The number of decimal places depends on the device model. All values have 4 digits. Adjustment resolution of set values in the display:

Voltage, OVP, U-min, U-max		Current, OCP, I-min, I-max		Power, OPP, P-max	
Nominal	Minimum step width	Nominal	Minimum step width	Nominal	Minimum step width
40 V	0.01 V	2 A - 5 A	0.001 A	160 W	0.1 W
80 V	0.01 V	10 A - 40 A	0.01 A	320 W	0.1 W
200 V	0.1 V			640 W	0.1 W

1.9.6 USB port (optional)

On the rear side of the device there is a slot to install one out of three types of optionally available, user-retrofitable interface cards. Also see section 1.9.4. All three types feature a USB port.

The USB port is for communication with the device and for firmware updates. The USB cable (included with the interface card) can be used to connect the device to a PC (USB 2.0 or 3.0). The driver is delivered on the included USB stick and installs a virtual COM port. Details for remote control can be found on the web site of Elektro-Automatik or on the USB stick included in the delivery.

The device can be addressed via this port either using the international standard ModBus RTU protocol or by SCPI language. The device recognises the message protocol automatically.

When requesting remote control via the USB port it has no priority over any other digital or analog interface and can, therefore, only be used alternatively to these. However, monitoring is always available.

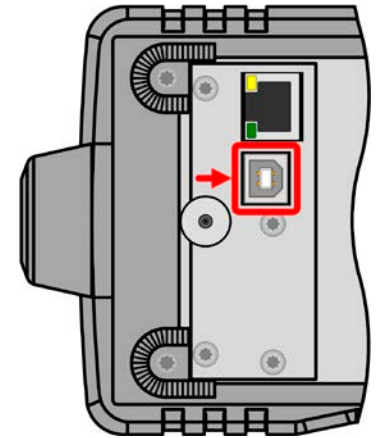

1.9.7 Ethernet port (optional)

On the rear side of the device there is a slot to install one out of three types of optionally available, user-retrofitable interface cards. Also see section 1.9.4. One of the types features an Ethernet/LAN port, plus a USB port.

The Ethernet port is for communication with the device in terms of remote control or monitoring over longer distances than possible with USB. The user has basically two options of access:

1. A website (HTTP, port 80) which is accessible in a standard browser under the IP or the host name given for the device. This website offers to configuration page for network parameters, as well as a input box for SCPI commands.
2. TCP/IP access via a freely selectable port (except 80 and other reserved ports). The standard port for this device is 5025. Via TCP/IP and this port, communication to the device can be established in most of the common programming languages.

Using the Ethernet port, the device can either be controlled by commands from SCPI or ModBus RTU protocol, while automatically detecting the type of message.

The network setup can be done manually or by DHCP. The transmission speed is set to "Auto negotiation" and means it can use 10MBit/s or 100MBit/s. 1GB/s isn't supported. Duplex mode is always full duplex.

When requesting remote control via the Ethernet port it has no priority over the USB port and can, therefore, only be used alternatively to these. However, monitoring is always available.

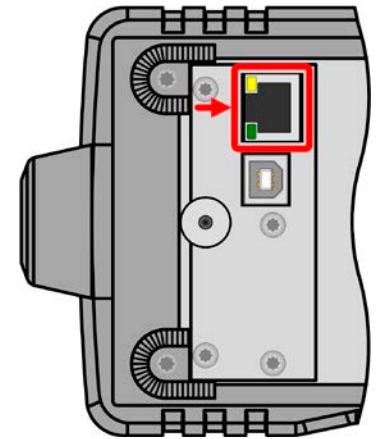

1.9.8 Analog interface (optional)

On the rear side of the device there is a slot to install one out of three types of optionally available, user-retrofitable interface cards. Also see section 1.9.4. One of the types features an analog 15 pole D-Sub type connector, plus a USB port.

This 15 pole socket is provided for remote control of the device via analog and digital switch signals. When requesting remote control via the analog port it has no priority over a digital interface and can, therefore, only be used alternatively to it. However, monitoring is always available.

The input voltage range of the set values and the output voltage range of the monitor values, as well as reference voltage level can be switched in the settings menu of the device between 0-5 V and 0-10 V, in each case for 0-100%.

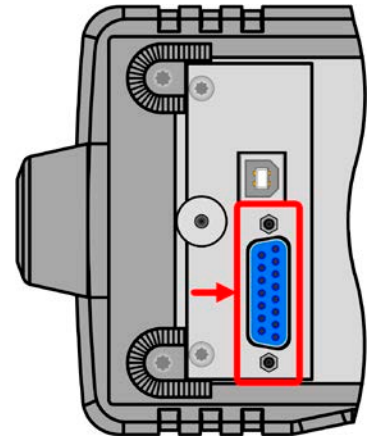

1.9.9 “Sense” connector (remote sensing)

In order to compensate for voltage drops along the DC cables, the **Sense** input (between the DC output terminals) can be connected to the load. The device will automatically detect when the Sense input is wired and compensate the input voltage up to a certain level. Remote sensing and its compensation is only effective in constant voltage operation.

The maximum possible compensation is given in the technical specifications.

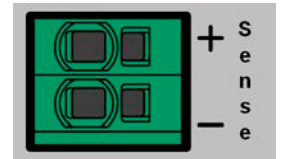

2. Installation & commissioning

2.1 Storage

2.1.1 Packaging

It's recommended to keep the complete transport packaging for the lifetime of the device for relocation or return to Elektro-Automatik for repair. Otherwise the packaging should be disposed of in an environmentally friendly way.

2.1.2 Storage

In case of long term storage of the equipment it's recommended to use the original packaging or similar. Storage must be in dry rooms, if possible in sealed packaging, to avoid corrosion, especially internal, through humidity.

2.2 Unpacking and visual check

After every transport, with or without packaging, or before commissioning, the equipment should be visually inspected for damage and completeness using the delivery note and/or parts list (see section „1.9.3. Scope of delivery“). An obviously damaged device (e.g. loose parts inside, damage outside) must under no circumstances be put in operation.

2.3 Installation

2.3.1 Safety procedures before installation and use



- Before connecting to the mains ensure that the connection is as shown on the product label. Overvoltage on the AC supply can cause equipment damage.
- In case the load is also a voltage source (motor, battery etc.) make sure before connecting it, that the source can't generate a voltage higher than 1.1 * rated voltage of your particular device model or install measures which can prevent damaging the device by overvoltage from outside.

2.3.2 Preparation

Mains connection for a PS 3000 C series device is done via the included 1.5 meters long 3 pole mains cord.

Dimensioning of the DC wiring to the load has to reflect the following:



- The cable cross section should always be specified for at least the maximum current of the device.
- Continuous operation at the approved limit generates heat which must be removed, as well as voltage loss which depends on cable length and heating. To compensate for these the cable cross section should be increased and/or the cable length reduced.

2.3.3 Installing the device



- Select the location for the device so that the connection to the load is as short as possible.
- Leave sufficient space behind the equipment, minimum 30 cm, for ventilation of warm air that will be exhausted
- Never obstruct the air inlets on the sides!
- In case the handle is used to bring the device into an uplifted position, never place any objects onto the top of the unit!

2.3.3.1 The handle

The included handle isn't only used to carry the device, it can also uplift the device's front for easier access to knobs and buttons or better display readability.

The handle can be rotated into various positions in an angle of 300°, such as a variable position (60...150°), 0°, -45°, -90° and -150°.

It's accomplished by pulling on both sides of the handle first in order to loosen the detent and then rotating the handle around its axis.

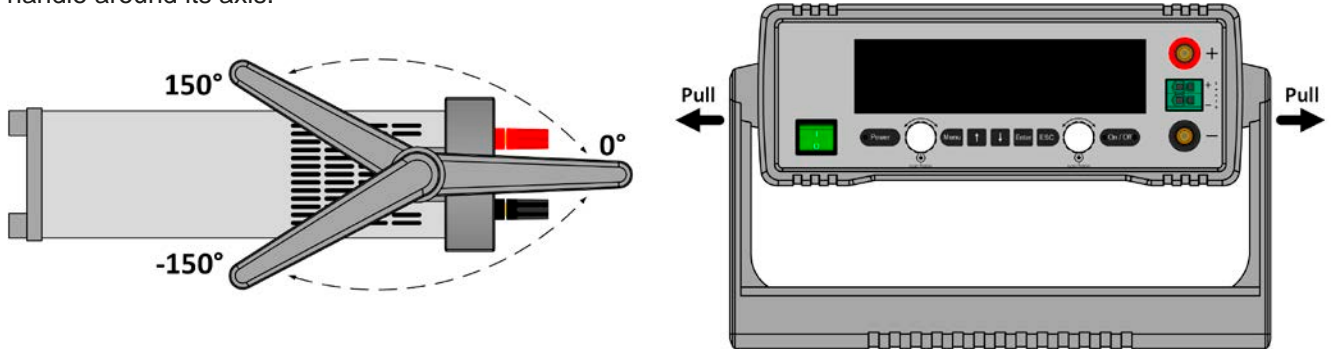

2.3.3.2 Placement on horizontal standing surfaces

The device is designed as a desktop unit and should only be operated in horizontal position on horizontal surfaces, which are capable of securely carrying the weight of the device.

Acceptable and unacceptable operating positions:

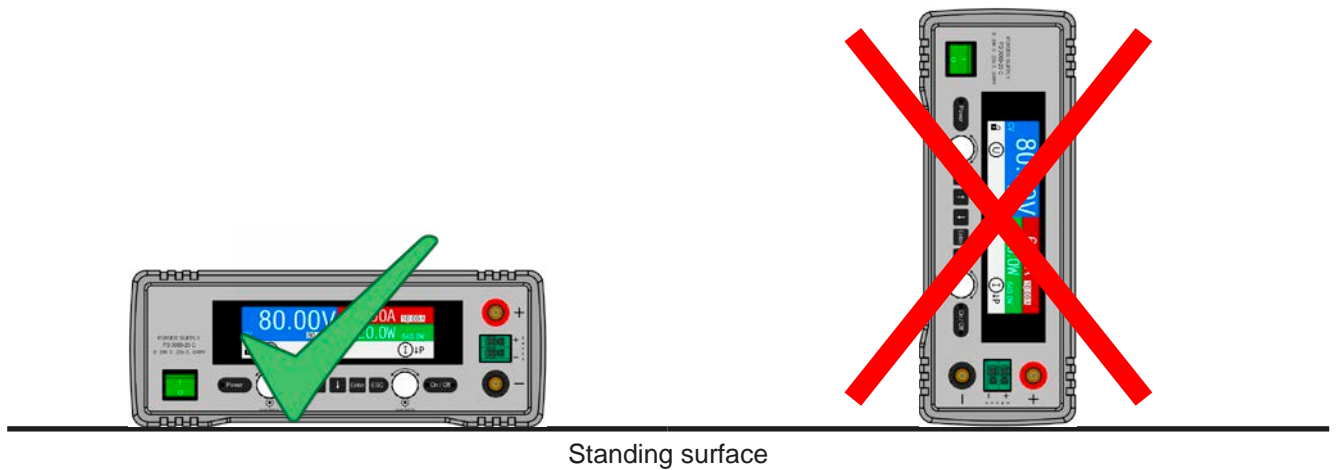
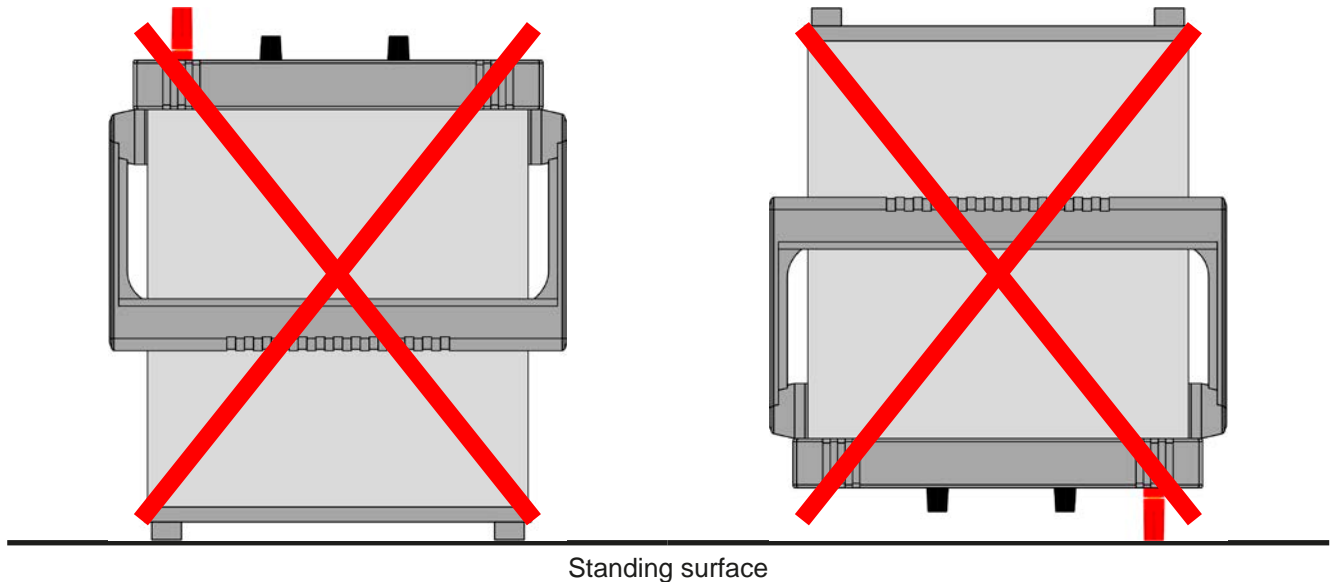

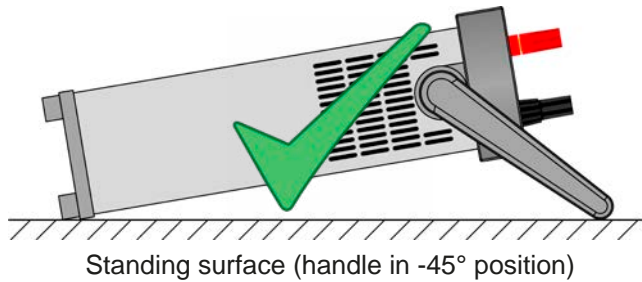

2.3.4 Connection to DC loads



- When using the model which is rated for 40 A, attention has to be paid to where the load is connected on the DC output terminals. The front 4mm banana plug hole is only rated for **max. 32 A!**
- Connection of loads which are also voltage sources and can probably generate voltages higher than 110% nominal of the device model isn't allowed!
- Connection of voltage sources with reversed polarity isn't allowed!

The DC output is located on the front of the device and isn't protected by a fuse. The cross section of the connection cable is determined by the current consumption, cable length and ambient temperature.

For cables **up to 5 m** and average ambient temperature up to 50°C, we recommend:

up to **10 A**: 0.75 mm² (AWG18) up to **25 A**: 4 mm² (AWG10)

up to **60 A**: 16 mm² (AWG4)

per lead (multi-conductor, insulated, openly suspended). Single cables of, for example, 16 mm² may be replaced by e.g. 2x 6 mm² etc. If the cables are long then the cross section must be increased to avoid voltage loss and overheating.

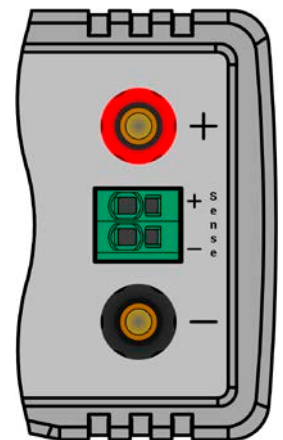

2.3.4.1 Possible connections on the DC output

The DC output on the front is of type clamp & plug and can be used with:

- 4 mm system plugs (Büschel, banana, safety) for **max. 32 A**
- Spade lugs (6 mm or bigger)
- Soldered cable ends (only recommended for small currents up to 10 A)

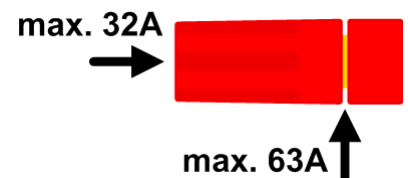

When using any type of lugs or cable end sleeves, only use those with insulation to ensure electric shock protection!

2.3.5 Grounding of the DC output

Grounding one of the DC output poles is permissible, but causes potential shift against PE on the opposite pole. Because of insulation, there is a max. allowed potential shift defined for the DC output poles, which depends on the device model. Refer to „1.8.3. Specific technical data“.

2.3.6 Connection of remote sensing



- Remote sensing is only effective during constant voltage operation (CV) and for other regulation modes the sense input should be disconnected, if possible, because connecting it generally increases the oscillation tendency.
- The cross section of the sensing cables is noncritical. Recommendation for cables up to 5 m: use at least 0.5 mm²
- Sensing cables should be laid close to the DC cables to damp oscillation. If necessary, an additional capacitor can be installed at the load to eliminate oscillation
- Sensing cables must be connected + to + and - to - at the load, otherwise the sense input of the device can be damaged. For an example see *Figure 6* below.

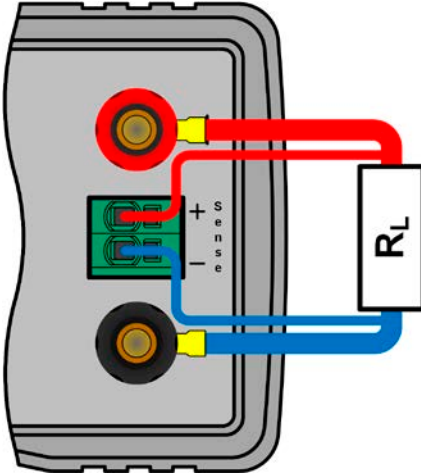

Figure 6 - Example for remote sensing wiring

The connector Sense is a clamp terminal. It means for the remote sensing cables:

- Insert cables: crimp sleeves onto the cable ends and simply push them into the bigger square hole
- Remove cables: use a small flat screwdriver and push into the smaller square hole next to the bigger one to loosen the cable clamp, then remove cable end

2.3.7 Connecting the analog interface

An analog interface in form of a pluggable interface card is optionally available, can be retrofitted by the user on location into the rear side located slot and offers a 15 pole D-Sub connector. To connect it to a control hardware (PC, PLC, electronic circuit), a standard D-Sub plug is required (not included with the interface). It's generally advisable to switch the device completely off before connecting or disconnecting this connector, but at least the DC output.

2.3.8 Connecting the USB port

A USB interface in form of a pluggable interface card is optionally available and can be retrofitted by the user on location into the rear side located slot. Depending on the type of the card it only offers the USB port or also has an extra port (LAN or analog).

In order to remotely control the device via this port, connect the device with a PC using the included USB cable and switch the device on.

2.3.8.1 Driver installation (Windows)

On the initial connection with a PC the operating system will identify the device as new hardware and will try to install a driver. The required driver is for a Communication Device Class (CDC) device and is usually integrated in current operating systems such as Windows 7 or 10. But it's strongly recommended to use the included driver installer (on USB stick) to gain maximum compatibility of the device to our softwares.

2.3.8.2 Driver installation (Linux, MacOS)

We can't provide drivers or installation instructions for these operating systems. Whether a suitable driver is available is best found out by searching the Internet. With newer versions of Linux or MacOS, a generic CDC driver should be "on board".

2.3.8.3 Alternative drivers

In case the CDC drivers described above are not available on your system, or for some reason do not function correctly, commercial suppliers can help. Search the Internet for suppliers using the keywords "cdc driver windows" or "cdc driver linux" or "cdc driver macos".

2.3.9 Connecting the LAN port

An Ethernet/LAN interface in form of a pluggable interface card is optionally available and can be retrofitted by the user on location into the rear side located slot.

Connection to a remote host of any type (switch, server, PC) is done with standard Cat 5 Ethernet cables (patch cable, not included with the interface card). There are several parameters to set up proper network connection. Refer to section 3.4.3 for more information.

2.3.10 Initial commission

For the first start-up after purchasing and installing the device, the following procedures have to be executed:

- Confirm that the connection cables to be used are of a satisfactory cross section!
- Check if the factory settings of set values, safety and monitoring functions and communication are suitable for your intended application of the device and adjust them if required, as described in the manual!
- In case of remote control via PC, read the additional documentation for interfaces and software!
- In case of remote control via the analog interface, read the section in this manual concerning analog interfaces!

During every start the device show a language selection screen for a few seconds where you can quickly switch the display language. This can also be done later, via the MENU:

2.3.11 Commission after a firmware update or a long period of non use

In case of a firmware update, return of the equipment following repair or a location or configuration change, similar measures should be taken to those of initial start up. Refer to „2.3.10. *Initial commission*“.

Only after successful checking of the device as listed may it be operated as usual.

3. Operation and application

3.1 Personal safety



- In order to guarantee safety when using the device, it's essential that only persons operate the device who are fully acquainted and trained in the required safety measures to be taken when working with dangerous electrical voltages
- For models which generate dangerous voltages, a protection against unwanted physical contact has to be installed on the DC output
- Whenever the load and DC output are being re-configured, the device should be switched off completely, not only the DC output!

3.2 Operating modes

A power supply is internally controlled by different control circuits, which shall regulate voltage, current and power to the adjusted values and hold them constant, if possible. These circuits follow typical laws of control systems engineering, resulting in different operating modes. Each operating mode has its own characteristics which are explained below in short form.



- *Unloaded operation while the DC output is switched on isn't considered as a normal operation mode and can thus lead to false measurements*
- *The optimal working point of the device is between 50% and 100% voltage and current*
- *It's recommended to not run the device below 10% voltage and current, in order to make sure technical values like ripple and transient times can be met*

3.2.1 Voltage regulation / Constant voltage

Voltage regulation is also called constant voltage operation, short CV.

The DC output voltage of a power supply is held constant on the adjusted value, unless the output current or the output power according to $P = U_{OUT} * I_{OUT}$ reaches the adjusted current or power limit. In both cases the device will automatically change to constant current or constant power operation, whatever occurs first. Then the output voltage can't be held constant anymore and will sink to a value resulting from Ohm's law.

While the DC output is switched on and constant voltage mode is active, then the condition 'CV mode active' will be indicated on the display by the abbreviation **CV** and this message will be passed as a signal to the optional analog interface, as well stored as status which can also be read as a status message via the optional digital interfaces.

3.2.1.1 Transient time after load step

For constant voltage mode (CV), the technical date "Settling time after load step" (see 1.8.3) defines a time that is required by the internal voltage regulator of the device to settle the output voltage after a load step. Negative load steps, i.e. high load to lower load, will cause the output voltage to overshoot for a short time until compensated by the voltage regulator. The same occurs with a positive load step, i.e. low load to high load. There the output collapses for a moment. The amplitude of the overshoot resp. collapse depends on the device model, the currently adjusted output voltage and the capacity on the DC output and can thus not be stated with a specific value.

Depictions:

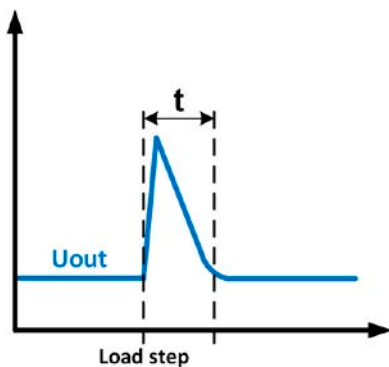

Example for neg. load step: the DC output will rise above the adjusted value for a short time. t = transient time to settle the output voltage.

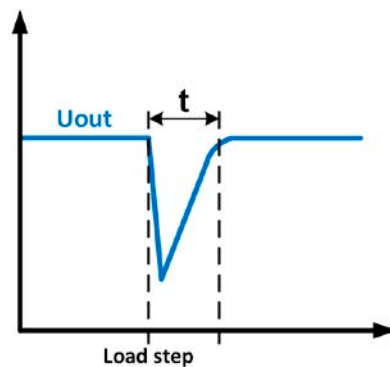

Example for pos. load step: the DC output will collapse below the adjusted value for a short time. t = transient time to settle the output voltage.

3.2.2 Current regulation / constant current / current limitation

Current regulation is also known as current limiting or constant current mode (CC).

The DC output current is held constant by the power supply, once the output current to the load reaches the adjusted limit. Then the power supply automatically switches. The current flowing from the power supply is determined by the output voltage and the load's true resistance. As long as the output current is lower than the adjusted current limit, the device will be either in constant voltage or constant power mode. If, however, the power consumption reaches the set maximum power value, the device will switch automatically to power limiting and sets the output current according to $I_{MAX} = P_{SET} / U_{IN}$, even if the maximum current value is higher. The current set value, as determined by the user, is always an upper limit only.

While the DC output is switched on and constant current mode is active, then the condition 'CC mode active' will be indicated on the display by the abbreviation **CC** and this message will be passed as a signal to the optional analog interface, as well stored as status which can also be read as a status message via the optional digital interfaces.

3.2.2.1 Voltage overshootings

In certain situations it's possible that the device generates a voltage overshooting. Such situations are when the device is in CC, with the actual voltage being unregulated, and either a jump in the current set value is initiated which would bring the device out of CC or when the load is suddenly cut from the power supply by an external means. Peak and duration of the overshooting aren't exactly defined, but as rule of thumb it shouldn't exceed a peak of 1-2% of the rated voltage (on top of the voltage setting) while the duration mainly depends on the charging state of the capacities on the DC output and also the capacity value.

3.2.3 Power regulation / constant power / power limitation

Power regulation, also known as power limiting or constant power (CP), keeps the DC output power of a power supply constant if the current flowing to the load in relation to the output voltage and the resistance of load reaches the adjusted value according to $P = U * I$ resp. $P = U^2 / R$. The power limiting then regulates the output current according to $I = \sqrt{P / R}$, where R is the load's resistance.

Power limiting operates according to the auto-range principle such that at lower output voltages higher current flows and vice versa in order to maintain constant power within the range P_N (see diagram to the right).

While the DC output is switched on and constant power mode is active, then the condition 'CP mode active' will be shown on the display by the abbreviation **CP**, as well stored as status which can also be read as a status message via the optional digital interfaces.

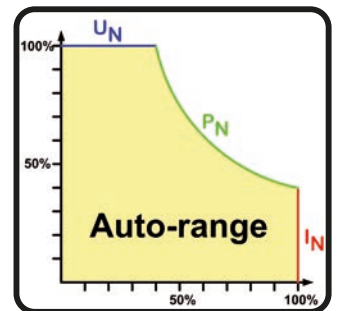

3.3 Alarm conditions



This section only gives an overview about device alarms. What to do in case your device indicates an alarm condition is described in section „3.6. Alarms and monitoring“.

As a basic principle, all alarm conditions are signalled optically (text + message in the display) and acoustically (if activated), as well status and alarm counter readable via an optional, digital interface. In addition, the alarms OT, PF and OVP are reported as signals on the optional, analogue interface. For later acquisition, the alarm counter can also be shown on display.

3.3.1 Power Fail

Power Fail (PF) indicates an alarm condition which may have various causes:

- AC input voltage too low (mains undervoltage, mains failure)
- Defect in the input circuit (PFC)

As soon as a power fail occurs, the device will stop to supply power and switch off the DC output. In case the power fail was an undervoltage and is gone later on, the alarm will vanish from display and doesn't require to be acknowledged. The condition of the DC output after a gone PF alarm can be determined in the MENU. See 3.4.3.



The device can't distinguish between intended (power switch) and unintended (blackout) disconnection from AC and thus will also signalise a PF alarm every time the device is switched off. It has to be ignored in this moment.

3.3.2 Overtemperature

An overtemperature alarm (OT) can occur from an excess temperature inside the device and causes it to stop supplying power temporarily. This can occur due to a defect of the internal fan regulation or due to excessive ambient temperature.

After cooling down, the device will automatically continue to work, while the condition of the DC output remains and the alarm doesn't require to be acknowledged.

3.3.3 Overvoltage

An overvoltage alarm (OVP) will switch off the DC output and can occur if

- the power supply itself, as a voltage source, generates an output voltage higher than set for the overvoltage alarm threshold (OVP, 0...110% U_{Nom}) or the connected load somehow returns voltage higher than set for the overvoltage alarm limit.
- the OV threshold has been adjusted too close above the output voltage. If the device is in CC mode and if it then experiences a negative load step, it will make the voltage rise quickly, resulting in a voltage overshoot for a short moment which can already trigger the OVP.

This function serves to warn the user of the power supply acoustically or optically that the device probably has generated an excessive voltage which could damage the connected load application.



- The device isn't fitted with protection from external overvoltage
- The changeover from operation mode CC -> CV can generate voltage overshoots

3.3.4 Overcurrent protection

An overcurrent alarm (OCP) will switch off the DC output and can occur if

- the output current in the DC output exceeds the adjusted OCP limit.

This function serves to protect the connected load application so that this isn't overloaded and possibly damaged due to an excessive current.

3.3.5 Overpower protection

An overpower alarm (OPP) will switch off the DC output and can occur if

- the product of the output voltage and output current in the DC output exceeds the adjusted OPP limit.

This function serves to protect the connected load application so that this isn't overloaded and possibly damaged due to an excessive power consumption.

3.4 Manual operation

3.4.1 Powering the device

The device should, as far as possible, always be switched on using the toggle switch on the front of the device. After switching on, the display will first show the company logo, followed by a language selection which will close automatically after 3 seconds and later manufacturer's name and address, device type, firmware version(s), serial number and item number.

In setup (see section „3.4.3. Configuration via the Menu“), in the second level menu **General settings** is an option **DC output after power ON** in which the user can determine the condition of the DC output after power-up. Factory setting here is **OFF**, meaning that the DC output will always be switched off on power-up, while **Restore** means that the last condition of the DC output will be restored, either on or off. All set values are also restored.



For the time of the start phase the analog interface can signal undefined statuses on the output pins such as ERROR or OVP. Those signals must be ignored until the device has finished booting and is ready to work.

3.4.2 Switching the device off

On switch-off, the last output condition and the most recent set values and output status are saved. Furthermore, a PF alarm (power failure) will be reported, but has to be ignored here.

The DC output is immediately switched off and after a short while fans the device will be completely powered off.

3.4.3 Configuration via the Menu

The Menu serves to configure all operating parameters which are not constantly required. These can be set by pressing button Menu, but only if the DC output is **switched off**. See figures below.

In case the DC output is switched on the settings menu will not be shown, only status information.

Menu navigation is by using the arrow buttons, as well as Enter and ESC. Values and parameters are set using the rotary knobs. The assignment of the knobs to the adjustable values isn't indicated in menu pages, but following applies:

- Values on the left side of the screen -> left-hand knob
- value on the right side of the screen -> right-hand knob.
- multiple values on any side -> switching to the next is done with the arrow buttons



3.4.3.1 Menu “Settings”

This is main menu for all settings related to the general operation of the device and of the interface(s).

Sub menu	Description
Output Settings	Allows for adjustment of set values related to the DC output, alternatively to the handling in the main screen of the display
Protection Settings	Allows for adjustment of protection thresholds (here: OVP, OCP, OPP) related to the DC output. Also see section „3.3. Alarm conditions“
Limit Settings	Allows for adjustment of adjustment limits for set values. Also see section „3.4.4. Adjustment limits“
General Settings	Settings for the operation of the device and its interface(s). Details below
Reset Device	When selecting Yes and confirming with Enter button, it will initiate a reset of all settings (HMI, profile etc.) to factory default

3.4.3.2 Menu “General Settings”

Some parameters are related to the optional interfaces and are thus only displayed if the corresponding one is installed.

Setting	Description
Allow remote control	Selection No means that the device can't be remotely controlled over either the digital or analog interfaces. If remote control isn't allowed, the status will be shown as Local in the status area on the main display. Also see section 1.9.5.1.
DC output after power ON	Determines the condition of the DC output after power-up. <ul style="list-style-type: none"> • OFF = DC output is always off after switching on the device. • Restore = DC output condition will be restored to the condition prior to switch off.
DC output after PF alarm	Determines how the DC output shall react after a power fail (PF) alarm has occurred: <ul style="list-style-type: none"> • OFF = DC output will be switched off and remain until user action • AUTO = DC output will switch on again after the PF alarm cause is gone and if it was switched on before the alarm occurred
DC output after remote	Determines the condition of the DC output after leaving remote control either manually or by command. <ul style="list-style-type: none"> • OFF = DC output will be always off when switching from remote to manual • AUTO = DC output will keep the last condition
Analog Rem-SB action	Selects the action on the DC output that is initiated when changing the level of analog input “Rem-SB”: <ul style="list-style-type: none"> • DC OFF = the pin can only be used to switch the DC output off • DC ON/OFF = the pin can be used to switch the DC output off and on again, if it has been switched on before at least from a different control location
Analog interface range	Selects the voltage range for the analog set values, monitoring outputs and reference voltage output. <ul style="list-style-type: none"> • 0...5 V = Range is 0...100% set /actual values, reference voltage 5 V • 0...10 V = Range is 0...100% set /actual values, reference voltage 10 V See also section „3.5.4. Remote control via the analog interface (AI)“
Analog interface Rem-SB	Selects how the input pin “Rem-SB” of the analog interface shall be working regarding levels and logic. Also see „3.5.4.7. Application examples“. <ul style="list-style-type: none"> • Normal = Levels and function as described in the table in 3.5.4.4 • Inverted = Levels and function will be inverted

3.4.3.3 Menu “Profiles”

See „3.8 Loading and saving a user profile“ on page 46.

3.4.3.4 Menu “Overview”

This menu page displays an overview of the set values (U, I, P or U, I, P, R) and alarm settings as well as adjustment limits. These can only be displayed, not changed.

3.4.3.5 Menu “About HW, SW...”

This menu page displays an overview of device relevant data such as serial number, article number etc., as well as an alarm history which lists the number of device alarms that probably occurred since the device has been powered.

3.4.3.6 Menu “Communication”

All settings for the optional, digital interface which can be installed on the rear side, are configured here. The USB port, as included with all three optional interface cards, doesn't require configuration. When installing interface type IF-KE5 USB/LAN the device will have an Ethernet/LAN port. After installation or a complete device reset, that Ethernet port has following default settings assigned:

- DHCP: off
- IP: 192.168.0.2
- Subnet mask: 255.255.255.0
- Gateway: 192.168.0.1
- Port: 5025
- DNS: 0.0.0.0
- Host name: “Client”, but configurable via PC software
- Domain: “Workgroup”, but configurable via PC software

Those settings can be changed anytime and configured to meet local requirements. Furthermore, there are global communication settings available regarding timing and protocols.

Sub menu IP Settings 1

Element	Description
Get IP address	DHCP: With setting DHCP the device will instantly try to get network parameters (IP, subnet mask, gateway, DNS) assigned from a DHCP server after power-on or when changing from Manual to DHCP and submitting the change with button Enter. If the DHCP configuration attempt fails, the device will use the settings from Manual . In this case, the overview in screen View Settings will indicate the DCHP status as DHCP (failed) , otherwise as DHCP(active) Manual (default setting): uses either the default network parameters (after reset) or the last user setting. Those parameters are not overwritten from selection DHCP and are thus available when switching to Manual again.
IP address	Only available with setting Manual . Default value: see above Manual setting of the device's IP address in standard IP format (setting will be stored)
Subnet mask	Only available with setting Manual . Default value: see above Manual setting of the subnet mask in standard IP format (setting will be stored)
Gateway	Only available with setting Manual . Default value: see above Manual setting of the gateway address in standard IP format (setting will be stored)

Sub menu IP Settings 2

Element	Description
Port	Default value: 5025 Adjust the socket port here, which belongs to the IP address and serves for TCP/P access when controlling the device remotely via Ethernet
DNS address	Default value: 0.0.0.0 Permanent manual setting of the network address of a domain name server (short: DNS) which has to be present in order to translate the host name to the device's IP, so the device could alternatively access by the host name
Enable TCP Keep-Alive	Default setting: No Enables/disables the “keep-alive time” functionality of TCP.

Sub menu **Communication Protocols**

Element	Description
Enabled	Default setting: SCPI&ModBus Enables/disables SCPI or ModBus RTU communication protocols for the device. The change is immediately effective after submitting it with Enter button. Only one of both can be disabled.
ModBus specification compliance	Allows to switch from Limited (default setting) to Full which makes the device send messages in ModBus RTU format which fully comply to the specification and are compatible to softwares available on the market. With Limited the device would still use the old, partially wrong message format (see programming guide for details).

Sub menu **Communication Timeout**

Element	Description
Timeout USB (ms)	Default value: 5 , Range: 5...65535 USB/RS232 communication timeout in milliseconds. Defines the max. time between two subsequent bytes or blocks of a transferred message. For more information about the timeout refer to the external programming documentation "Programming guide ModBus & SCPI".
Timeout ETH (s)	Default value: 5 , Range: 5...65535 Defines a timeout after which the device would close the socket connection if there was no command communication between the controlling unit (PC, PLC etc.) and the device for the adjusted time. The timeout is ineffective as long as option Enable TCP Keep-alive (see above) is switched on.
Enable interface monitoring	Default setting: deactivated Interface monitoring is a safety feature which, when activated, supervises the communication via any digital interface and also the physical connection line. For details refer to „3.5.3.4. <i>Interface monitoring</i> “.
Timeout interface monitoring[s]	Default setting: 10 , Range: 1... 36000 User adjustable time-out in seconds for the interface monitoring feature. Can only be varied while interface monitoring is activated. Also see above at Enable interface monitoring .

3.4.3.7 Menu "HMI Setup"

These settings refer exclusively to the control panel (HMI).

Element	Description
Language	Selection of the display language between German, English, Russian or Chinese. Default setting: English
Backlight Setup	The choice here is whether the backlight remains permanently on or if it should be switched off when no input via push buttons or rotary knob is done for 60 s. As soon as input is done, the backlight returns automatically. Furthermore the backlight intensity can be adjusted here. Default settings: 100, Always on
Status page	Switches to a different main screen layout. The user can select between two layouts which are depicted by small graphics as a preview. Also see section „3.4.6. <i>Switching the main screen view</i> “. Default setting: Layout 1
Key Sound	Activates or deactivates sounds when pressing a button on the HMI. It can usefully signal that the action has been accepted. Default setting: off
Alarm Sound	Activates or deactivates the additional acoustic signal of an alarm. See also „3.6 <i>Alarms and monitoring</i> “ on page 44. Default setting: off
HMI Lock	See „3.7 <i>Control panel (HMI) lock</i> “ on page 45. Default settings: Lock all, No

3.4.4 Adjustment limits



Adjustment limits are only effective on the related set values, no matter if using manual adjustment or remote control!

Defaults are, that all set values (U, I, P) are adjustable from 0 to 102%.





This can be helpful when wanting to protect sensitive applications against overvoltage caused by unintentionally adjusting a wrong voltage set value. Therefore upper and lower limits for current (I) and voltage (U) can be set which limit the range of the adjustable set values. For power (P) only an upper value limit is adjustable.

Limit Settings			
U-min=	00.00V	U-max=	80.00V
I-min=	00.00A	I-max=	20.00A
P-max=	400.0W		



The adjustment limits are coupled to the set values. It means, that the upper limit may not be lower than the corresponding set value. Example: If you wish to set the upper limit for the current (I-max) to 35 A while the set value of current is adjusted to 40 A, then the set value of current would first have to be reduced to 35 A or less in order to enable setting I-max down to 35 A.

► How to configure the adjustment limits

1. While the DC output is switched off, press button .
2. In the menu press , then navigate to **Limit Settings** with the arrow buttons (↓, ↑) and press  again.
3. In each case a pair of upper and lower limits for U/I or the upper limit for P are assigned to the rotary knobs and can be adjusted. In order to switch to a different pair/value, press any of the arrow buttons.
4. Accept the settings with .

3.4.5 Manual adjustment of set values

The set values for voltage, current and power are the fundamental operating possibilities of a power supply and hence the two rotary knobs on the front of the device are always assigned to two of the four values in manual operation. Default assignment is voltage and current. On the front control panel, set values can only be adjusted with the rotary knobs.



Using the knobs to adjust a value in the main screen changes it immediately and no matter if the DC output is switched on or off. This is different to set value adjustment in the menu, where you have to press the "Enter" button to submit changes.



When adjusting the set values, upper or lower limits may come into effect. See section „3.4.4. Adjustment limits“. Once a limit's reached, the main screen will show a note like "Limit: U-max" etc. for 1.5 seconds in the status area, while in the menu this is reduced to an exclamation mark.

► How to adjust values with the rotary knobs

1. First check if the value you want to change is already assigned to one of the rotary knobs. The main screen displays the assignment like this:

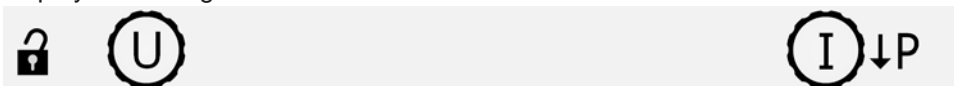

2. If, as shown above, the assignment is voltage (U, left) and current (I, right) and it's required to set the power, the assignment of the right-hand knob can be changed by pressing the arrow down button (↓).
3. After successful selection, the desired value can be set within the defined limits. Selecting a digit's done by pushing the rotary knob which shifts the cursor from right to left (selected digit will be underlined):



3.4.6 Switching the main screen view

The main screen, also called status page with its set values, actual values and device status, can be switched from the standard view mode with three values to a simpler mode. Refer to „3.4.3.7. Menu “HMI Setup”“ to see where to switch the view mode in the MENU. Comparison:

Layout 1 (standard)



Layout 2 (alternative)



Differences of layout 2 compare to layout 1:

- The hidden physical value is shown when switching the knob assignment, which also changes the upper right half of the display
- The actual regulation mode is displayed no matter what pair of physical values is currently shown, as the example in the upper figure on the right side depicts with **CP**



3.4.7 Switching the DC output on or off

The DC output of the device can be manually or remotely switched on and off. This can be restricted in manual operation by the control panel being locked.

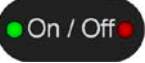

Switching the DC output on during manual operation or digital remote control could also be inhibited by pin REM-SB of the optional analog interface, if installed. Depending on the setting of parameter “Analog interface Rem-SB” this could even occur when no analog interface pin is wired. For more information refer to 3.4.3.2 and example a) in 3.5.4.7. In such a situation, the device would show a notification in the display.

► How to manually switch the DC output on or off

1. As long as the control panel (HMI) isn't fully locked press the button . Otherwise you are asked to disable the HMI lock, either by simply pressing  or entering the PIN, if the PIN has been activated in menu **HMI Lock**.
2. The ON/OFF button toggles between on and off, as long as a change isn't restricted by any alarm or the device being in **Remote**. The DC output condition is indicated by the two LEDs (green = on, red = off) on the  button.

► How to remotely switch the DC output on or off via the analog interface

1. See section „3.5.4 Remote control via the analog interface (AI)“ on page 40.

► How to remotely switch the DC output on or off via the digital interface

1. See the external documentation “Programming Guide ModBus & SCPI” if you are using custom software, or refer to the external documentation of LabView VIs or other documentation provided by EA Elektro-Automatik.

3.5 Remote control

3.5.1 General

Remote control is possible via any of the optionally available, user-retrofittable interface cards (refer to „1.9.4. *Optional accessories*“) and their feature analog or digital interface port. Important here is that only one of both ports can be in control. It means that if, for example, an attempt were to be made to switch to remote control via the digital interface whilst analog remote control is active (pin REMOTE = LOW) the device would report an error via the digital interface. In the opposite direction, a switch-over via pin REMOTE would be ignored. In both cases, however, status monitoring and reading of values are always possible.

3.5.2 Controls locations

Control locations are those locations from where the device is control. Essentially there are two: at the device (manual control) and external (remote control). The following locations are defined:

Displayed location	Description
-	If neither of the other locations is displayed then manual control is active and access from the analog and digital interfaces is allowed. This location isn't explicitly displayed
Remote:	Remote control via any interface is active
Local	Remote control is locked, only manual operation is allowed.

Remote control can be explicitly allowed or inhibited using the setting **Allow remote control** (see „3.4.3.2. *Menu "General Settings"*“). In inhibited condition, the status **Local** will be shown in the status area of the display. Activating the lock can be useful if the device is remotely controlled by software or some electronic device, but it's required to make adjustments at the device or deal with emergency situations, which would not be possible remotely.

Activating condition **Local** causes the following:

- If remote control via the digital interface is active (shown as **Remote:**), then it's immediately terminated and in order to continue remote control once **Local** is no longer active, it has to be reactivated from the PC side
- If remote control via the analog interface is active (**Remote: Analog**), then it's temporarily interrupted until remote control is allowed again by deactivating **Local**, because pin REMOTE continues to signal "remote control = on", unless the signal has been changed during the **Local** period.

3.5.3 Remote control via a digital interface

3.5.3.1 Selecting an interface

The device only supports the optionally available, digital interfaces USB and Ethernet.

For USB, a standard USB cable is included in the delivery of the interface card, not with the device, as well as a driver for Windows on USB stick. The USB interface requires no setup in the MENU.

The Ethernet interface typically requires network setup (manual or DHCP), but can also be used with its default parameters right from the start.

3.5.3.2 General

For the network port installation refer to „1.9.7. *Ethernet port (optional)*“.

The digital interface require little or no setup for operation and can be directly used with their default configuration. All specific settings will be permanently stored, but could also be reset to defaults with the setup menu item **Reset Device**.

Via the digital interface primarily the set values (voltage, current, power) and device conditions can be set and monitored. Furthermore, various other functions are supported as described in separate programming documentation.

Changing to remote control will retain the last set values for the device until these are changed. Thus a simple voltage control by setting a target value is possible without changing any other values.

3.5.3.3 Programming

Programming details for the interfaces, the communication protocols etc. are to be found in the documentation "Programming Guide ModBus & SCPI" which is supplied on the included USB stick or which is available as download from the EA Elektro-Automatik website.

3.5.3.4 Interface monitoring

Interface monitoring is a configurable functionality introduced in firmwares KE 2.04 and HMI 2.03. Its goal is to monitor (or supervise) the communication line between the device and a superior control unit, such as PC or PLC, and to ensure that the device wouldn't continue working uncontrolled in case the communication line fails. A failing line can mean that it's either physically interrupted (damaged cable, bad contact, cable pulled) or the interface port inside the device hangs.

The monitoring is always only valid for one of the digital interfaces, the one being used for remote control. It thus means that the monitoring can become temporarily inactive when the device leaves remote control. It's furthermore based on a user-definable timeout which would run out if not at least one message is sent to the device within the given time frame. After every message, the timeout would start again and reset with the next message coming. In case it runs out, following reaction of the device is defined:

- Exit remote control
- In case the DC output is switched on, either switch the DC output off or leave it on, as defined by the parameter "DC output after remote" (see 3.4.3.1)

Notes for the operation:

- The monitoring can be deactivated or activated anytime via remote control
- The timeout of the monitoring can be changed anytime via remote control; the new value would only be valid after the current timeout has elapsed
- The interface monitoring doesn't deactivate the Ethernet connection timeout (see 3.4.3.6), so these two timeouts can overlap

3.5.4 Remote control via the analog interface (AI)

3.5.4.1 General

The optionally available, once installed built-in, galvanically isolated, 15-pole analog interface (short: AI) is located on the rear side of the device and offers the following possibilities:

- Remote control of current, voltage and power
- Remote status monitoring (CC/CP, CV)
- Remote alarm monitoring (OT, OVP, PF)
- Remote monitoring of actual values
- Remote on/off switching of the DC output

Setting the **three** set values of voltage, current and power via the analog interface always takes place concurrently. It means, that for example the voltage can't be given via the AI and current and power would be set with the rotary knobs, or vice versa.

The OVP set value and other supervision (events) and alarm thresholds can't be set via the AI and therefore must be adapted to the given situation before the AI is taking over. Analog set values can be fed in by an external voltage or by the reference voltage on pin 3. As soon as remote control via the analog interface is activated, the set values on the display will be those provided by the interface.

The AI can be operated in the common voltage ranges 0...5 V and 0...10 V, both representing 0...100% of the nominal value. The selection of the voltage range can be done in the device setup. See section „3.4.3. Configuration via the Menu“ for details. The reference voltage sent out from pin 3 (VREF) will be adapted accordingly:

0-5 V: Reference voltage = 5 V, 0...5 V set value signal for VSEL, CSEL and PSEL correspond to 0...100% nominal value, 0...100% actual values correspond to 0...5 V at the actual value outputs CMON and VMON.

0-10 V: Reference voltage = 10 V, 0...10 V set value signal for VSEL, CSEL and PSEL correspond to 0...100% nominal values, 0...100% actual values correspond to 0...10 V at the actual value outputs CMON and VMON.

All set values are always additionally limited to the corresponding adjustment limits (U-max, I-max etc.), which would clip setting excess values for the DC output. Also see section „3.4.4. Adjustment limits“.

Before you begin, please read these important notes for use of the interface:



After powering the device and during the start phase the AI signals undefined statuses on the output pins such as ERROR or OVP. Those must be ignored until is ready to work.

- Analog remote control of the device must be activated by switching pin "REMOTE" (5) first. Only exception is pin REM-SB, which can be used independently
- Before the hardware is connected that will control the analog interface, it shall be checked that it can't provide voltage to the pins higher than specified
- Set value inputs, such as VSEL, CSEL or PSEL, must not be left unconnected (i.e. floating) during analog remote control. In case any of these isn't used for adjustment, it should be tied to a defined level, for example by bridging it to VREF so it would be set to 100%

3.5.4.2 Resolution

The analog interface is internally sampled and processed by a digital microcontroller. This causes a specific effective resolution, i. e. analog steps. The resolution is the same for set values (VSEL etc.) and actual values (VMON/CMON) and is 4096 when working with the 10 V range. In the 5 V range this resolution halves. Due to tolerances, the truly achievable resolution can be slightly lower.

3.5.4.3 Acknowledging device alarms

In case of a device alarm occurring during remote control via analog interface, the DC output will be switched off the same way as in manual control. The device would indicate all alarms (see 3.6.1) in the front display and some of them also as signal on the analog interface (see table below).

Some device alarms have to be acknowledged, either by the user of the device or by the controlling unit. Also see „3.6.1. Device alarm and event handling“. Acknowledgement is done with pin REM-SB switching the DC output off and on again, means a HIGH-LOW-HIGH edge (at least 50 ms for LOW).

3.5.4.4 Analog interface specification

Pin	Name	Type*	Description	Default levels	Electrical specification
1	VSEL	AI	Set voltage value	0...10 V or. 0...5 V correspond to 0..100% of U_{Nom}	Accuracy 0-5 V range: < 0.4% ***** Accuracy 0-10 V range: < 0.2% *****
2	CSEL	AI	Set current value	0...10 V or. 0...5 V correspond to 0..100% of I_{Nom}	Input impedance R_i >40 k...100 k
3	VREF	AO	Reference voltage	10 V or 5 V	Tolerance < 0.2% at $I_{max} = +5$ mA Short-circuit-proof against AGND
4	DGND	POT	Ground for all digital signals		For control and status signals
5	REMOTE	DI	Switching manual / remote control	Remote = LOW, $U_{Low} < 1$ V Manual = HIGH, $U_{High} > 4$ V Manual, if pin not wired	Voltage range = 0...30 V $I_{Max} = -1$ mA at 5 V $U_{LOW to HIGH typ.} = 3$ V Rec'd sender: Open collector against DGND
6	OT /PF	DO	Overheating alarm Power fail alarm ***	Alarm = HIGH, $U_{High} > 4$ V No Alarm = LOW, $U_{Low} < 1$ V	Quasi open collector with pull-up against V_{cc}^{**} With 5 V on the pin max. flow +1 mA $I_{Max} = -10$ mA at $U_{CE} = 0,3$ V $U_{Max} = 30$ V Short-circuit-proof against DGND
7	-	-	-	-	-
8	PSEL	AI	Set power value	0...10 V or. 0...5 V correspond to 0..100% of P_{Nom}	Accuracy 0-5 V range: < 0.4% ***** Accuracy 0-10 V range: < 0.2% ***** Input impedance R_i >40 k...100 k
9	VMON	AO	Actual voltage	0...10 V or. 0...5 V correspond to 0..100% of U_{Nom}	Accuracy < 0.2% at $I_{Max} = +2$ mA Short-circuit-proof against AGND
10	CMON	AO	Actual current	0...10 V or. 0...5 V correspond to 0..100% of I_{Nom}	
11	AGND	POT	Ground for all analog signals		For -SEL, -MON, VREF signals
12	-	-	-	-	-
13	REM-SB	DI	DC output off (DC output on) (ACK alarms ****)	Off = LOW, $U_{Low} < 1$ V On = HIGH, $U_{High} > 4$ V On, if pin not wired	Voltage range = 0...30 V $I_{Max} = +1$ mA at 5 V Rec'd sender: Open collector against DGND
14	OVP	DO	Overvoltage alarm	Alarm OV = HIGH, $U_{High} > 4$ V No alarm OV = LOW, $U_{Low} < 1$ V	Quasi open collector with pull-up against V_{cc}^{**} With 5 V on the pin max. flow +1 mA
15	CV	DO	Constant voltage regulation active	CV = LOW, $U_{Low} < 1$ V CC/CP = HIGH, $U_{High} > 4$ V	$I_{Max} = -10$ mA at $U_{CE} = 0,3$ V, $U_{Max} = 30$ V Short-circuit-proof against DGND

* AI = Analog Input, AO = Analog Output, DI = Digital Input, DO = Digital Output, POT = Potential

** Internal V_{cc} approx. 10 V

*** AC supply blackout or PFC failure or supply undervoltage

**** Only during remote control

***** The error of a set value input adds to the general error of the related value on the DC output of the device

3.5.4.5 Overview of the Sub-D Socket

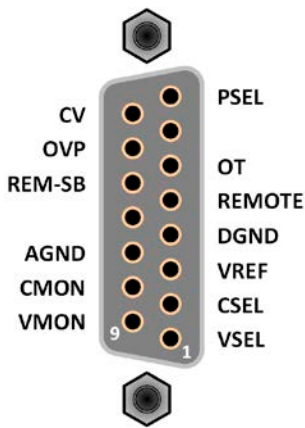

3.5.4.6 Simplified diagram of the pins

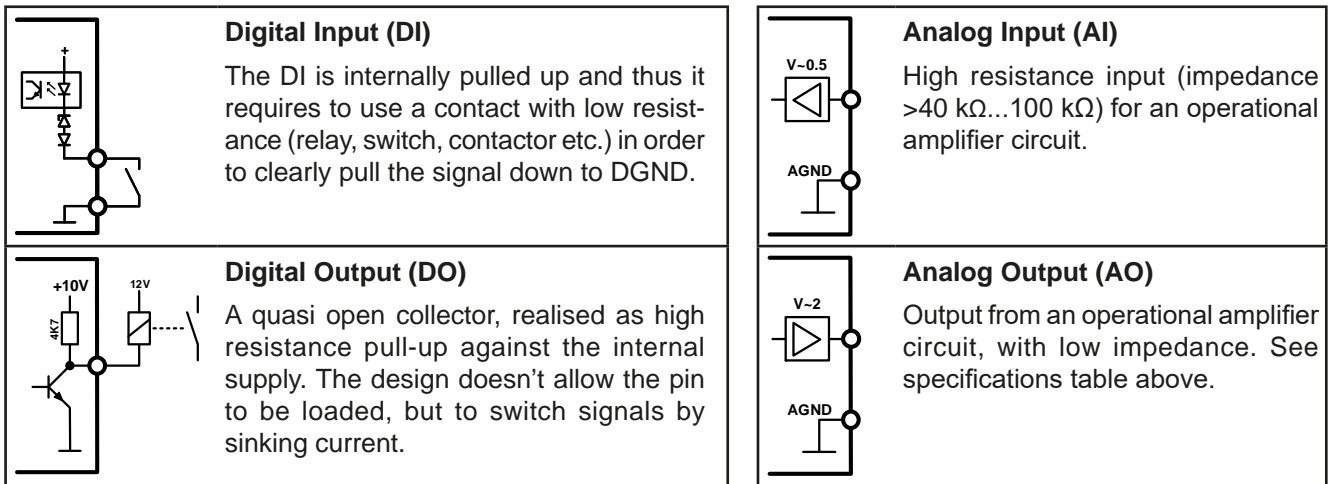

3.5.4.7 Application examples

a) Switching the DC output off or on via the pin REM-SB

A digital output, e.g. from a PLC, may be unable to cleanly effect this as it may not be of low enough resistance. Check the specification of the controlling application. Also see pin diagrams above.

In remote control, pin REM-SB is used to switch the DC output of the device on and off. This is also available without remote control being active. It's recommended that a low resistance contact such as a switch, relay or transistor is used to switch the pin to ground (DGND).

Following situations can occur:

- **Remote control has been activated**

During remote control via analog interface, only pin REM-SB determines the states of the DC output, according to the levels definitions in 3.5.4.4. The logical function and the default levels can be inverted by a parameter in the setup menu of the device. See 3.4.3.2.

If the pin is unconnected or the connected contact is open, the pin will be HIGH. With parameter "Analog interface Rem-SB" being set to "Normal", it requests 'DC output on'. In this situation, when activating remote control, the DC output would instantly switch on.

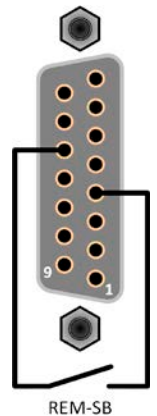

REM-SB

• **Remote control isn't active**

In this mode of operation pin REM-SB can serve as lock, preventing the DC output from being switched on by any means. This results in following possible situations:

DC-output	+	Level on pin REM-SB	+	Parameter „Analog interface Rem-SB“	→	Behaviour
is off	+	HIGH	+	Normal	→	The DC output isn't locked. It can be switched on by pushbutton "On/Off" (front panel) or via command from digital interface.
		LOW	+	Inverted		
	+	HIGH	+	Inverted	→	The DC output is locked. It can't be switched on by pushbutton "On/Off" (front panel) or via command from digital interface. When trying to switch on, a popup in the display resp. an error message will be generated.
		LOW	+	Normal		

In case the DC output is already switched on, toggling the pin will switch the DC output off, similar to what it does in analog remote control:

DC-output	+	Level on pin REM-SB	+	Parameter „Analog interface Rem-SB“	→	Behaviour
is on	+	HIGH	+	Normal	→	The DC output remains on, nothing is locked. It can be switched on or off by pushbutton "On/Off" (front panel) or digital command.
		LOW	+	Inverted		
	+	HIGH	+	Inverted	→	The DC output will be switched off and locked. Later it can be switched on again by toggling the pin. During lock, pushbutton "On/Off" (front panel) or digital command can delete the request to switch on by pin.
		LOW	+	Normal		

b) Remote control of current and power.

Requires remote control to be activated (pin REMOTE = LOW)

The set values PSEL and CSEL are generated from, for example, the reference voltage VREF, using potentiometers for each. Hence the electronic load can selectively work in current limiting or power limiting mode. According to the specification of max. 5 mA load for the VREF output, potentiometers of at least 10 kΩ must be used.

The voltage set value VSEL is directly connected to AGND (ground) and therefore has no influence on constant current or power operation.

If the control voltage is fed in from an external source it's necessary to consider the input voltage ranges for set values (0...5 V or 0...10 V).



Use of the input voltage range 0...5 V for 0...100% set value halves the effective resolution.

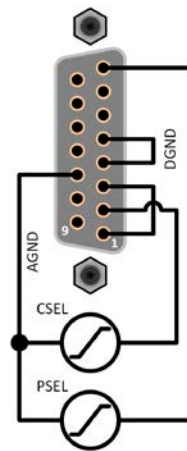

Example with external voltage source

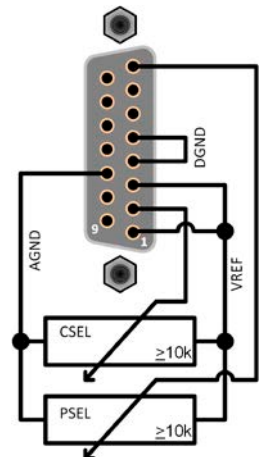

Example with potentiometers

c) Reading actual values

The AI provides the DC output values as current and voltage monitor. These can be read using a standard multimeter or similar.

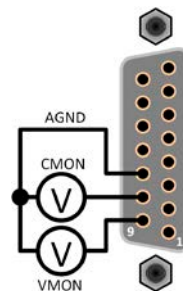

3.6 Alarms and monitoring

3.6.1 Device alarm and event handling

A device alarm incident will usually lead to DC output switch-off, the appearance of a text message in the display and, if activated, an acoustic signal to make the user aware. The alarm must always be acknowledged. If the alarm condition no longer exists, e.g. the device has cooled down following overheating, the alarm indication may have disappeared already. If the condition persists, the display remains and the alarm can only be acknowledged after elimination of the cause.

Alarm: OVP

► How to acknowledge an alarm in the display (during manual control)

1. Once an alarm is indicated, the user can try to acknowledge and delete the alarm by pressing either button



In order to acknowledge an alarm during analog remote control, see „3.5.4.3. Acknowledging device alarms“. To acknowledge in digital remote control, refer to the external documentation “Programming guide ModBus & SCPI”.



Some device alarms are configurable:

Alarm	Meaning	Description	Range	Indication
OVP	OverVoltage Protection	Triggers an alarm if the DC output voltage reaches the defined threshold. The DC output will be switched off..	0 V...1.03*U _{Nom}	Display, analog & digital interface
OCP	OverCurrent Protection	Triggers an alarm if the DC output current reaches the defined threshold. The DC output will be switched off..	0 A....1.1*I _{Nom}	Display, digital interface
OPP	OverPower Protection	Triggers an alarm if the DC output power reaches the defined threshold, The DC output will be switched off..	0 W...1.1*P _{Nom}	Display, digital interface

These device alarms can't be configured and are based on hardware:





Alarm	Meaning	Description	Indication
PF	Power Fail	AC supply over- or undervoltage. Triggers an alarm if the AC supply is out of specification or when the device is cut from supply, for example when switching it off with the power switch. The DC output will be switched off. The condition of the DC output after a temporary power fail alarm can be defined by parameter DC output after PF alarm .	Display, analog & digital interface
OT	OverTemperature	Triggers an alarm if the internal temperature exceeds a certain limit. The DC output will be switched off.	

► How to configure the device alarms

2. While the DC output is switched off, press button .
3. In the menu press , then navigate to **Protection Settings** with the arrow buttons (↓, ↑) and press  again.
4. Set the thresholds for the device alarms (OVP, OCP, OPP) relevant to your application if the default value of 110% is unsuitable.

The user also has the possibility of selecting whether an additional acoustic signal will be sounded if an alarm or user defined event occurs.







► **How to configure the alarm sound** (also see “3.4.3. Configuration via the Menu”)

1. While the DC output is switched off, press button .
2. In the menu navigate with the arrow buttons (↓, ↑) to **Page 2** and press . In the following menu page, navigate to **HMI Setup** and press  again.
3. There navigate to **Alarm Sound** and reach the settings page by pressing  once more.
4. In the settings page select **On** or **Off** and confirm with .

3.7 Control panel (HMI) lock

In order to avoid the accidental alteration of a value during manual operation, the rotary knobs can be locked so that no alteration of values will be accepted without prior unlocking.

► **How to lock the HMI**





1. While the DC output is switched off, press button .
2. In the menu navigate with the arrow buttons (↓, ↑) to **Page 2** and press . In the following menu page, navigate to **HMI Setup** and press .
3. In there navigate to **HMI Lock** to access the settings page with .
4. The simple (default) HMI lock is activated by pressing  here, which will immediately leave the menu and jump back to the main screen. The active lock is indicated by text **Locked** and symbol .

Alternatively to the simple lock, which can be unlocked very easily by every person and thus offers no protection against intentional misuse, a PIN can set up and activated, which then is requested to be entered every time the HMI is going to be unlocked.

► **How to lock the HMI with PIN**



Don't activate the PIN lock if you are unsure about the current PIN! It can be changed, but only if the current PIN is entered.

1. Select parameter to **Enable PIN** and set the parameter to **Yes** with the right-hand knob.
2. In order to change the PIN prior to activation select **Change PIN** and press  to access the next screen where you are requested to enter the former PIN 1x and the new PIN 2x and confirm every step with .
3. Back in the previous activate the PIN lock with , which will immediately leave the menu and jump back to the main screen. The active lock is indicated by text **Locked** and symbol .

If an attempt is made to alter something whilst the HMI is locked, a requester appears in the display asking if the lock should be disabled.

► **How to unlock the HMI**

1. Turn one of the rotary knobs or press any button (except for “On/Off” when lock mode **ON/OFF possible** has been set).

2. This request pop-up will appear:

HMI locked!
Press „Enter“ to unlock.

3. Unlock the HMI by pressing  within 5 seconds, otherwise the pop-up will disappear and the HMI remains locked. In case the additional PIN code lock has been activated in the menu **HMI Lock**, another requester will pop up, asking you to enter the PIN before it finally unlocks the HMI.





3.8 Loading and saving a user profile

The menu **Profiles** serves to select between a default profile and up to 5 user profiles. A profile is a collection of all settings and set values. Upon delivery, or after a reset, all 6 profiles have the same settings and all set values are 0. If the user changes settings or sets target values then these create a working profile which can be saved to one of the 5 user profiles. These profiles or the default one can then be switched. The default profile is read-only.

The purpose of a profile is to load a set of set values, settings limits and monitoring thresholds quickly without having to readjust these. As all HMI settings are saved in the profile, including language, a profile change can also be accompanied by a change in HMI language.

On calling up the menu page and selecting a profile the most important settings can be seen, but not changed.

► How to save the all values and settings as a user profile

1. While the DC output is switched off, press button .
2. In the menu use the arrow buttons (↓, ↑) to navigate to **Profiles**, then press .
3. In the selection screen select one of the user profiles 1-5 sub menus by using the arrow buttons.
4. In the sub menu you can view, load or save the profile by selecting the corresponding entry and pressing .
5. Select **Save settings in Profile x** and confirm with .



Loading a profile is done the same way.

3.9 Other applications

3.9.1 Series connection

Series connection of two or multiple devices is basically possible, but for reasons of safety and isolation following restrictions apply:



- Both, negative (DC-) and positive (DC+) output poles are coupled to PE via type X capacitors, limiting the max. allowed potential shift (see technical specs for rating) of every device in the series connection
- The remote sensing inputs must not be connected!
- Series connection must only be set up with devices of the same type, i.e. power supply with power supply, and should only use the same model, for instance PS 3080-10 C and PS 3080-10 C

Series connection isn't explicitly supported by additional connections and signals on the devices. Nothing else than output current and voltage is shared. It means, all units have to be controlled separately regarding set values and DC output status, whether it's manual or remote control.

In case the device have optional analog interfaces installed, these analog interface are allowed to be wired in parallel, because they are galvanically isolated from the device and the DC output. The mutual analog ground (AGND) on the analog interfaces can furthermore be connected to PE, if required.

3.9.2 Parallel operation

Multiple devices of same kind and ideally same model can be connected in parallel in order to create a system with higher total current and hence higher power. This can be achieved by connecting all units to the DC load in parallel, so the single currents can add. There is no support for a balancing between the individual units, like in form of a master-slave system. All power supplies would have to be controlled and set up separately. However, it's possible to have a parallel control by the signals on the analog interface, as this one is galvanically isolated from the rest of the device. There are few general points to consider and adhere:

- Always make parallel connections only with device of same voltage, current and power rating
- Never connect DC cables from power supply to power supply, but instead from every power supply device directly to the load, else the total current will exceed the current rating of the DC output clamp or the cables lead different currents and might also be overloaded.

3.9.3 Operation as battery charger

A power supply can be used as a battery charger, but with some restrictions, because it misses a battery supervision and a physical separation from the load in form of a relay or contactor, which is usually featured with true battery chargers as a protection against overvoltage or reversed polarity.

Following has to be considered:

- No false polarity protection inside! Connecting a battery with false polarity will damage the power supply severely, even if it isn't powered.
- All models of this series have resistive base load which is used to discharge the typical output capacities when there is no load or very low load. This base load would, more or less slowly, discharge the battery while the DC output or even the device is switched off, perhaps even until deep discharge condition. It's thus recommended to leave the battery only connected as long as it's charged.

4. Service and maintenance

4.1 Maintenance / cleaning

The device needs no maintenance. Cleaning may be needed for the internal fans, the frequency of cleanse is depending on the ambient conditions. The fans serve to cool the components which are heated by the inherent high dissipation of energy. Heavily dirt filled fans can lead to insufficient airflow and therefore the DC output would switch off too early due to overheating or possibly lead to defects.

Cleaning the internal fans can be performed with a vacuum cleaner or similar. For this the device needs to be opened.

4.2 Fault finding / diagnosis / repair

If the equipment suddenly performs in an unexpected way, which indicates a fault, or it has an obvious defect, this can't and must not be repaired by the user. Contact the supplier in case of suspicion and elicit the steps to be taken.

It will then usually be necessary to return the device to Elektro-Automatik (with or without warranty). If a return for checking or repair is to be carried out, ensure that:

- the supplier has been contacted and it's clarified how and where the equipment should be sent.
- the device is in fully assembled state and in suitable transport packaging, ideally the original packaging.
- a fault description in as much detail as possible is attached.
- if shipping destination is abroad, the necessary customs papers are attached.

4.2.1 Replacing a defect mains fuse

The device is protected by a fusible which is inside a fuse holder on the rear of the device. The fuse rating is printed next to the fuse holder. Replace the fuse only with one of same size and rating.

4.2.2 Firmware updates



Firmware updates should only be installed when they can eliminate existing bugs in the firmware in the device or contain new features.

The firmware of the control panel (HMI), of the communication unit (KE) and the digital controller (DR), if necessary, is updated via the rear side USB port. For this the software **EA Power Control** is needed which is included with the device or available as download from our website together with the firmware update, or upon request.

However, be advised not to install updates promptly. Every update includes the risk of an inoperable device or system. We recommend to install updates only if...

- an imminent problem with your device can directly be solved, especially if we suggested to install an update during a support case
- a new feature has been added which you definitely want to use. In this case, the full responsibility is transferred to you.

Following also applies in connection with firmware updates:

- Simple changes in firmwares can have crucial effects on the application the devices are use in. We thus recommend to study the list of changes in the firmware history very thoroughly.
- Newly implemented features may require an updated documentation (user manual and/or programming guide, as well as LabView VIs), which is often delivered only later, sometimes significantly later

Test Equipment Depot - 800.517.8431 - 5 Commonwealth Ave, MA 01801

TestEquipmentDepot.com