

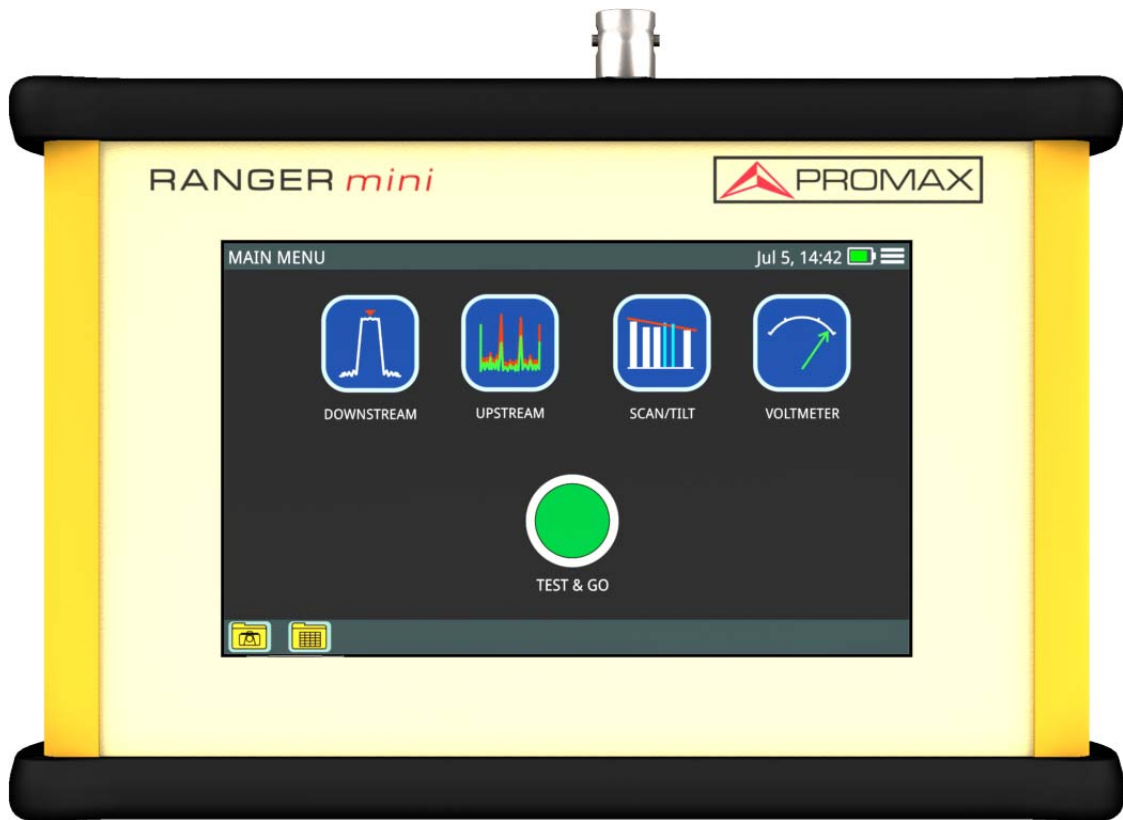



RANGER *mini*

DIGITAL MULTI SYSTEM ANALYZER



SAFETY NOTES

Read the user's manual before using the equipment, mainly "**SAFETY RULES**" paragraph.

The symbol  on the equipment means "**SEE USER'S MANUAL**". In this manual may also appear as a Caution or Warning symbol.

WARNING AND CAUTION statements may appear in this manual to avoid injury hazard or damage to this product or other property.

USER'S MANUAL ELECTRONIC VERSION

You can access instantly to any chapter by clicking on the title of the chapter in the table of contents.

Click on the arrow  at the top right page to return to the table of contents.

USER'S MANUAL VERSION















Manual Version	Date	Firmware Version
F1.0	September 2018	10.0.35

■ Please update your equipment to the latest software version available.

SAFETY RULES

- * The safety could not be assured if the instructions for use are not closely followed.
- * Use this equipment connected only to systems with their negative of measurement connected to ground potential.
- * The AL-103 external DC charger is a Class I equipment, for safety reasons plug it to a supply line with the corresponding ground terminal.
- * This equipment can be used in Overvoltage Category I installations and Pollution Degree 2 environments.
- * External DC charger can be used in Overvoltage Category II, installation and Pollution Degree 1 environments.
- * When using some of the following accessories use only the specified ones to ensure safety:
 - Rechargeable battery
 - External DC charger
 - Power cord
- * Observe all specified ratings both of supply and measurement.
- * Remember that voltages higher than 70 V DC or 33 V AC rms are dangerous.
- * Use this instrument under the specified environmental conditions.
- * When using the power adaptor, the negative of measurement is at ground potential.
- * Do not obstruct the ventilation system of the instrument.
- * Use for the signal inputs/outputs, specially when working with high levels, appropriate low radiation cables.
- * Follow the cleaning instructions described in the Maintenance paragraph.

SAFETY SYMBOLS

	DIRECT CURRENT		ON (Supply)
	ALTERNATING CURRENT		OFF (Supply)
	DIRECT AND ALTERNATING		DOUBLE INSULATION (Class II protection)
	GROUND TERMINAL		CAUTION (Risk of electric shock)
	PROTECTIVE CONDUCTOR		CAUTION REFER TO MANUAL
	FRAME TERMINAL		FUSE
	EQUIPOTENTIALITY		EQUIPMENT OR COMPONENT TO BE RECYCLED

DESCRIPTIVE EXAMPLES OF OVER VOLTAGE CATEGORIES

- * **Cat I**: Low voltage installations isolated from the mains.
- * **Cat II**: Portable domestic installations.
- * **Cat III**: Fixed domestic installations.
- * **Cat IV**: Industrial installations.

CAUTION: The battery used can present danger of fire or chemical burn if it is severely mistreat. Do not disassembly, cremate or heat the battery above 100 °C under no circumstances.

TABLE OF CONTENTS

1. INTRODUCTION	1
1.1. Description	1
2. SETTING UP	3
2.1. Package Content	3
2.2. Power	3
2.3. Equipment Details	6
2.4. Switching On / Off	8
2.5. Icons Table	9
2.7. General Settings	10
2.6. Controls	10
2.8. Firmware Update	11
3. MEASUREMENT	12
3.1. Downstream Spectrum Analyzer	12
3.2. Upstream	16
3.3. Scan	18
3.4. Tilt	20
3.5. Voltmeter	22
3.6. Digital Signal Demodulator	24
3.7. Analog Signal Demodulator	26
4. TOOLS	28
4.1. Edit Channel Plan	28
4.2. Screenshot	36
4.3. Datalogger - Test & Go	38
5. SPECIFICATIONS	40
6. MAINTENANCE	46
6.1. Instructions for Returning by Mail	46
6.2. Considerations about the TFT Screen	46
6.3. Cleaning Recommendations	46



DIGITAL MULTI SYSTEM ANALYZER

RANGER

1 INTRODUCTION

1.1 Description

The **RANGER mini** is the latest introduction in our TV analyzer product range. It is a multi system analyzer that can work in terrestrial, satellite and cable transmission systems. It can also be expanded to work with optical fibre.

The **RANGER mini** has all the functions necessary for an easy installation of any service. In addition, its intuitive menu, its adjusted weight and strength, makes it ideal for fieldwork.

The **RANGER mini** features a 5" professional grade resistive type touch-screen with excellent brightness and superior image sharpness. It includes a case with a touch pen to make easy browsing around the menus. The instrument is powered by an internal rechargeable battery.

In the design of the **RANGER mini** it has dedicated particular attention on making a practical and precise instrument, as easy to use. The touch interface allows direct access to different modes of operation and once there, it is easy to modify any parameter of the measurement.

All this makes the **RANGER mini** in a magnificent tool for installing and maintaining all kind of systems: Terrestrial, satellite and HFC (Hybrid Fiber Cable) / CATV. Being also very useful for testing DOCSIS data transmission systems.

In addition, the instrument provides Ethernet and USB port slots to connect to external devices, to download data and to update firmware.

Here are some of the most important functions in the **RANGER mini**.

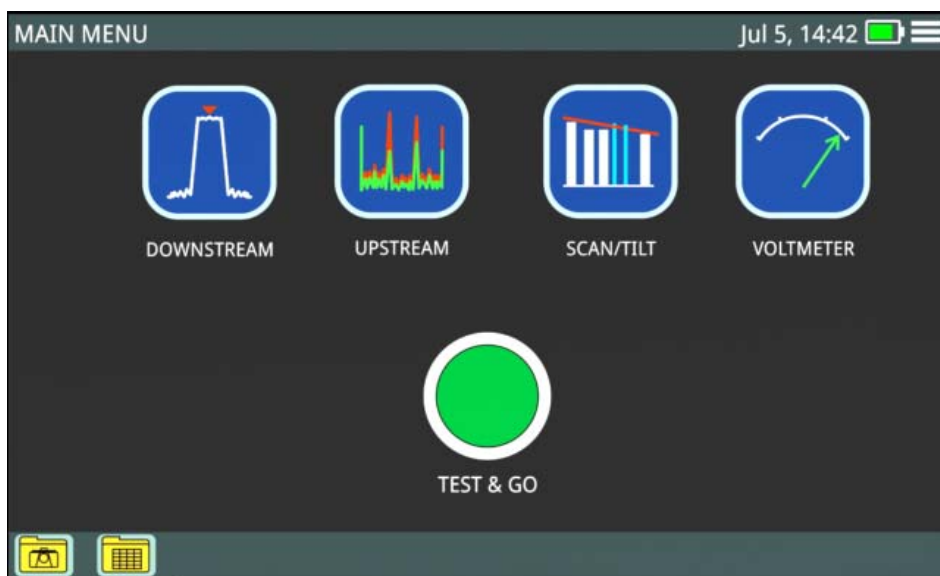

Figure 1.

The **Downstream Spectrum Analyzer** function provides an analysis of downstream spectrum in the band between 5 and 2700 MHz. It can demodulate a signal and show its constellation. Reference level and span can be set by user.

The **Upstream** function provides an analysis of upstream spectrum in the band between 5 and 200 MHz. It can easily detect impulse noise.

The **Scan** function shows the level of all active channels in the channel plan through a bar chart.

The **TILT** function measures the tilt in dB obtained from the difference in level between four carriers. It is useful for equalizing the line.

The **Voltmeter** function automatically identifies the voltage type (DC or AC) at the input and the frequency in case of alternating voltage.

In addition, it includes other tools such as datalogger, screenshot, channel plan editor, etc.

In short, implementation of all these functions into an light instrument, ergonomic design and robust, makes the **RANGER mini** into a productive and efficient fieldwork tool for the installer.

The **RANGER mini** can be expanded with an optical input allowing field technicians not only to perform optical power measurements but also to do all the RFOG measurements using a built-in optical to RF converter.



2 SETTING UP

2.1 Package Content

Check that your package contains the following elements:

- RANGER *mini* Analyser.
- External DC charger.
- Power cord for external DC charger
- "F" Adapters
 - "F" / f - BNC / f Adapter. (2 u.).
 - "F" / f - "F" / f Adapter (2 u.).
- Carrying case.
- Transport suitcase.
- Touch pen.
- Quick Start Guide.

NOTE: Keep the original packaging, since it is specially designed to protect the equipment. You may need it in the future to send the analyser to be calibrated.

2.2 Power

The RANGER *mini* is powered by a 7.2 V built-in rechargeable LiPo battery of high quality and long operation time. This equipment can operate on battery or connected to the mains using a DC adapter.

2.2.1 First Charge

The equipment comes with the battery half charged. Depending on the time elapsed from first charge and environmental conditions may have lost some of the charge. You should check the battery level. It is advisable a first full charge.



2.2.2 Charging the Battery

Connect the DC power adapter to the equipment through the power connector on the downside panel (see figure).



Figure 2. Power input and Charge Indicator + ON / OFF Button

Then connect the DC power adapter to the mains via the mains cord. Ensure that your mains voltage is compatible with the adapter voltage.

For a fast charging of the battery is necessary to switch off the equipment.

If the equipment is ON, the battery charging will be slower, depending on the type of work you are doing. When connecting the equipment to the mains the mains connected symbol appears inside the battery icon.

The led indicator next to the ON/OFF button shows the battery status:

- **Red:** Battery charging.
- **Off:** Battery full charge.

When switching on the equipment, the battery voltage is checked. If the tension is too weak to start, the equipment does not start up. In this case please charge the battery immediately.

2.2.3 Charge / Discharge times

Average charging time with the equipment off (fast charge):

- 3 hours to achieve an 80% charge.
- 5 hours to achieve an 100% charge.



With the equipment on (slow charge):

- 5 hours to achieve an 80% charge.
- 8 hours to achieve a 100% charge.

Average discharge time:

- With the battery at full charge the average battery time is 4 hours.
- With the battery at 80% charge the average battery time is 3 hours.

2.2.4 Usage Tips

The battery is losing storage capacity as you go through its life. Contact your **PROMAX** distributor when necessary to replace the battery.

To prolong battery life the user should follow these tips:

- In case of providing a long inactivity period of the equipment it is advisable to make every 3 months a charge / discharge cycle and a subsequent partial charge (40% aprox.).
- It is advisable to keep it in a cool place and away from heat.
- You should avoid keeping the battery for a long period of time at full load or fully discharged.
- There is not necessary to wait to fully discharge before a charge because these batteries have no memory effect.



2.3 Equipment Details

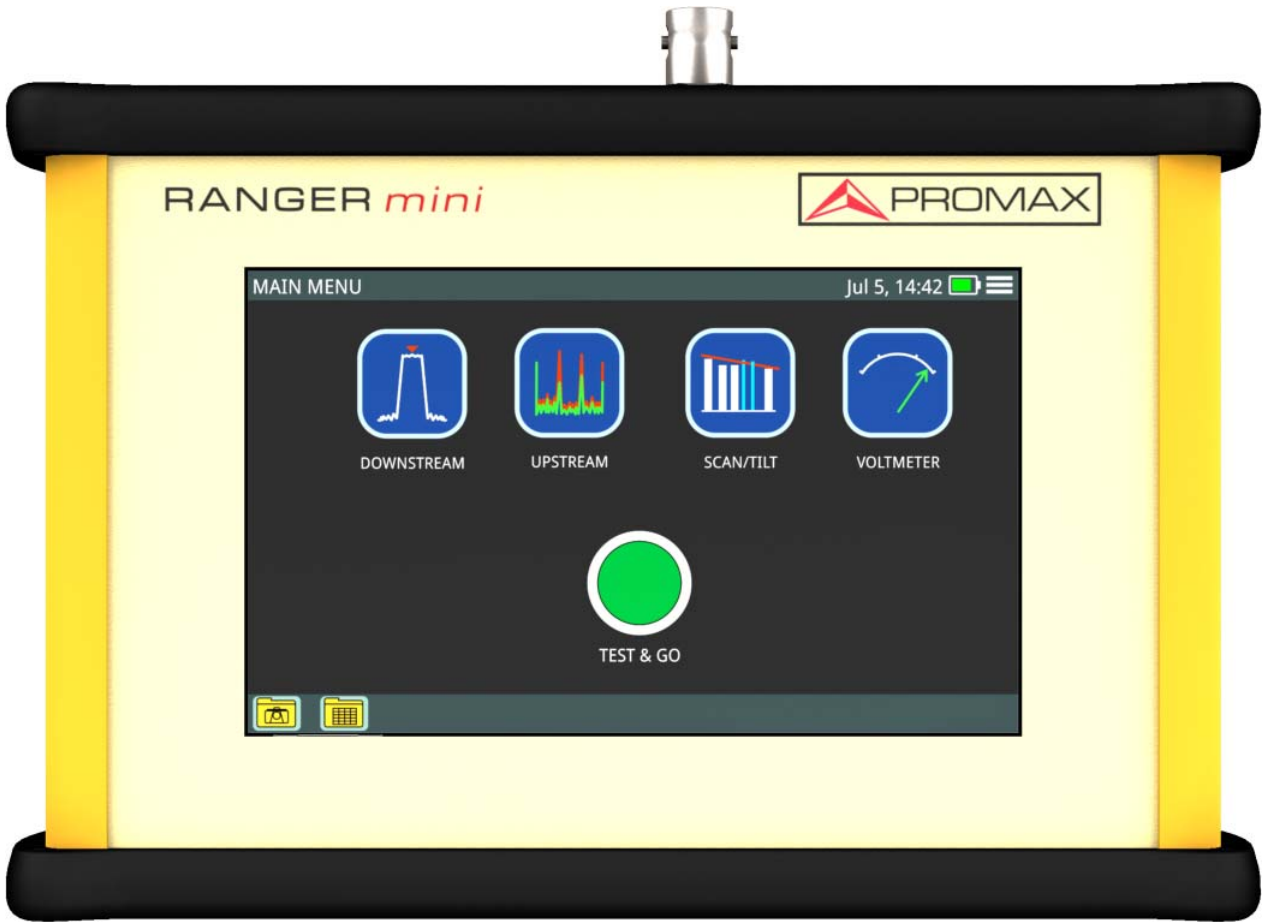

Figure 3. Front View.



Figure 4. Upside View.



Figure 5. Downside View.

2.4 Switching On / Off



► Switching On:

- 1 Press the on/off button located on the side of the equipment.
- 2 The boot screen appears. After the system load, the last screen before shutdown appears.



► **Switching Off:**

1 There are two options:









- **Option 1:** Press the ON/OFF* button located on the downside of the equipment. A gray screen with a red power off icon  will appear. Click on this icon to turn off the equipment or outside the icon to cancel power off.
- **Option 2:** Press on the menu icon  located at the screen upper right corner. Next press on the power off icon at the bottom right corner. A gray screen with a red power off icon  will appear. Click on this icon to turn off the equipment or outside the icon to cancel power off.

2 The equipment keeps its last status which is recovered when power on.

2.5

Icons Table

TOUCH ICONS

-  Screenshot
-  Back to previous screen
-  Back to main screen
-  Access to screenshots
-  Access to dataloggers
-  Access to settings menu
-  Switch off
-  Edit value
-  Select parameter

INDICATIVE ICONS







-  USB flashdrive connected and detected
-  Connected to Ethernet network
-  Battery charging
-  Battery not charging. Green level indicates battery left
-  Low battery
-  Cable measurements
-  Fibre optics measurements

Figure 6.

*. In case of crashing, press and hold on/off button until it turns off.



2.6 Controls

The equipment is operated only using the touch panel.

These actions can be done through the touch panel:

- Menu Selection.
- Frequency or channel selection or edition.
- Frequency or channel scroll.
- Reference level scroll.
- SPAN selection.
- Virtual keyboard writing (numerical and alphabetical).

2.7 General Settings

From the Home screen, clicking on the menu icon  you access the general settings:

- **Edit channel plan:** It allows you to edit a channel plan (refer to "Edit Channel Plan" chapter).
- **Language:** It allows you to select a language among English, Spanish, French or German.
- **Date:** It allows you to set date.
- **Time:** It allows you to select time format (12/24) and set time.
- **Sound:** It allows you to set sound level and enable or disable beep.
- **Auto power off:** It allows you to enable or disable auto power off option.
- **Equipment information:** It shows serial number, software version and other technical data.
- **Ethernet Configuration:** It allows you to select type of connection (manual/DHCP/Bridge) and network data (IP, Netmask, Gateway, DNS1, DNS2).
- **Test&Go configuration:** It allows you to set the datalogger settings when pressing on Test&Go (Scan, DBG or TILT measurements).



2.8 Firmware Update

Keep your device up to date for the latest improvements and features. Follow us on social networks (twitter, Facebook, linkedin, Google+) to get information about updates and latest news. To update follow these steps:

- 1 Use a USB flash drive in FAT32 format.
- 2 Download the file from the download area at PROMAX website (www.promaxelectronics.com).
- 3 Copy the update file (update_usb.tar) to the flash drive root (do not unzip the file).
- 4 Turn OFF the **RANGER mini** and insert the flash drive into the USB port.
- 5 Turn ON the **RANGER mini**. The update process starts automatically. Wait until finished.
- 6 Remove the flash drive.
- 7 Press the ON/OFF button for more than 5 seconds until the equipment turns OFF.
- 8 Turn ON again.



3 MEASUREMENT

3.1 Downstream Spectrum Analyzer

► Description

The **Downstream** function shows on screen the downstream spectrum of the signal received through the input connector in the band between 5 and 2700 MHz.

This function shows signals in the frequency band so any problem can be detected easily. It also measures level and demodulates the tuned signal.

User can adjust span and reference level for the frequency or channel tuned. User can also select trace type (max hold / min hold), measurement units and other parameters.

► Operation

- 1 Connect signal to the input through F/F or F/BNC adapter.
- 2 From the main screen press on the **DOWNSTREAM** icon.
- 3 **DOWNSTREAM** function opens.
- 4 Signal can be tuned by one of this ways:
 - **Tuning by CHANNEL:** Select one channel from a channel plan.
 - **Tuning by FREQUENCY:** Enter the frequency to tune.
 - **Tuning by DBG:** Select one DBG group and carrier to tune.

Tuned signal is located by the marker on top.

- 5 Press **DEMOD** to demodulate signal and show its constellation.
 - **CHANNEL tuning:** It can demodulate signal according to channel parameters defined in the channel plan.
 - **FREQUENCY tuning:** It can demodulate signal according to parameters defined in settings menu.
- 6 To show channels with DOCSIS BONDING GROUP carriers select a channel that belongs to a DBG and press on **DBG** (for cable transmission according to DOCSIS standard).
- 7 Press **HOME**  key to get back to the main screen.



► **Downstream Screen Description**

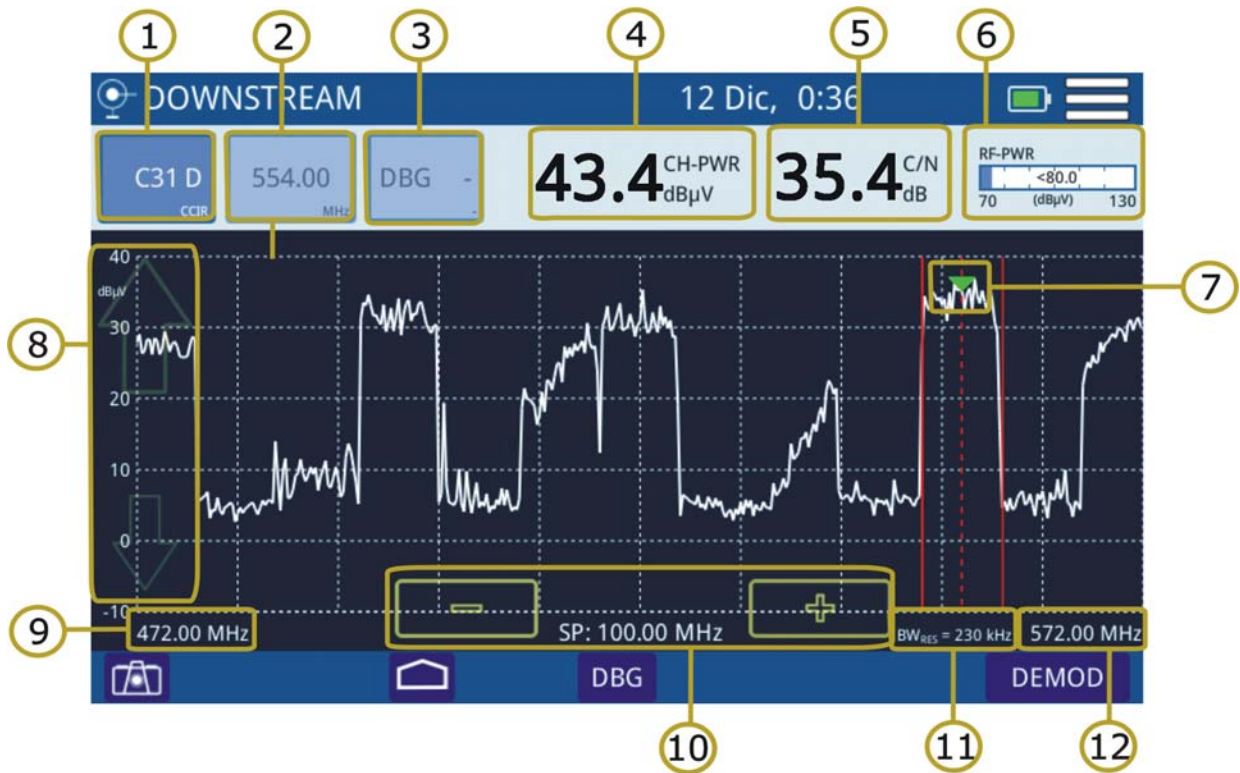

Figure 7. Downstream Spectrum

- 1 Selected channel. When pressing on it deploys a list of available channels.
- 2 Frequency selected. When pressing on it pops up a virtual numeric keypad to edit frequency.
- 3 DOCSIS Bonding Group selected and carrier.
- 4 According to signal type:
 - Digital signal: Power for channel bandwidth or frequency.
 - Analogue signal: Level for channel or frequency selected.
- 5 Carrier/Noise ratio for channel selected.
- 6 Full band RF cable power.
- 7 Marker for selected channel / frequency.
- 8 Arrows to change reference level.
- 9 Span lower frequency.
- 10 Arrows to increase / decrease span. Current span.
- 11 Bandwidth resolution.
- 12 Span upper frequency.



► DOCSIS BONDING GROUP Screen Description

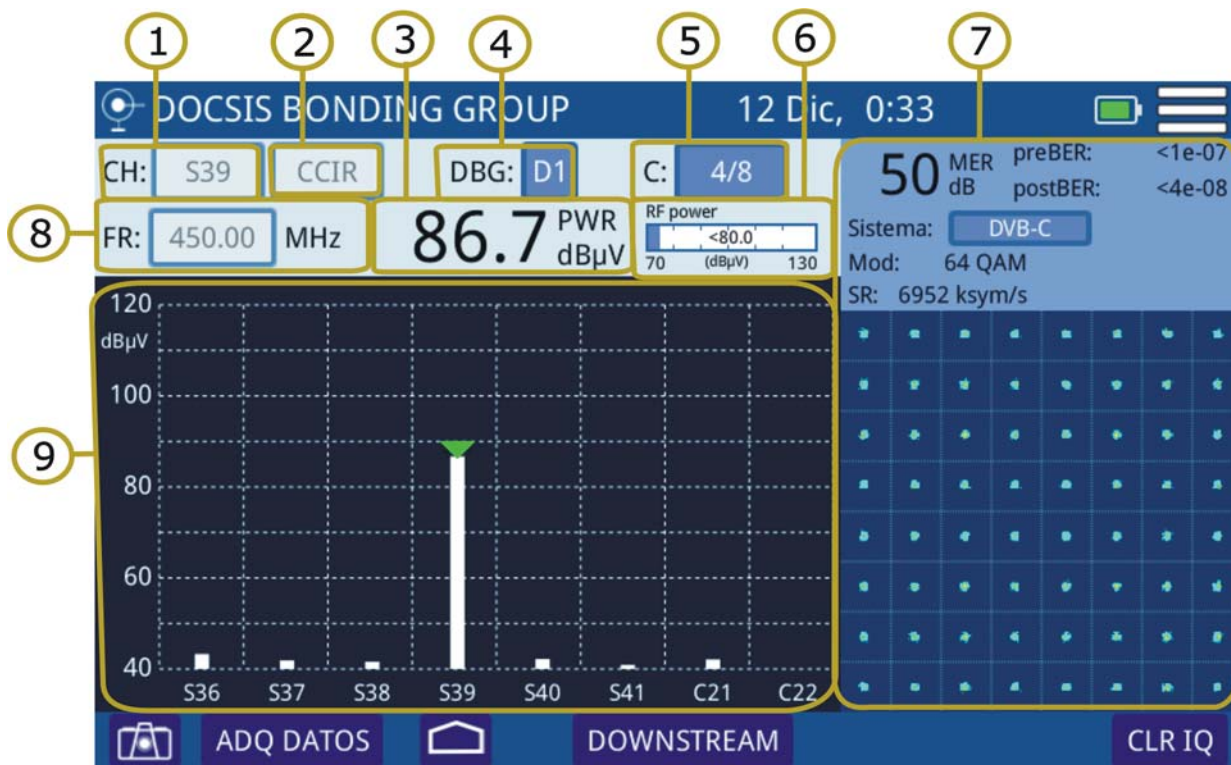



Figure 8. DOCSIS Bonding Group

- 1 Selected channel. Selected channel should belong to a DBG.
- 2 Channel plan for the channel selected.
- 3 Channel bandwidth power.
- 4 DOCSIS Bonding Group selected. When pressing on, it deploys a list of available DBGs.
- 5 DBG carrier selected. When pressing on, it deploys a list of available carriers.
- 6 Full band RF cable power.
- 7 Demodulation and constellation for the channel or frequency tuned (for more details see "Demodulator" chapter).
- 8 Frequency selected. When pressing on it pops up a virtual numeric keypad to edit frequency.
- 9 The graph shows the DBG channels. The marker is on the selected carrier.



► Options Menu

There are some options at the bottom of the screen:

-  : Screenshot.
- : Back to home screen.
- **DBG / DOWNSTREAM**: It switches between the DOCSIS BONDING GROUP screen that shows DBG carriers or the Downstream spectrum signal screen.
- **DEMODO**: Access to Demodulator (refer to "Demodulator " chapter).

► Settings

Click on the MENU icon  at the upper right corner to access the Settings menu. The **DOWSTREAM** function has these options:

- **Edit channel plan**: It allows you to edit a channel plan and DOCSIS Bonding Group (refer to "Edit Channel Plan" chapter).
- **Units**: It allows you to select measurement unit for power (dBuV, dBmV, dBm).
- **Reference line**: It allows you to select the reference line by numbers (-60 dBmV to +70 dBmV). Reference line allows you to define criteria in order to quickly accept or refuse channel levels.
- **Trace**: It allows you to select holding type of trace (maximal, minimum).
- **CTB/CSO**: It allows you to set parameters to measure intermodulation distortion CTB/CSO (Composite Triple Beat / Composite Second Order) that has a big influence on the net quality.
- **Frequency step**: It allows you to select frequency step (0.25 MHz, 1 MHz, 8 MHz, other value).
- **Full span maximum frequency**: It allows you to select full span maximum frequency (900 MHz, 2700 MHz, other value).
- **Tuning frequency demodulation**: It allows you to set parameters to demodulate signal when tuning by frequency. User must select type of signal, transmission standard (when it is digital) and other related parameters.



3.2 Upstream

► Description

The **Upstream** function shows the upstream spectrum in the band between 5 and 205 MHz allowing to detect impulse noise.

User can adjust span and reference level for the frequency or channel tuned.

► Operation

- 1 Connect signal to the input through F/F or F/BNC adapter.
- 2 From the main screen press on the UPSTREAM icon.
- 3 **UPSTREAM** function opens.
- 4 Press **HOME**  key to get back to the main screen.

► Screen Description

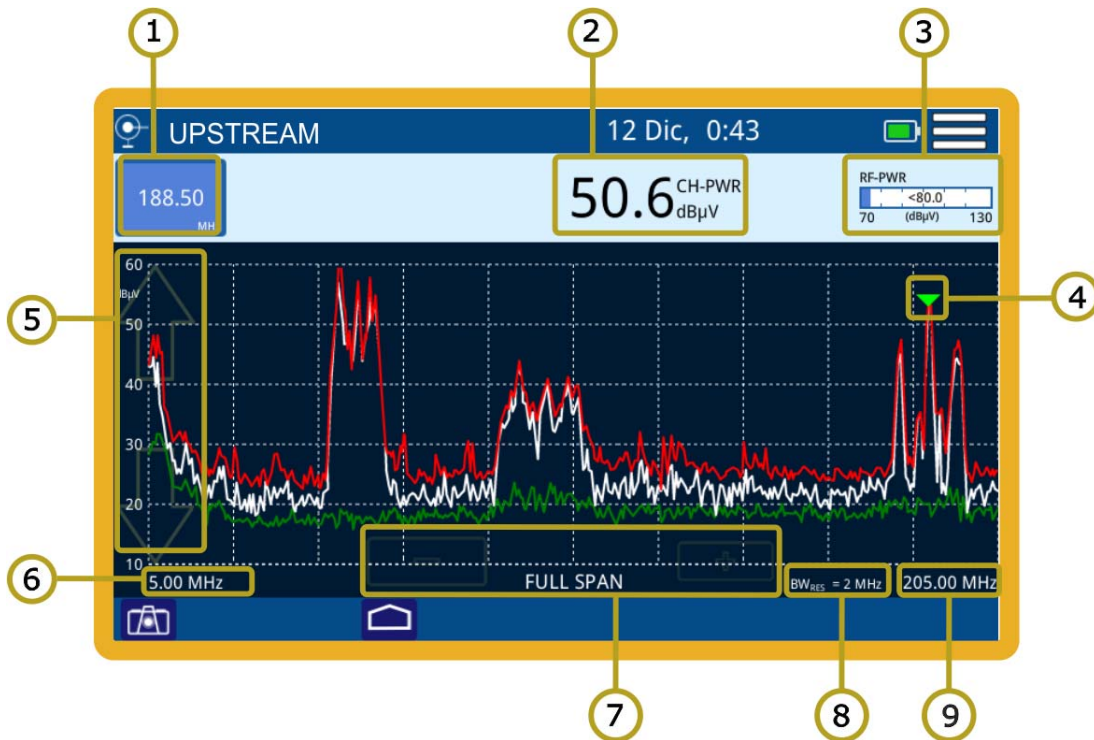

Figure 9.



- 1 Frequency selected. When pressing on it pops up a virtual numeric keypad to edit frequency.



- 2 Level for the selected frequency.
- 3 Full band RF cable power.
- 4 Marker in the selected frequency.
- 5 Arrows to change reference level.
- 6 Span lower frequency.
- 7 Arrows to increase / decrease span. Current span.
- 8 Bandwidth resolution.
- 9 Span upper frequency.

► Options Menu

There are some options at the bottom of the screen:

- : Screenshot.
- : Back to home screen.

► Settings

Click on the MENU icon  at the upper right corner to access the Settings menu. The **UPSTREAM** function has these options:

- **Frequency step:** It allows you to select full span maximum frequency (0.25 MHz, 1 MHz, 8 MHz, other value).
- **Full span maximum frequency:** It allows you to select full span maximum frequency (900 MHz, 1700 MHz, other value).



3.3

Scan

► Description

The **SCAN** function shows on screen signal level in graphic bar format for each one of the active channels in the selected channel plan.

► Operation

- 1 Connect signal to the input through F/F or F/BNC adapter.
- 2 From the main screen press on the SCAN/TILT icon.
- 3 **SCAN** function opens. It shows a bar graph representing signal level or power for each one of the active channels in the channel plan
- 4 Press **DEMOD** to demodulate signal.
- 5 Press **HOME**  key to get back to the main screen.

► Screen Description

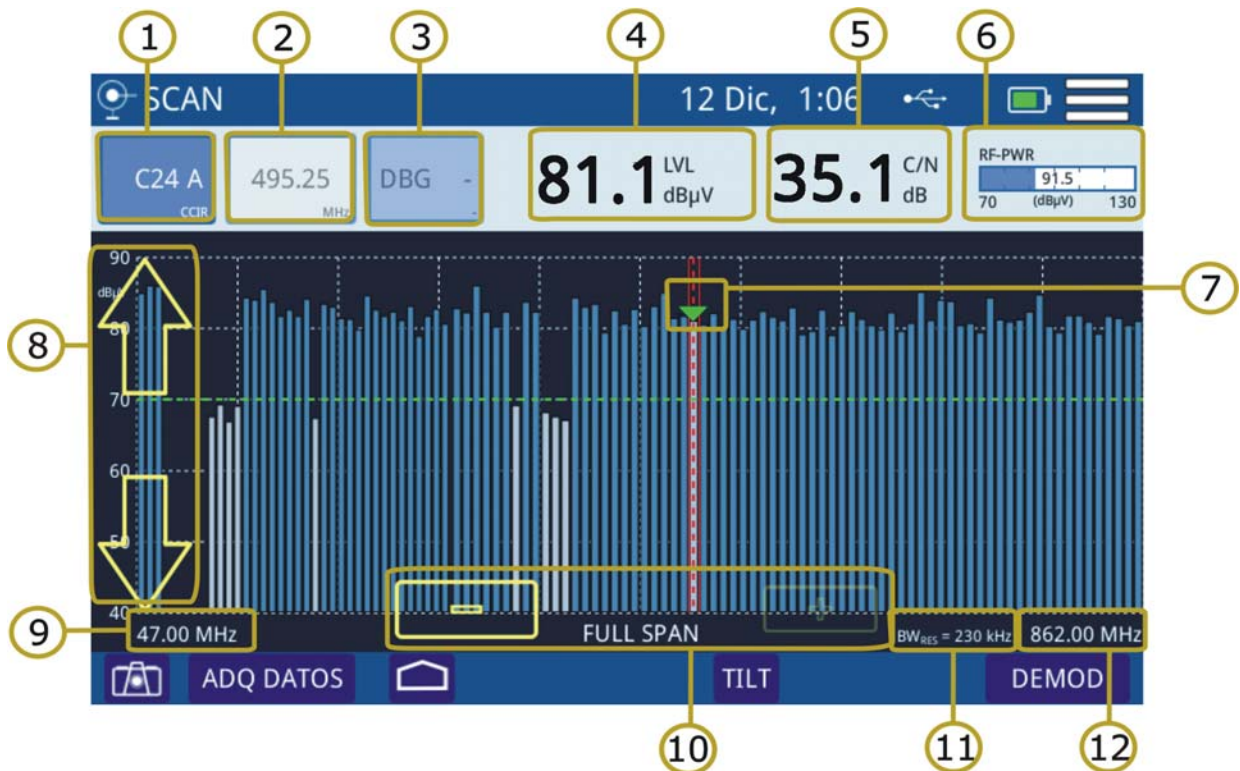

Figure 10.



- 1 Selected channel. When pressing on, it deploys a list of available channels.



- 2 Frequency for the channel selected.
- 3 DOCSIS Bonding Group selected and carrier (if any).
- 4 According to signal type:
 - Digital signal: Power for channel bandwidth or frequency.
 - Analogue signal: Level for channel or frequency selected.
- 5 Carrier/Noise ratio of the channel.
- 6 Full band RF cable power.
- 7 Marker for selected channel / frequency.
- 8 Arrows to change reference level.
- 9 Span lower frequency.
- 10 Arrows to increase / decrease span. Current span.
- 11 Bandwidth resolution.
- 12 Span upper frequency.

► Options Menu

There are some options at the bottom of the screen:

- : Screenshot.
- **DATALOGGER**: It creates a datalogger with measurement data.
- : Back to home screen.
- **TILT**: Access the TILT function.
- **DEMOD**: Demodulator (refer to "Demodulator" chapter).



► Settings Menu

Click on the **MENU**  icon at the upper right corner to access the Settings menu. The **SCAN** function has these options:

- **Edit channel plan:** It allows you to edit a channel plan and DBG (refer to "Edit Channel Plan" chapter).
- **Units:** It allows you to select a measurement unit for power (dBuV, dBmV, dBm).
- **Reference Line:** It allows you to select the reference line by numbers (-60 dBmV to +70 dBmV). Reference line allows you to define criteria in order to quickly accept or refuse channels levels.
- **Threshold:** It allows you to threshold level.
- **CTB/CSO:** It allows you to set parameters to measure intermodulation distortion CTB/CSO (Composite Triple Beat / Composite Second Order) that has a big influence on the net quality.

3.4 Tilt

► Description

The **TILT** function is a test to measure tilt in order to equalize the line. **TILT** is the difference in amplitudes between the minimum and maximum frequency that the system can compensate.

The **TILT** function displays on-screen, graphically and numerically, the difference in level between any four frequencies previously defined as pilots. This function works for upstream and downstream band.

Typically, CATV networks transmit pilot signals at the beginning and at the end of the band. These pilots signals and other intermediate signals can be tuned simultaneously on the screen. By this way you can evaluate the losses tilt and therefore readjust equalizers of the amplifiers in order to compensate these losses and ensure a flat response along the band.



► **Operation**

- 1 Connect signal to the input through F/F or F/BNC adapter.
- 2 From the main screen press on the **SCAN/TILT** icon.
- 3 Press on **TILT** option at the bottom of the screen.
- 4 **TILT** function opens.
- 5 Press on the lower right corner to switch between Upstream and Downstream band.
- 6 Press **HOME** key to get back to the main screen.

► **Screen Description**

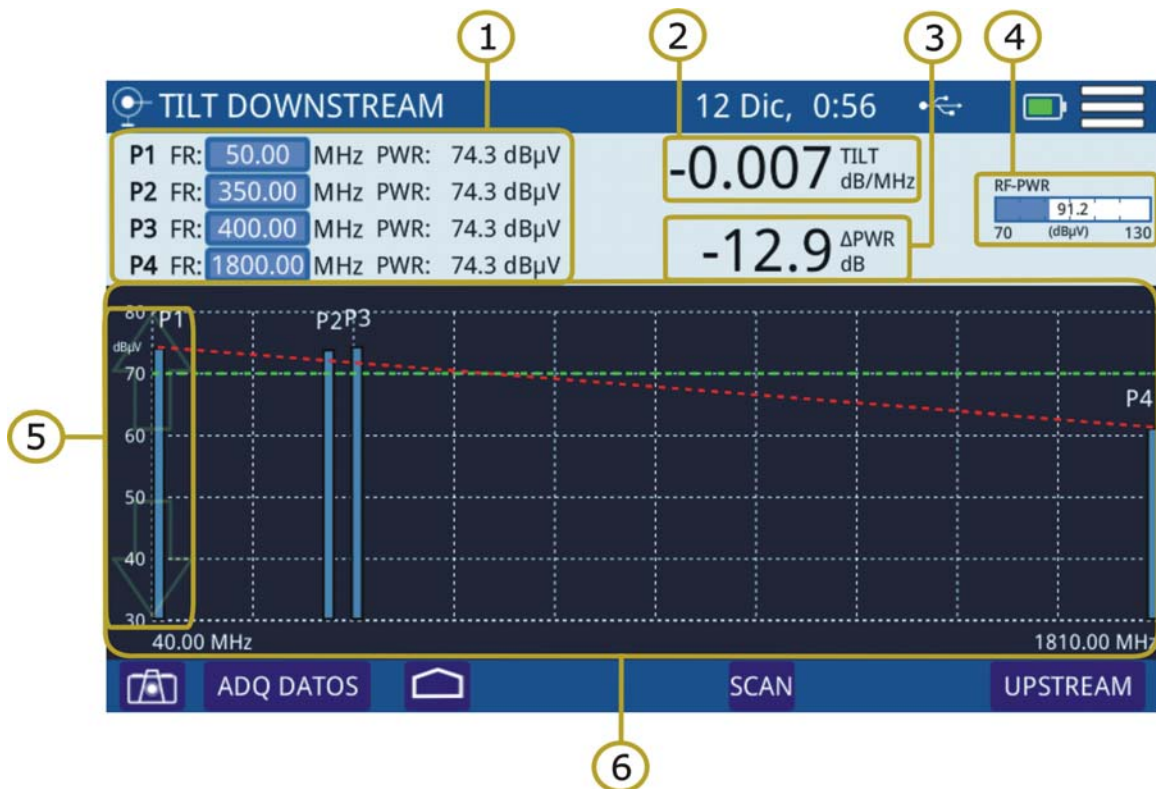

Figure 11.



- 1 It shows pilot signals frequency and power. Press on frequency to change its value.
 - P1/P4: End pilot signals.
 - P2/P3: Intermediate pilot signals.
- 2 TILT: Inclination rate in dB per MHz.
- 3 Power difference between P1 and P4.
- 4 Full band RF cable power.



- 5 Arrows to change reference level.
- 6 Bar graph showing signal level for each pilot signal and TILT.

► Options Menu

There are some options at the bottom of the screen:

-  : Screenshot.
- **DATALOGGER**: It creates a datalogger with measurement data.
- : Back to home screen.
- **SCAN**: Access the SCAN function.
- **UPSTREAM/DOWNSTREAM**: It allows you to switch between upstream and downstream band. The current band appears on the top of the left corner.

► Settings Menu

Click on the **MENU**  icon at the upper right corner to access the Settings menu. The **TILT** function has these options:

- **Units**: It allows you to select a measurement unit for power (dBuV, dBmV, dBm).

3.5 Voltmeter

► Description

The VOLTMETER function automatically identifies the voltage type (DC or AC) at the input and the frequency in case of alternating voltage.

It also allows to supply voltage to a LNB in several bands and polarizations in case of working in satellite band.

► Operation

- 1 Connect signal to the input through F/F or F/BNC adapter.
- 2 From the main screen press on the VOLTMETER icon.
- 3 VOLTMETER function opens.
- 4 Press **HOME**  key to get back to the main screen.



► Screen Description

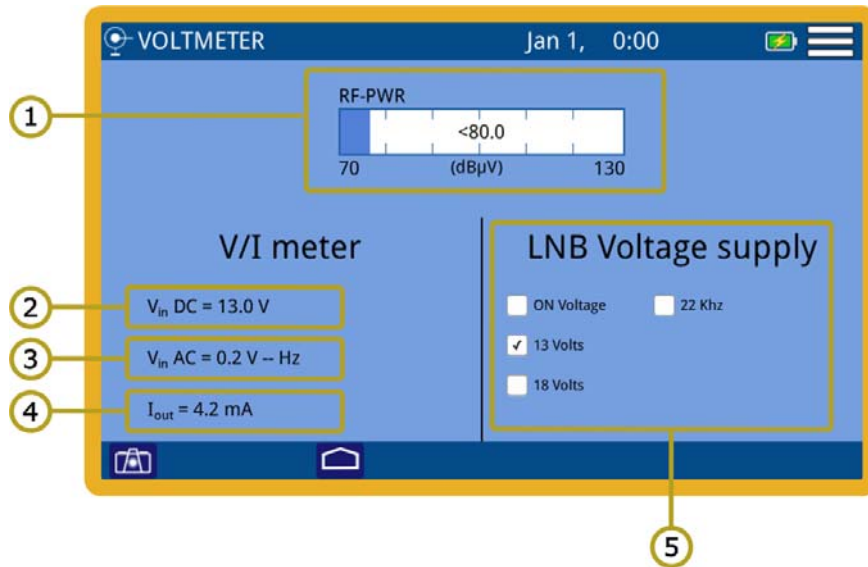



Figure 12.

- 1 RF-PWR: Full bandwidth power.
- 2 Vin DC: DC input voltage.
- 3 Vin AC: AC input voltage and frequency.
- 4 Iout: Current out.
- 5 Voltage supply for the LNB:
 - ON Voltage: Check the box to enable voltage supply.
 - 13 Volts / 18 Volts: Check the box to select between polarization (vertical=13 V; horizontal=18V).
 - 22 kHz: Commutation tone. Check the box to change band (0 kHz=low; 22 kHz=high).

► Options Menu

There are some options at the bottom of the screen:

- : Screenshot.
- : Back to home screen.



► Settings Menu

Click on the  **MENU** icon at the upper right corner to access the Settings menu. The VOLTMETER function has these options:

- **Units:** It allows you to select measurement unit for power (dBuV, dBmV, dBm).

3.6 Digital Signal Demodulator

► Description

Demodulator provides the most important measurements technicians need to assess digital QAM channel quality. Constellation diagram is a simple and graphical way to identify signal impairments which impact MER and ultimately BER. An ideal QAM channel for example will be represented by a set (constellation) of very sharp dots. These dots will become small dot clouds to indicate the presence of noise or other signal degradation sources. In addition to constellation diagram it also measures MER, preBER and postBER simultaneously with the spectrum trace.

► Operation

DEMODULATOR is available for digital signals of functions **SPECTRUM ANALYZER** and **SCAN**.

- 1 Select channel or frequency and tune it.
- 2 Press on "DEMOM" option.



► **Screen Description**

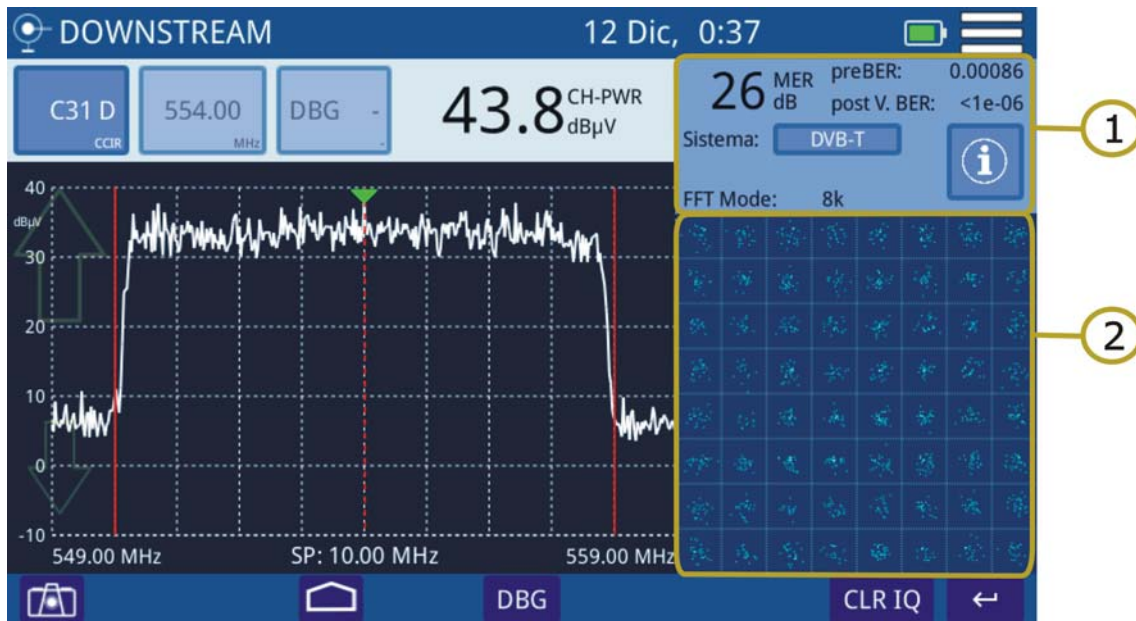

Figure 13.

- 1 Demodulated Signal Data.
 - MER for tuned channel.
 - pre-BER (BER before correction).
 - post-BER (BER after correction).
 - Transmission standard. Press to switch.
 - FFT Mode.
 - Press on "i" box to obtain more info.
- 2 Constellation Diagram (I-Q diagram).

► **Options Menu**

There are some options at the bottom of the screen:

- **CLR IQ:** It clears constellation.
- Back to previous screen.



3.7 Analog Signal Demodulator

► Description

The equipment can measure video carrier signal level, Video/Audio and C/N ratio, **HUM** and intermodulation products from an analogue signal. This is all shown alongside the screen together with the spectrum analyzer graphic. The **HUM** is buzz at low frequency modulation that affects video analogue carriers, producing a distinctive hum. The **HUM** value up to 2% is considered acceptable. Above this value is not acceptable and it should take appropriate countermeasures.

► Operation

This function is available for analogue signals in **DOWNSTREAM** and **SCAN**.

- 1 Select analogue channel or frequency and tune it.
- 2 Press on "DEMOD" option.
- 3 To set measurement parameters for intermodulation products (CTB/CSO) access the settings menu at the upper right corner.



► **Screen Description**

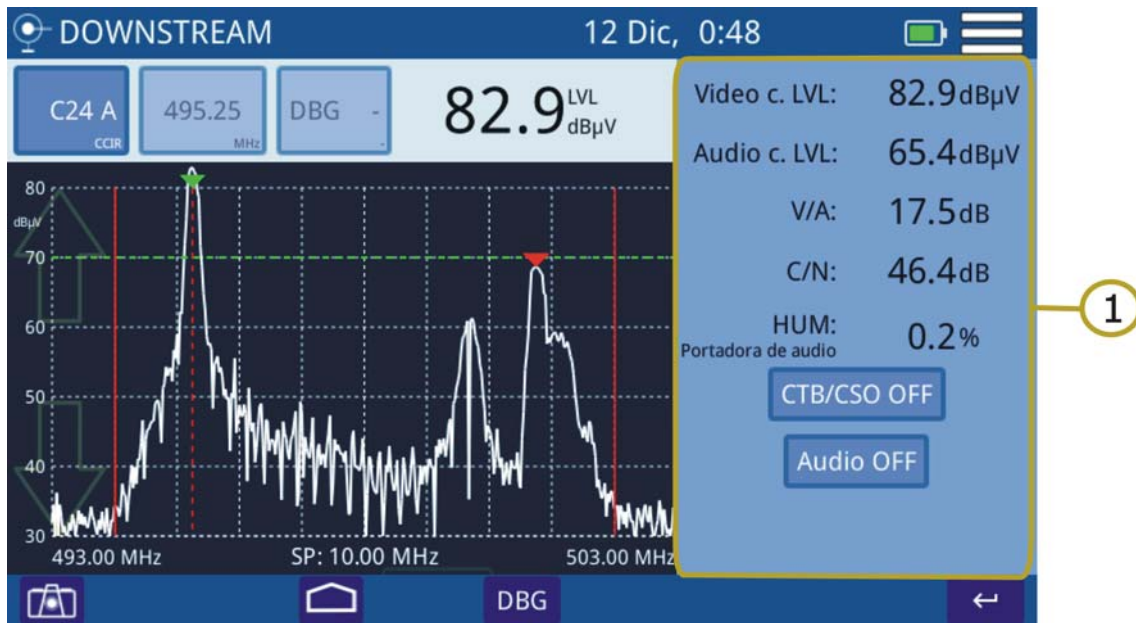

Figure 14.

- 1 Analogue Video Carrier / HUM.
 - Video c.LVL: Level of video carrier.
 - Audio c.LVL: Level of audio carrier.
 - V/A: Video/Audio ratio.
 - C/N: Carrier/Noise ratio.
 - HUM: Audio carrier.
 - CTB/CSO: Intermodulation product measurement. Press to enable/disable.
 - Audio OFF/ON: It enables / disables audio and to set audio level.



4 TOOLS

4.1 Edit Channel Plan

► Description

Channel plan editor allows to edit and create channel plans, and also to edit DBG (Docsis Bonding Group) channels.

► Operation

Channel plan editor is available for tools **DOWNSTREAM** and **SCAN** .

- 1 From the tool screen access settings menu by pressing on .
- 2 Press on "Edit Channel Plan" option to access channel plan editor.
- 3 To select a channel plan press on the channel plan name to dropdown a list of available channel plan. Select one of them.
- 4 Press on CH to switch between tune by channel or frequency.
- 5 Next to CH box press on the channel or frequency value to edit and select a specific channel or frequency. You can also select a channel moving along the channel plan list using the side scroll bar. The selected channel has a blue background.
- 6 Press on a parameter of the channel to edit. If the parameter is a number, it shows up a virtual keyboard to edit that value. If the parameter value is a text, you should press several times on it to switch among different options.
- 7 Once edited, press on Return key and it appears a window with options: "Save" (it saves changes and exits), "Don't save" (it does not save changes and exits), "Cancel" (it does not saves changes and does not exit).



► **Screen Description**

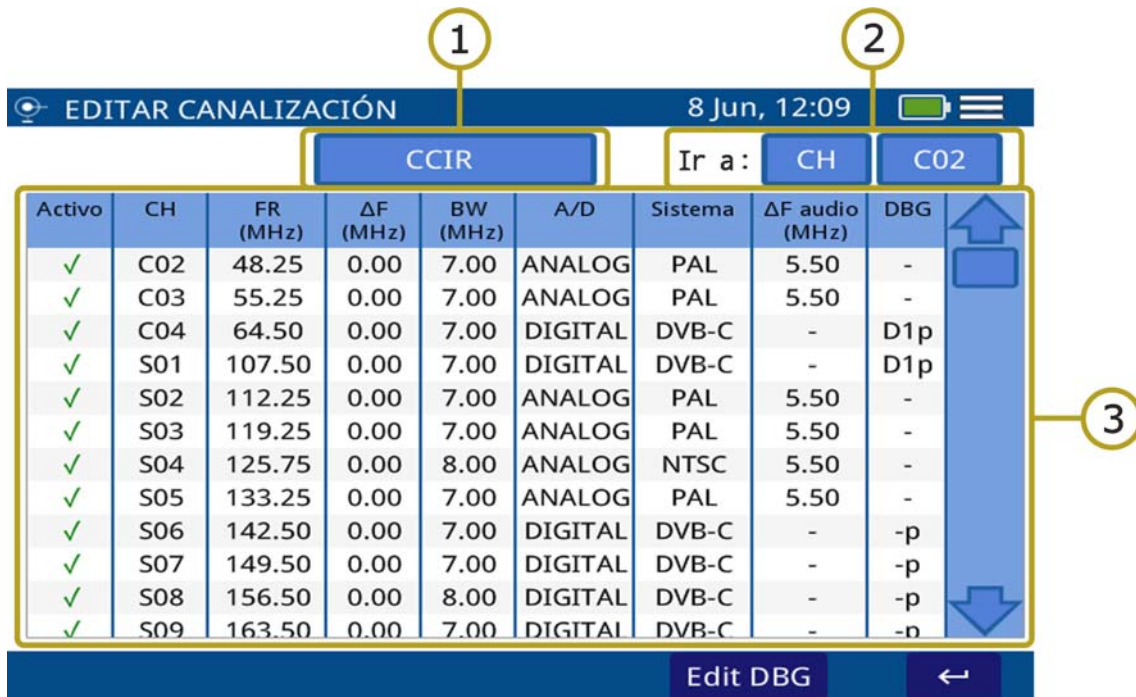

Figure 15.

- 1 Channel plan selected. Press on this box to select another channel plan.
- 2 Go to: Press on this box to switch between CH (channel) and FR (frequency) and to select a channel or frequency.
- 3 Channel table. Press on a parameter to edit or switch among options.

Parameters on channel table are:

- Active: To enable or disable channels.
- CH: Channel name.
- FR (MHz): Channel frequency (MHz).
- ΔF (MHz): Offset of tuned frequency for channel (MHz).
- BW (MHz): Bandwidth for channel.
- A/D: It indicates if channel is analogue (A) or digital (D).
- System: It indicates transmission standard (DVB-T/T2, ISDB-T, ITU J83.B, PAL/NTSC/SECAM, DVB-C/C2)*.
- ΔF Audio (MHz): Offset of tuned frequency for audio (MHz).
- DBG: It shows primary carrier for DBG.

*. Some standards may appear with an asterisk that means it is not available yet but it will be in next firmware updates.



► Options Menu

There are some options at the bottom of the screen:

- **EDIT DBG**: Opens the DBG editor screen (see next section).
- : Back to main screen.

► Settings Menu

Click on the MENU  icon at the upper right corner to access the Settings menu. The EDIT CHANNEL PLAN function has these options:

- Add new channel: It adds a new channel for a channel plan (for standard channel plans it is not allowed).
- Remove channel: It removes selected channel.
- New channel plan: It creates a new channel plan. There are three options (see next section):
 - Create a channel plan from an existing one.
 - Create automatically a channel plan from HFC network.
 - Create a channel plan from void pattern.
- Remove channel plan: It removes current channel plan.
- Import standard plan: It allows you to import a standard channel plan.



► EDIT DOCSIS BONDING GROUP Screen Description

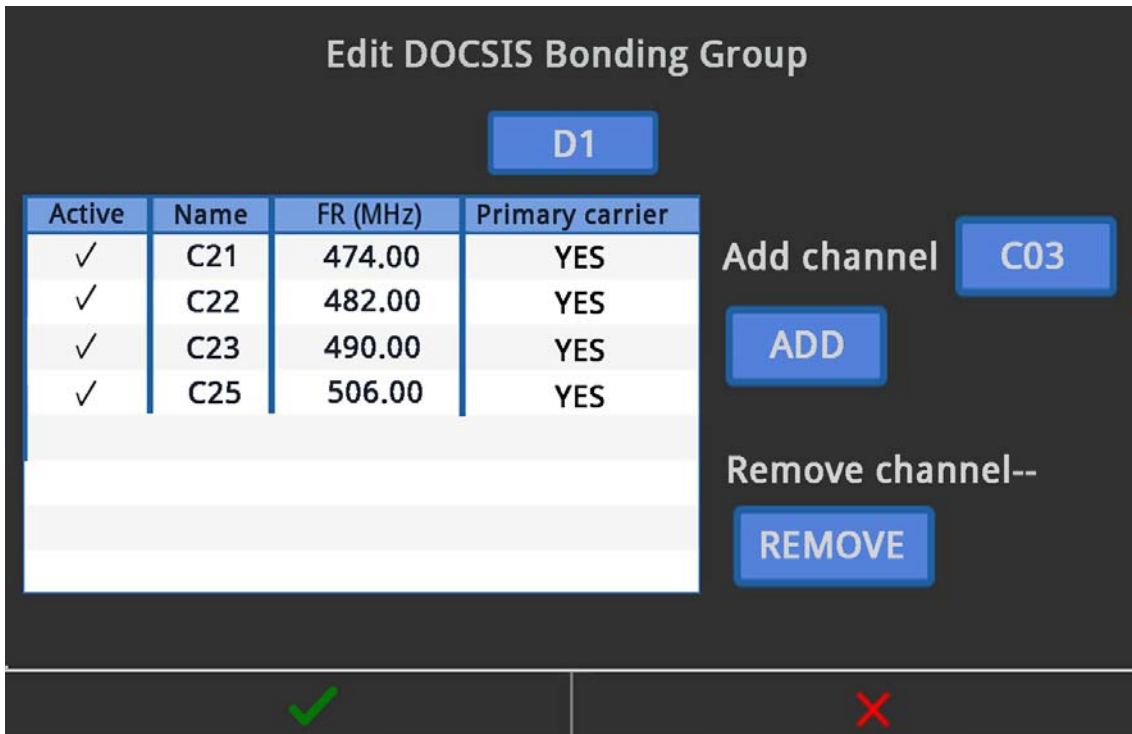

Active	Name	FR (MHz)	Primary carrier
✓	C21	474.00	YES
✓	C22	482.00	YES
✓	C23	490.00	YES
✓	C25	506.00	YES

Figure 16.

- Edit DOCSIS Bonding Group: Press on the box below to select a DBG to edit.
- Add channel: Press on the box next to “Add channel” to select one channel. Then press on ADD to add it to DBG.
- Remove channel: Press on one channel in the box to select it and then press on REMOVE to remove it from DBG.
- Primary Carrier: Press on Primary Carrier column to define if that channel is a primary carrier (YER or NO).



► Create a Channel Plan from an existing one

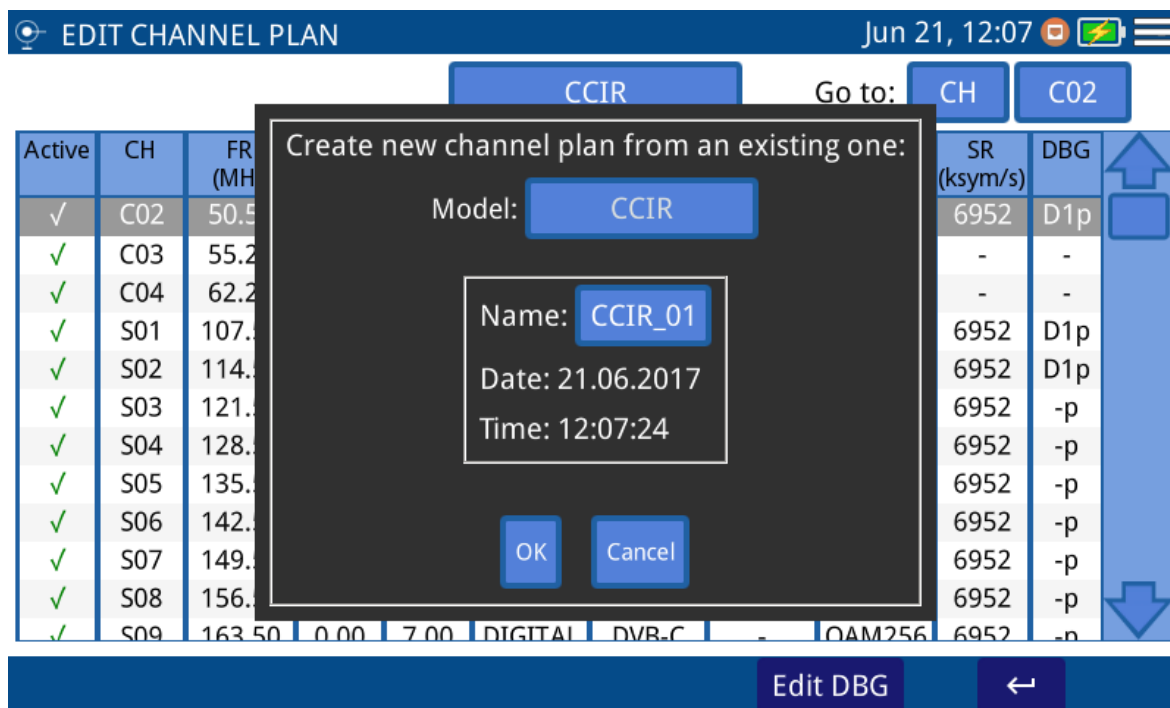

Figure 17.

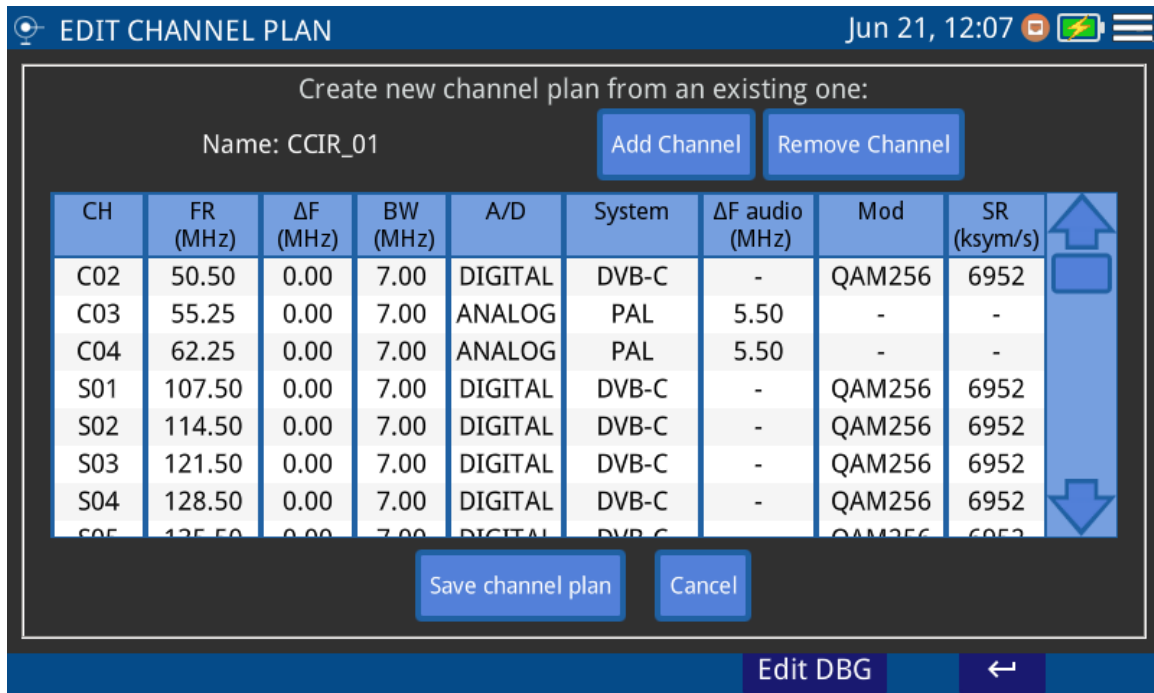

Figure 18.

- 1 Press on box "Model" to select a channel plan as a model to create a new one.
- 2 Press on box "Name" to give a name to the new channel plan.
- 3 Press "OK" to create a new channel plan or "Cancel" to exit.
- 4 At the next screen, press on "Add Channel", "Remove Channel" to edit channel plan. When finish, press on "Save channel plan" to save changes or "Cancel" to exit without saving.



► Create automatically a channel plan from HFC network

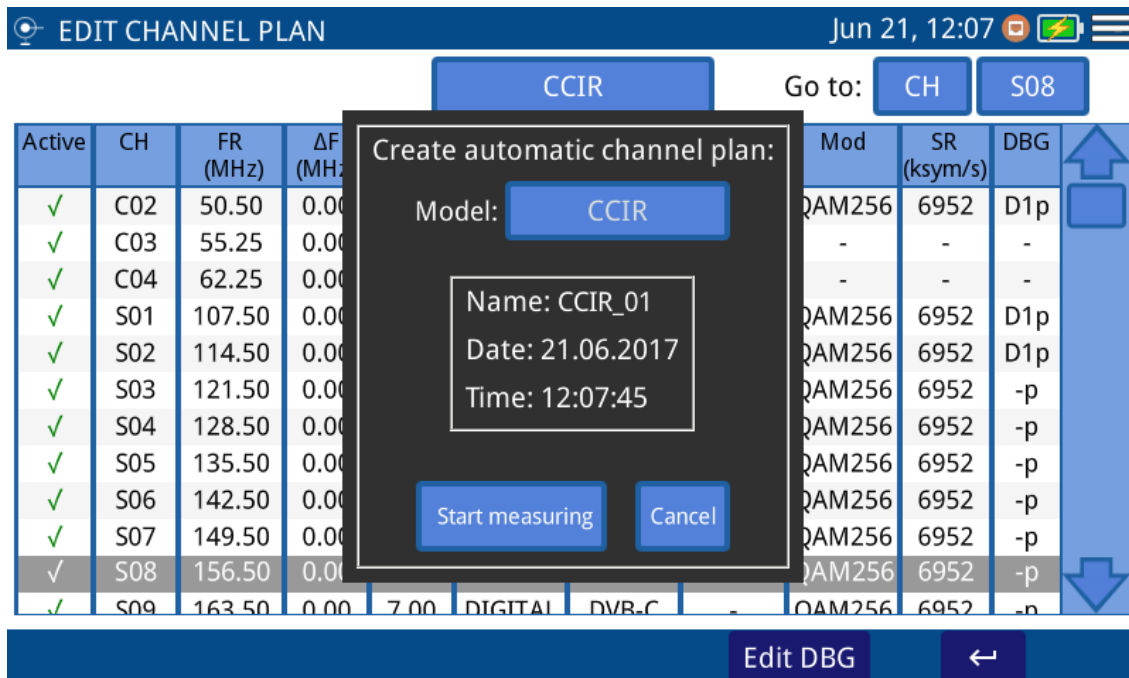

Figure 19.

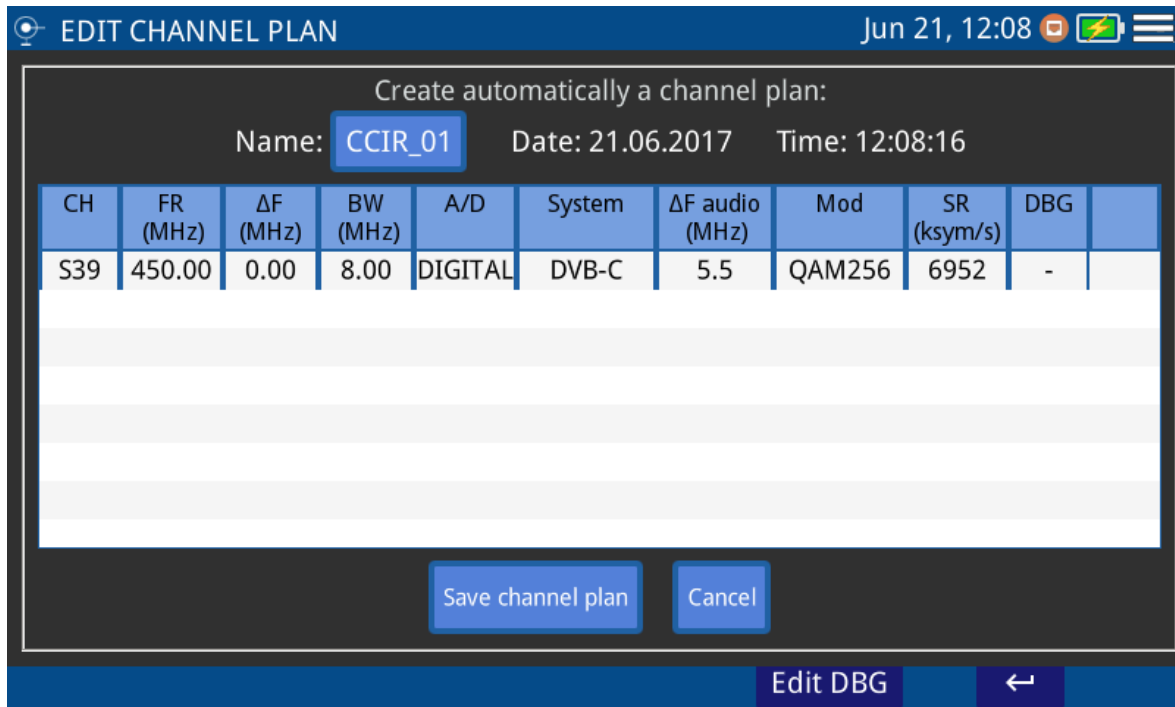

Figure 20.

- 1 Connect to the HFC network.
- 2 Press on box "Model" to select a channel plan as a model to create a new one.
- 3 Press on "Start measuring".
- 4 When finish press on "Name" box to edit the channel plan name. Press on "Save channel plan" to save changes or "Cancel" to exit without saving.



► Create a new Channel Plan from scratch

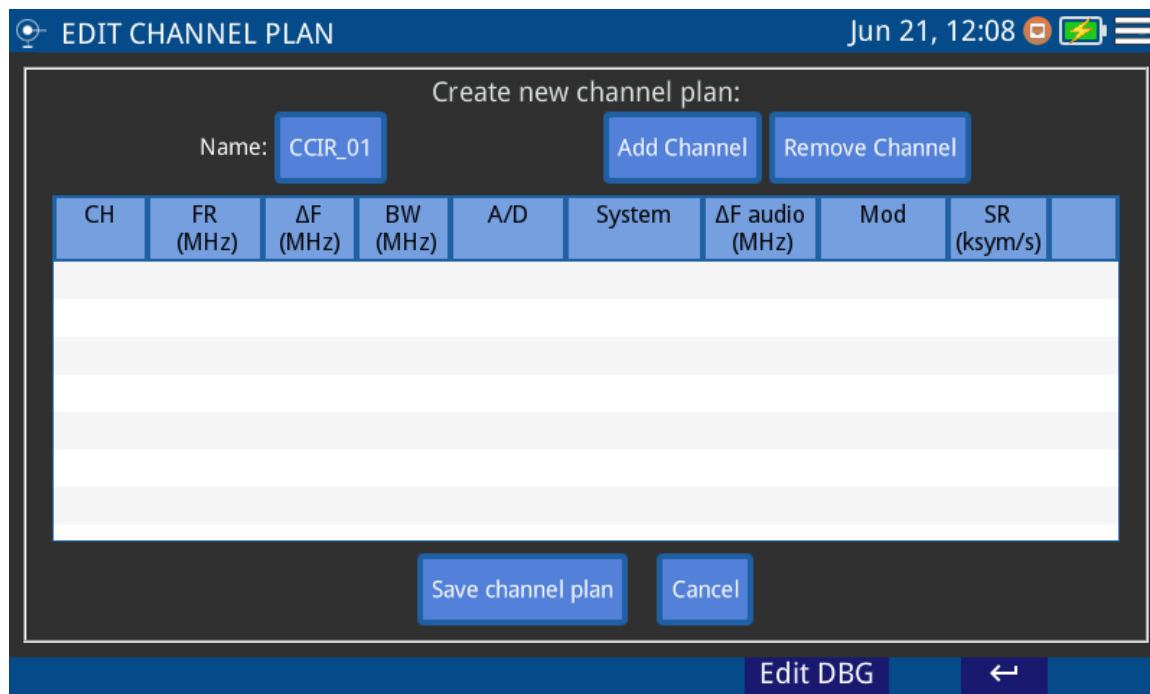

Figure 21.

- 1 Press on box "Name" to give a name to the new channel plan.
- 2 At the next screen, press on "Add Channel", "Remove Channel" to edit channel plan. When finish, press on "Save channel plan" to save changes or "Cancel" to exit without saving.

4.2 Screenshot

► **Description**

It saves a screenshot of current screen that can be downloaded to a USB flashdrive.



► **Operation**

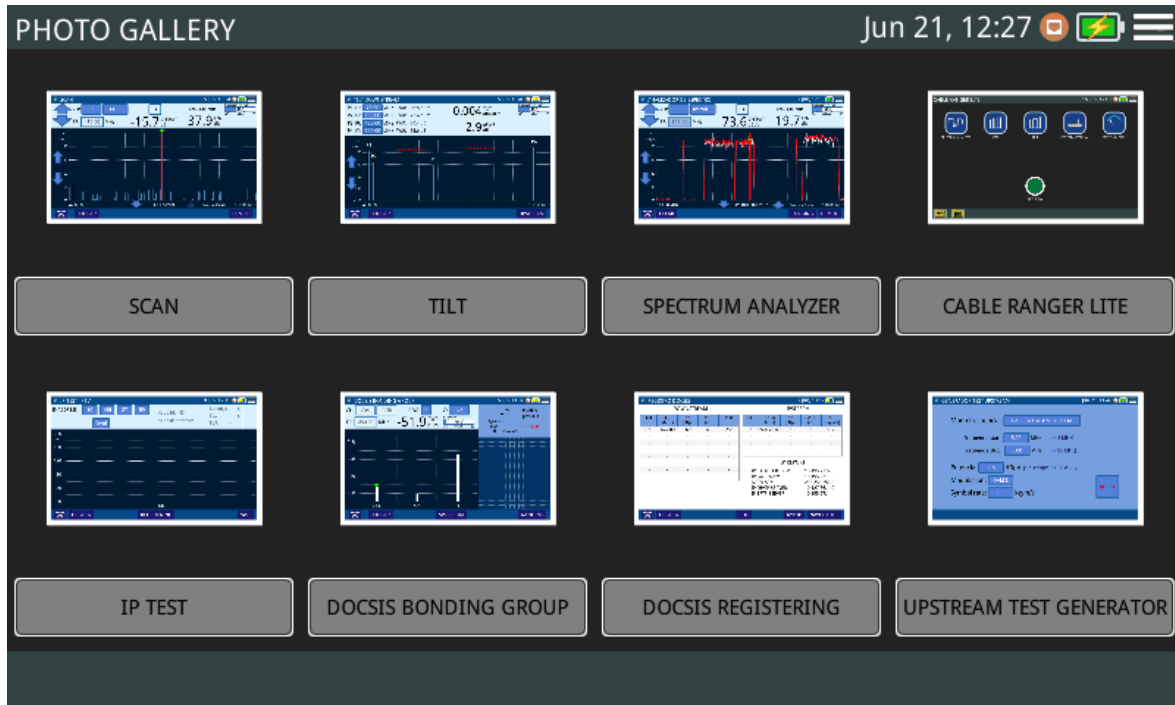





Figure 22.

Screenshot is available almost for all functions.

- 1 To take a screenshot press on photo camera icon  at the lower left corner.
- 2 It pops up a window with a screenshot miniature and some options: "Save and close", "Save and go to gallery" and "Cancel". Press your option.
- 3 To access the photo gallery with all the screenshots, from home screen press on icon  at the lower left corner.
- 4 Inside Photo Gallery, screenshots are classified by function.
- 5 Press on the corresponding folder and then on the image to view the screenshot.
- 6 To copy screenshots connect a USB flashdrive on USB port and press on menu option  and the on "Save in USB".
- 7 To remove a folder, go to the Photo Gallery, press on option menu  and then on "Remove". Now select the folder to remove and confirm.



- 8 To remove a single screenshot, see the screenshot fullscreen, press on option menu  and then on "Remove" and confirm.

4.3 Datalogger - Test & Go

► Description

Datalogger function can made and save automatically several measurements depending on the selected function, including signal level and channel power, carrier/noise, BER and MER for all channels in a specific channel band.

The Test & Go function is a shortcut in the home screen that starts a datalogger set by default in the Test&Go configuration option.

► Operation

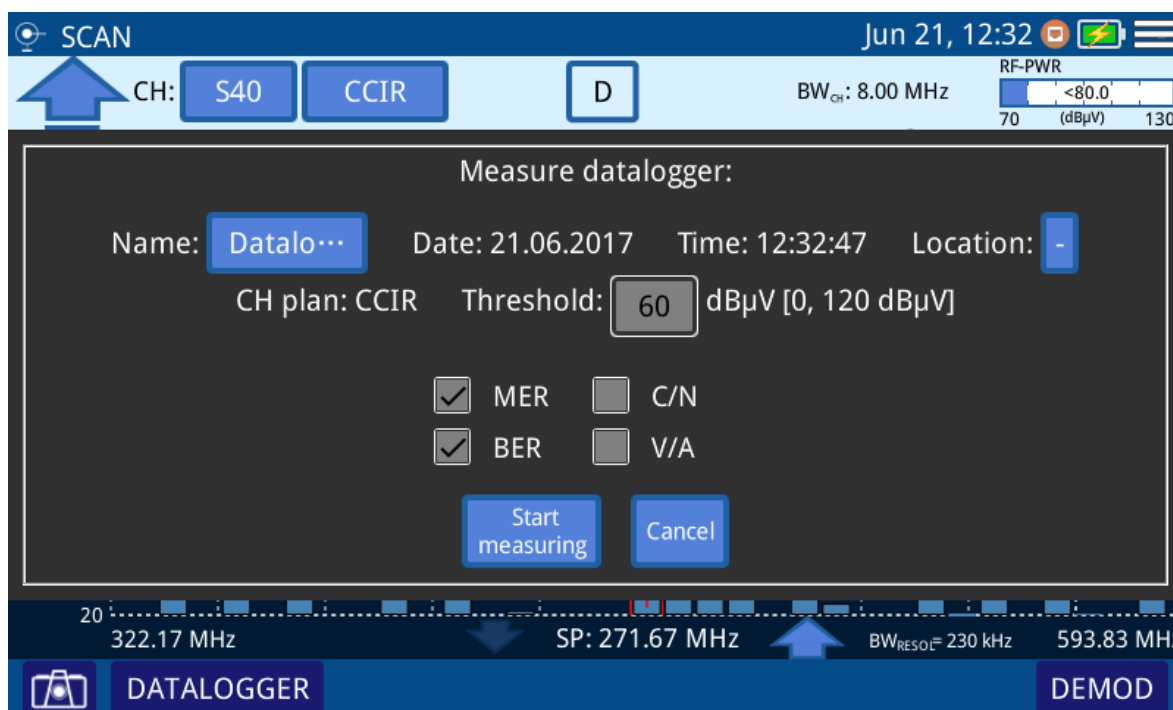





Figure 23.

- 1 To start datalogger, select a function and press on DATALOGGER at the left lower corner screen.
- 2 You can also press on "Test & Go" at the home screen. In this case you must select the datalogger by default through the option Test&Go configuration from the settings menu in the main screen.



- 3 A window opens with several setting options. You can edit boxes (name, location, threshold...) when pressing on it. Check the box to select measurements and press on "Start Measuring" or "Cancel".
- 4 It starts datalogger.
- 5 After finish, press on "Save and close", "Save and go to datalogger" or "Cancel".
- 6 To access datalogger library, go to home screen and press on  icon at the lower left corner.
- 7 In the library each datalogger is classified by function.
- 8 Press on any folder, then press on the specific datalogger to see data.
- 9 To remove a folder with dataloggers or a single datalogger, press on the menu option  and then on "Remove". It shows a window where to select a folder or datalogger to remove. Select and accept.
- 10 To copy a folder with dataloggers or a single datalogger to a USB memory in first place insert a USB memory in the USB slot. Press on menu option  and then press on "Save on USB". It shows a window with the path where are the files to be copied. Confirm to save.



5 SPECIFICATIONS

5.1 Spectrum Analyzer

► Frequency

Parameter	Value	Additional Data
Tuning Range	From 5 to 2700 MHz	
Tuning Mode	By frequency or by channel	
Bandwidth resolution	230 kHz, 2 MHz	
Frequency Tuning Resolution	10 kHz	
Accuracy	20 ppm	
Sweep time	600 ms full band	

► Amplitude

Parameter	Value	Additional Data
Measuring range	-50 dBmV to 60 dBmV	
Measuring range in screen	50 dB	
Max Input level	70 dBmV	
Resolution	0.1 dB	
Accuracy	± 2 dB	
Input impedance	75 Ohms	
Units	dBmV, dBuV, dBm	

► Frequency Tuning Mode

Parameter	Value	Additional Data
Level	- 50 dBmV to 60 dBmV	Peak detector level measurement from marker
Audio demodulation	Analog FM	
C/N	>50 dB for level >10 dBmV	Selectable noise frequency marker
HUM	1-15 % , ± 1 % accuracy	For FM or CW carriers

► DIGITAL Spectrum Analyzer (Cable and Terrestrial)

Parameter	Value	Additional Data
Tuning Range	From 10 to 2700 MHz	
Power	From -40 dBmV to 60 dBmV	Power measurement in the channel bandwidth by integration method
Compatibility	DVB-C/C2/T/T2, I.J43 Annex B, ISDBT, J.382	
SR	1000-7000 ksym/s	
MER	From 24 dB to 43 dB for QAM16, 32, 64, 128, 256 and QPSK	Accuracy ± 2 dB
BER	Pre BER (Before RS): From 10 E-2 to 10 E-10	Post BER (After FEC): From 10 E-2 to 10 E-10
Constellation Diagram	DVB-C/C2/T/T2, I.J43 Annex B, ISDBT, J.382	



Parameter	Value	Additional Data
Lock range	-20 dBmV to 60 dBmV	

► ANALOG Spectrum Analyzer

Parameter	Value	Additional Data
Tuning Range	From 10 to 2700 MHz	
Video Carrier Signal Level	From -45 dBmV to 60 dBmV	
Audio Carrier signal level, A/V	0- 30 dB (for PAL, SECAM or NTSC standard)	
C/N	48 dB for input level > 10 dBmV	
HUM (over audio carrier)	1-15%, 1% accuracy	
CTB/CSO	60 dB dynamic range. (In channel with removed carrier or out of channel selecting a not used channel)	± 3 dB accuracy
Sound	broadcast FM demodulation from internal speaker	

► DOCSIS

Parameter	Value	Additional Data
Dowstream Analyzer:		
Power and Spectrum	DOCSIS 2.0/3.0/3.1	
MER / BER	DOCSIS 2.0/3.0/3.1	(MER estimated in 3.1)
Constellation	DOCSIS 2.0/3.0	
DBG Tuning	16 x 8 channels	
Upstream Analyzer	5 - 200 MHz	

► SATELLITE Spectrum Analyzer

Parameter	Value	Additional Data
Tuning Range	950 - 2150 MHz	
Spectrum and Power	DVB-S/S2	
MER / BER	DVB-S/S2	
Constellation	DVB-S/S2	
LNB Supply	12 / 15 / DiSEqC	

► Configuration Menu

Parameter	Value	Additional Data
Channel Plan	Yes	
Standard TV Channel plans	CCIR,EIA,HRC,IRC,OIRL,FCC up to 10	
Customized Channel plan	Up to 30	
Units	dBmV, dBuV, dBm	
Reference Line	from -60 dBmV to 60 dBmV	
Trace	normal, max hold and min hold	
Frequency step	from 10 kHz to 100 MHz	
Top Frequency	900 MHz, 1800 MHz or selectable	



5.2 Scan

► Frequency

Parameter	Value	Additional Data
Tuning Range	Full frequency band occupied by selected Channel plan	
Tuning Mode	by channel	
Bandwidth resolution	230 kHz	

► Amplitude

Parameter	Value	Additional Data
Dynamic range	-50 dBmV to 60 dBmV	
Screen range:	50 dB	
Max Input level:	70 dBmV	
Resolution:	0.1 dB	
Accuracy:	± 2 dB	
Input impedance:	75 Ohms	
Units:	dBmV, dBuV, dBm	

► Measurements: DIGITAL Channel

Parameter	Value	Additional Data
Power	From -40 dBmV to 60 dBmV	Power measurement in the channel bandwidth by integration method at the marker. Represented by vertical blue bars

► Channel Demodulation

Parameter	Value	Additional Data
Compatibility	DVB-C/C2/T/T2, I.J43 Annex B, ISDBT, J.382	
SR	1000-7000 ksym/s	
MER	From 24 dB to 43 dB for QAM16,32,64,128,256 and QPSK	Accuracy ± 2 dB
BER	Pre BER (Before RS): From 10 E-2 to 10 E-10	Post BER (After FEC): From 10 E-2 to 10 E-10
Constellation Diagram	DVB-C/C2/T/T2, I.J43 Annex B, ISDBT, J.382	
Lock range	-20 dBmV to 60 dBmV	

► Measurements: Analog TV Channel

Parameter	Value	Additional Data
Video Carrier Signal Level	From -45 dBmV to 60 dBmV	Represented by vertical white bars



► Channel Demodulation

Parameter	Value	Additional Data
Audio Carrier signal level, A/V	0- 30 dB (for PAL, SECAM or NTSC standard)	
C/N	48 dB for input level > 10 dBmV	
HUM (over audio carrier)	1-15%, 1% accuracy	
CTB/CSO	60 dB dynamic range. (In channel with removed carrier or out of channel selecting a not used channel)	± 3 dB accuracy
Sound	broadcast FM demodulation from internal speaker	

► Configuration Menu

Parameter	Value	Additional Data
Channel Plan	Yes	
Standard TV Channel plans	CCIR,EIA,HRC,IRC,OIRL,FCC up to 10	
Customized Channel plan	Up to 30	
Units	dBmV, dBuV, dBm	
Reference Line	from -60 dBmV to 120 dBmV	
Units	dBmV, dBuV, dBm	
Reference Line	from -60 dBmV to 120 dBmV	
Thresholds	Max and Min limits for quality evaluation	

5.3 Tilt

► Downstream

Parameter	Value	Additional Data
Frequency:	Four selectable tuning frequencies (pilots) from 45 MHz to 1700 MHz	
Bandwidth resolution	230 kHz	
Frequency Tuning resolution	10 kHz	
Dynamic range	-50 dBmV to 60 dBmV	
Screen range	50 dB	
Max Input level	70 dBmV	
Resolution	0.1 dB	
Measurements	Level of four selected frequencies	±0 to 30 dB/ MHz (Tilt) between two selected pilots
Resolution	0.1 dB	

► Upstream

Parameter	Value	Additional Data
Frequency:	Four selectable tuning frequencies (pilots) from 45 MHz to 1700 MHz	



Parameter	Value	Additional Data
Bandwidth resolution	230 kHz	
Tuning resolution	10 kHz	
Dynamic range	-50 dBmV to 60 dBmV	
Screen range	50 dB	
Max Input level	70 dBmV	
Resolution	0.1 dB	
Measurements	Level of four selected frequencies	± 0 to 30 dB/ MHz (Tilt) between two selected pilots
Resolution	0.1 dB	

► Configuration Menu

Parameter	Value	Additional Data
Units	dBmV, dBuV, dBm	
Select two pilots for Tilt	Pbottom / Ptop	

5.4 Input Voltage and RF Power Meter

► RF Power Measurement

Parameter	Value	Additional Data
Frequency band	5-1700 MHz	
Power accuracy:	± 3 dB	

► Input Voltage Measurement

Parameter	Value	Additional Data
VDC	5 - 100 V	
VAC	1 - 30 V	
Frequency measurements	from 10 Hz to 200 Hz,	± 2 % accuracy
LNB Supply Voltage	13 V, 18 V, 13 V + 22 kHz, 18 V + 22 kHz	

► Configuration Menu

Parameter	Value	Additional Data
Units:	dBmV, dBuV, dBm	



5.5 General Specifications

► Inputs and Outputs

Parameter	Value	Additional Data
RF	Interchangeable F, BNC, IEC	
Optical	Yes	
USB	Available	USB type A female
Ethernet	Available	
VDC	Available	
Touch Monitor Display	Available	

► Mechanical Features

Parameter	Value	Additional Data
Dimensions	177 x 117 x 30 mm	
Weight	0.7 kg	

► Power Supply

Parameter	Value	Additional Data
Internal battery	7,2 V; 3 Ah Li-Po	
Battery Operation Time	> 4 hours in continuous mode	
Recharging Time	3 hours up to 80% (turned off)	
External Voltage	12 V DC	
Consumption	12 W	
Auto Power Off	Available	

► Operating Environmental Conditions

Parameter	Value	Additional Data
Altitude	Up to 2.000 m	
Temperature range	From 5°C to 40°C	
Max. Relative Humidity	80 %	up to 31°C, decreasing lineally up to 50% at 40°C

NOTE: Equipment specifications are set in these environmental operating conditions. Operation outside these specifications are also possible. Please check with us if you have specific requirements.

► Included Accesories

Parameter	Value	Additional Data
	DC Adapter, DC car adapter, F connector (2), transport case, suitcase, Quick reference guide	



6 MAINTENANCE

6.1 Instructions for Returning by Mail

Instruments returned for repair or calibration, either within or out of the warranty period, should be sent with the following information: Name of the Company, name of the contact person, address, telephone number, receipt (in the case of coverage under warranty) and a description of the problem or the service required.

6.2 Considerations about the TFT Screen

This paragraph offers key considerations regarding the use of the colour screen, taken from the specifications of the manufacturer.

In the TFT screen, the user may find pixels that do not light up or pixels that are permanently lit. This should not be regarded as a defect in the TFT. In accordance with the manufacturer quality standard, 9 pixels with these characteristics are considered admissible.

Pixels which are not detected when the distance from the surface of the TFT screen to the human eye is greater than 35 cm, with a viewing angle of 90° between the eye and the screen should not be considered manufacturing defects either.

It is advisable a viewing angle of 15° in the 6.00 o'clock direction in order to obtain the optimum visualization of the screen.

6.3 Cleaning Recommendations

The equipment consists of a plastic case and a TFT screen. Each element has its specific cleaning treatment.

► Cleaning the TFT Screen

The TFT screen surface is VERY DELICATE. It has to be cleaned with a soft fabric cloth (cotton or silk), always making the same move from left to right and from top to bottom, without putting pressure on the screen.

The TFT screen has to be dry-cleaned or with a product specifically designed for TFT screens, by slightly dampening the cloth. NEVER use tap or mineral water, alcohol or conventional cleaning products, because they contain components that can damage the screen.

Turn off the equipment to locate dirt on the screen. After cleaning, wait a few seconds before turning on.

**► Cleaning the Plastic Case**

The equipment has to be disconnected before cleaning the case.

The case must be cleaned with a solution of neutral soap and water, using a soft cloth dampened with this solution.

Before use, the equipment has to be completely dry.

Never clean with abrasive soaps, chlorinated solvents or aromatic hydrocarbons. These products may degrade the case.



PROMAX ELECTRONICA, S.L.