

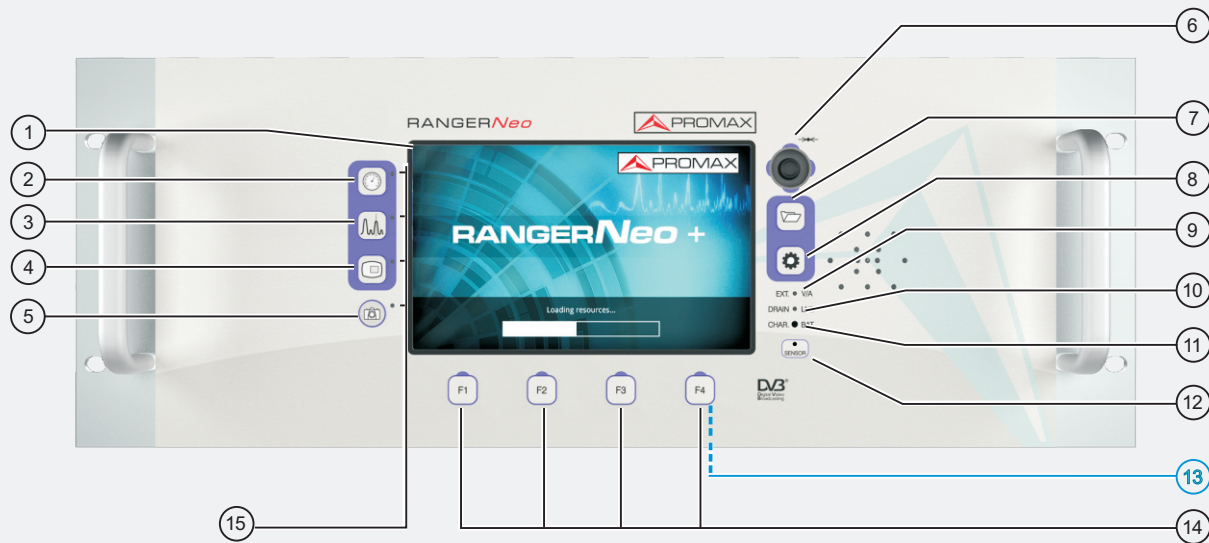

Trademark of the DVB - Digital Video Broadcasting Project

FRONT VIEW



- | | | |
|---|--|------------------------------------|
| ① TFT screen | ⑥ Joystick | ⑪ Battery charging indicator |
| ② Measurement key | ⑦ Installations management key | ⑫ Light sensor |
| ③ Spectrum key | ⑧ Settings key | ⑬ Reset (press and hold 5s) |
| ④ TV Key | ⑨ External Video/Audio Input indicator | ⑭ Softkeys |
| ⑤ Export (press>1s)
Reference (press<1s) | ⑩ External unit power supply indicator | ⑮ Active Function indicator |

SCREEN ICONS REFERENCE

STATUS BAR

- Battery charging**
- Battery not charging**, time left indicator
- Battery not charging**. Yellow level indicates charge left
- Satellite band**
- Current voltage, 22 kHz signal and LNB power level
- Terrestrial band**
- USB flash drive inserted**
- WIFI signal source**
- Current installation**
- Compressed installation**
- SatCR** (SCD/EN50494) commands enabled
- JESS** (SCD2/EN50607) commands enabled
- Joystick multi-function enabled**
Two-letter code indicates the exact function:
 - FR** Frequency tuning
 - CH** Channel tuning
 - SP** SPAN change
 - MK** Marker moving
 - EC** Echo change/zoom
 - AP** Access Point change

Task scheduled

SERVICE LIST SELECTOR

- Digital TV service**
- High Definition TV service**
- Digital radio**
- Data**
- Scrambled service**

DIALOG BOXES

- Error message**
- OK message**
- Question message**
- Warning message**

VIDEO & AUDIO SETTINGS MENU

- TFT backlight brightness
- Volume

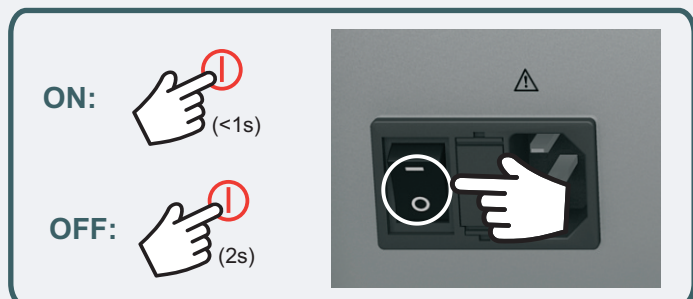

RF ► SETTINGS

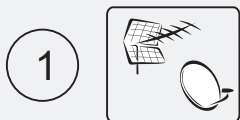

2

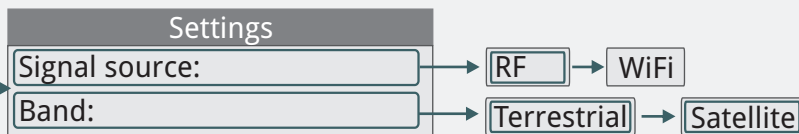

RF ► SCREENS

► MEASUREMENT

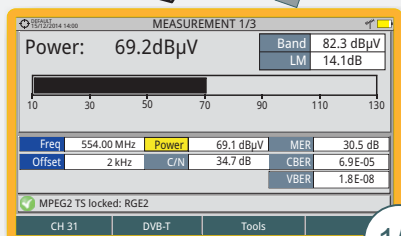
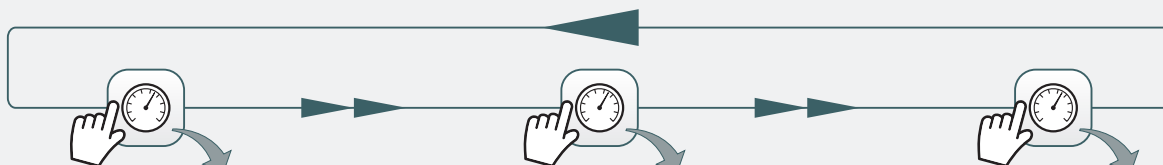

FULL MEASUREMENT

1/3

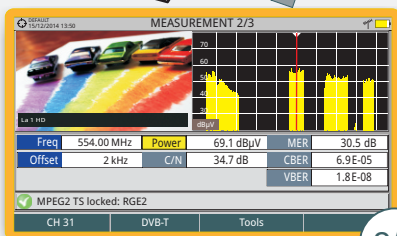

MEASUREMENT + TV + SPECTRUM

2/3

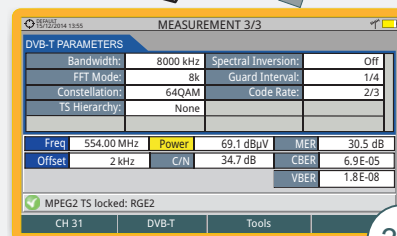

MEASUREMENT + PARAMETERS

3/3

► SPECTRUM ANALYSER

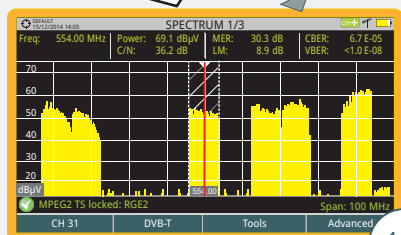

SPECTRUM + MEASUREMENT

1/3

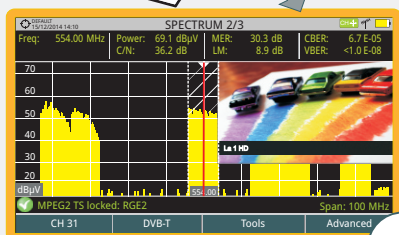

SPECTRUM + MEASUREMENT + TV

2/3

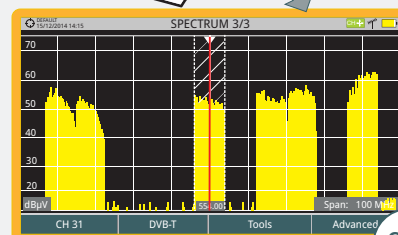

FULL SPECTRUM

3/3

TV MODE

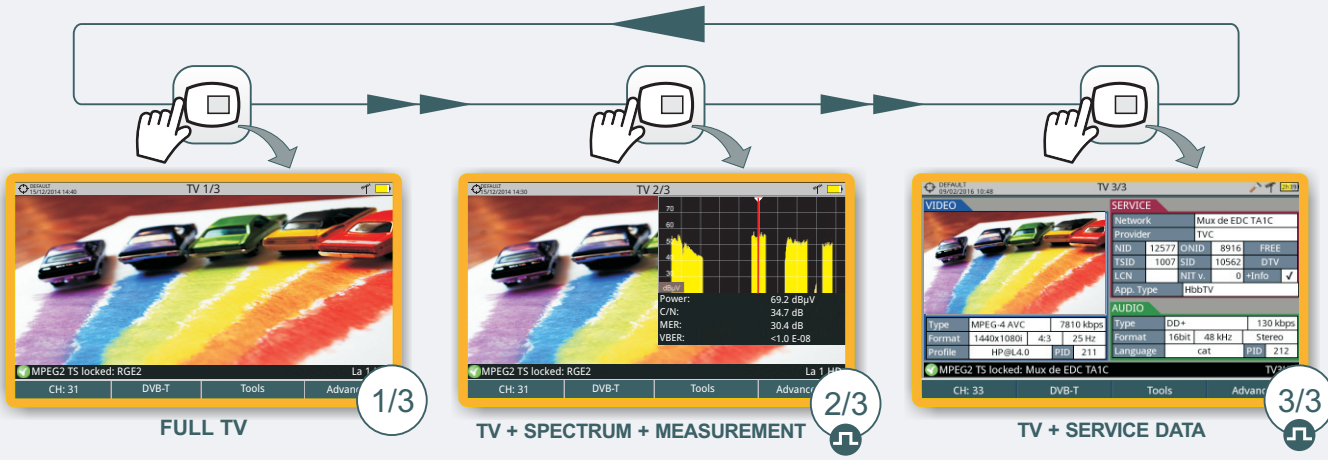

RF MENUS

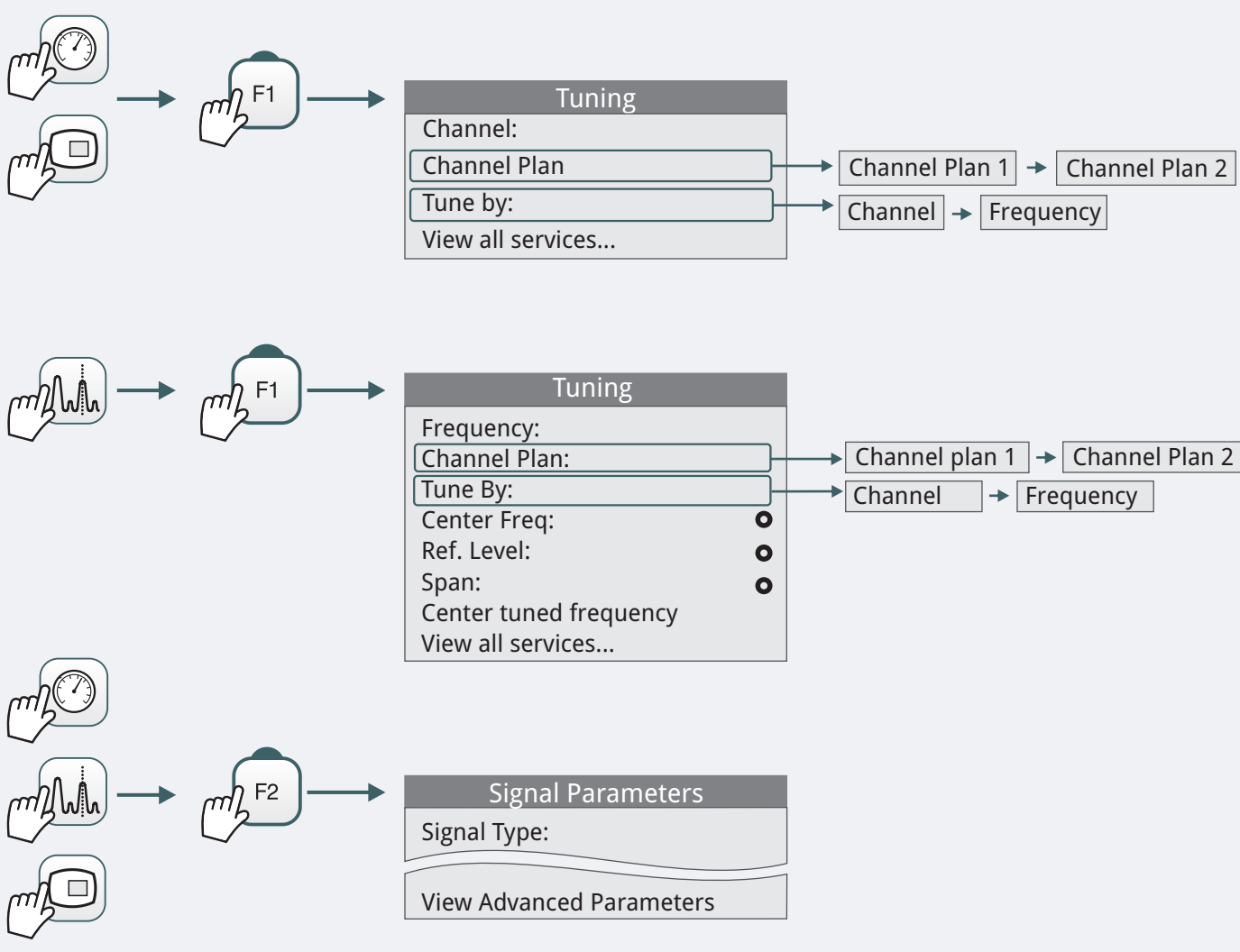

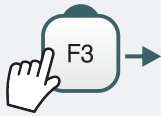

Tools

- Select Service...
- Signal Monitoring
- Explore Channel Plan
- Discover FM Stations
- Field Strength:
- Datalogger
- Echoes
- Constellation
- MER by carrier
- LTE Ingress Test
- Attenuation Test
- Task Planner...
- Merogram
- Spectrogram
- Wi-Fi Configuration
- Analogue Input

Off → On

New... → Test & Go → DL00

Antenna → External



Advanced

- Average:
- Spectrum Line:
- Tone Level:
- Marker:
- Marker Trace:
- Max.Hold:
- Min.Hold:
- Persistence:
- Detector Type:
- Resolution Bandwidth:
- Vertical Range:
- Dashed BW:
- Reference:

Outline → Solid → Transparency

Off → On

Off → On

Normal

Off → Permanent → Curtain

Off → Permanent → Curtain

Off → On

PEAK → RMS

100 kHz → 200kHz → 1000 kHz

10 dB/div → 5 dB/div → 2 dB/div → 1 dB/div

Off → On

Set → Clear

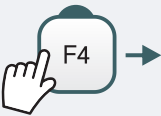
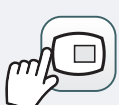

Advanced

- Audio:
- Discovered URLs:
- TS Data:
- Aspect Ratio

4:3 → 16:9

WIFI ► SETTINGS

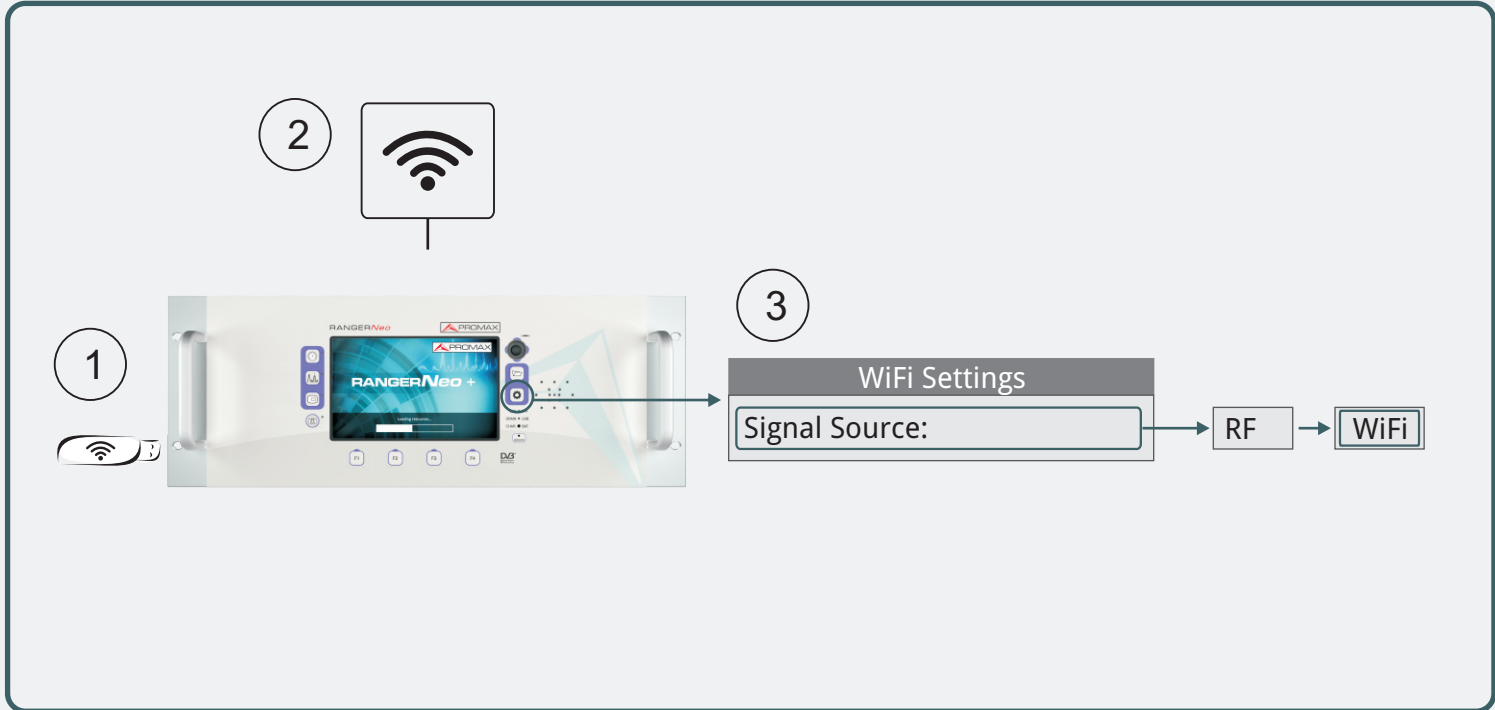

WIFI ► SCREENS

► SITE SURVEY

PROMAX 22/12/2016 12:10		SITE SURVEY						
SSID	BSS	CH	RSSI(dBm)	Security	Device			
JAZZTEL	01:23:45:67:89:ab	1	-86	WPA	Wireless Router...			
MOVISTAR	aa:bb:cc:dd:ee:ff	2	-72	WPA2	WAP6969N			
YACOM	98:76:54:32:10:fe	3	-84	WPE				
YOIGO	a1:b2:c3:d4:e5:f6	4	-74	Ninguno				
ORANGE	22:44:66:88:ab:cd	5	-70	WPA				
VODAFONE	13:57:92:46:80:31	6	-88	WPA				
ARRAKIS	ca:ac:ed:de:fb:bf	7	-78	WPA				
TELEFONICA	57:26:21:44:a6:89	8	-76	WPA				
TERRA	11:85:e5:74:0c:53	9	-80	WPA				
WANADOO	b4:07:32:41:a6:1c	10	-82	WPA				

CH 1 | Advanced



WIFI SPECTRUM

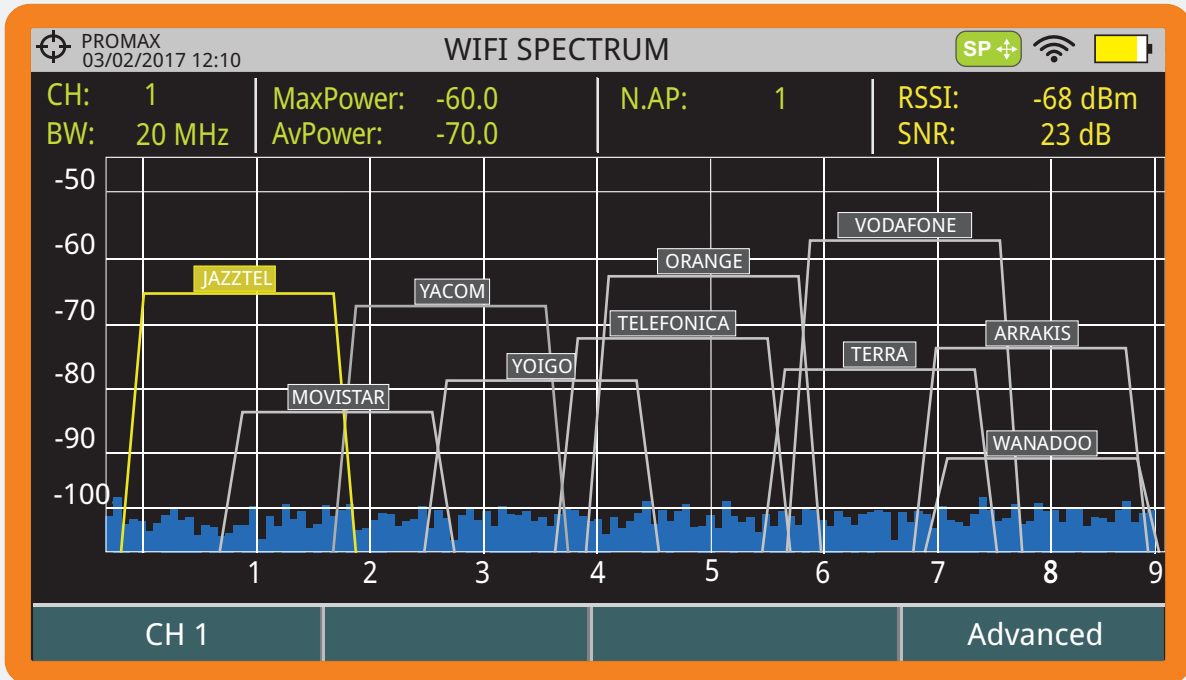

WIFI MENUS

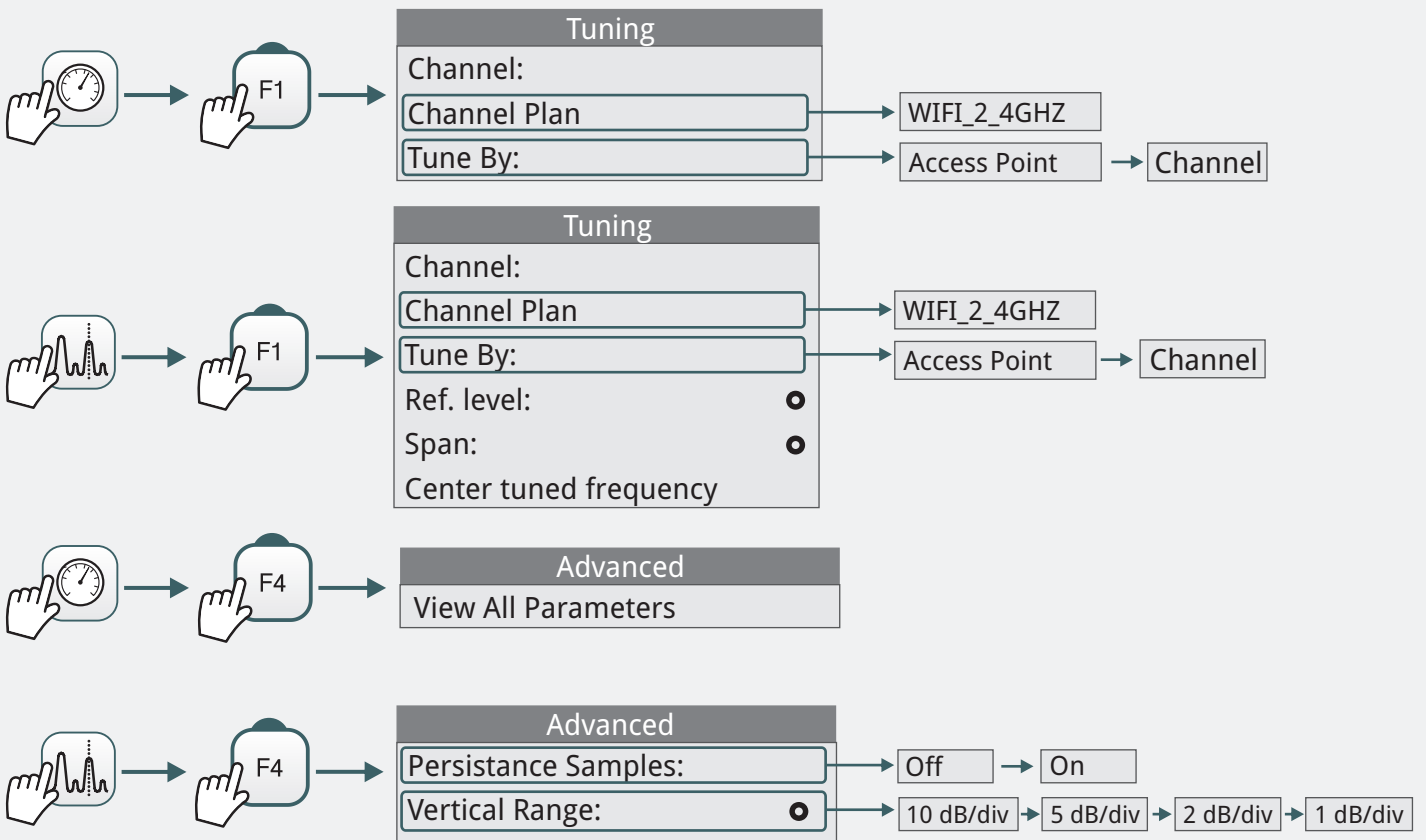

SETTINGS MENU

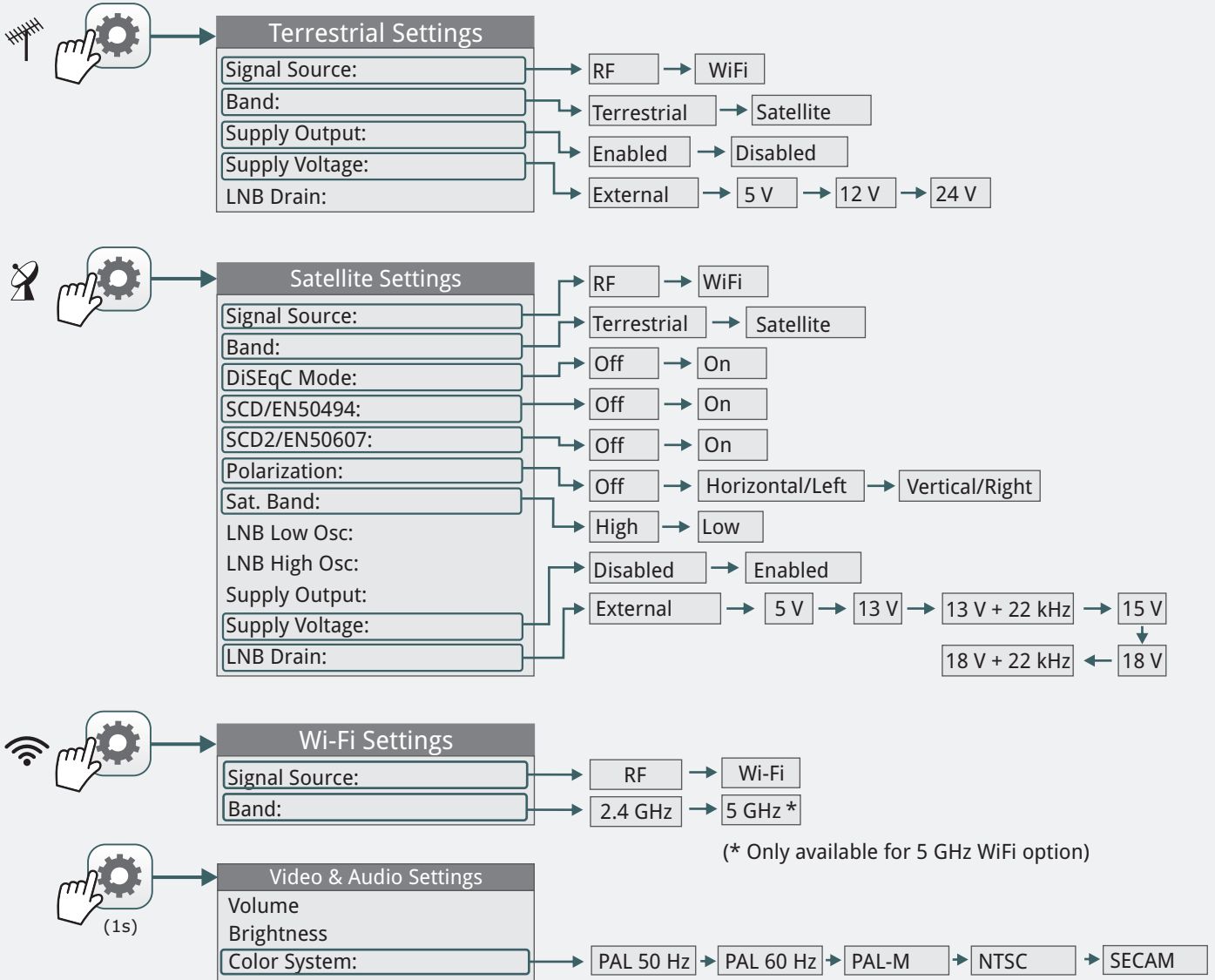

PREFERENCES MENU

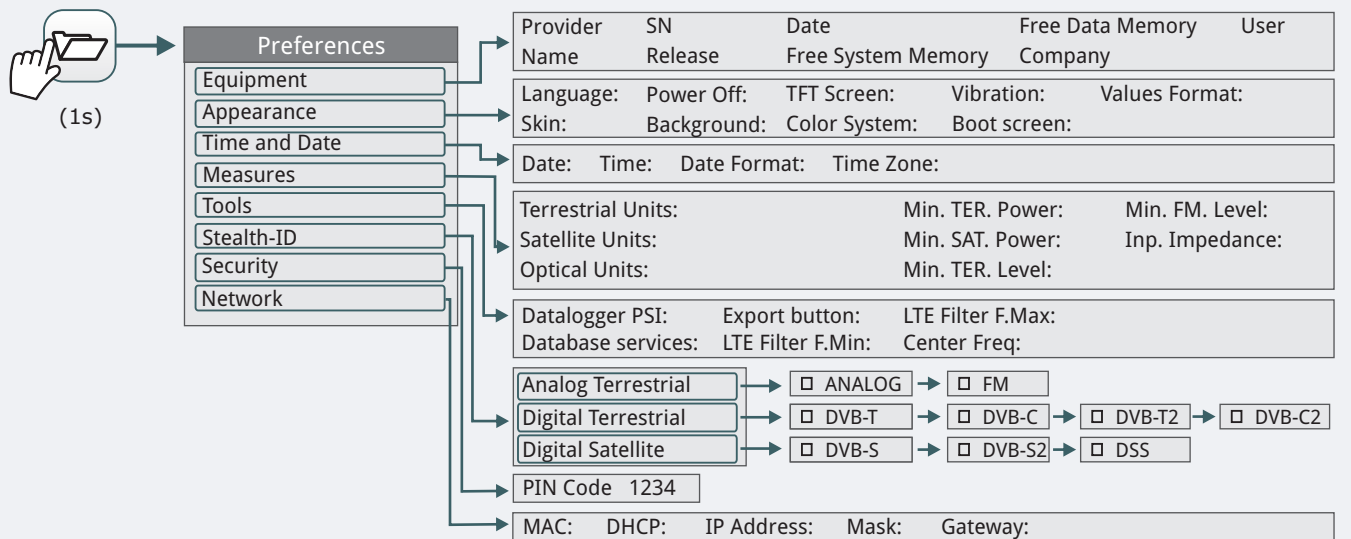

INSTALLATION MANAGEMENT

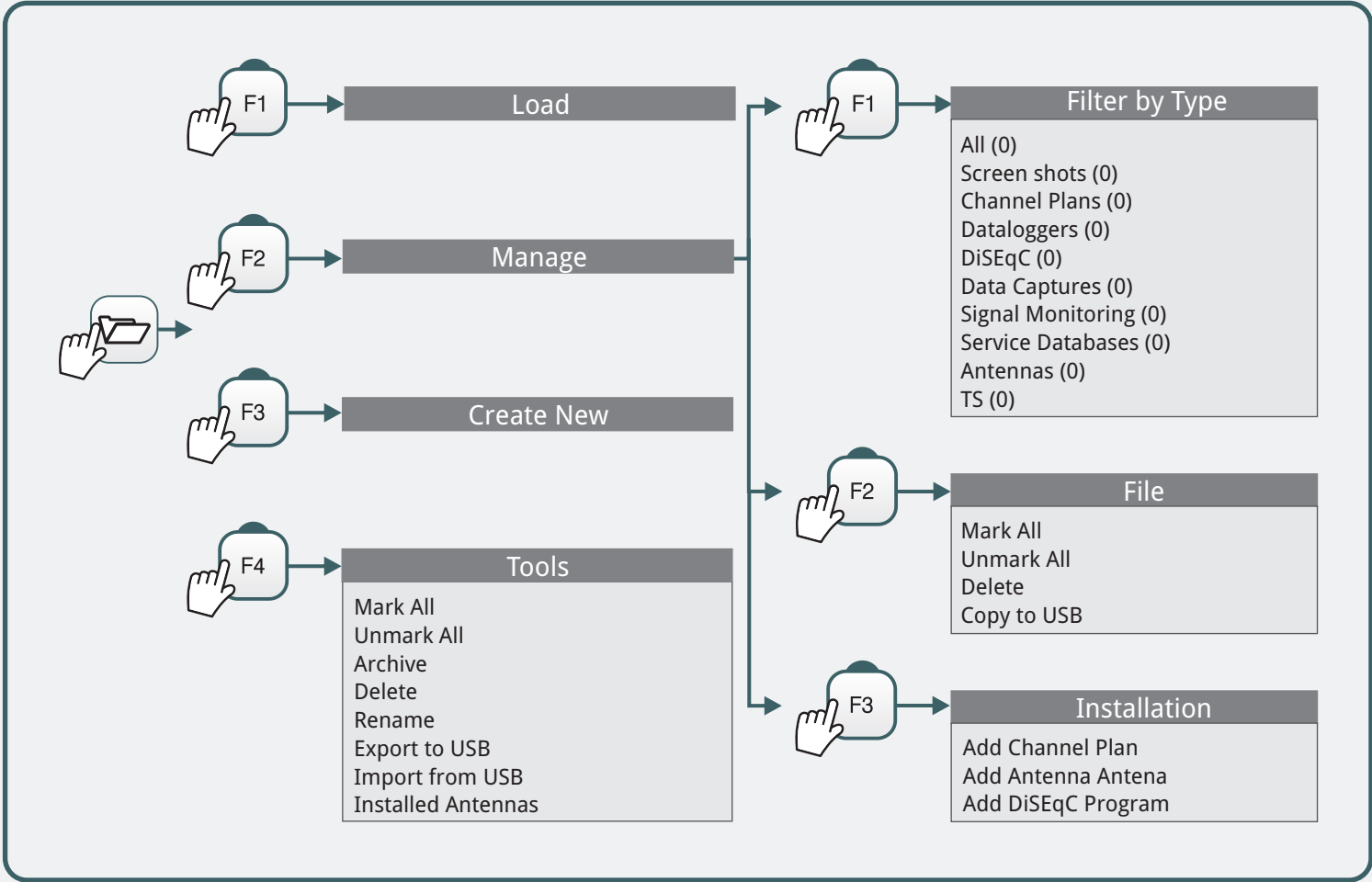

EXPORT* IMAGE / DATA / SPECTRUM

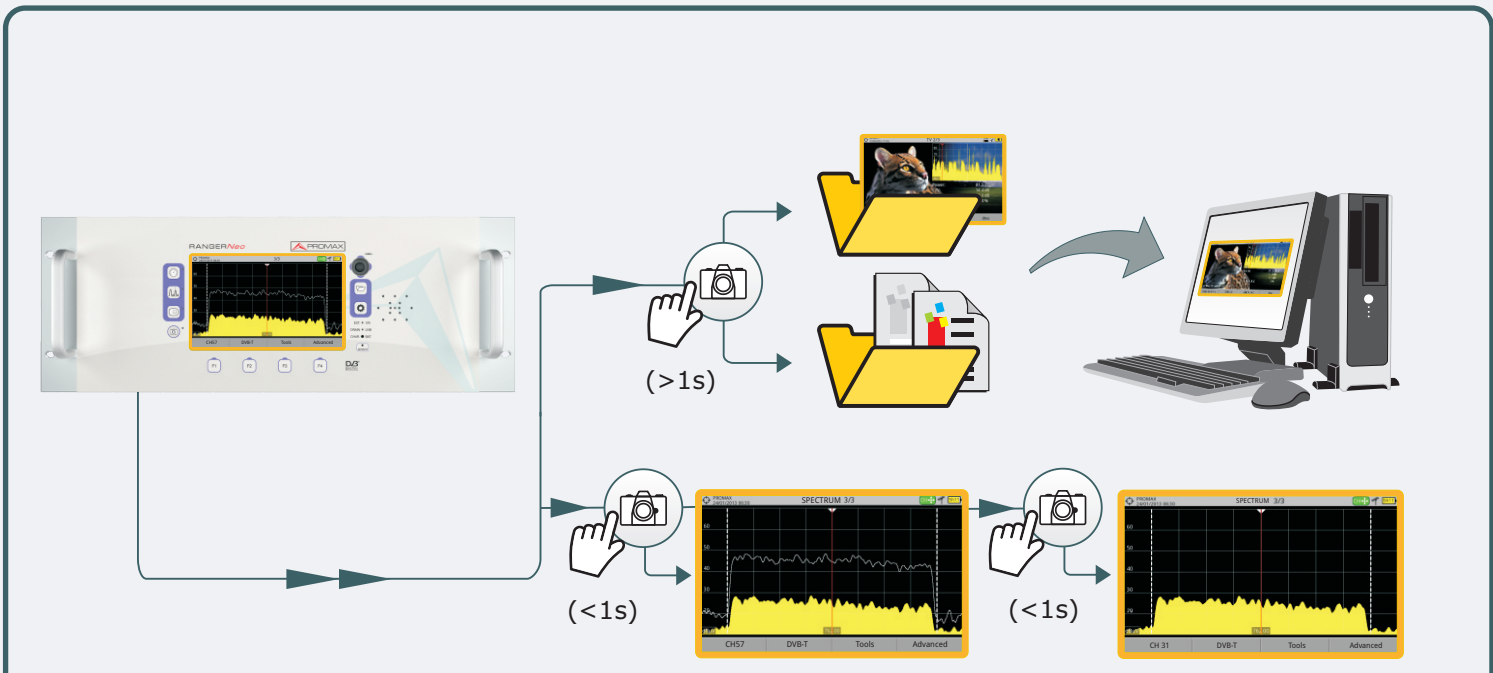

*Export settings in Preferences



▶ JOYSTICK

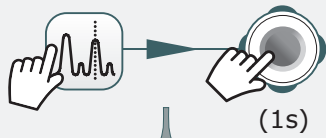

(1s)

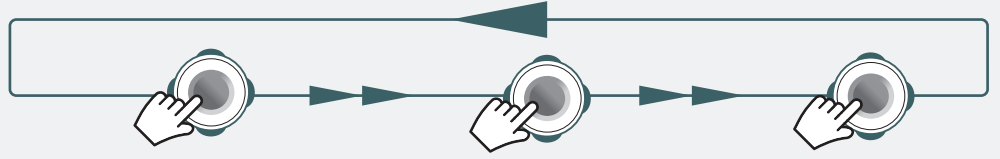
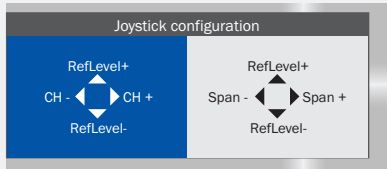

AP
Access Point
change



FR
Frequency
tuning



CH
Channel
tuning



SP
SPAN
Change



MK
Marker moving
(Marker ON)

PARAMETER EDITION

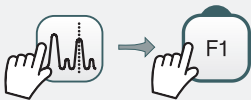

Tuning	
Channel:	44
Channel Plan	CCIR ▶
Tune By:	Channel ▶
Center Freq:	658.00 MHz ●



x3

Tuning	
Channel:	44
Channel Plan	CCIR ▶
Tune By:	Channel ▶
Center Freq:	658.00 MHz ●



Tuning	
Channel:	44
Channel Plan	CCIR ▶
Tune By:	Channel ▶
Center Freq:	658.00 MHz ●



Tuning	
Channel:	44
Channel Plan	CCIR ▶
Tune By:	Channel ▶
Center Freq:	658.00 MHz ●



Tuning	
Channel:	44
Channel Plan	CCIR ▶
Tune By:	Channel ▶
Center Freq:	658.10 MHz ●



Tuning	
Channel:	44
Channel Plan	CCIR ▶
Tune By:	Channel ▶
Center Freq:	658.10 MHz ●

PARAMETER SELECTION



Advanced	
Average	0 ●
Spectrum Line	Outline ◿



Advanced	
Average	0 ●
Spectrum Line	Outline ◿



Advanced	
Average	0 ●
Spectrum Line	Outline ◿
	Outline
	Solid
	Trans.



Advanced	
Average	0 ●
Spectrum Line	Outline ◿
	Outline
	Solid
	Trans.



Advanced	
Average	0 ●
Spectrum Line	Solid ◿



TOUCH SCREEN

MENU SELECTION

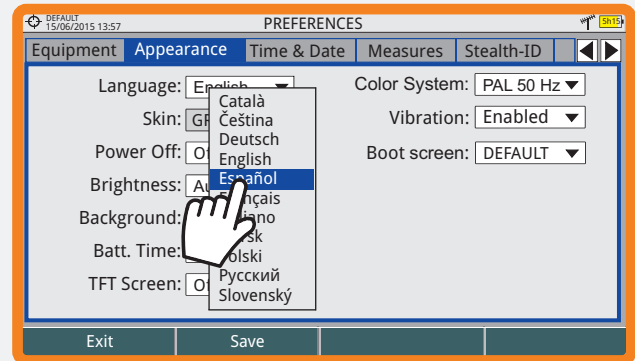
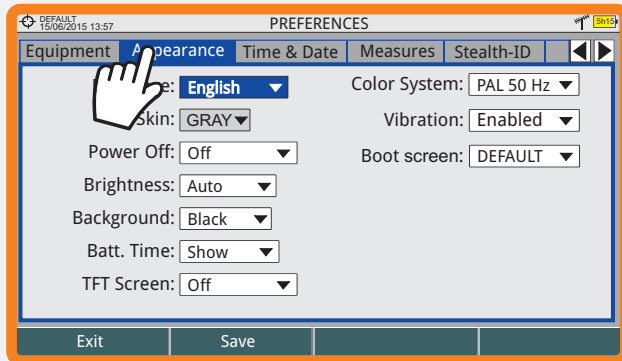

FREQUENCY SELECTION

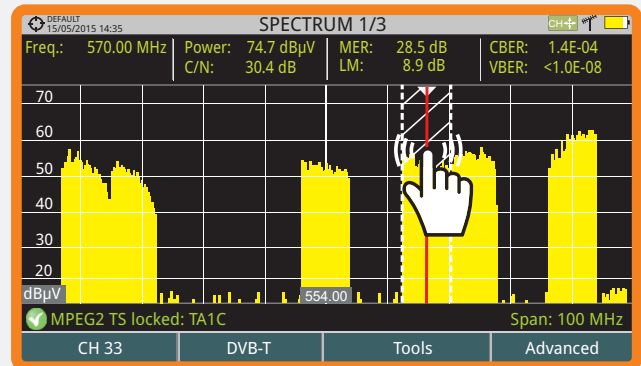
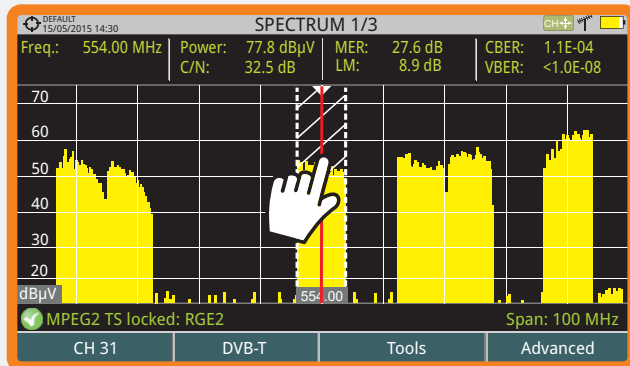



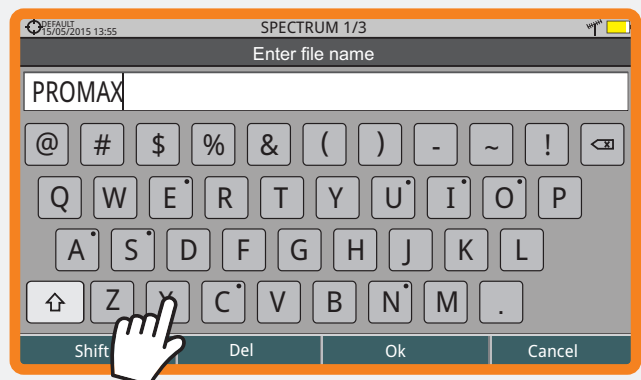
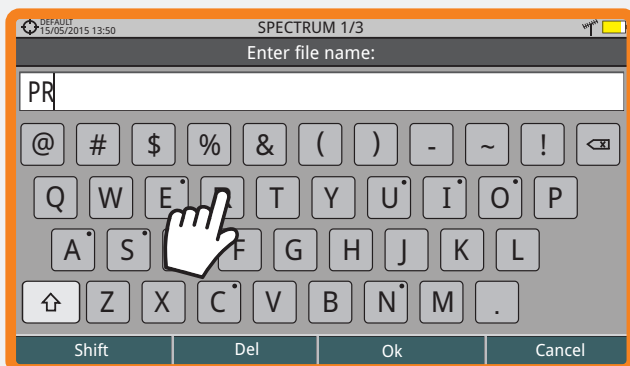



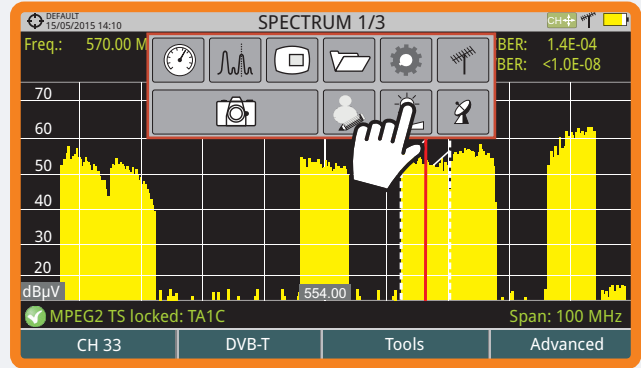
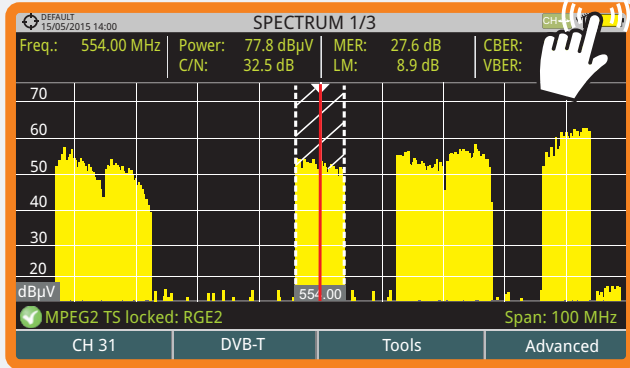



VIRTUAL KEYBOARD WRITING



TOOLBAR



TOOLBAR ICONS

-  Measurement Mode
-  Settings
-  Video & Audio Settings
-  Spectrum Analyser Mode
-  Terrestrial Band
-  Preferences
-  TV Mode
-  Satellite Band
-  Screen Capture
-  Installations Management

MODE SCREENS

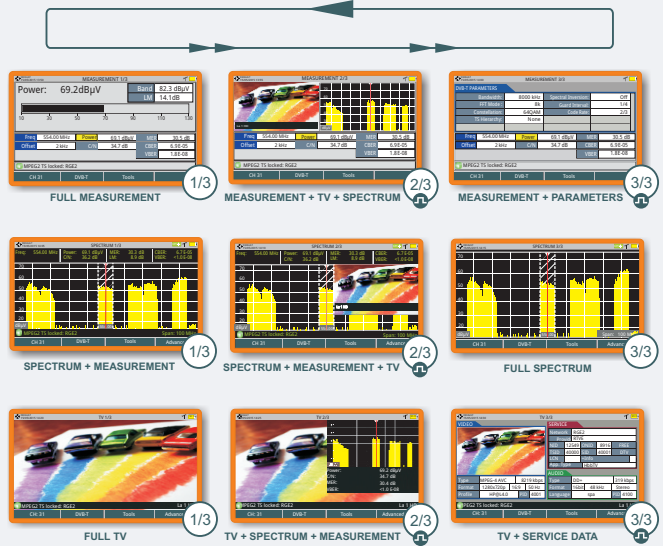
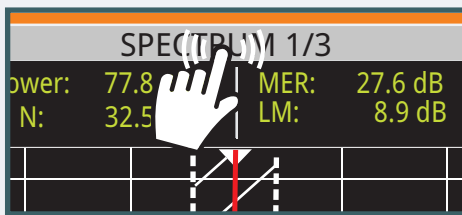

INSTALLATIONS MANAGEMENT

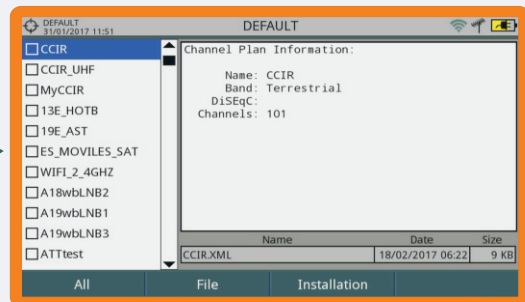
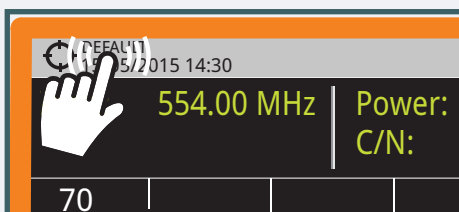

REAR VIEW



- 16 Power input connector
- 17 ON / OF slide switch
- 18 Fuse holder
- 19 RF input connector

SIDE VIEW

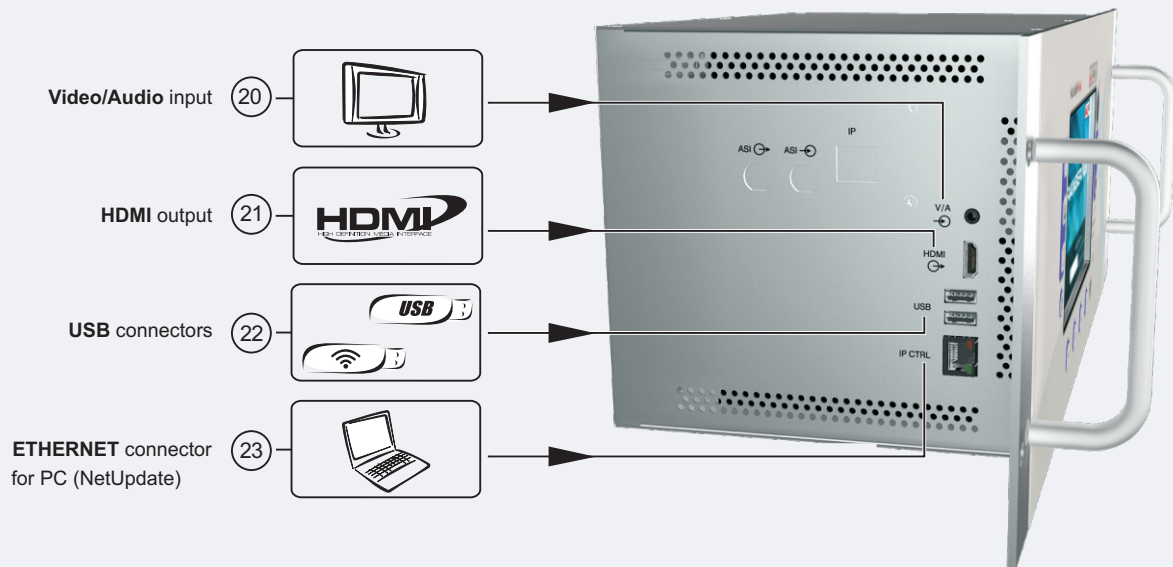

RESET

If the device crashes, press the ON/OFF button for 10 seconds. If the device does not respond then press the F4 key for 6 seconds and then release to reset (see user's manual for more information).