

# RANGER *Neo 2* ATSC

## TV & SATELLITE ANALYZER



- 0 MI2141 -



**Test Equipment  
Depot**  
1-800-517-8431

99 Washington Street  
Melrose, MA 02176  
Phone 781-665-1400  
Toll Free 1-800-517-8431

Visit us at [www.TestEquipmentDepot.com](http://www.TestEquipmentDepot.com)

## SAFETY NOTES

Read the user's manual before using the equipment, mainly "**SAFETY RULES**" paragraph.

The symbol  on the equipment means "**SEE USER'S MANUAL**". In this manual may also appear as a Caution or Warning symbol.

**WARNING AND CAUTION** statements may appear in this manual to avoid injury hazard or damage to this product or other property.

## MULTIMEDIA CONTENT

You can access instantly to any chapter by clicking on the title of the chapter in the table of contents.

Click on the arrow  at the top right of the page to return to the table of contents.

Throughout this manual are boxes with the symbol . It identifies a direct access to an explanatory video related to the function where it is. User has to click on this icon to watch the video.

All videos are in the PROMAX channel on YouTube, which is accessible through the PROMAX website.

## USER'S MANUAL VERSION















Version	Date	Software Version
1.0	May 2017	23.4

- Please update your equipment to the latest software version available

## SAFETY RULES

- \* **The safety could not be assured if the instructions for use are not closely followed.**
- \* Use this equipment **connected only to systems with their negative of measurement connected to ground potential.**
- \* The **AL-103** external DC charger is a **Class I** equipment, for safety reasons plug it to a supply line with the corresponding **ground terminal**.
- \* This equipment can be used in **Overvoltage Category I** installations and **Pollution Degree 2** environments.  
External DC charger can be used in **Overvoltage Category II**, installation and **Pollution Degree 1** environments.
- \* When using some of the following accessories use only the specified ones to ensure safety.:
  - Rechargeable battery
  - External DC charger
  - Car lighter charger cable
  - Power cord
- \* Observe all **specified ratings** both of supply and measurement.
- \* Remember that voltages higher than **70 V DC** or **33 V AC rms** are dangerous.
- \* Use this instrument under the **specified environmental conditions**.
- \* When using the power adaptor, the **negative of measurement** is at ground potential.
- \* **Do not obstruct the ventilation system of the instrument.**
- \* Use for the signal inputs/outputs, specially when working with high levels, appropriate low radiation cables.
- \* Follow the cleaning instructions described in the Maintenance paragraph.

\* Symbols related with safety:

	DIRECT CURRENT		ON (Supply)
	ALTERNATING CURRENT		OFF (Supply)
	DIRECT AND ALTERNATING		DOUBLE INSULATION (Class II protection)
	GROUND TERMINAL		CAUTION (Risk of electric shock)
	PROTECTIVE CONDUCTOR		CAUTION REFER TO MANUAL
	FRAME TERMINAL		FUSE
	EQUIPOTENTIALITY		EQUIPMENT OR COMPONENT TO BE RECYCLED

### Descriptive Examples of Over-Voltage Categories

**Cat I** Low voltage installations isolated from the mains.

**Cat II** Portable domestic installations.

**Cat III** Fixed domestic installations.



**Cat IV** Industrial installations.

**CAUTION:** The battery used can present danger of fire or chemical burn if it is severely mistreat. Do not disassembly, cremate or heat the battery above 100 °C under no circumstances.

## TABLE OF CONTENTS

1	INTRODUCTION .....	1-1
1.1	Description .....	1-1
2	SETTING UP .....	2-3
2.1	Package Content.....	2-3
2.2	Power.....	2-3
2.2.1	First charge.....	2-3
2.2.2	Charging the battery .....	2-4
2.2.3	Charge/discharge times .....	2-5
2.2.4	Energy saving.....	2-5
2.2.5	Smart control battery .....	2-5
2.2.6	Usage Tips .....	2-6
2.3	Equipment Details.....	2-7
2.3.1	<b>RANGER Neo 2 ATSC</b> .....	2-7
2.4	Switching On/Off the equipment .....	2-9
2.5	Reset .....	2-9
2.6	Screen Icons and Dialog boxes .....	2-10
2.7	Menu Tree .....	2-11
2.8	Controls.....	2-15
2.8.1	Touch Screen .....	2-15
2.8.2	Joystick .....	2-22
2.8.3	Joystick Operation.....	2-23
2.8.4	Select and edit parameters .....	2-24
2.8.5	Keyboard shortcuts .....	2-25
2.8.6	Softkeys .....	2-26
2.8.7	Virtual Keyboard .....	2-27
3	SETTINGS AND PREFERENCES .....	3-28
3.1	Settings Menu .....	3-28
3.2	Video & Audio settings.....	3-32
3.3	Preferences Menu .....	3-32
4	RF SIGNAL TUNING (Terrestrial and Satellite Band) .....	4-39
4.1	Introduction .....	4-39
4.2	Operation .....	4-39
4.3	General Menu Options .....	4-40
4.3.1	F1: Tuning – Selecting Channel / Frequency .....	4-40
4.3.2	F2: Signal Parameters .....	4-43
4.3.3	F3: Tools .....	4-44
4.4	Advanced Options .....	4-46
4.5	Screen Description .....	4-49
4.5.1	Measurement Mode Screens .....	4-49
4.5.2	Spectrum Analyzer Mode Screens .....	4-52
4.5.3	TV Mode Screens .....	4-57
4.6	Extra Information .....	4-63
4.6.1	StealthID Function .....	4-63
4.6.2	Generic Signal .....	4-64
4.6.3	Locking a signal .....	4-64
4.6.4	Satellite Identification.....	4-65

4.6.5	IRG Descriptor.....	4-66
4.7	Tools.....	4-67
4.7.1	Constellation .....	4-67
4.7.2	LTE Ingress test.....	4-70
4.7.3	Spectrogram .....	4-73
4.7.4	Attenuation Test .....	4-75
4.7.5	Signal Monitoring .....	4-78
4.7.6	Signal Coverage* .....	4-85
4.7.7	Datalogger .....	4-95
4.7.8	Screen and Data capture (Export key) .....	4-102
4.7.9	Explore Channel Plan.....	4-104
4.7.10	Discover FM stations .....	4-107
4.7.11	Field Strength.....	4-110
4.7.12	Task Planner .....	4-115
4.7.13	Transport Stream Analyzer.....	4-119
4.7.14	Transport Stream Recording.....	4-128
4.7.15	Shoulders Attenuation .....	4-131
<b>5</b>	<b>WIFI SIGNAL TUNING .....</b>	<b>5-133</b>
5.1	Introduction .....	5-133
5.2	Operation .....	5-133
5.3	Settings.....	5-134
5.4	WiFi Spectrum.....	5-134
5.4.1	Introduction .....	5-134
5.4.2	Screen Description .....	5-135
5.4.3	Menu Options .....	5-136
5.5	Site Survey .....	5-137
5.5.1	Introduction.....	5-137
5.5.2	Screen Description .....	5-138
5.5.3	Menu Options .....	5-139
<b>6</b>	<b>IPTV .....</b>	<b>5-140</b>
6.1	Introduction .....	5-140
6.2	Operation .....	5-140
6.3	Screen Description .....	5-141
6.3.1	Measurement mode.....	5-141
6.3.2	Interarrival Packet Time / Packet Rate Over Time .....	5-144
6.3.3	TV mode.....	5-145
6.4	Tools.....	5-147
6.4.1	PING / TRACE.....	5-147
6.4.2	View IP Network Log .....	5-148
6.4.3	IP Ethernet Frame Viewer .....	5-149
6.5	Settings.....	5-149
6.5.1	Multicast Settings.....	5-149
6.5.2	IPTV parameters and reset measures .....	5-150
6.5.3	General Settings and Preferences.....	5-150
<b>7</b>	<b>INSTALLATIONS MANAGEMENT .....</b>	<b>7-152</b>
7.1	Description .....	7-152
7.2	Operation .....	7-152
7.3	Installation Management .....	7-153
7.4	New installation .....	7-157

- 7.5 Tools.....7-157
- 7.6 Importing Data from USB .....7-158
- 8 CONNECTING TO EXTERNAL DEVICES.....8-160
  - 8.1 USB connector.....8-160
    - 8.1.1 Connecting a USB flash drive.....8-160
    - 8.1.2 Connecting a WiFi USB adapter.....8-162
  - 8.2 Connecting to a computer via Ethernet.....8-162
  - 8.3 Digital V/A Output via HDMI connector .....8-164
  - 8.4 Analogue V/A Input via jack connector .....8-164
  - 8.5 Connecting to antenna via RF Connector.....8-165
    - 8.5.1 DiSEqC commands .....8-165
    - 8.5.2 SCD/EN50494 (SatCR) commands .....8-165
    - 8.5.3 SCD2/EN50607 (JESS) commands .....8-167
  - 8.6 Common Interface Slot.....169
  - 8.7 TS-ASI Input / Output .....170
    - 8.7.1 TS-ASI Input.....170
    - 8.7.2 TS-ASI Output.....171
- 9 SPECIFICATIONS  .....172
  - 9.1 RANGER Neo 2 .....172
    - 9.1.1 General .....172
    - 9.1.2 Measurement Mode .....174
    - 9.1.3 Spectrum Analyzer Mode .....176
    - 9.1.4 TV Mode .....178
    - 9.1.5 WiFi Analyzer Mode .....178
    - 9.1.6 IPTV.....179
    - 9.1.7 Tools.....179
    - 9.1.8 Options.....181
- 10 MAINTENANCE  .....182
  - 10.1 Instructions for returning by mail.....182
  - 10.2 Considerations about the Screen.....182
  - 10.3 Cleaning Recommendations .....182
- ANNEX 1 OPTICAL OPTION OP-002-PS .....184
- ANNEX 2 DAB/DAB+ OPTION OP-002-DAB.....0
- ANNEX 3 MULTIMEDIA CONTENT .....4



# TV & SATELLITE ANALYZER

## RANGER Neo 2 ATSC



## 1 INTRODUCTION

### 1.1 Description

The new **RANGER Neo** is the seventh generation of field meters that **PROMAX** launches. As each new generation, it represents an evolution from the previous, since it integrates the latest technological innovations and develops applications for the new demands and needs that have emerged in recent years.

The new **RANGER Neo** has been created with the aim to make easy the user experience. From its ergonomic design and stylized lines to the reduction of keys and the easy use of its interface, everything has been designed so the user has a simple tool to use but powerful and useful.

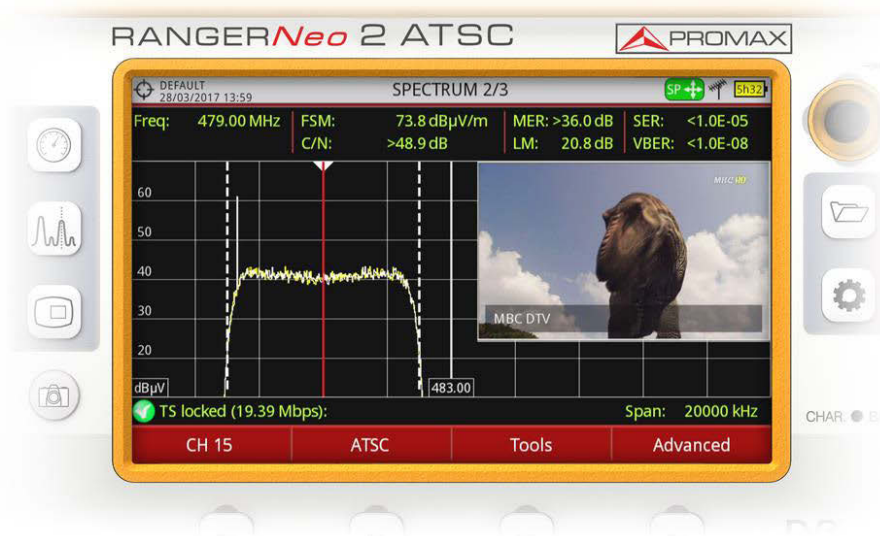

Figure 1.

The **RANGER Neo** is a universal Analyzer that covers several of the most popular standards, as well as formats such as MPEG-2 H.265 or MPEG-4 and Dolby audio\*.





Besides the basic functions of TV meter and spectrum Analyzer for terrestrial and satellite band, it provides additional tools, such as LTE interferences (some of its working frequencies are close to the TV bands), the diagrams constellations or the echoes detection.

The **RANGER Neo** has an application to manage data generated at each installation. This feature helps the user to manage information generated so he can access it at any time or download it to a PC for further analysis.

The **RANGER Neo** has been designed and developed entirely in the European Union. A multidisciplinary team of highly qualified professionals has dedicated effort and commitment to the development of a powerful, efficient and reliable tool. During the manufacturing process, all used materials have been subjected to a strict quality control.

In an effort to facilitate its work to professionals, our long experience ensures an after sales quality service, which includes software updates and upgrades for free.



Figure 2.



Click here to watch this video: [Introducing the RANGER Neo](#)



## 2 SETTING UP

### 2.1 Package Content

Check that your package contains the following elements:

- RANGER *Neo* Analyzer.
- External DC charger.
- Mains cord for external DC charger.
- GPS receiver.
- Car lighter charger.
- Dual WiFi Antenna.
- USB WiFi adapter.
- Aero SMA-H/BNC-M adapter.
- "F" Adapters.
  - "F" / H - BNC / H Adapter.
  - "F" / H - DIN / H Adapter.
  - "F" / H - "F" / H Adapter.
- Support belt and carrying bag.
- 4V/RCA Jack Cable.
- USB Cable.
- Monopode.
- Transport suitcase.
- Quick Start Guide.

**NOTE:** Keep the original packaging, since it is specially designed to protect the equipment. You may need it in the future to send the Analyzer to be calibrated.

### 2.2 Power

The RANGER *Neo* is powered by a 7.2 V built-in rechargeable Li-Ion battery of high quality and long operation time.

This equipment can operate on battery or connected to the mains using a DC adapter. An adapter is also supplied to use with the power connector car (cigarette lighter).

#### 2.2.1 First charge

The equipment comes with the battery half charged. Depending on the time elapsed from first charge and environmental conditions may have lost some of the charge. You should check the battery level. It is advisable a first full charge.

### 2.2.2 Charging the battery

Connect the DC power adapter to the equipment through the power connector on the left side panel (see figure 3).

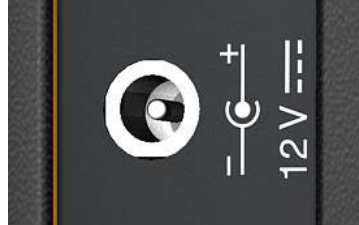



Figure 3.

Then connect the DC power adapter to the mains via the mains cord. Ensure that your mains voltage is compatible with the adapter voltage.

For a **fast** charging of the battery is necessary to switch off the equipment.

If the equipment is ON, the battery charging will be slower, depending on the type of work you are doing. When connecting the equipment to the mains the mains connected symbol  appears inside the battery icon.

The CHARGER led indicator shows the battery status:

- **Yellow:** Battery charging.
- **Green:** Battery full charge.
- **Blinking:** Battery failure or no battery.
- **Off:** Battery is not charging

When switching on the equipment, the battery voltage is checked. If the tension is too weak to start, the LED EXT and DRAIN flashes and the equipment does not start up. In this case please charge the battery immediately.

### 2.2.3 Charge/discharge times

Average charging time with the equipment off (fast charge):

- 3 hours to achieve an 80% charge.
- 5 hours to achieve a 100% charge.

With the equipment on (slow charge):

- 5 hours to achieve an 80% charge.
- 8 hours to achieve a 100% charge.

Average discharge time (with external supply disabled):

- With the battery full charge the average battery time is 5:30 hours.
- With the battery at 80% charge the average battery time is 4 h.

### 2.2.4 Energy saving

These options are available in the **Preferences** menu, pressing the key  for 1s.

- **Power Off:** It allows the user to select the time to power off, which is the time after which the equipment shuts down automatically unless user press any key.
- **TFT Screen:** User can select a time after which the TFT screen turns off, but the equipment is still running normally. The equipment can measure (for example, making a datalogger or channel exploration) and the battery will last longer, about 10 % more. The screen turns on by pressing any key. Time options are: off, 1, 5, 10 or 30 minutes.

### 2.2.5 Smart control battery

The built-in battery of the equipment is of the "**smart**" type, which means that reports its state of charge. This information is displayed inside the battery icon in the form of the average time available. In this way the user can know at any time the remaining battery level.

The remaining time charge that appears is calculated according to the work that has been doing. If you activate the external supply of the equipment, the average time would be reduced according to the increase in consumption that occurs.



## 2.2.6 Usage Tips

The battery is losing storage capacity as you go through its life. Contact your **PROMAX** distributor when necessary to replace the battery.

To prolong battery life the user should follow these tips:

- In case of providing a long inactivity period of the equipment it is advisable to make every 3 months a charge / discharge cycle and a subsequent partial charge (40% aprox.).
- It is advisable to keep it in a cool place and away from heat.
- You should avoid keeping the battery for a long period of time at full load or fully discharged.
- There is not necessary to wait to fully discharge before a charge because these batteries have no memory effect.

2.3 Equipment Details

2.3.1 RANGER Neo 2 ATSC

■ Front View



Figure 4.



## 2.4 Switching On/Off the equipment

### ► Switching On:

- 1 Press for a while (approximately one second) the button located on the side of the equipment.
- 2 When all indicators light up at once release the button.
- 3 The boot screen (user can select the boot screen from "Preferences" menu) appears and also a progress bar that indicates the system load. At the top left corner it shows the equipment model and the installed software release detected.
- 4 After the system load, the last screen before shutdown appears.

### ► Switching Off:

- 1 Press the button located on the side of the equipment.
  - **Short press (<1 s):** A menu on screen allows the user to select between power off or reboot.
  - **Long press (>2 s):** The equipment turns off directly.
- 2 When the screen goes off, user should release the button, which returns to its rest position.
- 3 The boot screen picture appears and also a bar showing the system shutdown progress.
- 4 The equipment keeps its last status (mode and screen) which is recovered when power on.

In the **PREFERENCES** menu  (press 1s), APPEARANCE tab, option "**Off**" the user can activate the automatic shutdown option, selecting a waiting time (time without pressing any key) after which the equipment turns off automatically.

## 2.5 Reset

How to **RESET**: Hold down the F4 key for 6 seconds and release.

When to **RESET**:

- **When it crashes and does not respond to any key.** Hold down the ON / OFF key for 10 seconds and if the meter does not turn off then RESET.





- **When it does not switch on.** If it does not start after trying turning on by the normal procedure (by pressing the ON / OFF button with the meter connected to the mains) then RESET.
- **When it does not finish the boot process.** Hold down the ON / OFF key for 10 seconds and if the meter does not turn off then RESET.

## 2.6 Screen Icons and Dialog boxes

On the screen are some icons that provide useful information to the user about the current status of the instrument.

	<b>Battery charging.</b>		<b>Warning</b>
	<b>Battery not charging.</b> Yellow level indicates charge left.		<b>USB flash drive inserted</b>
	<b>Battery not charging,</b> time left indicator.		<b>WiFi source signal</b>
	<b>Satellite band.</b>		<b>Current installation.</b>
	<b>Fibre Optics source signal</b>		<b>GPS locked.</b> <b>GPS unlocked.</b>
	<b>Current voltage, 22 kHz</b> signal and LNB power level.		<b>SATCR (SCD/EN50494)</b> commands enabled.
	<b>Terrestrial band.</b>		<b>JESS (SCD2/EN50607)</b> commands enabled..
	<b>IPTV mode enabled.</b>		<b>5 GHz RF Auxiliary Input.</b>
	<b>Compressed installation.</b>		<b>Task scheduled.</b>
			Multi-function Joystick enabled. Two-letter code indicates the exact function:
	<b>OK.</b>		<b>FR</b> Frequency tuning.
	<b>Searching.</b>		<b>CH</b> Channel tuning.
			<b>SP</b> Span change.
			<b>MK</b> Marker moving.
			<b>EC</b> Echo/zoom change.
			<b>AP</b> WiFi Acces Point

2.7 Menu Tree

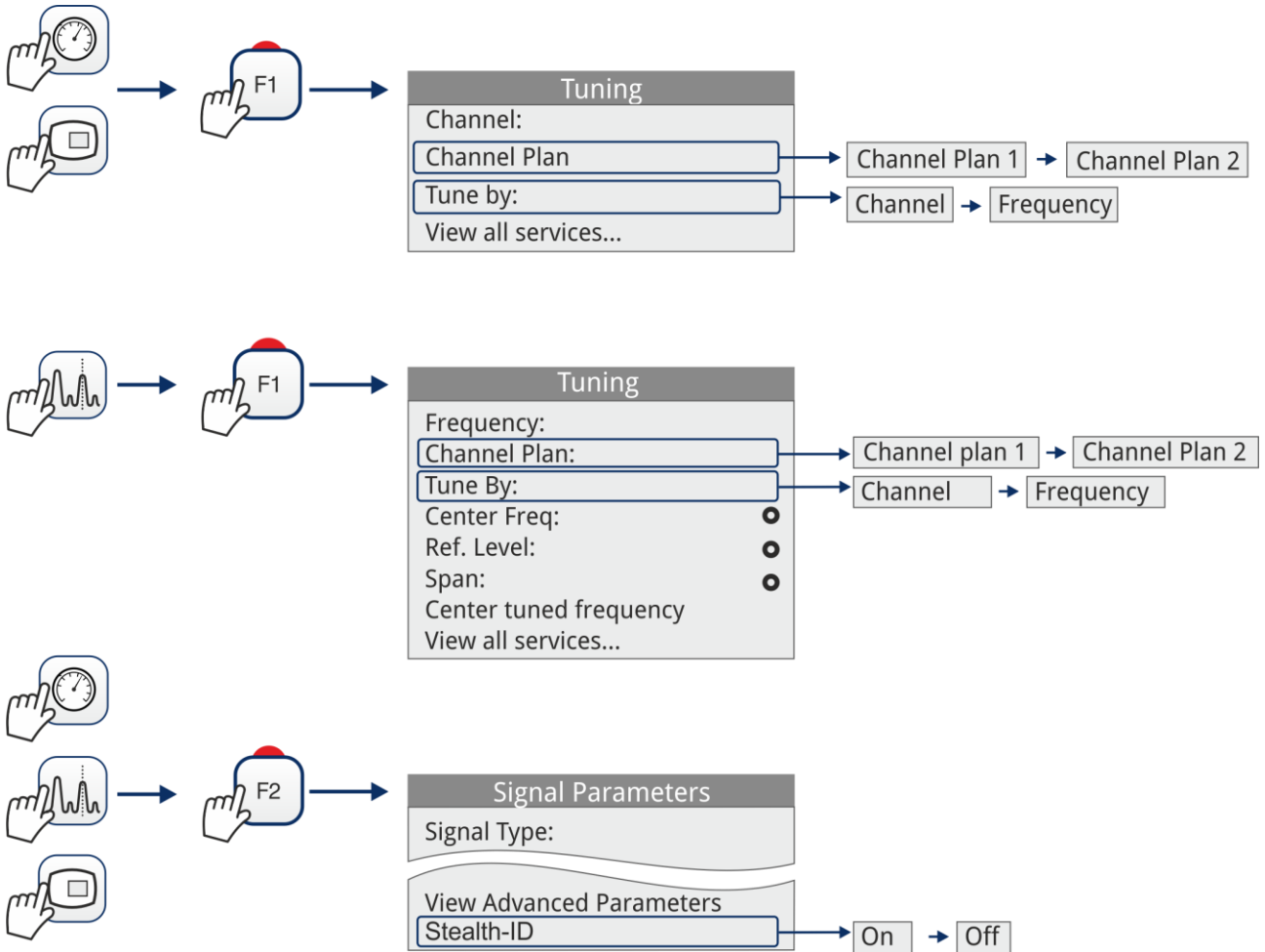





Figure 7.

 Only available for **digital channels**

 Option available for **terrestrial band**

 Option available for **satellite band**

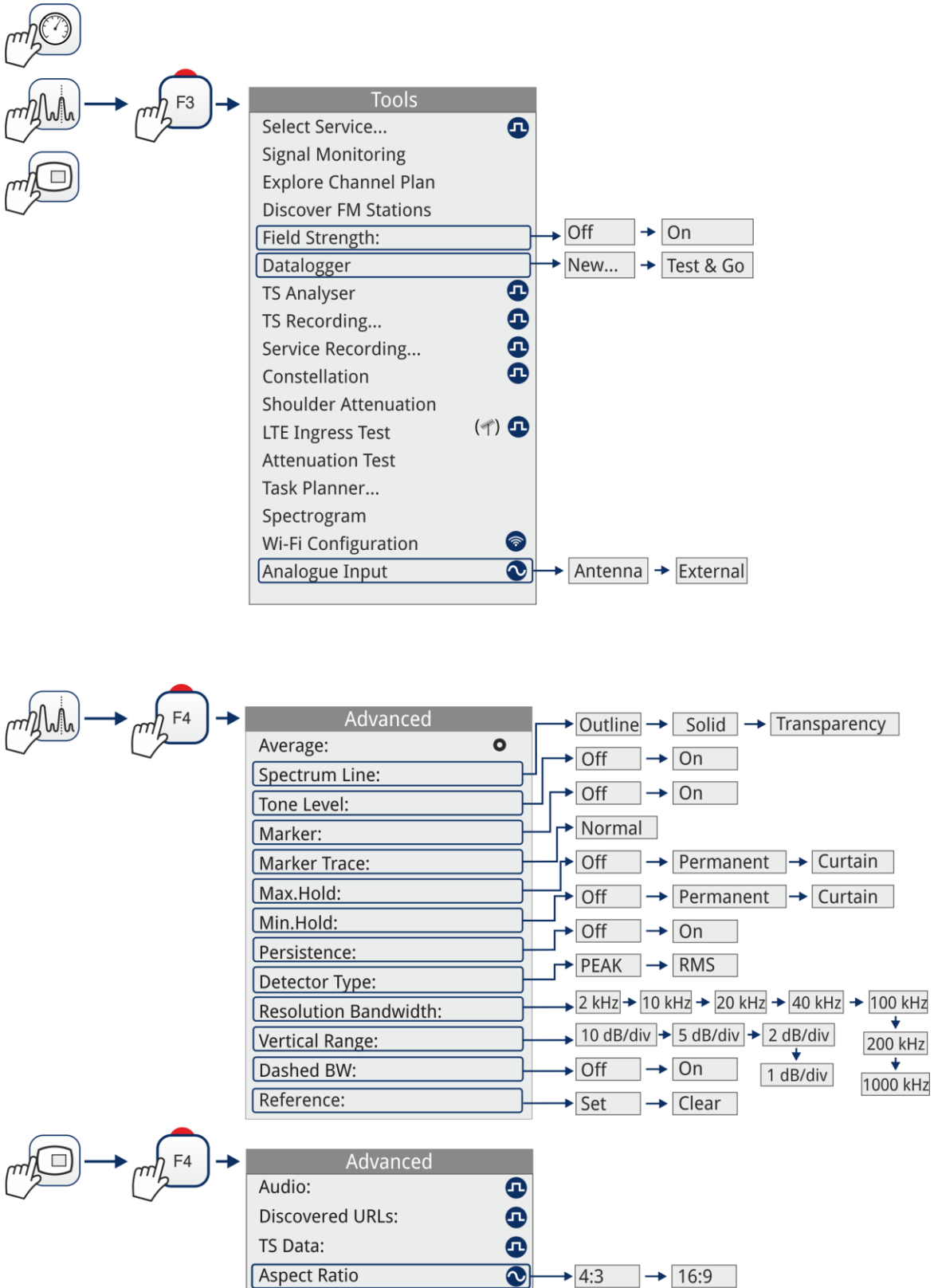

Figure 8.



Only available for **digital channels**



Option available for **terrestrial band**



Only available for **analogue channels**



Option available for **satellite band**



### INSTALLATION MANAGEMENT MENU

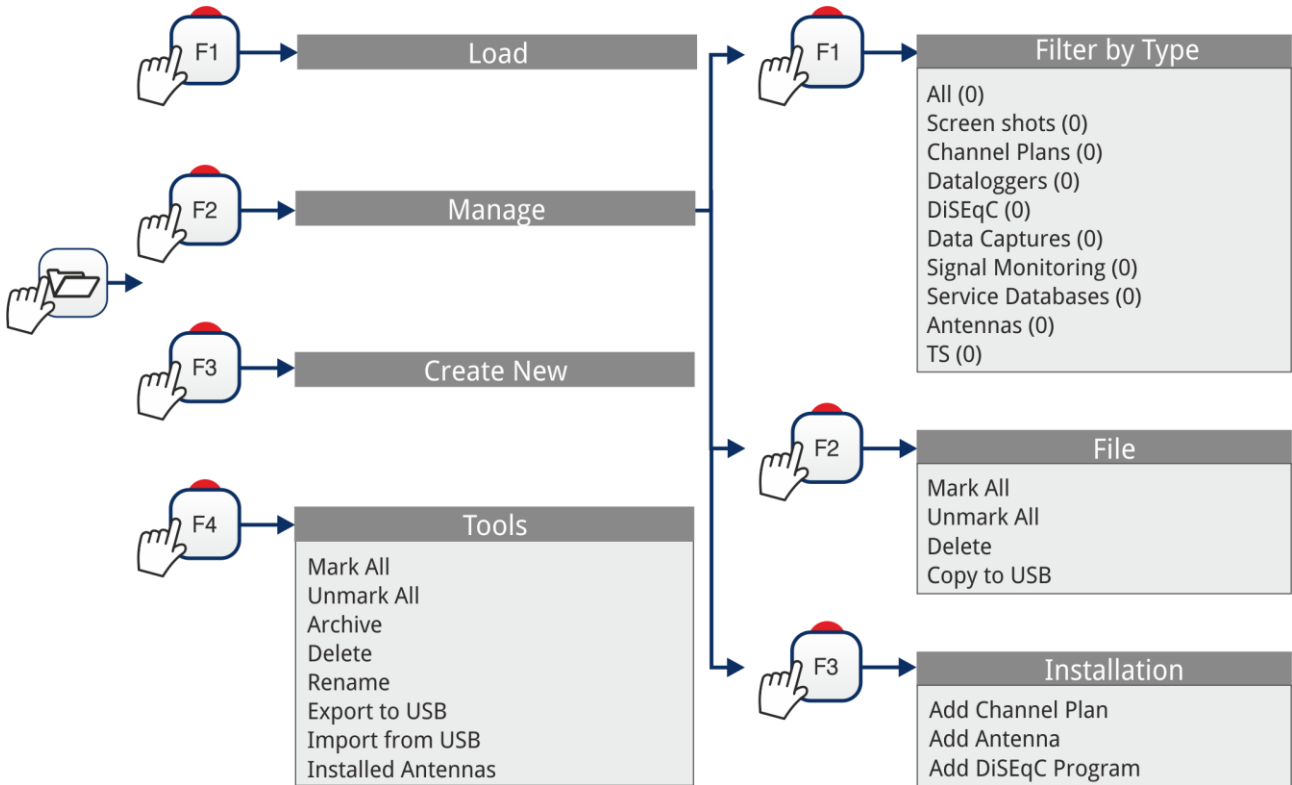

Figure 9.



### PREFERENCES MENU

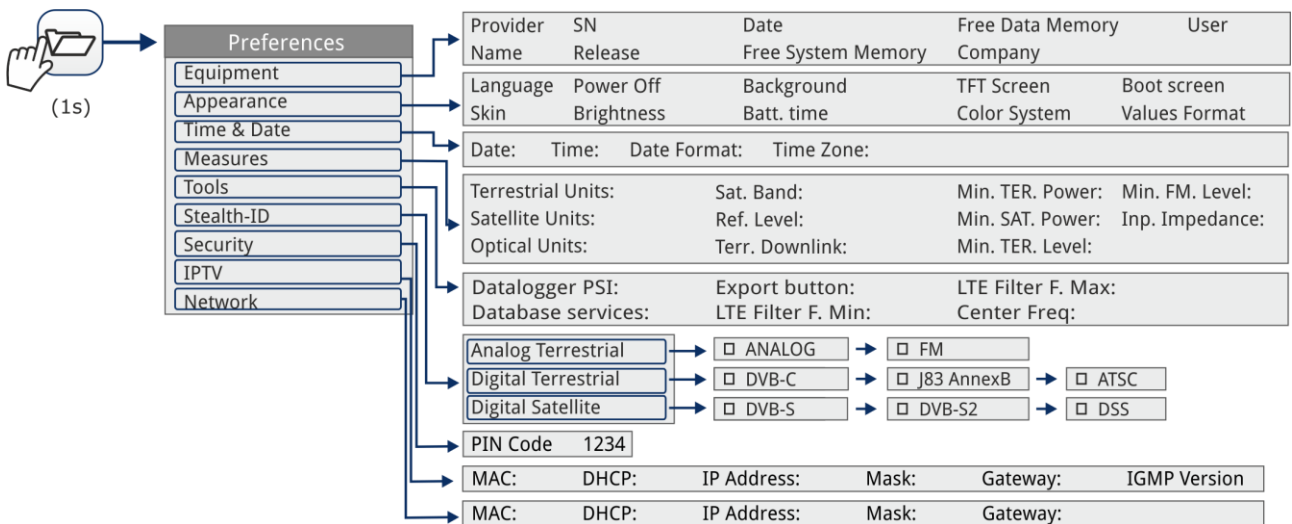

Figure 10.



SETTINGS MENU

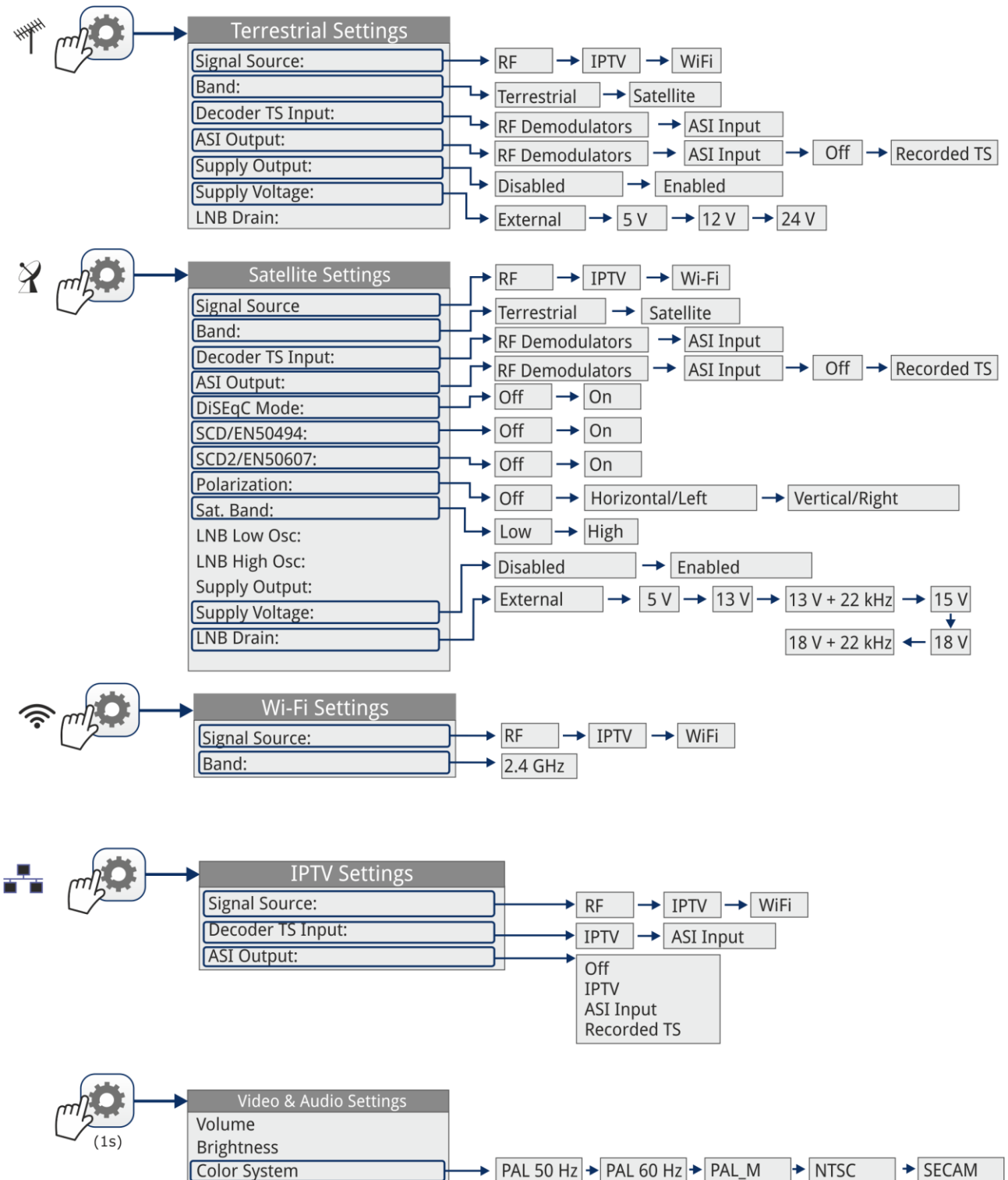



Figure 11.

 Option available for **terrestrial band**

 Option available for **satellite band**

## 2.8 Controls

The equipment has been designed to be an easy tool to use. For this reason the number of keys has been reduced and these are grouped by function.

The menu navigation includes hints that appear when the cursor is placed on an disabled (grayed) option for a while. This hints help the user to understand why an option is disabled and what to do to enable it.

The equipment can be fully operated using both the touch panel (even using wearing gloves) and the conventional keyboard.

For measurement and navigation through the menus, the equipment has the touch panel, a joystick, 4 programmable keys (softkeys) and 6 direct access keys (shortcut keys).

### 2.8.1 Touch Screen

The control software is designed in such a way that the meter can be fully operated using both the touch panel and the conventional keyboard.

These actions can be done through the touch panel:

- **Menu Selection.**
- **Frequency or channel selection.**
- **Frequency or channel scroll.**
- **Virtual keyboard writing.**
- **Toolbar access.**
- **Mode screens switch.**
- **Installations Management.**
- **One-touch zoom in.**



### ► Menu Selection

User can operate on the menus on screen: drop-down menu, select an option, accept or exit a message, and so on, just touching on the option.

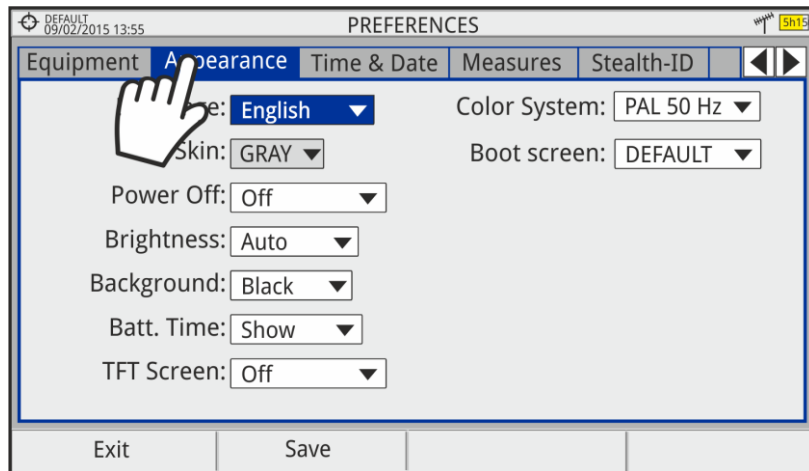

**Figure 12.**

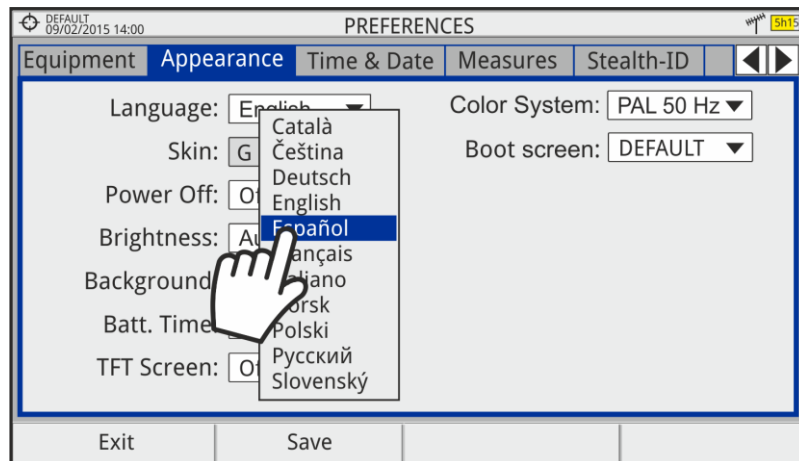

**Figure 13.**

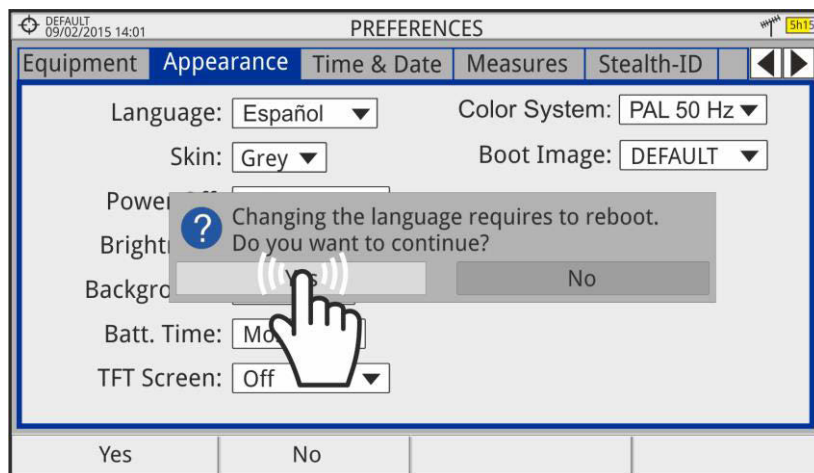
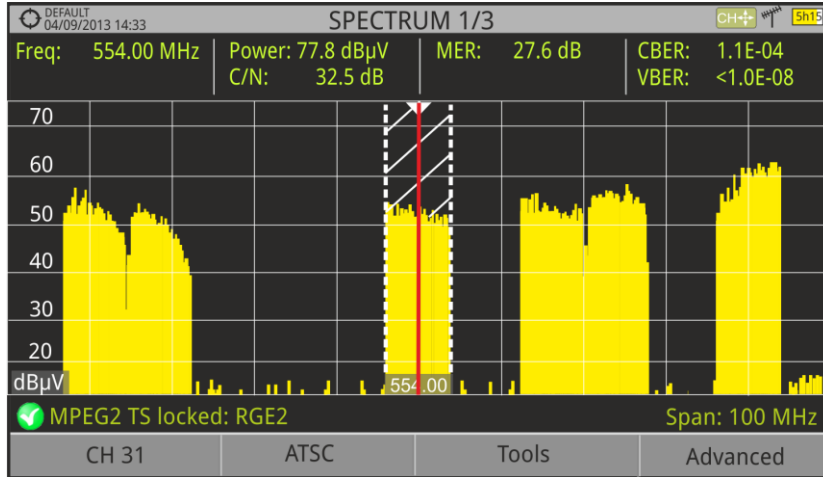

**Figure 14.**



► **Frequency or Channel Selection**

At the Spectrum Analyzer mode, user can select a channel or frequency by tapping on the frequency or channel.



**Figure 15.** First screen (channel locked).

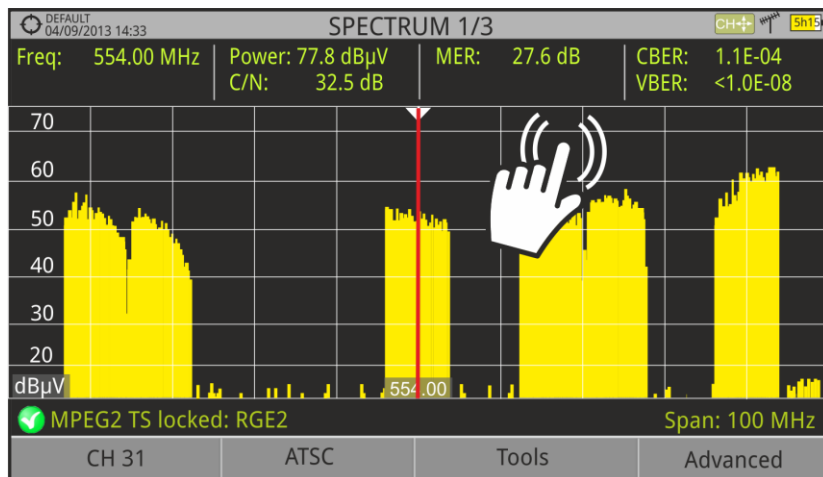

**Figure 16.** Tap on the new frequency.

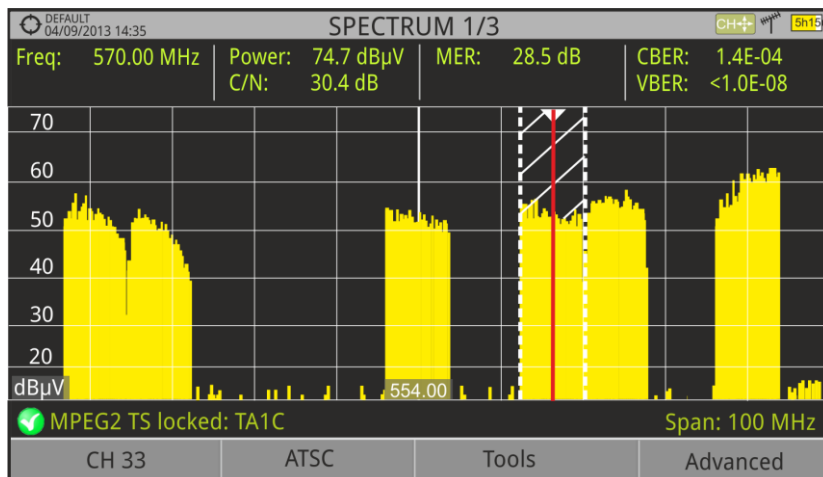

**Figure 17.** The cursor moves to the frequency.





► **Frequency or Channel Scroll**

At the Spectrum Analyzer mode, user can scroll through frequency or channels by dragging and dropping his finger on the screen.

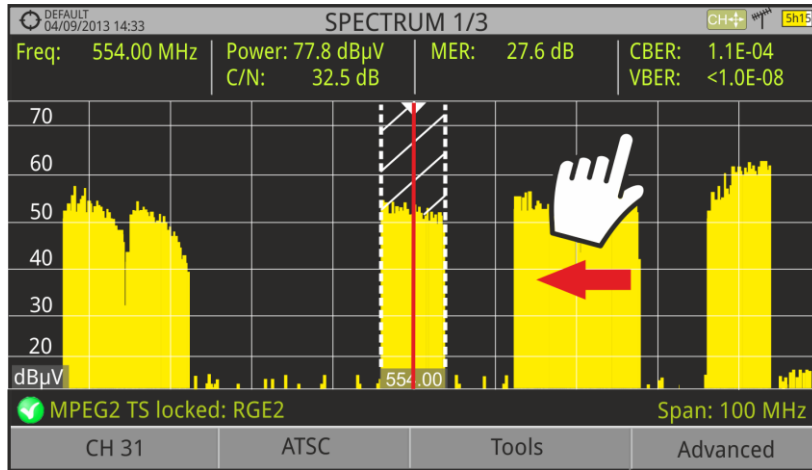

**Figure 18.**

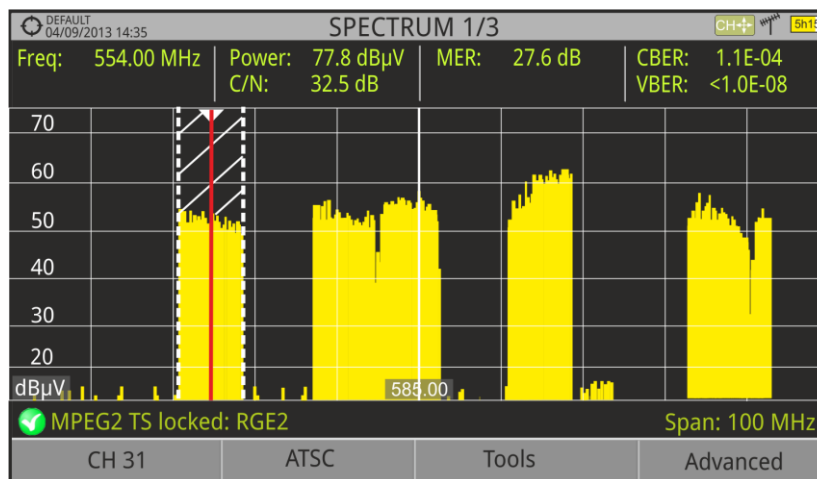
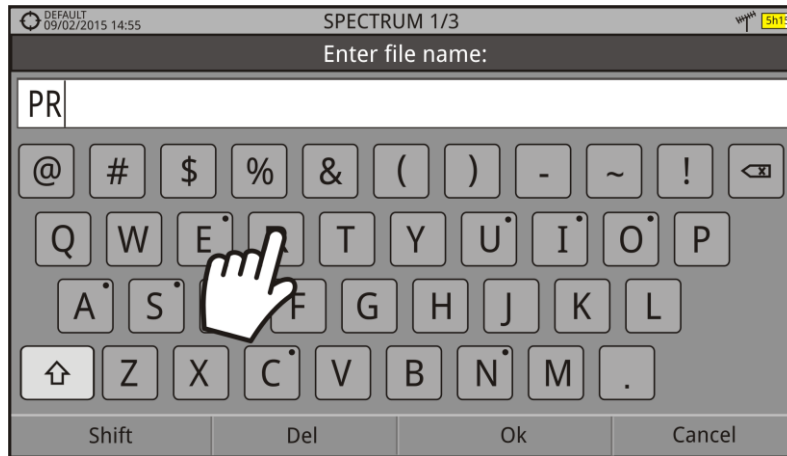

**Figure 19.**



► **Virtual keyboard/keypad writing.**

User can type directly on the on-screen keyboard or keypad.



**Figure 20.**

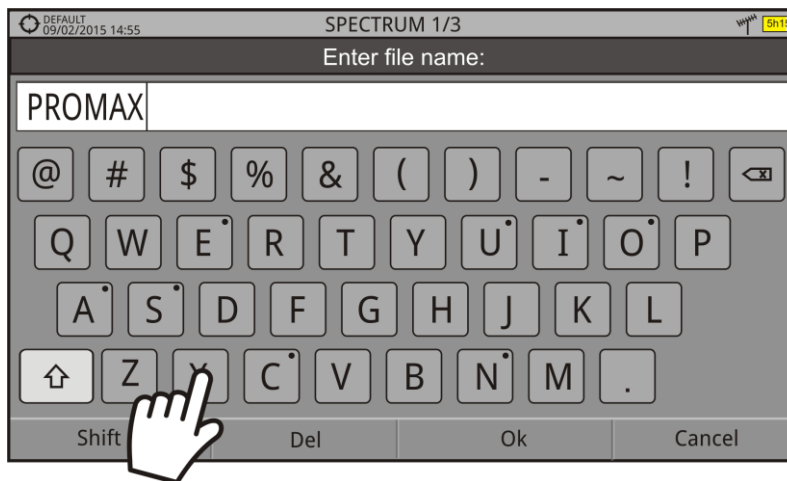
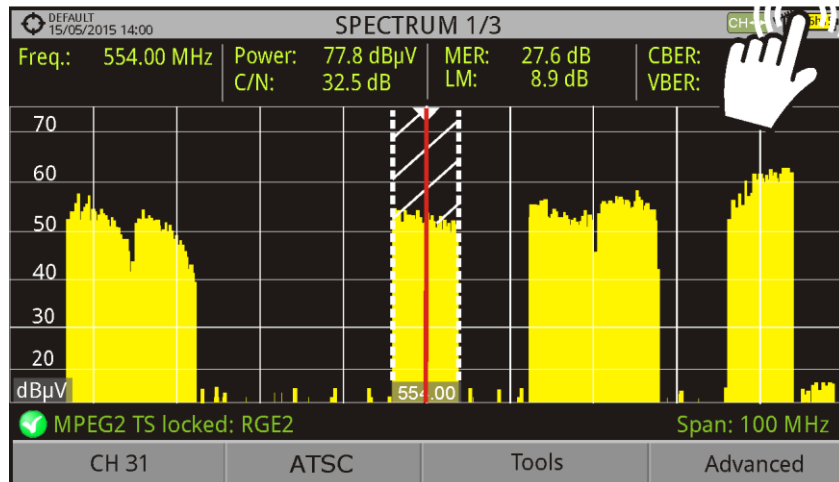

**Figure 21.**



► **Toolbar**

User can access the more important functions through the toolbar by pressing on the right top corner of the screen.



**Figure 22.**

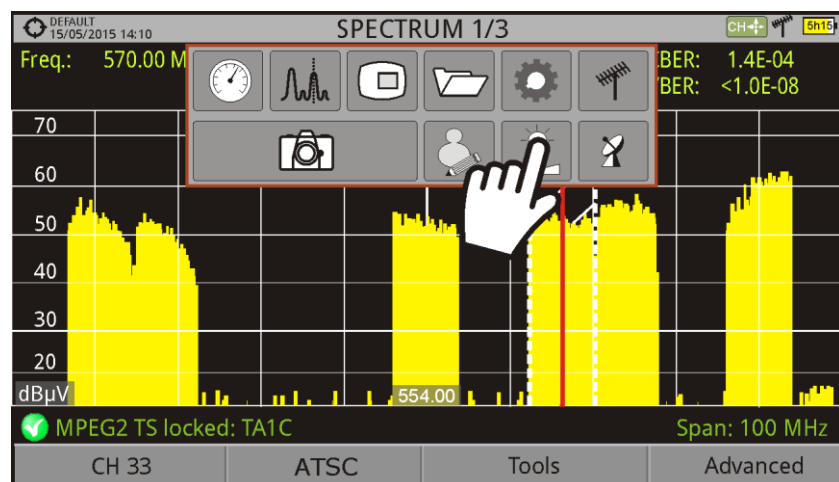

**Figure 23.**

• **Toolbar icons description**

- |                          |                  |                        |
|--------------------------|------------------|------------------------|
| Measurement Mode         | Settings         | Video & Audio Settings |
| Spectrum Analyzer Mode   | Terrestrial Band | Preferences            |
| TV Mode                  | Satellite Band   | Screen Capture         |
| Installations Management |                  |                        |



► **Mode screens**

User can switch the view of the current mode by pressing on the top center of the screen.

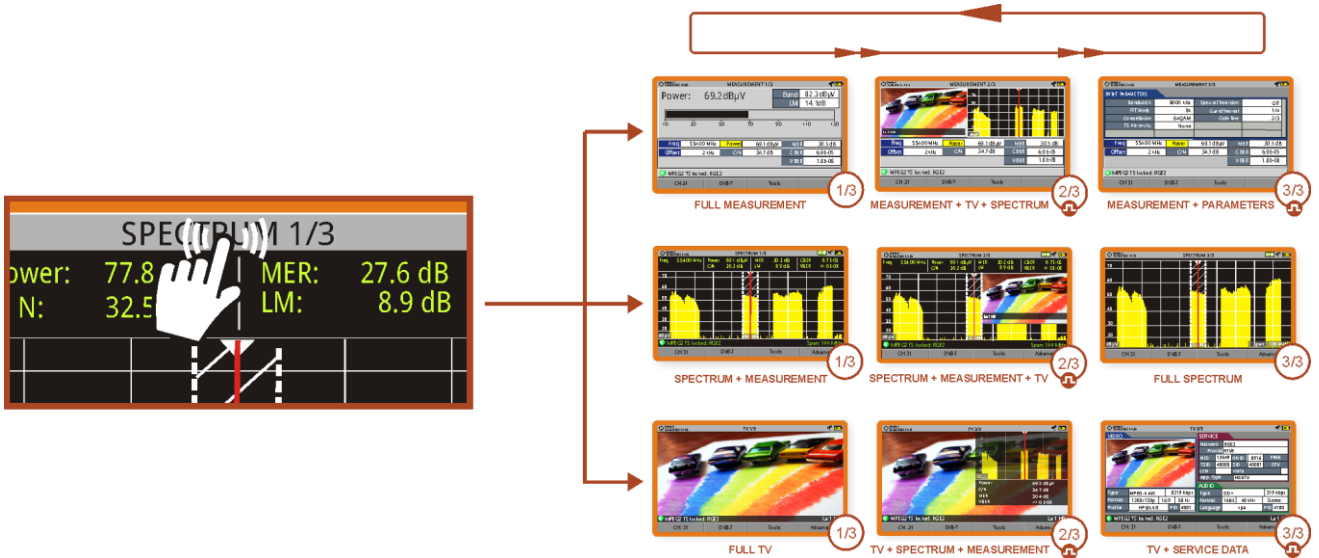

Figure 24.

► **Installations Management**

User can access data of the current installation by pressing on the left top corner.

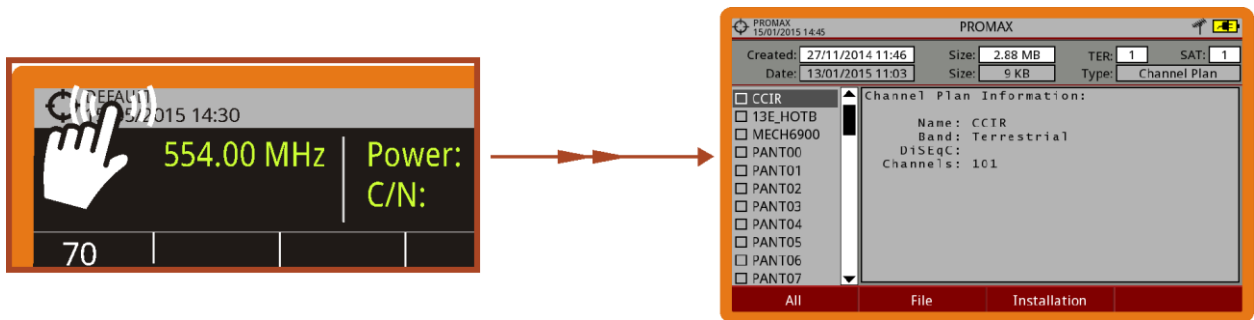

Figure 25.



► **One touch zoom-in**

In a view with different windows (measurement, spectrum and / or TV), if the user clicks on one of the windows, he will directly access the corresponding enlarged view.

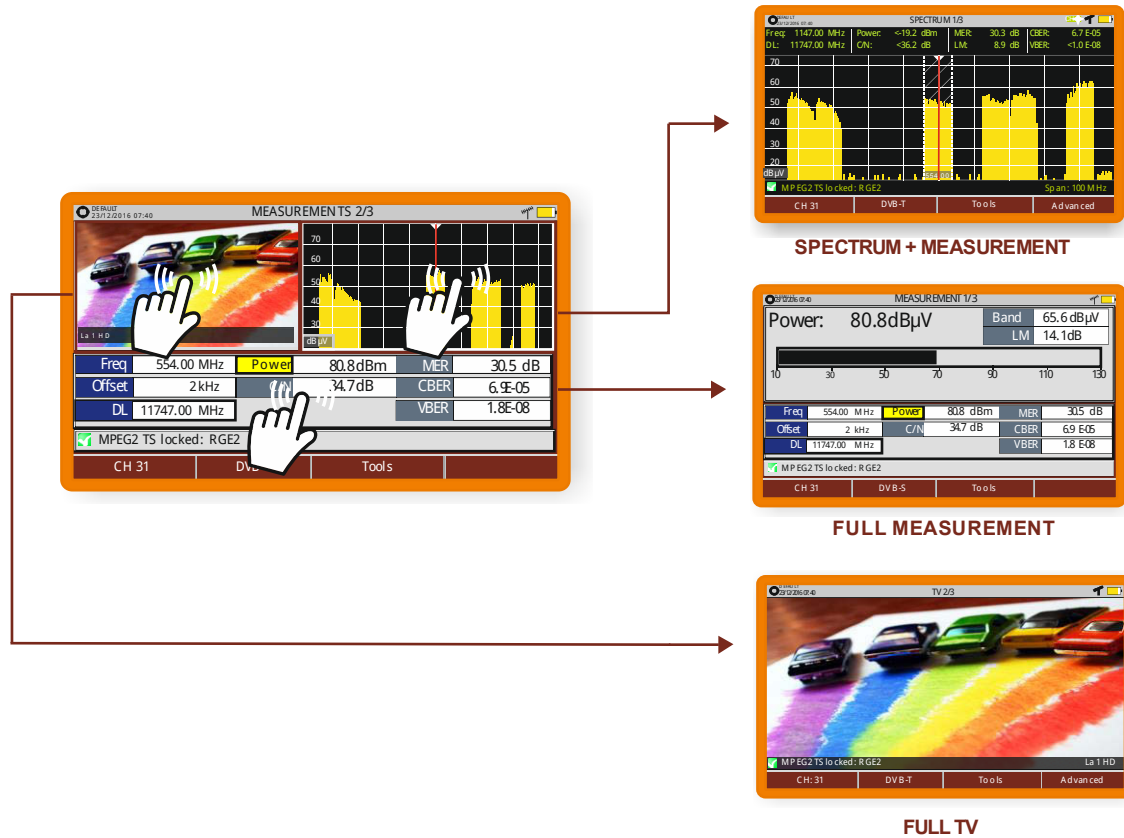

Figure 26.

**2.8.2 Joystick**

Joystick positions are five:

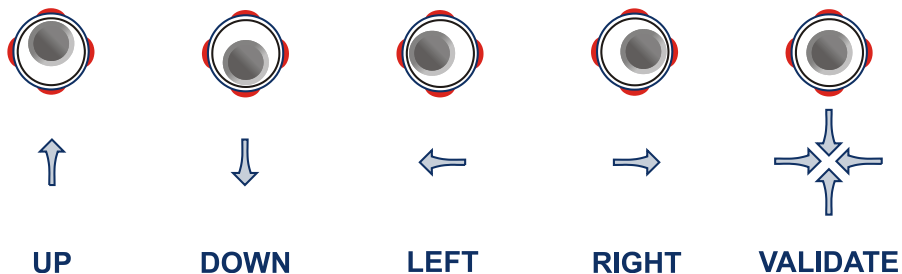

Figure 27.

The joystick is multifunctional, that is, each time you press its function changes. The user can see the active function according to the icon that is displayed at the upper right corner of the equipment, as shown in the image.



In the **SPECTRUM ANALYZER** mode, the joystick has the following functions:



- ▶ **CH** or **FR**: Channel change (CH) or frequency (FR) change (according to the tune selected: tune by channel or tune by frequency).
- ▶ **SP**: Span change.
- ▶ **MK**: Marker moving (if marker is enabled).

**Figure 28.**

Working in WIFI mode, the joystick has the following functions:

- ▶ **AP**: Change of Access Point.
- ▶ **SP**: Change of Span.

Using the **ECHOES** tool, the joystick is also multifunctional:

- ▶ **CH** or **FR**: Channel (CH) change or frequency (FR) change (according to the tune selected: tune by channel or tune by frequency).
- ▶ **EC**: Echo change.

According to the selected function, the joystick will do a specific action.



[Click here to watch this video: Navigating through the menus](#)

### 2.8.3 Joystick Operation

In the **SPECTRUM ANALYZER** mode, the joystick can make different actions depending on its active mode.

The active mode of the joystick appears as an icon at the top right of the screen. Available modes are:

- ▶ **Frequency tuning.**
- ▶ **Channel tuning.**
- ▶ **SPAN change.**
- ▶ **Marker moving.**



To change the active mode press the joystick.

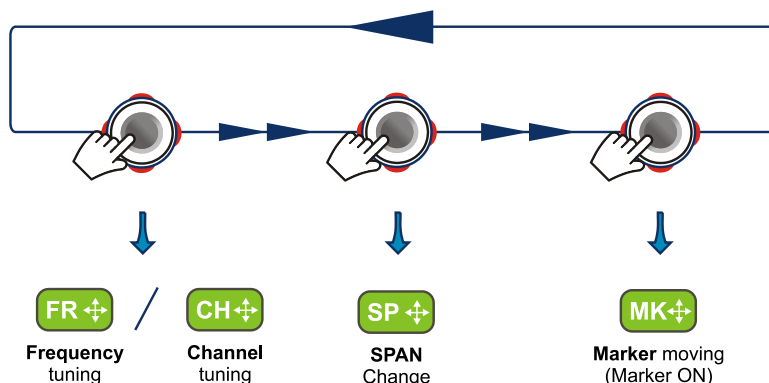

Figure 29.

Pressing left or right will take appropriate action according to the active mode. Pressing up or down will change the reference level regardless the active mode. The frequency or channel tuning mode will appear depending on the selected tuning type. Access the **Tune by** F1 menu to select the type of tuning.

To show the **Marker** mode, it must be ON. Access the **Advanced** menu F4 to activate the **Marker**.

Pressing the joystick for 1 second, a box appears explaining the joystick modes available. From here user can also select the active mode.

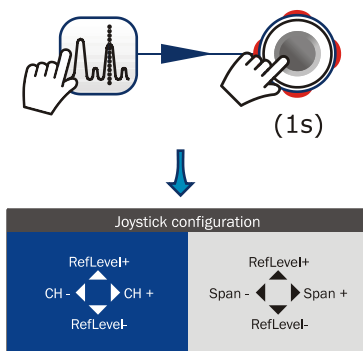

Figure 30.

### 2.8.4 Select and edit parameters

To edit or select any parameters of these described above, follow these instructions:

- 1 Place over the option and press the joystick.
- 2 The data field gets into the edit mode, indicated by the yellow background.



- 3 A menu is displayed at the right with some options or if it is numeric, a number gets a black ground.
- 4 Move the joystick up/down to select one option. To move between figures press right/left and to change it press up/down.
- 5 When finished press joystick or any function key to exit.

## 2.8.5 Keyboard shortcuts

### ► Management Keys

There are two Management keys. Each one has two different functions according to the pressing time:



**Short press:** It shows the list of installations and the menus to manage them.

**Long press:** It shows the preferences menu.



**Short press:** It shows the menu of terrestrial or satellite settings (according to the selected band).

**Long press:** It shows the Video & audio settings.



### ► Export / Reference key

Depending on how long you press this key, it has two different functions:

■ **Short Press:** Pressing this key for less than one second on the Spectrum Analyzer mode, it holds on screen the current waveform as a reference. It is equivalent to go to the option "Reference - Set" from the "Advanced" menu.

Pressing short again, it deletes the waveform reference. It is equivalent to go to the option "Reference - Clear" in the "Advanced" menu.

■ **Long press:** Pressing this key for one second it makes a capture of what it is shown on screen at the time.

The capture may be from the screen image, from the measurement data or from both.

The type of capture, either screen, data, or both can be set in the "**Export button**" option which is on the label "**Measures**" in the "**Preferences**" menu.

More information in the chapter "**Export key**".





► **Function keys**

On the left side there are 3 keys to access the most important functions of the equipment.



**Measurement key.**



**Spectrum Analyzer key.**





**TV Mode Key.**

The active function on screen is indicated by the LED next to the function key.

Pressing a key repeatedly provides access to a different view within the same function. For analogue signals only the first view of each function is available. Each view is shown at the top. When reaching the third view it returns to the first view.

**2.8.6 Softkeys**

There are four programmable keys, also called softkeys, numbered from  to .

Each key provides access to a menu. This menu varies depending on the function the user is working on the meter.

The menu is displayed on each softkey at the bottom of the screen.

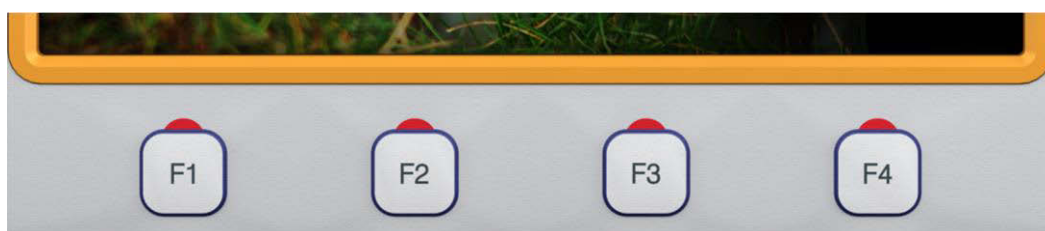

**Figure 31.**

## 2.8.7 Virtual Keyboard



When a user needs to enter or edit a text (from an image, Channel Plan, etc.), a screen with a virtual keyboard appears as shown at the figure.







**Figure 32.**



To edit the file name user should follow these steps:

- 1 Place the cursor over the text box where the name appears.
- 2 Move the cursor to place it next to the letter that user wants to edit.
- 3 Press on the virtual keyboard to edit.

To delete a letter, move the cursor to the right side of the letter and then press the joystick on the Delete key  or press  (Del).

To enter an upper case letter press first  or press the joystick on the  key. To block upper case press  or press the joystick on the  key twice consecutively. To return to lower case press  or the key again.

Keys with a point at the top right corner give access to special characters, by keeping pressed the joystick for one second on the key.

After editing press  (Ok) to validate the name and continue the process or  (Cancel) to cancel.



### 3 SETTINGS AND PREFERENCES

#### 3.1 Settings Menu

Press the **Settings** key to access the settings menu.

Depending on the selected band, the menu may be different.

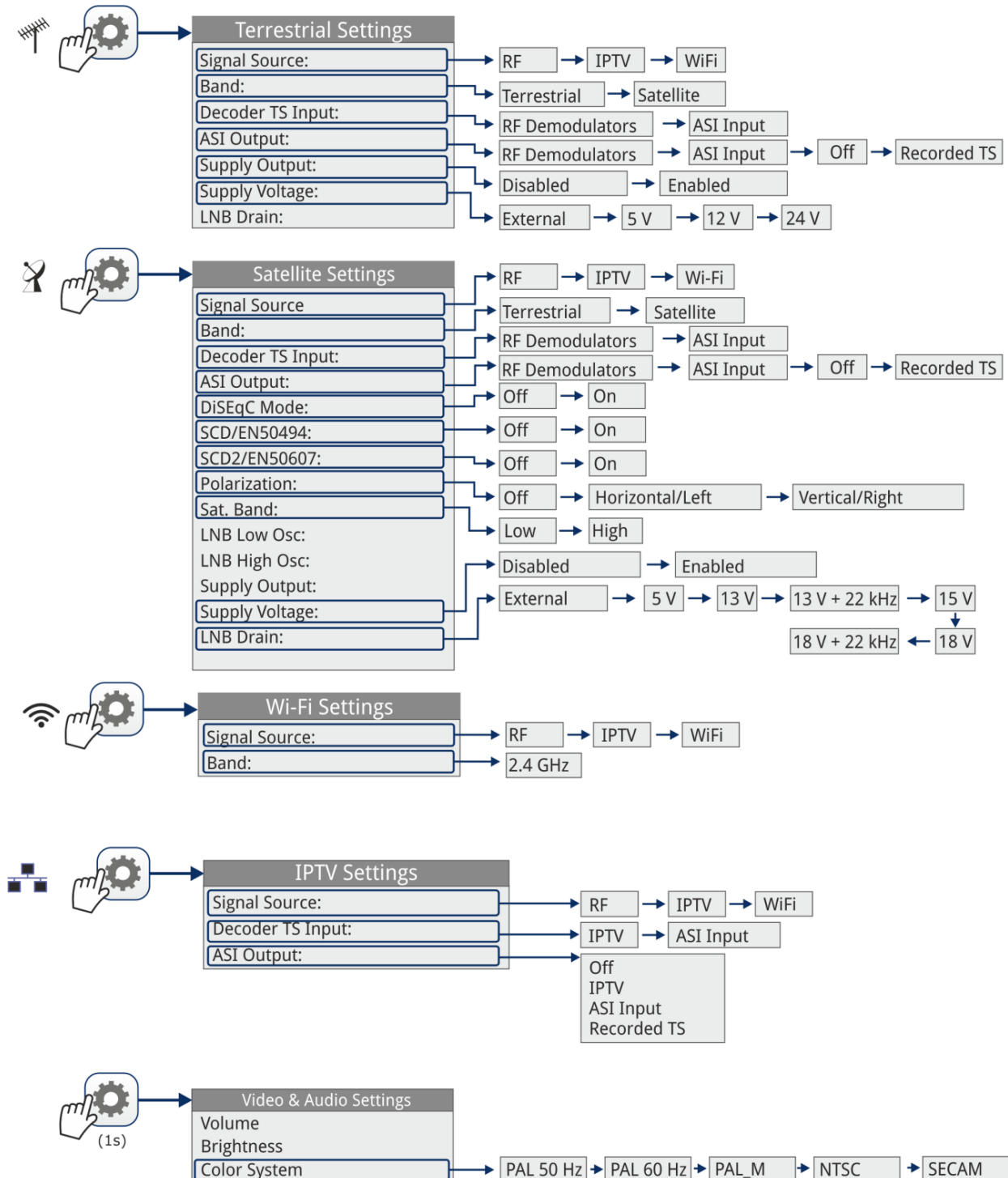

Figure 33.



A brief explanation of each option available on the menu:

► **Signal Source**

It allows the user to select the signal coming into the equipment between RF (for radio-frequency signals) or WiFi (for wireless signals).

► **Band**

It allows the user to select between terrestrial or satellite frequency band for RF, IPTV input (for TV over any type of IP packet based distribution network) or the WiFi operation band.



[Click here to watch this video: Switching satellite / terrestrial bands](#)

► **Decoder TS Input**

It allows the user to select the transport stream coming into the equipment between the RF Demodulators, IPTV input, ASI input and the transport stream played from the TS Recording tool.

- **RF Demodulators:** (This option is available only if RF is selected as a Signal Source). The TS extracted from the RF signal by means of the internal RF demodulator. The RF signal can come from digital terrestrial, satellite or cable.
- **IPTV:** (This option is available only if IPTV is selected as a Signal Source). The TS extracted from the IPTV signal.
- **ASI Input:** The TS coming directly through the ASI-TS input connector.
- **Recorded TS:** The TS comes from the one being played and previously recorded with the TS Recording tool (warning: this option is automatically selected each time a recorded TS is played. Disable it once the TS playing has finished).

► **ASI Output**

It allows the user to select the signal source for the TS-ASI packets going out through the equipment ASI Output. User can select among Off, RF Demodulators, IPTV and ASI Input. This transport stream can feed the signal to other devices.

- **Off:** ASI Output disabled.
- **RF Demodulators:** (This option is available only if RF is selected as a Signal Source). The signal through ASI Output is the TS extracted from the RF signal by means of the internal RF demodulator. The RF signal can come from digital terrestrial, satellite or cable.



- **IPTV:** (This option is available only if IPTV is selected as a Signal Source). The signal through ASI Output is the TS extracted from the IPTV signal.
- **ASI Input:** TS-ASI packets coming from ASI input connector go out through the ASI output connector.
- **Recorded TS:** (This option is available only if there there is a TS previously recorded) The TS comes from the one being played and previously recorded with the TS Recording tool (warning: this option is automatically selected each time a recorded TS is played. Disable it once the TS playing has finished).

► **External power supply** (available for terrestrial and satellite band)

It enables or disables the power supplied to external units such as preamplifiers for antennas in terrestrial television or LNBS and FI simulators in the case of satellite TV.

When this option is enabled the equipment applies at the output the voltage selected by the user in the Supply Voltage option (see below). When this option is disabled the equipment does not apply the voltage to the output but it will behave as if it did.

► **Supply voltages** (available for terrestrial and satellite band)

It selects the voltage to be applied to an external unit.

Available voltage options change depending on the selected band.

Voltage available for terrestrial band is: External, 5 V, 12 V and 24 V.

Voltage available for satellite band is: External, 5 V (for devices working with 5 V such as GPS active antennas), 13 V, 13 V + 22 kHz, 15V, 18 V, 18 V + 22 kHz.

In the External supply voltage option the power supplier to the external units is the power supplier of the antenna preamplifiers (terrestrial television) or the satellite TV receiver (collective or domestic).

► **LNB Drain** (available for terrestrial and satellite band)

The LNB drain option shows the voltage and current flowing to the external unit. If there is any problems (e.g. short circuit), an error message appears on the screen ('SHORTCIRCUIT'), a warning beep sounds and the equipment will not supply power. The equipment does not return to its normal operating state until the problem is solved .During this time the equipment checks every three seconds if there still the problem, warning with an audible signal.

The DRAIN LNB light indicator\* is lit if current is flowing to the external unit.



► **DiSEqC Mode** (only available for satellite band)

It enables or disables DiSEqC mode. DiSEqC (Digital Satellite Equipment Control) is a communication protocol between the satellite receiver and accessories of the satellite system (see chapter "CONNECTING TO EXTERNAL DEVICES").

► **SCD/EN50494** (only available for satellite band)

It enables or disables the SCD/EN50494 function to control devices of a satellite TV installation that supports this technology (see chapter "CONNECTING TO EXTERNAL DEVICES").

► **SCD2/EN50607** (only available for satellite band)

It enables or disables SCD2/EN50607 mode to control devices in a satellite TV installation which must be compatible with this technology (see chapter "CONNECTING TO EXTERNAL DEVICES").

► **Polarization** (only available for satellite band)

It allows the user to select the signal polarization between Vertical/Right (vertical and circular clockwise) and Horizontal/Left (horizontal and circular anti-clockwise), or disable it (OFF). In tuning mode the Polarization option can not be changed.

► **Sat Band** (only available for satellite band)

It allows the user to select the High or Low band frequency for satellite channel tuning. In channel tuning mode the Band Sat can not be changed.

► **LNB Low Osc.** (only available for satellite band)

It defines the local oscillator frequency for the LNB low band. When a channel plan is selected but LNB oscillator values are not properly selected, a warning is issued.

► **LNB High Osc.** (only available for satellite band)

It defines the local oscillator frequency for the LNB high band (up to 25 GHz). When a channel plan is selected but LNB oscillator values are not properly selected, a warning is issued.

## 3.2 Video & Audio settings

Press the Settings key  for one second to access the Video & Audio settings menu.

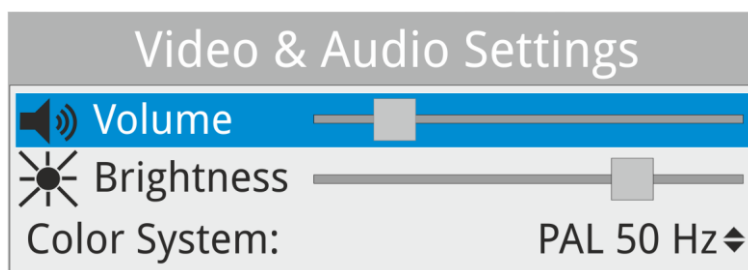

**Figure 34.**

A brief explanation of each option available on the menu:

### ► **Volume**

It increases or decreases the volume of the speaker audio output by moving the joystick to the right (+ volume) or left (- volume).

### ► **Brightness**

It increases or decreases the screen brightness by moving the joystick to the right (+ brightness) or left (- brightness).

### ► **Colour System**

The coding system used in analogue transmissions. Available options are: PAL 50 Hz, PAL 60 Hz, PAL-M, NTSC and SECAM.

## 3.3 Preferences Menu

You access the **Preferences** menu by pressing the **Installations Management** key  for one second. The options are grouped in tabs as follows:

- **Equipment:** Equipment information.
- **Appearance:** Equipment customization options.
- **Date & Time:** It allows the user to change date and time zone.
- **Measures:** It allows the user to choose between several units of measure among other parameters.
- **Tools:** It allows to edit some parameters for different tools.
- **StealthID:** It allows the user to select the set of signal types being used while auto identifying any modulation type.
- **Security:** It allows to edit the PIN code.
- **IPTV:** IPTV network parameters settings.
- **Network:** Network parameters settings.

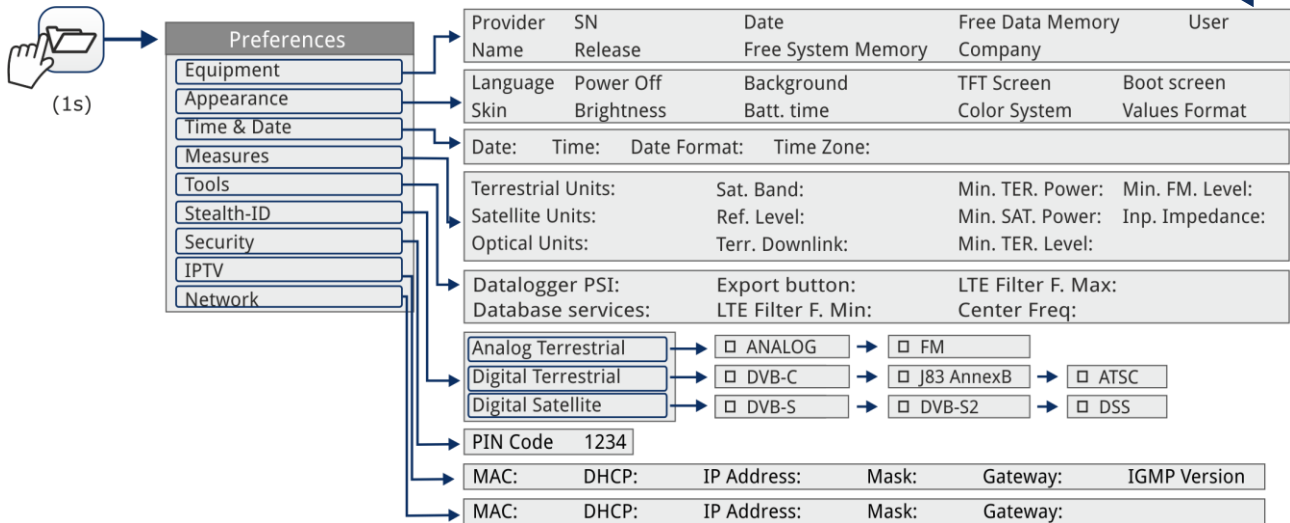

Figure 35.

To navigate between tabs move the joystick left or right. To navigate between the options within the tab move the joystick up or down.

Press **F1** **Exit** to exit Preferences.

Press **F2** **Save** to save changes.

A brief explanation of the options available in each tab:

► **Equipment information:**

- **Provider:** Provider's name.
- **Name:** Equipment's name.
- **Serial number:** Unique identification number for this equipment.
- **Release:** Version of the software installed on the equipment.
- **Date:** Date of the software and hardware installed on the equipment.
- **Free System memory:** Free size of the flash memory installed on the equipment / Size of the flash memory installed on the equipment for system.
- **Free Data memory:** Free size of the flash memory installed on the equipment / Size of the flash memory installed for data.
- **Company:** Name of the company which owns the equipment (editable by user; protected by PIN code). This field appears on the boot screen.
- **User:** Name of the equipment's user (editable by user; protected by PIN code). This field appears on the boot screen.





► **Appearance Options:**

- **Language:** Language used on menus, messages and screens. Available languages are: Spanish, Catalan, English, German, French, Czech, Italian, Norwegian, Polish, Russian and Slovak. Once the new language is selected, the equipment shows a warning message and re-starts in order to load the new language.
- **Skin:** Colours used on the screen.
- **Power Off:** It allows the user to select the time to power off, which is the time after which the equipment shuts down automatically unless user press any key.
- **Brightness:** User can select between two options:
  - **Manual:** The display brightness is adjusted manually using the brightness setting (see section **Video and audio settings**).
  - **Automatic:** The display brightness is automatically adjusted according to the light received by the sensor.
- **Background:** It allows the user to select the background colour on the display screen. Options available are: white, green, red, black and blue.
- **Battery Time:** It hides or shows the remaining battery time. Remaining battery time is displayed on the inside of the battery level icon.
- **TFT Screen:** User can select a time after which the TFT screen turns off, but the equipment is still running normally. The screen turns on by pressing any key. Time options are: off, 1, 5, 10 or 30 minutes.
- **Color System:** The coding system used in analogue transmissions. Available options are: PAL 50 Hz, PAL 60 Hz, PAL-M, NTSC and SECAM.
- **Boot Screen:** User can select the image that appears when the equipment is booting.
- **Values Format:** It allows the user to select the format to show on fields PID, NID, ONID, TSID and SID in TV mode screen 3/3. Available formats are decimal or hexadecimal.

► **Time & Date Options:**

- **Date:** It allows the user to edit the date. Press the joystick for edit mode.
- **Time:** It allows the user to edit the time. Press the joystick for edit mode.

- **Date Format:** It allows the user to change the date format, which is the order in which is shown day (DD), month (MM) and year (YYYY or YY).
- **Time Zone:** It allows the user to select the time zone where he is.
- ▶ **Measures Options:**
  - **Terrestrial Units:** It allows the user to select the terrestrial measurement units for the signal level. Available options are: dBm dBmV and dBμV.
  - **Satellite Units:** It allows the user to select the satellite measurement units for the signal level. Available options are: dBm, dBmV and dBμV.
  - **Optical Units:** It allows the user to select the optical measurement units for the signal level. Available options are: dBm.
  - **Satellite Band:** It allows the user to select the type of satellite band used between Ku/Ka band and C band.
  - **Reference Level:** It allows the user to select the type of reference level adjustment between manual (modified by the user) or automatic (selected by the equipment).
  - **TER. Downlink:** If this option is enabled it allows you to set a local oscillator in terrestrial band and it displays intermediate and downlink (DL) frequencies. It allows you to work with terrestrial radio-links or frequency converters.
  - **Min. TER. Power:** It sets the minimum power for a terrestrial digital signal to be identified when channel exploring.
  - **Min. SAT. Power:** It sets the minimum power for a satellite digital signal to be identified when channel exploring.
  - **Min. TER. Level:** It sets the minimum level for a terrestrial analogue signal to be identified when channel exploring.
  - **Min. FM. Level:** It sets the minimum power for a FM signal to be identified when channel exploring.
  - **Inp. Impedance:** It allows the user to select the impedance at the RF input between 50 Ω and 75 Ω.



► **Tools Options:**

■ **Datalogger**

**PSI:**

If you select the option "**Capture**", when datalogger is working it captures the service list of each channel. This process slows the datalogger, but provides additional information that can be downloaded in XML files. To disable this option select "**Don't capture**".

■ **Database services:**

When it is enabled, it saves all the services been detected in the current installation. There is a database for services in terrestrial band and another for services in satellital band. Services are included automatically when the signal is locked. If enabled, these services will be displayed on the "**View all services**" option in the **Tuning**  menu. When disabling the option all services in the database of the installation will be deleted.

- **Export button:** It allows the user to select the data to be exported when pressing the export key among the following options: screen only, data only or both. More info in the "Export key" chapter.

■ **LTE Filter**

**F.Min:**

Select the minimum frequency for the external LTE filter.

■ **LTE Filter**

**F.Max:**

Select the maximum frequency for the external LTE filter.

■ **Center Freq:**

User can set the center of frequency to **Manual or Auto mode**. In Manual mode the user sets the center of frequency and the equipment does not change it never, so the main cursor can be moved out of screen. In Auto mode the equipment changes the center of frequency to display always the main cursor on screen.

► **StealthID Options:**

It allows the user to select the set of signal types being used while auto identifying any modulation type. More information in the "StealthID function" chapter.

► **Security Options:**

It allows the user to change the PIN code that gives access to protected data fields. The default PIN code is "1234". To change the PIN, first enter the current PIN code, then enter the new PIN.

In case the user forgets the PIN, after the third attempt, a 12-digit code will appear on screen. Sending this 12 digit code to the PROMAX customer service, the user will recover the PIN.



### ► IPTV Options:

Network parameters that user has to fill out in order to register the equipment into a data network. This is necessary to receive IPTV signal. Network parameters are:

- **MAC:** Physical address of the equipment. It is unique and cannot be edited.
- **DHCP:** Enable this option to get the proper IP address when the unit is first connected to a network. That feature contributes to make things easier to installers when debugging network access. Enable the DHCP protocol for proper IP configuration.
- **IP Address:** IP Address of the equipment into the local network.
- **Mask:** Subnet mask of the equipment (by default 255.255.255.0).
- **Gateway:** IP Address of the router into the local network (by default 10.0.1.1).
- **IGMP Version:** Protocol for multicast transmissions used by the router. Available versions are 1, 2 and 3. To disable select Off.
  - **IGMPv1:** IGMP version 1. Each time user selects a multicast address, meter asks for the new multicast stream.
  - **IGMPv2:** IGMP version 2. Each time user selects a multicast address, meter stops receiving the current stream and asks for receiving the new one.
  - **IGMPv3:** IGMP version 3. Each time user selects a multicast address, meter stops receiving the current stream and asks for receiving the new one, from the servers approved by the user.
  - **Off:** Meter does not send any IGMP messages and discards the received ones.

### ► Network Options:

Network parameters that user has to fill out in order to identify the equipment into a data network. This is necessary to connect to a PC via ethernet. Network parameters are:

- **MAC:** Physical address of the equipment. It is unique and cannot be edited.
- **DHCP:** Enable this option to get the proper IP address when the unit is first connected to a network. That feature contributes to make things easier to installers when debugging network access. Enable the DHCP protocol for proper IP configuration.



- **IP Address:** IP Address of the equipment into the local network.
- **Mask:** Subnet mask of the equipment (by default 255.255.255.0).
- **Gateway:** IP Address of the router into the local network (by default 10.0.1.1).





## 4 RF SIGNAL TUNING (Terrestrial and Satellite Band)

### 4.1 Introduction

On the panel left side, the equipment has three functions keys, which give direct access to three ways to display RF signal.

 **MEASUREMENT:** This mode shows main measures of RF signal and allows you to identify if any measure is above or below usual values.

 **SPECTRUM ANALYZER:** This mode shows spectrum and allows you to visually identify any anomalies over the RF signal.

 **TV:** This mode shows RF signal demodulated and allows you to check broadcasting quality for video and audio.

Pressing a key repeatedly provides access to a different view within the same mode displaying different windows. Each view combines several RF modes (demodulated, spectrum, measures) which is very convenient to identify problems.

The StealthID function is an auto-identification system which identifies type and characteristic parameters of the signal and then tries to tune and demodulate it with no need to enter any parameter by hand.

### 4.2 Operation

- 1 Connect the RF input signal to the equipment.
- 2 Press the "Settings" key to access Settings menu and in "Source Signal" select "RF".
- 3 From Settings menu access the "Band" option and select "Terrestrial" to work on terrestrial band or "Satellite" to work on satellite band.
- 4 Select the display mode by pressing the MEASUREMENT, SPECTRUM ANALYZER or TV mode. Pressing a key repeatedly provides access to different views.
- 5 Enter frequency or channel using the "Tuning" (F1) menu or using the joystick to go left or right along the frequency / channel band.
- 6 Once you are placed on the channel or frequency, the StealthID function tries to identify and lock the signal and its characteristic parameters and will show results on screen.



### 4.3 General Menu Options

At the bottom of the screen four menus are accessible via the softkeys or programmable keys.



It displays the channel where is pointing the cursor and gives access to the tuning menu.



It displays the selected transmission standard and gives access to the signal parameters menu.



It displays the Tools menu.



It displays the Advanced menu.

In general, these options are the same for all modes (Measure, Spectrum Analyzer and TV).

The specific options for a mode are placed in the menu "Advanced" pressing the  key. For more details about these options go to section "Specific Options" in the chapter.



Next each one of these menus is described.

#### 4.3.1 F1: Tuning – Selecting Channel / Frequency

Access by the function  key. It contains the options to tune a channel.

The tuning menu consists of the following options:

- ▶ **Channel/Frequency:** It displays the channel/frequency pointed by the cursor. Tuning type (channel/frequency) is selected by means of the **Tune by** option.
- ▶ **Channel Plan:** This option allows the user to select a channel plan from the ones available for the current installation.
- ▶ **Tune by:** It allows the user to select between tuning by channel (selecting a channel or channel by channel with the joystick) and tuning by frequency (selecting a frequency or step by step with the joystick).

- 
- In case of **tuning by channel**, it allows selecting a channel from the active channel plan:
    - 1 Place over the **Channel** option and press the joystick.
    - 2 A box appears with all channels of the active channel plan and its frequency.
    - 3 Move the joystick on the box to select a channel.
    - 4 When finished press joystick to save the selected value or any function key to exit without saving.
    - 5 The cursor will place on the selected channel and it will appear on the  option.
  - The channel can be changed directly with the joystick in CH mode.

**NOTE:** When using tune by channel on satellite, the polarity parameters (horizontal/vertical and left/right) and satellite band (high/low) are selected automatically by the equipment, according to the channel plan enabled and cannot be changed by the user. To change these parameters, the user may switch to frequency tuning. But the user can change the voltage output while in a channel plan, as long as none has been defined in that same channel plan. For instance, if a standard channel plan is being used like the CCIR, there is now need for switching to frequency tuning mode or make special channel plans for using active antennas.

- In case of **tuning by frequency**, the frequency can be edited:
  - 1 Place over the **Frequency** option and press the joystick.
  - 2 The option is highlighted in yellow to indicate it is in edit mode.
  - 3 Move the joystick left/right to move between the figures and up/down to change the figure.
  - 4 When finished press joystick to save the selected value or any function key to exit without saving.
- The frequency can be changed directly with the joystick in **FR** mode in 50 kHz steps.



[Click here to watch this video: Manual input of frequencies](#)





- ▶ **Center Frequency:** This option is available only for the Spectrum Analyzer mode. It allows to edit the center frequency. The center frequency is the frequency at which the screen is centered.
  
- ▶ **Reference level:** This option is available only for the Spectrum Analyzer mode. It allows to edit the reference level. The reference level is the power range represented on the vertical axis.
  - The **Reference Level** can be changed directly pushing the joystick up or down.
  
- ▶ **Span:** This option is available only for the Spectrum Analyzer mode. It allows to edit the span, which is the frequency range displayed on screen.
  - The span can be changed directly with the joystick in **SP** mode.
  
- ▶ **Center tuned frequency:** This option is only available for the Spectrum Analyzer mode. When selecting this option, the frequency tuning (where the main cursor is pointing) is placed at the center of the screen. This option does not work with FULL span or if main cursor is very close to terrestrial or satellite band boundaries.
  
- ▶ **Downlink:** This option is available only if the option Ter. Downlink in Preferences menu has been enabled. If this option is enabled it allows you to set a local oscillator in terrestrial band and it displays intermediate and downlink (DL) frequencies. It allows you to work with terrestrial radio-links or frequency converters.
  
- ▶ **View all services:** This option only appears if the **Database services** option is enabled in the **Preferences** menu. This option displays a window with a list of services that have been detected in the current installation. The list shows service name, provider, SID (stream identifier) and an icon that shows its type (radio, tv) and if it is scrambled. When hovering on the service for one second it displays a hint window with more information. If user presses the joystick on a service, it will access that service.

When disabling the **Database services** option, all services in the installation will be deleted from the list. At the bottom of this option are shown the softkeys with these functions:



**Cancel:** It exits the option.



**Filter List:** It shows several options to filter the list of services: By access (Free Only, Scrambled Only, All); By type (All, TV, Radio); Search by name (filtered by the name); Reset list (it restarts the list as at first) Service filtering is persistent until resetting.



**Page Up:** It jumps one page up.



**Page Down:** It jumps one page down.

#### 4.3.2 **F2: Signal Parameters**

Access by the  function key. It allows selecting the standard transmission and displays the parameters for signal transmission.

This menu allows selecting the transmission standard:

► **Type of signal:** It displays the selected standard. It allows selecting another standard in the same band (terrestrial or satellite):

- 1 Place over the **Signal Type** option and press the joystick.
- 2 It displays a menu at the right with the transmission standards.
- 3 Move the joystick up / down to select a standard.
- 4 Press joystick to select the standard or any function key to exit without selecting.

► **View Advanced**

**Parameters:** It shows the TPS parameters (Transmission Parameters Signalling) for the locked signal according to the modulation standard. This option is available only when these parameters are detected.

- The remaining transmission parameters are detected demodulating the locked signal.
- In case of a DVB-S/S2 signal, the symbol-rate parameter can be set manually.



- In case of a DVB-S2 signal, there will be some special settings for this type of signal. They are:

Physical Layer Scrambling or PLS is used in DVB-S2 as a way to improve data integrity. A number called the "scrambling sequence index" is used by the modulator as a master key to generate the uplink signal. This same number must be known by the receiver so that demodulation is possible.

Most satellite transponders use PLS 0 as a default value but there are some transponders that use other values.

If it is a multistream signal (MIS), it will appear an option that enables filtering by the input stream identifier (ISI) and to select the stream to demodulate.

When a satellite transponder is working with a non-zero PLS code plus MSI (multiple streams), system will lock that signal in a quite automatic way.



[Click here to watch this video: DVB-S2 multi stream decoding](#)





- In case of a Generic signal, the menu shows an option to select the signal bandwidth.

### 4.3.3 F3: Tools

Access by the  key. It shows the Tools menu. If an specific tool is not available for the signal locked then the option is disabled. Tools are:

- ▶ **Select Service:** It displays the list of services available in the multiplex tuned, with the service name, icons that identify the service type, SID (stream identifier) and LCN (logic channel number).

Icons that appear next to the service name identify the features of the service. The meaning is given in the following table:

	<b>Digital TV service</b>		<b>High Definition TV service</b>
	<b>Digital radio</b>		<b>Data</b>
	<b>Scrambled service</b>		

- 
- ▶ **Signal monitoring:** This tool allows the user to monitor a signal by measuring its power, MER and C/N. All this data, can be downloaded to a PC and exported to a file for later analysis. In this file are saved all characteristics measurements for each type of signal.
  - ▶ **Signal coverage:** This option allows the user to check signal coverage by measuring its power, MER and C/N. The position where all these measurements are taken is determined by a GPS receiver\*. All this data, measurements and GPS position can be downloaded to a PC and exported to a file for later analysis.
  - ▶ **Explore channel plan:** It explores the selected channel plan. Tune by channel must be selected.
  - ▶ **Constellation:** It displays the constellation of the locked signal.
  - ▶ **LTE Ingress Test:** It enables the detection of signal interferences coming from mobile phones.
  - ▶ **Attenuation test:** This feature allows the user to easily check the response of the telecommunications installations before antennas and headers are working.
  - ▶ **Datalogger:** It creates a file in which are stored measurements. This file belongs to the selected current installation.
  - ▶ **Spectrogram:** This function shows a graphical representation of the spectrum superimposed over time of a channel or frequency selected by the user.
  - ▶ **Discover FM Stations:** This function scans the FM band and creates a FM channel plan from scratch. Scanned frequency range is from 87 to 108 MHz.
  - ▶ **Field strength:** This tool allows the equipment to measure as a field strength meter.



- ▶ **Task Planner:** It allows the user to schedule specific tasks.
- ▶ **TS Analyzer:** This tool allows the user to make a comprehensive analysis of the Transport Stream (TS) contained in a tuned signal.
- ▶ **TS Recording:** This tool can capture in real time the received transport stream (TS) contained in the received signal.
- ▶ **Shoulder Attenuation:** This utility measures the shoulder-shaped interferences in the adjacent channels.

For more information about these features, see the "**Tools**" chapter.

#### 4.4 **Advanced Options**

Access by the  function key. It allows selecting among several parameters related to mode selected.

The advanced menu in the **Spectrum Analyzer** mode consists of the following options:

- ▶ **Average:** The user can select the amount of signal values to be used to set the average signal value to be displayed on screen. The larger the average value, the more stable the displayed signal appears.
- ▶ **Spectrum Line:** It defines the spectrum display. Outline option displays the spectrum outline. The Solid option displays the contour of the spectrum with solid background. The **Transparence** option shows the outline in yellow and the background in a softer yellow.
- ▶ **Tone Level:** This option produces a tone that changes according to the input level of the signal so the tone is sharper if the level increases and deeper if the level decreases.
- ▶ **Marker:** It allows enabling/disabling the marker. This marker is displayed on screen with the shape of an arrowhead, showing on screen some information about the frequency and power level where it points. You can move left/right by the joystick in **MK** mode (press the joystick until the icon **MK** appears).  
When the Marker is ON at the top right corner a window pops up with the following data:
  - Freq:** Frequency where is placed the marker.
  - Level:** Power level at the frequency where is placed the marker.
  - ΔF:** Difference of frequency between the marker and the main cursor.
  - ΔL:** Difference of power level between the marker and the main cursor.



- ▶ **Marker Trace:** It allows the user to select the trace to place the marker on:
  - Normal:** It places the marker on the spectrum trace in real time.
  - Reference:** It places the marker on the spectrum reference trace. To make a spectrum reference use the **Reference** function.
  - Max. Hold:** It places the marker on the max. hold trace. To make a maximum hold trace use the **Max. Hold** function.
  - Min. Hold:** It places the marker on the min. hold trace. To make a minimum hold trace use the **Min. Hold** function.
  
- ▶ **Max. Hold:** (Off/Permanent/Curtain). It allows the user to display the current signal with the maximum values measured for each frequency. The **OFF** option disables this function. The **Curtain** option displays the maximum values in blue for a moment with the current signal. The **Permanent** option maintains maximum signal on the screen. This option is especially useful for detecting sporadic noises.
  
- ▶ **Min. Hold:** (Off/Permanent/Curtain). It allows the user to display the current signal with the minimum values measured for each frequency. The **OFF** option disables this function. The **Curtain** option displays the minimum values in green for a moment with the current signal. The **Permanent** option maintains minimum signal on the screen. This option is useful for detecting interferences in TV cable or identify deterministic interference in analogue and digital channels.
  
- ▶ **Persistence:** When active, the signal is displayed on a coloured background. The signal prior to current signal persists for a while before disappearing so the user can see how the signal changes easily.
  
- ▶ **Detector Type:** (PEAK / RMS). It allows the user to select between maximum PEAK detector or RMS detector. The maximum peak detector is mainly used for analogue modulated signals, while the RMS option is the right choice for digital modulated signals. The max PEAK detector is mostly used for analogue modulated signals, while the RMS is the proper choice for digital modulations. The maximum peak detector causes the noise floor to rise, according to the RMS to peak ratio. That same effect causes digital signals to apparently grow in level when maximum peak detector is used.
  
- ▶ **Resolution bandwidth:** Resolution filters available. For terrestrial and satellite: 100, 200 and 1000 kHz. According to the filter being selected, that maximum and minimum span allowed is modified.

- ▶ **Vertical Range:** It allows to adjust the vertical scale on screen. Available values are 1, 2, 5 and 10 dB per division.
- ▶ **Dashed BW:** When it is ON the channel bandwidth area is hatched by lines.
- ▶ **Reference:** (Set / Clear). It memorizes the current trace on screen, which can be used as a reference for further comparison. It may be also very helpful for visually measure the gain or attenuation in a TV distribution network. To delete the reference, select the "clear" option. The trace can be also captured by a short press on the **export** key in the Spectrum Analyzer mode. Pressing short again on the export key it clears the reference.

The Advanced menu of the **TV mode** consists of the following options:

▶ **Analogue Signal**

This option is available only if the detected or selected signal is ANALOGUE.

Pressing the F3 key  it allows selecting the type of analogue input, between antenna (via RF connector) and external (via V/A input connector).

To get an external analogue signal use the A/V input (see [figure 5](#)).

▶ **Aspect Ratio**

This option is available only if the detected or selected signal is ANALOGUE.

It allows the user to select the image aspect ratio (4:3; 16:9). It remembers this selection even after switch off.

▶ **Advanced**

It gives access to these options:

This option is available only if the detected or selected signal is DIGITAL.

- **Audio:** It allows the user to select among the audio tracks available.
- **TS Data:** It shows the IRG data descriptor. If the signal contains this carrier identifier, this option will be enabled. If the signal does not contain this identifier, the option will be disabled (for more information refer to section "IRG descriptor").
- **Discovered URLs:** If shows the URL related to the interactive service.

4.5 Screen Description

4.5.1 Measurement Mode Screens

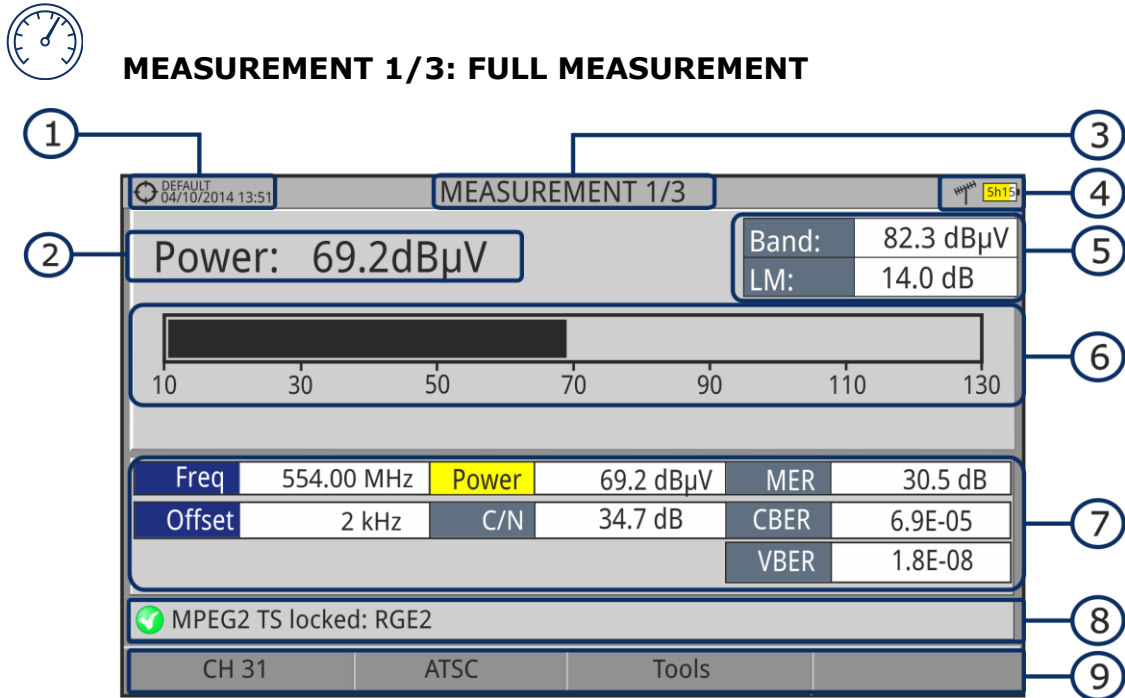

Figure 36.

- 1 Selected installation, date and time.
- 2 Measurement value of the selected parameter. To change parameter move joystick up / down.
- 3 Number of view/total views.
- 4 Selected band, battery level.
- 5 Total power detected over the whole selected band (terrestrial or satellite). It also shows the link margin measurement. The total power can be used to know when it is close to saturation. The link margin is the margin of safety remaining for a good reception.
- 6 Graphical measurement of the selected parameter.
- 7 Measurement values for the type of locked signal.
- 8 Signal status (searching/locked/multiplex name).
- 9 Softkeys menus.

- ▶ **Joystick up/down:** It changes selected parameter.
- ▶ **Joystick left/right:** It changes channel/frequency.





**MEASUREMENT 2/3: MEASUREMENT + TV + SPECTRUM**

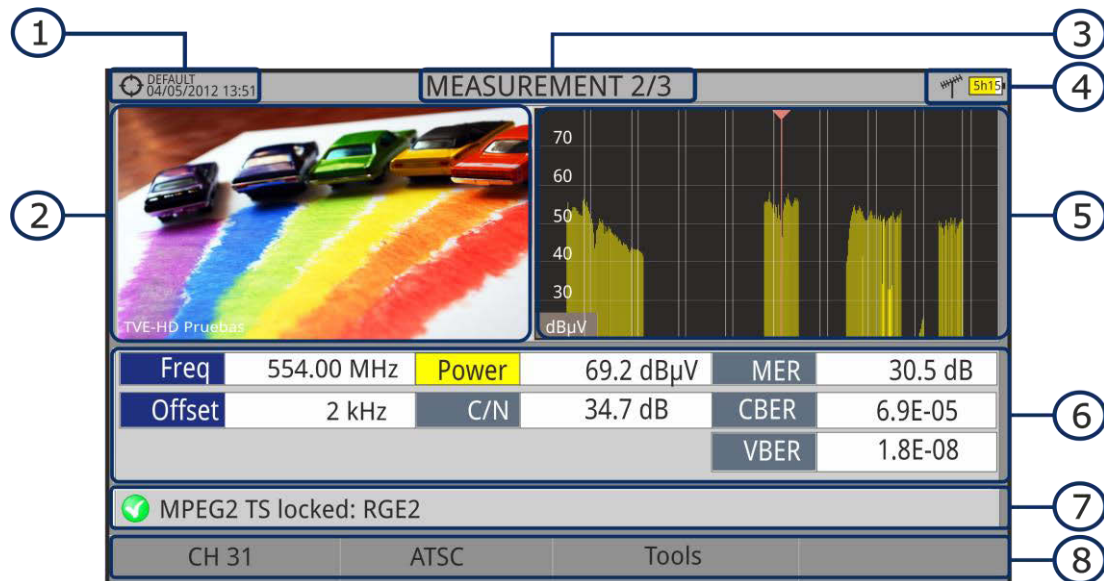

**Figure 37.**

- 1 Selected installation, date and time.
- 2 Image of the locked signal.
- 3 Number of view/total views.
- 4 Selected band, battery level.
- 5 Spectrum of the locked signal.
- 6 Measurement values for the type of locked signal.
- 7 Signal status (searching/locked/multiplex name).
- 8 Softkeys menus.

► **Joystick right/left:** It changes the selected channel/frequency.



**MEASUREMENT 3/3: MEASUREMENT + PARAMETERS**

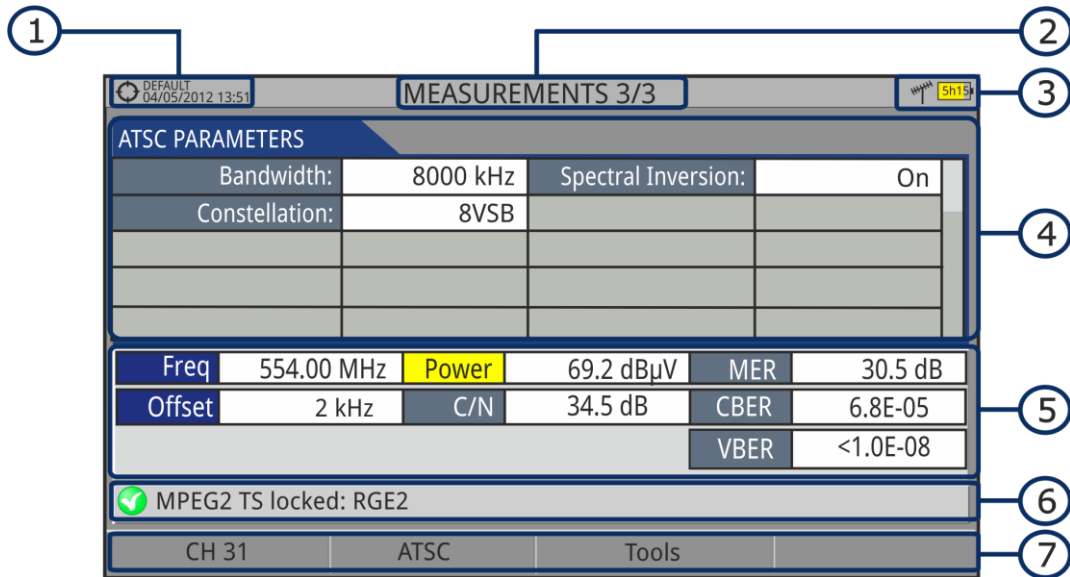

**Figure 38.**

- 1 Selected installation, date and time.
- 2 Number of view/total views.
- 3 Selected band, battery level.
- 4 Demodulation parameters of the locked signal.
- 5 Measurement values for the type of locked signal.
- 6 Signal status (searching/locked/multiplex name).
- 7 Softkeys menus.

► **Joystick right/left:** It changes the selected channel/frequency.

## 4.5.2 Spectrum Analyzer Mode Screens



### SPECTRUM 1/3: SPECTRUM + MEASUREMENT

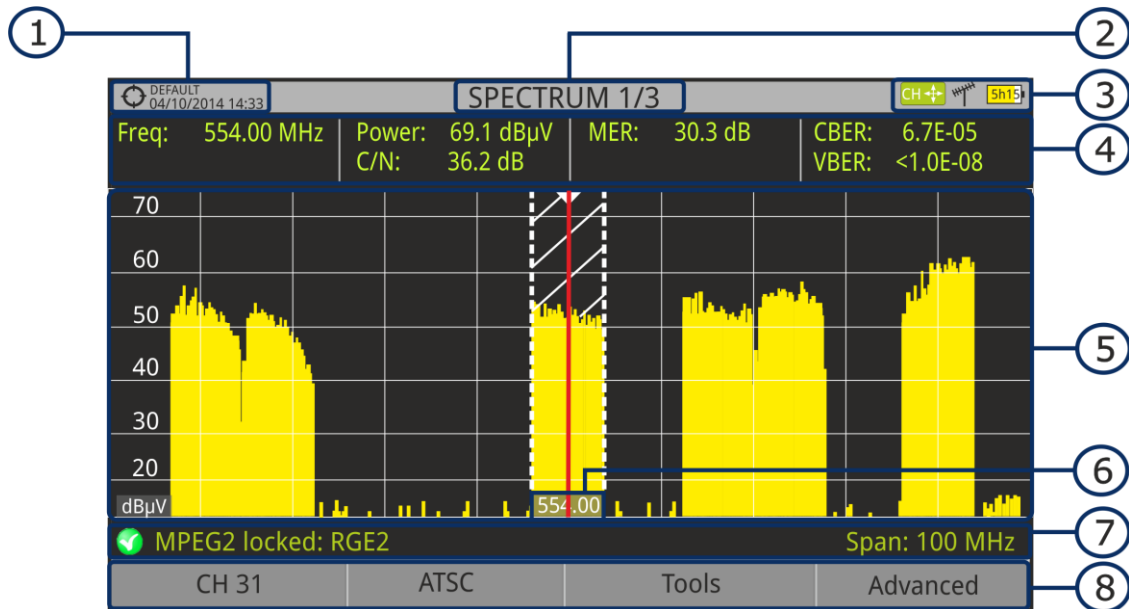

**Figure 39.**

- ① Selected installation, date and time.
- ② Number of view/total views.
- ③ Joystick active mode, selected band, battery level.
- ④ Measured values of the signal at the frequency/channel where is pointing the cursor.
- ⑤ Spectrum in the band with the selected span.
- ⑥ Centre frequency and cursor. It also shows the bandwidth of a digital locked signal.
- ⑦ Signal status (searching/locked/multiplex name/selected span).
- ⑧ Softkeys menus.

► **Joystick up/down:** It changes the reference level.

► **Joystick left/right** (depending on the joystick active mode):

**SP:** SPAN change.

**FR or CH:** Frequency change or channel change.

**MK:** Marker change (if marker is ON).

 SPECTRUM 2/3: SPECTRUM + MEASUREMENT + TV 

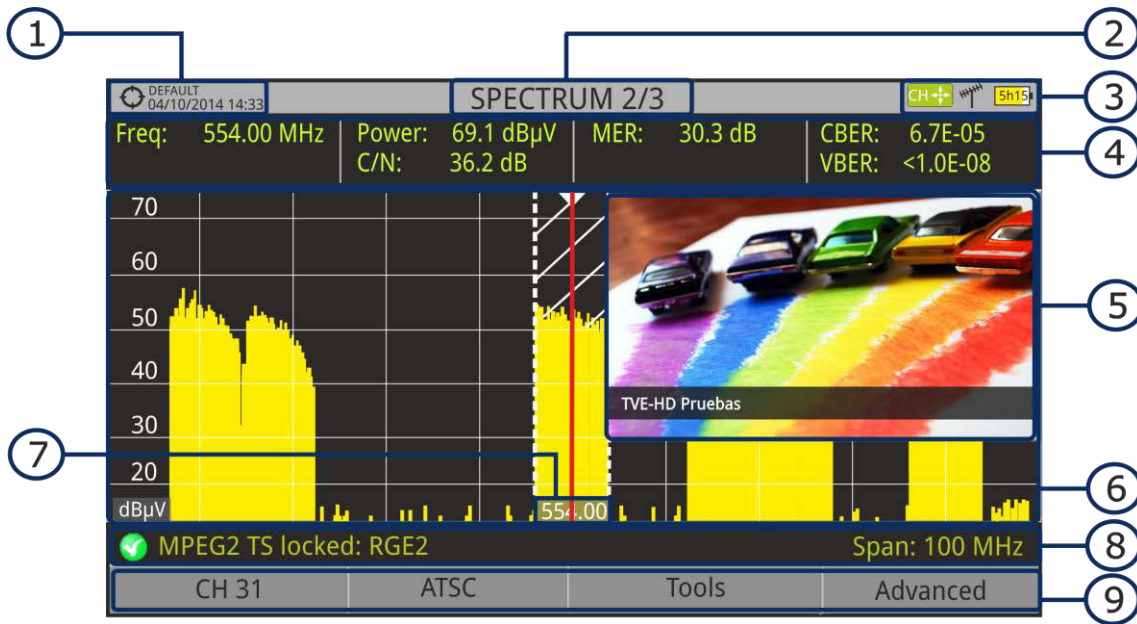

Figure 40.

- ① Selected installation, date and time.
- ② Number of view/total views.
- ③ Joystick active mode, selected band, battery level.
- ④ Measured values of the signal at the frequency/channel where is pointing the cursor.
- ⑤ Image of the tuned signal.
- ⑥ Spectrum in the band with the selected span.
- ⑦ Centre frequency and cursor. It also shows the bandwidth of a digital locked signal.
- ⑧ Signal status (searching/locked/multiplex name/selected span).
- ⑨ Softkeys menus.

► **Joystick up/down:** It changes the reference level.

► **Joystick left/right** (depending on the joystick active mode):

**SP:** SPAN change.

**FR or CH:** Frequency change or channel change.

**MK:** Marker change (if marker is ON).

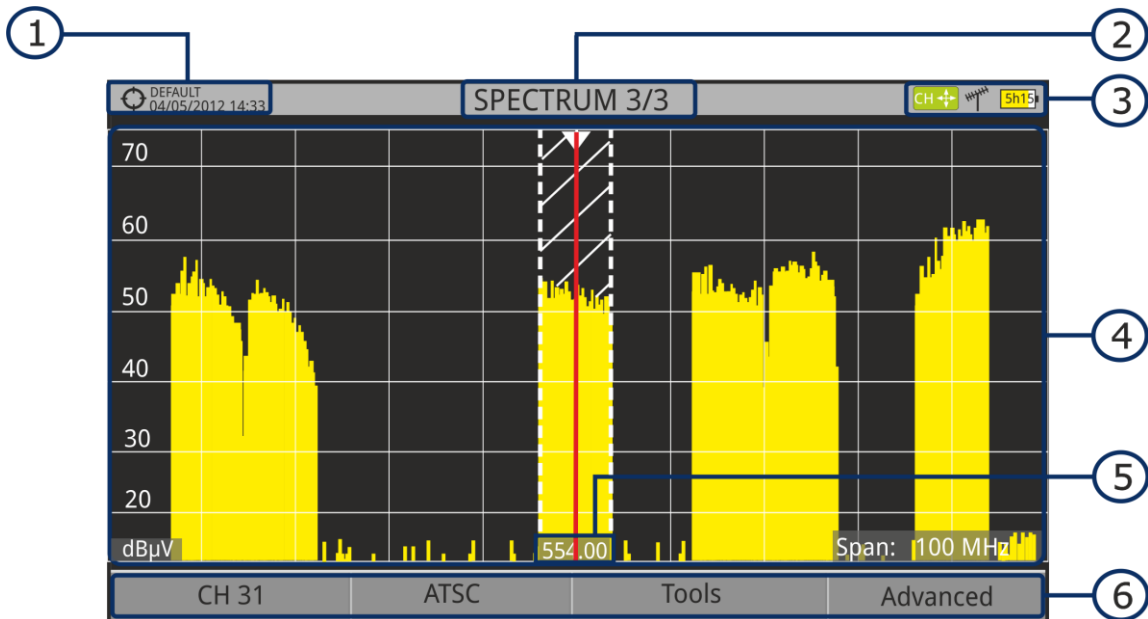
**SPECTRUM 3/3: FULL SPECTRUM**

**Figure 41.**

- ① Selected installation, date and time.
- ② Number of view/total views.
- ③ Joystick active mode, selected band, battery level.
- ④ Spectrum in the band with the selected span.
- ⑤ Centre frequency and cursor. It also shows the bandwidth of a digital locked signal.
- ⑥ Softkeys menus.

► **Joystick up/down:** It changes the reference level.

► **Joystick left/right** (depending on the joystick active mode):

**SP:** SPAN change.

**FR or CH:** Frequency change or channel change.

**MK:** Marker change (if marker is ON).

\* Only available for **digital channels**.

► Full Spectrum screen description

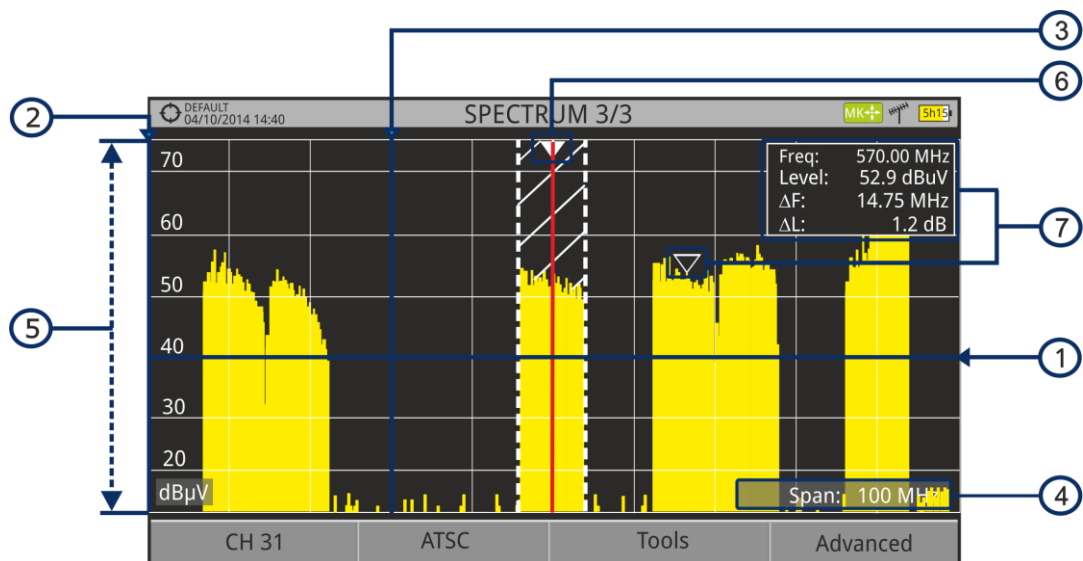

Figure 42.

① **Horizontal reference line**

It indicates the signal level.

② **Vertical axis**

It indicates the signal level.

③ **Vertical reference line**

It indicates the frequency.

④ **SPAN**

It is the frequency range displayed on the horizontal axis.

The current span value appears at the bottom right of the screen. To change use the joystick (left, right) in span mode (SP) or change it by the "span" option in the Tuning menu (F1 key).

Using the *joystick*, span values available are: Full (full band), 500 MHz, 200 MHz, 100 MHz, 50 MHz, 20 MHz and 10 MHz.

Using the "span" option in the Tuning menu it is possible to use any span value between 10 Hz and FULL.

Tune by frequency works in 50 kHz steps or by frequency selection.

⑤ **Reference Level**

It is the power range represented on the vertical axis.

To change use the joystick (up, down; 5 dB steps).

This equipment has an option to activate the automatic adjustment of the reference level, so it detects the optimal reference level for each situation. In automatic mode, it sets the optimum reference level each time it enters the spectrum mode. This option can be enabled or disabled through the **PREFERENCES** menu and **Measures** tab.



## 6 **Cursor**

Red vertical line that indicates position during the channel or frequency tuning.

When a digital signal is detected, there is a triple cursor that shows the frequency for the signal locked and two vertical lines that shows the bandwidth of the digital carrier.

In the case of a GENERIC signal, the bandwidth shown is the one selected by the user on the "Signal Parameters" menu when pressing the **F2** key.

To change frequency/channel use the joystick (left, right) in FR mode (tuning by frequency) or CH mode (tuning by channel).

## 7 **Marker**

It is a special cursor that can be placed on a given frequency to check the power in this point.

This option can be enabled using the "Marker" option from the Advanced menu (**F4** key). To change use the joystick (left, right) in MARKER (MK) mode.

The window Marker shows the following data:

**Freq:** Frequency where is placed the marker.

**Level:** Power level at the frequency where is placed the marker (in case of working with FSM tool, it shows FSM level).

**ΔF:** Difference of frequency between the marker and the main cursor.

**ΔL:** Difference of power level between the marker and the main cursor.

## 8 **Centre frequency**

Frequency at which the screen is centered. This frequency can be set through the **Tuning** **F1** menu. It also changes when moving the cursor out of the screen.

4.5.3 TV Mode Screens

4.5.3.1 TV views



TV 1/3: FULL TV

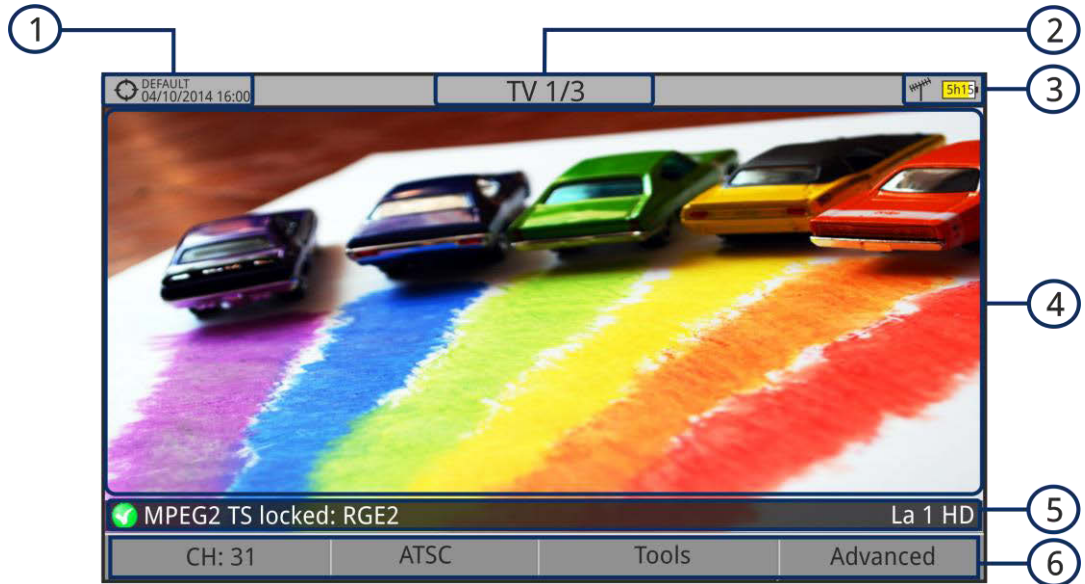

Figure 43.

- 1 Selected installation; date and time.
- 2 Number of view/total views.
- 3 Selected band, battery level.
- 4 Tuned service image.
- 5 Signal status (searching/locked/multiplex name) and name of the selected service.
- 6 Softkeys menus.

► **Joystick up/down:** It changes service.

► **Joystick left/right:** It changes channel/frequency (depending on the tuning mode).





**TV 2/3: TV + SPECTRUM + MEASUREMENT** \*

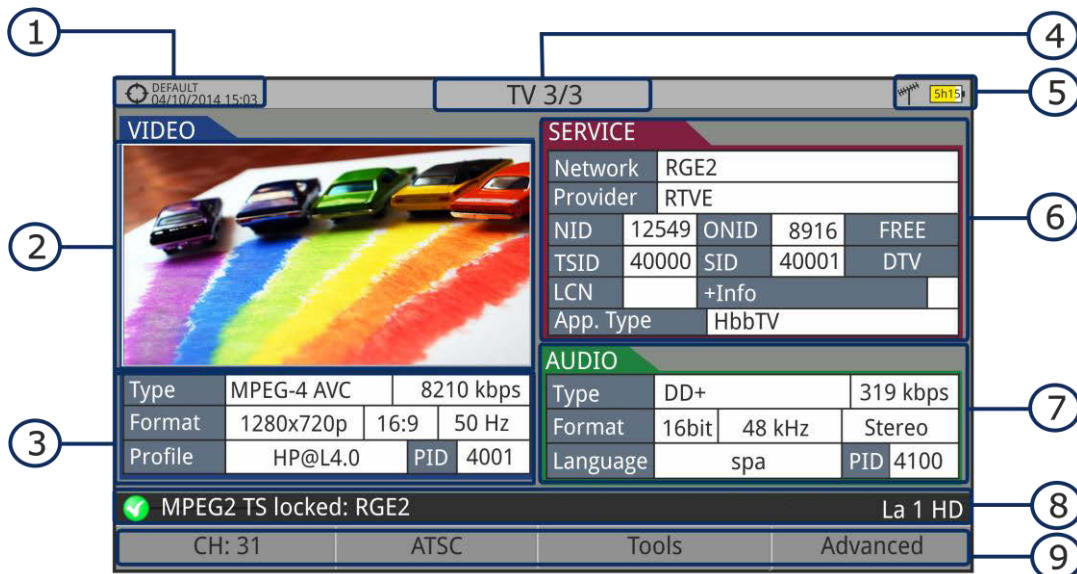

**Figure 44.**

- 1 Selected installation; date and time.
- 2 Number of view/total views.
- 3 Selected band, battery level.
- 4 Tuned service image.
- 5 Spectrum.
- 6 Measured values of the signal in the frequency/channel the cursor is pointing.
- 7 Signal status (searching/locked/multiplex name) and name of the selected service.
- 8 Softkeys menus.

► **Joystick up/down:** It changes service.

► **Joystick left/right:** It changes channel/frequency (depending on the tuning mode).

\* only available for digital channels



TV 3/3: SCREEN TV + SERVICE DATA \*

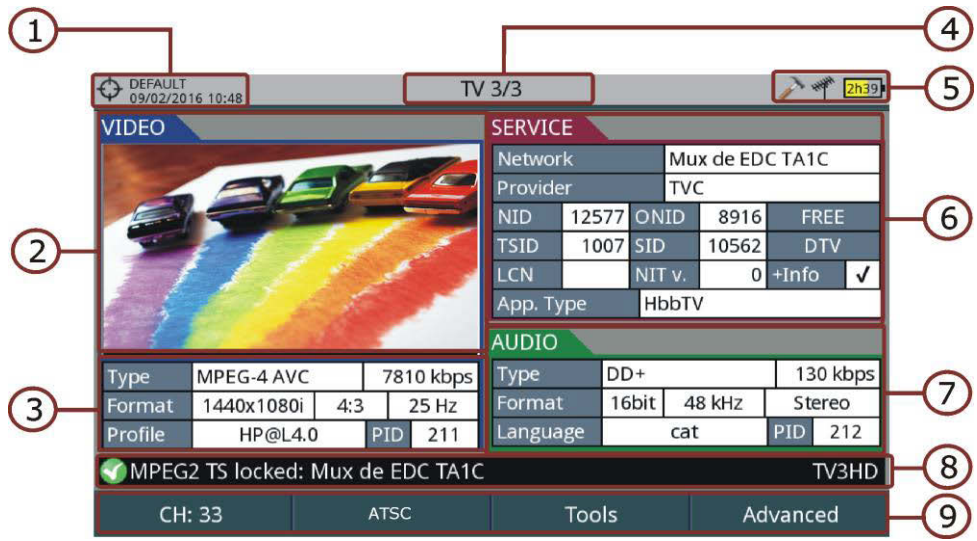

Figure 45.

- 1 Selected installation; date and time.
- 2 Tuned service image.
- 3 Tuned service information.
  - ▶ **TYPE:** Encoding type and video transmission rate.
  - ▶ **FORMAT:** Resolution (horizontal x vertical), aspect ratio and frequency.
  - ▶ **PROFILE:** Profile level.
  - ▶ **PID:** Video program identifier.
- 4 Number of view/total views.
- 5 Selected band; battery level.
- 6 Tuned service information.
  - ▶ **NETWORK:** Television distribution network (Terrestrial). Orbital position (Satellite).
  - ▶ **PROVIDER:** Program provider name.
  - ▶ **NID:** Network identifier where the signal is distributed.
  - ▶ **ONID:** Identifier of the original network where the signal originates.
  - ▶ **TSID:** Transport stream identifier.
  - ▶ **SID:** Service Identifier.
  - ▶ **App. Type:** Type of detected interactive service such as HbbTV, MHP and MHEG-5. It also shows the URL related to the interactive service in F4: Advanced - Discovered URLs.
  - ▶ **LCN:** Logic Channel Number. It is the first logic number assigned to the first channel in the receiver.

\* only available for digital channels



- ▶ **+Info:** Additional service information.
  - ▶ **NIT v.:** Network Information Table version.
  - ▶ **FREE/SCRAMBLED:** Free/scrambled transmission.
  - ▶ **DTV/DS:** Standard type of transmission.
- 7 Tuned audio information.
- ▶ **TYPE:** Type of audio encoding and transmission speed
  - ▶ **FORMAT:** Service audio format. Bit depth; sampling frequency; sound reproduction.
  - ▶ **LANGUAGE:** Broadcasting language.
  - ▶ **PID:** ID of the audio program.
- 8 Signal status (searching/locked/multiplex name) and name of the selected service.
- 9 Softkeys menu.
- ▶ **Joystick up/down:** It changes service.
  - ▶ **Joystick left/right:** It changes channel/frequency (depending on the tuning mode).

**NOTE:** The equipment can identify the HEVC (H.265) signaling and display its transmission data such as the video type, profile format, aspect ratio, bit rate and image. In UHD services will display all transmission data except for the image.

**NOTE:** PID, NID, ONID, TSID and SID fields can be shown in decimal or hexadecimal format. To select this parameter go to "Values Format" in "Preferences" - "Appearance".



4.5.3.2 Radio views



**RADIO 1/3: AUDIO RADIO**



Figure 46.



**RADIO 2/3: AUDIO RADIO + SPECTRUM + MEASUREMENTS**



Figure 47.

**RADIO 3/3: AUDIO RADIO + RDS DATA**

FM RADIO 3/3			
<b>DETAILS</b>			
PS:	SER	ECC:	00 LIC: 00
PI:	E239	TP:	✓ TA: MS:
PTY:	Unknown(3)	PTYN:	
UTC Time:	-----	Local:	----
<b>RADIOTEXT</b>			
A	---		
B			
<b>DECODER ID</b>			
Stereo:	<input checked="" type="checkbox"/>		
Artificial Head:	<input type="checkbox"/>		
Compressed:	<input type="checkbox"/>		
Dynamic PTY:	<input type="checkbox"/>		
<b>ALTERNATIVE FREQS</b>			
Method:	A		
#7	96.9 MHz	98.5 MHz	
101.9 MHz	97.7 MHz	103.1 MHz	
95.7 MHz	93.4 MHz		
FM STEREO, PI: e239, PS: SER			
96.90 MHz		FM	

**Figure 48.**

It shows the most representative RDS data. RDS data are:

- 1 Details:** It has the following fields:
  - ▶ **PS:** Programme service.
  - ▶ **PI:** Programme Identification.
  - ▶ **PTY:** Program type.
  - ▶ **UTC Time:** Universal time.
  - ▶ **Local:** Local time.
  - ▶ **ECC:** Extended country code.
  - ▶ **LIC:** Language Identification Code.
  - ▶ **TP:** Traffic program.
  - ▶ **TA:** Traffic announcement.
  - ▶ **MS:** Music switcher.
- 2 Radiotext:** Extra text information.
- 3 Decoder ID** (decoder identifier): It identifies different operation modes of the decoder.
- 4 Alternative freqs:** It shows alternative frequencies and total number.

## 4.6 Extra Information

### 4.6.1 StealthID Function







The **StealthID** function of the **RANGER Neo** is a signal identification function performed automatically by the equipment without any user intervention.

The equipment tries to identify the channel or frequency of the input signal it receives, and according to the band selected by the user, it applies identifying criteria according to the standards of that band. When the equipment recognizes in the input signal the identification parameters of a standard, it decodes the signal and shows the data of that signal on the screen.

The identification system tries to lock the first signal using the modulation defined in the channel plan for that signal. If after five seconds it fails to lock with that modulation, it starts the wheel for automatic detection. If then it locks in a modulation other than indicated, it generates an internal temporary channel plan to accelerate tuning the same channel later on.

Then, the user only has to follow these steps in order to identify a signal:

#### ► Operation

- 1 Press the **Preferences** key  for 1 second.
- 2 In the **StealthID** tab, select the signal types to auto-identify (see "Menu tree" [figure 7](#)). By default all them are selected. Press the  key to save the changes made and the  key to exit the **Preferences** screen.
- 3 Press the **Settings**  key.
- 4 Select the band (terrestrial or satellite).
- 5 Select a channel or frequency to identify.
- 6 The bottom of the screen shows the message "**Searching for signal**" and the standard transmission checking. Wait a few seconds for the equipment to identify the signal. User can force the auto-identification of a signal by pressing the  key and selecting the type of signal from the menu.
- 7 When the equipment identifies the signal a text shows the detected signal type.
- 8 Press  (Signal Parameters) to see the signal parameters.

#### ► Signals automatically detected

- Advanced Television System Committee (ATSC) Standard
- Digital multi-programme systems for television, sound and data services for cable distribution (J83 Annex B)
- Digital Satellite Television First Generation (DVB-S)
- Digital Satellite Television Second Generation (DVB-S2)



- Digital Satellite Television, exclusive for DirecTV (DSS)
- Digital Cable Television First Generation (DVB-C)
- Analogue terrestrial TV
- Analogue Terrestrial FM

#### 4.6.2 **Generic Signal**

This is a special digital signal that the equipment does not demodulate. It can be used for special signals as DAB/DAB + or COFDM modulation with narrow BW.

In this type of signal the user can select the signal bandwidth by accessing the "Signal Parameters" menu on the  key.

The power measure and C/N ratio is calculated according to the bandwidth selected by the user. The triple cursor shows on screen the BW selected by the user.

#### 4.6.3 **Locking a signal**

- 1 Connect the cable with the input signal to the **RF** input connector.
- 2 Press the **SPECTRUM** key. The spectrum of the signal is displayed.
- 3 Adjust the span (recommended value for a terrestrial signal 50 MHz and for a satellite signal 100 MHz). The current value of the span is at the right bottom of the screen.
- 4 Find the frequency of the signal by moving the joystick left or right to move sweeping the entire band.
- 5 If you know the channel change the tuning by frequency to tuning by channel. The channel mode allows you to navigate from channel to channel, using the selected channel plan.
- 6 When the channel is locked information appears at the bottom left of the screen. A triple cursor shows the detected BW for a digital carrier.
- 7 The equipment automatically detects transmission parameters of the signal and makes the corresponding measurements.



#### 4.6.4 Satellite Identification

The spectrum Analyzer makes easier the fieldwork for engineers when working with SNG mobile units and VSAT communications, since it allows adjusting transmission-reception systems. It also has several functions to identify satellites that avoid any possibility of error. When the signal is locked it identifies the satellite and shows on screen its name.

Often satellite operators request to look for the "Beacon" signal, as a method of satellite identification. This signal is easily identified by the equipment, because it has high resolution, high sensitivity and short sweep times.

Below are two BEACON screenshots signals, with a span of 10 MHz and a bandwidth of 100 kHz resolution, all with a sweep time of 90 ms.

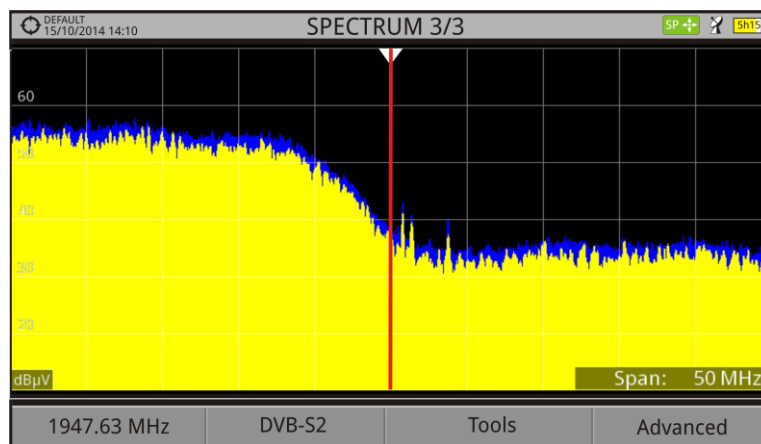

Figure 49.

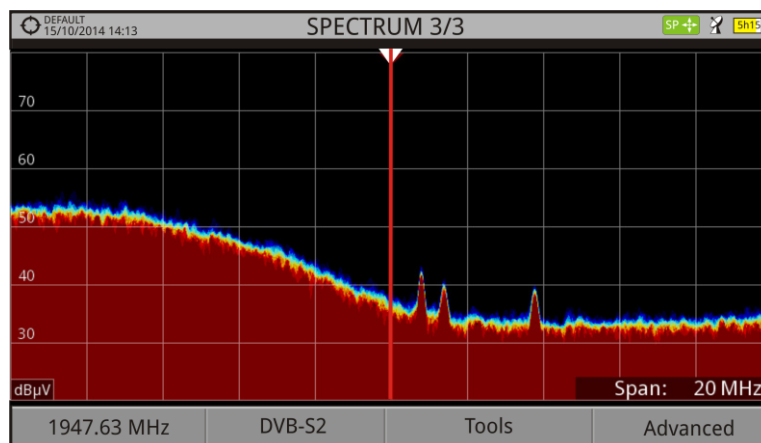

Figure 50.

More data for installations with satellite signals in annex "How to point a dish antenna."



#### 4.6.5 IRG Descriptor

The Analyzer is compatible with IRG recommendations and it can extract the Carrier ID information and display it conveniently showing all the details.

This information is useful to identify the interference, thanks to the carrier ID. This identifier provides enough information to detect the interference source (customer name, contact data, geo coordinates, etc.) and allows the operators to communicate directly with the RFI source to resolve the incident.

**IRG descriptor** function is available only for signals containing the carrier identifier. To access this feature:

- 1 Connect the **RF** input signal to the equipment.
- 2 Tune the channel that produces interferences.
- 3 Access to **TV** mode.
- 4 Press the **Advanced** menu .
- 5 Select the **TS Data** option. If the signal has a carrier identifier, this option is enabled. If the signal does not contain this identifier, this option is disabled.
- 6 The **IRG descriptor** window is displayed with the data about the provider (see figure below).

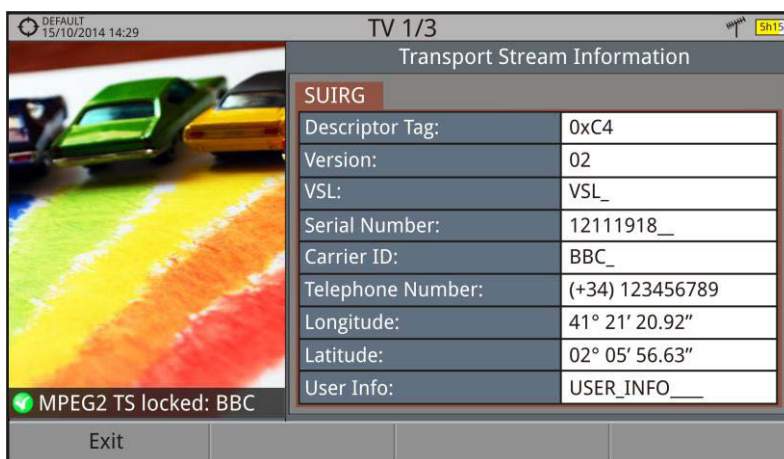

**Figure 51.**

## 4.7 Tools

### 4.7.1 Constellation

#### 4.7.1.1 Description

The constellation diagram is a graphic representation of the digital symbols received over a period of time. There are different types of constellation diagrams according to the modulation type.

In the case of an ideal transmission channel without noise or interference, all symbols are recognized by the demodulator without errors. In this case, they are represented in the constellation diagram as well defined points hitting in the same area forming a very concentrated dot.

Noise and interferences cause the demodulator to not always read the symbols correctly. In this case hits are dispersed and create different forms which can visually determine the type of problem in the signal.

Each type of modulation is represented differently. A 16-QAM signal is shown on screen by a diagram of a total of 16 different zones and a 64-QAM signal is represented by a diagram of 64 different zones and so on.

The constellation diagram shows in different colours the density of hits and includes features to zoom, move and delete the display on screen.

#### 4.7.1.2 Operation

The constellation is available to all **DIGITAL** signals, both **TERRESTRIAL** and **SATELLITE**.

To access the **CONSTELLATION** tool:

- 1 Connect the **RF** input signal to the equipment.
- 2 Tune to a digital signal from satellite or terrestrial band.
- 3 Press the  key (Tools).
- 4 Select **CONSTELLATION**.
- 5 The **CONSTELLATION** of the tuned signal appears.

► **Screen description**

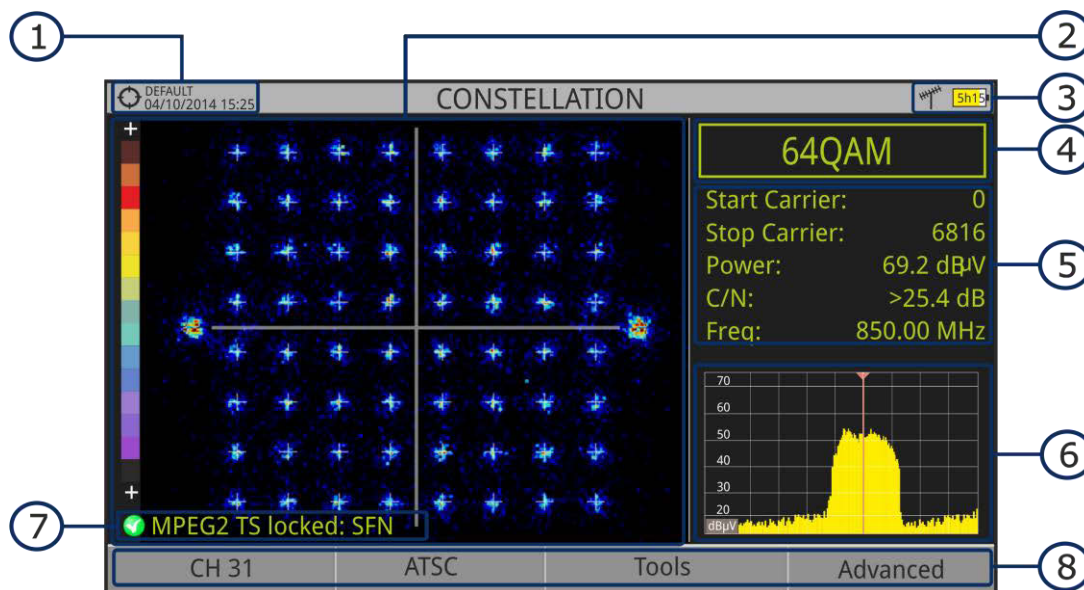

**Figure 52.**

- 1 Selected installation; date and time.
- 2 Constellation window.  
The colour scale placed at the left side indicates the signal quality in a qualitative way by a gradation of colours proportional to the density of symbols concentrated in a given area. The colour scale ranges from black (no symbols) to red (highest density).  
Greater dispersion of the symbols indicates higher noise level or worse signal quality signal. If there is symbols concentration with respect to the full grid (see advanced menu for types of grid) this is indicative of good ratio signal/noise or absence of problems.
- 3 Selected band, battery level.
- 4 Constellation modulation.
- 5 Data Window.  
The data shown are: Start Carrier, Stop Carrier, Power, C/N and frequency/channel.
- 6 Spectrum of the tuned signal.  
Spectrum is displayed with the span selected at the **SPECTRUM** mode.
- 7 Signal status (searching/locked/multiplex name).
- 8 Softkeys menus.

► Joystick **Left/Right**: Frequency/Channel change (depending on the tuning mode).

#### 4.7.1.3 Menu options

On the bottom of the screen there are four menus accessible via the function keys.



It displays the channel / frequency where is pointing the cursor, accesses the tuning menu and allows selecting the channel plan.



It displays the selected transmission standard menu and accesses the signal parameters.



It displays the Tools menu.



It displays the Advanced menu.

In the **Advanced** menu there are some options to set the constellation tool. They are:

► **Grid type:**

- **Full Grid:** The grid where the constellation is displayed is a complete grid.
- **Cross Grid:** The grid where the constellation is displayed is made of crosses.

► **Persistence:**

It allows the user to set the level of persistence, which is the lapse of time the signal stays on the screen before disappearing. Available options according to the persistence level are: low, medium, high or permanent.

► **Zoom:**

It allows the user to select a quarter (I, II, III or IV) where apply the zoom in. To come back to normal view select **All**.

► **Start Carrier/Stop Carrier:**

This option allows selecting the range of carriers to be displayed between the first and last.

► **Clear:**

This options clears all symbols in the whole constellation window.

## 4.7.2 **LTE Ingress test**

### 4.7.2.1 **Description**

**Long Term Evolution** is a new standard for mobile networks. This mobile communication standard uses a frequency band close to the bands used by television. For this reason it can cause interferences.

The equipment allows you to use an LTE external filter to put on the RF input connector. This filter can be enabled to check if the quality of the TV signal reception improves, when much of the LTE band has been attenuated by the filter. With this tool you can measure the MER of a DTT channel, presumably affected by an LTE signal, and evaluate the effects of enabling an LTE filter.

To be clarified that these filters cannot completely remove the LTE band signals. Especially for the TV channels close to 790 MHz, where is the end for the current UHF. If we are close to a LTE station with low downlink channels, a filter cannot be a sufficient solution.



Other options to better mitigate the LTE signals can be considered, such as a change in the location of the TV antenna or a passive shield in the way between the two antennas (TV and LTE).

For more information, refer to annex "digital dividend".



### 4.7.2.2 **Operation**

The **LTE Ingress Test** is available to all **DIGITAL TERRESTRIAL** signals.

#### ► **Setting:**

- 1 Press the "**Installation manager**" key for one second to access "**Preferences**" settings.
- 2 Go to "**Tools**" tab and edit the LTE filter settings.
  - **LTE Filter F.Min:** In case of use, select the minimum frequency for the external LTE filter.
  - **LTE Filter F.Max:** In case of use, select the maximum frequency for the external LTE filter.
- 3 Once selected, press  to save changes and  to exit "Preferences".

#### ► **Operation:**

- 1 Connect the external **LTE** filter between the signal and the **RF** input.
- 2 Tune the channel that is possibly affected by a LTE interference.
- 3 Press the  key: Tools.
- 4 Select the **LTE Ingress Test** mode.
- 5 Screen shows a confirmation message. Press on : "Yes" if filter is connected or : "No" if filter is not connected.



- 6 It starts to measure.
- 7 To change filter status (ON / OFF), press again the **F4** key and will appear a confirmation message. Connect / disconnect the LTE filter at the RF input and then press **F1** key: Ok to start measuring.
- 8 The user can enable / disable the LTE measure by pressing the **F4**: **ON/OFF**. Remember to connect / disconnect the LTE filter to the RF input. Each time a LTE measure starts, the time counter will reset.
- 9 Check how to connect and disconnect the LTE filter affects the installation, by comparing the MER measure and the LTE band power.

[Click here to watch this video: What is LTE](#)

► **Screen description**

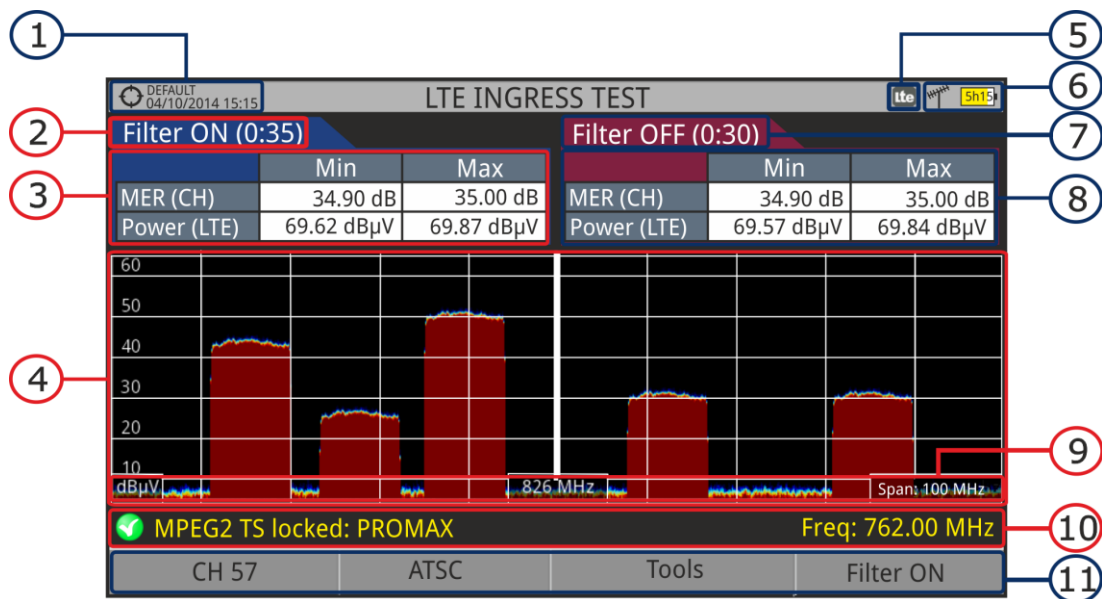

**Figure 53.**





- 1 Selected installation; date and time.
- 2 Elapsed time with filter enabled (ON).
- 3 Measurement with LTE filter enabled:
  - **MER:** Maximum and minimum MER for the TV channel tuned (the one probably affected by the LTE interference signal).
  - **LTE Power:** Maximum and minimum power for the complete band, between minimum and maximum filter frequencies (internal filter between 776 and 876 MHz).



- 4 Spectrum band, frequencies between minimum and maximum filter frequencies (internal filter between 776 and 876 MHz).
- 5 Identifier icon of the **LTE** filter ON (only when using internal LTE filter).
- 6 Selected band; battery level.
- 7 Time elapsed with filter disabled (OFF).
- 8 Measurement with LTE filter disabled:
  - **MER:** Maximum and minimum MER for the TV channel tuned (the one probably affected by the LTE interference signal).
  - **LTE Power:** Maximum and minimum power for the complete band, frequencies between minimum and maximum filter frequencies (internal filter between 776 and 876 MHz).
- 9 Measurement units/centre frequency/span (span: 10 MHz/division).
- 10 Signal status (searching/locked/multiplex name).
- 11 Softkeys menus.

#### 4.7.2.3 **Menu options**

On the bottom of the screen there are four menus accessible via the function keys.

- 
 It displays channel/frequency and access the tuning menu. It allows selecting the channel plan and the channel where apply the LTE ingress test.
- 
 It displays the selected transmission standard menu and accesses the signal parameters.
- 
 It displays the Tools menu.
- 
 It enables (ON) / disables (OFF) the LTE filter.

4.7.3 Spectrogram

4.7.3.1 Description

This function shows a graphical representation of the spectrum superimposed over time of a channel or frequency selected by the user. During the Spectrogram, maximum and minimum of several measures and time are registered. This tool is especially useful to analyse the behaviour of a spectrum over time, because sporadic and indeterminate anomalies can be detected.

4.7.3.2 Operation

The Spectrogram tool is available for all signals.

- 1 Connect the **RF** input signal to the equipment.
- 2 Select a channel or frequency.
- 3 Select the **SPAN** within the spectrogram will be displayed.
- 4 Press the **Tools** key .
- 5 Select the **Spectrogram** option.
- 6 It shows the **Spectrogram** of the signal.
- 7 To exit this function press any key of mode (**TV** mode, **Spectrum** mode or **Measurement** mode). All data registered is cleaned after leaving.

While using the Spectrogram function, if the signal unlocks, timer and measurement registered will clean and they will start to register when the signal is locked again.

► Screen description:

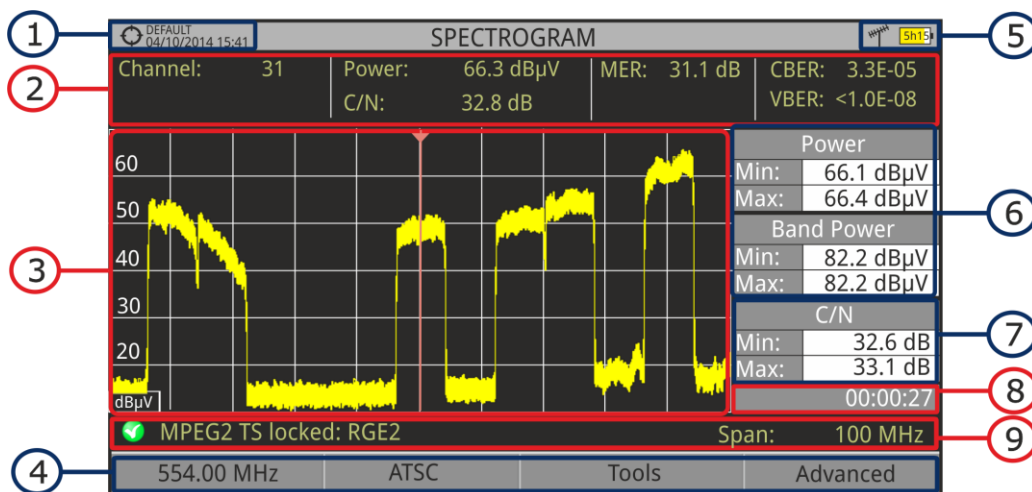

Figure 54.





- 1 Selected installation; date and time.
- 2 Measurement values for the signal tuned at the frequency/channel selected.
- 3 Spectrum over time at the selected span.
- 4 Softkeys menus.
- 5 Selected band, battery level.
- 6 Maximum and minimum values of signal power and band power over time.
- 7 Maximum and minimum value of the measure selected by the user in the option "User measure".
- 8 Elapsed time.
- 9 Signal status (searching / locked / multiplex name / selected span).

**X Axis:** Span (MHz)

**Y Axis:** Power

- ▶ Joystick does not have any function in this tool.

#### 4.7.3.3 **Menu options**

At the bottom of the screen there are four menus available via the function keys.



It displays the channel/frequency where is pointing the cursor and access the tuning menu.



It displays the selected transmission standard menu and accesses the signal parameters.



It displays the Tools menu.



It displays the Advanced menu.

In the Advanced menu there are some options for the spectrogram configuration. They are:

#### ▶ **User measure:**

It allows the user to select the measure to view on screen among the several available for each type of signal.



► **Details:**

It allows the user to view on screen the date and time when maximum and minimum measures were reached. To quit this view press the key .

► **Clear measures:**

It cleans the spectrogram and measures and it restarts the timer.





#### 4.7.4 **Attenuation Test**

##### 4.7.4.1 **Description**

This feature allows the user to easily check the response of the telecommunications installations before antennas and headers are working. It allows the user to evaluate the response along the complete range of frequencies by measuring the losses (attenuation) in the distribution of TV signals, comparing reference levels at headend output and at each house antenna plugs.

##### 4.7.4.2 **Operation**

Attenuation test function is available for all signals.

- 1 In **Settings**  select the terrestrial or satellite band.
- 2 Press the **Tools** key .
- 3 Select the **Attenuation Test** option.
- 4 The **Attenuation Test** function for the signal appears on screen.
- 5 First, set the parameters before the test, pressing the **Advanced**  key: Frequencies of pilot signals (pilot 0, pilot 1 and pilot 2), maximum attenuation and threshold attenuation (see more details in the next section).
- 6 Then it is necessary to **Set References**. This requires a signal generator. We recommend to use of one of the PROMAX signal generators: **RP-050**, **RP-080**, **RP-110** or **RP-250** (depending on the frequency band).
- 7 Connect the generator and the meter where the origin of the signal distribution is in the installation (antenna, headend, etc.) or connect the generator directly to the RF input of the meter. If necessary, the meter can feed the generator using the **Supply Output** option from the **Settings** menu .
- 8 Active the signal generator and in the equipment, press the **Set Reference** key .
- 9 Once are set the references for the pilot signals, let the signal generator connected to the source point of the distribution system and take measurements in each user access point with the equipment.



- 10 In each measurement a message over each pilot signal indicates whether the measure "Pass" or "Fail" according to the parameters set.
- 11 The measurement data from the **Attenuation Test** can be saved through the **Datalogger** tool. To do this, when creating a new datalogger, in the option **Include Attenuation Tests**, select Terrestrial and/or Satellite. Then, the user must perform a datalogger from the test point where he is performing the attenuation test. Another quick option it is to select the "Test & Go" function in the "Datalogger" menu. This option creates automatically one channel plan (TER ICT or SAT ICT according to the current band) and starts to save measurements. The data will be saved and can be checked and transferred to a PC. For more information, see "Datalogger" section under the "Tools" chapter. Also measurement data or screen image can be exported by pressing the **Export**  key (see more details in section "Export key") and after that display the images or download the data files (in XML format).

**NOTE:** In both satellite and terrestrial band, the system saves the LNB state every time the user sets a reference and uses this value always that the equipment is working in this mode.

► **Screen description:**

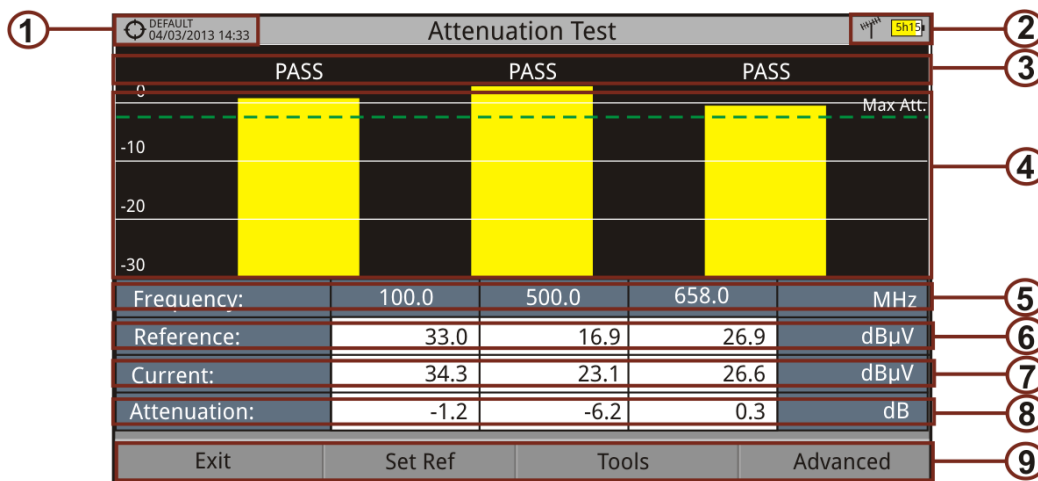

**Figure 55.**

- 1 Installation selected, date and time.
- 2 Selected band; battery level.
- 3 Status message depending on the attenuation level.



- 4 Power level of the signal.
- 5 Signal Frequency (MHz).
- 6 Power level of the reference signal obtained when setting the reference and used to calculate the attenuation level (dB $\mu$ V).
- 7 Power level of the test signal at the user access point (dB $\mu$ V).
- 8 Attenuation level (dB); Attenuation = Reference – Current.
- 9 Softkeys.

**X-axis:** Pilot signals

**Y-axis:** Power

- ▶ **Joystick:** The joystick does not have any function in this tool.

#### 4.7.4.3 Menu options

In the bottom of the screen are four menu accessible via the softkeys.



**Exit:** Exits the tool.



**Set Reference:** Pressing this option the current power values are captured and they are assigned as reference values.



**Tools:** It access the Tools main menu.



**Advanced:** It access the Advanced menu.

In the **Advanced** menu there are five parameters to set the attenuation test. They are:

- ▶ **Threshold Attenuation:**

It defines the maximum difference that may exist between the pilot signal of higher level and the pilot signal of lower level. All pilot signals out of this range will be removed and not used as a pilot signal during the measurement process.

- ▶ **Maximum Attenuation:**

It sets the attenuation level used by the equipment to show on screen if the signal passes or fails. When the attenuation level is below this value the message on screen is "**PASS**" and when it is above this value is "**FAIL**".



- ▶ **Pilot 0:**  
It defines the frequency of the pilot signal 0 (MHz).
- ▶ **Pilot 1:**  
It defines the frequency of the pilot signal 1 (MHz).
- ▶ **Pilot 2:**  
It defines the frequency of the pilot signal 2 (MHz).





#### 4.7.5 **Signal Monitoring**

##### 4.7.5.1 **Description**

This tool allows the user to monitor a locked signal over time, measuring its power, MER and C/N. All this data can be downloaded to a PC and exported to a file for later analysis.

##### 4.7.5.2 **Operation**

The Signal Monitoring tool is available for all signals.

- 1 In **Settings** menu  select the band.
- 2 Access the **SPECTRUM** mode and tune the signal for monitoring.
- 3 Press the **Tools** key .
- 4 Select the **Signal Monitoring** option.
- 5 The **Signal Monitoring** function appears on screen.
- 6 Before starting the monitoring, access the **Configuration** option in the **Advanced** menu  for settings (more details in next section).
- 7 After settings, access the **Advanced** menu  and press on **Start** to start the signal monitoring.  
In **Continuous** mode, the equipment takes samples automatically according to sample time (see next section). In **Manual** mode each time the user presses the joystick the equipment takes a sample.
- 8 Access the **Advanced** menu  and press on **Stop** to finish the signal monitoring. Data obtained is automatically stored.



- 9 After stopped, it appears the Signal Monitoring Viewer that allows the user to watch the final results (more details in "Signal Monitoring Viewer" section).
- 10 Access the data by pressing the **Installation Management** key to check that the monitoring data file has been saved. This file is a "Signal Monitoring" type. To manage the data, see below the section "Data File Processing".

► **Screen Description:**

The following describes the **Signal Monitoring** screen:

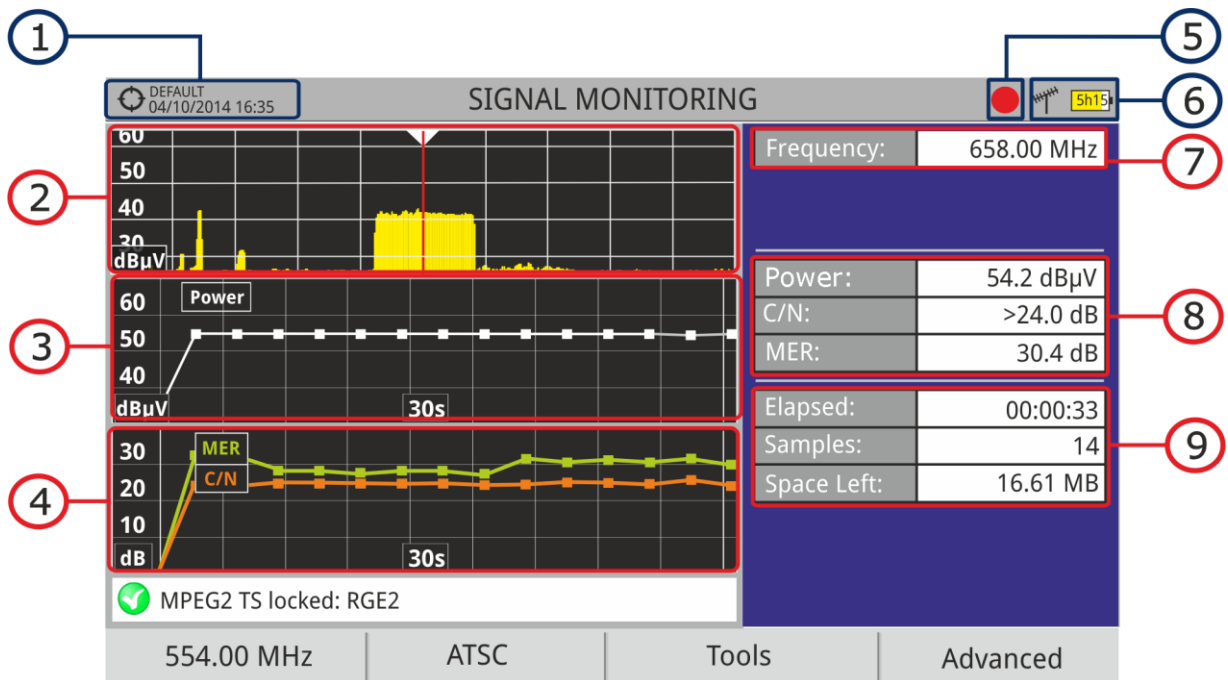

**Figure 56.**

- 1 Selected installation; date and time.
- 2 Spectrum.
- 3 Power measurement over time (shows span time).
- 4 Mer and C/N measurement over time (shows span time).
- 5 Indicator of signal monitoring started.
- 6 LNB, Selected band; battery level.
- 7 Signal information window 1:  
**Frequency:** frequency at which signal is locked;
- 8 Signal information window 2:  
Power, MER, C/N measurements of the signal over time. It shows on screen only the span time selected in settings.





- 9 Signal information window 3:
- Elapsed:** Time elapsed since the beginning of the monitoring.
- Samples:** Samples taken since the beginning of the monitoring.
- Space left:** Space left in the memory to save data.

#### 4.7.5.3 **Menu options**

At the bottom of the screen there are four menus available via the function keys.

- 

F1 It displays the channel/frequency where is pointing the cursor and access the tuning menu.
- 

F2 It displays the selected transmission standard menu and accesses the signal parameters.
- 

F3 It displays the Tools menu.
- 

F4 It displays the Advanced menu.

In the **Advanced** menu there are some options for the **Signal Monitoring**. They are:

- ▶ **Start:** It starts the signal monitoring.
- ▶ **Stop:** It stops the signal monitoring.
- ▶ **Pause:** It stops the signal monitoring for a while until resuming.
- ▶ **Configuration:** It shows the settings window with some parameter (see the "Settings" section for more details).
- ▶ **Audio:** It allows disable or disable audio. When this option is enabled, the user can listen to any service in the monitored signal, knowing about signal reception while driving or doing other tasks.

#### 4.7.5.4 Settings

User can adjust some parameters on the Signal Monitoring:

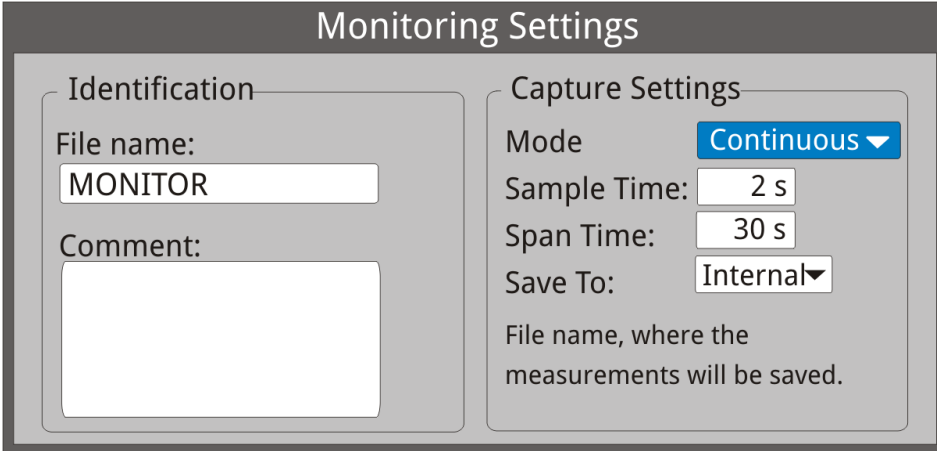

The image shows a screenshot of the 'Monitoring Settings' screen. It is divided into two main sections: 'Identification' and 'Capture Settings'. In the 'Identification' section, there is a 'File name' field containing the text 'MONITOR' and a larger 'Comment' text area below it. In the 'Capture Settings' section, there are four fields: 'Mode' is a dropdown menu set to 'Continuous'; 'Sample Time' is a text field set to '2 s'; 'Span Time' is a text field set to '30 s'; and 'Save To' is a dropdown menu set to 'Internal'. Below these fields is a note: 'File name, where the measurements will be saved.'

Figure 57.

► **File name:**

User can give a name to the file where data is saved. All measurement that can be seen in the MEASUREMENT 1/3 screen (frequency, power/level, C/N, MER) will be stored on the data file. Be sure to change the file name when starting a new signal monitoring. If not, new data file will be saved on the last one.

► **Comment:**

User can write some comments about the monitoring.

► **Mode:**

There are **two** options: **Continuous** or **Manual**. In continuous mode a sample is taken automatically every sample time. In manual mode a sample is taken every time that user presses the joystick.

► **Sample Time:**

Time between acquisitions. Only when working in continuous mode. Minimum time is 1 second.

► **Span time:**

It is the width, in time, shown on screen for the X axis.

► **Save to:**

There are **two** options: **Internal** or **USB**. For Internal option it saves the file with all data in the internal memory of the equipment. For USB option it saves the file with all data in a USB flashdrive connected to the micro-USB port of the equipment.





4.7.5.5 Data viewer

The data viewer allows the user to watch the monitoring final results. It accesses directly when signal monitoring ends or also by opening the data file in the installation management screen.

► Screen description:

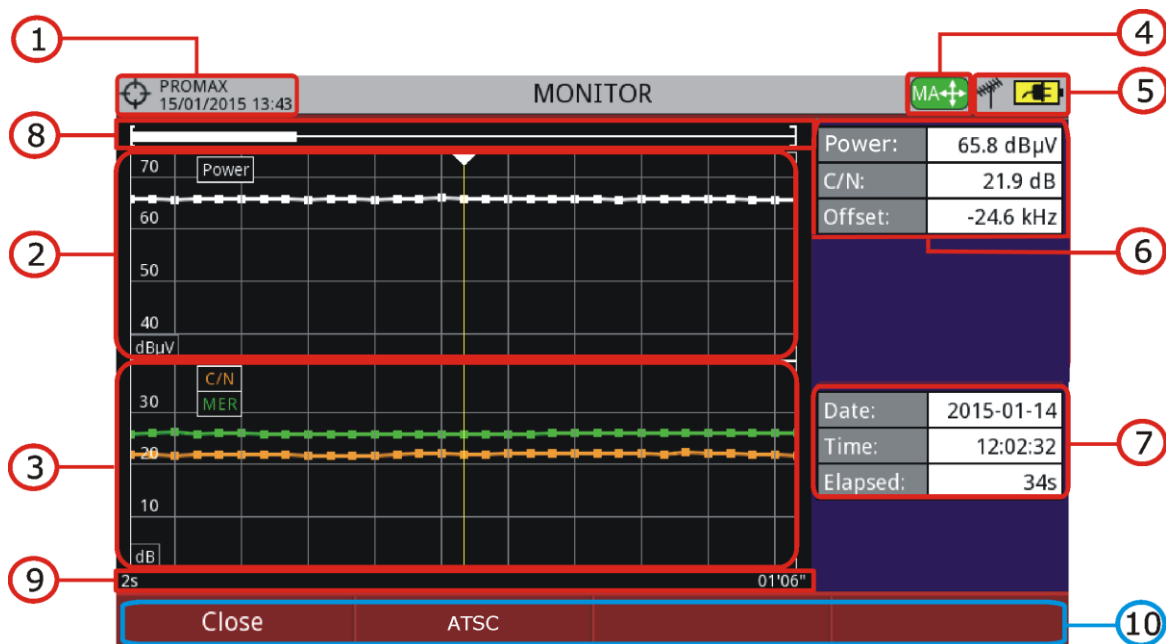

Figure 58.

- 1 Selected installation; date and time.
- 2 Power measurement over time.
- 3 Mer and C/N measurement over time.
- 4 Joystick mode selected: PA mode (panoramic) or MA mode (cursor movement).
- 5 LNB, selected band; battery level.
- 6 Signal information window 1: Measurement where the cursor is.
- 7 Signal information window 2: Date, time and elapsed time.
- 8 Scrollbar: it shows position and size of the data displayed related to total data.
- 9 Time span of displayed data.
- 10 Menu Options:
  - F1: Exits the data viewer.
  - F2: It shows transmission parameters of the monitored signal.



- ▶ **Joystick up/down:** It increases / decreases zoom.
- ▶ **Joystick left/right:** In PA mode it moves time span along the total time. In MA mode it moves the cursor along the samples of the time span.
- ▶ **Joystick pressing:** It switches between panoramic (PA) and movement (MA) mode.

#### 4.7.5.6 Data file processing

##### ▶ Description:

This document is an explanation about the process that is needed to be done in order to obtain a more comfortable view of the XML data obtained with **RANGER Neo** family equipment, when performing a Signal Monitoring.

Once you got the monitoring data, copy the XML data file from the equipment to a USB memory using the Installation Manager. See the equipment's documentation in how to get files from an Installation.

##### ▶ Obtaining an excel file:

For this section, you must have at least Excel 2003 or newer version. Excel 2007 (or later) is highly recommended to avoid macro problems.

- 1 First of all we need to locate the XML data file in the folder from which we want to work. There are no requirements needed to be satisfied. A file named COVERAGE.XSL must be placed in the same data file folder. That second file allows proper data formatting when processed by Excel.
- 2 Select the XML data file and then right click with the mouse button on the file name.
- 3 Choose the option "**Open with**" and then select Excel 2007 (or the available version).

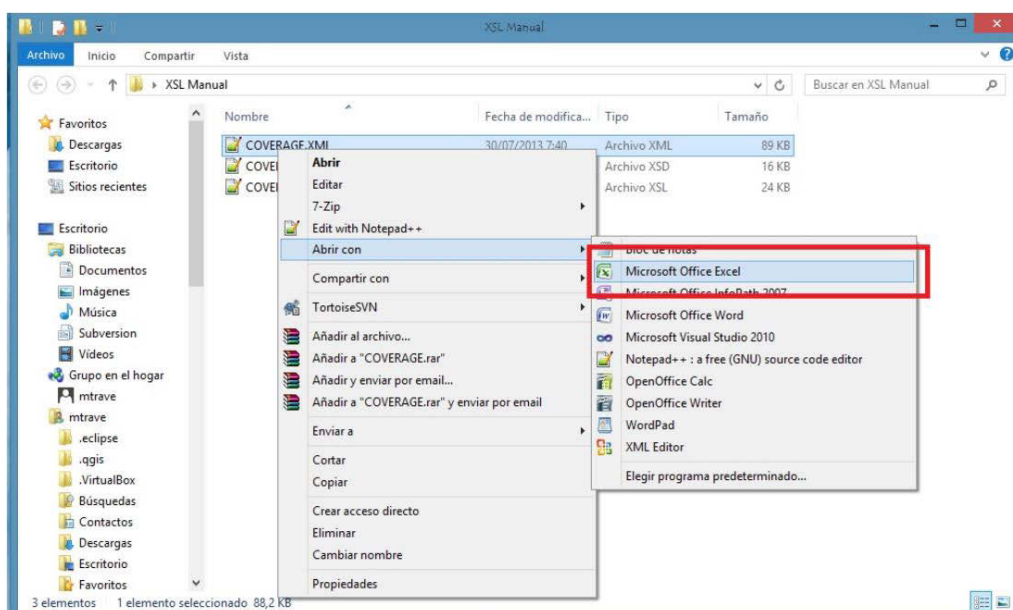

Figure 59.

- 4 When Excel tries to open the file it will ask you the import method to open the XML data file by this way:

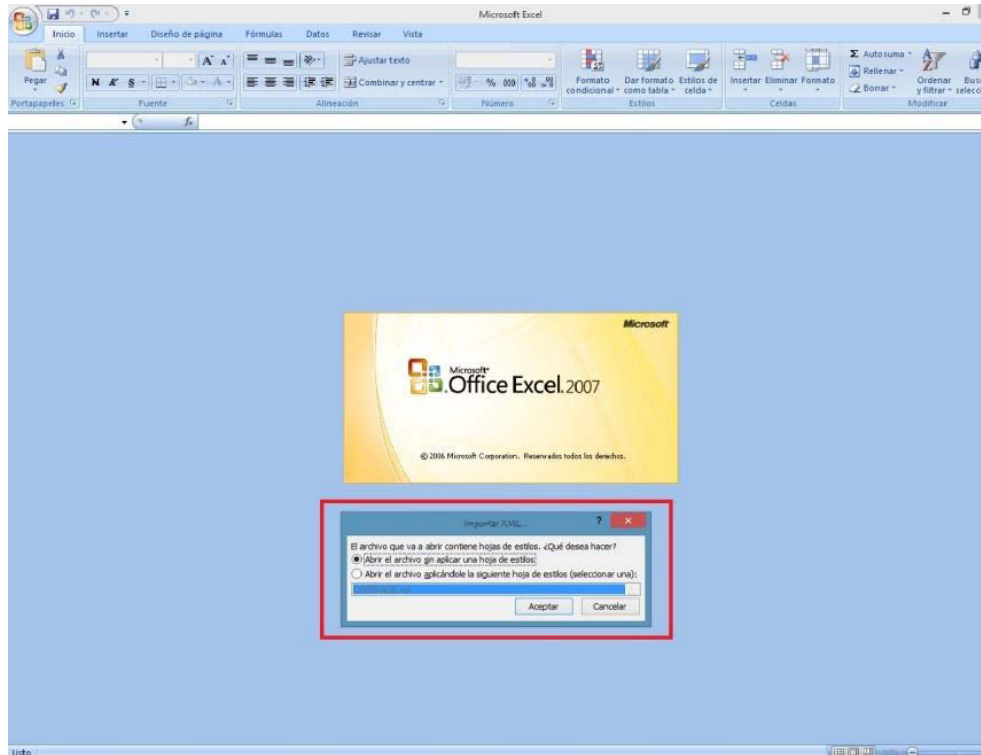

Figure 60.

- 5 You must choose the option in which a stylesheet is asked. It will appear as an option the "COVERAGE.xsl" file.

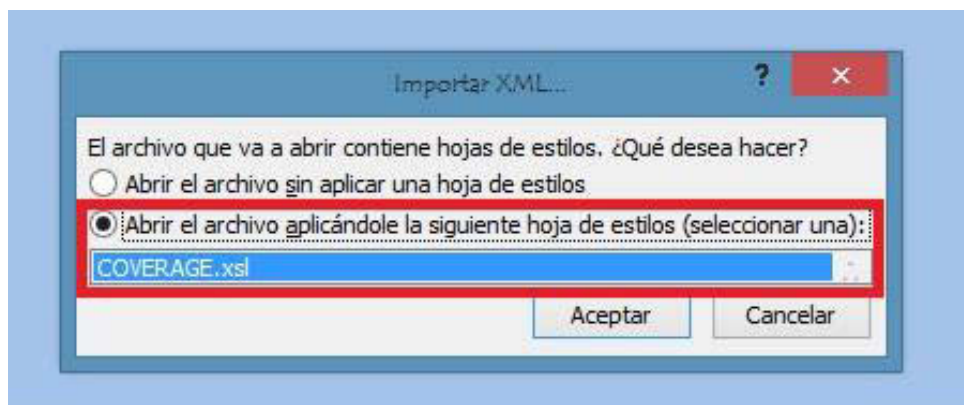

Figure 61.

- 6 Now Excel is opening the XML data file using the format that the XSL file is providing. This step could take few seconds depending on the size of the XML data file.
- 7 At this point, you should have an excel file with three different sheets. Each sheet corresponds to a different view of the same data:



- ✓ The first one will show you the generic signal information and the different coverage measures for each point acquired.
- ✓ In the second one, you will find the same data but presented in a table format, more user friendly for working with graphs based on each measured parameter.
- ✓ The third one provides data in a format adapted for geolocation. This is available only for users with GPS option (refer to annex OP-001-GPS).

**8** Now save the data as a true excel file. No specific name or path is required, but you must remember the path.

#### 4.7.6 **Signal Coverage\***



##### 4.7.6.1 **Description**

This option allows the user to check signal coverage by measuring its level and C/N. The position where all these measurements are taken is determined by a GPS receiver. All this data, measurements and GPS position can be downloaded to a PC and exported to a file for later analysis.

Please, read the user's manual of the equipment for detailed information about general operation, specifications and other data.

##### 4.7.6.2 **Operation**

The Signal Coverage tool is available for all signals.

- 1** Connect the GPS receiver to the equipment.
- 2** In **Settings** menu  select the terrestrial band.
- 3** Access the **SPECTRUM** mode and tune the signal for coverage study.
- 4** Press the **Tools** key .
- 5** Select the **Signal Coverage** option.
- 6** The **Signal Coverage** function appears on screen.

\*GPS receiver not included. Contact PROMAX to buy validated GPS receiver.



7 Before starting the signal coverage analysis, access the **Configuration** option in the **Advanced** menu  for settings (more details in next section).

8 After settings, access the **Advanced** menu  and press on **Start** to start the signal coverage analysis.

In **Automatic** mode, the equipment takes samples automatically according to settings (see next section). In **Manual** mode each time the user presses the joystick the equipment takes a sample. Measurement are linked to the GPS reference.

9 Access the **Advanced** menu  and press on **Stop** to finish the signal coverage analysis. Data obtained is automatically stored.

10 Access the data by pressing the **Installation List** key  to check that the monitoring data file has been saved. This file is a "Data Capture" type. To manage the data, see below the section "Data File Processing".

4.7.6.3

**Settings**

User can adjust some parameters on the Signal Coverage analysis:

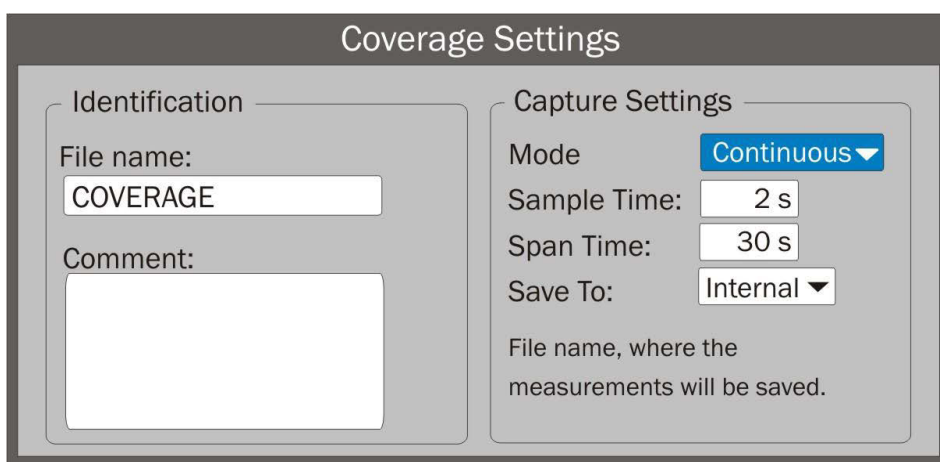

Figure 62.

► **File name:**

User can give a name to the file where data is saved. All measurement that can be seen in the MEASUREMENT 1/3 screen (frequency, power/level, C/N, PLP identifier, MER, CBER, LBER and LM) will be stored on the data file. Be sure to change the file name when starting a new Signal coverage analysis. If not, new data file will be saved on the last one.

► **Comment:**

User can write some comments about the study.



► **Mode:**

There are **two** options: **Continuous** or **Manual**. In continuous mode a sample is taken automatically every sample time. In manual mode a sample is taken every time that user presses the joystick.

► **Sample Time:**

Time between acquisitions. Only when working in continuous mode. Minimum time is 1 second.

► **Span time:**

It is the width, in time, shown on screen for the X axis.

► **Save to:**

There are **two** options: **Internal** or **USB**. For Internal option it saves the file with all data in the internal memory of the equipment. For USB option it saves the file with all data in a USB flashdrive connected to the micro-USB port of the equipment.

**4.7.6.4 Description of signal coverage screen**

The following describes the **Signal Coverage** screen:

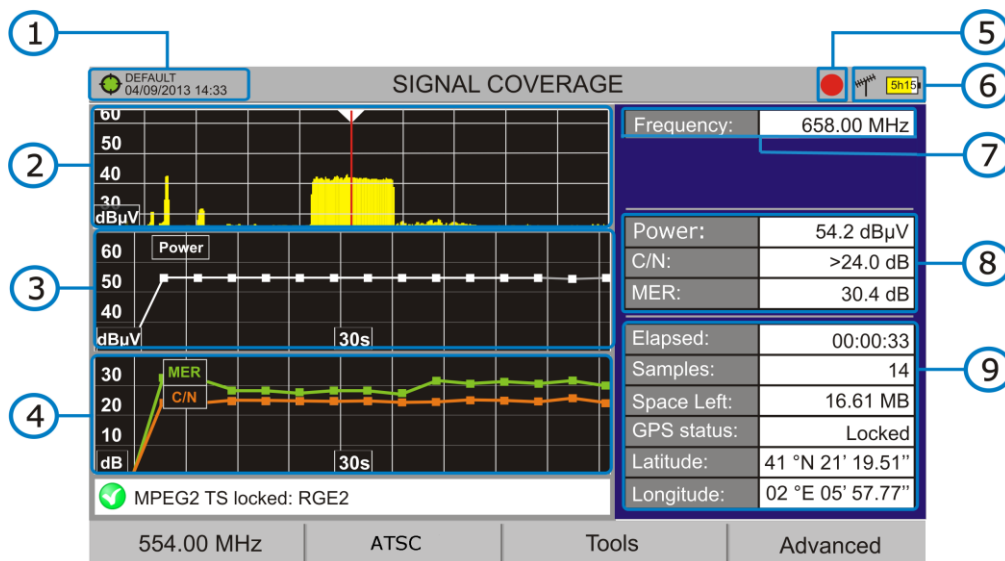

**Figure 63.**





- 1 Selected installation; date and time. The "Current installation" in green indicates the system has locked the GPS signal. The "Current installation" in red indicates that the system has not locked the GPS signal.
- 2 Spectrum.
- 3 Level measurement over time (shows span time).
- 4 Mer and C/N measurement over time (shows span time).



- 5 Signal coverage started.
- 6 LNB, Selected band; battery level.
- 7 Signal information window 1:  
**Frequency:** frequency at which signal is locked; **TS Hierarchy** (table hierarchy at the transport stream) **TS Priority** (packet priority at the transport stream).
- 8 Signal information window 2:  
 Power, MER, C/N, measurements of the signal over time. It shows on screen only the span time selected in settings.
- 9 Signal information window 3:  
**Elapsed:** Time elapsed since the beginning of the coverage study.  
**Samples:** Samples taken since the beginning of the coverage study.  
**Space left:** Space left in the memory to save data.  
**GPS status:** It shows if the GPS receiver is locked or unlocked.  
**Latitude, Longitude:** It shows the latitude and longitude at the current position, if GPS is locked. Measurement are linked to the GPS position.

#### 4.7.6.5 **Menu Options**

At the bottom of the screen there are four menus available via the function keys.

-  It displays the channel/frequency where is pointing the cursor and access the tuning menu.
-  It displays the selected transmission standard menu and accesses the signal parameters.
-  It displays the Tools menu.
-  It displays the Advanced menu.

In the **Advanced** menu there are some options for the **Signal Coverage**. They are:

- **Start:** It starts the signal coverage study.
- **Stop:** It stops the signal coverage study.
- **Pause:** It stops the signal monitoring for a while until resuming.
- **Configuration:** It shows the settings window with some parameters (see "Settings" chapter for more details).
- **Audio:** It allows enable or disable audio. When this option is enabled, the user can listen to any service in the monitored signal, knowing about signal reception while driving or doing other tasks.
- **GPS Status:** It shows a list and a graph with satellites detected to locate the GPS signal. It is also provided additional data such as longitude, latitude, date and universal time, visible satellites and GPS status (locked or not).

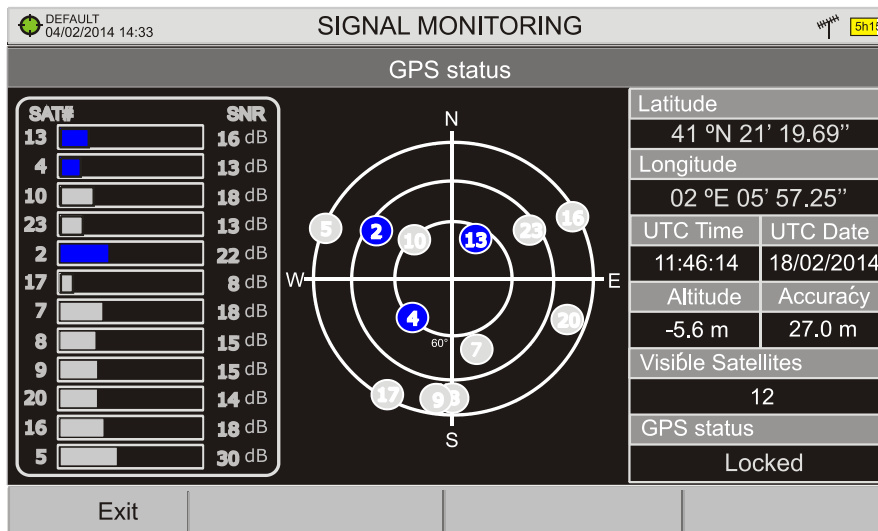

Figure 64.





**4.7.6.6 Data viewer**

The data viewer allows the user to browse along the final results. It opens directly after saving the data or by opening the associated data file (that is located in the installation manager).

► **Screen description:**

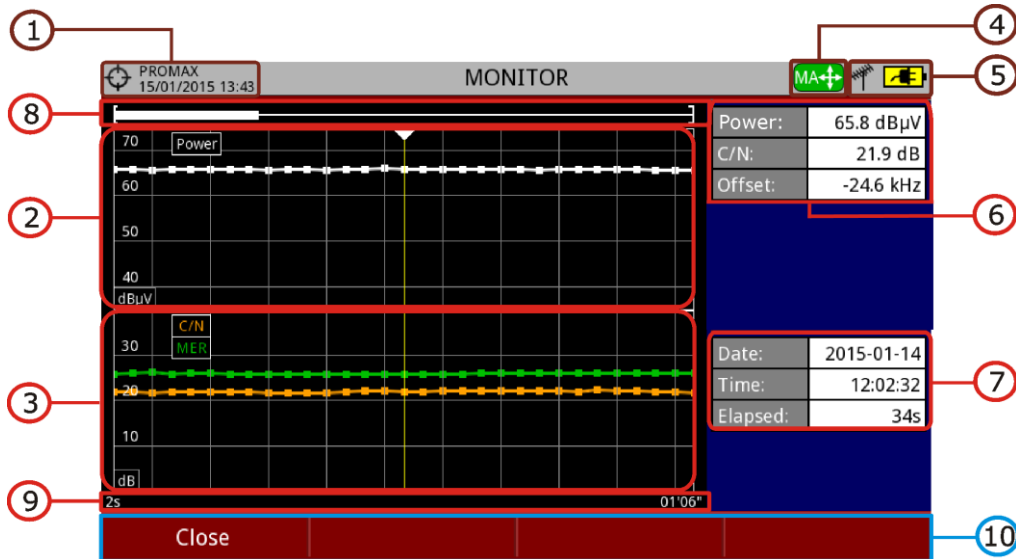

**Figure 65.**

- 1 Selected installation; date and time.
- 2 Power measurement over time.
- 3 MER and C/N measurement over time.
- 4 Joystick mode selected: PA mode (panoramic) or MA mode (cursor movement).
- 5 LNB, selected band; battery level.
- 6 Signal information window 1:  
Measures where the cursor is.
- 7 Signal information window 2:  
Date, time and elapsed time.
- 8 Scrollbar: it shows position and size of the data displayed related to total data.
- 9 Time span of displayed data.
- 10 Menu Options:  
  - F1: Exits the data viewer.
  - F2: It shows transmission parameters of the monitored signal.



- ▶ **Joystick up/down:** It increases / decreases zoom.
- ▶ **Joystick left/right:** In PA mode it moves time span along the total time.  
In MA mode it moves the cursor along the samples of the time span.
- ▶ **Joystick pressing:** It switches between panoramic (PA) and movement (MA) mode.

#### 4.7.6.7 **Data File Processing**

##### 4.7.6.7.1 **Description**

This document is an explanation about the process that is needed to be done in order to obtain a more comfortable view of the XML data obtained with RANGER Neo family equipment, with GPS option, when doing a Signal Coverage analysis.

Once you got the coverage data, copy the XML data file from the equipment to a USB memory using the Installation Manager. See the equipment's documentation in how to get files from an Installation.

##### 4.7.6.7.2 **Obtaining an excel file**

For this section, you must have at least Excel 2003 or newer version. Excel 2007 (or later) is highly recommended to avoid macro problems.

- 1 First of all we need to locate the XML data file in the folder from which we want to work. There are no requirements needed to be satisfied. A file named COVERAGE.XSL must be placed in the same data file folder. That second file allows proper data formatting when processed by Excel.
- 2 Select the XML data file and then right click with the mouse button on the file name.

- Choose the option **"Open with"** and then select Excel 2007 (or the available version)

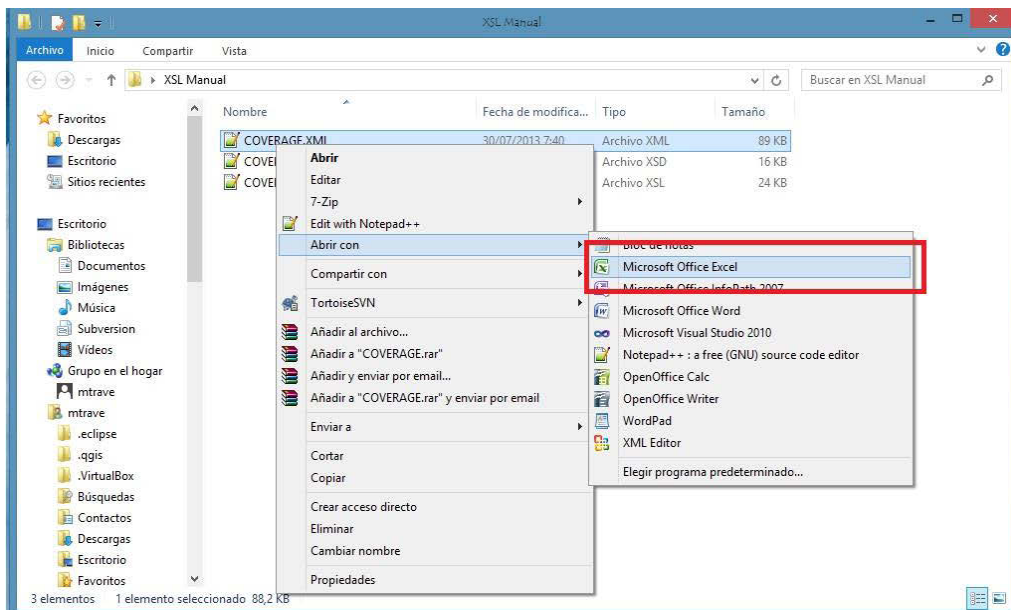

Figure 66.

- When Excel tries to open the file it will ask you the import method to open the XML data file by this way:

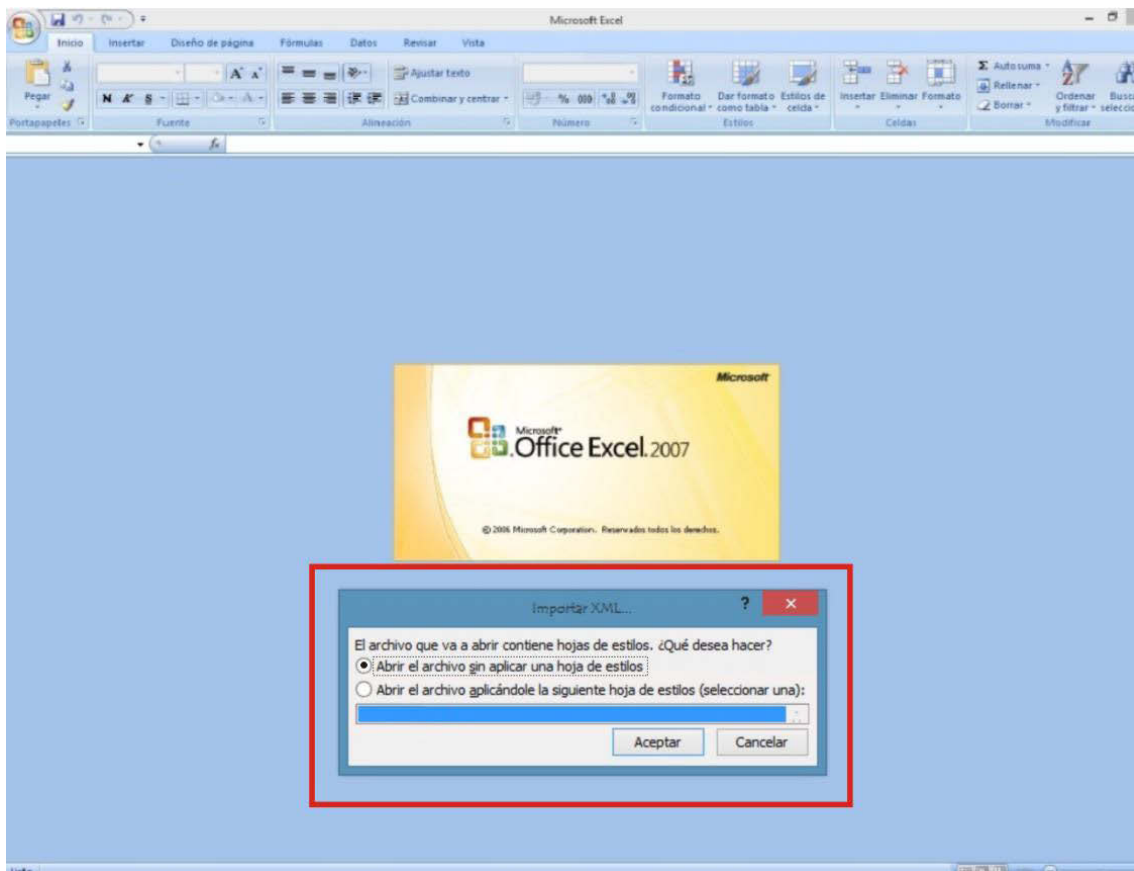
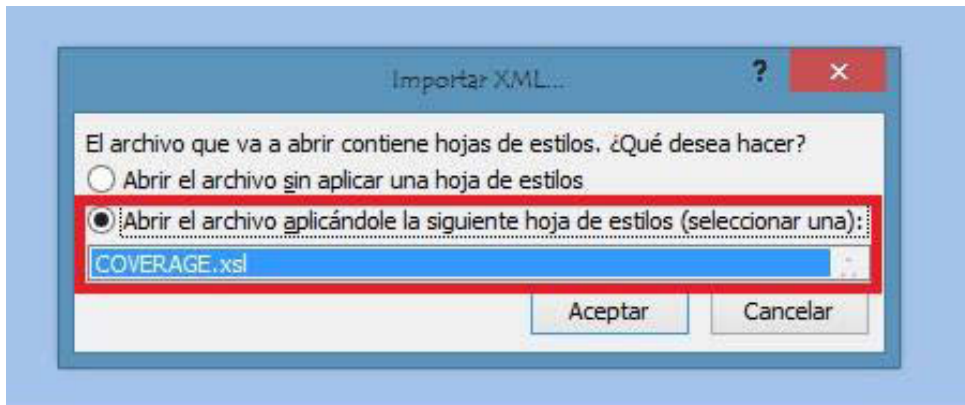

Figure 67.

- 5 You must choose the option in which a stylesheet is asked. It will appear as an option the "COVERAGE.xsl" file.



**Figure 83.**

- 6 Now Excel is opening the XML data file using the format that the XSL file is providing. This step could take few seconds depending on the size of the XML data file.
- 7 At this point, you should have an excel file with three different sheets. Each sheet corresponds to a different view of the same data:
- ✓ The first one will show you the generic signal information and the different coverage measures for each point acquired.
  - ✓ In the second one, you will find the same data but presented in a table format, more user friendly for working with graphs based on each measured parameter.
  - ✓ The third one provides data in a format adapted for geolocation. Information is shown in terms of parameters required for presenting the measured data as a map layer (latitude, longitude, id, description and an icon identifier number) as required for GIS and Google Earth technologies. This third sheet is formatted mainly to be compatible with main Google Earth format converters available in Internet.
- 8 Now save the data as a true excel file. No specific name or path is required, but you must remember the path.

#### 4.7.6.8 **Displaying measurements in Google Earth**

Measures taken with the **Signal Coverage** tool can be exported and displayed on Google Earth 3D maps.

- 1 Install **Google Earth** (<https://www.google.com/earth>) on your PC.
- 2 Once measurements have been made and coverage data obtained, copy the generated data file (COVERAGE.XML) to a USB stick or to a PC (see "Connecting external devices" for more details).
- 3 Access the KML Generator application by PROMAX (<http://www.promax.es/tools/kml-generator/>).
- 4 Click on the **KML Generator** screen and then a file explorer opens. Select your data file (COVERAGE.XML) exported from the meter.
- 5 If the file is correct it opens a window with a series of options that allow you to customize the visualization:
  - **Assign colors to the test points using a quality-based color scale:** It assigns a color (selected by the user) for the worst quality value and another color for the best quality value. For the intermediate values performs a gradation between both colors.
  - **Use a PASS/FAIL threshold:** It uses only two colors (selected by the user). A color for measures that are below a certain threshold value and another color for measures that are above that value.
  - **Quality parameter to use as reference:** Select the type of measurement (POWER, MER...) to show on the map.
  - **Bad quality test points color:** Select one color for bad quality points.
  - **Good quality test points color:** Select one color for good quality points.
  - **Value:** Define a value for bad quality and another for good quality points. These values are related to color above.
  - **Automatic:** If you check this option it uses the highest and / or lowest value detected in your exported data file.
  - **Threshold value:** It allows you to select the limit value to paint the measurements of one color or another.
  - **Generate and overlay a legend:** It shows a legend that provides information to understand the map.
  - **Include test points with UNLOCKED signal (only for digital signals):** It shows all test points even if signal is not tuned.
  - **Add extra information to test points (all measurements, date and time):** It displays all measures for each test point also date and time when they were taken.

- 
- **Skip test points at the same physical location:** It only uses the first measure if are more than one with the same coordinates.
  - **Choose a marker style for test points geolocation:** Select the type of marker.
- 6 Once the configuration of the file is finished, click on the option "Download your KML file for Google Earth".
  - 7 Click on the downloaded file in KML format (COVERAGE.KML). It Should open the Google Earth program showing the measurement data over a 3D map.



#### 4.7.7 Datalogger

##### 4.7.7.1 Description

The Datalogger function stores automatically measurements in a file set by the user (name, channel plan). User can store for each datalogger measurements taken at different test points of the selected installation. Measurements are made for all channels in the active channel plan, both analogue and digital. Each installation has its own datalogger files.

##### 4.7.7.2 Operation

► **To create a new datalogger:**

- 1 First select one installation of the list of installations  and load it pressing the "Load" key . An installation contains the channel plans and DiSEqC commands selected by the user and it stores dataloggers and screenshots made while it is selected (more information in chapter "Installations management").
- 2 Check the installation is selected. The name of the installation should appear on the upper left corner of the screen.
- 3 Press the : Tools key.



- 4 Press on the "Datalogger" option.
- 5 It displays a menu with the "New ...", "Test & Go" option and a list of all dataloggers at the selected installation.
- 6 Select "New ..." to create a new datalogger, select "Test & Go" to create a quick datalogger (see next) or select the file name of an existing datalogger if the user want to save data on a specific datalogger already existing.
- 7 If "New ..." is selected, a installation wizard shows how to create a new datalogger. Follow its instructions (F4): Next to move to the next screen, (F3): Previous to move to the previous screen or (F1): Cancel to cancel).
- 8 When creating a new datalogger through the wizard, the user can give a name to the datalogger.

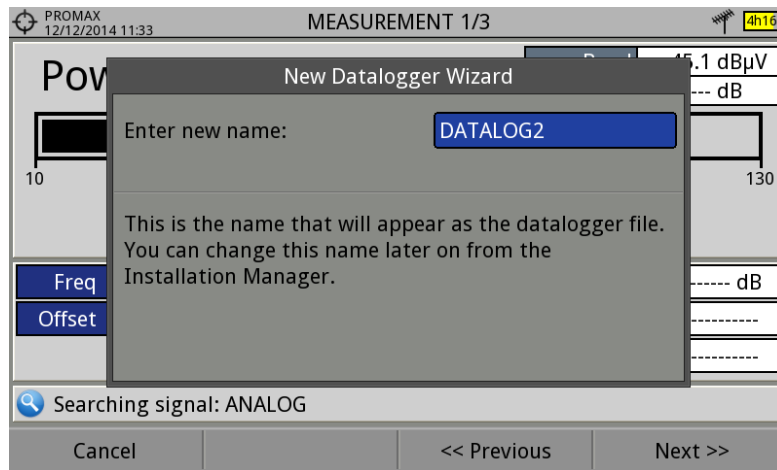

Figure 68.

- 9 Next, the user can select the terrestrial and/or satellite channel plan to use in the datalogger. The channel plans that are shown depends on the channel plans available for the current installation.

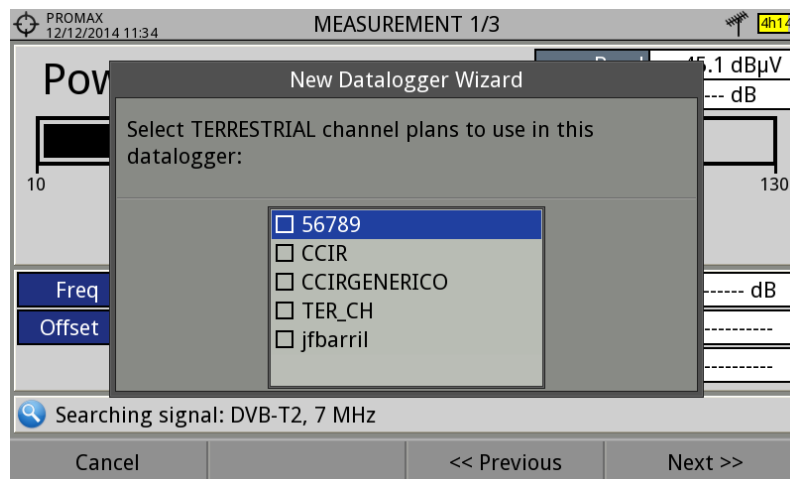
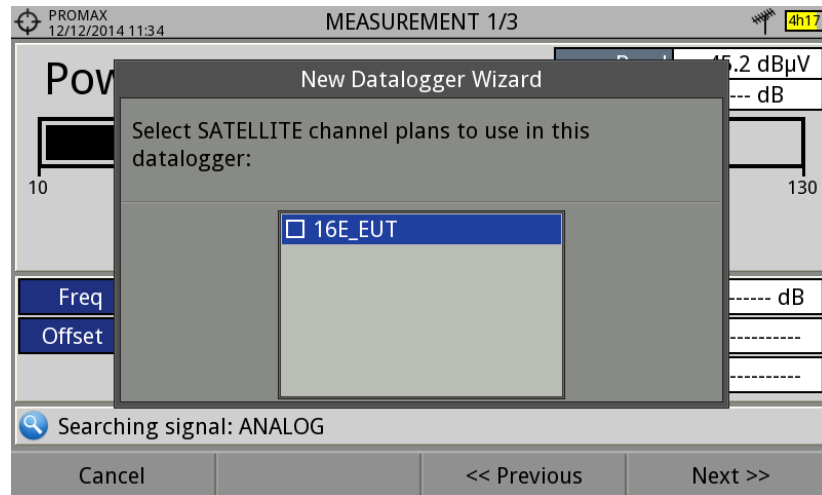
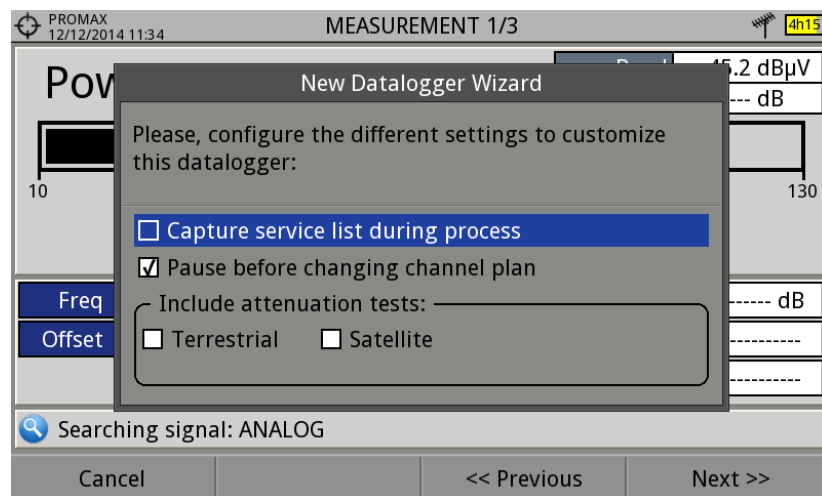

Figure 69.



**Figure 70.**

- 10** In the next window, the user can select an option to capture de service list when performing the datalogger (this option slows down the process but provides more information). Another option allows the user to enable a pause between channel plans (the process stops until the user wants to carry on). There is also the option to perform a datalogger on the attenuation test, terrestrial or satellite (see section "Attenuation Test" under "Tools" for more information).



**Figure 71.**

- 11** At the last step, user can select to open the just created new datalogger (by default, this option is selected).
- 12** Once a new datalogger is created or selected an already existing one, it shows the datalogger viewer screen and measurements of test points can start.
- 13** If it is a new datalogger, in first place before starting the datalogger, the system will create a new test point (see next section).







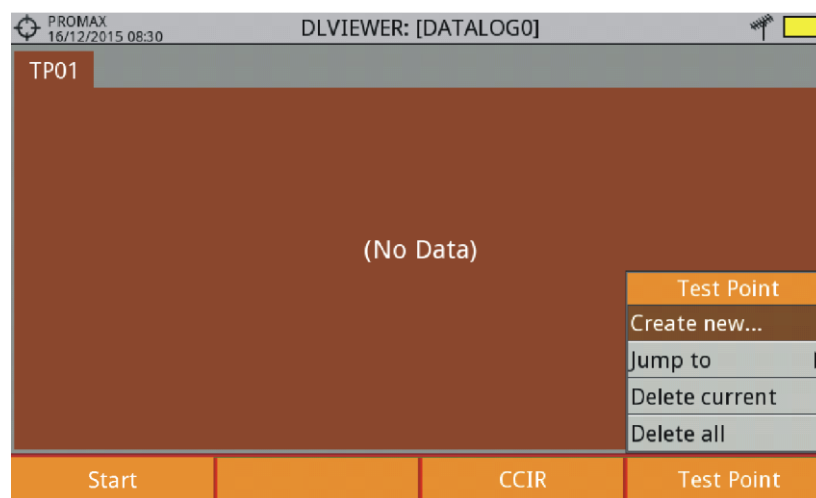

Click here to watch this video: [Datalogger](#)

► **To start the datalogger:**

- 1 After creating a new datalogger file or selecting an existing one, the user can start the datalogging process.
- 2 From the datalogger viewer screen, press the "Test point" key  and from the menu select an existing test point using the "Jump to ..." option or "Create new ..." to create a new test point. If a new test point is created, user has to give it a name.



**Figure 72.**

- 3 Now datalogger is ready to start. Press the key  and "Start". The datalogger process starts, during which all the measurements of all channels that are part of the datalogger and also the attenuation test are saved.
- 4 During datalogger, it catches the list of available services of all channels in the channel plan that are part of the datalogger (if this option was selected when creating the datalogger or if the "Datalogger PSI" option is enabled in the Preferences menu). If there is a change of channel plan during datalogger there will be a pause (if this option was selected when creating the datalogger). User can pause and resume the datalogger process at any time by pressing on the key "Pause" . If the "Attenuation Test" option was included when creating the datalogger, these measures will also saved.
- 5 At the end it saves the data and allows watching the results on screen by channel plan/attenuation test. To change the view of channel plan or attenuation test data press on the  key. Data about terrestrial and satellite attenuation will appear as the option TER ICT and SAT ICT respectively.

- 6 It is also possible to download Datalogger files to a PC by the NetUpdate software (free download on the PROMAX website). Once downloaded, the program can generate reports with these files. This is not possible with the datalogger files exported directly to a USB (without using NetUpdate). Information of Service lists are in the XML files downloaded to the PC.

**NOTE:** To make a datalogger with the Field Strength tool, in first place user has to enable the field strength tool, and then to create a new datalogger file. The field strength data will be stored in this datalogger.

### ► Datalogger screen description

The following describes the datalogger screen:

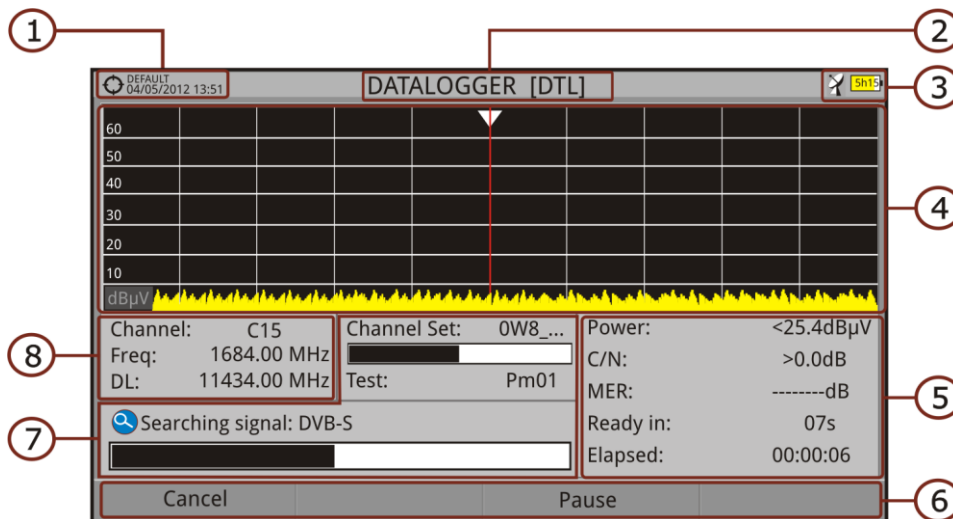

**Figure 73.**

- 1 Selected installation; date and time.
- 2 Current datalogger name.
- 3 Selected band; battery level.
- 4 Exploring the spectrum in real time.
- 5 Level/Power, C/N ratio, MER, time remaining to identify a channel, elapsed time since the start of the channel identification.
- 6 Softkey menus.
- 7 Current channel plan, progress bar in the current channel plan, selected test point.
- 8 Channel, frequency and Downlink.



► **Datalogger viewer screen description**

The following describes the display of data acquired:

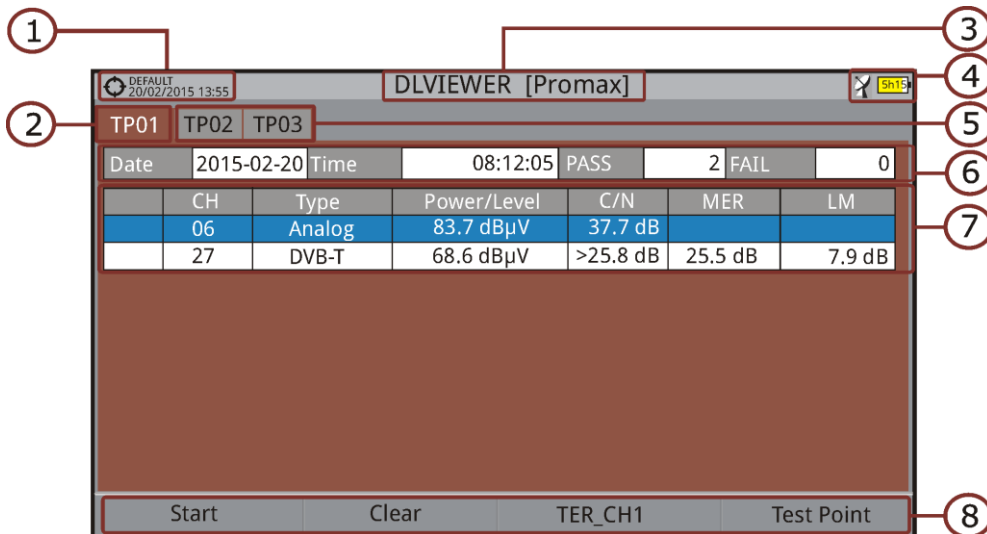

**Figure 74.** Channel Plan Datalogger viewer.

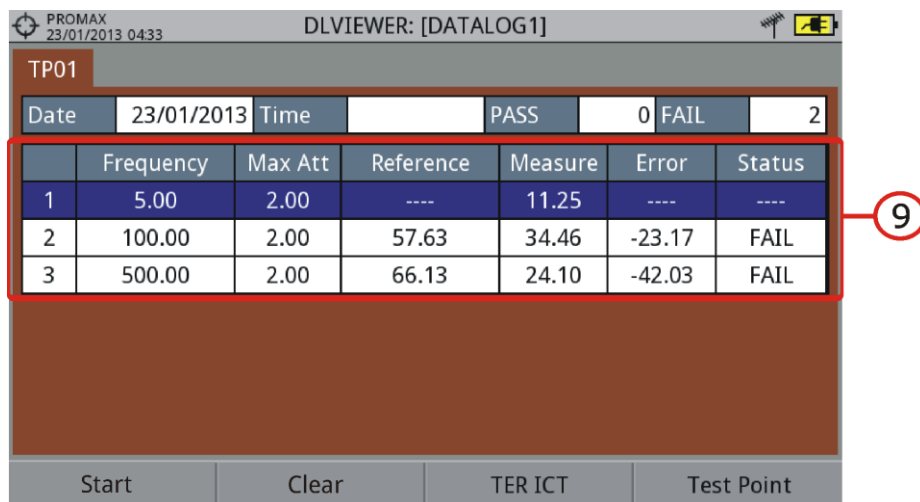

**Figure 75.** Attenuation test Datalogger viewer.

- ① Selected installation; date and time.
- ② Tab identifying the displayed test point.
- ③ Current datalogger name.
- ④ Selected band; battery level.
- ⑤ Tab identifying each test point.
- ⑥ Date and time when the datalogger was created. Number of channels locked (PASS) or not locked (FAIL).

- 7 Data table with measurement data for each channel. In order from left to right: Colour identifying if the channel has been locked (WHITE) or not locked (RED) channel; signal type; power/level; Carrier/Noise (C/N) rate; MER; Link Margin. Move the joystick up or down to navigate along the measurement data. Press the joystick on a channel to display the signal parameters.
- 8 Softkey menus.
- 9 Table with the measurement data for each pilot signal in the attenuation test. In order from left to right: number of pilot signal, pilot signal frequency, maximum attenuation allowed, reference level value, level value at the test point, error and signal status.

#### 4.7.7.3 **Menu options**

##### ► Datalogger viewer screen description



**Start:** It starts the datalogger in the selected test point.



**Clear:** It clears all the acquired data.



##### **Channel plan**

It displays a menu with the available channel plans to select the channel plan whose data want to be displayed. Channel plans available are those that have been selected during the creation of the datalogger.



##### **Test Point**

It contains four options:

**Jump to:** It allows selecting a test point.

**Create New...:** It creates a new test point.

**Delete current:** It deletes the current test point.

**Delete all:** It deletes all test points of the datalogger.



► **Datalogger menu options**



**Cancel**

It cancels the datalogger.



**Pause**

It pauses datalogger until the user resumes by pressing again.

#### 4.7.7.4 **Test & Go**

"Test & Go" function inside the "Datalogger" tool allows the user to create a quick datalogger by creating automatically a new datalogger, a new test point and then starting it.

Datalogger parameters are set automatically based on:

- File name: DL [current band - terrestrial or satellite][consecutive number]
- Channel plan: Current channel plan selected in the equipment.
- Test point: PM01
- No capture of services list.

If "Test & Go" is performed when using the "Attenuation test" tool, then the datalogger created will be specific to save attenuation test data.

#### 4.7.8 **Screen and Data capture (Export key)**

##### 4.7.8.1 **Description**

It captures what is displaying at time.



The capture can be an image, measurement data or both. This is set through the **Preferences** menu ("Export button" option).

Data capture is saved in a XML file with all data, measurements and text, that is on screen at this time. The image is saved in a PNG file.



Captures can be displayed on the equipment or also can be downloaded and displayed through an external software.

#### 4.7.8.2 **Operation**



##### ► **Settings**

- 1 Press the "Management Installation"  key for one second to enter "Preferences" menu.
- 2 Go to the label " **Tools**" and select your option in "**Export button**". There are three options available: Screen Only, Data Only or Screen+Data. "Screen Only" saves the screen image in PNG format. "Data Only" saves measurement data on screen in a XML file format. "Screen + Data" saves both screen and data.
- 3 Once selected, press  to save changes and  to exit "Preferences".

##### ► **Capture**

- 1 Press the **Export** key  for one second when on screen appears the screen to be captured. The LED next to key lights.
- 2 A progress bar shows the progress of the capture process. When finished, the screen is captured and the LED is OFF.
- 3 Then the virtual keyboard appears with the default name assigned to the file. The filename for the screen capture is automatically generated with the following code: capture mode (SP for Spectrum mode, TV for TV mode, ME for Measurement mode), capture channel (CHXX) and a consecutive number.
- 4 Edit the name if necessary (see section "Virtual keyboard"). Then press : OK to end the capture or : Cancel for cancellation.

##### ► **Display**

- 1 To display the captured press on the **Installations Management** key .
- 2 Select the installation where the capture was done and press : **Manage**.
- 3 Press : **Filter by type**. Select the "Screen Shots" or "Data Captures" option. This will limit the list to the selected.
- 4 It appears a list of all the captures.
- 5 Move up or down to find the file to be displayed.
- 6 Leave the cursor on the file to be displayed. It appears a progress bar that lasts a few seconds, depending on the size. Then the capture appears.



- 7 To see the capture in full screen just press the F4: **Options** key and then on the menu press "View in Full Screen". To exit the full screen view press any **softkey**.
- 8 To delete or copy the capture to a USB stick, select the capture by pressing the joystick, and then select the appropriate option from the menu **F2**: **File**.
- 9 Captures can also be viewed on a PC, by downloading the whole installation file using the NetUpdate software (see the NetUpdate manual for more information).

#### 4.7.9 Explore Channel Plan

##### 4.7.9.1 Description

This option performs a scan of the selected channel plan. It detects where active signals are in a channel plan and in which channels of the current channel plan signal is received. With this information it explores these channels with signal, looking for any broadcast and identifying them.

##### 4.7.9.2 Operation

Explore Channel plan tool is available for all signals.

- 1 Connect the **RF** input signal to the equipment.
- 2 Access Preferences by pressing the Installations key  for 1s.
- 3 At the 'Measures' tab check the minimum values for the signal to be identified during the scan (for more information refer to section: Preferences -> Measures options).
- 4 Press the **Tools** key **F3**.
- 5 Select the **Explore Channel Plan** option.
- 6 The first screen of **Explore Channel Plan** appears.

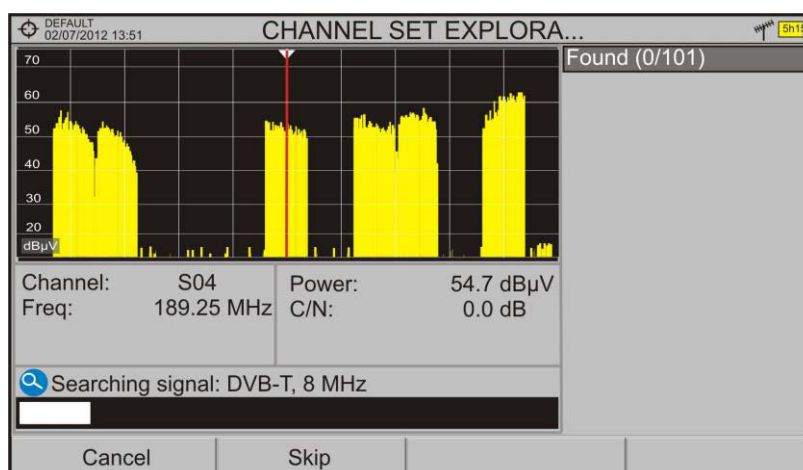

**Figure 76.**

7 After the exploration the following screen appears:

► **Screen description**

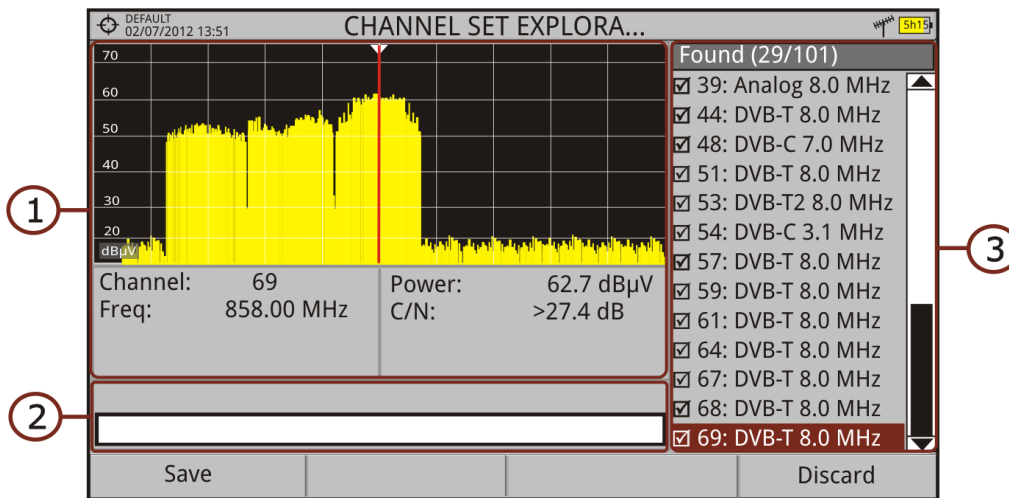

**Figure 77.**

The window is divided into three areas:

1 **Spectrum and Measurement**

It shows the cursor scrolling through each of the channels of the channel plan. On the bottom of the screen the channel and frequency appears next to the Power/Level and the C/N ratio.

2 **Progress Bar**

It shows the signal type detected and the scan progress in real time. At the end a box shows a message informing the exploration process has finished.

3 **Channel plan**

At the end of the process it shows the channels that have been detected during the channel plan exploration. In parentheses shows the number of detected channels to total channels of the channel plan. When moving the cursor through the channels, the spectrum and measurement windows are dynamically updated for the selected channel.



#### 4.7.9.3 Menu options

At the bottom are the function keys. They are detailed below.



**Cancel** (during the process):

This option appears only while performing the exploration process. It cancels the exploration before finish. When pressing, a confirmation message appears before cancelling.



**Save** (at the end of the process):

This option appears at the end of the exploration process. It saves the results obtained during the exploration. The name of the original channel plan is assigned to the new one by default and the user can modify the name using the virtual keyboard that appears prior to saving. The new channel plan is now available in the list of channel plans in the installation and can be used as any other channel plan. After saving it becomes the selected channel plan to work with.



**Skip** (during the process):

This option allows skipping the current channel and explore the next one in the channel plan.



**Discard** (at the end of the process):

This option appears at the end of the exploration process. It discards the results obtained from the exploration.



[Click here to watch this video: Channel plan exploration](#)

#### 4.7.10 Discover FM stations

##### 4.7.10.1 Description

The **Discover FM Stations** tool scans the FM band and creates a FM channel plan from scratch. Scanned frequency range is from 87 to 108 MHz.

##### 4.7.10.2 Operation

To scan the FM band:

- 1 Connect the **RF** input signal to the equipment.
- 2 Press the **Tools** key .
- 3 Select the **Discover FM Stations** option.
- 4 The first screen of **Channel Plan Exploration** appears and the exploration starts.



Figura 78.



5 After the exploration the following screen appears:

► **Screen description**

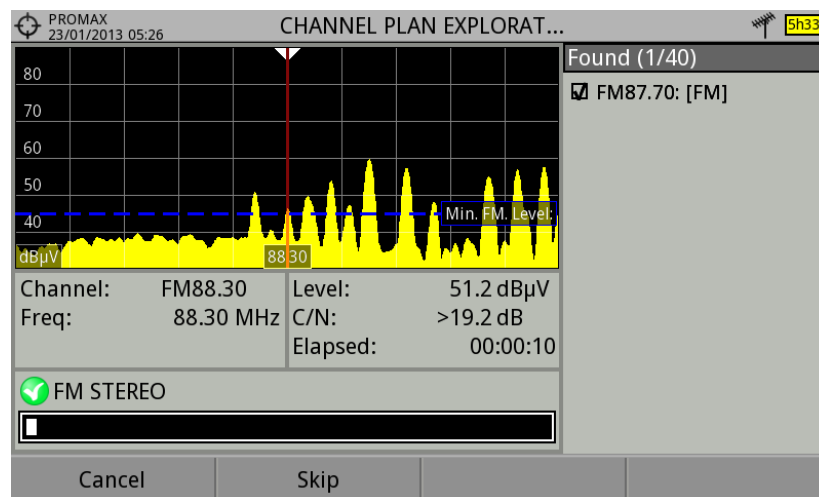
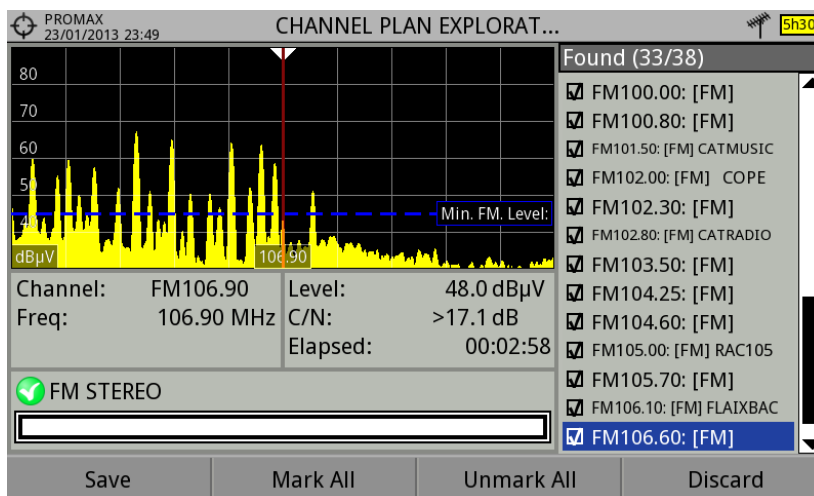



Figure 79.

The window is divided into three areas:

1 **Spectrum and Measurement**

It shows the cursor scrolling through each of the channels of the **FM** band. On the bottom of the screen the channel and frequency appears next to the Power/Level and the C/N ratio.

In the spectrum area there is the **Minimum FM Level**. This line is the minimum signal level required to identify the FM signal. The channels below that signal level will not be identified. It can be configured in the "Measures" tab in "Preferences" .

2 **Progress Bar**

It shows the signal type detected and the scan progress in real time. At the end a box shows a message informing the exploration process has finished.

3 **Channel Plan**

It shows a list with the channels being detected during the exploration of the FM band. At the top and between parentheses there is the number of detected channels to total channels. When moving the cursor through the channels, the spectrum and measurement windows are dynamically updated for the selected channel. User can mark / unmark the FM channels to save in the channel plan.

#### 4.7.10.3 Menu options

At the bottom are the function keys. They are detailed below:



##### **Cancel** (during the process)

This option appears only while performing the exploration process. It cancels the exploration before finish. When pressing, a confirmation message appears before cancelling.



##### **Save** (at the end of the process)

It saves the results obtained during the exploration and selected by the user. It is assigned a name by default to the channel plan but the user can modify the name using the virtual keyboard that appears prior to saving. The new channel plan is now available in the list of channel plans in the installation and can be used as any other channel plan. After saving it becomes the selected channel plan to work with.



##### **Skip** (during the process)

This option allows skipping the current channel and explore the next one.



##### **Mark All** (at the end of the process)

This option marks all the channels that appear on the channel list.



##### **Unmark All** (at the end of the process)

This option unmarks all the channels that appear on the channel list.



##### **Discard** (at the end of the process)

This option appears at the end of the exploration process. It discards the results obtained from the exploration.

#### 4.7.11 **Field Strength**

##### 4.7.11.1 **Description**

This function allows the equipment to work as a field strength meter, measuring dB $\mu$ V per meter. To perform this type of measurement is needed to enter the calibration parameters of the antenna being used to receive the signal.

##### 4.7.11.2 **Operation**

The **Field Strength** tool is available for all signals received by the **RF** input.

- 1 Connect the antenna to the **RF** input of the equipment.
- 2 Select a channel or frequency.
- 3 Press the **Tools** key.
- 4 Select the **Field Strength** option and in the drop down menu select **On**.
- 5 Select again the **Field Strength** option, now select the new option that appears, called **Configuration**.
- 6 In the configuration window enter the antenna calibration parameters, by hand or selecting one of the available antenna types (data of different antenna types should be imported by the user. Refer to the following section).
- 7 Now access the **Spectrum Analyzer** or **Measurement** mode to check the field strength measure shown as FSM (dB $\mu$ V/m). This measure replaces the power.

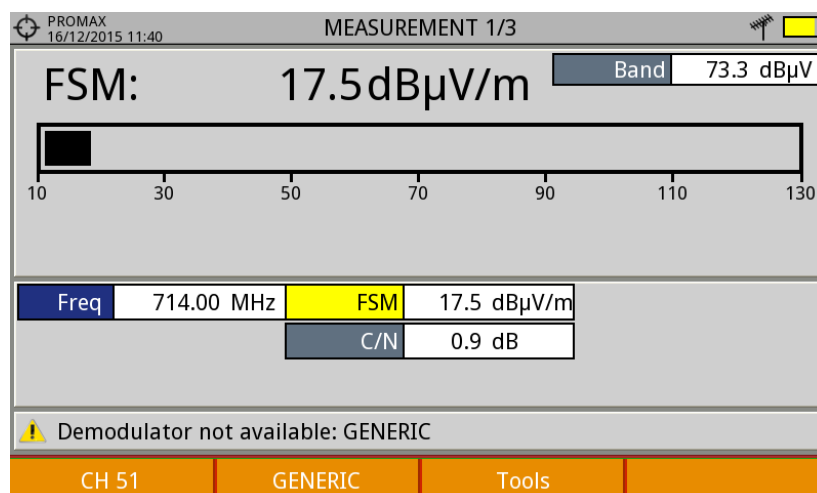

**Figure 80.**

- 8 To save FSM data, go to "Tools", select "Datalogger" and then "New" to create a new datalogger. Keep in mind that the "FSM" tool does not demodulate any signal, it only detects the transmitted energy, so it is identified as a GENERIC signal. For this reason only FSM data is saved for each channel (for more information refer to "Datalogger" chapter).
- 9 Once finished, return to the **Tools** menu and in the **Field Strength** option select **Off**.

**WARNING:** Some tools (Constellation, Echoes, MER by carrier, Merogram ...) are disabled when the **Field Strength** option is enabled. Remember to turn off "FSM" option if you want to use these other tools.

#### 4.7.11.3 Settings

The **Field Strength** configuration option allows the user to enter the correction factors for the antenna and cable used when measuring the field strength.

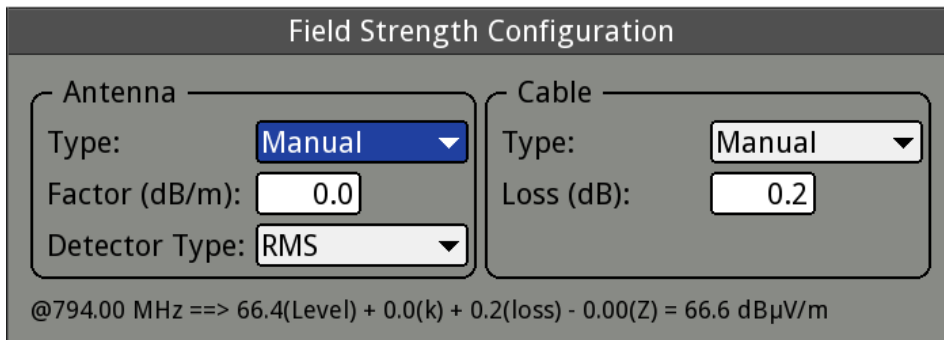

The image shows a software dialog box titled "Field Strength Configuration". It is divided into two main sections: "Antenna" and "Cable".

- Antenna section:**
  - Type: Manual (dropdown menu)
  - Factor (dB/m): 0.0 (text input)
  - Detector Type: RMS (dropdown menu)
- Cable section:**
  - Type: Manual (dropdown menu)
  - Loss (dB): 0.2 (text input)

At the bottom of the dialog, there is a calculation result:  $@794.00 \text{ MHz} \implies 66.4(\text{Level}) + 0.0(\text{k}) + 0.2(\text{loss}) - 0.00(\text{Z}) = 66.6 \text{ dB}\mu\text{V/m}$

Figure 81.



Data fields to be filled are:

► **Antenna:**

- **Type:** In this field the user can select the type of antenna between manual and any other type of antenna available. If you select the manual antenna, you must enter the correction factor by hand. If you select an antenna type then the correction factors associated with each frequency are applied. These data are defined in the antenna file imported by the user.
- **Factor:** This is the correction factor (K) for the antenna at the measurement frequency.
- **Detector Type:** (PEAK / RMS). It allows the user to select between maximum PEAK detector or RMS detector. The maximum peak detector is mainly used for analogue modulated signals, while the RMS option is the right choice for digital modulated signals.

► **Cable**

- **Type:** In this field contains the user can select the type of antenna between manual and any other type of cable available. If you select the manual cable, you must enter cable loss by hand.
- **Loss (dB):** In this field you must enter the estimated loss for the cable used to connect to the antenna.

In the bottom of the configuration window you can see the field strength in real time according to the current frequency and correction factors.

#### 4.7.11.4 Creating and importing calibration tables

The user can import the antenna calibration data obtained from the manufacturer. There is a template (available on the download area at PROMAX website) that can be filled and imported into the equipment (this template has been created in an Excel file; the procedure explained below only works for the Excel 2007 version and above).

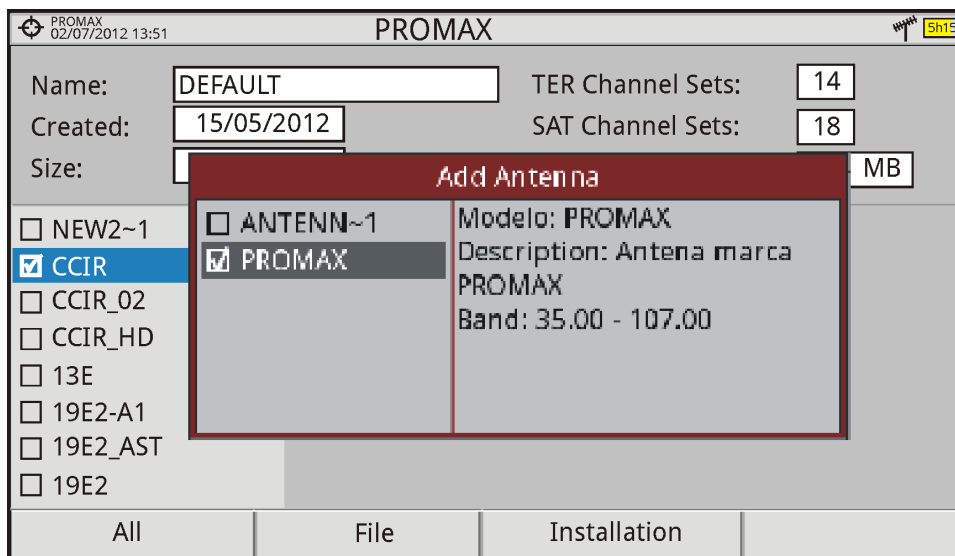

**Figure 82.**

Next are the steps to fill in the template data and import them to the equipment:

##### ► Generation







- 1 Download the "Antenna XML Generator" template from the PROMAX website.
- 2 In the "Model" box enter the name by which the antenna will be identified (maximum 8 characters).
- 3 In the "Description" box, type a description to identify the antenna.
- 4 In the "Impedance" box select the impedance of the antenna between 50 and 75 ohms.
- 5 In the "Height" box enter the antenna height in meters.
- 6 Now fill the calibration table of the antenna with the K factor according to frequency.
- 7 When filling the table does not change the units.
- 8 Extend or contract the calibration table to the number of filled lines.
- 9 After filling the calibration table, go to option "Save As -> Other Formats."





- 10 In the window that appears, edit the file name in "File name".
- 11 In the drop down menu "Save as type" select the "XML Data" option. Then click "Save."
- 12 If a warning message shows up, click "Continue".
- 13 Now the file is already generated with the selected name and the extension ".xml".
- 14 Now just import it to your equipment and load the calibration table of the antenna in the installation.

### ► **Import**

- 1 Copy the generated file on a flash drive and connect it to the mini-USB port using the supplied cable.
- 2 Press the **Installation Manager** key .
- 3 Press the  "Tools" key.
- 4 Select "Import from USB" option.
- 5 The Import Files window appears. Select the generated file and press the  "Import" key.
- 6 Press the **Installation Manager** key , select the installation to which you want to add the antenna calibration table and press the  "Manage" key.
- 7 Press  key: "Installation" and select the "Add Antenna" option.
- 8 Select the antenna to be added and OK.
- 9 The antenna calibration table is now added to the installation.
- 10 Now this antenna will be available in the type of antenna field in the configuration menu of the "Field Strength" tool.

### ► **Remove**

- 1 Press the **Installation manager** key.
- 2 Press : **Tools** key.
- 3 Select "Installed Antennas" option.
- 4 Check the antenna to remove.
- 5 Press : **Remove** key.



4.7.12 **Task Planner**

4.7.12.1 **Description**

The **Task Planner** allows the user to set-up a task list, selecting when to start, a repetition rate and other parameters. The equipment can be switched off after setting all parameters and it will wake-up, at the required time, to perform the scheduled tasks.

4.7.12.2 **Operation**

The Task Planner tool is available to run screenshots and dataloggers with RF and IPTV source signals.

- 1 Press the **Tools** key.
- 2 Select the **Task Planner** option to access the Task Planner window that shows a list of scheduled tasks. In the right column and next to each task there is its status: if the date of the next execution appears then the task is pending; if "finished" appears then the task has been executed; if nothing appears then the task has not been scheduled.

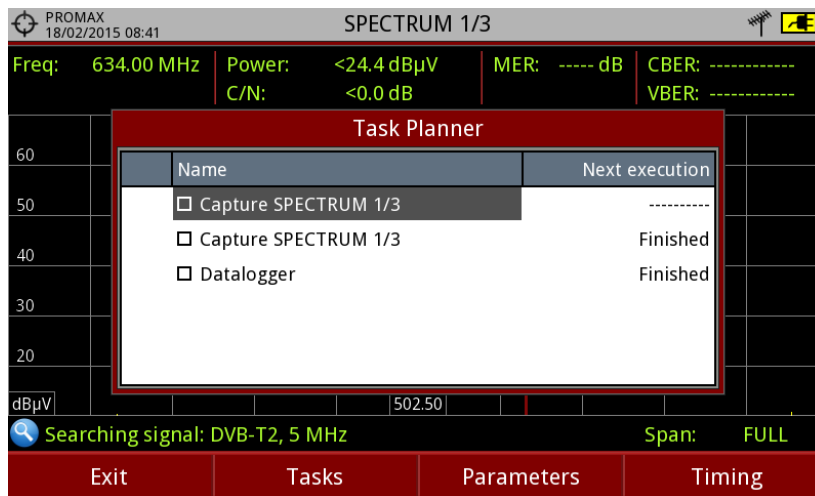

Figure 83.



- 3 To add a new task press **F2**: **Tasks** and select the **"Add"** option. It deploys a menu with two options: Capture and Datalogger.

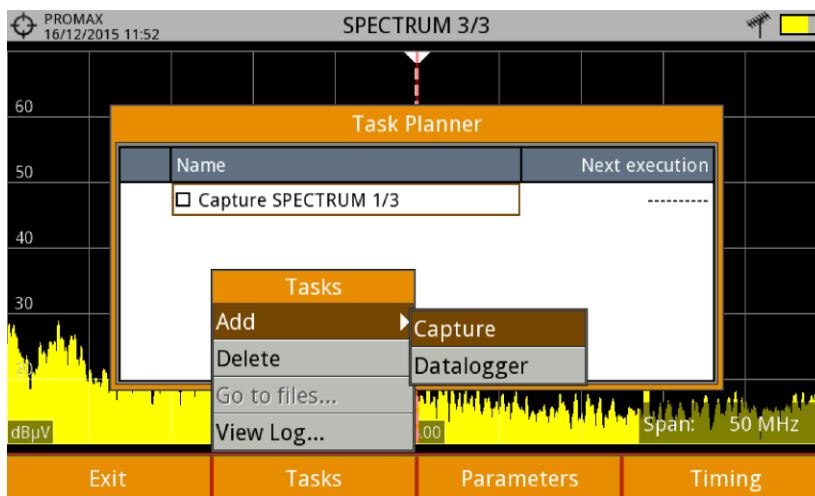

Figure 84.

- 4 The **"Capture"** option performs the capture task. The user can select the screen and type of capture. The screen options include any view in the three modes: Measurement, Spectrum or TV. The options for type of capture are: screen only, data only or screen+data (for details about capture refer to "Screen and data captures (Export button)" section).

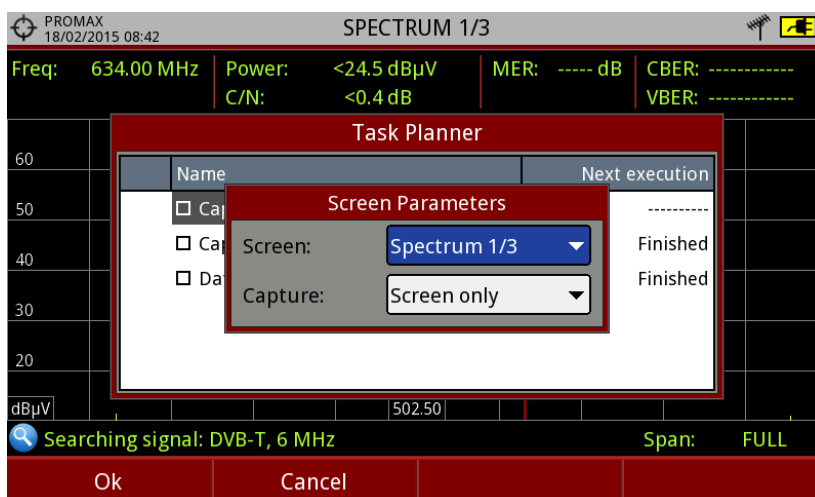



Figure 85.

- 5 The **"Datalogger"** option performs the datalogger task. The user must first select the datalogger from those available for the current installation (for details about datalogger read "Datalogger" section).

- 6 After selecting the type of task, check the box next to it and press **F4:Timer** to schedule the time to execute the task (see next section for details about the timer).
- 7 When saving the timer for the task, the upper right corner shows an icon of a clock  indicating that the equipment has tasks pending to execute.

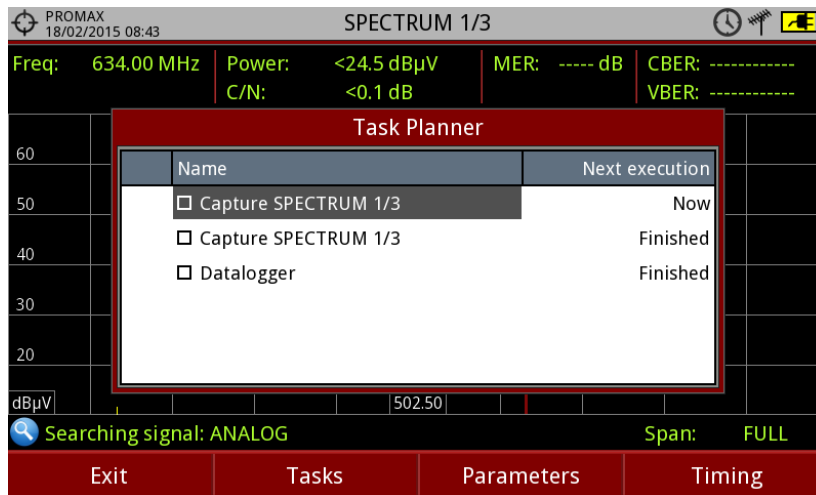

Figure 86.

- 8 To change any parameter of the task, check the box next to the task and press **F3: Parameters**.
- 9 To delete a task, check the box next to it and in **F2:Tasks**, press "**Delete**".
- 10 After setting up the tasks press **F1:Exit**. Since this moment the timer for task execution starts.
- 11 When the task is finished, the user can access the data through "**Go to file ...**" option in **F2:Tasks**. It will take you directly to the management installation window where the data for each installation are stored.
- 12 Once the task is completed, user can access a short log for each programmed task, just to know if each task has been successfully completed or to indicate if something prevented its execution. To access this function, from **Task Manager**, press **F2: Task** and then "**View Log...**".



- NOTE:**
- The equipment can be turned off after task planning as it will automatically turn on when the time to task execution comes.
  - Two tasks cannot be executed simultaneously.
  - It is recommended that the datalogger selected have not enabled the option to pause between channel plans, since in that case the process would stop during the execution of the task.
  - The filename for the screen capture is automatically generated with the following code: capture mode (SP for Spectrum mode, TV for TV mode, ME for Measurement mode), capture channel (CHXX) and a consecutive number.

### 4.7.12.3 Timer

The timer window contains several options for task scheduling.



**Figure 87.**

#### ► Start

- **Start Now:** The task begins immediately after leaving the task planner.
- **On date:** The user selects the start date for the task (day / month / year) and time (hour: minute).

#### ► Repeat every

The task repeats each cycle of time (days, hours and minutes).



► **Stop**

- **Manual:** The user finishes the task.
- **On date:** The user selects the stop date for the task (day / month / year) and (hour: minute).
- **Repeat a number of times:** The task execution ends after the number of times set.

► **Turn off after execution**

By checking this option, the equipment turns off after the execution of the task.

#### 4.7.13 **Transport Stream Analyzer**

##### 4.7.13.1 **Description**

This tool allows the user to make a comprehensive analysis of the Transport Stream (TS) contained in a tuned signal. The signal can be received through any of the equipment inputs: TS -IN, RF, IP, CAM module and terrestrial and satellite demodulators. This feature gives a great flexibility to process the signal in multiple ways, so the equipment becomes a portable laboratory for the analysis of digital signal.

This tool can be of great interest to research centres, broadcasting operators, universities or training centres as well as to installers that want to expand their technical knowledge or training in analysing the smallest unit of a digital signal transmission.

This tool has these main functions:

- **Tables:** It shows all the metadata carried in the corresponding PSI/SI tables in a tree diagram so user can deploy its content to the detail.
- **Bitrates:** It shows the bitrate information for each program in real time, in a graphical way and also shows the percentage contribution of each one to the total TS.
- **Alarms:** It shows a list of alarms that warn about any possible failure in the TS layer according to the three priority levels described in the TR 101 290 measurement guidelines by the DVB group.
- **PID list:** It shows an ordered PID list with a short explanation of its contents. PID bitrate is refreshed continuously to help in understand bandwidth usage.



#### 4.7.13.2 **Operation**

The Transport Streams (TS) Analyzer tool is available for all DIGITAL signals.

- 1 Connect the digital signal to any input of the equipment.
- 2 Select the channel or frequency and tune the signal.
- 3 Press the **Tools** key .
- 4 Select the **TS Analyzer** option.
- 5 A drop down menu appears with three options: **Tables, Bitrates, Alarms, PID list and T2MI**. Select your option.
- 6 While starting, the TS Analyzer takes few seconds to detect and identify the TS signal (it shows the table capture process on screen), and then the results appear.
- 7 An error message pops up if the signal does not contain any TS or if the TS cannot be found. In this case, check the signal.

The following describes in detail each one of these functions.

#### 4.7.13.3 **Table Analyzer**

##### ► **Description:**

This function displays the TS tables. When system starts it shows the table capture process. When it finishes tables are shown in a tree diagram for easy browsing with the joystick. All components and contents of tables can be consulted by deploying the nodes. So the user can analyse the tables and see in detail what is being transmitted and if the information is properly encapsulated. This tool requires detailed knowledge about the contents of these tables.



► **Screen Description:**

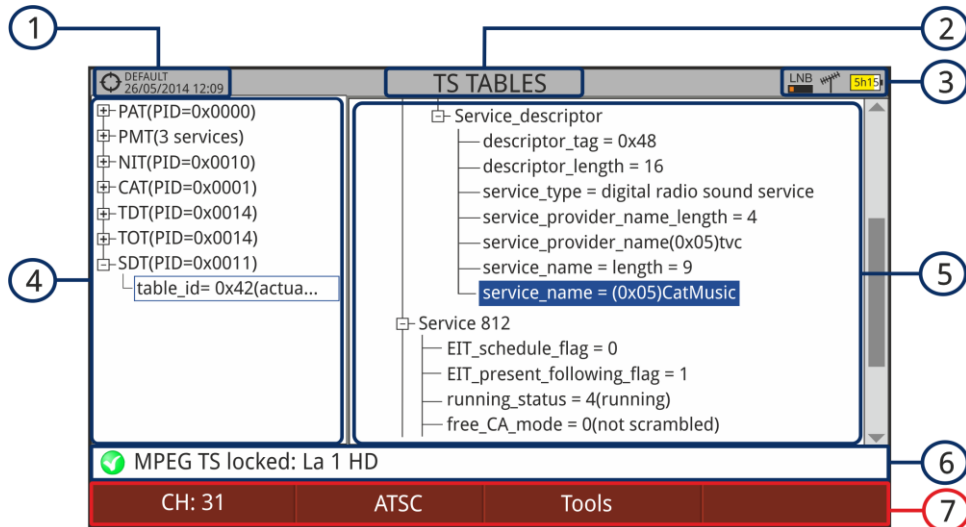

**Figure 88.**

- 1 Selected installation; date and time.
- 2 Selected function.
- 3 Selected band; battery level.
- 4 Main Table Tree.
- 5 Detail Table Tree.
- 6 Signal status (searching/locked/multiplex name).
- 7 Softkey menus.

- Joystick **left/right**: It changes between Main menu tree and Detail menu tree.
- Joystick **up/down**: It moves along the tables in the tree.
- Joystick: Pressing on a node with the symbol it deploys the tree. Pressing on a node with the symbol it closes the tree.

- **Advanced** : It shows the "**Restart Analysis**" option which makes a new detection and updating of the TS tables.

► **Tables Description:**

Below is a brief explanation of the main tables that can appear in the detection of a TS. For more details we recommend to consult the these guidelines [ETSI TR 101 211](#).





There are two generic groups of tables:

- **PSI** (Program Specific Information) **Tables**: These tables are specified by the MPEG-2 standard worldwide. They are used by all the digital transmission standards. The TS analyzer detects all the PSI tables.
- **SI** (Service Information) **Tables**: These tables are specified by the standard used in the area or country (in this case DVB). These tables are more detailed and imply a higher level of information relating to the PSI tables. The TS analyzer detects the most important SI tables.

The PID (Packet Identification) code next to the name of the table is a 13-bit code that identifies each packet type and therefore to what kind of table corresponds.

#### ► **PSI Tables:**

PSI tables are:

- **PAT** (Program Association Table): It is a master table that lists all services found in the TS being transmitted. It also points the table where are specified each one of the services.
- **PMT** (Program Map Table): It is a table that identifies all the components within a service (video, audio and/or data).
- **NIT** (Network Information Table): Optional table with information about TS and multiplex of a given network. The content in detail is described in the tables used by the digital standard (DVB in this case).
- **CAT** (Conditional Access Table): Table that controls the scrambling of a service.

#### ► **SI Tables:**

Most important SI tables are:

- **NIT** (Network Information Table): It is a master table used by the broadcasting network to manage the services. It provides logic network info by grouping several TS together and adding tuning information for all network services. In the case of a satellite provides information about its channels. It also contains the LCN descriptor that provides information to order the services.
- **BAT** (Bouquet Association Table): It is a table containing information required to group a set of services or content, which is related for commercial reasons (packs of a particular distribution platform, packs of a particular film genre or sport, etc.).
- **SDT** (Service Description Table): It is a table with a description of each service, providing a service name and other related information such as head-end and service details, if it is scrambled or not, if it is radio or tv, the provider, etc.



- **EIT** (Event Information Table): Table that provides information on events (program or programs being broadcasted) in a given service. It is the basis for building an EPG (Electronic Program Name), the program guide shown on TV.
- **TDT** (Time and Date Table): Table that provides UTC (Universal Time Coordinated) coded as MJD (Modified Julian Date) that means, time and date at the current moment and universal.
- **TOT** (Time Offset Table): Table that provides the time offset related to UTC in order to calculate the local time. It also provides information on daylight saving time changes.

**4.7.13.4 Bitrate Analyzer**

► **Description:**

This function shows the TS bitrate in a graphical way, and also by numbers and percentage. A pie graph, which is updated in real time, shows the evolution of the bitrate distribution for each one of the services in the tuned multiplex. It also allows selecting any of the services to check its composition, which is also shown in bar graph.

This function allows the user to compare between television services and to check the bitrate used by each one. User can observe dynamically the variation that when changing the transmission content. Another use may be to identify the amount of null packets and therefore to know the amount of available payload by the multiplex.

► **Screen Description:**

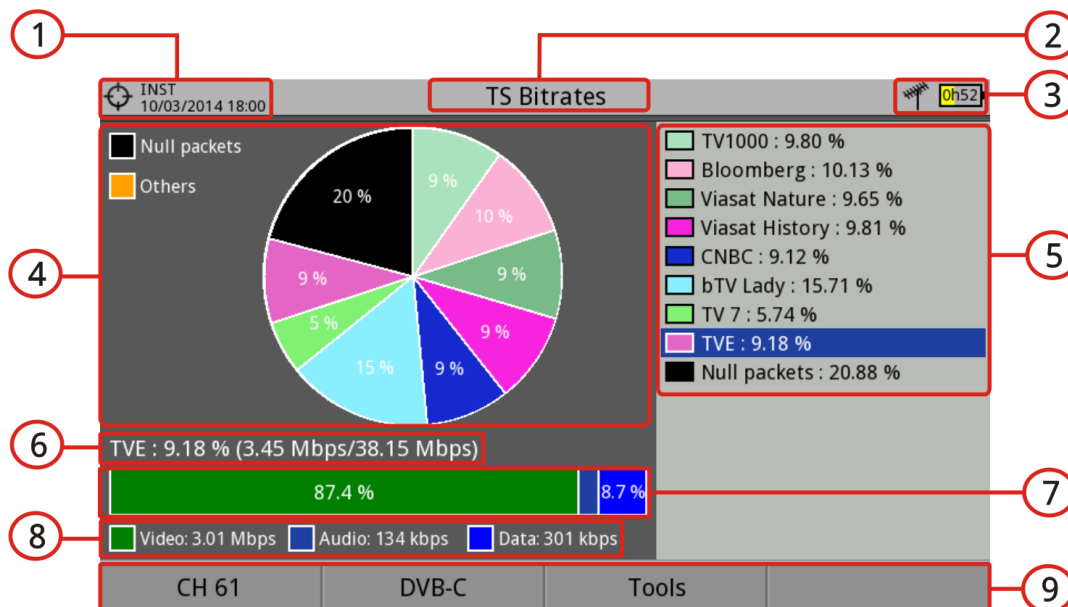



Figure 89.



- ① Selected installation; date and time.
  - ② Selected function.
  - ③ Selected band; Battery level.
  - ④ Pie Chart. The graph represents and shows the percentage of each service on the total bitrate for the tuned channel. The colours of the graph correspond to the services detected. They are shown on the right side of the screen. Services with a very low percentage are grouped with the legend "Others".
  - ⑤ Detected services. It shows all the services identified in the tuned multiplex and the percentage of each service relating to the total bitrate.
  - ⑥ Detail of the Selected Service: Service name and percentage related to the total bitrate (bitrate/total bitrate).
  - ⑦ Bar graph representing the bitrate percentage for each component (video, audio, data).
  - ⑧ Video bitrate, audio and data.
  - ⑨ Softkey menus.
- ▶ Joystick **up/down**: It moves among detected services.
  - ▶ Joystick: Pressing on a service it will show details of the selected service.
  - ▶ **Advanced** : It shows the "**Restart Analysis**" option which makes a new detection and updating of the TS tables.

#### 4.7.13.5 **Alarms**

##### ▶ **Description:**

This tool monitors the TS. It is a dynamic tool as it displays in real time the evolution of the TS and the alarms that may occur. The priority levels of alarms are set according to the recommendations by technical standards TR 101 290.

Each alarm has a log where events are stored. These data can be exported.

► Screen Description

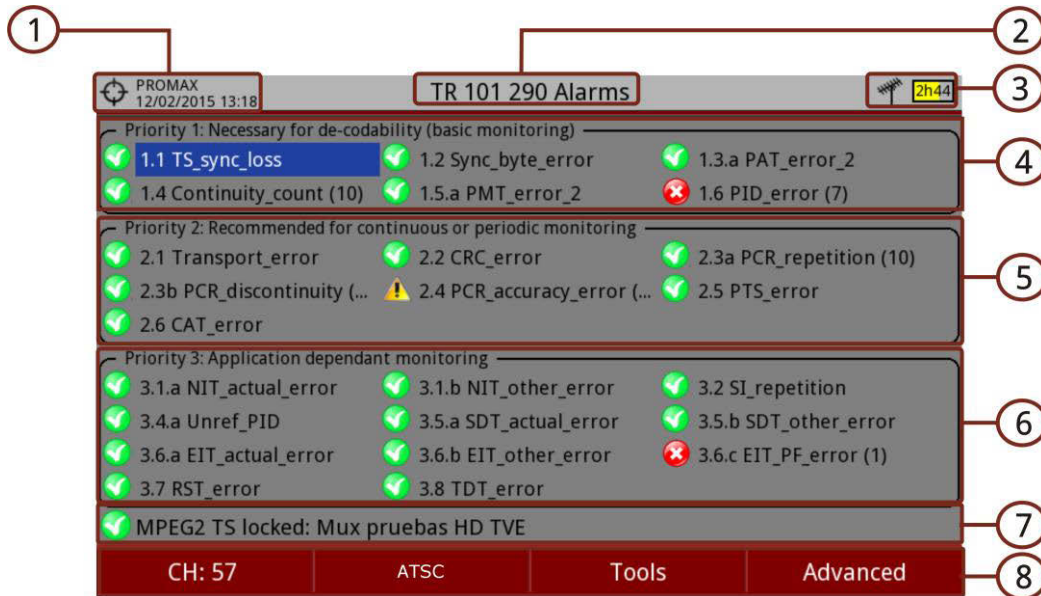



Figure 90.

- 1 Selected installation; date and time.
- 2 Selected function.
- 3 Selected band; Battery level.
- 4 **Priority 1:** High level security parameters. These are alarms that make the TS vulnerable and avoid them to be received. The parameters at this level must be correct for the TS to be decoded. If any of these parameters fails the information cannot be recovered and therefore the signal cannot be decoded.
- 5 **Priority 2:** Medium level security parameters. These are alarms recommended by DVB for continuous or periodic monitoring of TS and ensure quality of transmission parameters. The alarm in any of these parameters does not prevent the receiving but it is indicative of a possible problem.
- 6 **Priority 3:** Low level security parameters. These are parameters that are not harmful but are required for getting the most from the receiver capabilities. They ensure that the receiver can extract in the best conditions the TS information especially when there are additional features such as the program guide or the services list.
- 7 Signal status (searching/locked/multiplex name).



8 Softkey menus.

**Advanced** : It shows the "Restart Analysis" option which makes a new detection and updating of the TS tables.

- ▶ **Joystick up/down**: It moves among alarms and highlights one on blue background.
- ▶ **Joystick press**: When you press on an alarm, it gives access to the alarm log.
- ▶ Icons that appear according to the alarm type are:



OK.



Warning.



Error.

▶ **Alarm Log description**

To access the alarm log screen, press on the alarm to access its log screen.



Figure 91.

The "Log" tab shows the alarm log data.

The "Description" tab shows a description of the alarm.

The "Settings" tab shows the following settings options:

- **Enable this alarm**: When this box is checked the alarm is enabled.
- **Notify on error**: It enables or disables the alarm warnings. If it is enabled it will notify the alarm status on screen.



- **Log Size:** It allows the user to select the number of events stored (10, 25 or 50).
- **Order of events:** Select the order for keeping the events between keeping the first or the last ones.

To export the alarm log connect an USB memory to the equipment and press **F2**: **Export**. The data is exported into a plain text file.

**4.7.13.6** PID list

► **Description:**

This tool shows an ordered PID list with a short explanation of each PID and its bitrate. Bitrate is refreshed continuously to help in understand bandwidth usage.

► **Screen Description:**

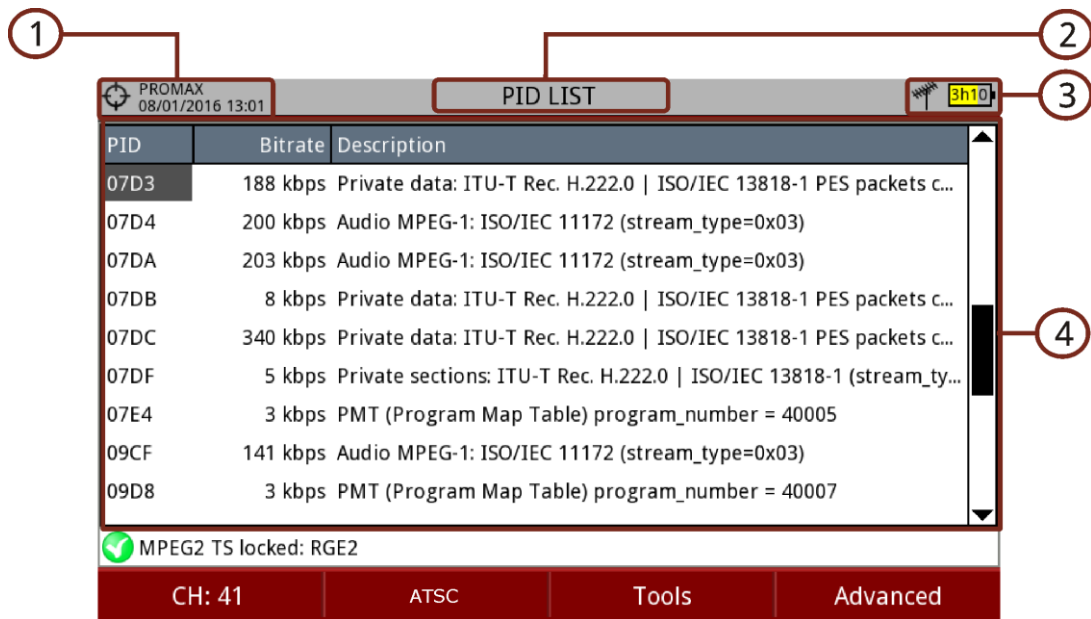

**Figure 92.**

- 1 Selected installation; date and time.
- 2 Selected function.
- 3 Selected band; Battery level.
- 4 PID, real-time bitrate and description.



#### 4.7.14 **Transport Stream Recording**







##### 4.7.14.1 **Description**

This tool captures in real-time transport streams received by any input (RF, ASI or IP) such as a DTT channel. The recording is stored in an internal dedicated memory of 1 GB. After recording, it can be played on the equipment itself as if it were a live received signal. The recording time depends on the bit rate of the transport stream, but by reference to a signal of 19.9 Mbps, six minutes of transmission can be stored.

##### 4.7.14.2 **Operation**

Transport Stream recording is available for all **DIGITAL** signals.

To access the **Transport Stream recording** tool:

- 1 Connect the signal to any of the equipment inputs.
  - 2 Access the **SETTINGS** menu  and in the **Source Signal** option select between IPTV or RF.
  - 3 Access the **SETTINGS** menu  and in the **Decoder TS Input** select from where comes the transport stream: RF, IPTV or ASI Input.
  - 4 Press : Tools and select the option **TS Recording**.
  - 5 It shows the screen for TS recording / playback.
  - 6 Start recording by pressing the **RECORD** key .
  - 7 End recording by pressing the **STOP** key .
  - 8 To play the recorded transport stream press the **PLAY** key .
  - 9 During the playback of the transport stream it can be analysed by the **TS Analyzer** tool as if it was received live. All services encapsulated in the transport stream are also available in the TV mode.
  - 10 When playback ends verify that the **Decoder TS Input** option in the **Settings** menu  is properly set in order to receive the corresponding type of signal.
- Only one transport stream can be recorded, regardless of size.
  - When a new transport stream is recorded, the previous one, if any, is deleted.



► **Screen Description**



**Figure 93.**

- ① Selected installation; date and time.
- ② Selected band; Battery level.
- ③ Recording / playback image.
- ④ Recording / Playback time elapsed.
- ⑤ Control Keys:
  - : Recording.
  - : Rewind.
  - : Stop.
  - : Forward.
  - : Play.
- ⑥ File information window that reports about file duration, the recording date and maximum bit rate.
- ⑦ This window reports about the recording source.
- ⑧ This window reports about available space and total space.
- ⑨ Softkey menus.

► **Joystick Left / Right:** Navigation through the control keys.



#### 4.7.14.3 **Menu options**

In the bottom of the screen are two options accessible via the softkeys.



**Exit:** It exits the tool.



**Erase File:** It erases the internal memory dedicated to record transport stream, prior a confirmation message.



**Export to USB:** It copies the captured TS to an external USB memory. It displays a menu with two options:

**Start copy:** It starts to copy if a USB is connected.

**Start at:** The user can set an offset in seconds from the capture start.

While copying the following data are indicated: percentage completed, amount of data and seconds copied. The copy can be interrupted at any time by pressing **Cancel**. The piece of copy after the cancellation is fully functional.



**Advanced:** It allows to enable the "Play Loop" option for playing the recorded stream in an endless loop.

#### **ATTENTION:**

Please note that due to the huge size of such files and the slow transfer speed, the total time for a copy of TS can take several hours. For this reason it is recommended to use this option only when the internal TS capabilities are not enough. In that case, a 15 seconds TS capture is enough to detect tables issues.



#### 4.7.15 Shoulders Attenuation

##### 4.7.15.1 Description

This tool measures interferences in adjacent channels that look like shoulders.

Broadcast signals such as DVB-T, DVB-T2, ISDB-T or ATSC are constructed to follow strict RF requirements mostly aimed to ensure they occupy the bandwidth they have been assigned and they do not interfere with any other adjacent channels. In particular the shape of the signal spectrum must be within the limits of certain given masks specified in the different corresponding standards, i.e. ETR290 recommendations for DVB-T. The specific masks depend on the type of signal and standard.

Due mainly to nonlinearities in the power amplifiers the output RF signal contains unwanted band limit and out of band components, the shape of which has given rise to the term "shoulder", that tend to compromise the compliance with the mask limits.

##### 4.7.15.2 Operation

Shoulders attenuation tool is available for DIGITAL TERRESTRIAL signals.

- 1 Shoulder attenuation should be measured at the output of the power amplifier right before sending the signal to the antenna through the net of passive devices. Because of the power level typically available at that point it is mandatory to use external power attenuators so that the level can be adapted to the maximum accepted by the Analyzer.
- 2 Connect the signal to be measured to the RF input.
- 3 Tune a digital channel in terrestrial band.
- 4 Press the  **Utilities** key
- 5 Select the **Shoulders Attenuation** option.
- 6 The **Shoulders Attenuation** screen shows up.



► Screen Description



Figura 94.

- ① Frecuency / tuned channel; Power; C/N; MER; CBER; VBER of pilot signal.
- ② Channel spectrum showing shoulder attenuation delimited by two vertical red markers. These markers delimit the area of calculation for Upper shoulder attenuation and Lower shoulder attenuation. The Parameters window shows the Resolution of the bandwidth.

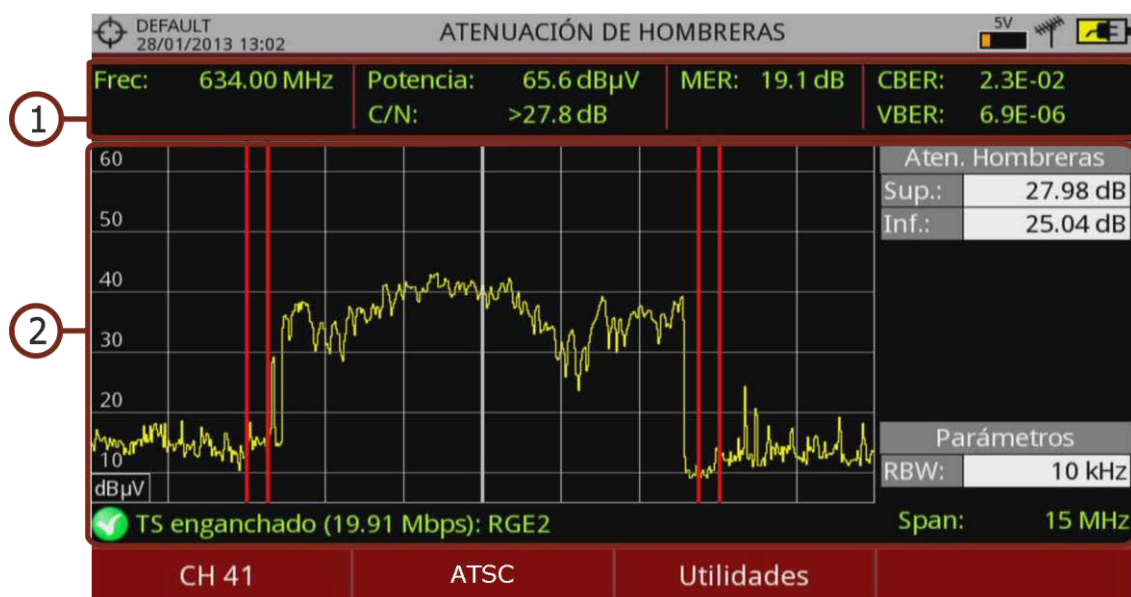

## 5 WIFI SIGNAL TUNING

### 5.1 Introduction



WiFi allows connectivity and communication among devices in the 2.4 GHz frequency band. The 2.4 GHz band is used by several technologies simultaneously, such as Bluetooth, Wireless USB, Zigbee (used in Domotics), cordless phones, security cameras, microwave ovens, etc. which may interfere on WiFi devices. For this reason it is necessary to have a tool that can analyze all these signals to detect problems and ensure good level in WiFi communication.

On the panel left side, the equipment has two functions keys, which give direct access to two most important functions to display WiFi signal.

 **MEASUREMENT:** Access the "Site Survey" screen which shows all access points (AP) and its characteristic parameters.

 **SPECTRUM:** Access the "WiFi Spectrum" screen which shows the spectrum signal over the Access Point detected and power measures.

### 5.2 Operation

- 1 Connect the USB WiFi adapter (supplied) to one of the two USB connectors on the device. The "Wi-Fi Configuration" window pops up, allowing you to set up your device in the network, and also performs a Wi-Fi scan and shows the networks detected. If it is successful, the WiFi icon will appear at the top of the screen. Press F1 to exit.
- 2 Connect the omni-directional antenna (supplied) to the RF input.
- 3 Press "Settings" key to access Settings menu and in "Signal Source" select "WiFi".
- 4 Press "Settings" key again, access "Band" option and select from available bands.
- 5 To display Access Point information, press key. Press "Advanced" key MEASUREMENT  for more details about the access point.
- 6 To display the WiFi spectrum screen press SPECTRUM key . To monitor a signal, enter an access point or channel by the "Tuning" menu (F1) or navigate left / right through the access points / channels. Define the workspace using the span to focus on the desired APs.
- 7 To return to RF tuning press "Settings" key to access the Settings menu and in "Signal Source" option select "RF".



## 5.3 Settings

WiFi settings window is available right after the USB WiFi adapter is connected to the device. It is also available as an option in "Tools" menu (F3 key) on the RF mode.

WiFi settings are:

- **Band:** Select the WiFi frequency band to be monitored.
- **DHCP:** Enable this option to get automatically the proper IP address when the unit is first connected to a network. Enable the DHCP protocol for proper IP configuration.
- **IP Address:** IP Address of the equipment into the local network.
- **Mask:** Subnet mask of the equipment (by default 255.255.255.0).
- **Gateway:** It allows the meter to get out from the local network (if the network does not have gateway, use 0.0.0.0).

## 5.4 WiFi Spectrum

### 5.4.1 Introduction

This function shows spectrum on the WiFi band over access points and also data about power, identification and channel bandwidth. Set the screen to clearly see each channel occupation.

With this function you can determine the occupation of each channel, how many APs share the same spectrum and activity at any point on the spectrum.

All this information help user to determine the best place to place the AP or to analyze interferences on the spectrum.

To display the WiFi spectrum screen from the WiFi tuning mode, press the SPECTRUM key .

## 5.4.2 Screen Description

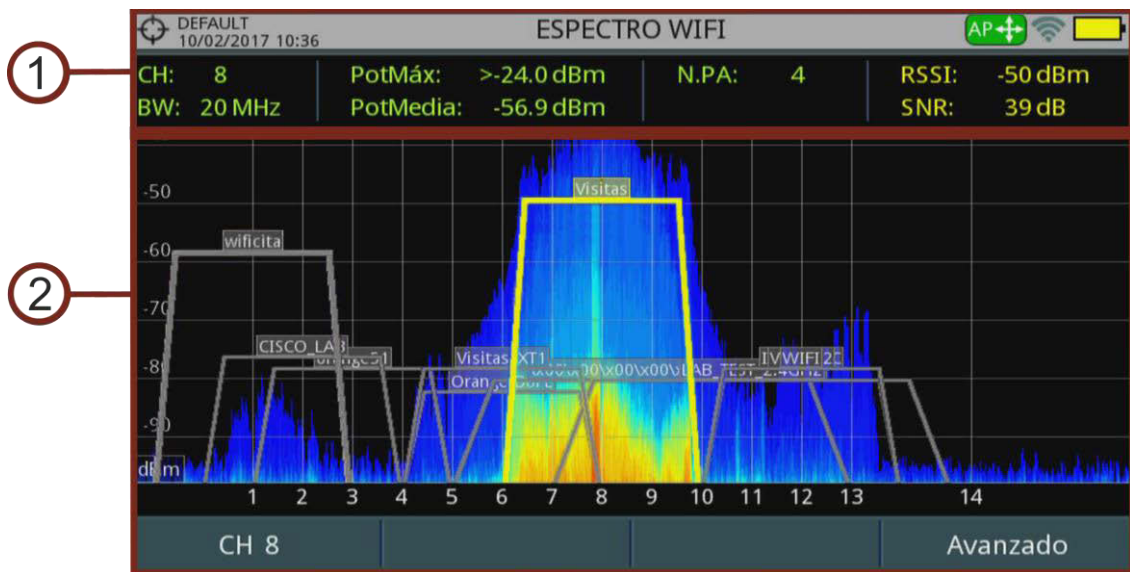

Figure 95.

### 1 Measures

**CH:** Selected channel / Channel at selected Access Point.

**BW:** Channel / Access Point bandwidth. Channel bandwidth changes depending on the AP. Each AP can work in different bandwidths depending on standard and configuration.

**AvPower:** RMS value of power detected in the channel (dBm) measured during a time interval necessary to obtain a stable measurement. This power will always be integrated in the bandwidth determined by channel or access point.

**MaxPower:** Maximum power detected at the channel (dBm) during the same time as the one used for AvPower measurement. This power will always be integrated in the bandwidth determined by channel or access point. Each time the channel changes, the measure restarts.

**N.AP:** Number of access points using the same channel. This number determines if the channel is very saturated. If it is used by more than one AP there may be times with a high percentage of use.

**RSSI (Received Signal Strength Indicator):** Power measured by the dongle (USB WiFi adapter) of the selected Access Point. The dongle measures the power of a single AP and the meter measures the power of an area of the spectrum where there may be several APs. For this reason and also for using different type of antennas on both devices, the power measured by the dongle and by the spectrum may not match.

**SNR (Signal to Noise Ratio):** SNR measurement provided by the USB WiFi adapter over the selected channel / Access Point.



## 2 WiFi Spectrum

It shows WiFi channels within the WiFi band, Access Points detected and name, bandwidth and spectrum. Spectrum is drawn from the signal received by the RF input.

This screen allows you to know how busy each channel is, how many APs share spectrum, activity in each point of spectrum, etc. Spectrum not only shows WiFi signals but any signals that use this band, such as those coming from security video cameras, etc. which allows you to easily identify interferences in a network.

### ► How to scroll on the screen:

To change mode: press joystick.

Joystick Left / Right

In AP mode: It changes access point.

In CH mode: It changes WiFi channel.

In SP mode: It changes span.

Joystick Up / Down: It changes reference level.

### 5.4.3 **Menu Options**

#### ► Tuning menu (F1)

Press F1 to access this menu. It has some options to tune a channel or an access point.

The Tuning menu has these options:

- **Channel / Access Point:** It allows you to select the channel / AP to tune (type of tuning is set by the "Tuning by" option). After pressing it shows available channels / AP to select.
- **Channel Plan:** This option allows the user to select a channel plan from the ones available for the current installation.
- **Tune by:** It allows the user to select between tuning by channel or tuning by access point.

Tuning by channel: Allows you to select a channel or move from channel to channel by pressing left / right. When the channel corresponds to an Access Point channel, the AP highlights and shows some information on screen (RSSI and SNR).

Tuning by AP: Allows you to select a AP or move from AP to AP by pressing left / right. The selected AP highlights and shows some information on screen (RSSI and SNR).



- **Reference Level:** It allows you to edit the reference level. The reference level is the power range represented on the vertical axis.
- **Span:** It allows you to edit the span, which is the frequency range displayed on screen.
- **Center Tuned Frequency:** When selecting this option, the channel / Access Point tuned (where the main cursor is pointing) is placed at center of the screen. Frequency will keep at screen center even if changing span or mode (TV or MEASURES). This option does not work with FULL span.

#### ► **Advanced Menu (F4)**

Press F4 to access this menu. It has some options to display the spectrum.

- **Persistence samples:** It allows you to set retentive depth of spectrum. This option helps to identify level of channel usage by non-wireless signals such as those generated by microwave ovens or some wireless video cameras. The more presence of this type of signals in the channel, the brighter the spectrum will appear on screen.
- **Vertical Scale:** It allows you to adjust the vertical scale on screen. Available values are 1, 2, 5 and 10 dB per division.

## 5.5 **Site Survey**

### 5.5.1 **Introduction**

This function shows all Access Points detected and its main parameters.

To display the Site Survey screen from the WiFi tuning mode, press the MEASURES key .

To display a detailed report about the selected Access Point, press F4: Advanced \ View all parameters.



## 5.5.2 Screen Description

### ► Access points at Site Survey

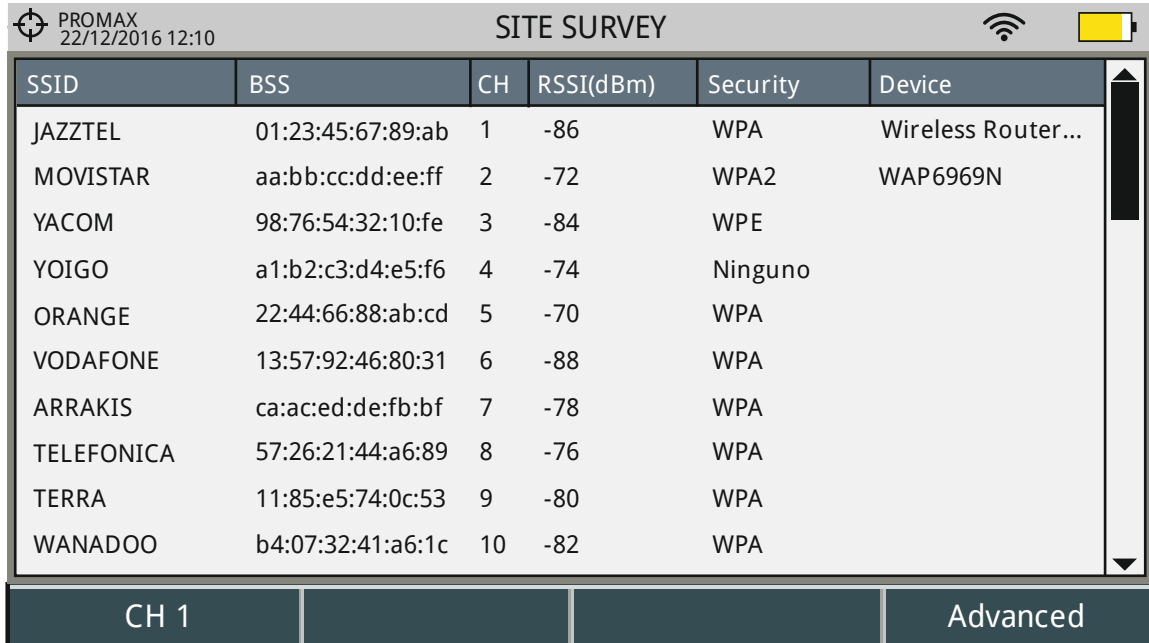

SSID	BSS	CH	RSSI(dBm)	Security	Device
JAZZTEL	01:23:45:67:89:ab	1	-86	WPA	Wireless Router...
MOVISTAR	aa:bb:cc:dd:ee:ff	2	-72	WPA2	WAP6969N
YACOM	98:76:54:32:10:fe	3	-84	WPE	
YOIGO	a1:b2:c3:d4:e5:f6	4	-74	Ninguno	
ORANGE	22:44:66:88:ab:cd	5	-70	WPA	
VODAFONE	13:57:92:46:80:31	6	-88	WPA	
ARRAKIS	ca:ac:ed:de:fb:bf	7	-78	WPA	
TELEFONICA	57:26:21:44:a6:89	8	-76	WPA	
TERRA	11:85:e5:74:0c:53	9	-80	WPA	
WANADOO	b4:07:32:41:a6:1c	10	-82	WPA	

**Figure 96.**

- **SSID (Service Set ID):** Access Point Name.
- **BSS (Basic Service Set ID):** MAC of Access Point.
- **CH:** Central Channel of Access Point.
- **RSSI:** Power (in dBm) of AP received. This power is measured by the USB WiFi adapter.
- **Security:** Type of security to access the AP.
- **Device:** Name of device's manufacturer that provides infrastructure. Not always available.

#### **How to scroll on the screen:**

Joystick Up / Down: It changes Access Point.

► **Access point report**

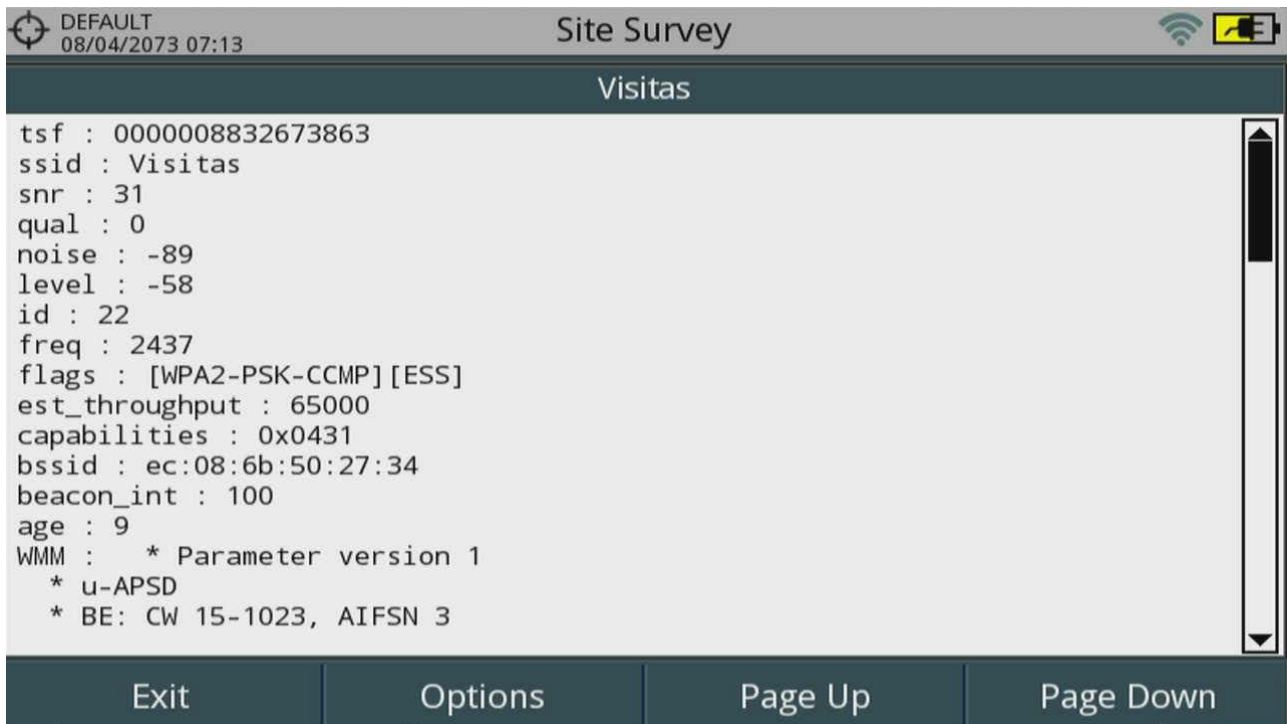

**Figure 97.**

**How to scroll on the screen:**

Joystick Up / Down: It scrolls along the report.

### 5.5.3 Menu Options

► From the Site Survey screen:

**Advanced Menu (F4)**

View all parameters: It shows a detailed report about the access point selected.

► From the Access Point Report screen:

**Exit (F1):** Returns to the previous screen.

**Options (F2)**

Copy to USB: If you insert a USB memory into a USB port you can copy the Access point report.

**Page Up / Page Down (F3 / F4):** It scrolls through the report.



## 6 IPTV



### 6.1 Introduction

IPTV stands for TV over IP networks. It actually means TV over any type of IP packet based distribution network. They can be referred to as LAN (Local Area Network), ethernet, computer networks, etc.. With the growth of LAN based TV distribution systems, having an IPTV input in your field strength meter becomes a handy feature.

The equipment allows you to receive television programmes coming from IPTV networks. Those programmes can be displayed on the screen together with other important service information.

Although some concepts are similar, signal quality assessment metrics is not the same in IPTV as it is in digital TV over RF. The equipment offers you the measurements you need to understand, identify and correct the new problems that can be found in this new type of television distribution networks.

### 6.2 Operation

- 1 Connect the IPTV input/output signal to the equipment through the Ethernet connector.
- 2 In the "Settings"  menu, in the option "Signal source" select IPTV. The IPTV icon  will appear at the screen corner.
- 3 Press the  **Multicast** key. Set the server IP address and server port. The equipment automatically detects if it is UDP or RTP protocol (for more details see next).
- 4 Now the signal should appear on screen.
- 5 Access the **MEASUREMENT, SPECTRUM ANALYZER** or **TV** mode by pressing the corresponding key to view measurement data and image. Press again to display the next view.

6.3 Screen Description

6.3.1 Measurement mode

IPTV views in MEASUREMENT mode are:

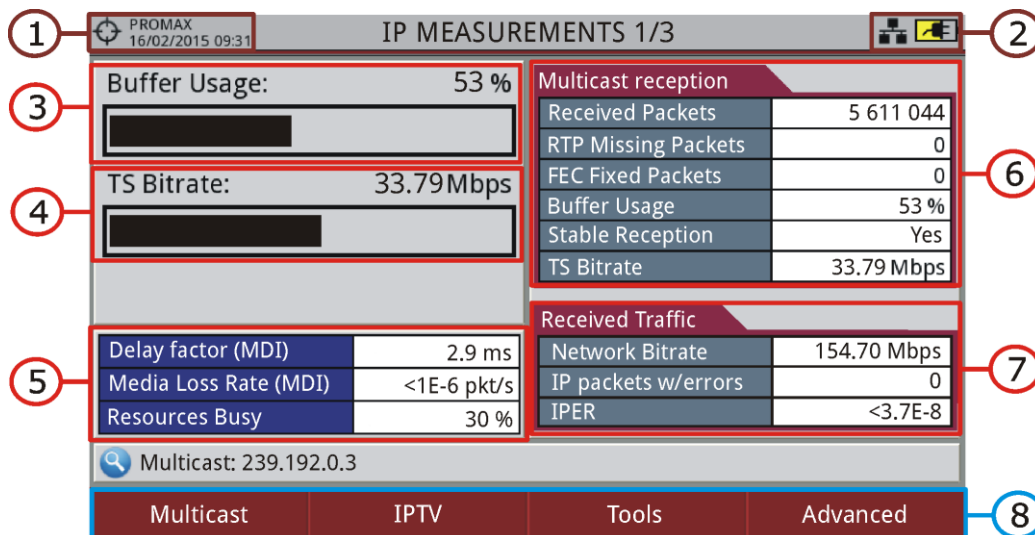
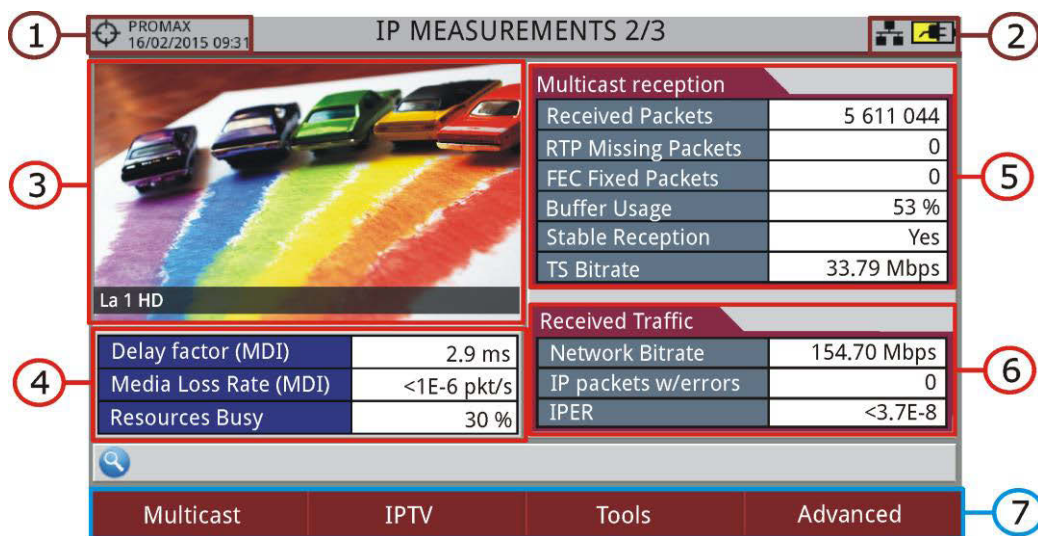

Figure 98. IP MEASUREMENTS 1/3.

- 1 Selected installation; date and time.
- 2 IPTV mode enabled; battery level.
- 3 Graphic bar "Buffer Usage" showing the internal multicast stream buffer usage.
- 4 Graphic bar "TS Bitrate" showing the recovered TS bitrate.
- 5 Measurements on the data network:
  - **Delay Factor (MDI - Media Delivered Index):** Maximum time that one multicast packet stream is within the receiving buffer of the equipment (measurement done over the last second of data received) (recommended value < 100 ms).
  - **Media Loss Rate (MDI):** Ratio of lost packets to received packets in one multicast stream (only for RTP protocol after FEC) (recommended value < 0.005 pkt/s).
  - **Resources Busy:** Resources busy shows the “%” of equipment resources used for handling current IP traffic. Arriving at 100%, means the receiver can’t handle all packets related to data and IP protocols other than Multicast stream. In that situation, data loss may happen.

- 6 Measurement on the multicast reception: received packets, RTP missing packets, FEC fixed packets, buffer usage, stable reception and TS bitrate (if TS input has many variations in packet reception a stable packet rate cannot be established).
- 7 Measurements over all traffic data in the network: network bitrate, IP packets with errors and IPER (IP Packet Error Ratio; ratio of Ethernet packets with errors to Ethernet packets received).
- 8 Softkey menus (see next "Settings" chapter for more details).



**Figure 99.** IP MEASUREMENTS 2/3.

- 1 Selected installation; date and time.
- 2 IPTV mode enabled; battery level.
- 3 Image of the tuned signal.
- 4 Measurements on the data network: Delay Factor, Media Loss Rate and Resources busy (see previous section for more details).
- 5 Measurement on the multicast reception: received packets, RTP missing packets, FEC fixed packets, buffer usage, stable reception and TS bitrate (if TS input has many variations in packet reception a stable packet rate cannot be established).
- 6 Measurements over all traffic data in the network: network bitrate, IP packets with errors and IPER (IP Packet Error Ratio; ratio of Ethernet packets with errors to Ethernet packets received).
- 7 Softkey menus (see next "Settings" chapter for more details).

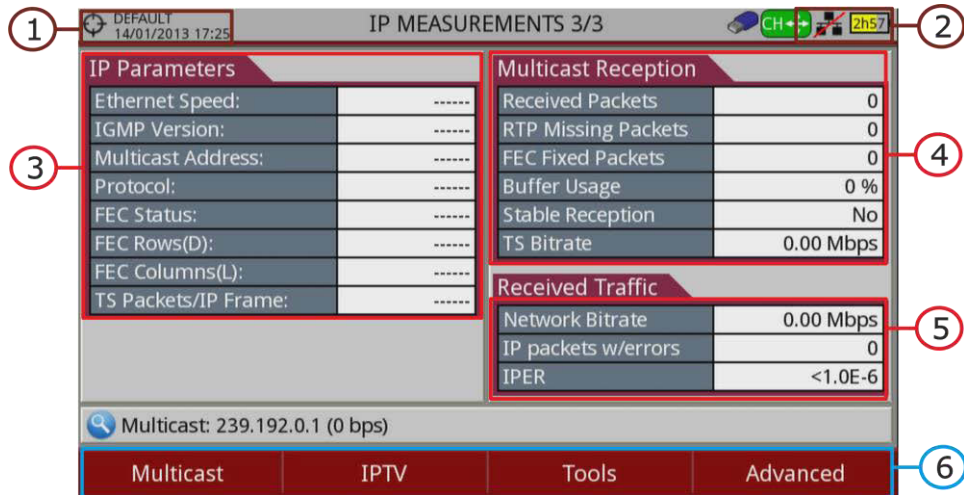

**Figure 100.** IP MEASUREMENTS 3/3.

- 1 Selected installation; date and time.
- 2 IPTV mode enabled; battery level.
- 3 Internet parameters:  
Ethernet speed, IGMP protocol version, multicast server address, detected communication protocol (UDP/RTP), forward error correction (FEC) status, FEC rows, FEC columns and TS packets / IP frame.
- 4 Measurement on the multicast reception: received packets, RTP missing packets, FEC fixed packets, buffer usage, TS locked/unlocked and TS bitrate.
- 5 Measurements over all traffic data in the network: network bitrate, IP packets with errors and IPER (IP Packet Error Ratio; ratio of Ethernet packets with errors to Ethernet packets received).
- 6 Softkey menus (see next "Settings" chapter for more details).



### 6.3.2 Interarrival Packet Time / Packet Rate Over Time

IPTV view in **Spectrum Analyzer** mode shows the "Interarrival packet time" or "Packet Rate Over Time" screen. To change between these two options press **F3**: **Tools** and select on **IPTV Graph** submenu.

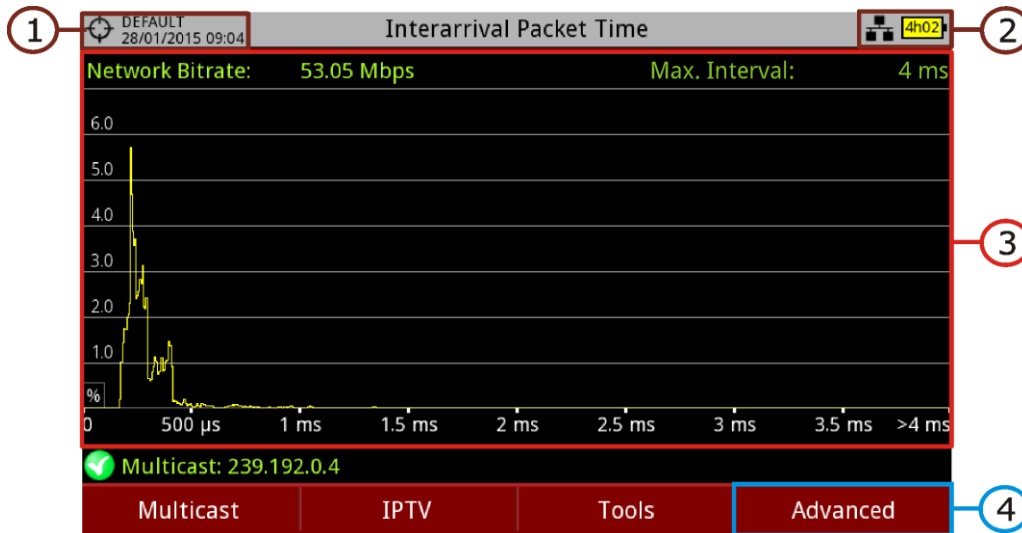

**Figure 101.** Interarrival packet time.



**Figure 102.** Packet rate over time.

- 1 Selected installation; date and time.
- 2 IPTV mode enabled; battery level.

- 3 **Interarrival packet time:** It shows the IP packet percentage as a function of time between packets. Its purpose is check for reception packet continuity, for the selected stream. Usually, the graph should concentrate around small time values. Spreading through the time axis may point to a network problem. Maximum interval measure shows the maximum time detected between consecutive IP packets.

**Packet Rate Over Time:** This graph shows the number of IP packets being received from the current streaming over time.

4 **Advanced**

For **Interarrival Packet Time** allows to change span (4, 8, 40, 200, 400 and 1920 ms) or restart analysis.

For **Packet Rate Over Time** allows change resolution (1, 5, 10, 50, 200 and 1000 ms) or restart analysis.

### 6.3.3 TV mode

IPTV views in TV mode are:

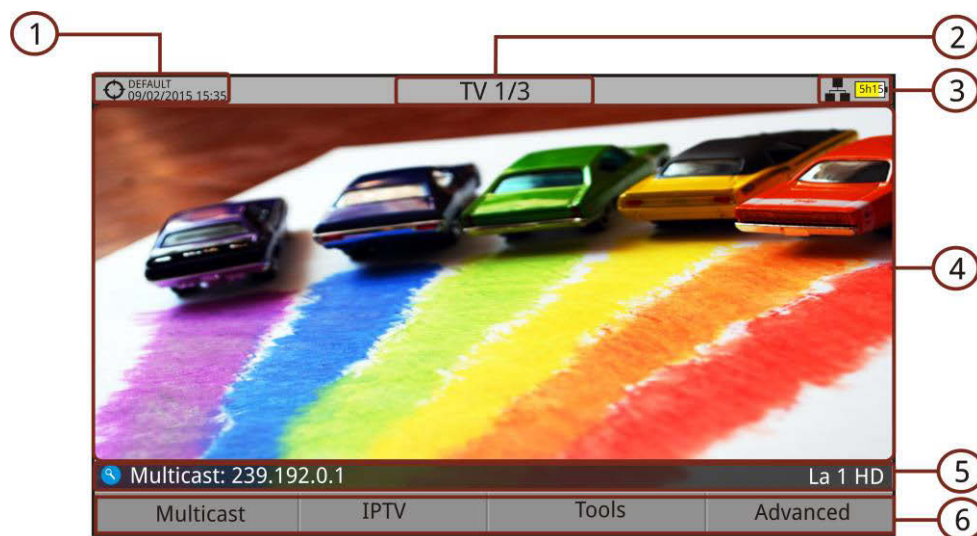

**Figure 103.** IP TV 1/3.

- 1 Selected installation; date and time.
- 2 Number of view/total views.
- 3 Selected band, battery level.
- 4 Tuned service image.
- 5 Multicast IP address and name of the selected service.
- 6 Softkeys menus.



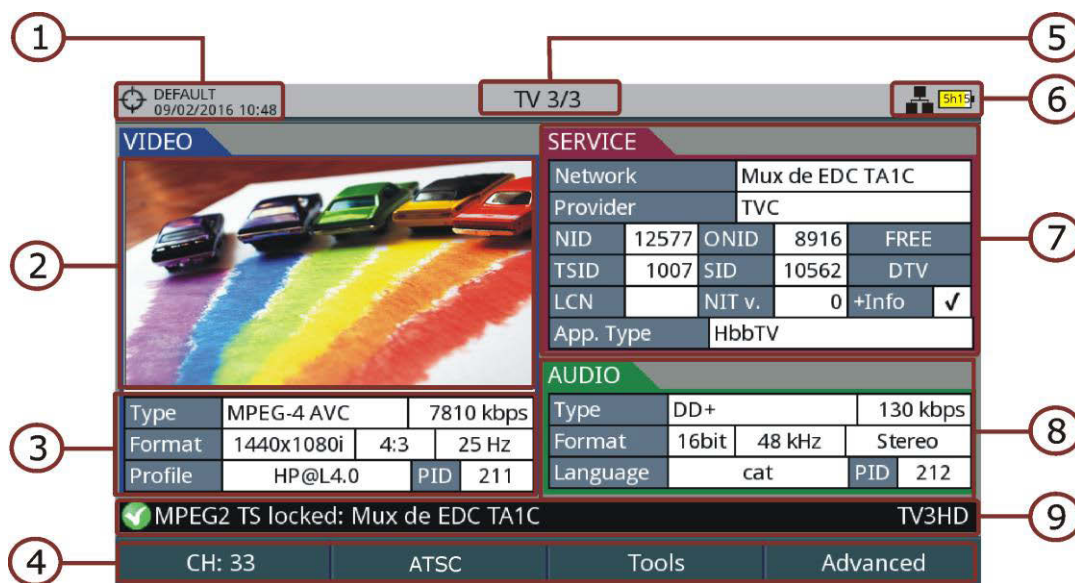

Figure 104. IP TV 3/3.

- 1 Selected installation; date and time.
- 2 Tuned service image.
- 3 Tuned service information.
  - ▶ **TYPE:** Encoding type and video transmission rate.
  - ▶ **FORMAT:** Resolution (horizontal x vertical), aspect ratio and frequency.
  - ▶ **PROFILE:** Profile level.
  - ▶ **PID:** Video program identifier.
- 4 Softkeys menu.
- 5 Number of view/total views.
- 6 Selected band; battery level.
- 7 Tuned service information.
  - ▶ **NETWORK:** Television distribution network (Terrestrial). Orbital position (Satellite).
  - ▶ **PROVIDER:** Program provider name.
  - ▶ **NID:** Network identifier where the signal is distributed.
  - ▶ **ONID:** Identifier of the original network where the signal originates.
  - ▶ **TSID:** Transport stream identifier.
  - ▶ **SID:** Service Identifier.
  - ▶ **App. Type:** Type of detected interactive service such as HbbTV, MHP and MHEG-5. It also shows the URL related to the interactive service.
  - ▶ **LCN:** Logic Channel Number. It is the first logic number assigned to the first channel in the receiver.
  - ▶ **NIT v.:** Network Information Table version.
  - ▶ **+Info:** Additional service information.



- ▶ **FREE/SCRAMBLED:** Free/scrambled transmission.
  - ▶ **DTV/DS:** Standard type of transmission.
- 8 Tuned audio information.
- ▶ **TYPE:** Type of audio encoding and transmission speed
  - ▶ **FORMAT:** Service audio format. Bit depth; sampling frequency; sound reproduction.
  - ▶ **LANGUAGE:** Broadcasting language.
  - ▶ **PID:** ID of the audio program.
- 9 Multicast IP address and name of the selected service.

## 6.4 Tools

Press **F3**: **Tools** to access the tools in the IPTV mode. The **IP Ethernet Frame Viewer**, **PING** and **View IP Network log** are the specific tools for IPTV. The other tools (TS Analyzer, TS Recording, Task Planner) are generic and its operation can be found in the "Tools" chapter.

### 6.4.1 PING / TRACE

The PING tool is a diagnostic tool about the network. To use it follow these steps:

- 1 Set parameters for the PING/TRACE test. Press on **F4**: **Advanced**. Options are:
  - **Mode:** Select between PING (it confirms if a given unit can get any response from another machine in the same network), TRACE (it shows all IP servers between the meter and the IP address measuring transit delays of packets across the network) or Avg Packet Delay / IPDV (it shows delay between two points in the network and changes in this delay).
  - **Pings for each IP** (only for PING tool): Number of times to repeat the ping test. If "Forever" is selected, it can be stopped with "Cancel" or "Exit".
  - **Ping range** (only for PING tool): Range of addresses to apply the ping test. It adds the number selected to the original IP address.
- 2 Click on IP Address and enter the IP address of the remote machine you want to check its communication. It works for both local network or external network.
- 3 Press **F2**: Start.
- 4 The equipment starts sending data packets to the IP address of the remote machine.

- 5 If it gets response, on screen appears the message "Reply from" with the response IP address, number of bytes received, time of response, TTL (time-to-live) or average IPTD (average IP Packet Transfer Delay) and IPDV (IP Packet Delay Variation).

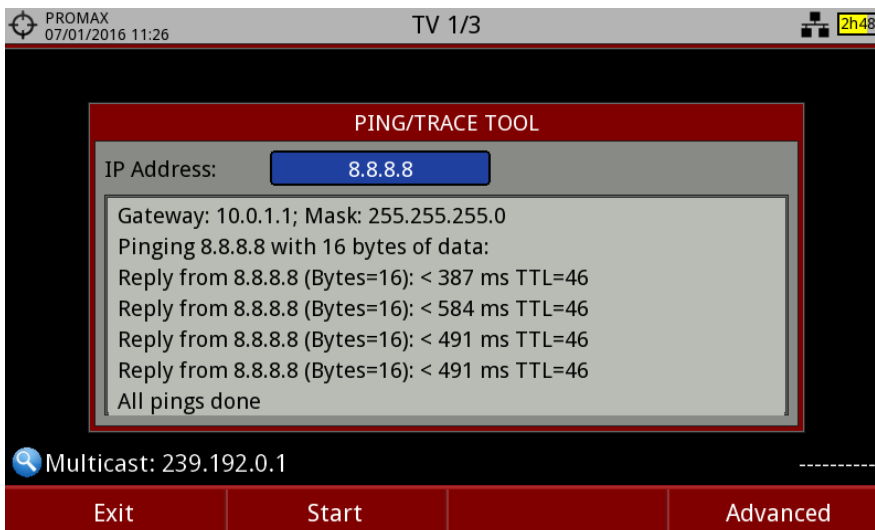

Figure 105.

- 6 To exit the tool press **F1**: **Exit**.

### 6.4.2 View IP Network Log

This function shows a log with network events about protocols IGMP, PING, ARP, DHCP and also Ethernet link detection. Data shown is date, hour and a description.

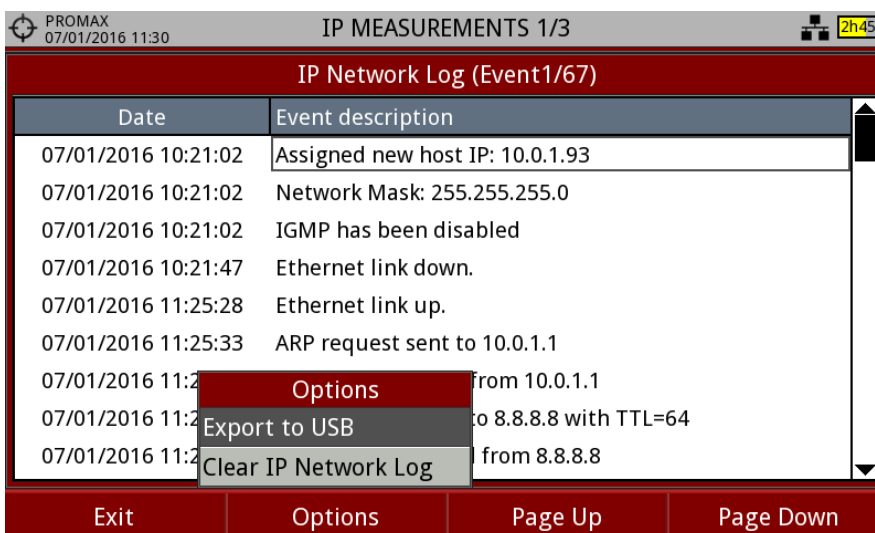

Figure 106.

Pressing on **F2**: **Options** the log can be exported to an USB flash memory or be cleared.

### 6.4.3 IP Ethernet Frame Viewer

This function only works for **Multicast streaming**.

When user presses on F2: **Capture** the system captures an Ethernet packet that belongs to the multicast stream been received. Information of this packet is shown as a tree that can be deployed to show header data of each protocol available (Ethernet, IPv4, UDP and RTP).

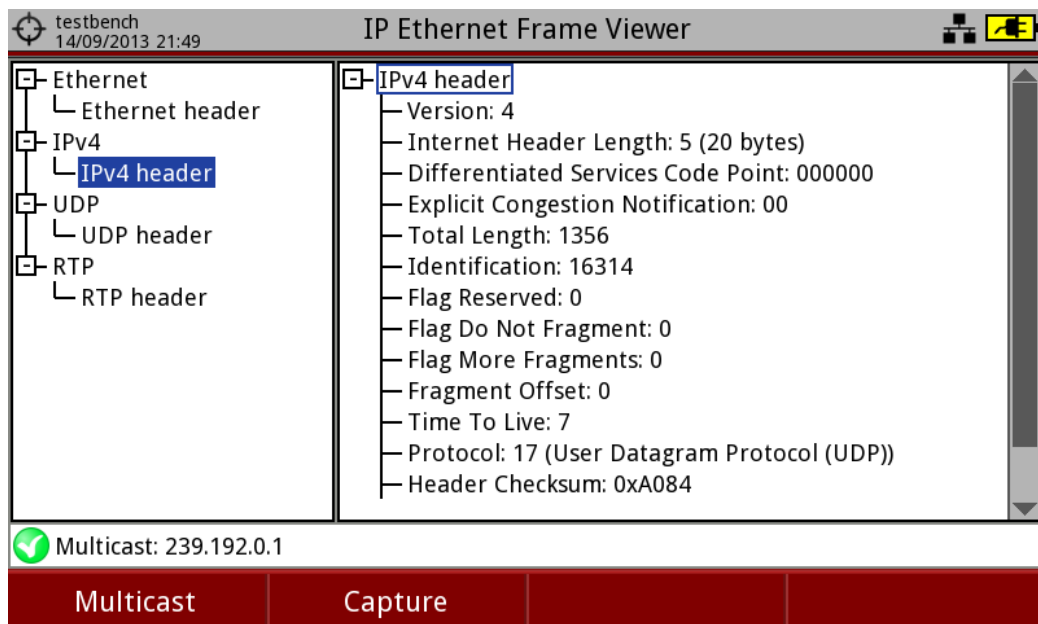

**Figure 107.**

Pressing on : Multicast allows user to change multicast address.

Pressing on : Capture allows user to capture a new packet in the multicast stream.

## 6.5 Settings

### 6.5.1 Multicast Settings

The IPTV tuning options are on the : **Multicast** key. These options are available to receive a multicast signal. Multicast is an open broadcasting over IP in which the device only takes data packets with a specific address.

For multicast distribution, options are:

- **Multicast Address:** Multicast address at which the equipment is subscribed to receive a multicast transmission.
- **UDP Port:** It allows the user to select the port when working with UDP protocol.



- **Recent Multicast Addresses:** It shows a list of multicast addresses recently used.
- **Discovered Multicast Addresses:** It discovers and shows all multicast streams into the network. It shows a complete list including IP addresses and bitrates for each stream.
- **IGMPv3 Server Sources:** Multicast IP servers validated by the user to receive multicast streams (only for IGMPv3 protocol; select IGMP version protocol in "Preferences").

### 6.5.2 IPTV parameters and reset measures

Pressing on the : **IPTV** key it displays a list of IP Parameters: ethernet speed, IGMP version, multicast address, protocol, FEC status and TS packets/IP frame.

Pressing on : **Advanced** there is an option to reset measured values.

### 6.5.3 General Settings and Preferences

#### ► Preferences

To access **Preferences** press the  key for 1 second. Go to the **Network** options tab to fill out the network options to identify the equipment into a data network. This is necessary to receive IPTV signal.

Network parameters are:

- **MAC:** Physical address of the equipment. It is unique and cannot be edited.
- **DHCP:** Enable this option to get the proper IP address when the unit is first connected to a network. That feature contributes to make things easier to installers when debugging network access. Enable the DHCP protocol for proper IP configuration.
- **IP Address:** IP Address of the equipment into the local network.
- **Mask:** Subnet mask of the equipment (by default 255.255.255.0).
- **Gateway:** It allows the meter to get out from the local network when using PING or TRACE (if the network does not have gateway, use 0.0.0.0).
- **IGMP Version:**  
 Protocol for multicast transmissions used by the router. Available versions are 1, 2 and 3. To disable select Off.
  - **IGMPv1:** IGMP version 1. Each time user selects a multicast address, meter asks for the new multicast stream.



- **IGMPv2:** IGMP version 2. Each time user selects a multicast address, meter stops receiving the current stream and asks for receiving the new one.
- **IGMPv3:** IGMP version 3. Each time user selects a multicast address, meter stops receiving the current stream and asks for receiving the new one, from the servers approved by the user.
- **Off:** Meter does not send any IGMP messages and discards the received ones.

#### ► General Settings

The IPTV settings when pressing the settings  key are:

- **Signal Source:** It allows the user to select the signal coming into the equipment between the RF input for RF signal and the IPTV input. In this case select IPTV.
- **Decoder TS Input:** It allows the user to select the transport stream coming into the equipment. In this case select IPTV. If you want to save the transport stream received by the IPTV, select the IPTV input.
- **ASI Output:** It allows the user to select the way out for TS-ASI packets. User can select among Off, IPTV and ASI Input. This transport stream received by the equipment can feed the signal to other devices as well. In the case of IPTV option the TS-ASI packets go out through the IPTV connector. If you want to send to the output the transport stream from the IPTV signal, select IPTV.





## 7 INSTALLATIONS MANAGEMENT

### 7.1 Description

The Installations Management is a program embedded in the equipment that allows the user to easily create a file (installation) to individually store and manage data for each installation. Measurements, channel plans, screenshots and any other data associated with the installation will be stored in the folder corresponding to that installation. These measures can then be displayed and downloaded to a PC.

If the user does not create any file installation, the equipment stores measurements in the installation file that is preinstalled by default (named "DEFAULT").

### 7.2 Operation

- 1 To access the Installations menu press the  key.
- 2 It shows up a window with a list of all available installations. On the softkeys appears the options to manage these installations.
- 3 To exit the list of installations press the key .

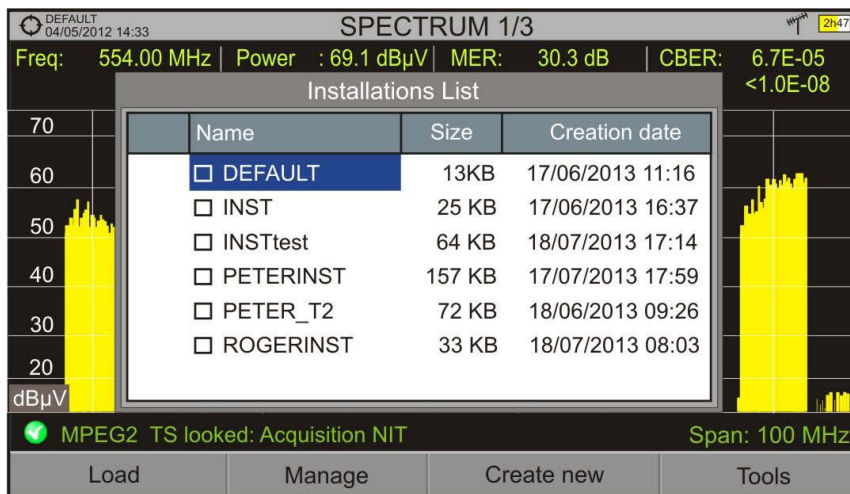

Figure 108.



There are the following options:

- **Load** F1: It loads the selected installation. To select a installation from the list, place the cursor on the installation and press the joystick, then press "Load" F1 to load it. Once loaded, the name of the installation appears on the upper left corner of the screen, accompanied by the symbol , that means that is the current installation. All measurements, screenshots, channel plans and other data since this moment will be stored in the current installation.
- **Manage** F2: It opens a window that displays all data of the current installation and from where they can be edited, changed or view (more details in "Installation Management" section).
- **Create new** F3: It creates a new installation with the data introduced by the user (more details in "New installation" section).
- **Tools** F4: It shows up a menu with some tools to use with the installations (see "Tools" section).

### 7.3 Installation Management

In the list of installations, press on the option **Manage** F2 to access to the **Installation manager** screen:

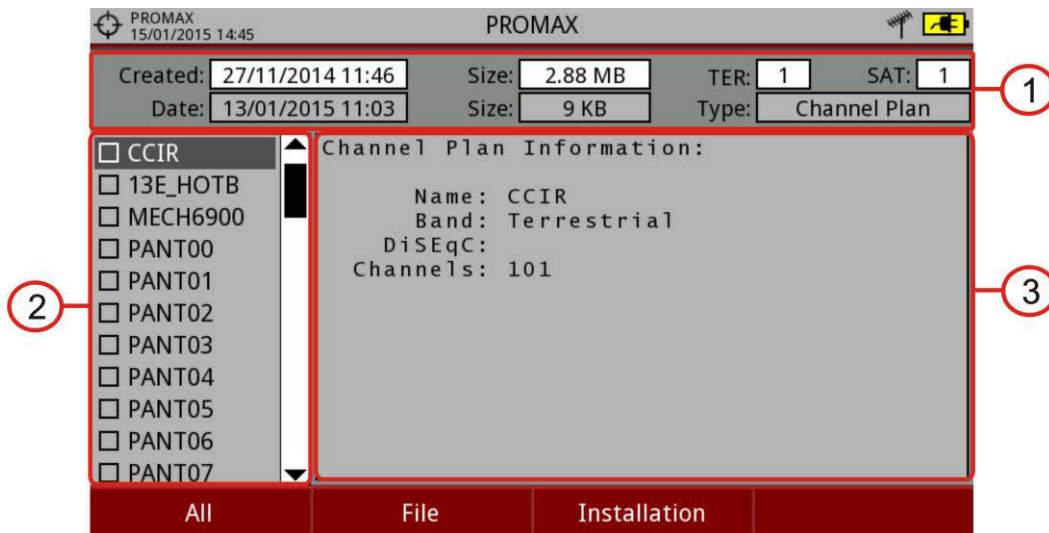

Figure 109.

The DEFAULT installation is the installation preinstalled on the equipment. It is like any other installation and it can load channel plans, DiSEqC programs, etc. The DEFAULT installation can not be deleted or renamed.





The window is divided into three areas:

### 1 General data

- The first line shows general information about the installation. The second line shows information about the selected file. Data fields are:
  - ▶ **Created:**  
Date and time the current installation was created.
  - ▶ **Size:**  
Data size of the current installation.
  - ▶ **TER:**  
It shows the number of terrestrial channel plans in the installation.
  - ▶ **SAT:**  
It displays the number of satellite channel plans in the installation.
  - ▶ **Date:**  
Date and time when the selected file was created.
  - ▶ **Size:**  
Data size of the selected file.
  - ▶ **Type:**  
Data type of the selected file.

### 2 List of files area

It shows all types of data files in the selected installation. These can be: screenshots, channel plans, dataloggers, DiSeqC commands, data captures, signal monitoring, service databases and antennas.

To move along this file list move the joystick up or down.

Any of these files can be selected or deselected by pressing the joystick.

### 3 Display area

It is the area where data file description is displayed. The file data is displayed only if the cursor is placed for a moment on the file name.

For a screenshot, it displays a thumbnail of the full screen, as captured.

In the remaining cases, it only shows some data description of the file type.

If there is any extra option associated with the file, it will appear on the  key.



## ► Menu options

The installation manager menu has four options linked with the softkeys. They are described below:



### Filter by type

It shows all available file types in the current installation and the amount of them between brackets. User can filter by file type. The selected file type will be the only one available in the list of files. Available file types are: screenshots, channel plans, dataloggers, DiSeqC commands, data captures, signal monitoring, service databases and antennas (or all).



### File

#### ► Mark All:

It marks all files on the list of files area.

#### ► Unmark All:

It deselects all files on the list of files area.

#### ► Delete:

It deletes all selected files on the list of files area.

#### ► Copy to USB:

It saves selected files on the list of files area to an USB stick connected to the equipment.

If the name of the file to be copied is greater than 8 characters the system cuts it. If the file name is cut and matches with another one, then it is added a number to the name to make them different. For instance, 2 files with similar names, like FILENAME01 and FILENAME02 both files will be correctly copied with names FILENA~1 and FILENA~2.

To keep the file names with more than 8 characters it is recommended to export the complete installation using the "Export to USB" option (see "Tools" section).

The Datalogger files copied to the USB cannot be used to generate reports by the NetUpdate program. To do this the datalogger files must be exported directly through the NetUpdate program (see the NetUpdate user's manual for details).



## Installation

### ► **Add Channel Plan:**

It opens a window to add a channel plan, terrestrial or satellite and band (for optical option), to the current installation.

### ► **Add Antenna:**

It allows the user to add an specific antenna among the ones available. To import an antenna refer to "Field Strength" section in chapter "Tools".

### ► **Add DiSEqC Program:**

It allows the user to select and add to the current installation any DiSEqC program available in the equipment.



## Options

This options appears if there is any extra option associated with the file type.

### ► **See full screen:**

This option only appears if user selects an image in the list of files. It displays the selected image full screen.

### ► **Diseqc program:**

This option only appears if a satellite channel plan is selected in the list of files area. It allows the user to add a Diseqc program to the selected satellite channel plan from the list of diseqc programs available for the current installation.

### ► **Open file**

This options appears if the file type selected is datalogger, data capture or signal monitoring. In case of data capture (if the capture was done in the Spectrum Analyzer mode) shows the spectrum reference. In case of signal monitoring it opens the signal monitoring viewer.

To get out from the Installation manager press any key to access MEASUREMENT, SPECTRUM or TV mode.



[Click here to watch this video: Installation manager](#)

## 7.4 New installation

In the list of installations, when selecting the option **Create New**  it runs the installation wizard that helps to create a new installation:

- 1 During the process, the user has the option to edit the default name assigned or import data from another installation.
- 2 The user can select the channel plans (terrestrial and satellite) that will be used in that installation. At least one for each band has to be selected.
- 3 For satellite channel plans the user can select the Diseqc commands associated to the installation and also the satellite band (Ku-Ka or C band) and the frequencies of the LNB Oscillator.
- 4 During the creation process the softkeys function are: Next (it goes to the next step), Previous (it goes to the previous step) or Cancel (it cancels the process).
- 5 When finish, the new installation created will be the current installation.

## 7.5 Tools

In the list of installations, when pressing the **Tools**  option it shows a menu with some options to edit the installation files:

- ▶ **Mark All:**  
It selects all installations in the list of installations.
- ▶ **Unmark All:**  
It deselects all installations in the list of installations.
- ▶ **Archive:**  
It compresses (using the ZIP algorithm) the selected installations to save more space. A zipped installation shows a box icon  at the left side in the list of installations. A zipped installation can be loaded as anyone else, but the load time can be slightly higher because previously it is unzipped automatically. Once the installation is unzipped the user must re-zip it if necessary. To transfer an installation file from the equipment to a PC, it must have been previously zipped.
- ▶ **Delete:**  
It deletes the selected installations and all the files associated to them. The DEFAULT installation cannot be deleted.



- ▶ **Rename:**  
It edits the name of the installation selected in the list of installations. The installation by default DEFAULT cannot be renamed.
- ▶ **Export to USB:**  
It saves the installations files selected in the list of installations to an USB stick connected to the instrument. The installation file is exported in zip format.
- ▶ **Import from USB:**  
It imports installation files from a USB stick connected to the equipment. It has to use the same folder structure that is generated when exporting to USB.
- ▶ **Installed Antennas:**  
It allows user to remove antennas files on the meter.



## 7.6 Importing Data from USB

The data import tool allows the user to import data files in a simple way from an USB flash drive to the equipment.

Data available to be imported are:

- **Installations.**
- **Channel Plans.**
- **Antennas.**

### ▶ **Operation:**

- 1 Copy the file to be imported on a flash drive and plug it into the mini-USB port using the supplied cable. The file must be in the proper format so the system can recognize it.
- 2 Press the **Installation Management** key .
- 3 Press the  key "**Tools**".
- 4 Select the "**Import from USB**" option.
- 5 The Import Files window appears. Select the file and press the  key: "**Import**".

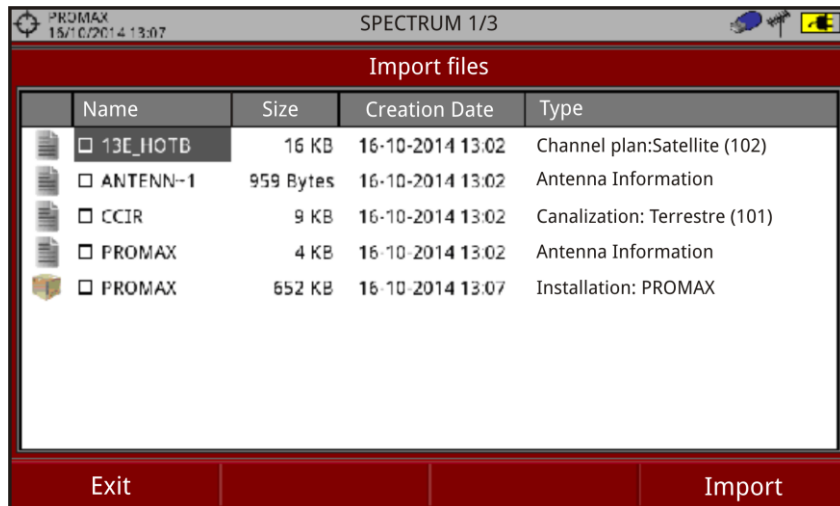

**Figure 110.**

- 6 If the file import is successful then a window shows a confirmation message.



## 8 CONNECTING TO EXTERNAL DEVICES

The **RANGER Neo** can interact with external devices, sharing information through its interfaces. Connection types are:

- 1 Input/output data from / to PCo via Ethernet connector
- 2 Input/output data interface via USB connector for USB WiFi adapter or USB flash drive.
- 3 Video/Audio digital output interface via **HDMI** connector output.
- 4 Video/Audio analogue input interface via **V/A** connector input.
- 5 DiSEqC, SCD/EN50494 standard (also known as SatCR) and SCD2/EN50607 standard (also known as JESS). interface via **RF** connector.
- 6 CAM modules input via Common Interface slot. TS-ASI Input/Output via F connector.
- 7 TS-ASI Input/Output via F connector.





Next is described each of these interfaces and their interaction with external devices.

### 8.1 **USB connector**



#### 8.1.1 **Connecting a USB flash drive**

This connection allows the user to copy files (screenshots, channel plans, dataloggers, DiSEqC commands and others) and export/import installations from the equipment to the USB and vice versa.

► **To copy some select data from the installation:**

- 1 Connect the USB stick to the USB equipment port.
- 2 USB icon should appear on the top right corner of the equipment. This icon indicates that an USB stick has been detected at the port.
- 3 Press the Installations key  and select check the installation to download some of its data.
- 4 Press the key : Manage to access the data of the selected installation.
- 5 Press : Filter by type to select the type of list to view (list of all the files, only screenshots, only channel plans, only dataloggers or only DiSEqC commands).
- 6 Select the files from the list to be copied on the USB memory stick, by pressing the joystick or by pressing : File and selecting "Mark All" (it selects all files on the list displayed).



- 7 Once files are selected press : File and select the "Copy to USB" option. This option is enabled only if it detects that there is an USB connected to the equipment and if any file has been selected.
  - 8 It shows a progress bar and a message informing that files are being copied to the USB.
  - 9 When finish you can remove the cable with the USB stick memory directly from the equipment and connect it to a computer to view the files copied.
  - 10 Default files are copied to the root directory of the USB memory. Screenshots appear with PNG extension and data with XML extension.
- **To export one or more complete installations:**
- 1 Connect the USB stick to the USB equipment port.
  - 2 USB icon should appear on the top right corner of the equipment. This icon indicates that an USB stick has been detected at the port.
  - 3 Press the Installations key and check the installations to export.
  - 4 Press the key : Tools and select Export to USB.
  - 5 A progress bar and a message indicates that the files are being copied to the USB. The files are copied to the root directory of the USB in ZIP format.
  - 6 When finished, the cable can be extracted directly with the USB stick and connect it to a computer to display the copied files.
  - 7 Unzip the installation file to access the data.
- **To import one installation:**
- 1 Connect the USB stick to the USB equipment port.
  - 2 USB icon should appear on the top right corner of the equipment. This icon indicates that an USB stick has been detected at the port.
  - 3 Press the Installations key and check the installation to export.
  - 4 Press de key : Tools and select Import from USB.
  - 5 A dropdown menu shows the installations identified in the USB memory. An installation can be imported if it has the same folder structure than when exporting. Select the installation to import from those available.
  - 6 The import process starts. If the name of the installation matches with an existing one, it gives a warning before import.





### 8.1.2 **Connecting a WiFi USB adapter**

This connection is necessary for the use of the equipment as a WiFi meter. Once it is connected to one of the two USB ports, a configuration window will pop up to set parameters to connect to the WiFi network (see section "WiFi Signal Tuning" for more details).

## 8.2 **Connecting to a computer via Ethernet**

### ► **Description**

This connection allows the communication between the equipment and a computer via an Ethernet cable or using the program NetUpdate of PROMAX.

NetUpdate program can be downloaded for free from the PROMAX website.

It has the following functions:

- Update the main firmware of the equipment.
- Open/Receive/Save/Print data files captured with the Datalogger function.
- Transmit/Receive/Edit/Save channel plans.
- Create/Edit channel plans.

Connect the equipment to your computer using the Ethernet cable

For more information about the NetUpdate program, see the user's manual, which is available on the PROMAX website.



[Click here to watch this video: Generating a measurement report](#)



[Click here to watch this video: Creation of a channel plan](#)

### ► **Operation**

- 1 From the PC that you are going to use to connect to the meter, find out and write down connection data at the local Ethernet network. For more details read the following section "Find out local network connection data".
- 2 Access the "Preferences" options in the meter by pressing the "Installations" key  for 1 second
- 3 Go to the "Network" tab where network setting parameters are.



- 4 In the "IP Address" box enter the IP for the meter. You have to use an IP in the same range as the IP of your PC (which we obtained in step 1). For example if the IP of your PC is 10.0.1.3, the meter should have the same IP except for the last number, for example 10.0.1.8.
- 5 In the "Mask" box, enter the mask value to match the one we obtained in step 1 (usually 255.255.255.0).
- 6 In case you want to connect to the meter from an external network, fill in the "Gateway" box (obtained in step 1).
- 7 In case you connect the meter to a network with a DHCP server, you can set the DHCP box to ON and the server will automatically assign the IP address.
- 8 Click on the "Save" option and then "Exit" to save changes.
- 9 Install the NetUpdate program on the PC. All permissions requested during the installation must be approved for a correct operation of the program.
- 10 Using an Ethernet cable, connect the meter's IPCTRL port to the PC's network port.
- 11 Open the NetUpdate program. In the "Select Port" box select the "Ethernet" option and press "Detect".
- 12 A window will appear where you must enter the same IP that you have set in the meter (in our example it would be 10.0.1.8) and then press OK.
- 13 If connection is successful, a confirmation window will appear and you will be able to see the meter data in the main NetUpdate window (for details about NetUpdate program, download the manual from the PROMAX website.)

#### ► Find out local network data

- 1 To find out connection data of your PC to the local Ethernet network, click on the Windows Start menu. In the search box type CMD and press Enter.
- 2 The Windows command line will open. Type IPCONFIG and press enter.
- 3 A window with several lines of information will appear. Refer to the "IPv4 Address" line in "Ethernet Adapter Local Area Connection" section. That is the local IP of your PC. Write down the IP. Also write down the "Subnet Mask" and "Default Gateway" data. This data will be necessary to connect with the meter.



### 8.3 Digital V/A Output via HDMI connector

HDMI (High-Definition Multimedia Interface) is a compact audio/video interface for transmitting uncompressed digital data. HDMI supports, on a single cable, any TV or PC video format, including standard, enhanced, and high-definition video; up to 8 channels of digital audio; and a Consumer Electronics Control (CEC) connection. The CEC allows HDMI devices to control each other when necessary and allows the user to operate multiple devices with one remote control handset.



This connection allows the equipment to interface with other High Definition equipment. It can also be very useful to check proper operation of the client's TV while on a service call. Everything that can be seen on the meter's screen is available through the HDMI.

This connection allows you to switch between the image from the equipment to an auxiliary monitor by following these steps:

- 1 Connect the HDMI cable to the video/audio output connector (see [Figure 5](#)), ensuring that the plug is fully inserted.
- 2 Connect the opposite end to the auxiliary monitor where video and audio of the equipment will be played.

### 8.4 Analogue V/A Input via jack connector

The V/A input connector allows connecting a video/audio analogue input signal. This connection allows the user to view an image on the equipment screen coming from an external source by following these steps:



- 1 Connect the supplied jack 4V cable to the video/audio input connector (see [Figure 5](#)), ensuring that the plug is fully inserted.
- 2 Connect the opposite end (RCA connector) to the source of video/audio.
- 3 Switch on the equipment and select the terrestrial and analogue signal.
- 4 Select TV mode  and press : Input.
- 5 From the menu, select "External". A message shows that the external input has been selected.
- 6 After a few seconds, the input image will be displayed on screen.
- 7 With the option : Aspect, you can select the aspect ratio of the image, between 4:3 and 16:9.

**NOTE:** If the equipment is displaying an external analogue video, it will not switch to internal video mode anymore when that external video is disconnected or lost.



## 8.5 Connecting to antenna via RF Connector

### 8.5.1 DiSEqC commands

The RF connector allows controlling an antenna using DiSEqC commands. DiSEqC (Digital Satellite Equipment Control) is a communication protocol between the satellite receiver and the installation accessories of satellite (switches, LNBS, etc.) proposed by Eutelsat, in order to standardize the diversity of switching protocols (13 to 18 V, 22 kHz) and meet the needs of the installations for the reception of digital TV.

- 1 Connect the RF cable ([see Figure 6](#)) to the RF connector for the input signal of the equipment.
- 2 Press the **Spectrum** key  to access the spectrum Analyzer mode.
- 3 Press the **Settings** key  and select the satellite band.
- 4 From the **Settings** menu, select the polarization (horizontal/vertical) and the satellite band (high/low).
- 5 If necessary, enable the **Supply output** and select the supply voltage for the LNB.

**NOTE:** When tuning by channel is selected, polarization, satellite band and supply output cannot be changed, because these parameters are determined by the channel plan.

- 6 Select the option **DiSEqC mode**.
- 7 Two new functions appear on the softkeys: Command  and Software . DiSEqC programs appear classified in categories or folders.
- 8 Select the command or program and press the joystick to send it to the antenna. These commands or programs allow the user to control an antenna (for more information about DiSEqC commands and programs see [Annex 3](#)).

### 8.5.2 SCD/EN50494 (SatCR) commands

By means of function SCD/EN50494 (international standard, also known as SatCR) it is possible to control the devices of a TV satellite installation that are compatible with this standard, which allows to concentrate downlink frequencies (slots) by an only cable. By this way each user using a slot can tune and decode any signal present in the satellite.

- 1 Connect the RF cable ([see Figure 6](#)) to the RF connector for the input signal of the equipment.
- 2 Press the **Spectrum** key  to access the Spectrum Analyzer mode.



- 3 Press the **Settings** key  and select the satellite band.
- 4 Select the polarization (horizontal/vertical) and the satellite band (high/low).
- 5 If necessary, enable the **Supply output** and select the supply voltage for the LNB.

**NOTE:** When tuning by channel is selected, polarization, satellite band and supply output cannot be changed, because these parameters are determined by the channel plan.

- 6 In the option SCD/EN50494, select ON to enable it. It appears the  icon at the top right corner.
- 7 Also in the SCD/EN50494 option, select **Configuration** to access SCD/EN50494 parameters.

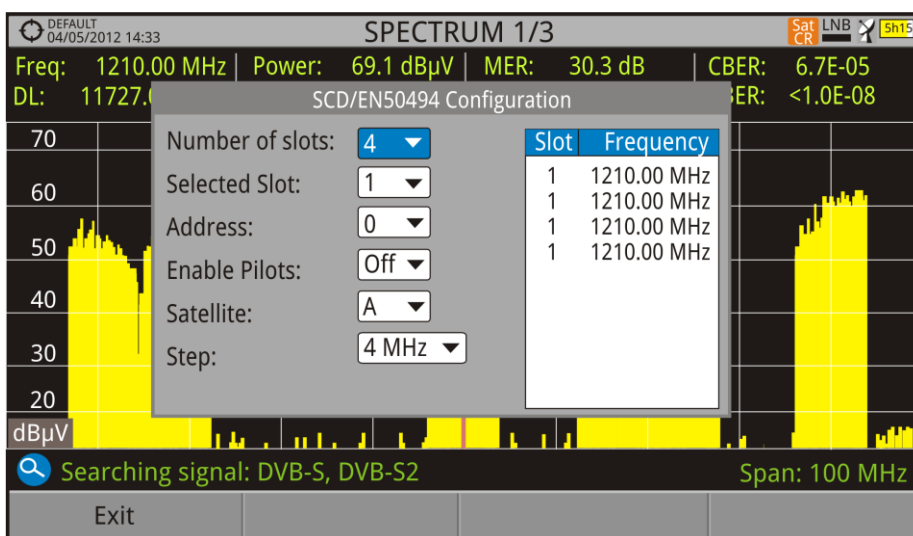

**Figure 111. SCD/EN50494** command screen.

The configuration window shows the options that user can modify: number of slots, slot selected, device address, pilot signal activation (when activating the SatCR device located in the headend, it emits a pilot signal with constant level for each downlink frequency to identify available channels), selected satellite and frequency step. For each type of slot number unit there is a list of independent frequencies to select. The user may have separate frequencies for 2, 4 or 8 slots units and these values are not lost when switching from one type to another.

- 8 Once SCD/EN50494 is configured, the user can select the slot by the "Tuning" key.



**8.5.3 SCD2/EN50607 (JESS) commands**

Through the SCD2/EN50607 (international standard, also known as JESS) function is possible to control the devices of a TV satellite installation that are compatible with this standard. This technology has two main functionalities: one for configuring headends, and another for configuring sockets. This technology requires bidirectional DiSEqC capabilities. Although this equipment do not have such capability, a simpler way to blind configure units has been implemented, without any confirmation other than spectrum reference. For information about JESS technology, developed by JULTEC, refer to its website ( <http://jultec.de/>).

- 1 Connect the RF cable (see Figure 6) to the RF connector for the input signal of the equipment.
- 2 Press the **Spectrum** key to access the spectrum Analyzer mode.
- 3 Press the **Settings** key and select the satellite band. From the Settings menu, select the polarization (horizontal/vertical) and the satellite band (high/low).
- 4 If necessary, enable the **Supply output** and select the supply voltage for the LNB.

**NOTE:** When tuning by channel is selected, polarization, satellite band and supply output cannot be changed, because these parameters are determined by the channel plan.

- 5 In the option **SCD2/EN50607**, select ON to enable it. It appears the JESS icon at the top right corner of the screen.
- 6 Now the **SCD2/EN50607** option shows a new menu. Select **Configuration** to access the configuration parameters. The user can select the power, central frequency, tone beacon and satellite for each band. The user can also select the number of user bands and the available satellites through the option "Configuration" on key F2.

INSTAL55 05/09/2014 12:45		SCD2/EN50607 CONFIGURATION			JESS 13V	Sh08
UB	Power	Central Frequency	Tone Beacon	Satellite		
UB_1	Enabled	1076 MHz	Off	A		
UB_2	Disabled	1178 MHz	Off	A		
UB_3	Disabled	1280 MHz	Off	A		
UB_4	Disabled	1382 MHz	Off	A		
UB_5	Disabled	1484 MHz	Off	A		
UB_6	Disabled	1586 MHz	Off	A		
UB_7	Disabled	1688 MHz	Off	A		
UB_8	Disabled	1790 MHz	Off	A		
Exit		Configuration		Send		

**Figure 112.**

- 7 Also from option **SCD2/EN50607**, select **Socket** to access the configuration of socket. The user can select the user bands that should be enabled for the socket and to send them to configure the socket.

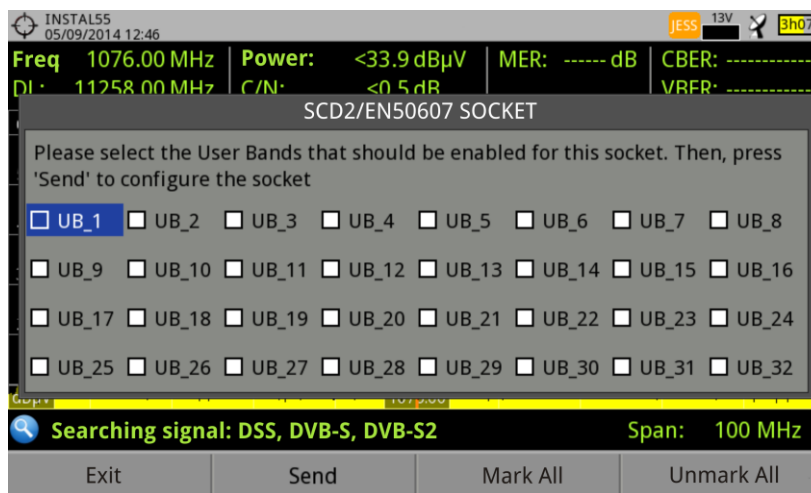

Figure 113.

- 8 Once it is configured, the user, through the **F1** key "Tuning" can select the user band.

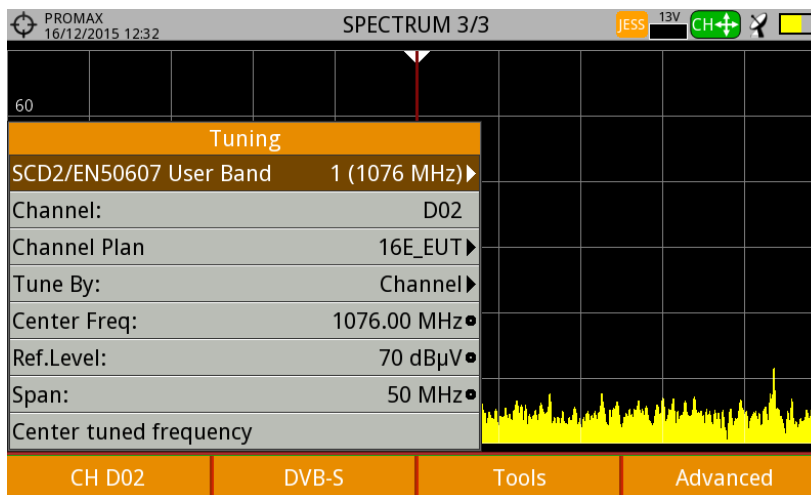

Figure 114.

- 9 User frequency tuned is stored for each User band (UB) and it is restored each time the multiswitch is being configured.

**NOTE:** When not detecting any SCD2 receiver, the function enters in a more basic mode, allowing sending configuration commands even with nothing connected. In that mode, the user can debug cable issues or even SCD2 units problems.

**NOTE:** For special devices that use non-standard commands, it has been added a channel bandwidth for every user band.

## 8.6 Common Interface Slot

This connection enables the conditional access (decryption) for encoded digital TV signals, in agreement with the DVB-CI (Common Interface) recommendation.

This technology supports all those decryption systems for which a valid CAM module exists, according to DVB-CI, with the corresponding subscriber card.

The equipment by means of Common Interface method offers the possibility of supporting various conditional access systems, so that video and/or audio broadcast by encrypted services (scrambled TV for subscribers) may be decoded following the SimulCrypt model. It provides a standard connector to insert CAM modules (Conditional Access Module), which allows a specific management for each codification system.

SimulCrypt is a process that supports various parallel conditional access systems, together with the encryption algorithms specified by DVB-CSA (Common Scrambling Algorithm) to control access to pay-TV services. The SimulCrypt broadcasts Transport Stream contains keys for various conditional accesses, thereby allowing reception by more than one type of decoder.

**NOTE:** The insertion of a CAM module or a SMART-CARD in a wrong position might produce the instrument malfunction and could generate damages to the equipment.

### ► Operation

- 1 Insert the subscriber Smart-Card\* in the CAM module\*.

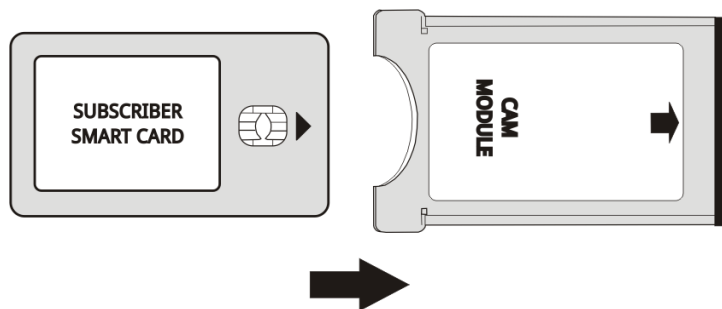

**Figure 115.** Subscriber Smart-Card and CAM module insertion.

- 2 Insert the CAM module in the Common Interface slot of the equipment. The CAM module connector is located on the equipment rear panel. Place the instrument on a stable surface and insert the module so the printed arrow appears on visible upper face, pressing until the extractor mechanism button becomes activated.
- 3 If the equipment detects the CAM module it shows a confirmation message.
- 4 Press the Settings key .
- 5 Select the **Common Interface** option.

\* CAM Module and Smart card are not included



- 6 By means of this option the user can navigate through the CAM module menu. Each time an option is selected, the waiting icon appears, until the module allows accessing the next menu or option.
- 7 To extract an inserted CAM module, press the button from extractor mechanism and remove the module. If the equipment detects the CAM module extraction it shows a confirmation message.

## 8.7 **TS-ASI Input / Output**

It is an asynchronous serial interface. It is the serial standard used for MPEG-2 TS, in multimedia equipment interconnection:

- Synchronous 270 Mbps data flow (up to 218 Mbps payload).
- Differential signal over coax interface.
- It allows intermediate node test in broadcast and distribution infrastructures.

### 8.7.1 **TS-ASI Input**

The TS-ASI option is a key feature. You can monitor and analyze streams coming from satellite receivers, transport stream players, multiplexers, etc... It automatically detects whether the stream is composed of 188 or 204 bytes.

#### ► **Operation**

- 1 Press the **Settings** key  to access the settings.
- 2 Select the **Decoder TS Input** option. It shows up a menu to select the transport stream coming into the equipment between the RF Demodulators, IPTV and the ASI Input.
- 3 The **RF Demodulators** option (this option is available only if RF is selected as a Signal Source) extracts the TS from the RF signal by means of the internal RF demodulator. The RF signal can come from digital terrestrial, satellite or cable.
- 4 The **IPTV** option (this option is available only if IPTV is selected as a Signal Source) extracts the TS from the IPTV signal.
- 5 The **ASI Input** option gets the TS directly through the ASI-TS input connector.

## 8.7.2 TS-ASI Output

It can transmit in packet mode or burst mode. User can use the transport stream received by the equipment to feed the signal to other devices as well through the TS-ASI output.

### ► Operation

- 1 Press the **Settings** key  to access the settings.
- 2 Select the **ASI Output** option. It allows the user to select the signal source for the TS-ASI packets going out through the ASI Output. User can select among Off, IPTV, RF demodulators and ASI Input. By this way, the transport stream can feed another device.
- 3 The **Off** disables the ASI Output. If the **RF Demodulators** option (this option is available only if RF is selected as a Signal Source) is selected, the signal through ASI Output is the TS extracted from the RF signal by means of the internal RF demodulator. The RF signal can come from digital terrestrial, satellite or cable. If the **IPTV** option is selected (This option is available only if IPTV is selected as a Signal Source), the signal through **ASI Output** is the TS extracted from the IPTV signal. The ASI Input option enables the TS-ASI packets coming from ASI input connector go out through the ASI output connector.



## 9 SPECIFICATIONS

### 9.1 RANGER Neo 2

#### 9.1.1 General

##### ► Inputs and Outputs

Parameter	Value	Additional data
<b>RF Input</b>		
Connector Input type	F male	75 $\Omega$
Maximum Signal	130 dB $\mu$ V	
Maximum Input Voltage	50 V rms	DC to 100 Hz; powered by the AL-103 power charger
	30 V rms	DC to 100 Hz; not powered by the AL-103 power charger
	140 dBuV	Protected up to 30 seconds
<b>Analogue Video Input</b>		
Connector Input	Multipole Jack	Zin=75 $\Omega$
Sensibility	1 Vpp	75 $\Omega$ ; positive video
<b>Analogue Audio Input</b>		
Connector Input	Multipole Jack	Zin=10 k; same V/A input multipole jack
<b>Digital Video/Audio OutPut</b>		
Output Connector	HDMI	1080p Resolution
<b>USB Interface 2.0</b>		
Connector	USB type A	
Features	Mass Storage Host	Can read and write on a pendrive USB CDC.
	USB CDC	CDC: Communication device class
<b>IP Interface (IP control)</b>		
Connector	RJ45	Labeled IP CTRL
Type	Ethernet 10 / 100 / 1000 Mbps	Webcontrol, firmware update, remote control
<b>WiFi Interface</b>		
Type	Wireless standard 802.11 abgn	Dongle-WiFi connected to USB port.
		Dongle must be validated by PROMAX.
<b>Monitor Display</b>		
Monitor	7" TFT	Transmissive colour dot matrix type
Aspect ratio	16:9	
Dot Format	800 x 480 dots	(R,G,B)(W) x (H)
Brightness	300 cd/m <sup>2</sup>	
<b>External Unit Power (through the RF input connector)</b>		
Terrestrial Supply	External	
	5 V	Up to 500 mA
	12 V	Up to 500 mA
	24 V	Up to 250 mA
Satellite Supply	External	Up to 500 mA
	5 V	Up to 500 mA
	13 V	Up to 500 mA

	15 V	Up to 500 mA
	18 V	Up to 500 mA
<b>22 kHz signal Voltage</b>	0.65 V ± 0.25 V	Selectable in Satellite band
<b>22 kHz signal Frequency</b>	22 kHz ± 4 kHz	Selectable in Satellite band
<b>DiSEqC Generator</b>	According to DiSEqC 2.x (DiSEqC 1.2 commands implemented)	DiSEqC is a trademark of EUTELSAT
<b>SATCR / SCD(EN50494)</b>	Available	
<b>dCSS / SCD2 (EN50607)</b>	Available	

### ► Mechanical Features

Parameter	Value	Additional data
<b>Dimensions</b>	290x185x95 mm	WxHxD
<b>Weight</b>	2.2 kg	without installed options
<b>Size</b>	5.096 cm <sup>3</sup>	

### ► Power Supply

Parameter	Value	Additional data
<b>Internal battery</b>	7.2 V; 13 Ah	Li-Ion Intelligent battery
<b>Battery Operation Time</b>	> 5 hours in continuous mode	No EXTERNAL supply active
<b>Recharging time</b>	3 hours up to 80%	Instrument off
<b>External Voltage</b>	12 V DC	Using only PROMAX supplied accessories
<b>Consumption</b>	40 W	
<b>Auto Power Off</b>	Programmable	After the selected amount of minutes without operating on any control. Deactivable

### ► Operating Environmental Conditions

Parameter	Value	Additional data
<b>Altitude</b>	Up to 2000 m	
<b>Temperature range</b>	From 5 °C to 45 °C	Automatic disconnection by excess of temperature
<b>Max. Relative humidity</b>	80%	up to 31°C; decreasing lineally up to 50 % at 40 °C.

**NOTE:** Equipment specifications are set in these environmental operating conditions. Operation outside these specifications are also possible. Please check with us if you have specific requirements.

### ► Included Accessories

Parameter	Value	Additional data
<b>1x 0 MT0170</b>	Antenna Dual WiFi	
<b>1x</b>	USB WiFi adapter	
<b>1x 0 MF0214</b>	USB cable	
<b>1x 0 C06861</b>	Aero SMA-H/BNC-M adapter	
<b>1x CC-046</b>	Jack 4V/RCA cable	
<b>1x AA-103</b>	Car lighter charger	
<b>1x AL-103</b>	External DC charger	
<b>1x AD-055</b>	"F"/H-"BNC"/H adapter	
<b>1x AD-056</b>	"F"/H-"DIN"/H adapter	
<b>1x AD-057</b>	"F"/H-"F"/H adapter	
<b>1x CA-005</b>	Mains cord	
<b>1x CB-084</b>	Rechargeable Li+ battery 7,2 V 13 Ah	Built-in
<b>1x DC-300</b>	Transport belt	
<b>1x DC-302</b>	Carrying bag	
<b>1x DC-230</b>	Transport Suitcase	
<b>1x DG0253</b>	Quick Reference Guide	
<b>1x OPS041</b>	Monopod	

### RECOMMENDATIONS ABOUT THE PACKING

It is recommended to keep all the packing material in order to return the equipment, if necessary, to the Technical Service.

## 9.1.2 Measurement Mode

### ► ATSC

Parameter	Value	Additional data
<b>Modulation</b>	8-VSB	
<b>Margin of power measurement</b>	From 45 dB $\mu$ V to 100 dB $\mu$ V	
<b>Measures</b>	Power, SER, VBER, MER, C/N and noise margin	
<b>Displayed data</b>	Numeric and level bar	
<b>Demodulation</b>	16/32/64/128/256 QAM	
<b>Symbol rate</b>	10,762 Mb/s	
<b>Code Rate</b>	2/3	
<b>Spectral inversion</b>	ON, OFF	Auto

### ► J83 Annex B

Parameter	Value	Additional data
<b>Modulation</b>	QAM	
<b>Margin of power measurement</b>	From 45 dB $\mu$ V to 115 dB $\mu$ V	
<b>Measures</b>	Power, BER, MER, C/N and noise margin	
<b>Displayed data</b>	Numeric and level bar	
<b>Bandwidth</b>	5, 6, 7 and 8 MHz	
<b>Spectral Inversion</b>	ON, OFF	Auto
<b>Demodulation</b>	64/256 QAM	
<b>Symbol rate</b>	5057 / 5361 kbauds	
<b>Roll-off (<math>\alpha</math>) factor of Nyquist filter</b>	0.18 / 0.12	
<b>Spectral inversion</b>	ON, OFF	Auto

### ► DVB-C

Parameter	Value	Additional data
<b>Modulation</b>	QAM	
<b>Margin of power measurement</b>	From 45 dB $\mu$ V to 115 dB $\mu$ V	786 MHz  16 QAM Sensitivity (QEF): 30 dB $\mu$ V 32 QAM Sensitivity (QEF): 33 dB $\mu$ V 64QAM Sensitivity (QEF): 36 dB $\mu$ V 128QAM Sensitivity (QEF): 39 dB $\mu$ V 256QAM Sensitivity (QEF): 42 dB $\mu$ V
<b>Measures</b>	Power, BER, MER, C/N and Link margin	
<b>Displayed data</b>	Numeric and level bar	
<b>Demodulation</b>	16/32/64/128/256 QAM	
<b>Symbol rate</b>	1000 - 7100 kbauds	
<b>Roll-off (<math>\alpha</math>) factor of Nyquist filter</b>	0.15	
<b>Spectral inversion</b>	ON, OFF	Auto
<b>Tuning Range</b>	45 - 1000 MHz	



► **Analogue TV**

Parameter	Value	Additional data
<b>Colour System</b>	PAL, SECAM and NTSC	
<b>Standard supported</b>	M, N, B, G, I, D, K and L	
<b>Sensitivity</b>	40 dBuV for a correct synchronism	

► **FM / RDS**

Parameter	Value	Additional data
<b>Tuning range</b>	45 to 1000 MHz	
<b>Tuning step size</b>	10 kHz	
<b>Sensitivity</b>	5 dBuV	150 MHz (S+N/N = 40 dB)
<b>Selectivity (mono)</b>	± 200 kHz 25 dB	

► **DVB-S**

Parameter	Value	Additional data
<b>Modulation</b>	QPSK	
<b>Margin of power measurement</b>	From 35 dBuV to 115 dBuV	2150 MHz, 27500 kSps, CR=2/3 Sensitivity (QEF): 29 dBuV  18 dBuV@2.15 GHz / 2 MSs; 30 dBuV@2.15 GHz / 27 MSs; 33 dBuV@2.15 GHz / 45 MSs
<b>Measures</b>	Power, CBER, MER, C/N and Link Margin	
<b>Displayed data</b>	Numeric and level bar	
<b>Symbol rate</b>	1 to 45 Mbauds	
<b>Roll-off (α) factor of Nyquist filter</b>	0.35	
<b>Code Rate</b>	1/2, 2/3, 3/4, 5/6, 7/8	
<b>Spectral inversion</b>	ON, OFF	Auto
<b>Tuning Range</b>	250 – 2350 MHz	From 2150 to 2350 MHz does not meet sensitivity specifications

► **DVB-S2**

Parameter	Value	Additional data
<b>Modulation</b>	QPSK, 8PSK, 16APSK, 32APSK	
<b>Margin of power measurement</b>	From 35 dBuV to 115 dBuV	2150 MHz, 27500 kSps, CR=2/3 Roll-off: 0.20  QPSK Sensitivity (QEF): 26 dBuV 8PSK Sensitivity (QEF): 30 dBuV  8PSK: 24 dBuV@2.15 GHz / 2 MSs; 34 dBuV@2.15 GHz / 27 MSs;
<b>Measures</b>	Power, CBER, LBER, MER, C/N, BCH ESR, Wrong Packets and Link Margin	
<b>Displayed data</b>	Numeric and level bar	
<b>Symbol rate</b>	1 - 45 MSps	QPSK, 8PSK, 16APSK, 32APSK
<b>Roll-off (α) factor of Nyquist filter</b>	0.20, 0.25 and 0.35	
<b>Code Rate (8PSK)</b>	1/2, 3/5, 2/3, 3/4, 4/5, 5/6, 8/9, 9/10	
<b>Code Rate (QPSK)</b>	3/5, 2/3, 3/4, 5/6, 8/9, 9/10	
<b>Spectral inversion</b>	ON, OFF	Auto
<b>Pilots</b>	Presence Indication	
<b>TS clock</b>		Warning message when the TS clock is too high.
<b>Tuning Range</b>	250 – 2350 MHz	From 2150 to 2350 MHz does not meet sensitivity specifications



► **DSS**

Parameter	Value	Additional data
<b>Modulation</b>	QPSK	
<b>Margin of power measurement</b>	From 35 dB $\mu$ V to 115 dB $\mu$ V	
<b>Measures</b>	Power, CBER, VBER, MER, C/N and Noise Margin	
<b>Displayed data</b>	Numeric and level bar	
<b>Symbol rate</b>	20 Mbauds or variable	Auto detected
<b>Roll-off (<math>\alpha</math>) factor of Nyquist filter</b>	0.20	
<b>Code Rate</b>	1/2, 2/3, 6/7 and AUTO	
<b>Spectral Inversion</b>	ON, OFF	Auto
<b>Tuning Range</b>	250 – 2350 MHz	From 2150 to 2350 MHz does not meet sensitivity specifications

### 9.1.3 Spectrum Analyzer Mode

► **Digital Signal**

Parameter	Value	Additional data
<b>General Parameters</b>		
<b>Resolution filter</b>	100 kHz	
<b>Markers</b>	1	It displays frequency, level indication, level difference, frequency difference
<b>Reference Level</b>	65 dB $\mu$ V to 135 dB $\mu$ V	Adjustable in steps of 5 dB
<b>Spectrum range</b>		Span, dynamic range and reference level are variable by means of arrow cursors
<b>Terrestrial</b>		
<b>Tuning range</b>	5 to 1000 MHz	Continuous tuning from 5 to 1000 MHz
<b>Tuning mode</b>	Channel or frequency	Channel plan configurable; tune step 50 kHz
<b>Tuning Accuracy</b>	$\pm 1.163$ kHz	
<b>Tuning Resolution</b>	10 kHz	
<b>Resolution filter</b>	2, 10, 20, 40, 100, 200, 1000 kHz	
<b>Measurement range</b>	30 dB $\mu$ V - 130 dB $\mu$ V $\pm 1,5$ dB	31,6 $\mu$ V to 3.16 V
<b>Span</b>	Full span-500-200-100-50-20-10 MHz	Full span (full band); selectable by joystick
<b>Digital channels measures</b>	Channel power, C/N, MER, BER, LM	According to modulation type
<b>Satellite</b>		
<b>Tuning range</b>	250 to 2500 MHz	
<b>Tuning mode</b>	Intermediate frequency or downlink	Channel plan configurable; tune step 50 kHz
<b>Tuning accuracy</b>	$\pm 2,6$ kHz	
<b>Tuning Resolution</b>	10 kHz	
<b>Resolution filter</b>	10, 20, 40, 100, 200, 1000 kHz	
<b>Measurement range</b>	31 dB $\mu$ V - 130 dB $\mu$ V	35.5 $\mu$ V to 3.16 V
<b>Span</b>	Full span-1500-1265-850-500-250-200-100-50-20-10 MHz	Full span (full band); selectable by joystick
<b>Digital channels measures</b>	Channel power, C/N, MER, BER, LM	According to modulation type



► **Analogue Signal**

Parameter	Value	Additional data
<b>General Parameters</b>		
<b>Attenuation scale</b>	Auto-range	
<b>Numerical indication</b>	Absolute value according to selected units	
<b>Graphical indication</b>	Analogue bar on screen	
<b>Audible indicator</b>	Pitch sound	Tone with pitch proportional to signal strength
<b>Terrestrial</b>		
<b>Tuning range</b>	5 to 1000 MHz	
<b>Tuning mode</b>	Manual	
<b>Tuning Resolution</b>	10 kHz	
<b>Measurement range</b>	15 dBµV to 130 dBµV	3.16 µV to 3.16 V
<b>Analogue channels measures</b>	Level, C/N, V/A	
<b>Accuracy</b>	±1.5 dB	20 dBµV -130 dBµV @ 990 MHz 10 µV - 3.16 V 22°C ± 5°C
<b>Out of range indication</b>	<, >	
<b>Satellite</b>		
<b>Tuning range</b>	250 to 2500 MHz	
<b>Tuning mode</b>	Intermediate frequency or downlink	Channel plan configurable
<b>Resolution</b>	10 kHz	
<b>Measurement range</b>	15 dBµV (250 - 1800MHz) 20 dBµV (1800 - 2300MHz) 25 dBµV (2300 - 2500MHz)	20 dBµV -130 dBµV @ 2490 MHz 10 µV - 3.16 V
<b>Analogue channels measures</b>	Level, C/N	
<b>Accuracy</b>	±1.5 dB	20 dBµV - 130 dBµV @ 2490 MHz 10 µV - 3.16 V 22 °C ± 5 °C
<b>Out of range indication</b>	<, >	



### 9.1.4 TV Mode

#### ► Video

Parameter	Value	Additional data
<b>Codecs</b>	MPEG-1	
	MPEG-2	MP@HL (Main profile high level)
	MPEG-4 AVC H.264	High Profile Level 4.1; maximum bitrate 40 Mbps
	H.265 L4.1	Maximum Bitrate according to specifications by HEVC High Profile 4.1
<b>Maximum Image Size</b>	1920x1080x60p; 1280x720x60p/50p	
<b>Minimum Image Size</b>	352x240x30p; 352x288x25p	
<b>Bitrate</b>	40 Mbps	
<b>Aspect Ratio</b>	16/9; 4/3	
<b>SI/PSI data</b>	Service list and main PIDs	
<b>HD Video Resolution</b>	1080, 720 and 576	Progressive or interlaced
<b>HDMI output resolution</b>	1080p	

#### ► Audio

Parameter	Value	Additional data
<b>Codecs</b>	MPEG-1	
	MPEG-2	
	HE-AAC	
	Dolby Digital and Dolby Digital +	
<b>Demodulation</b>	According to the TV standard	
<b>De-emphasis</b>	50 $\mu$ s	75 $\mu$ s (NTSC)
<b>Sound subcarrier</b>	Digital frequency synthesis according to the TV standard	

#### ► Transport Stream

Parameter	Value	Additional data
<b>Communication protocol</b>	MPEG-2	
<b>Packets</b>	188 or 204 bytes	Automatic detection
<b>Video Info</b>	Type, bitrate, format, aspect ratio, frequency, profile, PID	
<b>Service Info</b>	Network, provider, NID, ONID, scrambled/free, TSID, SID, LCN	
<b>Audio Info</b>	Type, bitrate, format, frequency, mono/stereo, language, PID	

### 9.1.5 WiFi Analyzer Mode

Parameter	Value	Additional data
<b>Band</b>	2,4 GHz	
<b>Resolution Filter</b>	100 kHz	
<b>Reference Level</b>		
<b>RSSI</b>	dBm	Depending on WiFi dongle
<b>SNR</b>	dB	
<b>Maximum Power</b>	+15 dBm	Measured over spectrum
<b>Average Power</b>	+15 dBm	Measured over spectrum
<b>Bandwidth</b>	Ap Bandwidth	
<b>Access Point Number</b>	AP number in the same BW	



**9.1.6 IPTV**

► **Streams Multicast**

Parameter	Value	Additional data
<b>IP</b>	224.0.0.0 to 239.255.255.255	
<b>Ports</b>	1024 to 65535	
<b>Maximum bitrate</b>	80 Mbit/s	
<b>IPER (ITU Y.1540)</b>		Population of interest: all Ethernet frames received on the interface; recommended value < 100 ms
<b>MDI (RFC4445)</b>		Population of interest: specified multicast stream; recommended value < 0.005 pkt/s
<b>Mean IPTD, IPDV (ITU Y.1540)</b>		Population of interest: PING packets with 16 bytes of data. Packet Transfer Delays are based in the halved round-trip time of PING packets
<b>Autodetection of crossover cables</b>	Yes	

**9.1.7 Tools**

► **Constellation**

Parameter	Value	Additional data
<b>Type of Signal</b>	ATSC, J83 Annex B, DVB-C, DSS, DVB-S and DVB-S2	
<b>Displayed data</b>	I-Q graph	

► **LTE Ingress Test**

Parameter	Value	Additional data
<b>Type of signal</b>	ATSC	
<b>Displayed data</b>	LTE band plus quality parameters for a selected TV channel	

► **Attenuation Test**

Parameter	Value	Additional data
<b>Test frequencies</b>	3 selectable pilots	

► **Datalogger**

Parameter	Value	Additional data
<b>Stored data</b>	Signal type, modulation parameters, all measures available for the detected signal type, and time stamp	If GPS is connected to USB port, the equipment stamps GPS coordinates in each measure made.
<b>Timestamp</b>	Date and time at each measured channel	



► **Transport Stream Analyzer**

Tables	Value	Additional data
<b>PSI Tables</b>	PAT	Program Association Table
	PMT	Program Map Table
	NIT	Network Information Table
	CAT	Conditional Access Table
<b>SI Tables</b>	NIT	Network Information Table
	BAT	Bouquet Association Table
	SDT	Service Description Table
	EIT	Event Information Table
	TDT	Time and Date Table
	TOT	Time and Date Table
<b>Bitrate</b>	<b>Value</b>	<b>Additional data</b>
<b>Bitrate max</b>	80 Mbit/s	
<b>Alarms</b>	<b>Value</b>	<b>Additional data</b>
<b>According to ETSI std TR101 290 V1.2.1</b>		Sections 3.3, 3.9 and 3.10 (no measurements done)

► **Shoulders Attenuation**

**TDB**



**9.1.8 Options**

► **Fibre Optics**

Parameter	Value	Additional data
<b>Selective Optical Power Meter</b>		
<b>Optical Measure bands</b>	1310 nm ± 50 nm; 1490 nm ± 10 nm; 1550 nm ± 15 nm	
<b>Connector</b>	FC/APC	
<b>Measurement Dinamic Range</b>	- 49,9 dBm to +10 dBm	Accuracy ± 0,5 dB
<b>Isolation between bands</b>	> 45 dB	
<b>Optical to RF Converter</b>		
<b>Dynamic range of conversion</b>	From -5 dBm to +10 dBm	
<b>Atenuación RF</b>	ON = 15 dB; OFF = 0 dB	
<b>RF band converted (Optical Cable and DTT links)</b>	From 65 MHz to 1000 MHz	
<b>RF band converted (Optical IF-Satellite Installations)</b>	From 950 MHz to 5450 MHz	for universal optical LNB
<b>RF output</b>	From 65 MHz to 2150 MHz	
<b>5 GHz RF Auxiliary input</b>		
<b>Connector</b>	SMA	
<b>Frequency bands</b>	Band1 = De 2000 MHz a 3000 MHz	
	Band2 = De 3400 MHz a 4400 MHz	
	Band3 = De 4400 MHz a 6000 MHz	
<b>Dynamic Range</b>	45 -105 dBµV	ATT OFF
	60 - 120 dBµV	ATT ON
<b>Conversion Gain</b>	7 dB	
	-8 dB	
<b>Flatness</b>	+ -5 dB	
<b>Spurious</b>	< 45 dBµV	(-65 dBm) typical
<b>Intermodulation products</b>	<15 dB typical	
<b>Maximum input signal</b>	RF: 120 dBµV; DC: 50 V	

► **DAB/DAB+**

Parameter	Value	Additional data
<b>Combined antenna input</b>	for Band III	
<b>DAB sensitivity</b>	up to -94 dBm	typical value
<b>Decodes audio services</b>	up to 384 kbit/s	

► **WiFi 5G Analyzer**

TBD



## 10 MAINTENANCE

### 10.1 Instructions for returning by mail

Instruments returned for repair or calibration, either within or out of the warranty period, should be sent with the following information: Name of the Company, name of the contact person, address, telephone number, receipt (in the case of coverage under warranty) and a description of the problem or the service required.

### 10.2 Considerations about the Screen

This paragraph offers key considerations regarding the use of the colour screen, taken from the specifications of the manufacturer.

In the TFT display, the user may find pixels that do not light up or pixels that are permanently lit. This should not be regarded as a defect in the TFT. In accordance with the manufacturer quality standard, 9 pixels with these characteristics are considered admissible.

Pixels which are not detected when the distance from the surface of the TFT screen to the human eye is greater than 35 cm, with a viewing angle of 90° between the eye and the screen should not be considered manufacturing defects either.

It is advisable a viewing angle of 15° in the 6.00 o'clock direction in order to obtain the optimum visualization of the screen.

### 10.3 Cleaning Recommendations

The equipment consists of a plastic case and a TFT screen. Each element has its specific cleaning treatment.

#### ■ Cleaning the TFT screen

The TFT screen surface is VERY DELICATE. It has to be cleaned with a soft fabric cloth (cotton or silk), always making the same move from left to right and from top to bottom, without putting pressure on the screen.

The TFT screen has to be dry-cleaned or with a product specifically designed for TFT screens, by slightly dampening the cloth. NEVER use tap or mineral water, alcohol or conventional cleaning products, because they contain components that can damage the screen.

Turn off the equipment to locate dirt on the screen. After cleaning, wait a few seconds before turning on.



- **Cleaning the plastic case**

The equipment has to be disconnected before cleaning the case.

The case must be cleaned with a solution of neutral soap and water, using a soft cloth dampened with this solution.

Before use, the equipment has to be completely dry.

Never clean with abrasive soaps, chlorinated solvents or aromatic hydrocarbons. These products may degrade the case.



## ANNEX 1 OPTICAL OPTION OP-002-PS

### A1.1 GENERAL

#### A1.1.1 Description

This annex contains operating instructions for the next option:

**OP-002-PS:** Selective Optical Power Meter +  
Optical to RF Selective Converter.

The evolution of the telecommunications market, more and more demanding in quality standards, speed, services and so on and also economical and competitiveness factors has changed the trend in telecommunications installations, and increasingly, fibre-optics is being imposed on traditional ADSL twisted-pair copper lines.

For this reason and in anticipation of an increase of fibre-optics installations, this option has been developed. It is applicable to the **RANGER Neo** Analyzers and allows adapting it in order to work with fibre-optics networks.

This optical module expansion includes two separate functions: The selective optical power meter and the selective optical to RF converter.

The selective meter option allows measurements on optical fibre networks, which are necessary to certify an installation according to the parameters set by local policies.

The optical to **RF** selective converter has a photosensor for each wavelength, which obtains the **RF** signal carried by each one. With this module, user can measure terrestrial or cable (up to 1 GHz) networks or optical **LNB** for satellite antennas (up to 5.45 GHz), so that the installer does not need any additional equipment to measure this type of installations.

This expansion module is available for **RANGER Neo** unit (both for new equipments or to upgrade equipments owned).

## A1.2 DESCRIPTION OF INTERNAL OPERATION

The selective meter consists, in first place, of a selective triple filter for 1310, 1490 and 1550 nm signals. The filter separates each wavelength and each one leads to an independent circuit with a photosensor, which obtains the **RF** signal that it carries. Next, a circuit measures the optical signal power received by the photosensor. The **RF** signal obtained for each wavelength goes to a band switch.

The band switch receives a signal and converts it to a frequency within the RF band (65 – 2150 MHz). In the case of a terrestrial/cable signal the signal is not converted since that signal is within the RF range.

After the conversion, the **RF** signal output is connected to the Analyzer input connector and the measurement is performed in the usual way to an RF signal. In the conversion, bear in mind that for every unit of optical attenuation (one dB), occurs two dBs of power loss in **RF**. As an example, every 3 dB of optical attenuation for each splitter are equivalent to 6 dB of power loss for **RF**.

The following diagram explains graphically how works the module:

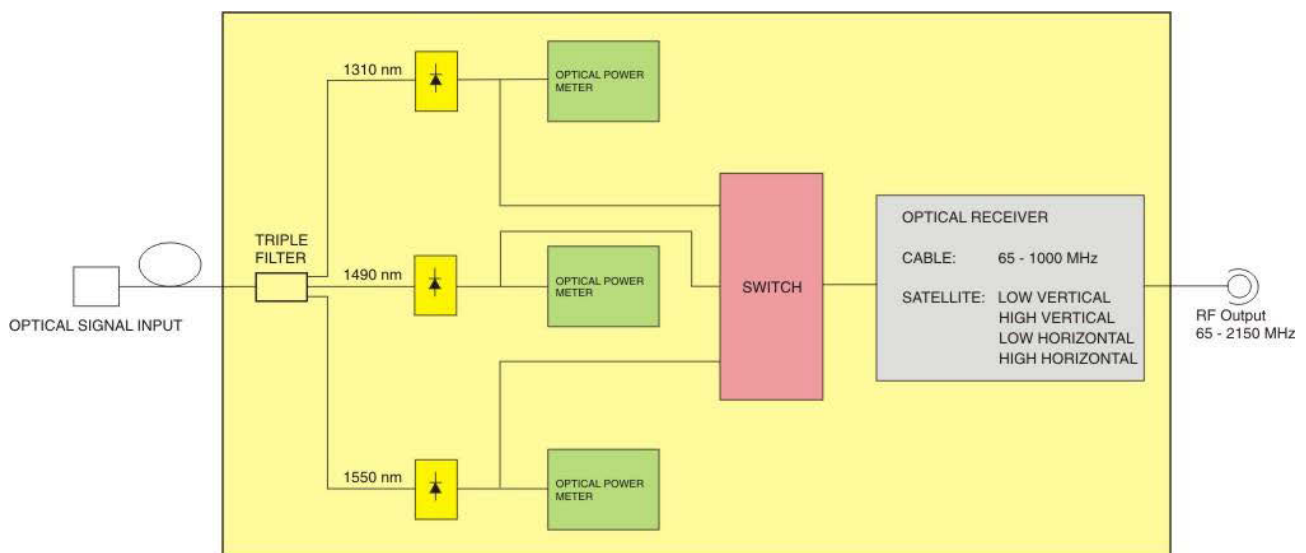

Figure A1.1.





## A1.3 Fibre optical test

### A1.3.1 Description

The optical function of this module allows the user to certify a telecommunication installation by calibrating the signals at the installation and then measuring them in each of the user access points.

The **RANGER Neo** with optical module can measure simultaneously and in a selective way the three wavelengths used in optical fibre (1310, 1490 and 1550 nm). It has a selective receiver with a filter for each band that makes a real and very stable measurement of each wavelength. With this feature, user will be able to certify any installation according to the telecommunications infrastructure policies.

### A1.3.2 Operation

To access the **FIBRE OPTIC TEST** tool:

- 1 Connect the **optical input** signal to the optical input of the equipment.
- 2 Enter the **MEASUREMENT** or **SPECTRUM** mode.
- 3 Press the **TOOLS** key .
- 4 Select the **FIBRE OPTIC TEST** option.
- 5 It appears the screen to perform the **FIBRE OPTIC TEST** on the signal.



**Figure A1.2.**

Next it is shown the screen to perform the fibre optic test:

► **Screen description**

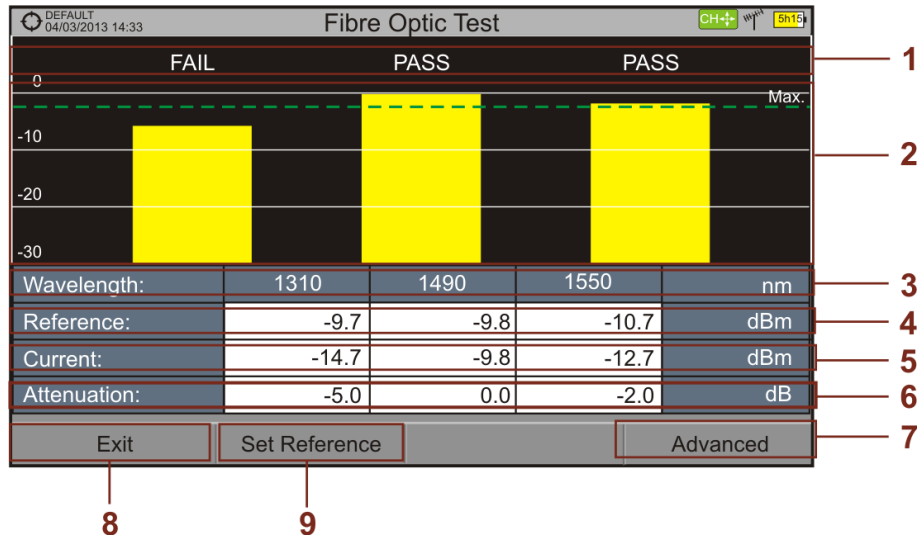

**Figure A1.3.**

- 1 Status message depending on the level of attenuation.
- 2 Power level of the signal.
- 3 Wavelength of the signal (nm).
- 4 Power level of the reference signal, which is used to calibrate and calculate the attenuation level (dBm).
- 5 Power level of the test signal at the user's access point (dBm).
- 6 Attenuation level (dB);  $\text{Attenuation} = \text{Current} - \text{Reference}$ .
- 7 "**Advanced**" key to access these options: Threshold attenuation and Max. attenuation (see Max. dashed line).
- 8 "**Exit**" button to exit the screen.
- 9 "**Set Reference**" key to calibrate the reference signal.



### A1.3.3 Menu options for the Fibre Optical Test tool

On the bottom of the screen there are three menus accessible via the function keys.



It exits the tool.



When pressing this key it uses the current values of power as a reference values.



It accesses the Advanced menu.

In the **Advanced** menu there are two parameters to configure the fibre optical test. They are:

► **Threshold Attenuation:**

It defines the maximum difference that can exist between the reference signal with the highest power level and the reference signal with the lowest power level. Any signal out of this range will be deleted and not used as a reference signal during the measurement process.

► **Max. Attenuation:**

It defines the attenuation level used by the field meter to display the status message on screen. If the attenuation level is below this value the status message will be "**PASS**" and if it is above this value the status message will be "**FAIL**".



### A1.3.4 Example of a practical application in order to certify an installation by using the RANGER Neo

Next there is a step by step example to certify a telecommunication installation of optical fibre by using the RANGER Neo optical module.

To make the required certification it is necessary:

- RANGER Neo with the optical module.
- A signal generator of the three wavelengths used in fibre optical installations in order to calibrate and measure (**PROLITE-105**).
- A pigtail with a **FC** to **SC** adapter.

► **Stage 1. Capturing reference measurements.**

- 1 Connect the **SC** pigtail end connector to the **PROLITE-105** output connector.
- 2 Connect the **FC** end of the pigtail to the optical input of the **RANGER Neo** (see figure below).
- 3 Turn on the **PROLITE-105** and the **RANGER Neo**
- 4 Press  key to access the **Tools** menu.
- 5 Select the **FIBRE OPTIC TEST** option and press the *joystick*.
- 6 In the **PROLITE-105**, press once the **SEQ**  key to select the **SIMULTANEOUS** mode. This mode simultaneously sends three wavelengths signals.
- 7 In the **RANGER Neo**, press the  key **Set Reference**. All current values are captured, which will be used as reference values.
- 8 Now, user can proceed to **Stage 2** in order to measure the attenuation at each user's access point.

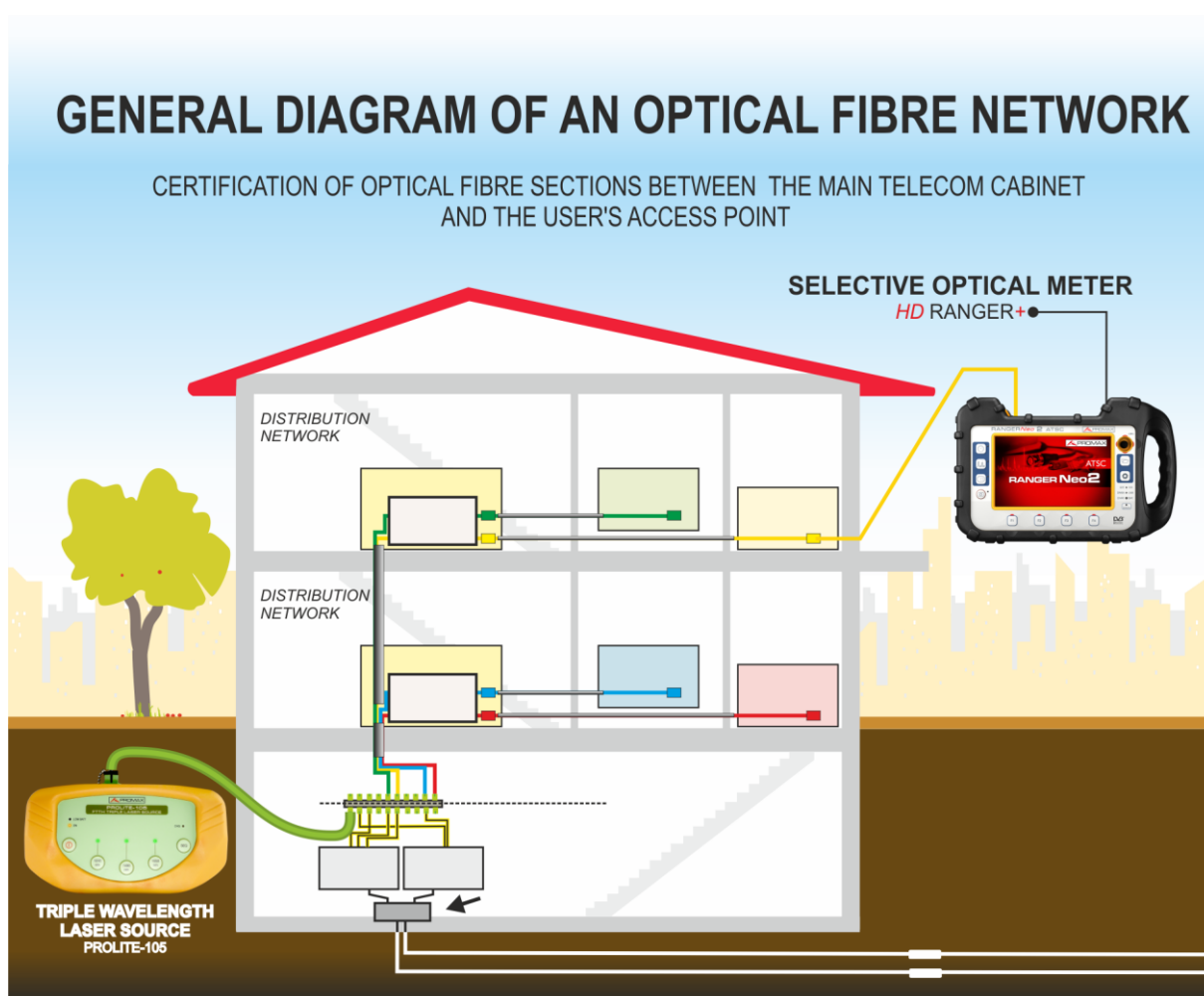

**Figure A1.4.**



► **Stage 2. Attenuation Test Measurement.**

- 1 Connect the **PROLITE-105** in a source node of the transmission optical network, for example in a free strip of the main telecommunications cabinet of the building.
- 2 Keep the **PROLITE-105** in simultaneous mode for generating signals, so it **SIMULTANEOUSLY** generates all three wavelengths (1310 nm, 1490 nm and 1550 nm).
- 3 Connect the **RANGER Neo** to a receiving node of the optical network that is going to be measured, such as for example in a **UAP** (User Access Point).
- 4 Using the **RANGER Neo**, check measurements on the **FIBRE OPTIC TEST** screen.



**Figure A1.5.**

## A1.4 Selective optical to RF converter

### A1.4.1 Description

The selective optical to **RF** converter has a filter that separates each wavelength and directs it to an independent circuit with a photosensor, which obtains the **RF** signal that carries. The **RF** signal obtained for each wavelength passes to a band switch.

The band switch receives a signal and converts it to a frequency within the **RF** band (65 – 2150 MHz). In the case of a terrestrial / cable signal the signal is not converted since that signal is within the **RF** range. After the conversion, the **RF** signal output is connected to the Analyzer input connector and the measurement is performed in the usual way to an **RF** signal. In the conversion, bear in mind that for every unit of optical attenuation (one dB), occurs two dBs of power loss in **RF**. As an example, every 3 dB of optical attenuation for each splitter are equivalent to 6 dB of power loss for RF.

### A1.4.2 Operation

Signal connection to use this option is as follows:



**Figure A1.6.** Upper panel of RANGER Neo (with this option installed).

- 1 Pigtail adapter (supplied with the module) with input optical signal.
- 2 **FC—APC** input connector for optical signal.



**A1.4.3 Configuration for the selective optical to RF converter**

After the connection is made, the user can use the equipment for measurement of optical signals as if they were **RF** signals. Steps to measure a signal are as follows:

- 1 Press the Settings  key and in "Signal source" select "Fiber optic".
- 2 select the corresponding band, whether terrestrial (for optical link) or satellite (for optical LNB). In the case of a satellite optical signal and frequency tuning, user has to select the signal type, characterized by the band (low/high) and the type of polarization (vertical/horizontal). In the case of a satellite optical signal and channel tuning, the parameters are defined by the channel (refer to the Settings menu section for more details).
- 3 Select the **Optical module** option and press the joystick.
- 4 It appears a window to enable the optical module and to configure additional parameters.
- 5 Select **Enable**.
- 6 At the top right area of the screen appears the **OPT** icon meaning there is external power.
- 7 It appears a window with some setting parameters.

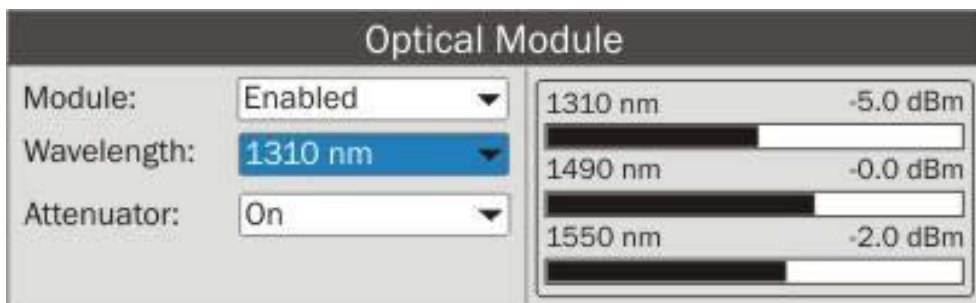

**Figure A1.7.**

In this window appears the level power for each wavelength and also the user can set two parameters:

- ▶ **Wavelength:**  
Wavelength selection at the **RF** output by the user among the three wavelength available: 1310, 1490 and 1550 nm.
- ▶ **Attenuator:**  
When the attenuator is ON is 15 dB RF attenuation. When the attenuator is OFF is 0 dB RF attenuation. The attenuator must be adapted to the installation according to the RF power (modulation index).



## ANNEX 2 DAB/DAB+ OPTION OP-002-DAB

### A2.1 GENERAL

#### A2.1.1 Description

This annex contains instructions for the following option:



**OP-002-DAB:** DAB/DAB+ signal analysis.

This option allows the user to detect, measure, analyse and visualise digital radio **DAB** and **DAB+** .

The **DAB** (Digital Audio Broadcasting) is a digital radio standard, designed for both home and portable receivers to broadcast terrestrial and satellite audio and also data. It works with Band III and L-Band frequencies.

The **DAB+** is an evolution of DAB using the AAC + audio codec. It also includes Reed-Solomon error correction, which makes it more robust. DAB receivers are not compatible with DAB+ receivers.

#### A2.1.2 Operation

- 1 Connect the RF input signal to the equipment.
- 2 Select the frequency band (terrestrial or satellite) by means of the "Settings"  menu.
- 3 Access the **MEASUREMENT, SPECTRUM ANALYSER** or **TV MODE** by pressing the corresponding key.
- 4 Lock the DAB/DAB+ signal.
- 5 If you want to enable auto-detection function for DAB/DAB+, go to "Preferences" by pressing the  key for 1 second and in the Stealth -ID tab select the **DAB/DAB+** option.





**A2.1.3 MEASUREMENT Mode**

Views for **DAB/DAB+** signal in **MEASUREMENT** mode are:

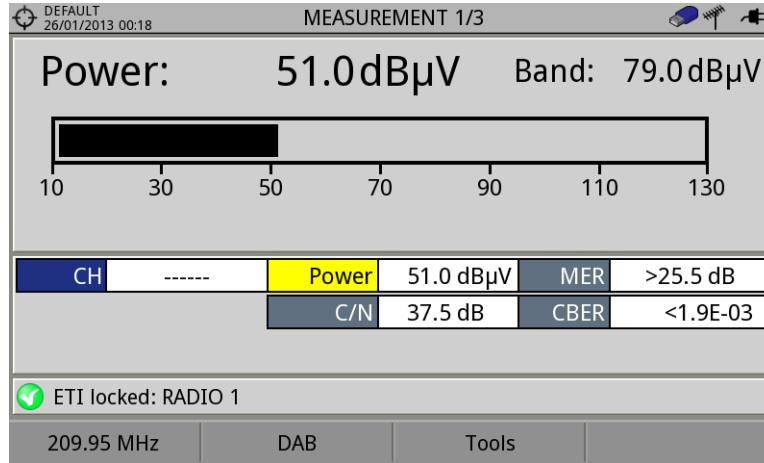

**Figure A2 1.** Measurement 1/3

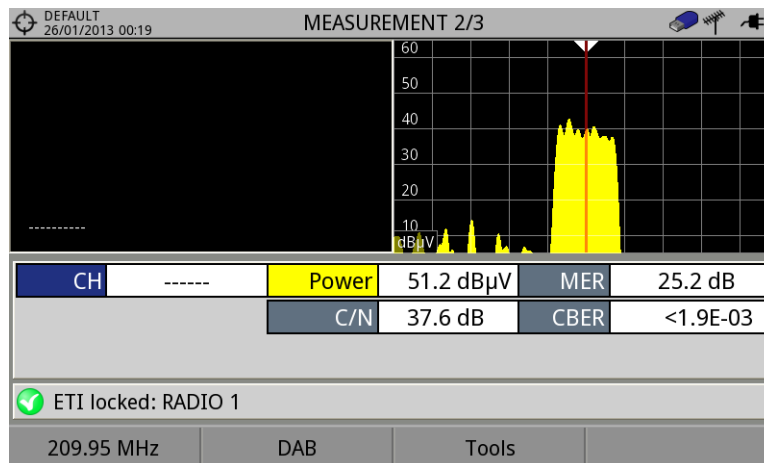

**Figure A2 2.** Measurement 2/3

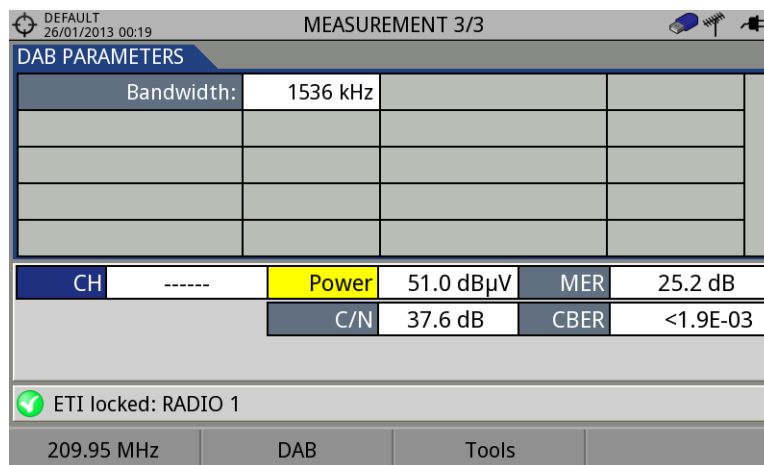
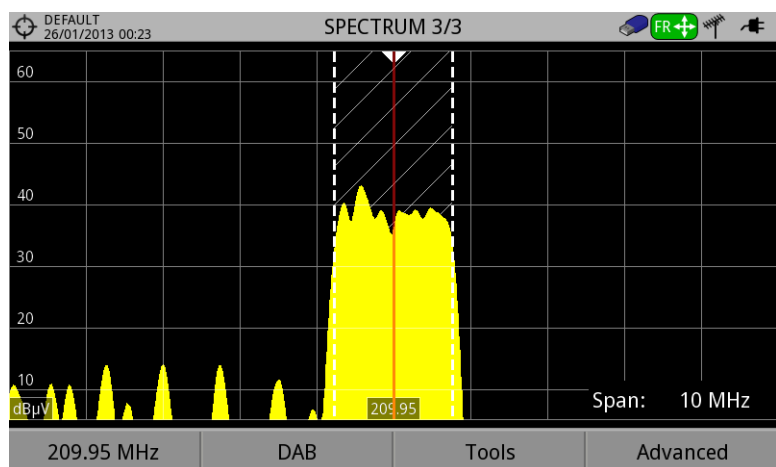
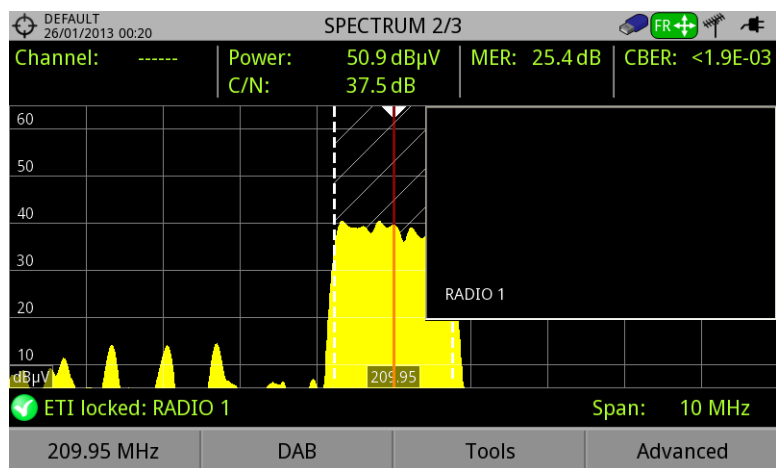
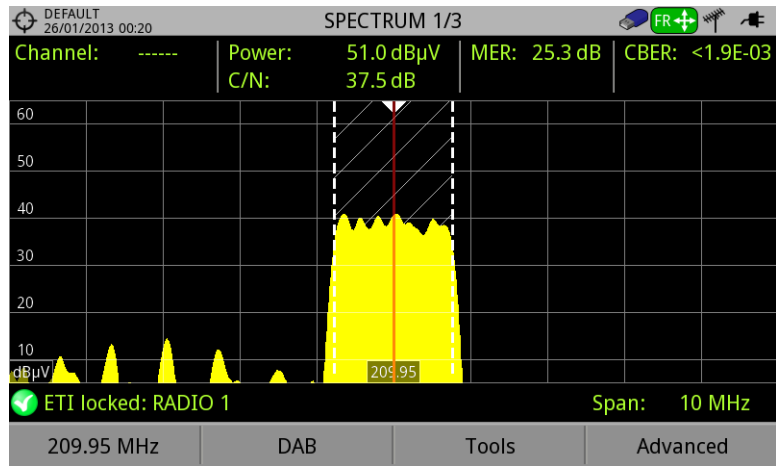

**Figure A2 3.** Measurement 3/3



**A2.1.4 SPECTRUM ANALYSER Mode**

Views for **DAB/DAB+** signal in **MEASUREMENT** mode are:





**A2.1.5 TV Mode**

Views for **DAB/DAB+** signal in TV mode are:



**Figure A2 7. DAB 1/3**

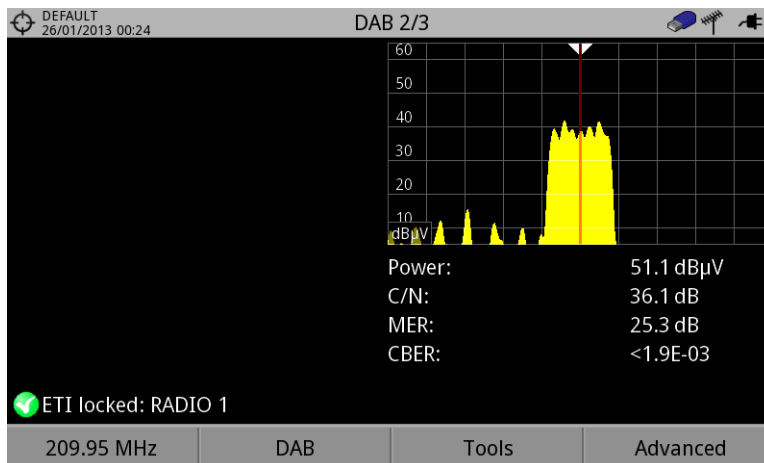

**Figure A2 8. DAB 2/3**

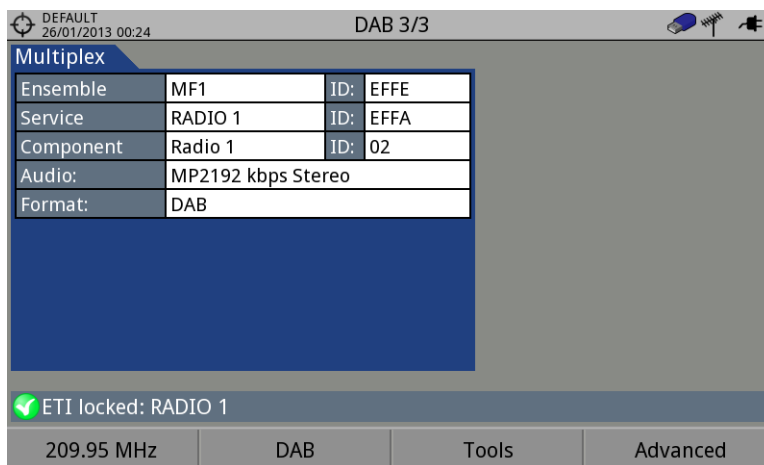

**Figure A2 9. DAB 3/3**



## ANNEX 3 MULTIMEDIA CONTENT

Next it is the list with all the links of the multimedia content in the user's manual:

TITLE	LINK
Introducing the RANGER <i>Neo</i>	<a href="http://youtu.be/XpNxIOSfkf0">http://youtu.be/XpNxIOSfkf0</a>
Navigating through the menus	<a href="http://youtu.be/Zm_QT-qtY4">http://youtu.be/Zm_QT-qtY4</a>
Switching satellite/terrestrial bands	<a href="http://youtu.be/ecv1P0Cf_fI">http://youtu.be/ecv1P0Cf_fI</a>
Manual input of frequencies	<a href="http://youtu.be/81I5ezO4cgg">http://youtu.be/81I5ezO4cgg</a>
DVB-S2 multi stream decoding	<a href="http://youtu.be/xuv9ESed_Ak">http://youtu.be/xuv9ESed_Ak</a>
What is LTE?	<a href="http://youtu.be/ZNPeDC4K-YI">http://youtu.be/ZNPeDC4K-YI</a>
Datalogger	<a href="http://youtu.be/TUuHJBX0BQI?t=3m55s">http://youtu.be/TUuHJBX0BQI?t=3m55s</a>
Channel plan exploration	<a href="http://youtu.be/TUuHJBX0BQI?t=2m54s">http://youtu.be/TUuHJBX0BQI?t=2m54s</a>
Installation manager	<a href="http://youtu.be/TUuHJBX0BQI">http://youtu.be/TUuHJBX0BQI</a>
Generating a measurement report	<a href="http://youtu.be/fQP8n-59pHc">http://youtu.be/fQP8n-59pHc</a>
Creation of a channel plan	<a href="http://youtu.be/YwbpfRNGJYI">http://youtu.be/YwbpfRNGJYI</a>

Below is a list of documents that provide additional information along with the download link and the QR code for downloading from the PROMAX website.

- **Signals Description:** Brief definition of all signals and parameters detected by the meter.
- **How to point a dish antenna:** Explanation about how to use the meter to install and point a satellite dish.
- **DiSEqC Commands:** Description of DiSEqC commands for remote control of antennas.
- **Remote Control Commands:** Description of remote commands for remote control of the meter.
- **NetUpdate Manual:** Instructions manual about the NetUpdate software to update firmware and manage data from the meter.



---

**PROMAX ELECTRONICA, S. L.**

**Test Equipment  
Depot**

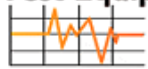

**1-800-517-8431**

99 Washington Street  
Melrose, MA 02176  
Phone 781-665-1400  
Toll Free 1-800-517-8431



Visit us at [www.TestEquipmentDepot.com](http://www.TestEquipmentDepot.com)