

# RANGER *Neo* Lite RANGER *Neo* +

## TV AND SATELLITE ANALYZER



## SAFETY NOTES

Read the user's manual before using the equipment, mainly "SAFETY RULES" paragraph.

The symbol  on the equipment means "SEE USER'S MANUAL". In this manual may also appear as a Caution or Warning symbol.

**WARNING AND CAUTION** statements may appear in this manual to avoid injury hazard or damage to this product or other property.

## ELECTRONIC MANUAL VERSION

You can access instantly to any chapter by clicking on the title of the chapter in the table of contents.

Click on the arrow  at the top right page to return to the table of contents.

Click on video boxes  to access video-tutorial on PROMAX youtube channel.

At Index click on page number to access the subject.

## USER'S MANUAL VERSION

| Manual Version | Web Publication Date | Firmware Version |
|----------------|----------------------|------------------|
| F4.0           | March 2021           | 29.5             |

- Please update your equipment to the latest software version available.
- This user's manual describes operation for models **RANGER *Neo* Lite** and **RANGER *Neo* +**. Differences between them are specified by an asterisk (\*) and in certain sections explicitly.
- Screen captures of current manual are from the **RANGER *Neo* +**.

## WHAT'S NEW on manual F4.0

- New tool: Task Management from webControl (["Task Management" on page 183](#)).
- New tool (optional): Mask Monitoring from webControl (["Mask Monitoring" on page 169](#)).
- Update: Monitoring total time counter and cycle time counter on the quality signal monitoring from webControl (["? Screen Description" on page 168](#)).

- Update: On TV Parameters from webControl if DAB contains images they are also shown (["? Screen Description" on page 161](#)).
- Update: Polarization for satellite band it is also saved in datalogger (["? Datalogger" on page 209](#)).
- Update: New options on webControl (About Equipment; current installation folder; GPS coordinates) (["? Screen Description" on page 160](#)).
- New option: Power off from menu (["Switching On/Off" on page 13](#)).
- New preference: Time setting by means of NTP protocol (["?NTP Options" on page 45](#)).
- Update: On Installation Manager, when selecting a channel plan it shows its version (["Installation Management" on page 150](#)).
- Update: Previous to start a Signal Coverage or Drive Test, it shows the reference level to be used during measurement (["SIGNAL COVERAGE OPTION" on page 231](#)).
- Update: On Discover FM Stations, each channel is named after its service name (["Menu Options" on page 119](#)).
- Others: Other minor updates and improvements.

## PREVIOUS VERSIONS OF USER'S MANUAL

| Manual Version | Web Publication Date | Firmware Version |
|----------------|----------------------|------------------|
| F3.0           | October 2019         | 28.0             |
| F2.1           | May 2019             | 27.2             |
| F2.0           | May 2019             | 27.2             |
| 1.2            | May 2017             | 23.4             |

## WHAT'S NEW on manual F3.0

- New tool: Channel plan edition from webControl (["Channel Plan Editor" on page 182](#)).
- New tool: PDF report creation from webControl (["? Options Menu \(mouse right button\):" on page 179](#)).
- Update: New parameters available when creating a channel plan from webControl (["Channel Plan Creator" on page 181](#)).
- Update: In webControl, the TV Parameters screen allows listening to FM or DAB audio (["TV Parameters" on page 161](#)).
- New option: It allows rebooting the meter from webControl (["Measurements and Spectrum" on page 159](#)).
- New preference: Using a hard drive for webcontrol monitoring (["?Tools Options" on page 42](#)).
- Update: Ethernet communication specs (["? Inputs and Outputs" on page 198](#)).
- Update: Available SID identifier in hexadecimal format (["?Appearance Options" on page 41](#)).

## WHAT'S NEW on manual F2.1

- Others: Error corrections and minor improvements.

## WHAT'S NEW on manual F2.0















- New tool: OTT signal (["OTT " on page 145](#)).
- New tool: webControl tool (["WEBCONTROL" on page 156](#)).
- New tool: Service Recording (["Service Recording" on page 130](#)).
- New tool: Tilt (["Tilt" on page 132](#)).
- New tool: Scan (["Scan" on page 134](#)).
- New tool: Streaming V/A (["Streaming V/A" on page 135](#)).
- New Signal Source: CCTV (["? Signal Source" on page 36](#)).
- New option: Stealth-ID ON/OFF (["?Stealth-ID" on page 53](#)).
- New setting: 22 kHz Tone Position (["?Measurement Options" on page 42](#)).
- New preference: SMTP e-mail server settings (["?SMTP Options" on page 45](#)).
- Update: Date and time are updated when locking a GPS signal (["SIGNAL COVERAGE OPTION" on page 231](#)).
- New setting: GPS Alarm setting (["SIGNAL COVERAGE OPTION" on page 231](#)).
- New option: Schedule for signal monitoring and coverage (["Settings" on page 101](#)).
- New preference: Offset for power/level (["?Measurement Options" on page 42](#)).
- New setting: Touch panel calibration (["?Appearance Options" on page 41](#)).
- New preference: SNMP protocol settings (["?SNMP Options" on page 45](#)).
- Update: DAB/DAB+ screens (["DAB/DAB+ OPTION" on page 242](#)).
- Update: Datalogger shows profile and PLP number for DVB-T2 channels (["Datalogger" on page 105](#)).
- Update: The Task Planner can run and stop alarm monitoring (["Task Planner" on page 125](#)).
- Update: The IP by default for the meter to connect via Ethernet using webControl or Netupdate is 10.8.8.188 (for previous firmware versions it was 10.0.6.198) (["Settings and Remote Access" on page 156](#)).
- Update: TV 3/3 screen show more service features (["? TV + SERVICE DATA \(TV 3/3\)" on page 69](#)).
- Update: Compatible with standard DCII (["? DCII \(DigiCipher 2\)" on page 204](#)).
- Update: Last spectrum settings recovered after switching on (["?Advanced Menu in Spectrum Analyzer Mode:" on page 56](#)).
- Update: Improvement of Optical option annex (["OPTICAL OPTION" on page 213](#)).
- Update: New section "LTE Signals" (["LTE Signals" on page 76](#)).
- Update: New annex for RACK models (["RACK OPTION" on page 248](#)).
- Update: Code Rate DVB-S2 Specifications (["? DVB-S2" on page 203](#)).
- Update: Boot screen option removed (on Preferences/Appearance).
- Updated: It allows disable LNB when short-circuit (["?LNB Drain \(available for terrestrial and satellite band\)" on page 37](#)).
- Updated: Frequency marker displays values until Hz.
- Updated: In Signal Monitoring/Coverage user can start even if signal is unlocked.
- Updated: In Signal Monitoring/Coverage shows the file name on screen.

- Updated: In Signal Monitoring/Coverage by channel plan the “span time” setting has been removed.
- Improvement: Joystick section ([“Joystick” on page 29](#)).
- Improvement: Specific chapter for TOOLS ([“TOOLS” on page 78](#)).
- New option: Signal Monitoring for Channel plan ([“Signal Monitoring” on page 97](#)).
- Improvement: WiFi chapter ([“WIFI MONITORING” on page 137](#)).
- Improvement: Ethernet Port ([“Ethernet Port” on page 188](#)).
- Improvement: Specifications unified for all models ([“SPECIFICATIONS RANGER Neo Lite / +” on page 198](#)).
- Improvement: Additional Information Annex ([“ADDITIONAL INFORMATION” on page 252](#)).
- Improvement: Index by keywords ([“INDEX” on page 254](#)).
- Others: Other minor updates and improvements.

## SAFETY RULES

- \* **The safety could not be assured if the instructions for use are not closely followed.**
- \* Use this equipment **connected only to systems with their negative of measurement connected to ground potential.**
- \* The **AL-103** external DC charger is a **Class I** equipment, for safety reasons plug it to a supply line with the corresponding **ground terminal**.
- \* This equipment can be used in **Overvoltage Category I** installations and **Pollution Degree 2** environments.
- \* External DC charger can be used in **Overvoltage Category II**, installation and **Pollution Degree 1** environments.
- \* When using some of the following accessories use only the specified ones to ensure safety:
  - Rechargeable battery
  - External DC charger
  - Car lighter charger cable
  - Power cord
- \* Observe all **specified ratings** both of supply and measurement.
- \* Remember that voltages higher than **70 V DC** or **33 V AC rms** are dangerous.
- \* Use this instrument under the **specified environmental conditions**.
- \* When using the power adaptor, the **negative of measurement** is at ground potential.
- \* **Do not obstruct the ventilation system of the instrument.**
- \* Use for the signal inputs/outputs, specially when working with high levels, appropriate low radiation cables.
- \* Follow the cleaning instructions described in the Maintenance paragraph.

## SAFETY SYMBOLS

|   |                        |   |  |
|---|------------------------|---|--|
|  | DIRECT CURRENT         |  | ON (Supply)                                |
|  | ALTERNATING CURRENT    |  | OFF (Supply)                               |
|  | DIRECT AND ALTERNATING |  | DOUBLE INSULATION<br>(Class II protection) |
|  | GROUND TERMINAL        |  | CAUTION<br>(Risk of electric shock)        |
|  | PROTECTIVE CONDUCTOR   |  | CAUTION REFER TO MANUAL                    |
|  | FRAME TERMINAL         |  | FUSE                                       |
|  | EQUIPOTENTIALITY       |  | EQUIPMENT OR COMPONENT<br>TO BE RECYCLED   |

## DESCRIPTIVE EXAMPLES OF OVER-VOLTAGE CATEGORIES

- \* **Cat I**: Low voltage installations isolated from the mains.
- \* **Cat II**: Portable domestic installations.
- \* **Cat III**: Fixed domestic installations.
- \* **Cat IV**: Industrial installations.

**CAUTION:** The battery used can present danger of fire or chemical burn if it is severely mistreat. Do not disassembly, cremate or heat the battery above 100 °C under no circumstances.

## TABLE OF CONTENTS

|  |            |
|--|------------|
| <b>1. INTRODUCTION .....</b>                     | <b>1</b>   |
| 1.1. Description .....                           | 1          |
| <b>2. SETTING UP .....</b>                       | <b>3</b>   |
| 2.1. Package Content .....                       | 3          |
| 2.2. Power .....                                 | 3          |
| 2.3. Equipment Details .....                     | 7          |
| 2.4. Switching On/Off .....                      | 13         |
| 2.6. Screen Icons and Dialog Boxes .....         | 14         |
| 2.5. Reset .....                                 | 14         |
| 2.7. Menu Tree .....                             | 15         |
| 2.8. Controls .....                              | 20         |
| <b>3. SETTINGS AND PREFERENCES .....</b>         | <b>35</b>  |
| 3.1. Settings Menu .....                         | 35         |
| 3.2. Video & Audio Settings .....                | 38         |
| 3.3. Preferences Menu .....                      | 39         |
| <b>4. RF SIGNAL TUNING .....</b>                 | <b>47</b>  |
| 4.1. Introduction .....                          | 47         |
| 4.2. Operation .....                             | 47         |
| 4.3. General Menu Options .....                  | 48         |
| 4.4. Advanced Options .....                      | 56         |
| 4.5. Screen Description .....                    | 58         |
| 4.6. Additional Functions .....                  | 73         |
| <b>5. TOOLS .....</b>                            | <b>78</b>  |
| 5.1. Introduction .....                          | 78         |
| 5.2. Constellation .....                         | 79         |
| 5.3. LTE Ingress Test .....                      | 82         |
| 5.4. Echoes .....                                | 85         |
| 5.5. MER by Carrier .....                        | 87         |
| 5.6. MEROGRAM .....                              | 89         |
| 5.7. Spectrogram .....                           | 91         |
| 5.8. Attenuation Test .....                      | 94         |
| 5.9. Signal Monitoring .....                     | 97         |
| 5.10. Datalogger .....                           | 105        |
| 5.11. Screen and Data Capture (Export key) ..... | 113        |
| 5.12. Explore Channel Plan .....                 | 115        |
| 5.13. Discover FM Stations .....                 | 118        |
| 5.14. Field Strength .....                       | 120        |
| 5.15. Task Planner .....                         | 125        |
| 5.16. Shoulders Attenuation .....                | 129        |
| 5.17. Service Recording .....                    | 130        |
| 5.18. Tilt .....                                 | 132        |
| 5.19. Scan .....                                 | 134        |
| 5.20. Streaming V/A .....                        | 135        |
| <b>6. WIFI MONITORING .....</b>                  | <b>137</b> |
| 6.1. Introduction .....                          | 137        |
| 6.2. Operation .....                             | 137        |
| 6.3. WiFi Access Point Connect .....             | 138        |
| 6.4. WiFi Spectrum .....                         | 138        |
| 6.5. Site Survey .....                           | 142        |



|   |            |
|---|------------|
| <b>7. OTT</b>                                     | <b>145</b> |
| 7.1. Introduction                                 | 145        |
| 7.2. Operation                                    | 145        |
| 7.3. Screen Description                           | 146        |
| <b>8. INSTALLATIONS MANAGEMENT</b>                | <b>149</b> |
| 8.1. Introduction                                 | 149        |
| 8.2. Operation                                    | 149        |
| 8.3. Installation Management                      | 150        |
| 8.4. New Installation                             | 153        |
| 8.5. Tools  | 153        |
| 8.6. Importing Data from USB                      | 154        |
| <b>9. WEBCONTROL</b>                              | <b>156</b> |
| 9.1. Introduction                                 | 156        |
| 9.2. Settings and Remote Access                   | 156        |
| 9.3. Measurements and Spectrum                    | 159        |
| 9.4. TV Parameters                                | 161        |
| 9.5. Remote Console                               | 162        |
| 9.6. Monitoring                                   | 164        |
| 9.7. Historical Monitoring                        | 174        |
| 9.8. Installations Management                     | 178        |
| 9.9. Task Management                              | 183        |
| <b>10. CONNECTING TO EXTERNAL DEVICES</b>         | <b>186</b> |
| 10.1. Introduction                                | 186        |
| 10.2. USB Port                                    | 186        |
| 10.3. Ethernet Port                               | 188        |
| 10.4. HDMI Port                                   | 191        |
| 10.5. Input Jack Connector                        | 192        |
| 10.6. RF Connector                                | 193        |
| <b>11. SPECIFICATIONS RANGER Neo Lite / +</b>     | <b>198</b> |
| 11.1. General                                     | 198        |
| 11.2. Measurement Mode                            | 201        |
| 11.3. Spectrum Analyzer Mode                      | 204        |
| 11.5. WiFi Analyzer Mode 2.4 GHz                  | 207        |
| 11.4. TV Mode                                     | 207        |
| 11.6. Tools                                       | 208        |
| 11.7. Options                                     | 209        |
| <b>12. MAINTENANCE</b>                            | <b>211</b> |
| 12.1. Instructions for Returning by Mail          | 211        |
| 12.2. Considerations about the Screen             | 211        |
| 12.3. Cleaning Recommendations                    | 211        |
| <b>i. OPTICAL OPTION</b>                          | <b>213</b> |
| <b>ii. WIFI 5 GHz+LTE 2.6 GHz+RF 6 GHz OPTION</b> | <b>226</b> |
| <b>iii. SIGNAL COVERAGE OPTION</b>                | <b>231</b> |
| <b>iv. DAB/DAB+ OPTION</b>                        | <b>242</b> |
| <b>v. RACK OPTION</b>                             | <b>248</b> |
| <b>vi. ADDITIONAL INFORMATION</b>                 | <b>252</b> |
| <b>vii. INDEX</b>                                 | <b>254</b> |



# TV AND SATELLITE ANALYZER

## RANGER *Neo* Lite

## RANGER *Neo* +

### 1 INTRODUCTION

#### 1.1 Description

The new **RANGER *Neo*** is the seventh generation of field meters that **PROMAX** launches. As each new generation, it represents an evolution from the previous, since it integrates the latest technological innovations and develops applications for the new demands and needs that have emerged in recent years.

The new **RANGER *Neo*** has been created with the aim to make easy the user experience. From its ergonomic design and stylized lines to the reduction of keys and the easy use of its interface, everything has been designed so the user has a simple tool to use but powerful and useful.

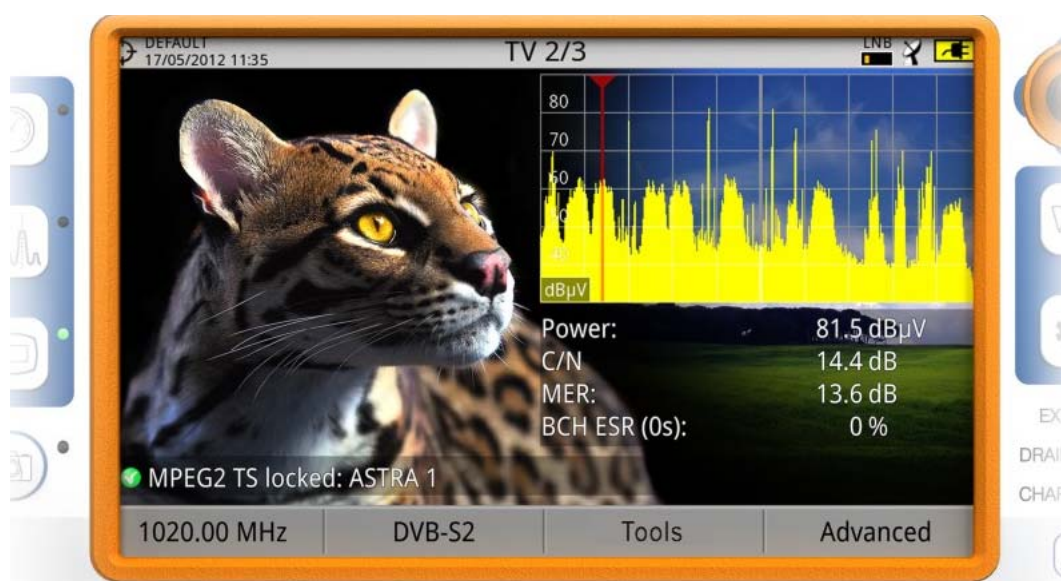

Figure 1.

The **RANGER *Neo*** is a universal analyzer that covers several of the most popular standards of the DVB family, as well as formats such as MPEG-2, MPEG-4, HEVC... and Dolby audio.

Besides the basic functions of TV meter and spectrum analyzer for terrestrial and satellite band, it provides additional tools, such as the detection of LTE signal interferences (some of its working frequencies are close to the TV bands), the diagrams constellations or the echoes detection.



The **RANGER Neo** has an application to manage data generated at each installation. This feature helps the user to manage information generated so he can access it at any time or download it to a PC for further analysis.

The **RANGER Neo +** has some extra tools such as Spectrogram, web remote control, spectrogram, MER by carrier, merogram and others than differ from the **RANGER Neo Lite**. The **RANGER Neo +** in addition can be expanded with several modules: GPS for mobile measurement, DAB for digital radio measurement, Fibre Optics and WiFi 5G+RF 6 GHz+LTE 2.6 GHz (for more details about expansion modules see annex).

In an effort to facilitate its work to professionals, our long experience ensures an after sales quality service, which includes software updates and upgrades for free.

The **RANGER Neo** has been designed and developed entirely in the European Union. A multidisciplinary team of highly qualified professionals has dedicated effort and commitment to the development of a powerful, efficient and reliable tool. During the manufacturing process, all used materials have been subjected to a strict quality control.



Figure 2.



Click here to watch this video: [Introducing the RANGER Neo](#)



## 2 SETTING UP

### 2.1 Package Content

Check that your package contains the following elements:

- RANGER *Neo* Analyzer.
- External DC charger.
- Mains cord for external DC charger.
- Car lighter charger.
- Dual WiFi Antenna.
- USB WiFi Adapter.
- Aero SMA-H/BNC-M adapter.
- "F" adapters:
  - "F"/f - BNC/f adapter.
  - "F"/f - DIN/f adapter.
  - "F"/f - "F"/f adapter.
- Support belt and carrying bag.
- 4V/RCA Jack Cable.
- USB (A) - USB (A) cable.
- Monopod.
- Transport suitcase\* .
- Quick Start Guide.

**NOTE:** Keep the original packaging, since it is specially designed to protect the equipment. You may need it in the future to send the analyzer to be calibrated.

### 2.2 Power

The RANGER *Neo* is powered by a 7.2 V built-in rechargeable Li-Ion battery of high quality and long operation time.

---

\*. only available for RANGER *Neo* +



This equipment can operate on battery or connected to the mains using a DC adapter. An adapter is also supplied to use with the power connector car (cigarette lighter).

### 2.2.1 First Charge

The equipment comes with the battery half charged. Depending on the time elapsed from first charge and environmental conditions may have lost some of the charge. You should check the battery level. It is advisable a first full charge.

### 2.2.2 Charging the Battery

Connect the DC power adapter to the equipment through the power connector on the side panel (see figure).

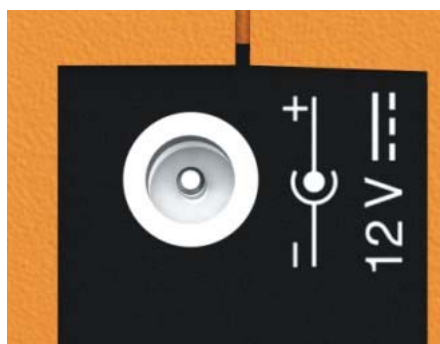

**Figure 3.**

Then connect the DC power adapter to the mains via the mains cord. Ensure that your mains voltage is compatible with the adapter voltage.

For a **fast** charging is necessary to switch off the equipment.

If the equipment is ON, the battery charge will be slower, depending on the type of work you are doing. When connecting the equipment to the mains the mains connected symbol  appears inside the battery icon.

The CHARGER led indicator shows the battery status:

- **Yellow:** Battery charging.
- **Green:** Battery full charge.
- **Blinking:** Battery not detected.
- **Off:** Battery is not charging.



When switching on the equipment, the battery voltage is checked. If the tension is too weak to start, the LED EXT\* and DRAIN\*\* flashes and the equipment does not start up. In this case please charge the battery immediately.

### 2.2.3 Charge / Discharge Times

Average charging time with the equipment off (fast charge):

- 3 hours to achieve an 80% charge.
- 5 hours to achieve a 100% charge.

With the equipment on (slow charge):

- 5 hours to achieve an 80% charge.
- 8 hours to achieve a 100% charge.

#### ► RANGER *Neo* Lite

Average discharge time (with external supply disabled):

- With the battery full charge the average battery time is 3 hours.
- With the battery at 80% charge the average battery time is 2 h.

#### ► RANGER *Neo* +

Average discharge time (with external supply disabled):

- With the battery full charge the average battery time is 5:30 hours.
- With the battery at 80% charge the average battery time is 4 h.

### 2.2.4 Energy Saving

These options are available in the **Preferences** menu, pressing the key  for 1 s.

- **Power Off:** It allows the user to select the time to power off, which is the time after which the equipment shuts down automatically unless pressing any key.

---

\*.only available for RANGER *Neo* +

\*\*only available for RANGER *Neo* +



- **TFT Screen:** User can select a time after which the TFT screen turns off, but the equipment is still running normally. The equipment can measure (for example, making a datalogger or channel exploration) and the battery will last longer, about 10% more. The screen turns on by pressing any key. Time options are: off, 1, 5, 10 or 30 minutes.

### 2.2.5 Smart Control Battery\*

\*. only available for **RANGER *Neo* +**

The built-in battery of the equipment is of the "**smart**" type, which means that reports its state of charge. This information is displayed inside the battery icon in the form of the average time available. In this way the user can know at any time the remaining battery level.

The remaining time charge that appears is calculated according to the work that has been doing. If you activate the external supply of the equipment, the average time would be reduced according to the increase in consumption that occurs.

### 2.2.6 Usage Tips

The battery is losing storage capacity as you go through its life. Contact your **PROMAX** distributor when necessary to replace the battery.

To extend battery life the user should follow these tips:

- In case of providing a long inactivity period of the equipment it is advisable to make every 3 months a charge / discharge cycle and a subsequent partial charge (40% aprox.).
- It is advisable to keep it in a cool place and away from heat.
- You should avoid keeping the battery for a long period of time at full load or fully discharged.
- There is not necessary to wait to fully discharge before a charge because these batteries have no memory effect.



## 2.3 Equipment Details

### 2.3.1 RANGER *Neo* Lite



Figure 4. Front View.





Figure 5. Side View.



Figure 6. Top View.



2.3.2 RANGER *Neo* +



Figure 7. Front View.



**Figure 8. Side View.**



Figure 9. Top View (for Optical Option refer to annex).



## 2.4 Switching On/Off

### ► Switching On:

- 1 Press for a while (approximately one second) the ON/OFF button placed on the side of the equipment.
- 2 The boot screen appears and also a progress bar that indicates the system is loading. At the top left corner it shows the equipment model and release.
- 3 After the system loads, it shows the last status used (mode and screen).

### ► Switching Off by hardware:

- 1 Press the ON/OFF button placed on the side of the equipment:
  - **Short Press (<1 s):** A menu on screen allows the user to select between power off or reboot.
  - **Long Press (>2 s):** The equipment turns off directly.

### ► Switching Off by software:

- 1 Press the Tools key .
- 2 Select the "Power Off" option.

### ► Switching Off by software (Energy save):

- 1 Press the Preferences key  (press 1 s).
- 2 Select the "Appearance" tab.
- 3 The option "**Off**" allows the user to enable the automatic shutdown option. Select a waiting time (time without pressing any key and the meter not working) after which the equipment turns off automatically.

**NOTE:** The shutdown process lasts few seconds, during which it shows the boot screen picture and also a bar showing the shutdown progress.

The equipment keeps its last status (mode and screen) which is recovered when power on.



## 2.5 Reset

How to **RESET**: Hold down the key for 6 seconds and release.

When to **RESET**:

- **When it crashes and does not respond to any key.** Hold down the ON/OFF button for 10 seconds and if the meter does not turn off then RESET.
- **When it does not switch on.** If it does not start after trying turning on by the normal procedure (by pressing the ON/OFF button with the meter connected to the mains) then RESET.
- **When it does not finish the boot process.** Hold down the ON/OFF button for 10 seconds and if the meter does not turn off then RESET.

## 2.6 Screen Icons and Dialog Boxes

On the screen are some icons that provide useful information to the user about the current status of the instrument.

|  |   |  |  |
|--|---|--|--|
|  | Battery charging.   |  | USB flash drive inserted.  |
|  | Battery not charging. Yellow level indicates charge left. |  | WiFi source Signal   |
|  | Battery not charging, time left indicator.                |  | Current installation.  |
|  | Satellite band.   |  | GPS locked.  |
|  |   |  | GPS unlocked.  |
|  | Current voltage, 22 kHz signal and LNB power level.       |  | SATCR (SCD/EN50494) commands enabled.  |
|  | Terrestrial band.   |  | JESS (SCD2/EN50607) commands enabled.  |
|  | Compressed installation.                                  |  | Task scheduled.  |
|  | OK.   |  | Multi-function Joystick enabled. Two-letter code indicates the exact function: |
|  | Searching.  |  | FR Frequency tuning.   |
|  |   |  | CH Channel tuning.   |
|  |   |  | SP Span change.  |
|  |   |  | MK Marker moving.  |
|  |   |  | EC Echo/zoom change.   |
|  | Warning.  |  | AP WiFi Acces Point  |

Figure 10. Icons Table\*



## 2.7 Menu Tree

### ▶ RF Menu

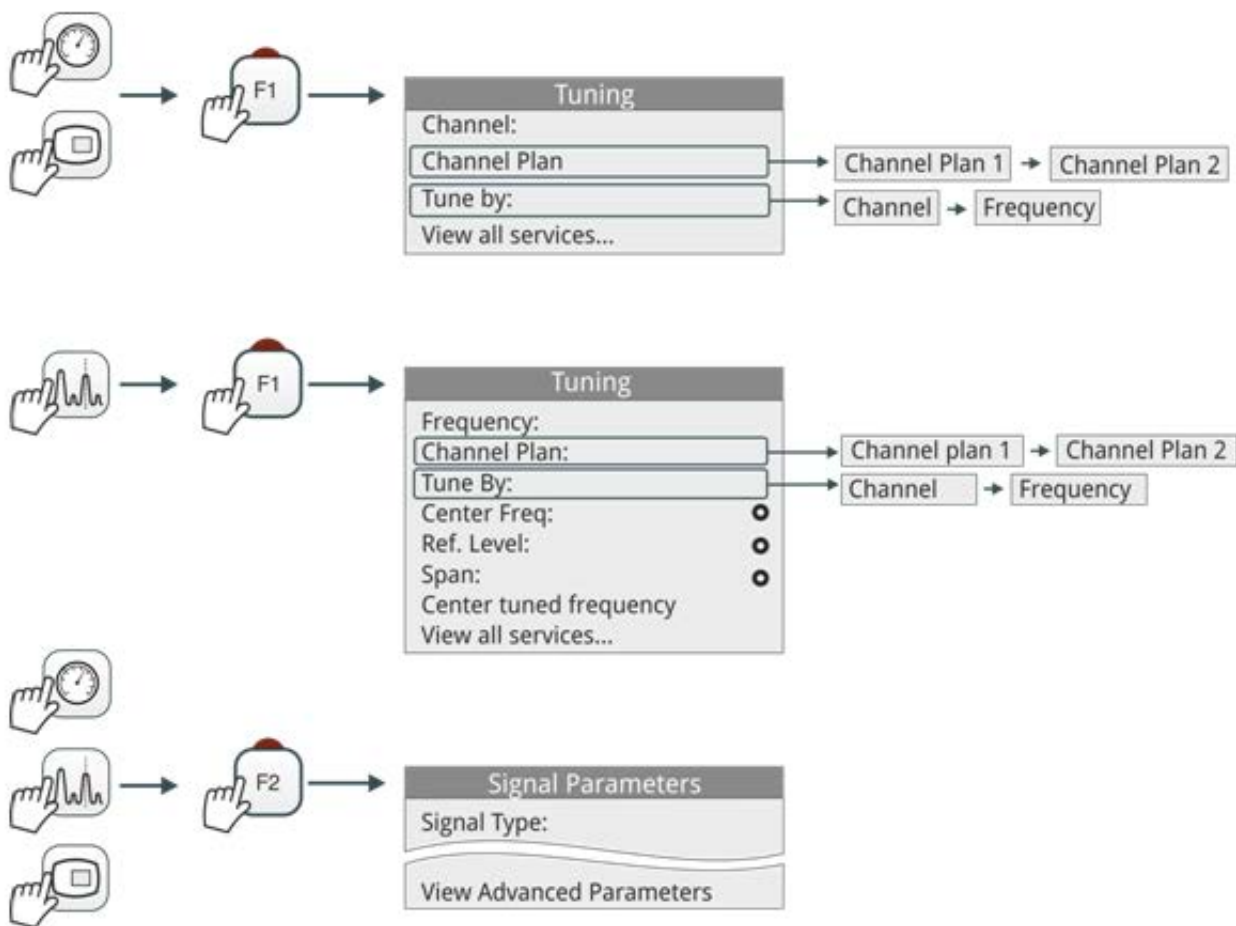

Figure 11. RF Tuning

\*. Some icons are only available for RANGER *Neo* +



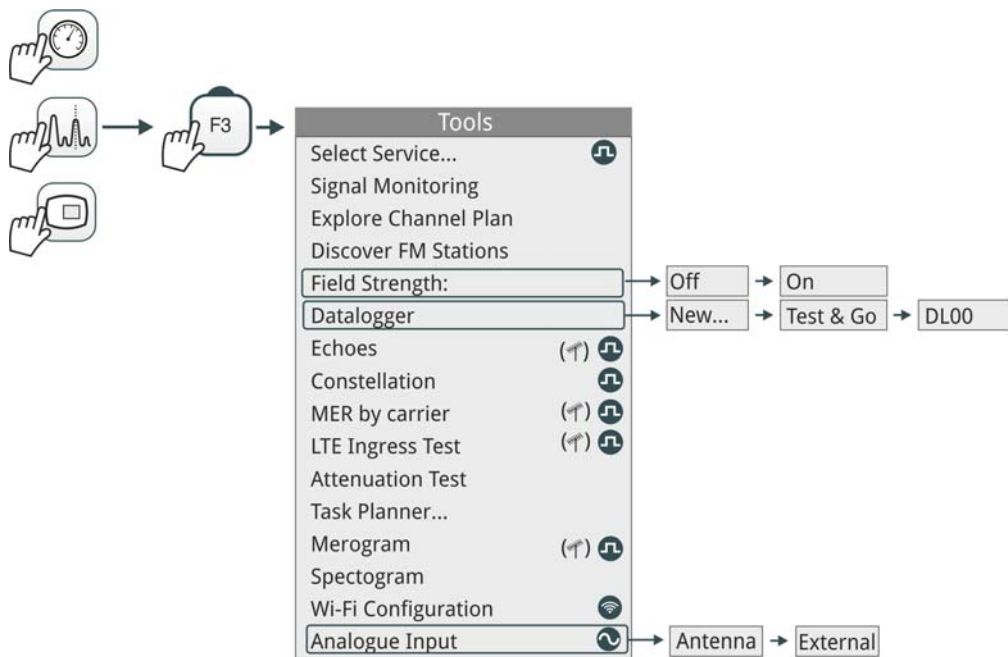

Figure 12. Tools Menu\*

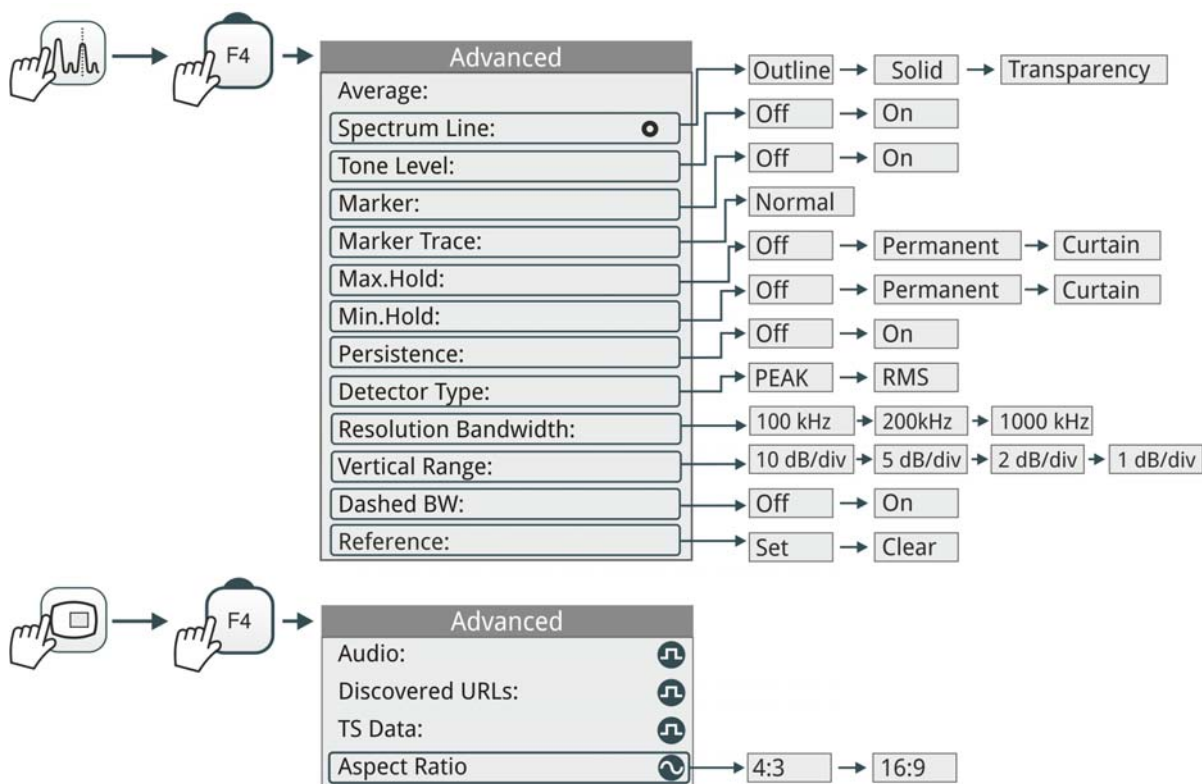

Figure 13. Advanced Menu

\*. some tools are only available for RANGER Neo +



► WiFi Menu

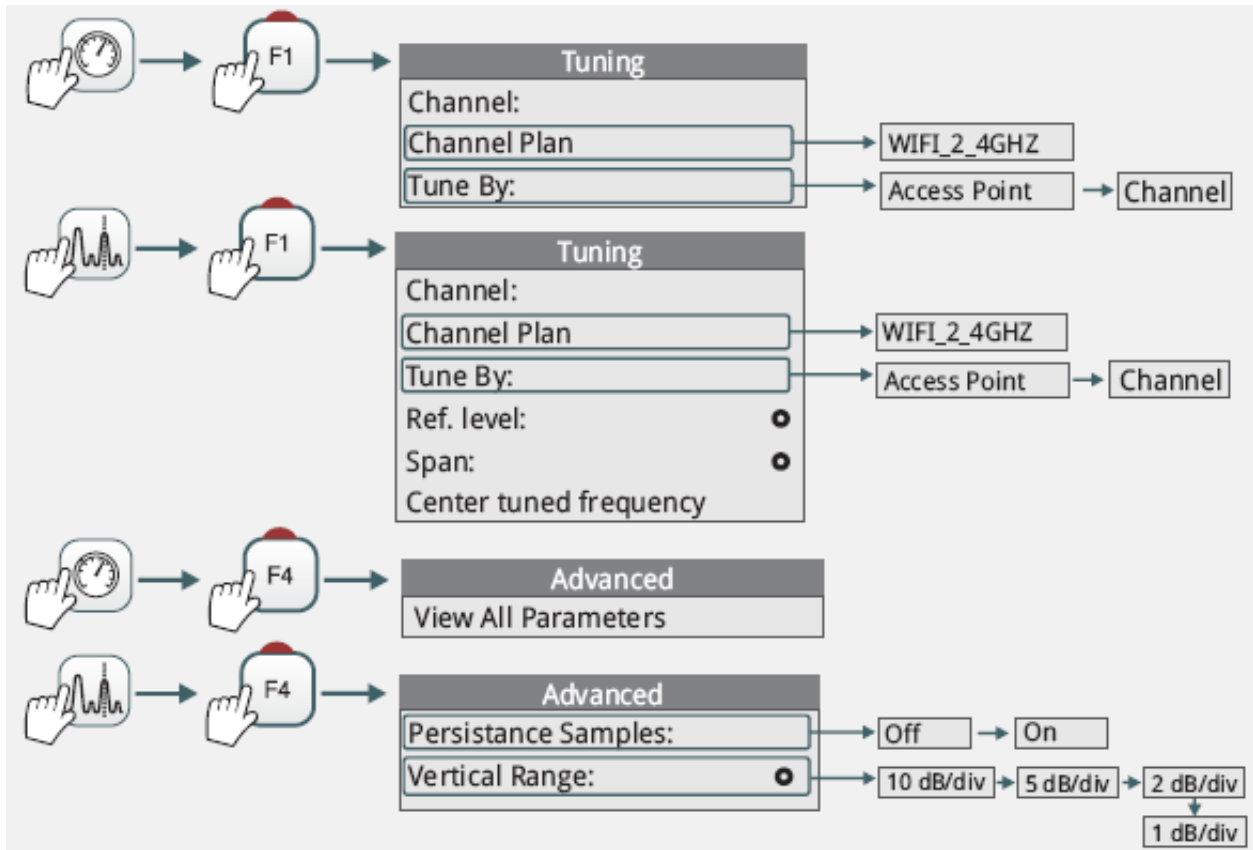

Figure 14.



► Installation Management Menu

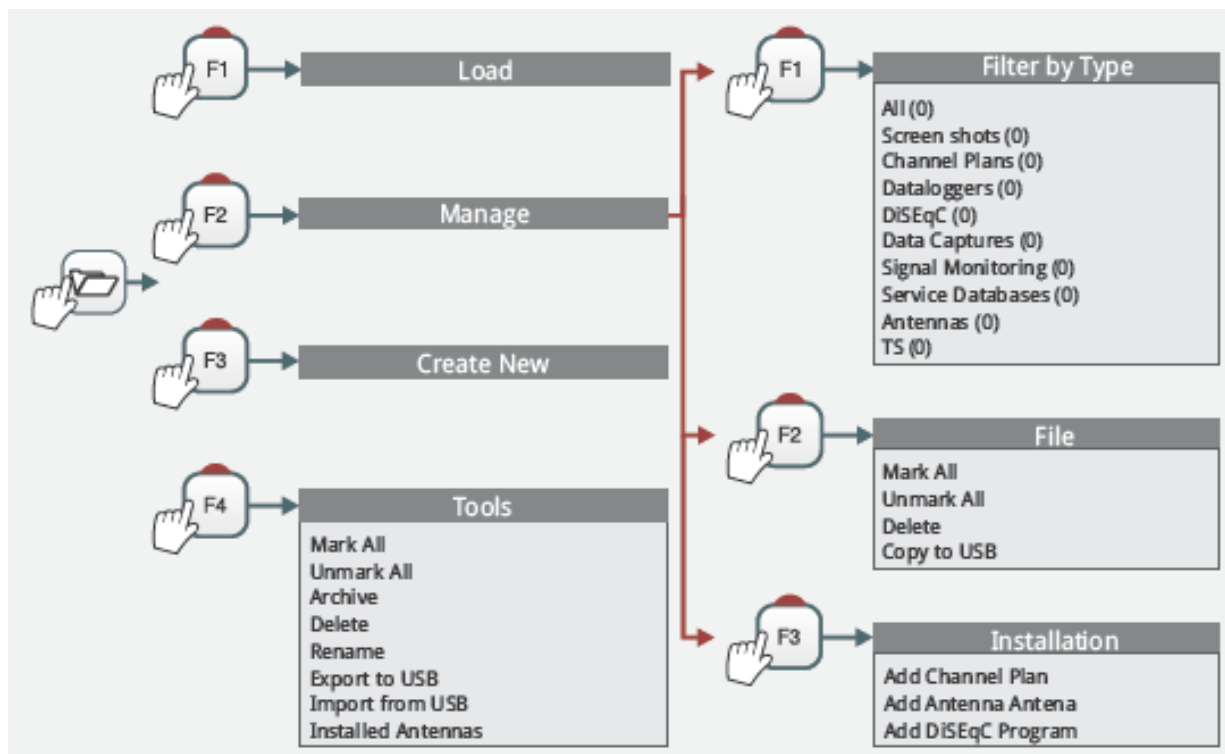

Figure 15.

► Preferences Menu

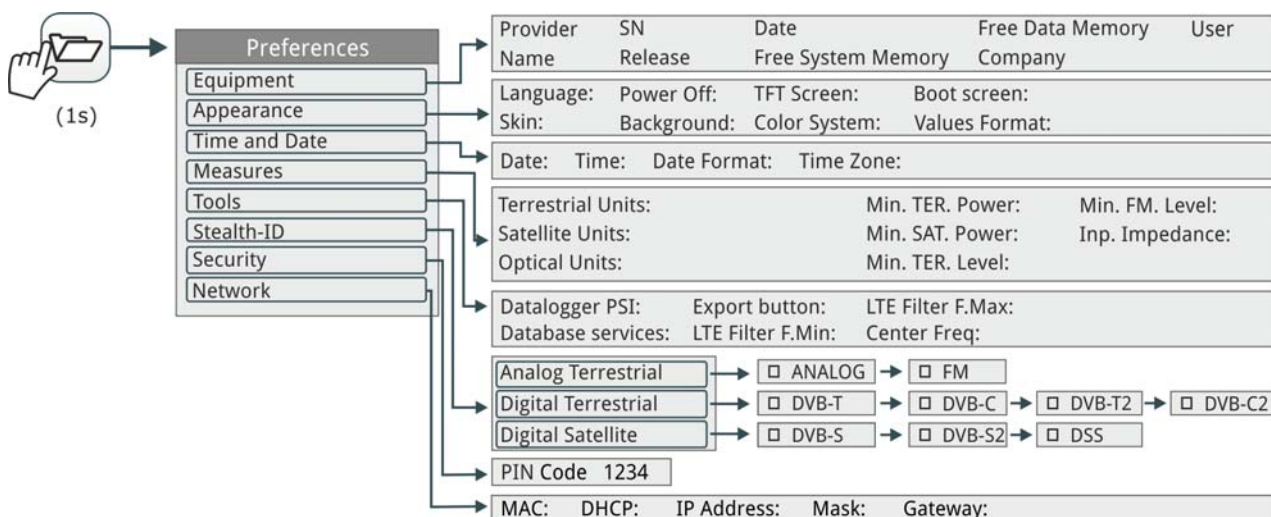

Figure 16.



► Settings Menu

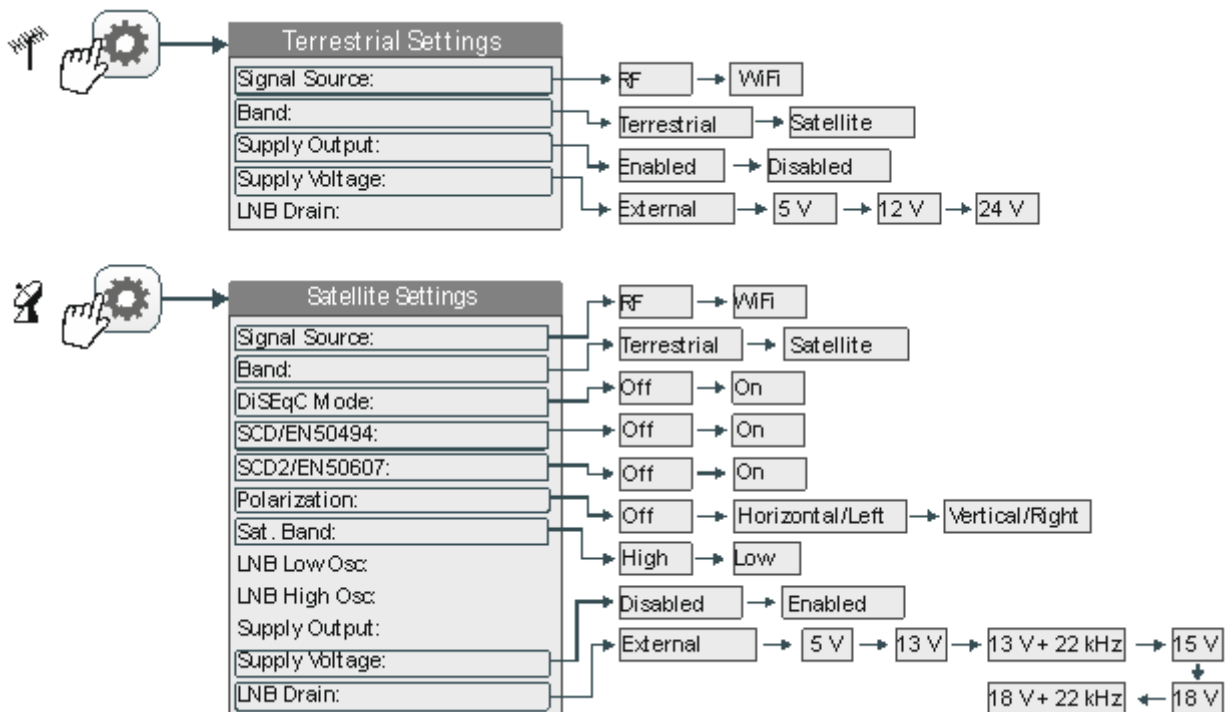

Figure 17.

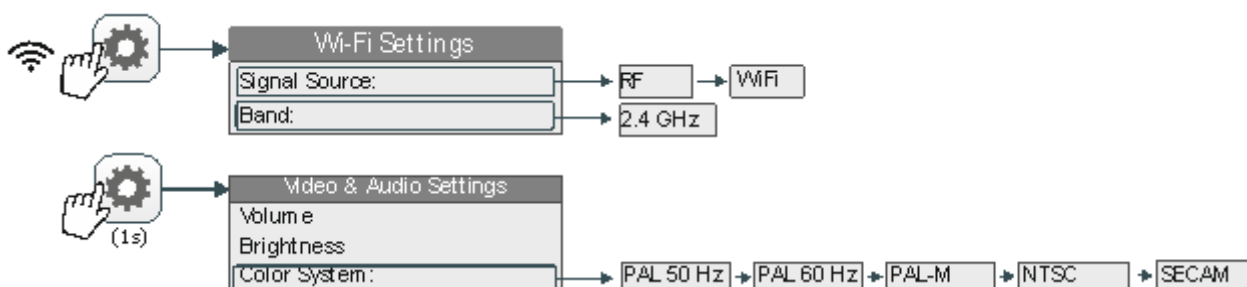

Figure 18.



## 2.8 Controls

The equipment has been designed to be an easy tool to use. For this reason the number of keys has been reduced and they are grouped by function.

The equipment can be fully operated using both the touch panel (even using wearing gloves) and the conventional keyboard. For measurement and navigation through the menus, the equipment has the touch panel, one joystick, 4 function keys (softkeys) and 6 direct access keys (shortcut keys).

The menu navigation includes hints that appear when the cursor is placed on an disabled (grayed) option for a while. These hints help the user to understand why an option is disabled and what to do to enable it.

### 2.8.1 Touch Screen

The control software is designed in such a way that the meter can be fully operated using the touch panel.

These actions can be done through the touch panel:

- Menu Selection.
- Frequency or Channel Selection.
- Frequency or Channel Scroll.
- Virtual Keyboard Writing.
- Toolbar Access.
- Screen Mode Switch.
- Installation Manager Access.
- One-touch zoom-in.



► Menu Selection

User can operate on the menus on screen: drop-down a menu, select an option, accept or exit a message, and so on, just touching on the option.

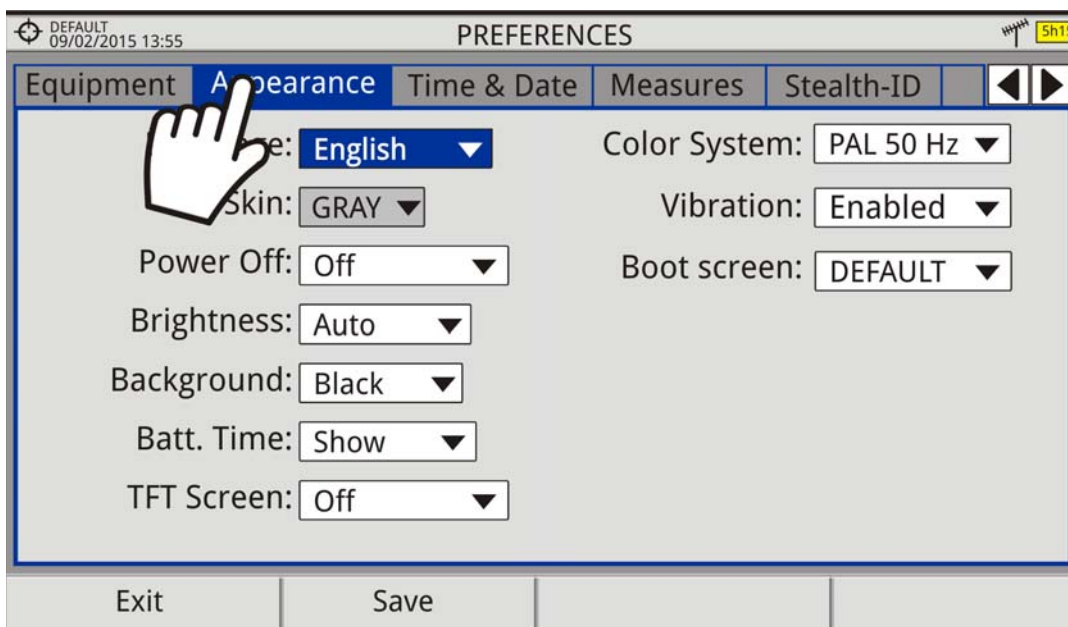

Figure 19.

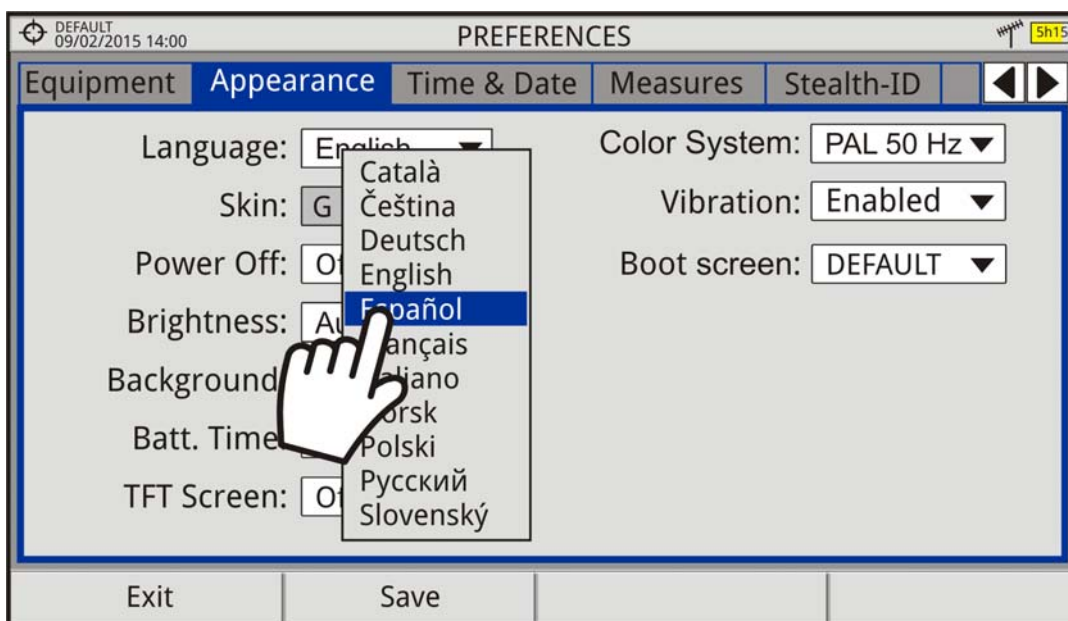

Figure 20.

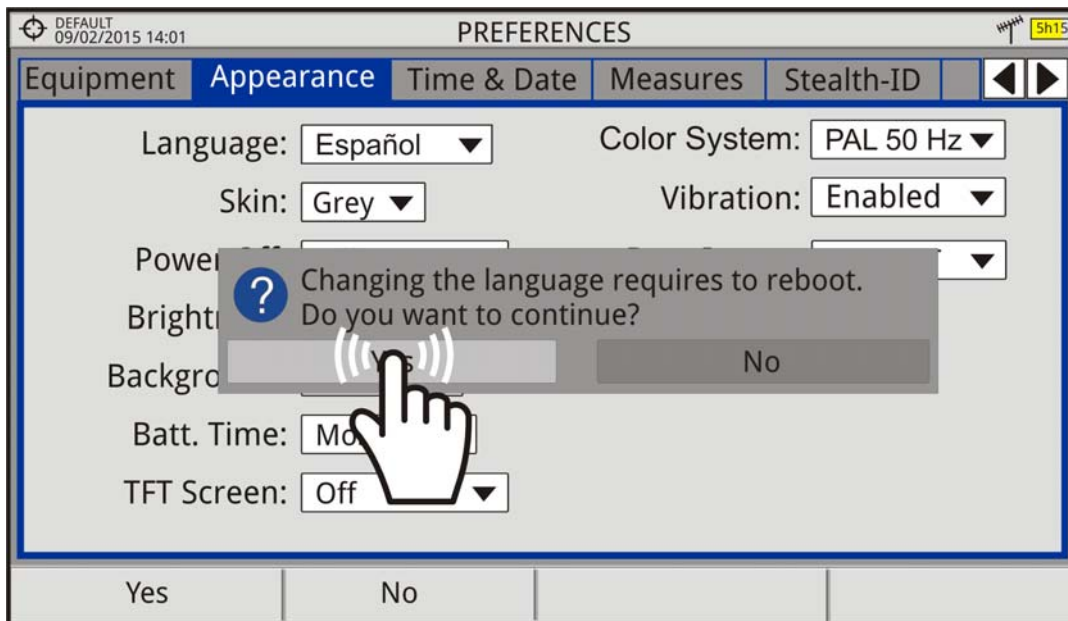

Figure 21.

► Frequency or Channel Selection

At the Spectrum Analyzer mode, user can select a channel or frequency by tapping on the frequency or channel.

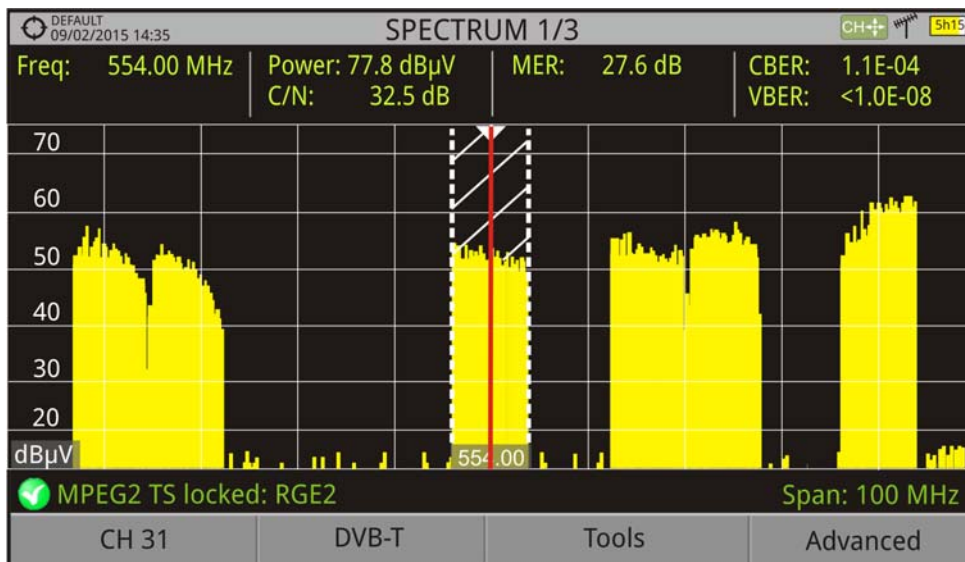

Figure 22. First screen (channel locked).

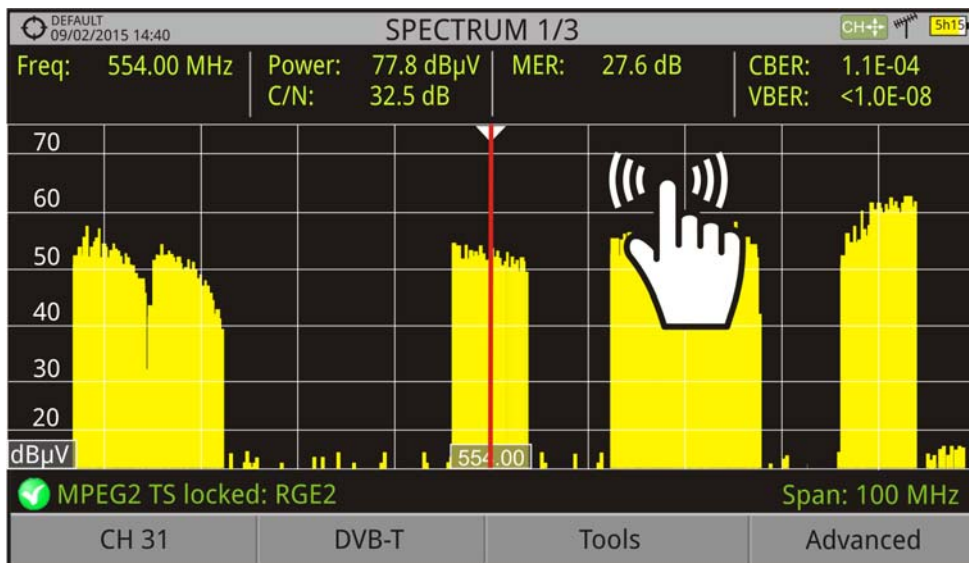

Figure 23. Tap on the new frequency.

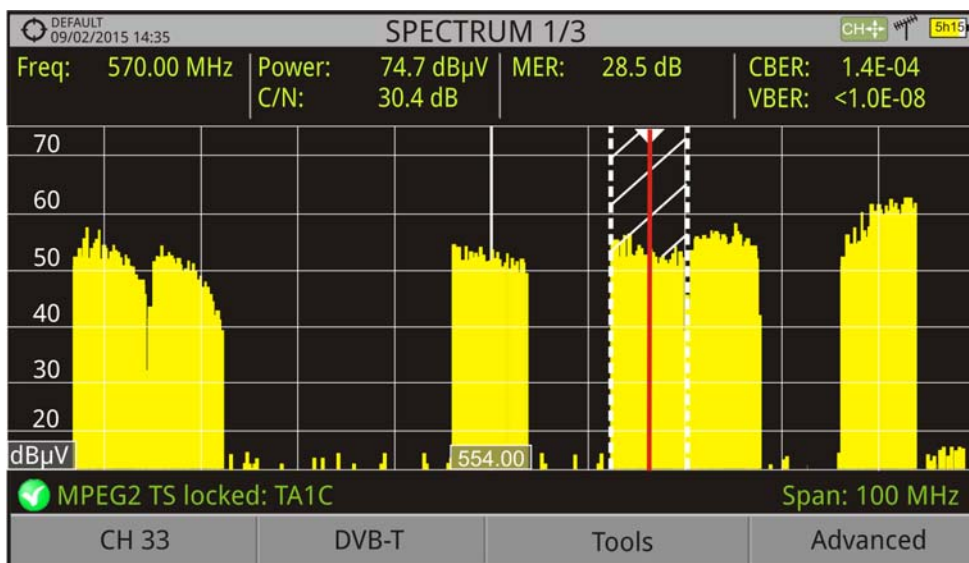

Figure 24. The cursor moves to the frequency.





► Frequency or Channel Scroll

At the Spectrum Analyzer mode, user can scroll through frequency or channels by dragging and dropping his finger on the screen.

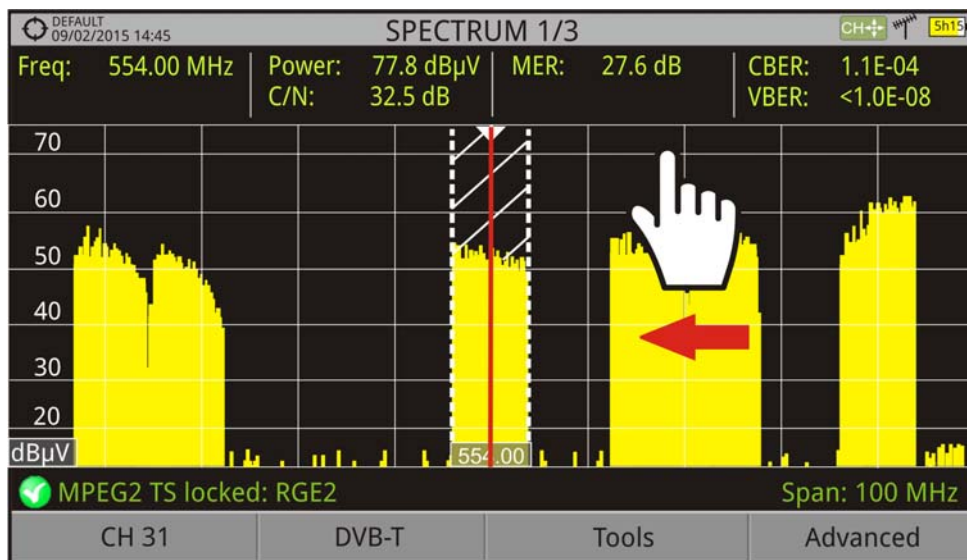

Figure 25.

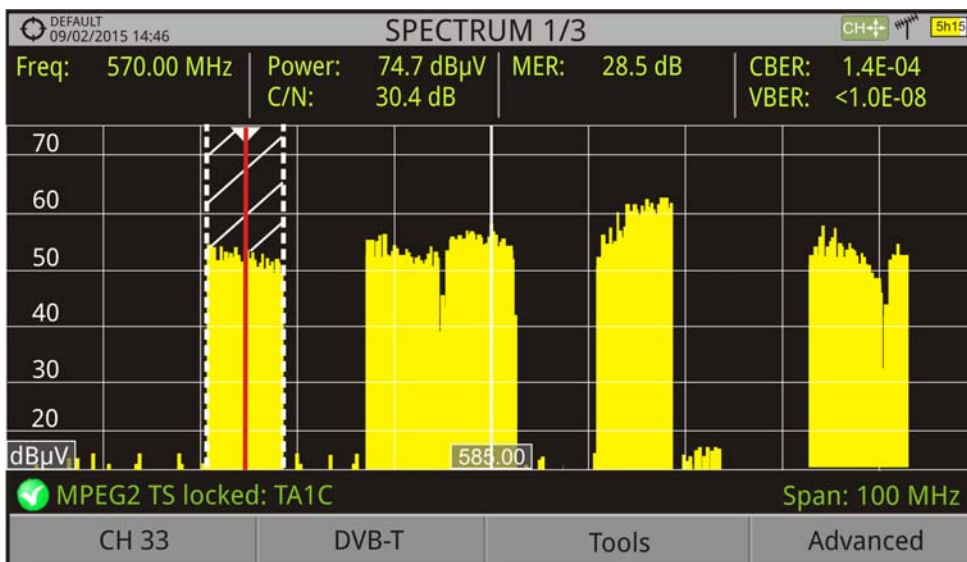

Figure 26.



### ► Virtual keyboard/keypad writing

User can type directly on the on-screen keyboard or keypad.

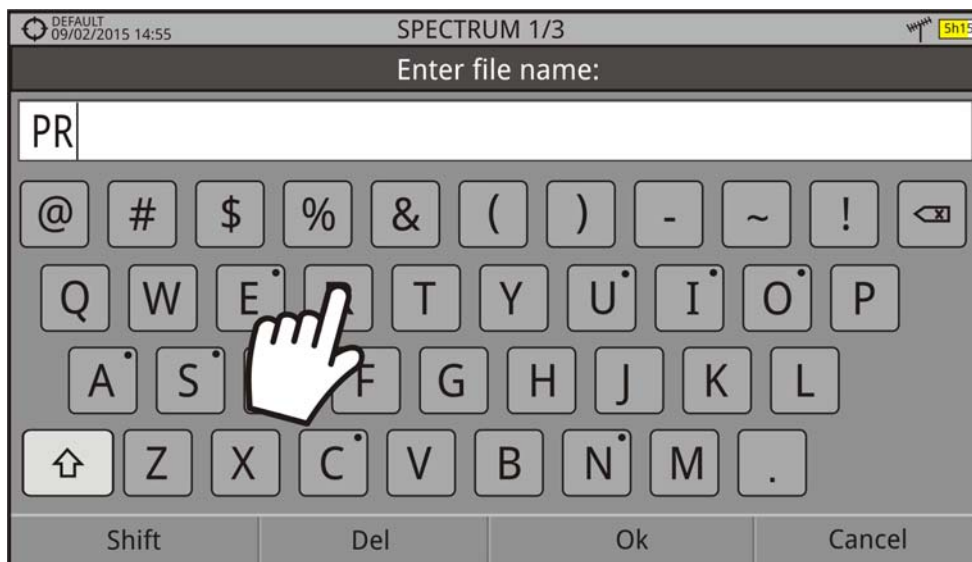

Figure 27.

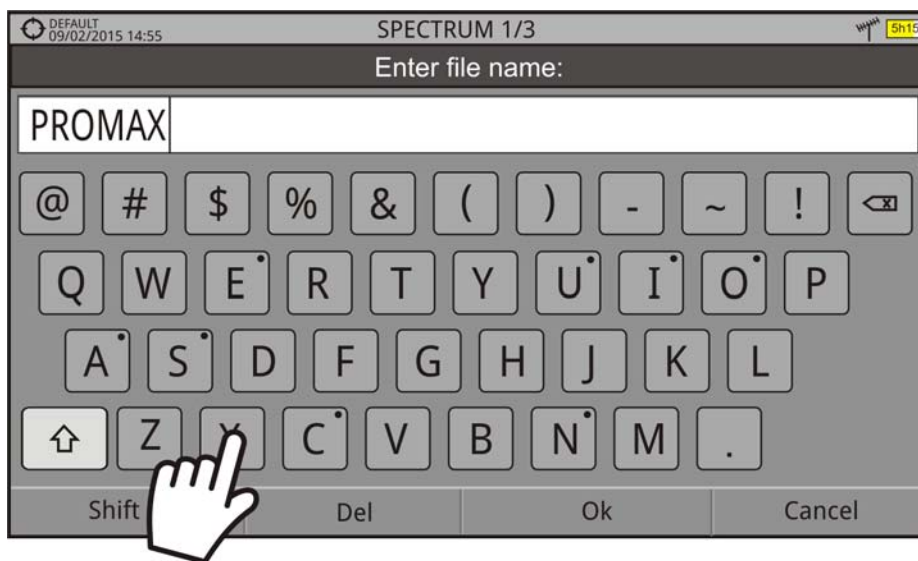

Figure 28.



► **Toolbar Access**

User can access the most important functions through the toolbar by pressing on the right top corner of the screen. It displays a box with several icons to access several functions.

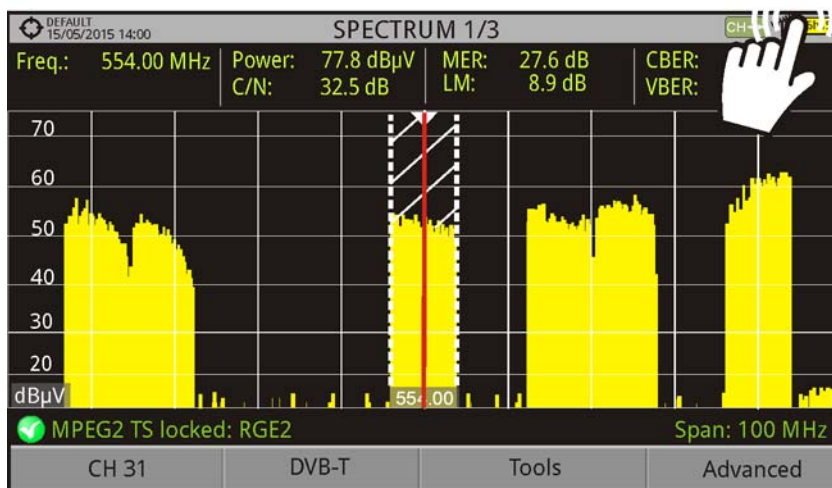

Figure 29.

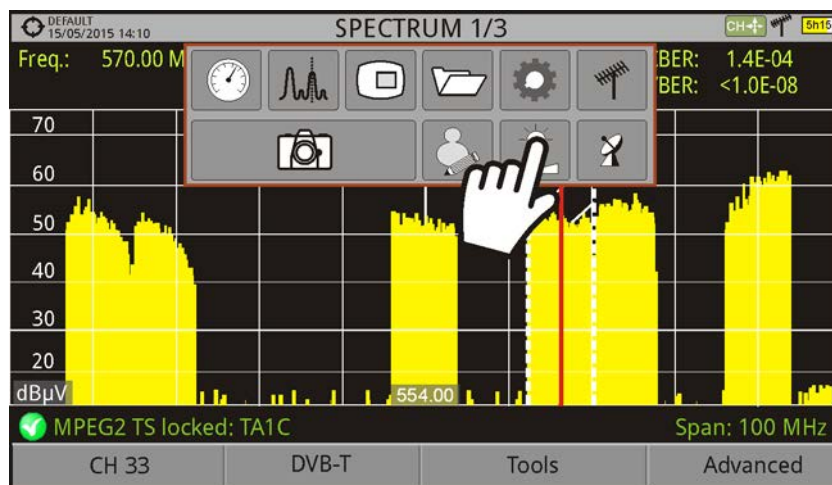

Figure 30.

• **Toolbar**

- Measurement Mode
- Spectrum Analyser Mode
- TV Mode
- Installations Management
- Settings
- Terrestrial Band
- Satellite Band
- Video & Audio Settings
- Preferences
- Screen Capture



► Mode Screens

User can switch the view of the current mode by pressing on the top center of the screen.

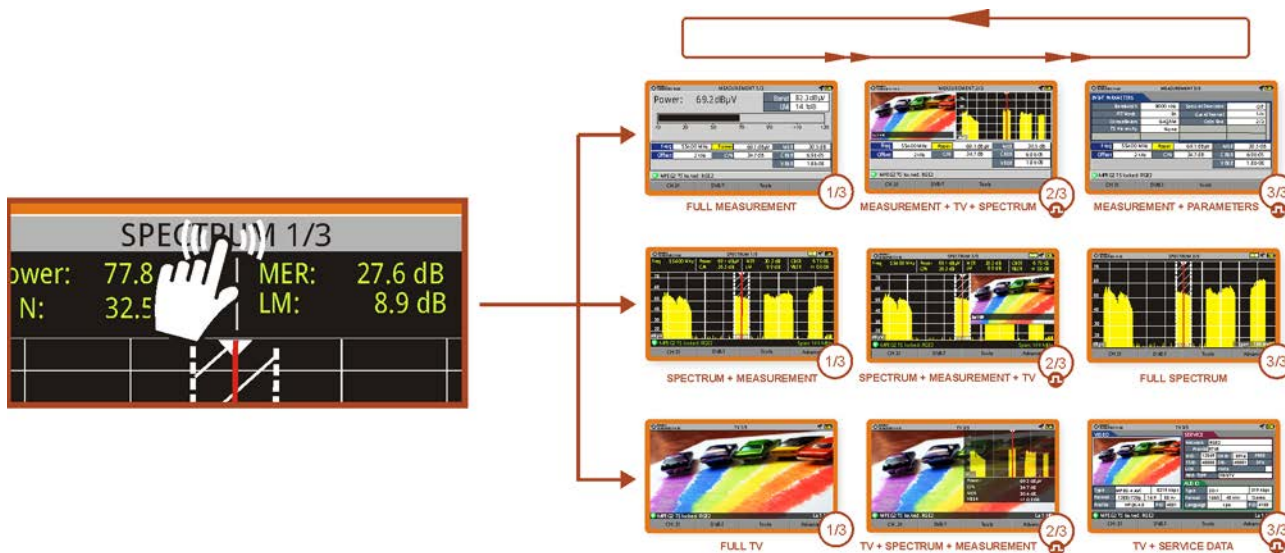

Figure 31.

► Installations Management

User can access data from the current installation by pressing on the left top corner.

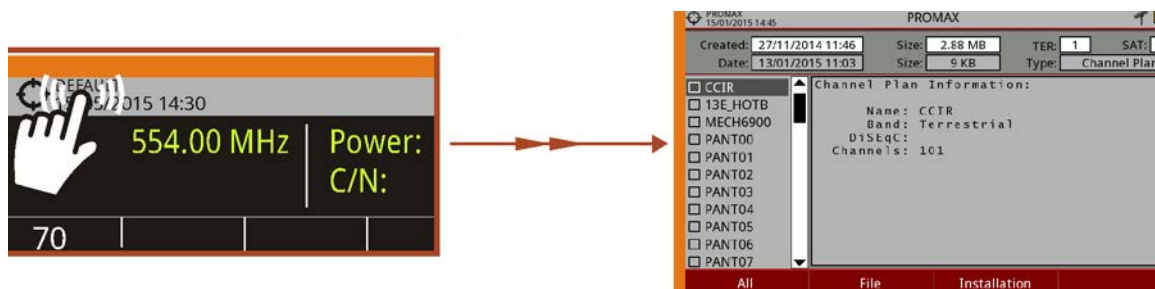

Figure 32.



► One Touch Zoom-in

In a view with different windows (Measurement, Spectrum and / or TV), if the user clicks on one of the windows, he will directly access the corresponding enlarged view.

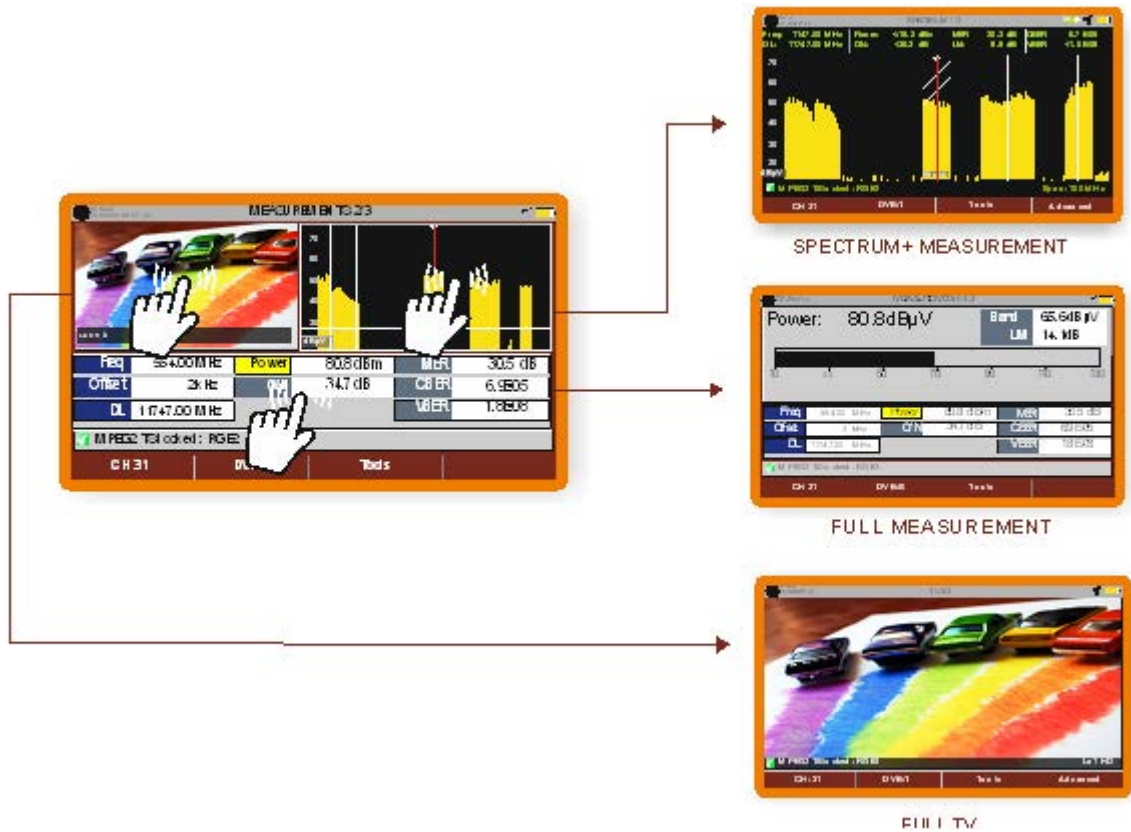

Figure 33.



2.8.2 Joystick

Joystick can make five movements:

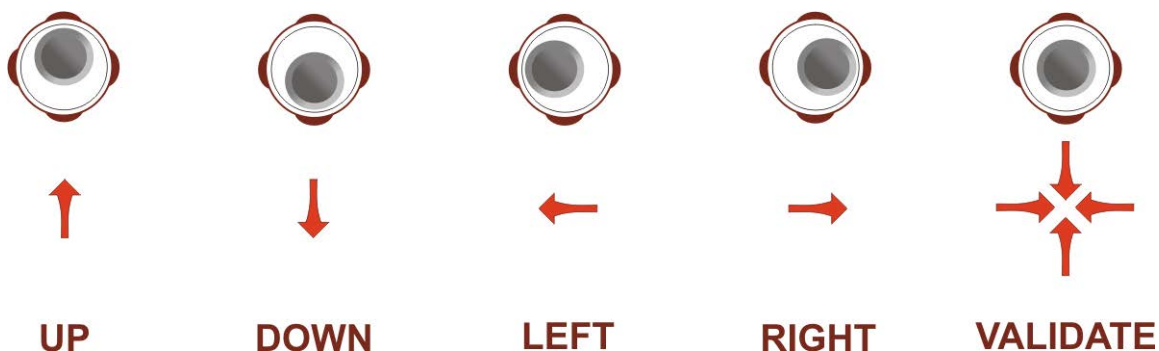

Figure 34.

In some modes or tools, the joystick is multifunctional, that is, each time you press on it (validate), its function changes:

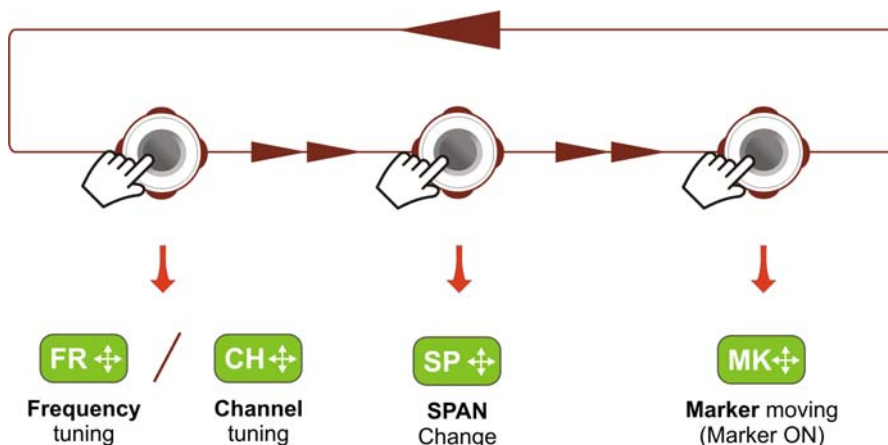

Figure 35. Functions of Joystick in SPECTRUM ANALYZER mode.

The user can see the active function according to the icon that is displayed at the upper right corner of the equipment (see next figure).



**Figure 36. SPAN mode selected**

Also, depending on the screen, the joystick has some specific functions. They are:

► In **MEASUREMENT** mode, the joystick has these functions:

- Left - Right
  - Channel change or frequency change (according to tune selected: tune by channel or tune by frequency).
- Up - Down
  - Change of main measure on screen (screen MEASUREMENT 1/3).

► In **TV** mode, the joystick has these functions:

- Left - Right
  - Channel change or frequency change (according to tune selected: tune by channel or tune by frequency).
- Up - Down
  - Change of TV service.

► In **SPECTRUM ANALYZER** mode, the joystick has these functions:

- Left - Right
  - CH or FR: Channel change (CH) or frequency (FR) change (according to tune selected: tune by channel or tune by frequency).
  - SP: Span change.
  - MK: Marker move (if marker is enabled).
- Up - Down
  - Reference level change.

In Spectrum Analyzer mode, pressing the joystick for 1 second, a box appears explaining the joystick modes available. From here user can also select the joystick mode.

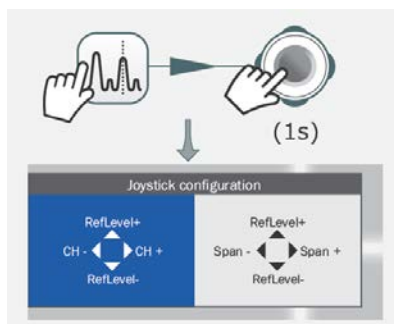

**Figure 37.**

► In **WIFI** mode, the joystick has these functions:

■ Left - Right

- AP or CH: Change of Access Point (AP) or Channel (CH) (according to tune selected: tune by Access Point or tune by Channel).
- SP: Change of Span.

■ Up - Down

- Reference level change.

► In **ECHOES** tool, the joystick has these functions:

■ Left - Right

- CH or FR: Channel (CH) change or frequency (FR) change (according to the tune selected: tune by channel or tune by frequency).
- EC: Echo change.

■ Up - Down

- Distance span.



[Click here to watch this video: Navigating through the menus](#)

### 2.8.3 Select and Edit Parameters

To edit or select any parameters follow these instructions:

- 1 Place over the option and press the joystick.
- 2 The data field gets into the edit mode (yellow background).
- 3 A menu is deployed with some options or if it is numeric, a number gets a black background.







- 4 Move the joystick up/down to select one option. To move between figures press right/left and to change it press up/down.
- 5 After finish press joystick to confirm or any function key to exit.

## 2.8.4 **Shortcut Keys**

### ► **Management Keys**

There are two Management keys. Depending on how long you press these keys, it has two different functions:

- **Installations / Preferences key** 
  - Short Press (<1s): It shows the list of installations and the menus to manage them.
  - Long Press (>1s): It shows the Preferences menu.
- **Tune Settings / Video - Audio Settings** 
  - Short Press (<1s): It shows the Settings menu (menu changes according to signal source selected).
  - Long Press (>1s): It shows the Video & audio settings.

### ► **Screenshot / Reference key**



Depending on how long you press this key, it has two different functions:

- Short Press (<1s): Pressing this key for less than one second on the Spectrum Analyzer mode, it holds on screen the current waveform as a trace or reference. It is equivalent to go to the option "Reference - Set" from the "Advanced" menu. Pressing short again, it deletes the waveform reference. It is equivalent to go to the option "Reference - Clear" in the "Advanced" menu.
- Long Press (>1s): Pressing this key for one second it makes a capture of what it is shown on screen at the time. The capture may be from the screen image, from the measurement data or from both. The type of capture, either screen, data, or both can be set in the "**Export button**" option which is on the label "**Measures**" in the "**Preferences**" menu (for more details refer to ["Screen and Data Capture \(Export key\)" on page 113](#)).



### ► Mode keys



On the left side there are three keys to access the most important modes of the meter.

-  Measurement key.
-  Spectrum Analyzer key.
-  TV Mode key.

The active function on screen is indicated by the LED\* next to the function key.

Pressing on one of these keys repeatedly provides access to a different view within the same function. For analogue signals only the first view of each function is available. Each view name is shown at the top centre of the screen. When reaching the third view it returns to the first view.

## 2.8.5 Function keys or Softkeys

There are four programmable keys, also called softkeys, numbered from  to .

Each key provides access to one menu. This menu changes according to the mode or tool selected.

The menu is displayed over each softkey at the bottom of the screen.

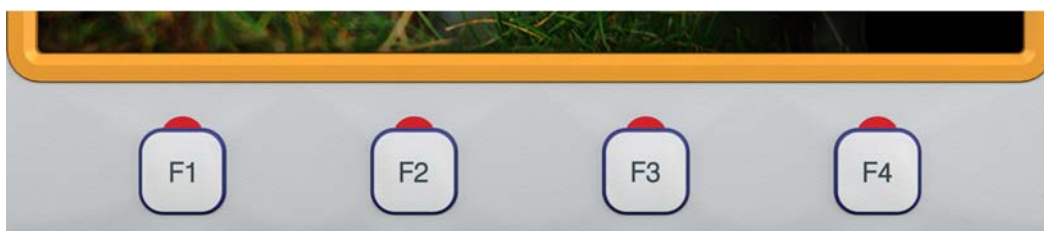

Figure 38.

\*. only available for RANGER *Neo* +



## 2.8.6 Virtual Keyboard

When a user needs to enter or edit a text (from an image, Channel Plan, etc.), a screen with a virtual keyboard appears (see figure).





**Figure 39.**

To edit a word user should follow these steps:

- 1 Place the cursor over the text box where the name appears.
- 2 Move the cursor to place it next to the letter that user wants to edit.
- 3 Press on the virtual keyboard to edit.
- 4 Once edition is finished, press OK (F3) to accept or (F4) to Cancel.

To delete a letter, move the cursor to the right side of the letter and then press the joystick on the Delete key  or press Delete (F2).

To enter an upper case letter press first (F1) or press the joystick on the key . To block upper case press (F1) or press the joystick on the key  twice. To return to lower case press (F1) or the key  again.

Keys with a point at top right corner give access to special characters, by keeping pressed the joystick for one second on the key.



### 3 SETTINGS AND PREFERENCES

#### 3.1 Settings Menu

Press the **Settings** key to access the settings menu. Depending on the signal source, the menu may be different.

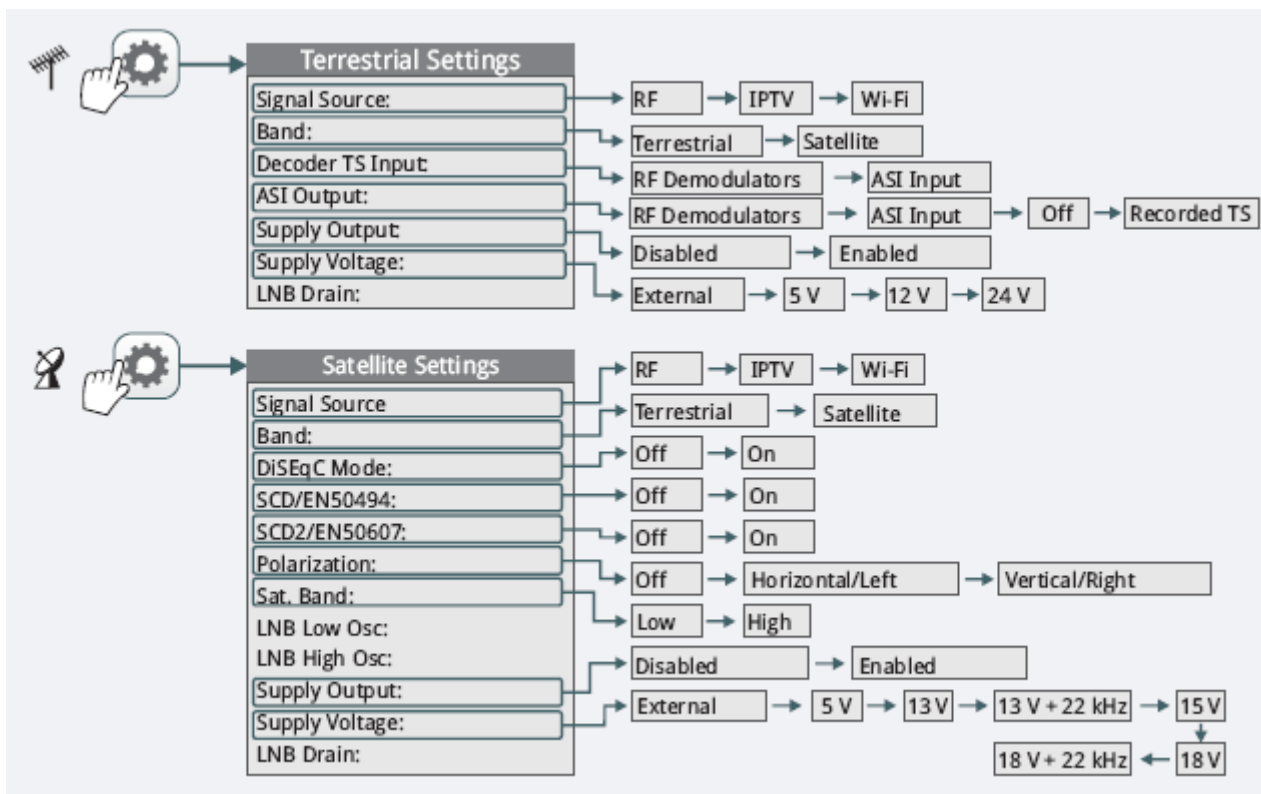

Figure 40. Settings for RF (Terrestrial and Satellite band)

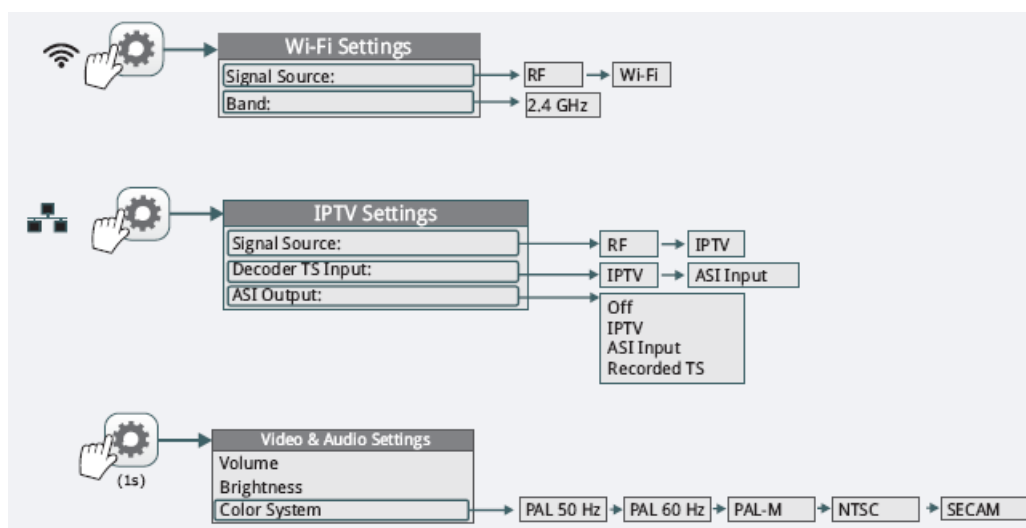

Figure 41. Settings for WiFi / Video & Audio



### ► Signal Source

It allows the user to select the signal coming into the equipment: RF (for radio-frequency signals), WiFi (for WiFi operation bands), OTT (for Over the Top services) or CCTV\* (to show video from video-surveillance devices).

### ► Band

It allows the user to select between terrestrial or satellite frequency band for RF, or the WiFi operation band for WiFi.



[Click here to watch this video: Switching satellite / terrestrial bands](#)

### ► External power supply (available for terrestrial and satellite band)

It enables or disables the power supplied to external units such as preamplifiers for antennas in terrestrial television or LNBS and FI simulators in the case of satellite TV.

When this option is enabled the equipment applies at the output the voltage selected by the user in the Supply Voltage option (see below). When this option is disabled the equipment does not apply the voltage to the output but it will behave as if it did.

### ► Supply voltages (available for terrestrial and satellite band)

It selects the voltage to be applied to an external unit. Available voltage options change depending on the selected band. In tuning by channel mode this option can not be changed because is defined by the channel.

- Voltage available for terrestrial band: External, 5 V, 12 V and 24 V.
- Voltage available for satellite band: External, 5 V (for devices working with 5 V such as GPS active antennas), 13 V, 13 V + 22 kHz, 15V, 18 V, 18 V + 22 kHz.

In the External supply voltage option the power supplier to the external units is the power supplier of the antenna preamplifiers (terrestrial television) or the satellite TV receiver (collective or domestic).

---

\*. It works with the CV-150 adapter. Contact PROMAX for more info.



► **LNB Drain** (available for terrestrial and satellite band)

The LNB drain option shows the voltage and current flowing to the external unit. The DRAIN LNB light indicator\* is lit if current is flowing to the external unit.

If there is any problems (e.g. short circuit), an error message appears on the screen ('SHORTCIRCUIT'), a warning beep sounds. The equipment allows you to disable the output tension that feeds the LNB when the short-circuit warning is displayed.

The equipment does not return to its normal operating state until the problem is solved. During this time the equipment checks every three seconds if there still the problem, warning with an audible signal.

► **DiSEqC Mode** (only available for satellite band)

It enables or disables DiSEqC mode. DiSEqC (Digital Satellite Equipment Control) is a communication protocol between the satellite receiver and accessories of the satellite system (for more details refer to ["CONNECTING TO EXTERNAL DEVICES" on page 186](#)).

► **SCD/EN50494** (only available for satellite band)

It enables or disables the SCD/EN50494 function to control devices of a satellite TV installation that supports this technology (for more details refer to ["CONNECTING TO EXTERNAL DEVICES" on page 186](#)).

► **SCD2/EN50607** (only available for satellite band)

It enables or disables SCD2/EN50607 mode to control devices in a satellite TV installation which must be compatible with this technology (for more details refer to ["CONNECTING TO EXTERNAL DEVICES" on page 186](#)).

► **Polarization** (only available for satellite band)

It allows the user to select the signal polarization between Vertical/Right (vertical and circular clockwise) and Horizontal/Left (horizontal and circular anti-clockwise), or disable it (OFF). In tuning by channel mode this option can not be changed because is defined by the channel.

---

\*. only available for RANGER *Neo* +



► **Sat Band** (only available for satellite band)

It allows the user to select the High or Low band frequency for satellite channel tuning. In channel tuning mode the Band Sat can not be changed. In tuning by channel mode this option can not be changed because is defined by the channel.

► **LNB Low Osc.** (only available for satellite band)

It defines the local oscillator frequency for the LNB low band. When a channel plan is selected but LNB oscillator values are not properly selected, a warning is issued.

► **LNB High Osc.** (only available for satellite band)

It defines the local oscillator frequency for the LNB high band (up to 25 GHz). When a channel plan is selected but LNB oscillator values are not properly selected, a warning is issued.

## 3.2 Video & Audio Settings

Press the Settings key  for one second to access the Video & Audio settings menu.

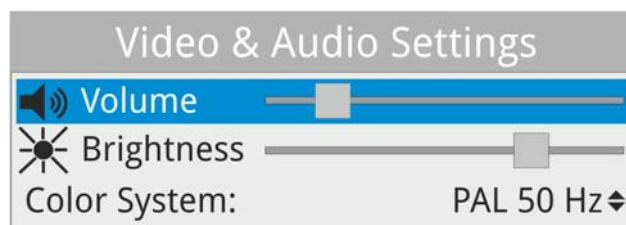

**Figure 42.**

A brief explanation of each option available on the menu:

► **Volume**

It increases or decreases the volume of the speaker audio output by moving the joystick to the right (+ volume) or left (- volume).

► **Brightness**

It increases or decreases the screen brightness by moving the joystick to the right (+ brightness) or left (- brightness).



## ► Colour System

The coding system used in analogue transmissions. Available options are: PAL 50 Hz, PAL 60 Hz, PAL-M, NTSC, SECAM.

### 3.3 Preferences Menu

**Preferences** menu is available by pressing the **Installations Management** key  for one second. The options are grouped in tabs as follows:

- **Equipment**: Equipment information.
- **Appearance**: Equipment customizing options.
- **Time & Date**: It allows the user to change date, time, date format and time zone (selecting continent and country/city).
- **Measurements**: It allows the user to choose between several units of measure among other parameters.
- **Tools**: It allows to edit some parameters for different tools.
- **StealthID**: It allows the user to select the set of signal types being used while auto identifying any modulation type.
- **Security**: It allows to edit the PIN code.
- **Network**: Network parameters settings.
- **Streaming V/A\***: Streaming configuration.
- **SNMP\*\***: SNMP configuration.
- **SMTP\*\*\***: E-mail server configuration.
- **NTP**: (Network Time Protocol) It allows your meter to connect to a server in order to set date and time.

---

\*. only available for RANGER *Neo* +

\*\*. only available for RANGER *Neo* +

\*\*\*. only available for RANGER *Neo* +



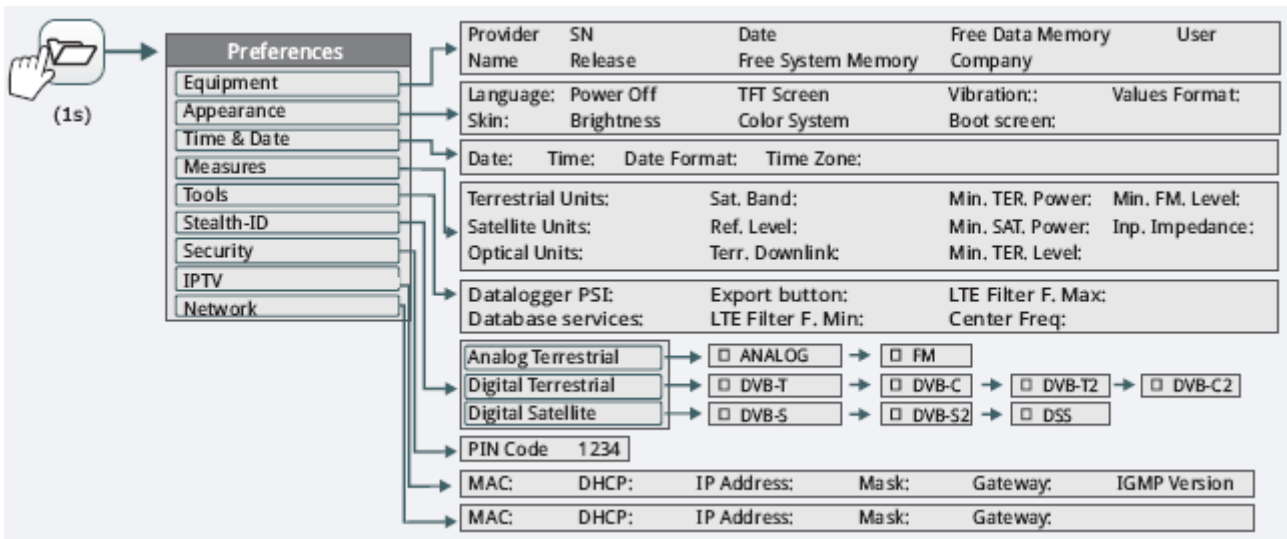

Figure 43.

To navigate between tabs move the joystick left or right. To navigate between options inside the tab move the joystick up or down.

Press **F1** Exit to exit Preferences.

Press **F2** Save to save changes.

A brief explanation of the options available in each tab:

► **Equipment Information**

- Provider: Provider’s name.
- Name: Equipment’s name.
- Serial number: Unique identification number for this equipment.
- Release: Version of software installed on the equipment.
- Date: Date of software installed on the equipment.
- Free system memory: Free size of the flash memory installed on the equipment / Size of the flash memory installed on the equipment for system (equipment software).
- Free data memory: Free size of the flash memory installed on the equipment / Size of the flash memory installed for data (dataloggers, screenshots, service recording and so on...).
- Company: Name of the company which owns the equipment (set by user; protected by PIN code). This field appears on the boot screen.
- User: Name of the equipment's user (set by user; protected by PIN code). This field appears on the boot screen.



### ► Appearance Options

- **Language:** Language used on menus, messages and screens. Available languages are: English, Spanish, Catalan, Czech, German, French, Italian, Norwegian, Polish, Portuguese, Greek, Russian, Slovak and Swedish. Once the new language is selected, the equipment shows a warning message and re-starts in order to load the new language.
- **Skin:** It is the theme and colours used on screen.
- **Power Off:** It allows the user to select the time to power off, which is the time after which the equipment shuts down automatically unless user press any key.
- **Brightness:** User can select between two options:
  - **Manual:** The display brightness is adjusted manually using the brightness setting (see section **Video and audio settings**).
  - **Automatic\***: The display brightness is automatically adjusted according to the light received by the sensor.
- **Background:** It allows the user to select the background colour on the display screen. Options available are: white, green, red, black and blue.
- **Battery Time:** It hides or shows the remaining battery time. Remaining battery time is displayed on the inside of the battery level icon.
- **TFT Screen:** User can select a time after which the TFT screen turns off, but the equipment is still running normally. The screen turns on by pressing any key. Time options are: off, 1, 5, 10 or 30 minutes.
- **Color System:** The coding system used in analogue transmissions. Available options are: PAL 50 Hz, PAL 60 Hz, PAL-M, NTSC and SECAM.
- **Values Format:** It allows the user to select the format to show on fields PID, NID, ONID, TSID and SID in TV mode screen 3/3 and on field SID in "Select Service" tool. Available formats are decimal or hexadecimal.
- **Touchscreen Calibration:** Press on F4 to run a test to calibrate the touchscreen. Just follow the instructions and press on each circle at corner and centre to calibrate.

### ► Time & Date Options

- **Date:** It allows the user to edit the date. Press the joystick for edit mode.
- **Time:** It allows the user to edit the time. Press the joystick for edit mode.
- **Date Format:** It allows the user to change the date format, which is the order in which is shown day (DD), month (MM) and year (YYYY or YY).
- **Time Zone:** It allows the user to select continent and country/city where the meter is in order to determine if it is necessary to apply DST (Daylight Saving Time).

---

\*. only available for **RANGER *Neo* +**



### ► Measurement Options

- **Terrestrial Units:** It allows the user to select the terrestrial measurement units for the signal level. Available options are: dBm dBmV and dB $\mu$ V.
- **Satellite Units:** It allows the user to select the satellite measurement units for the signal level. Available options are: dBm, dBmV and dB $\mu$ V.
- **Optical Units:** It allows the user to select the optical measurement units for the signal level. Available options are: dBm.
- **Satellite Band:** It allows the user to select the type of satellite band used between Ku/Ka band and C band.
- **Reference Level:** It allows the user to select the type of reference level adjustment between manual (modified by the user) or automatic (selected by the equipment).
- **TER. Downlink:** If this option is enabled it allows you to set a local oscillator in terrestrial band from Settings  and it displays intermediate and downlink (DL) frequencies calculated from local oscillator. For example, it allows you to work with terrestrial radio-links or frequency converters.
- **Position Tone:** The user can select where at the voltage to insert a 22 kHz tone: Up, Center or Down. The tone will be inserted on the top, in the center or below the LNB tension respectively.
- **Min. TER. Power:** It sets the minimum power for a terrestrial digital signal to be identified when channel exploring.
- **Min. SAT. Power:** It sets the minimum power for a satellite digital signal to be identified when channel exploring.
- **Min. TER. Level:** It sets the minimum level for a terrestrial analogue signal to be identified when channel exploring.
- **Min. FM Level:** It sets the minimum power for a FM signal to be identified when channel exploring.
- **Input Impedance:** It allows the user to select the impedance at the RF input between 50  $\Omega$  and 75  $\Omega$ .
- **Power Offset:** It adds this value to the power/level measurement. When this value is different to 0 dB, next to power/level measurement an asterisk (\*) is shown as a warning that offset is been applied.

### ► Tools Options

- **Datalogger PSI:** If you select the option "**Capture**", when datalogger is working it captures the service list of each channel. This process slows the datalogger, but provides additional information that can be downloaded in XML files. To disable this option select "**Don't capture**".
- **Database Services:** When it is enabled, it saves all the services been detected in the current installation. There is a database for services in



terrestrial band and another for services in satellite band. Services are included automatically when the signal is locked. If enabled, these services will be displayed on the "**View all services**" option in the

**Tuning**  menu.

- **Export Button:** It allows the user to select the data to be exported when pressing the export key among the following options: screen only, data only or both. More info in the "Export key" chapter.
- **LTE Filter F. Min:** Select the minimum frequency for the external LTE filter.
- **LTE Filter F. Max:** Select the maximum frequency for the external LTE filter.
- **Center Frequency:** User can set the center of frequency to **Manual or Auto mode**. In Manual mode the user sets the center of frequency and the equipment does not change it never, so the main cursor can be moved out of screen. In Auto mode the equipment changes the center of frequency to display always the main cursor on screen.
- **Moni. ddbb loc.:** It allows you to select where the database for the webControl "Monitoring" tool will be stored (for more details refer to ["Monitoring" on page 164](#)). Options are "Internal" to save to the internal memory of the meter or "Hard Drive" to save to an external disk connected to the device. In the case of using the external disk option, it must be USB 2.0 formatted with the "ext4" file system and labeled with the name "PROMAX\_HD" where 0 is a zero.

### ► **Stealth-ID Options**

It allows the user to select the set of signal types being used while auto identifying any modulation type (for more details refer to ["?Stealth-ID" on page 53](#)).

### ► **Security Options**

It allows the user to change the PIN code that gives access to protected data fields. The default PIN code is "1234". To change the PIN, first enter the current PIN code, then enter the new PIN.

In case the user forgets the PIN, after the third attempt, a 12-digit code will appear on screen. Sending this 12 digit code to the PROMAX customer service, the user will recover the PIN.



### ► Network Options

Network parameters that user has to fill out in order to identify the equipment into a data network. This is necessary to connect to a PC via ethernet. Network parameters are:

- MAC: Physical address of the equipment. It is unique and cannot be edited.
- DHCP: Enable this option to get the proper IP address when the unit is first connected to a network. That feature contributes to make things easier to installers when debugging network access.
- IP Address: IP Address of the equipment into the local network.
- Mask: Subnet mask of the equipment (by default 255.255.255.0).
- Gateway: IP Address of the router into the local network (by default 10.0.1.1).

### ► Streaming V/A Options \*

Streaming parameters that user has to fill out in order to broadcast video/audio from the meter to a PC. Streaming parameters are:

- IP Address: IP address belonging to the PC to broadcast in streaming from the meter.
- Port: Broadcasting port linked to the PC IP.

For more details refer to ["Streaming V/A" on page 135](#).

---

\*. only available for RANGER *Neo* +



### ► SNMP Options\*

SNMP is a communication protocol to monitor devices in a network. User has to fill out these parameters to communicate with the meter and to supervise it. SNMP parameters are:

- SNMP Configuration:
  - Get Community (by default "public"): Community identification name for request messages.
  - Set Community (by default "private"): Community identification name for setting messages.
- SNMP version 1 / SNMP version 2
  - Traps: It allows enabling or disabling alert messages.
  - Manager IP: IP address for SNMP Manager.
  - Community: Community identification name.

### ► SMTP Options\*\*

SMTP stands for simple mail transfer protocol. User has to fill in all these parameters in order to receive by e-mail all the notifications triggered during monitoring (for more details refer to ["Monitoring" on page 164](#)). SMTP parameters are:

- Enabled: When checking this box e-mails sending is enabled.
- Server IP Address
- Server port.
- From e-mail address.
- Connection type (secure, unsecure).
- Authentication required: Check this box if authentication is required and in that case enter user and password.

### ► NTP Options

NTP (Network Time Protocol) is a network protocol that synchronizes time from a server on a device. It periodically connects this server and updates date and time. This function requires an Internet connection to work. It is especially necessary in tools where accuracy at the time of execution is important, such as in monitoring, task management, etc.

NTP parameters are:

---

\*. only available for RANGER *Neo* +

\*\*.. only available for RANGER *Neo* +





- Enabled: Mark this checkbox to enable NTP.
- Server URL Address: NTP server address (example: 0.pool.ntp.org).
- Test Configuration: NTP connection server test (to perform this test, first unmark the Enabled checkbox).



## 4 RF SIGNAL TUNING

### 4.1 Introduction

On the panel left side, the equipment has three functions keys, which give direct access to three ways to display RF signal.

- MEASUREMENT : This mode shows main measures of RF signal and allows you to identify if any measure is above or below usual values.
- SPECTRUM ANALYZER : This mode shows spectrum and allows you to visually identify any anomalies over the RF signal.
- TV : This mode shows RF signal demodulated and allows you to check broadcasting quality for video and audio.

Pressing a key repeatedly provides access to a different view within the same mode displaying different windows. Each view combines several RF modes (demodulated, spectrum, measures) which is very convenient to identify problems.

The StealthID function is an auto-identification system which identifies type and characteristic parameters of the signal and then tries to tune and demodulate it with no need to enter any parameter by hand.

### 4.2 Operation

- 1 Connect the RF input signal to the equipment.
- 2 Press the "Settings" key to access Settings menu and in "Source Signal" select "RF".
- 3 From Settings menu access the "Band" option and select "Terrestrial" to work on terrestrial band or "Satellite" to work on satellite band.
- 4 Select the display mode by pressing the MEASUREMENT, SPECTRUM ANALYZER or TV mode. Pressing a key repeatedly provides access to different views.
- 5 Enter frequency or channel using the "Tuning"  menu or using the joystick to go left or right along the frequency / channel band.









- 6 Once you are placed on the channel or frequency, the StealthID function tries to identify and lock the signal and its characteristic parameters and will show results on screen.

### 4.3 General Menu Options

At the bottom of the screen four menus are accessible via the softkeys or function keys.

-  It displays the channel where is pointing the cursor and gives access to the tuning menu.
-  It displays the selected transmission standard and gives access to the signal parameters menu.
-  It displays the Tools menu.
-  It displays the Advanced menu.

In general, these options are the same for all modes (Measure, Spectrum Analyzer and TV).

The specific options for a mode are placed in the menu "Advanced" pressing the key .

In next sections each one of these menus is described.

#### 4.3.1 F1: Tuning - Selecting Channel / Frequency

Press  to access. It contains tuning options.

Tuning options are:

##### ► Channel/Frequency

It displays the channel/frequency pointed by the cursor. Tuning type (channel/frequency) is selected by means of the Tune by option



### ► Channel Plan

This option allows the user to select a channel plan from the ones available for the current installation.

### ► Tune by

It allows the user to select between tuning by channel (selecting a channel or channel by channel with the joystick) and tuning by frequency (selecting a frequency or step by step with the joystick).

#### In case of tuning by channel:

- 1 Place over the **Channel** option and press the joystick.
- 2 A box appears with all channels of the active channel plan and its frequency.
- 3 Move the joystick on the box to select a channel.
- 4 After finished press the joystick to save the selected value or any function key to exit without saving.
- 5 The cursor will place on the selected channel and it will appear on the  option.
  - Channels can be changed directly with the joystick in CH mode.

**NOTE:** When using tune by channel on satellite, the polarity parameters (horizontal/vertical and left/right) and satellite band (high/low) are selected automatically by the equipment, according to the channel plan enabled and cannot be changed by the user. To change these parameters, the user may switch to frequency tuning. But the user can change the voltage output while in a channel plan, as long as none has been defined in that same channel plan. For instance, if a standard channel plan is being used like the CCIR, there is no need for switching to frequency tuning mode.

#### In case of tuning by frequency:

- 1 Place over the **Frequency** option and press the joystick.
- 2 The option is highlighted in yellow to indicate it is in edit mode.
- 3 Move the joystick left/right to move between the figures and up/down to change the figure.



**4** After finished press the joystick to save the selected value or any function key to exit without saving.

- The frequency can be changed directly with the joystick in FR mode in 50 kHz steps.



[Click here to watch this video: Manual input of frequencies](#)

### ► Center Frequency

This option is available only for the Spectrum Analyzer mode. It allows to edit the center frequency. The center frequency is the frequency at which the screen is centered.

### ► Reference Level

This option is available only for the Spectrum Analyzer mode. It allows you to edit the reference level. The reference level is the power range represented on the vertical axis.

The Reference Level can be changed directly pushing the joystick up or down.

### ► Span

This option is available only for the Spectrum Analyzer mode. It allows to edit the span, which is the frequency range displayed on screen on the horizontal axis. The current span value appears on screen at bottom right.

Span available values change according to Resolution Bandwidth selected (for more details refer to ["Spectrum Analyzer Mode" on page 204](#)).

To switch among span default values move the joystick (left, right) in span (SP) mode. For example, for RBW = 100 kHz default span values are Full (full band), 500 MHz, 200 MHz, 100 MHz, 50 MHz, 20 MHz and 10 MHz. To change to any other span value in this frequency range use the "span" option in the Tuning menu (**F1** key).

### ► Center Tuned Frequency

This option is only available for the Spectrum Analyzer mode. When selecting this option, the frequency tuning (where the main cursor is pointing) is placed at the center of the screen. This option does not work with FULL span or if main cursor is very close to band boundaries.



### ► Downlink

This option shows up if "Terrestrial Downlink" option in Preferences is enabled and if it is selected tune by frequency. It displays downlink (DL) frequency calculated from local oscillator value. To set a local oscillator value press Settings  from terrestrial band.

### ► View all services





This option only appears if the Database services option is enabled in the Preferences menu.

This option displays a window with a list of services that have been detected in the current installation.

The list shows service name, provider, SID (stream identifier) and an icon that shows its type (radio, TV) and if it is scrambled. When hovering on the service for one second it displays a hint window with more information.

If user presses the joystick on a service, it will access that service. When disabling the Database services option, all services in the installation will be deleted from the list.

At the bottom of this option are shown the softkeys with these functions:

-  F1 Cancel: It exits the option.
-  F2 Filter List: It shows several options to filter the list of services:
  - By access (Free Only, Scrambled Only, All).
  - By type (All, TV, Radio).
  - Search by name (filtered by the name).
  - Reset list (it restarts the list as at first) Service filtering is persistent until resetting.
-  F3 Page Up: It jumps one page up.
-  F4 Page Down: It jumps one page down.



### 4.3.2 F2: Signal Parameters

Access by the , function key. It allows selecting the standard transmission and displays the parameters for signal transmission.

#### ► Signal Type

It displays the selected standard. It allows selecting another standard in the same band (terrestrial or satellite):

#### Operation:

- 1 Place over the **Signal Type** option and press the joystick.
- 2 It displays a menu with transmission standards.
- 3 Move the joystick up / down to select a standard.
- 4 Press joystick to select the standard or any function key to exit without selecting.

#### ► View Advanced Parameters

It shows the TPS parameters (Transmission Parameters Signalling) for the locked signal according to the modulation standard. This option is available only when these parameters are detected. The remaining transmission parameters are detected demodulating the locked signal.

- In case of a DVB-S/S2 signal, the symbol-rate parameter can be set manually.
- In case of a Generic signal, the bandwidth of the channel can be set manually.

In case of a DVB-S2 signal, there will be some special settings for this type of signal. They are:

- Physical Layer Scrambling or PLS is used in DVB-S2 as a way to improve data integrity. A number called the "scrambling sequence index" is used by the modulator as a master key to generate the uplink signal. This same number must be known by the receiver so that demodulation is possible.



[Click here to watch this video: DVB-S2 multi stream decoding](#)

- Most satellite transponders use PLS 0 as a default value but there are some transponders that use other values.





- If it is a multistream signal (MIS), it will appear an option that enables filtering by the input stream identifier (ISI) and to select the stream to demodulate (by default it will randomly select one stream from the signal).

### ► Stealth-ID



The **StealthID** function is a RF signal identification function performed automatically by the equipment without any user intervention.

The equipment tries to identify the channel or frequency of the input signal it receives, and according to the band selected by the user (terrestrial or satellite), it applies identifying criteria according to the standards available on that band. When the equipment recognizes in the input signal the identification parameters of a specific standard, it decodes and identifies data of that signal.



#### Settings:

- 1 Press the **Preferences** key  for 1 second.
- 2 In the **StealthID** tab, select the signal types to auto-identify. By default all them are selected. Press the  key to save the changes made and the  key to exit the **Preferences** screen.

#### Operation:

- 1 Press the  key and check the StealthID option is ON.
- 2 Press the **Settings**  key.
- 3 Select the band (terrestrial or satellite).
- 4 Select a channel or frequency to identify.
- 5 The bottom of the screen shows the message "**Searching for signal**" and the standard transmission checking. The identification system tries to lock the first signal using the modulation defined in the channel plan for that signal. If after five seconds it fails to lock with that modulation, it starts the wheel for automatic detection. If then it locks in a modulation other than indicated, it generates an internal temporary channel plan to accelerate tuning the same channel later on.
- 6 Wait a few seconds for the equipment to identify the signal. User can force the auto-identification of a signal by pressing the  key and selecting the type of signal from the menu.



- 7 When the equipment identifies the signal it displays on screen its standard and type.
- 8 Press  **Signal Parameters** to see all signal parameters.
- 9 Once the signal has been identified, to disable auto-identification press  and on StealthID option select OFF. In this way, if the signal unlocks, the system will try to look the previous signal, without restarting the auto-identification.

#### ► Signals automatically detected

- Digital Terrestrial Television First Generation (DVB-T).
- Digital Terrestrial Television Second Generation (DVB-T2: T2-Base and T2-Lite profiles).
- Digital Satellite Television First Generation (DVB-S).
- Digital Satellite Television Second Generation (DVB-S2).
- Digital Satellite Television, exclusive for DirecTV (DSS).
- Digital Cable Television First Generation (DVB-C).
- Digital Cable Television Second Generation (DVB-C2).
- Integrated Services Digital Broadcasting - Terrestrial (ISDB-T).
- Digital multi-programme systems for television, sound and data services for cable distribution (J83 Annex B).
- Analogue TV.
- Analogue FM.
- DAB (Digital Audio Broadcasting)\*.

### 4.3.3 **F3: Tools**





Access by the  key. It shows the Tools menu. If a specific tool is not available for the signal locked then the option is disabled. Tools are:

- **Select Service:** It displays a list of services available in a locked multiplex. It shows service name, icons that identify the service type, SID (stream identifier) and LCN (logic channel number). Icons that appear next to the service name identify the features of the service. Each icon is explained in the following table:

---

\*. available as an option for **RANGER *Neo* +**



|   |                           |   |                                   |
|---|---------------------------|---|-----------------------------------|
|  | <b>Digital TV service</b> |  | <b>High Definition TV service</b> |
|  | <b>Digital radio</b>      |  | <b>Data</b>                       |
|  | <b>Scrambled service</b>  |   |                                   |

- Signal Monitoring<sup>\*</sup>: This tool allows the user to monitor a signal by measuring its power, MER and C/N. All this data, can be downloaded to a PC and exported to a file for later analysis. In this file are saved all characteristics measurements for each type of signal.
- Signal Coverage<sup>\*\*</sup>: This option allows the user to check signal coverage by measuring its power, MER and C/N. The position where all these measurements are taken is determined by a GPS receiver. All this data, measurements and GPS position can be downloaded to a PC and exported to a file for later analysis.
- Explore Channel Plan: It explores the selected channel plan. Tune by channel must be selected.
- Datalogger: It creates a file in which are stored measurements. This file belongs to the selected current installation.
- Constellation: It displays the constellation of the locked signal.
- LTE Ingress Test: It enables the detection of signal interferences coming from mobile phones.
- Attenuation Test: This feature allows the user to easily check the response of the telecommunications installations before antennas and headers are working.
- Echoes: It detects the echoes that may appear due to the simultaneous reception of the same signal from several transmitters.
- MER by carrier<sup>\*\*\*</sup>: This function analyses continuously the measure of the MER value for each one of the carriers forming the selected channel and they are displayed in a graphic on screen.
- MEROGRAM<sup>\*\*\*\*</sup>: This functions shows a graphical representation of the MER level for each carrier of the locked signal, which is superimposed over time.
- Spectrogram<sup>\*\*\*\*\*</sup>: This function shows a graphical representation of the spectrum superimposed over time of a channel or frequency selected by the user.
- Discover FM Stations: This function scans the FM band and creates a FM channel plan from scratch. Scanned frequency range is from 87 to 108 MHz.

\*. only available for **RANGER Neo +**

\*\*.. available as an option for **RANGER Neo +**

\*\*\*. only available for **RANGER Neo +**

\*\*\*\*. only available for **RANGER Neo +**

\*\*\*\*\*. only available for **RANGER Neo +**





- **Field Strength:** This function allows the equipment to measure as a field strength meter.
- **Task Planner:** This function allows the user to schedule specific tasks.
- **Shoulder Attenuation<sup>\*</sup>:** This function measures the shoulder-shaped interferences in the adjacent channels.
- **Service Recording:** This function records in real-time the digital service shown on display from the tuned transport stream.
- **Tilt<sup>\*\*</sup>:** This function shows level difference among four carriers, in graphic and numerical mode.
- **Scan<sup>\*\*\*</sup>:** This function shows signal level in bar graph mode for all channels in a channel plan.
- **Streaming V/A<sup>\*\*\*\*</sup>:** This function allows the user to broadcast video/audio from the meter to a PC through a data network.
- **Power Off:** This option allows you to switch off the meter from the menu.

For more details about these tools refer to ["TOOLS" on page 78](#).

## 4.4 Advanced Options

Press key , to access advanced options for the mode selected.

### ► Advanced Menu in Spectrum Analyzer Mode:

- **Average:** The user can select the amount of signal values to be used to set the average signal value to be displayed on screen. The larger the average value, the more stable the displayed signal appears.
- **Spectrum Line:** It defines the spectrum display. The Outline option displays the spectrum outline. The Solid option displays the contour of the spectrum with solid background. The Transparence option shows the outline in yellow and the background in a softer yellow.
- **Tone Level:** This option produces a tone that changes according to the input level of the signal so the tone is sharper if the level increases and deeper if the level decreases.
- **Marker:** It allows enabling/disabling the marker. This marker is displayed on screen with the shape of an arrowhead, showing on screen some information about the frequency and power level where it points. You can move left/right by the joystick in MK mode (press the joystick until the

---

\*. only available for **RANGER *Neo* +**  
 \*\*. only available for **RANGER *Neo* +**  
 \*\*\*. only available for **RANGER *Neo* +**  
 \*\*\*\*. only available for **RANGER *Neo* +**



icon MK appears). When the Marker is ON at the top right corner a window pops up with the following data:

- Freq: Frequency where is placed the marker.
  - Level: Power level at the frequency where is placed the marker.
  - $\Delta F$ : Difference of frequency between the marker and the main cursor.
  - $\Delta L$ : Difference of power level between the marker and the main cursor.
- **Marker Trace:** It allows the user to select the trace to place the marker on:
    - Normal: It places the marker on the spectrum trace in real time.
    - Reference: It places the marker on the spectrum reference trace. To make a spectrum reference use the Reference function.
    - Max. Hold: It places the marker on the max. hold trace. To make a maximum hold trace use the Max. Hold function.
    - Min. Hold: It places the marker on the min. hold trace. To make a minimum hold trace use the Min. Hold function.
  - **Max. Hold: (Off/Permanent/Curtain).** It allows the user to display the current signal with the maximum values measured for each frequency. The OFF option disables this function. The Curtain option displays the maximum values in blue for a moment with the current signal. The Permanent option maintains maximum signal on the screen. This option is especially useful for detecting sporadic noises.
  - **Min. Hold: (Off/Permanent/Curtain).** It allows the user to display the current signal with the minimum values measured for each frequency. The OFF option disables this function. The Curtain option displays the minimum values in green for a moment with the current signal. The Permanent option maintains minimum signal on the screen. This option is useful for detecting interferences in TV cable or identify deterministic interference in analogue and digital channels.
  - **Persistence:** When active, the signal is displayed on a coloured background. The signal prior to current signal persists for a while before disappearing so the user can see how the signal changes easily.
  - **Detector Type: (PEAK/RMS).** It allows the user to select between maximum PEAK detector or RMS detector. The maximum peak detector is mainly used for analogue modulated signals, while the RMS option is the right choice for digital modulated signals. The max PEAK detector is mostly used for analogue modulated signals, while the RMS is the proper choice for digital modulations. The maximum peak detector causes the noise floor to rise, according to the RMS to peak ratio. That same effect causes digital signals to apparently grow in level when maximum peak detector is used.
  - **Resolution Bandwidth (RBW):** Resolution filters available are: 100 kHz, 200 kHz\* and 1000 kHz\*\*. According to filter selected maximum and minimum span changes (for more details refer to ["Spectrum Analyzer Mode" on page 204](#)).

---

\*. only available for RANGER *Neo* +

\*\*.. only available for RANGER *Neo* +



- Vertical Range: It allows setting the vertical scale on screen. Available values are 1, 2, 5 and 10 dB per division.
- Dashed BW: When it is ON the channel bandwidth area is hatched by lines.
- Reference: (Set / Clear). It memorizes the current trace on screen, which can be used as a reference for further comparison. It may be also very helpful for visually measure the gain or attenuation in a TV distribution network. To delete the reference, select the "clear" option. The trace can be also captured by a short press on the export key  in the Spectrum Analyzer mode. Pressing short again on the export key it clears the reference.

**NOTE:** Some parameters such as average, spectrum line, tone level and marker are recovered after switching on.

#### ► Advanced Menu in TV Mode:

- Analogue Signal: This option is available only if the detected or selected signal is ANALOGUE. Pressing the  key it allows you to select the source for the analogue signal between antenna (via RF connector) and external (via V/A input connector). To get an external analogue signal use the A/V input.
- Aspect Ratio: This option is available only if the detected or selected signal is ANALOGUE. It allows the user to select the image aspect ratio (4:3; 16:9). It remembers this selection even after switch off.
- Advanced: This option is available only if the detected or selected signal is DIGITAL. There are these options:
  - Audio: It allows the user to select among the audio tracks available.
  - TS Data: It shows the IRG data descriptor. If the signal contains this carrier identifier, this option will be enabled. If the signal does not contain this identifier, the option will be disabled (for more information refer to ["IRG Descriptor" on page 75](#)).
  - Discovered URLs: It shows the URL related to the interactive service.

## 4.5 Screen Description

The information that appears on screens for each mode (Measurement mode, Spectrum mode and TV mode) is described below. To change the mode, press the corresponding mode key. To change the screen in the same mode, press the same mode key consecutively.



#### 4.5.1 Measurement Mode Screens

##### ► FULL MEASUREMENT (MEASUREMENT 1/3)

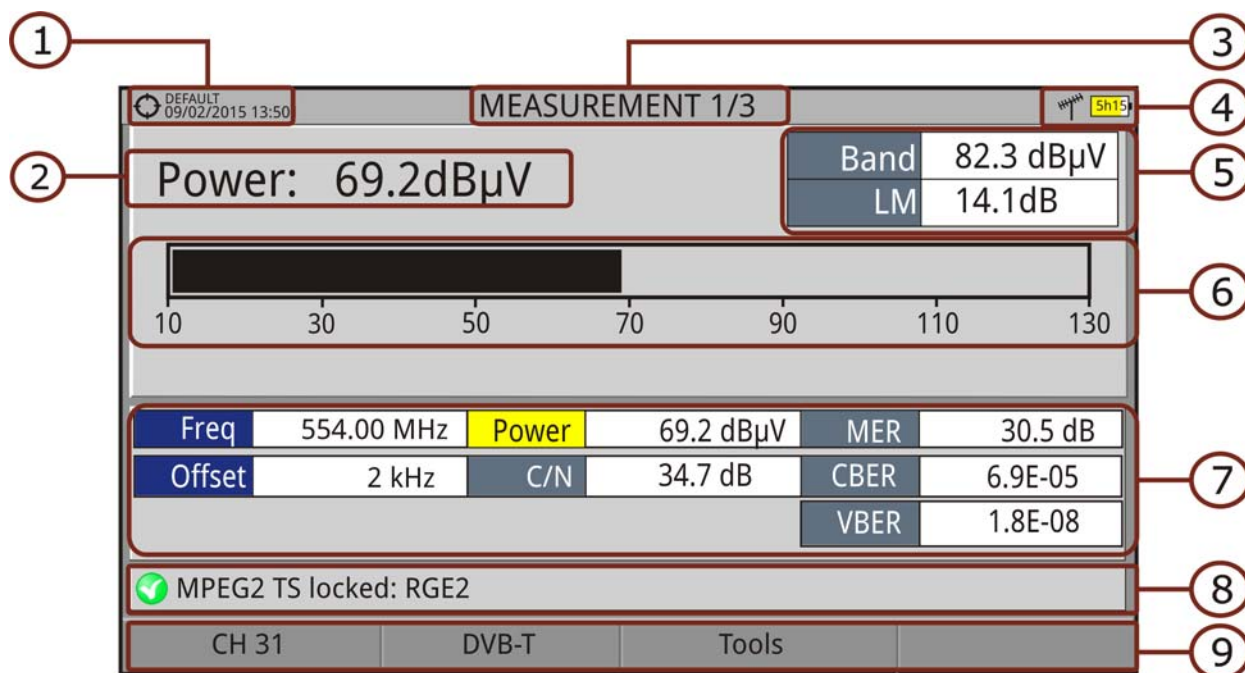

**Figure 44.**

- 1 Selected installation, date and time.
  - 2 Main measurement and its numeric value. To select another main measurement move joystick up / down. The main measurement selection does not change even if you change screen or switch off the meter.
  - 3 Number of view/total views.
  - 4 Selected band, battery level.
  - 5 Total power detected over the whole selected band (terrestrial or satellite). The total power can be used to know when it is close to saturation. It also shows the link margin measurement. The link margin is the margin of safety remaining for a good reception.
  - 6 Graphical measurement of the main measurement.
  - 7 Measurement values for the type of locked signal.
  - 8 Signal status (searching/locked/multiplex name).
  - 9 Softkeys menus.
- Joystick functions:
- Joystick up/down: Change of main measurement on screen.
  - Joystick left/right: Change of channel/frequency.



► MEASUREMENT + TV + SPECTRUM (MEASUREMENT 2/3)

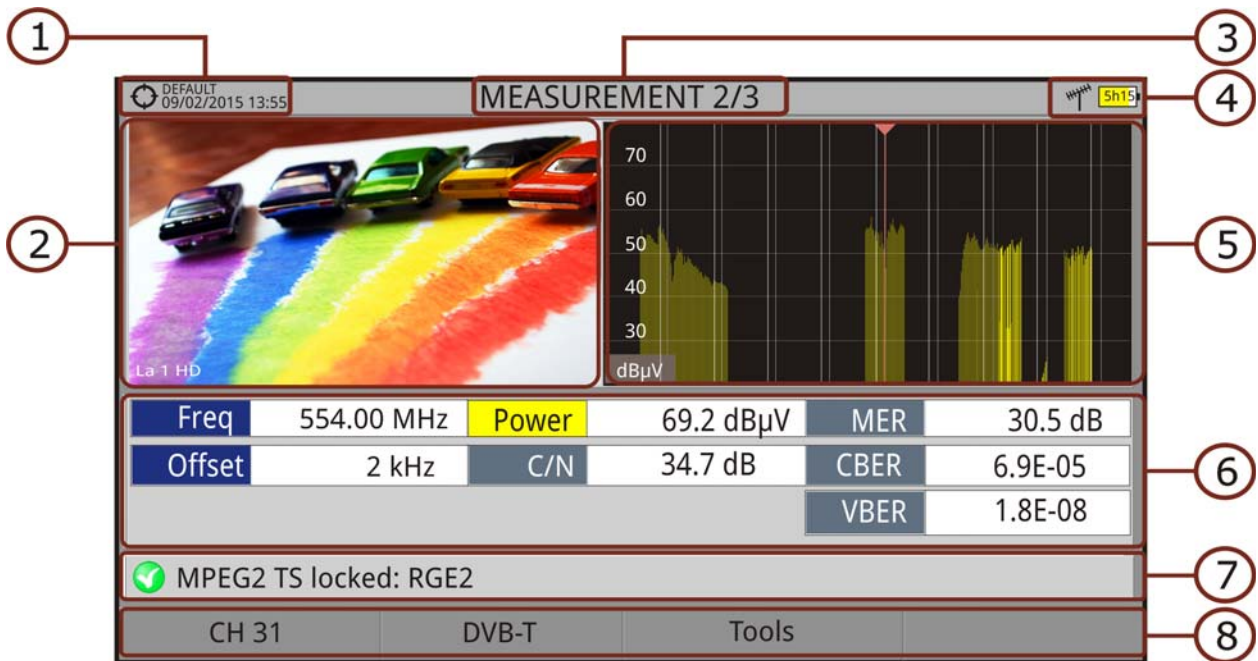

Figure 45.

- 1 Selected installation, date and time.
  - 2 Image of locked signal.
  - 3 Number of view/total views.
  - 4 Selected band, battery level.
  - 5 Spectrum of locked signal.
  - 6 Measurement values for the type of locked signal.
  - 7 Signal status (searching/locked/multiplex name).
  - 8 Softkeys menus.
- Joystick functions:
- Joystick left/right: It changes channel/frequency.



► MEASUREMENT + PARAMETERS (MEASUREMENT 3/3)

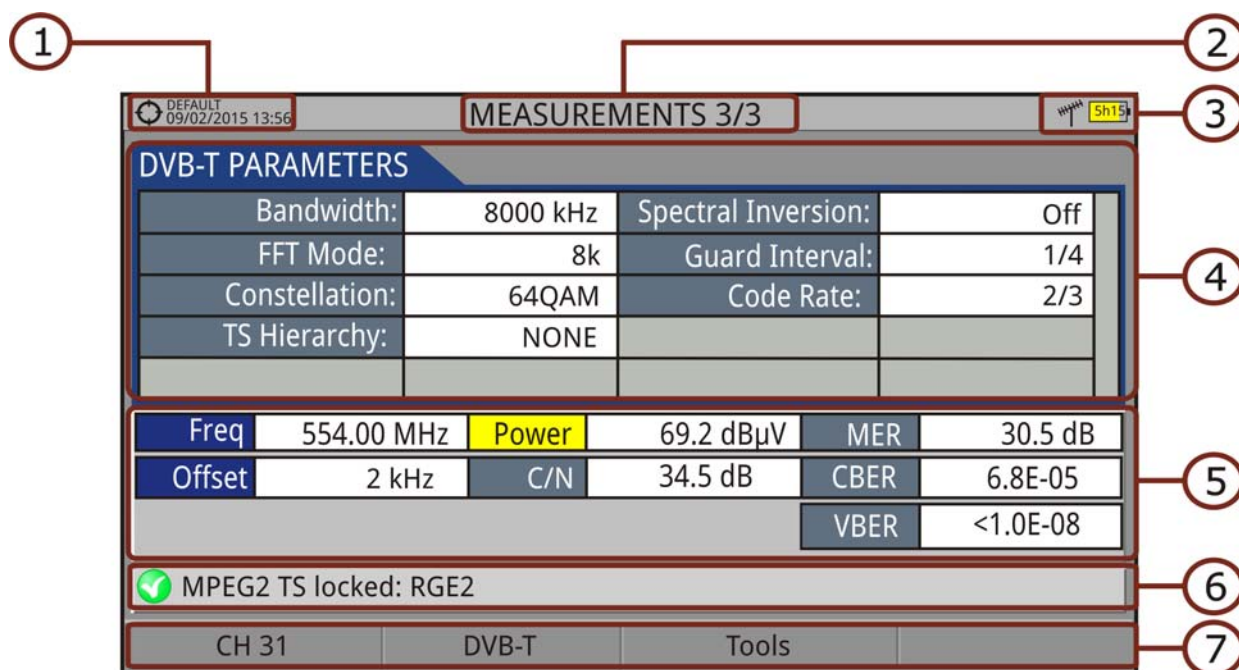

Figure 46.

- 1 Selected installation, date and time.
  - 2 Number of view/total views.
  - 3 Selected band, battery level.
  - 4 Demodulation parameters for the locked signal.
  - 5 Measurement values for the type of locked signal.
  - 6 Signal status (searching/locked/multiplex name).
  - 7 Softkeys menus.
- Joystick functions:
- Joystick left/right: It changes channel/frequency.



## 4.5.2 Spectrum Analyzer Mode Screens

### ► SPECTRUM + MEASUREMENT (SPECTRUM 1/3)

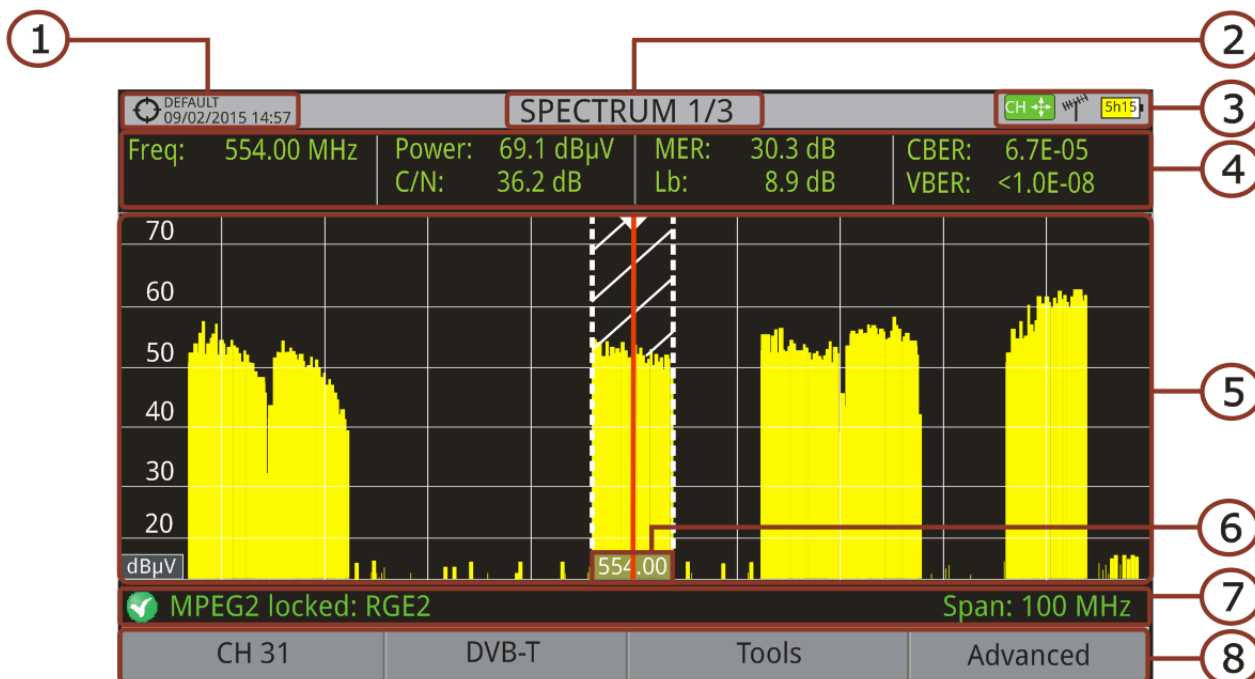

**Figure 47.**

- 1 Selected installation, date and time.
  - 2 Number of view/total views.
  - 3 Joystick active mode, selected band, battery level.
  - 4 Measured values of the signal at the frequency/channel where is pointing the cursor.
  - 5 Spectrum in the band with the selected span.
  - 6 Centre frequency and cursor. It also shows the bandwidth of a digital locked signal.
  - 7 Signal status (searching/locked/multiplex name/selected span).
  - 8 Softkeys menus.
- Joystick functions:
- Joystick up/down: It changes reference level.
  - Joystick left/right (depending on the joystick active mode):
    - SP: Span change.
    - FR or CH: Frequency change or Channel change.
    - MK: Marker change (if marker is enabled).

► SPECTRUM + MEASUREMENT + TV (SPECTRUM 2/3)

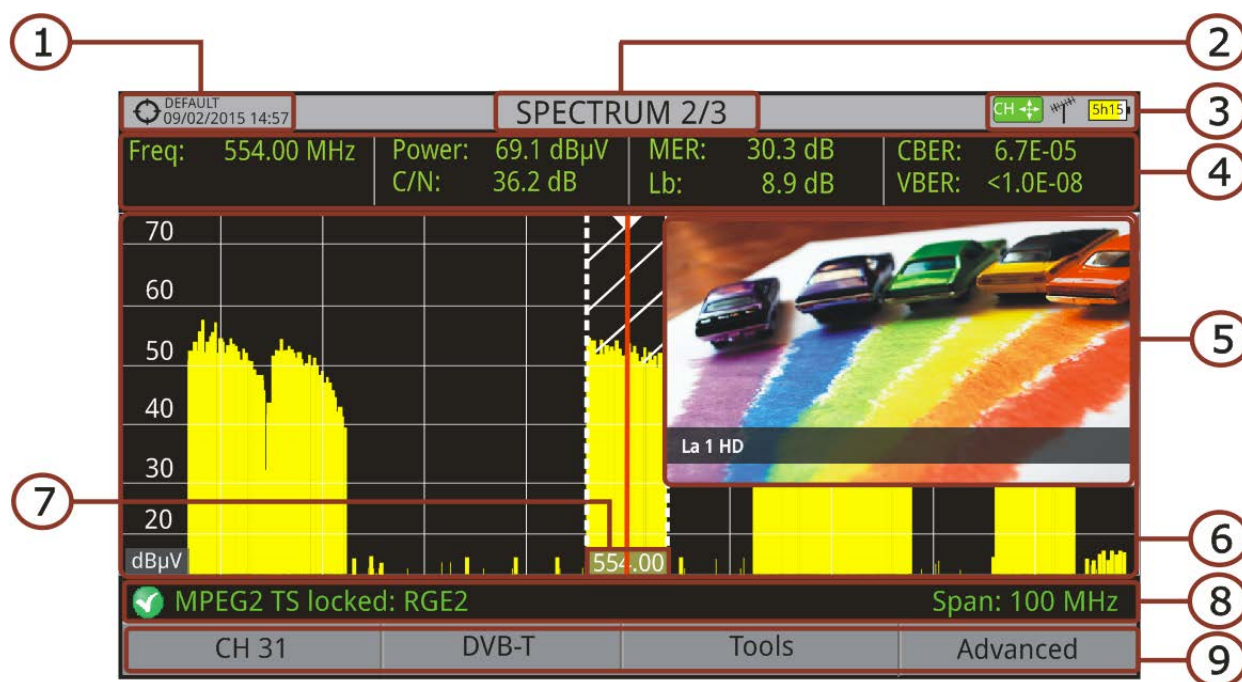

**Figure 48.**

- 1 Selected installation; date and time.
  - 2 Number of view/total views.
  - 3 Joystick active mode; selected band; battery level.
  - 4 Measured values of the signal at the frequency/channel where is pointing the cursor.
  - 5 Image of the tuned signal.
  - 6 Spectrum in the band with the selected span.
  - 7 Centre frequency and cursor. It also shows the bandwidth of the digital signal locked.
  - 8 Signal status (searching/locked/multiplex name/selected span).
  - 9 Softkeys menus.
- Joystick functions:
- Joystick up/down: It changes reference level.
  - Joystick left/right (depending on the joystick active mode):
    - SP: Span change.
    - FR or CH: Frequency change or Channel change.
    - MK: Marker change (if marker is enabled).





► FULL SPECTRUM (SPECTRUM 3/3)

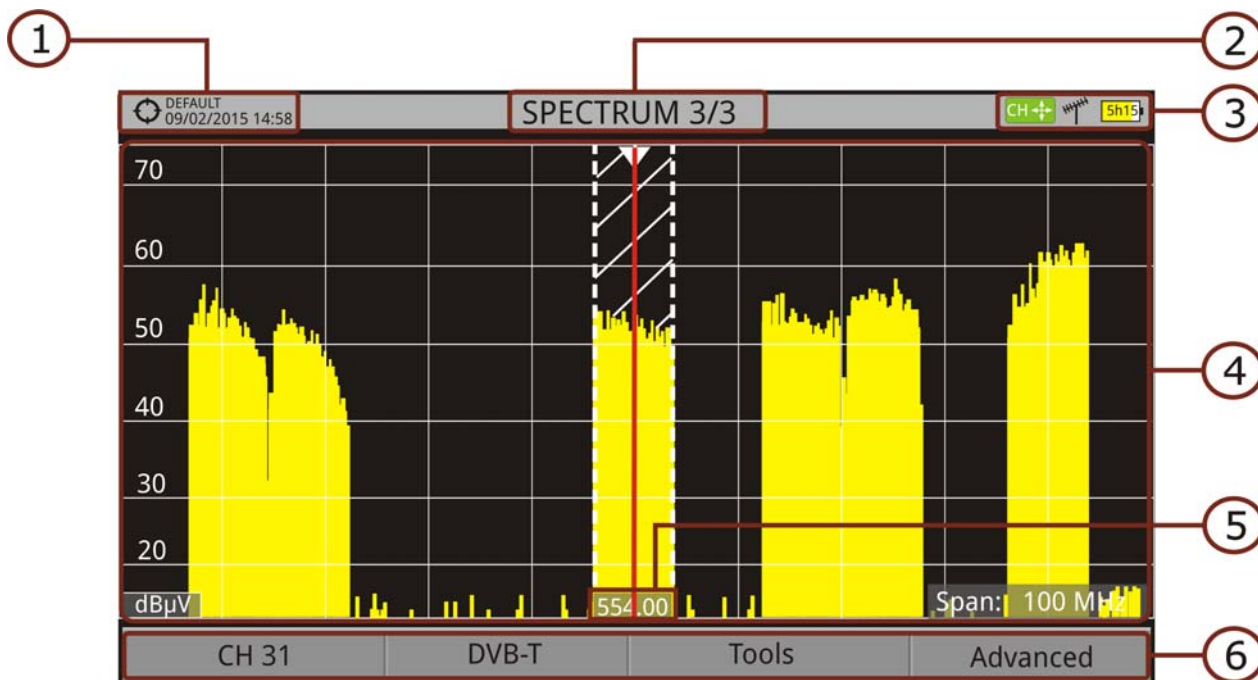

Figure 49.

- 1 Selected installation, date and time.
  - 2 Number of view/total views.
  - 3 Joystick active mode; selected band; battery level.
  - 4 Spectrum in the band with the selected span.
  - 5 Centre frequency and cursor. It also shows the bandwidth of a digital signal locked.
  - 6 Softkeys menus.
- Joystick functions:
- Joystick up/down: It changes reference level.
  - Joystick left/right (depending on the joystick active mode):
    - SP: Span change.
    - FR or CH: Frequency change or Channel change.
    - MK: Marker change (if marker is enabled).

► FULL SPECTRUM (SPECTRUM 3/3) WITH MARKER

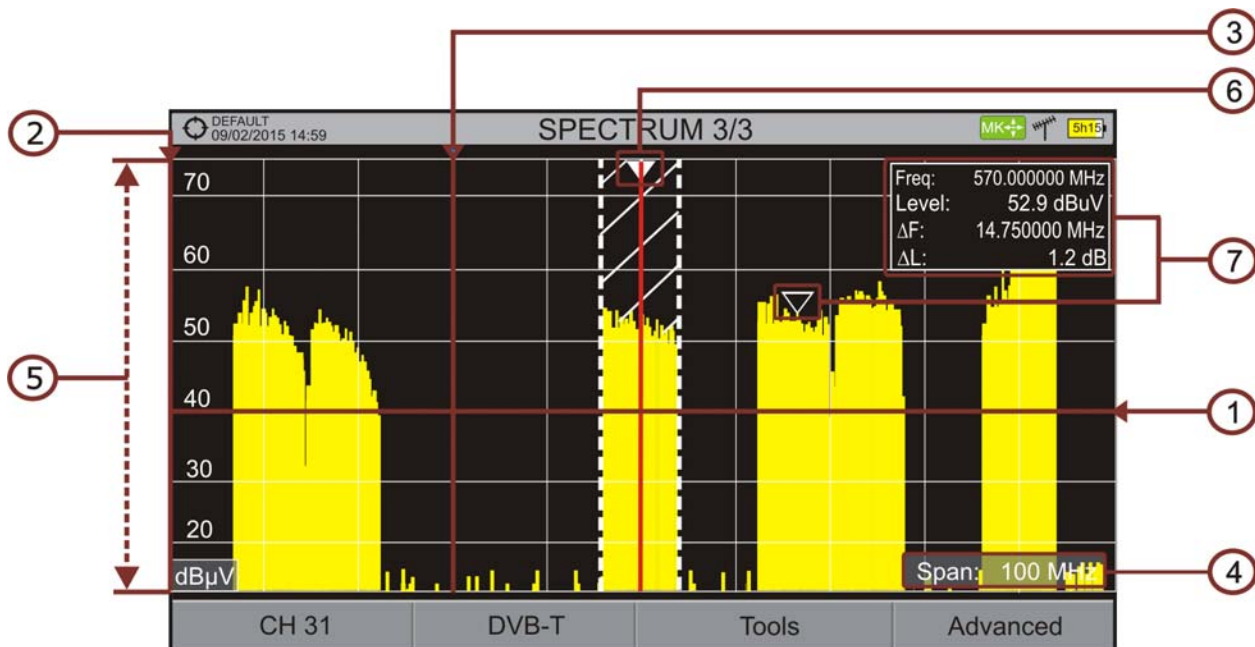

Figure 50.

- 1 Horizontal reference line: It shows level of signal.
- 2 Vertical axis: It indicates the signal level.
- 3 Vertical reference line: It indicates the frequency.
- 4 SPAN: It is the frequency range displayed on the horizontal axis. Span values available changes according to Resolution Bandwidth selected. The current span value appears at the bottom right of the screen. To switch among span default values use the joystick (left, right) in span mode (SP). For example, for RBW = 100 kHz default span values are Full (full band), 500 MHz, 200 MHz, 100 MHz, 50 MHz, 20 MHz and 10 MHz. To change to any other span value in that frequency range use the "span" option in the Tuning menu (F1 key).
- 5 Reference Level: It is the power range represented on the vertical axis. To change use the joystick (up, down; 5 dB steps). This equipment has an option to activate the automatic adjustment of the reference level, so it detects the optimal reference level for each situation. In automatic mode, it sets the optimum reference level each time it enters the spectrum mode. This option can be enabled or disabled through the **PREFERENCES** menu and **Measurements** tab.
- 6 Cursor: Red vertical line that indicates position during the channel or frequency tuning. When a digital signal is detected, there is a triple cursor that shows the frequency for the signal locked and two vertical lines that shows the bandwidth of the digital carrier. In the case of a GENERIC signal, the bandwidth shown is the one selected by the user on the "Signal Parameters" menu when pressing the F2 key. To change frequency/channel



use the joystick (left, right) in FR mode (tuning by frequency) or CH mode (tuning by channel).

- 7** Marker: It is a special cursor that can be placed on a given frequency to check the power in this point. This option can be enabled using the "Marker" option from the Advanced menu (**F4** key). To change use the joystick (left, right) in MARKER (MK) mode. The window Marker shows the following data: :
  - Freq: Frequency where is placed the marker (MHz units; accurate to Hz).
  - Level: Power level at the frequency where is placed the marker (in case of working with FSM tool, it shows FSM level).
  - $\Delta F$ : Difference of frequency between the marker and the main cursor (MHz units; accurate to Hz).
  - $\Delta L$ : Difference of power level between the marker and the main cursor.
- 8** Centre Frequency: Frequency at which the screen is centered. This frequency can be set through the **Tuning** key (**F1**). It also changes when moving the cursor out of screen.



### 4.5.3 TV Mode Screens

#### ► FULL TV (TV 1/3)

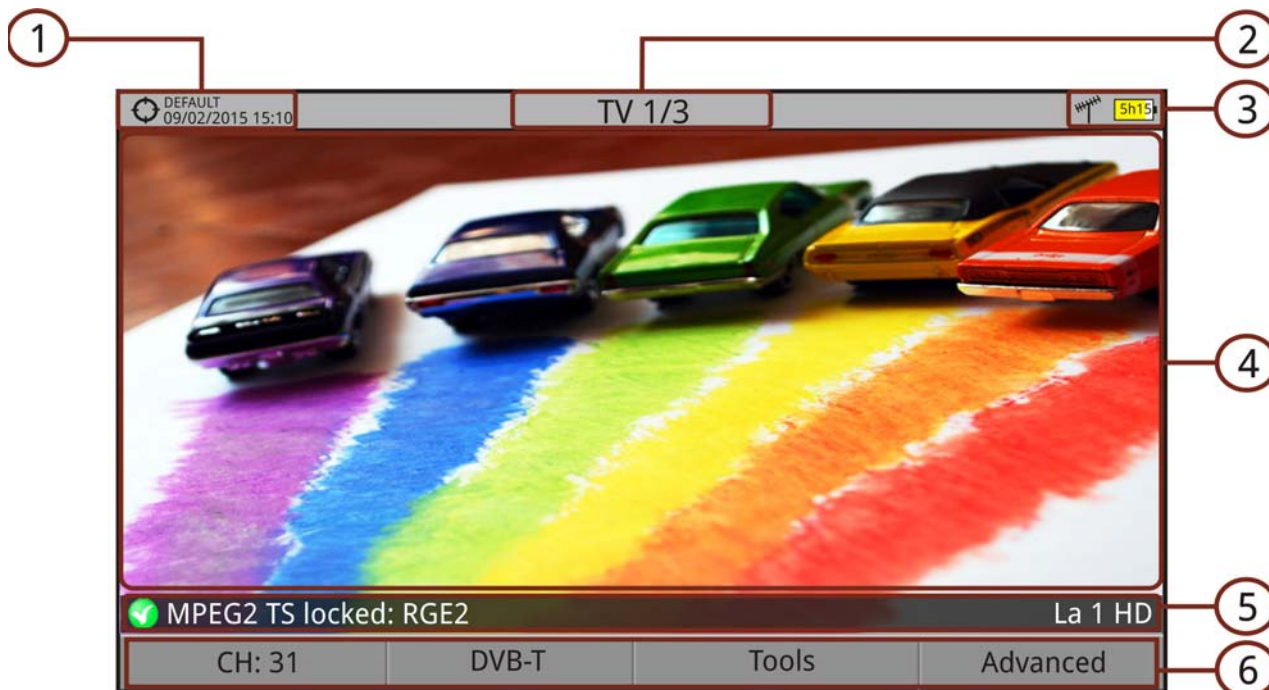

**Figure 51.**

- 1** Selected installation; date and time.
  - 2** Number of view/total views.
  - 3** Selected band, battery level.
  - 4** Tuned service image.
  - 5** Signal status (searching/locked/multiplex name) and name of the selected service.
  - 6** Softkeys menus.
- Joystick functions:
- Joystick up/down: It changes service.
  - Joystick left/right: It changes channel/frequency (depending on the tuning mode).



► TV + SPECTRUM + MEASUREMENT (TV 2/3)

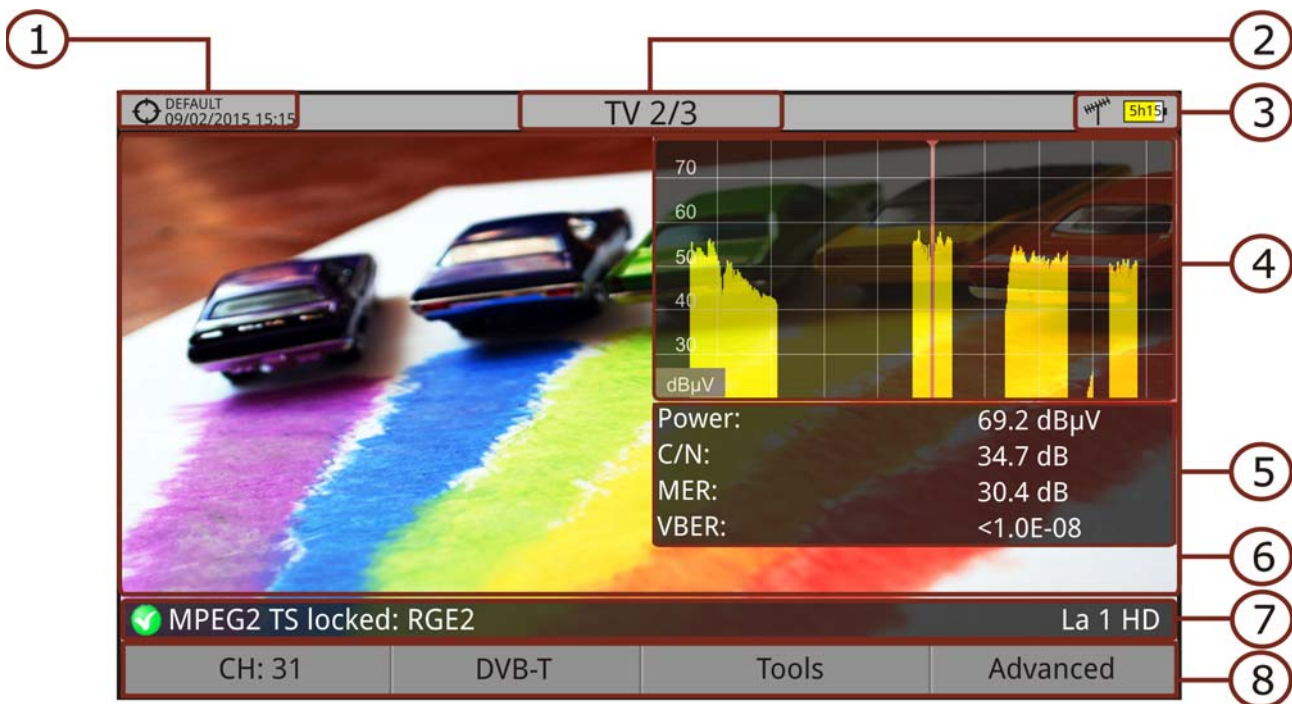

Figure 52.

- 1 Selected installation; date and time.
  - 2 Number of view/total views.
  - 3 Selected band, battery level.
  - 4 Tuned service image.
  - 5 Spectrum.
  - 6 Measured values of the signal in the frequency/channel the cursor is pointing.
  - 7 Signal status (searching/locked/multiplex name) and name of the selected service.
  - 8 Softkeys menus.
- Joystick functions:
- Joystick up/down: It changes service.
  - Joystick left/right: It changes channel/frequency (depending on the tuning mode).



► TV + SERVICE DATA (TV 3/3)

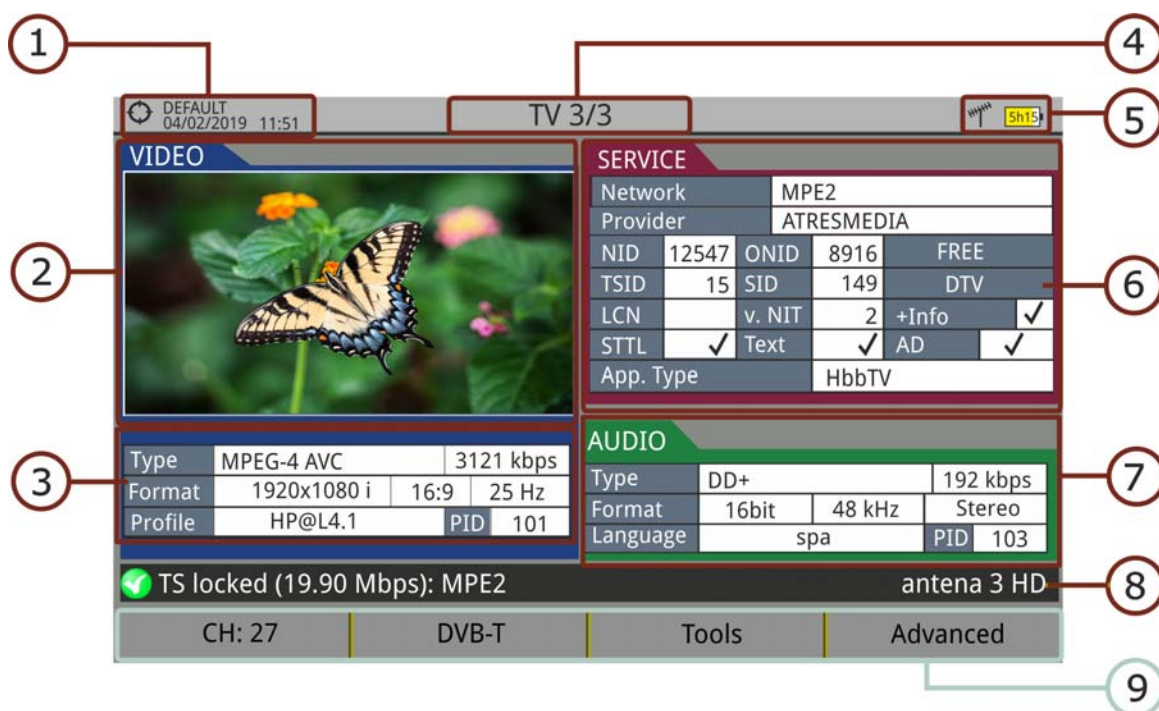

Figure 53.

- 1 Selected installation; date and time.
- 2 Tuned service image.
- 3 Tuned service information.
  - TYPE: Encoding type and video transmission rate.
  - FORMAT: Resolution (horizontal x vertical), aspect ratio and frequency.
  - PROFILE: Profile level.
  - PID: Video program identifier.
- 4 Number of view/total views.
- 5 Selected band; battery level.
- 6 Tuned service information.
  - NETWORK: Television distribution network (Terrestrial). Orbital position (Satellite).
  - PROVIDER: Program provider name.
  - NID: Network identifier where the signal is distributed.
  - ONID: Identifier of the original network where the signal originates.
  - TSID: Transport stream identifier.
  - SID: Service Identifier.



- App. Type: Type of detected interactive service such as HbbTV, MHP and MHEG-5. It also shows the URL related to the interactive service in F4: Advanced - Discovered URLs.
  - LCN: Logic Channel Number. It is the first logic number assigned to the first channel in the receiver.
  - +Info: Additional service information.
  - v. NIT: Network Information Table (NIT) version.
  - FREE/SCRAMBLED: Free/scrambled transmission.
  - DTV/DS: Standard type of transmission.
  - STTL: Subtitles available.
  - Text: Teletext available.
  - AD: Audio description available (for visually impaired).
- 7** Tuned Audio Information.
- TYPE: Type of audio encoding and transmission speed.
  - FORMAT: Service audio format. Bit depth; sampling frequency; sound reproduction.
  - LANGUAGE: Broadcasting language.
  - PID: ID of the audio program.
- 8** Signal status (searching/locked/multiplex name) and name of the selected service.
- 9** Softkeys menu.
- Joystick functions:
    - Joystick up/down: It changes service.
    - Joystick left/right: It changes channel/frequency (depending on the tuning mode).

**NOTE:** For services with video in 4K UHD, it shows a sequence of fixed images (frames) extracted from the video by means of the "4K Frame Grabber" function available in the F4 Advanced menu.

**NOTE:** PID, NID, ONID, TSID and SID fields can be shown in decimal or hexadecimal format. To select this parameter go to "Values Format" in "Preferences" - "Appearance".



▶ AUDIO RADIO (RADIO 1/3)



Figure 54.

▶ AUDIO RADIO + SPECTRUM + MEASUREMENT (RADIO 2/3)

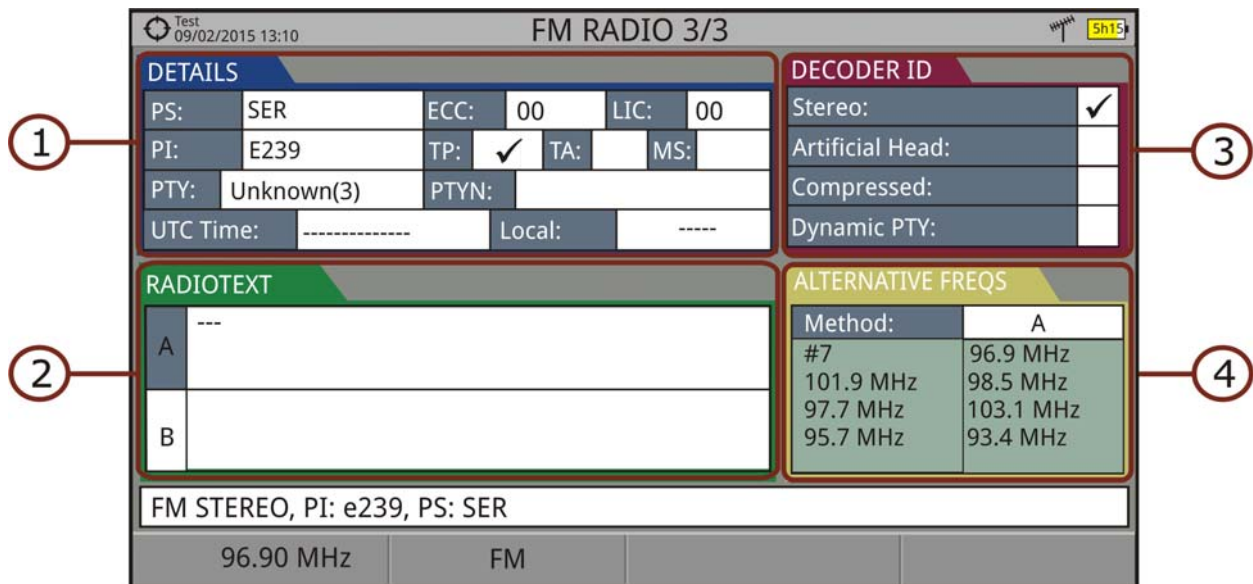

Figure 55.





► **AUDIO RADIO + RDS DATA (RADIO 3/3)**



**Figure 56.**

- 1** RDS Data:
  - PS: Programme service.
  - PI: Programme Identification.
  - PTY: Program type.
  - UTC Time: Universal time.
  - Local: Local time.
  - ECC: Extended country code.
  - LIC: Language Identification Code.
  - TP: Traffic program.
  - TA: Traffic announcement.
  - MS: Music switcher.
- 2** Radiotext: Extra text information.
- 3** Decoder ID: It identifies different operation modes of the decoder.
- 4** Alternative Freqs: : It shows alternative frequencies and its total number.



## 4.6 Additional Functions

In this chapter there is explained some additional functions for the meter. There are:

- Generic Signal
- Locking a Signal
- Satellite Identification
- IRG Descriptor
- 4K Decoding
- LTE Signals

### 4.6.1 Generic Signal



This is a special digital signal that the equipment does not demodulate. It can be used for special signals as DAB/DAB + or COFDM modulation with narrow BW.

To select this type of signal press  and in "Signal Type" select GENERIC.

In this type of signal the user can select the signal bandwidth by accessing the "Signal Parameters" also from menu on the  key.

The power measure and C/N ratio is calculated according to the bandwidth selected by the user. The triple cursor shows on screen the BW selected by the user.

### 4.6.2 Locking a Signal

- 1 Connect the cable with the input signal to the **RF** input connector.
- 2 On Preferences  (1s) -> Stealth-ID check the signals that the equipment should try to identify during the automatic searching process.
- 3 Press  and enable StealthID function (On).
- 4 Press the **Spectrum** key . The spectrum of the signal is displayed.
- 5 Adjust the span (recommended value for a terrestrial signal 50 MHz and for a satellite signal 100 MHz). The current value of the span is at the right bottom of the screen.
- 6 Find the frequency of the signal by moving the joystick left or right.



- 7 If you know the channel number change the tuning by frequency to tuning by channel. The channel mode allows you to navigate from channel to channel, using the selected channel plan.
- 8 When the channel is locked information appears at the bottom left of the screen. A triple cursor shows the detected BW for a digital carrier.
- 9 The equipment automatically detects transmission parameters of the signal and makes the corresponding measurements.

#### 4.6.3 Satellite Identification

The spectrum analyzer makes easier the fieldwork for engineers when working with SNG mobile units and VSAT communications, since it allows adjusting transmission-reception systems. It also has several functions to identify satellites that avoid any possibility of error. When the signal is locked it identifies the satellite and shows on screen its name.

Often satellite operators request to look for the Beacon signal, as a method of satellite identification. This signal is easily identified by the meter, because it has high resolution, high sensitivity and short sweep times.

Below are two Beacon screen-shots signals, with a span of 10 MHz and a bandwidth of 100 kHz resolution, all with a sweep time of 90 ms.

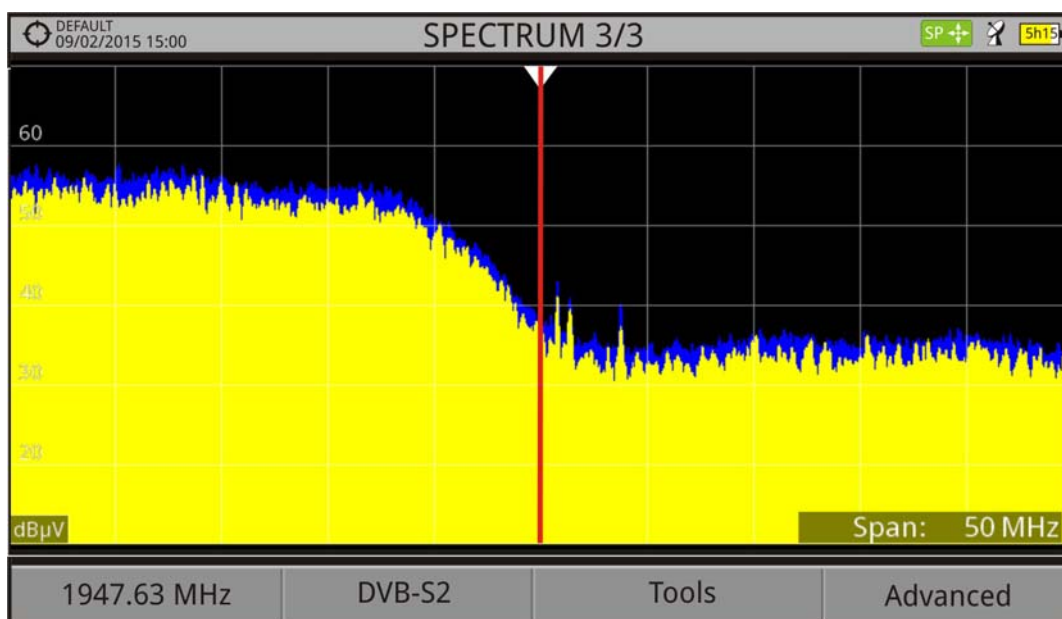

Figure 57.

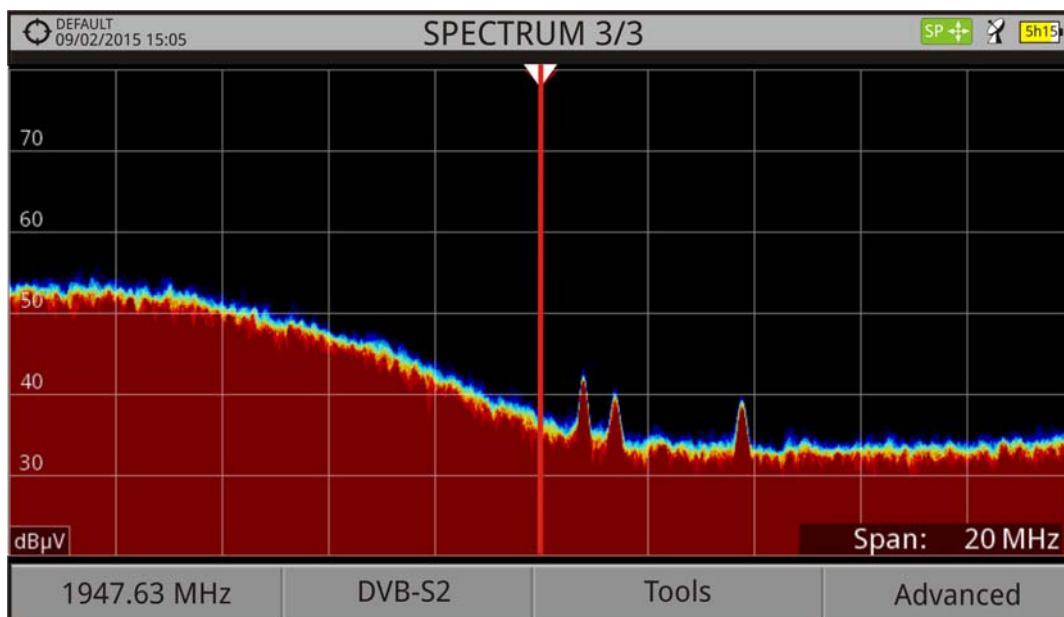

Figure 58.

More info about satellite signals in the application note "How to point a dish antenna" available on the [PROMAX website](#).

#### 4.6.4 IRG Descriptor

The analyzer is compatible with IRG recommendations and it can extract the Carrier ID information and display it conveniently showing all the details.

This information is useful to identify the interference, thanks to the carrier ID. This identifier provides enough information to detect the interference source (customer name, contact data, geo coordinates, etc.) and allows the operators to communicate directly with the RFI source to resolve the incident.

IRG descriptor function is available only for signals containing the carrier identifier. To access this feature:

- 1 Connect the **RF** input signal to the equipment.
- 2 Tune the channel that produces interferences.
- 3 Access the **TV** mode and press the **Advanced** menu (F4).
- 4 Select the **TS Data** option. If the signal has a carrier identifier, this option is enabled. If the signal does not contain this identifier, this option is disabled.
- 5 The **IRG descriptor** window is displayed with the data about the provider (see figure below).

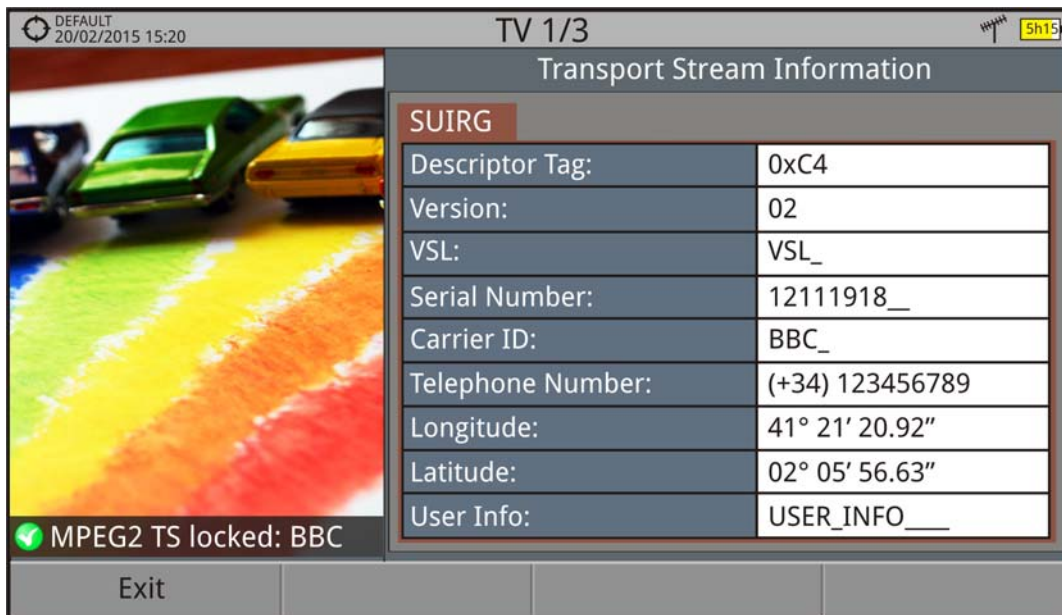

Figure 59.

#### 4.6.5 4K Decoding

The equipment can identify the HEVC (H.265) signalling and display its transmission data such as the video type, profile format, aspect ratio, bit rate and image.

RANGER *Neo* Lite and RANGER *Neo* + have the "4K Frame Grabber" function. This function decodes UHD video frames and displays them on screen as a slideshow

#### 4.6.6 LTE Signals

The equipment can measure LTE signals at 900 MHz (band 8) or at 2600 GHz (band 7)\*.

- 1 Connect the RF input signal to the equipment. In "Settings" select the RF source signal and the terrestrial band.
- 2 Select the Spectrum Analyzer mode . Press **F2** and select the GENERIC signal.
- 3 In this kind of signal the user can select its bandwidth from "Signal Parameters" on key **F2**. Usually the bandwidth for this signal is 10 MHz.

\*. Band 7 is an expansion option available for RANGER *Neo* +. Refer to annex.



- 4 Now press F1 and select tuning by channel or frequency. If you have a channel plan with the operators channels\* then use the tuning by channel. If not then use tuning by frequency.
- 5 If using tuning by frequency, enter the frequency for the operator's link you want to measure. If using tuning by channel just select a channel.



Figura 60.

- 6 Set the SPAN to better signal view. Measure on downlink and uplink frequencies.

---

\*. Contact PROMAX for specific LTE channel plans.

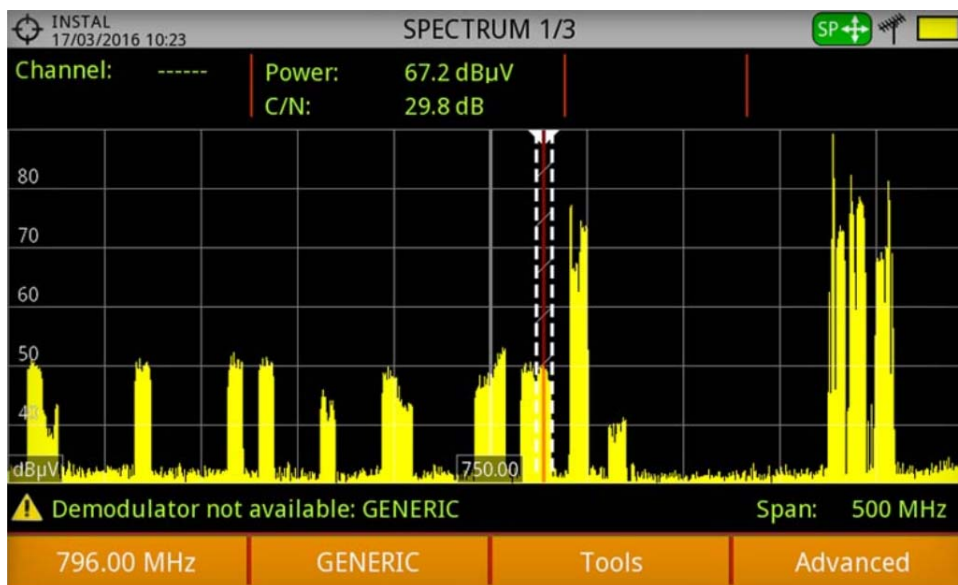

## 5 TOOLS

### 5.1 Introduction

Tools are specific functions that complement the standard functions of the meter. These tools can help solve specific situations where the usual measurement is not enough. In this chapter, each of these tools is described in detail. It is advisable to know them to make the most of the meter potential.

Tools are accessible by pressing the key . Some tools may be disabled or unavailable when they are incompatible with the type of signal tuned.

The following lists shows all available tools and the type of signal they are compatible with:

| Name   | Type of Signal  | Additional Data                             |
|--|---|---|
| <a href="#">Constellation</a>                        | All digital signals   |   |
| <a href="#">LTE Ingress Test</a>                     | All terrestrial digital signals   |   |
| <a href="#">Echoes</a>                               | DVB-T, DVB-T2, DVB-C2   |   |
| <a href="#">MER by Carrier</a>                       | DVB-T, DVB-T2, DVB-C2   |   |
| <a href="#">MEROGRAM</a>                             | DVB-T, DVB-T2, DVB-C2   |   |
| <a href="#">Spectrogram</a>                          | All signals   |   |
| <a href="#">Attenuation Test</a>                     | All signals   |   |
| <a href="#">Signal Monitoring*</a>                   | All signals   |   |
| <a href="#">Datalogger</a>                           | All signals   |   |
| <a href="#">Screen and Data Capture (Export key)</a> | DVB-T, DVB-T2, DVB-S, DVB-S2, DSS, DVB-C, DVB-C2, analogue, FM, generic | Also for other source signals: WiFi and OTT |
| <a href="#">Explore Channel Plan</a>                 | All signals   |   |
| <a href="#">Discover FM Stations</a>                 | FM  |   |
| <a href="#">Field Strength</a>                       | All signals   |   |
| <a href="#">Task Planner</a>                         | All signals   |   |
| <a href="#">Shoulders Attenuation**</a>              | DVB-T, DVB-T2, DVB-C, DVB-C2  |   |
| <a href="#">Service Recording</a>                    | DVB-T, DVB-T2, DVB-S, DVB-S2, DSS, DVB-C, DVB-C2, IPTV                  |   |
| <a href="#">Tilt***</a>                              | All terrestrial signals   |   |
| <a href="#">Scan****</a>                             | All terrestrial signals   |   |
| <a href="#">Streaming V/A*****</a>                   | All signals   |   |

- \*. only available for **RANGER Neo +**
- \*\*.. only available for **RANGER Neo +**
- \*\*\*. only available for **RANGER Neo +**
- \*\*\*\*. only available for **RANGER Neo +**
- \*\*\*\*\*. only available for **RANGER Neo +**



## 5.2 Constellation

### 5.2.1 Description

The constellation diagram is a graphic representation of the digital symbols received over a period of time. There are different types of constellation diagrams according to the modulation type.

In the case of an ideal transmission channel without noise or interference, all symbols are recognized by the demodulator without errors. In this case, they are represented in the constellation diagram as well defined points hitting in the same area forming a very concentrated dot.

Noise and interferences cause the demodulator to not always read the symbols correctly. In this case hits are dispersed and create different forms which can visually determine the type of problem in the signal.

Each type of modulation is represented differently. A 16-QAM signal is shown on screen by a diagram of a total of 16 different zones and a 64-QAM signal is represented by a diagram of 64 different zones and so on.

The constellation diagram shows in different colours the density of hits and includes features to zoom, move and delete the display on screen.

### 5.2.2 Operation

The constellation is available to all **digital** signals, both **terrestrial** and **satellite**.

To access the **Constellation** tool:

- 1 Connect the **RF** input signal to the equipment.
- 2 Tune to a digital signal from satellite or terrestrial band.
- 3 Press the  key (Tools).
- 4 Select **Constellation**.
- 5 The **Constellation** of the tuned signal appears.





► Screen Description

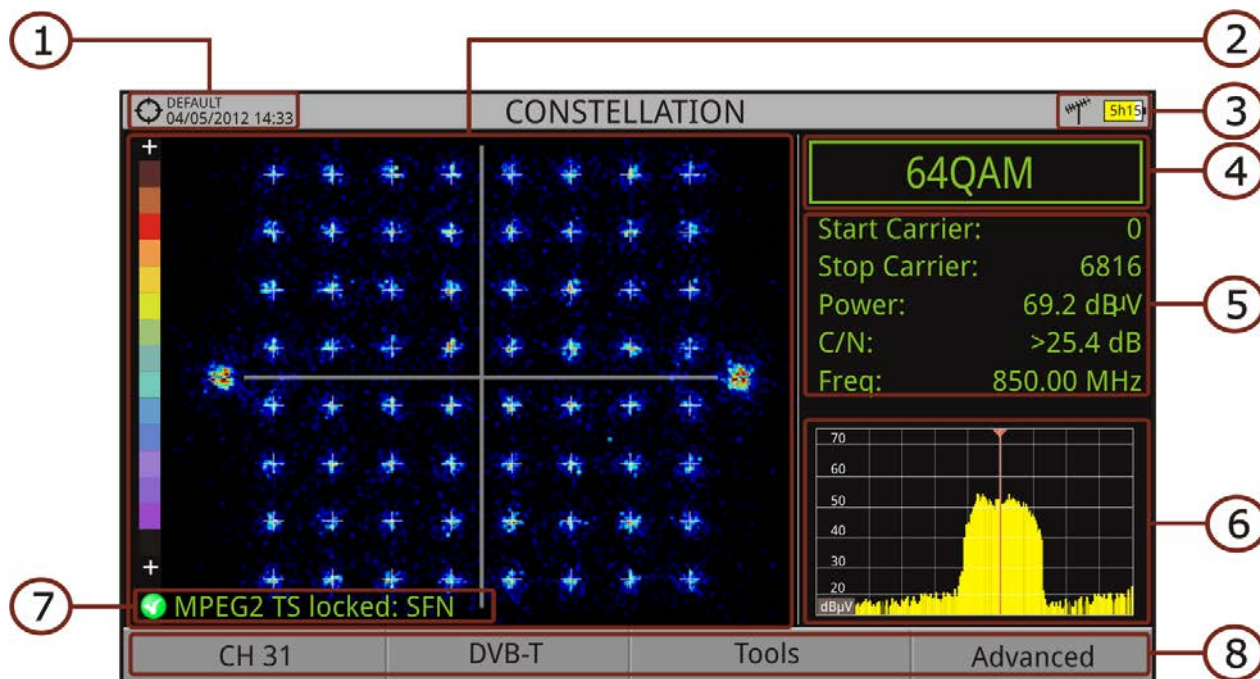

Figure 61.





- 1 Selected installation; date and time.
- 2 Constellation window. The colour scale placed at the left side indicates the signal quality in a qualitative way by a gradation of colours proportional to the density of symbols concentrated in a given area. The colour scale ranges from black (no symbols) to red (highest density). Greater dispersion of the symbols indicates higher noise level or worse signal quality signal. If there is symbols concentration with respect to the full grid (see advanced menu for types of grid) this is indicative of good ratio signal/noise or absence of problems.
- 3 Selected band; battery level.
- 4 Constellation modulation.
- 5 Data Window. Data shown are: Start Carrier, Stop Carrier, Power, C/N and frequency/channel.
- 6 Spectrum of the tuned signal. Spectrum is displayed with the span selected at the **Spectrum** mode.
- 7 Signal status (searching/locked/multiplex name).
- 8 Softkeys menus.



- Joystick functions:
  - Joystick left/right: Frequency/Channel change (depending on the tuning mode).

### 5.2.3 Menu Options

On the bottom of the screen there are four menus accessible via the function keys.

-  F1 It displays the channel / frequency where is pointing the cursor, accesses the tuning menu and allows selecting the channel plan.
-  F2 It displays the selected transmission standard menu and accesses the signal parameters.
-  F3 It displays the Tools menu.
-  F4 It displays the Advanced menu.

In the **Advanced** menu there are some options to set the constellation tool. They are:

- Grid type:
  - Full Grid: The grid where the constellation is displayed is a complete grid.
  - Cross Grid: The grid where the constellation is displayed is made of crosses.
- Persistence: It allows the user to set the level of persistence, which is the lapse of time the signal stays on the screen before disappearing. Available options according to the persistence level are: low, medium, high or permanent.
- Zoom: It allows the user to select a quarter (I, II, III or IV) where apply the zoom in. To come back to normal view select All.
- Start Carrier/Stop Carrier: This option allows selecting the range of carriers to be displayed between the first and last.
- Clear: This option clears all symbols in the whole constellation window.



## 5.3 LTE Ingress Test

### 5.3.1 Description

**Long Term Evolution** is a new standard for mobile networks. This mobile communication standard uses a frequency band close to the bands used by television. For this reason it can cause interferences.

The equipment allows you to use an LTE external filter to put on the RF input connector. This filter can be enabled to check if the quality of the TV signal reception improves, when much of the LTE band has been attenuated by the filter. With this tool you can measure the MER of a DTT channel, presumably affected by an LTE signal, and evaluate the effects of enabling an LTE filter.

To be clarified that these filters cannot completely remove the LTE band signals. Especially for the TV channels close to 790 MHz, where is the end for the current UHF. If we are close to a LTE station with low downlink channels, a filter cannot be a sufficient solution.



Other options to better mitigate the LTE signals can be considered, such as a change in the location of the TV antenna or a passive shield in the way between the two antennas (TV and LTE).

For more information, refer to application note "LTE Digital Dividend" available on the [PROMAX website](#).

### 5.3.2 Operation







The **LTE Ingress Test** is available to all **Digital Terrestrial** signals.

#### ► Settings

- 1 Press the "**Installation manager**" key for one second to access "**Preferences**" settings.
- 2 Go to "**Tools**" tab and edit the LTE filter settings:
  - LTE Filter F. Min.: Select the minimum frequency for the external LTE filter.
  - LTE Filter F. Max.: Select the maximum frequency for the external LTE filter.
- 3 Once selected, press  to save changes and  to exit "Preferences".



## ► Operation

- 1 Connect the external **LTE** filter between the signal and the **RF** input.
- 2 Tune the channel that is possibly affected by a LTE interference.
- 3 Press the key : Tools.
- 4 Select the **LTE Ingress Test** mode.
- 5 Screen shows a confirmation message. Press on  "Yes" if filter is connected or  "No" if filter is not connected.
- 6 It starts to measure.
- 7 To change filter status (ON / OFF), press again the  key and will appear a confirmation message. Connect / disconnect the LTE filter at the RF input and then press  key: Ok to start measuring.
- 8 The user can enable / disable the LTE measure by pressing the  : **ON/ OFF**. Remember to connect / disconnect the LTE filter to the RF input. Each time a LTE measure starts, the time counter will reset.
- 9 Check how to connect and disconnect the LTE filter affects the installation, by comparing the MER measure and the LTE band power.



[Click here to watch this video: What is LTE](#)



► Screen Description

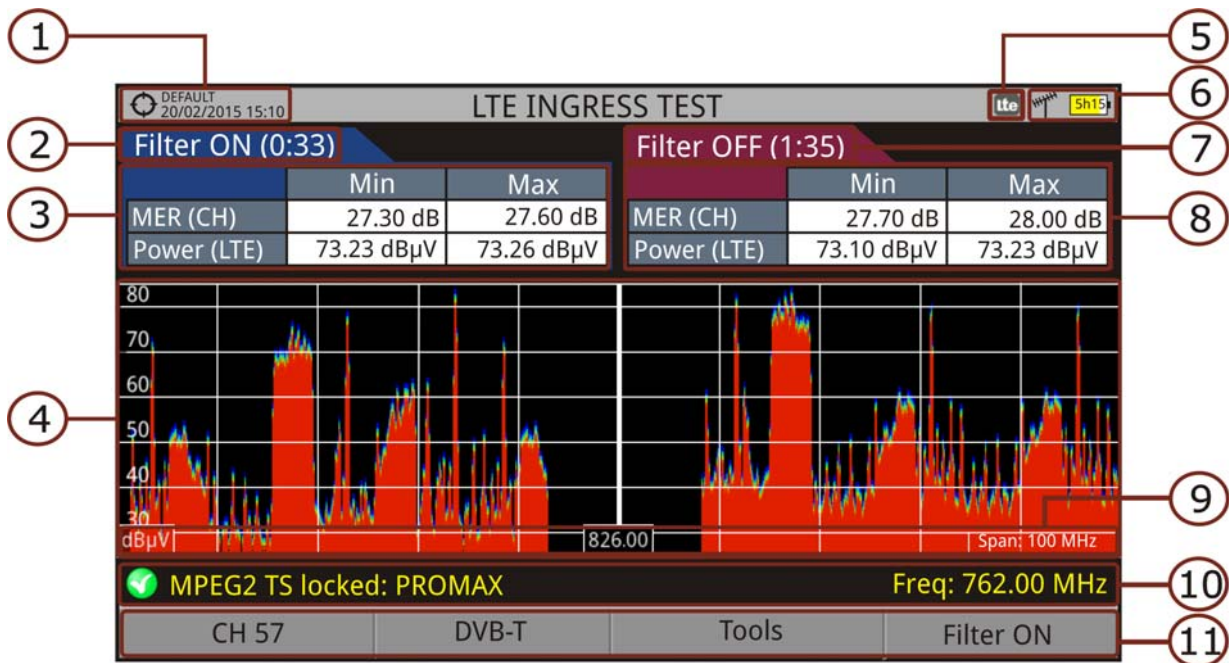

Figure 62.





- 1 Selected installation; date and time.
- 2 Elapsed time with filter enabled (ON).
- 3 Measurement with LTE filter enabled:
  - MER: Maximum and minimum MER for the TV channel tuned (the one probably affected by the LTE interference signal).
  - LTE Power: Maximum and minimum power for the complete band, between minimum and maximum filter frequencies.
- 4 Spectrum band, frequencies between minimum and maximum filter frequencies.
- 5 Identifier icon of the **LTE** filter ON (only when using internal LTE filter).
- 6 Selected band; battery level.
- 7 Time elapsed with filter disabled (OFF).
- 8 Measurement with LTE filter disabled:
  - MER: Maximum and minimum MER for the TV channel tuned (the one probably affected by the LTE interference signal).
  - LTE Power: Maximum and minimum power for the complete band, frequencies between minimum and maximum filter frequencies.
- 9 Measurement units/centre frequency/span (span: 10 MHz/division).
- 10 Signal status (searching/locked/multiplex name).



## 11 Softkeys menus.

### 5.3.3 Menu Options

On the bottom of the screen there are four menus accessible via the function keys.

-  F1 It displays channel/frequency and access the tuning menu. It allows selecting the channel plan and the channel where apply the LTE ingress test.
-  F2 It displays the selected transmission standard menu and accesses the signal parameters.
-  F3 It displays the Tools menu.
-  F4 It enables (ON) / disables (OFF) the LTE filter.

## 5.4 Echoes

### 5.4.1 Description

The **Echoes** function shows the response in time of a digital terrestrial channel and therefore it can detect echoes that can occur due to the simultaneous reception of the same signal from several transmitters with different delays and amplitudes.

Another cause that may cause echoes is reflection of the signal on large objects, as buildings or mountains. This may be the explanation that having a good C/N and a good signal, the BER does not reach the minimum value.

With the **Echoes** function is possible to know the distance from where the equipment is to the transmitter or the object that caused the echo. Thus, the installer can minimise the effect that the echo may cause on the installation, reorienting the antenna and reducing the effect of received echoes.

This function is only available for **DVB-T**, **DVB-T2** and **DVB-C2**. Therefore, previously have to configure the equipment for the reception of such signals.



## 5.4.2 Operation

Echoes function is available for **DVB-T**, **DVB-T2** and **DVB-C2** signals.

- 1 Connect the **RF** input signal to the equipment.
- 2 Tune a **DVB-T**, **DVB-T2** or **DVB-C2** digital signal at the terrestrial band.
- 3 Press the Tools (F3) key.
- 4 Select the Echoes option.
- 5 The **Echoes** function of the tuned signal appears on screen.

### ► Screen Description

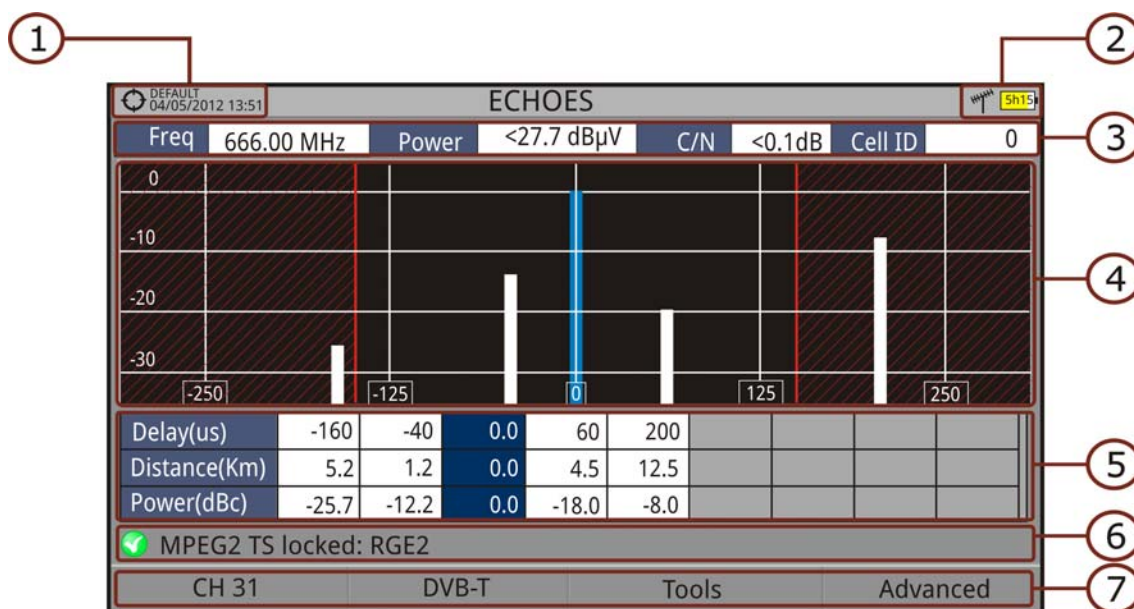

**Figure 63.**

- 1 Selected installation; date and time.
- 2 Selected band, battery level.
- 3 Main signal data: Frequency, Power, C/N and Cell ID (it shows the main signal transmitter, if available).
- 4 **Echoes** Diagram. The display shows a graphical representation of the echoes. The horizontal axis of the graph corresponds to the delay in receiving the echo on the main path (the stronger signal). The vertical axis represents the attenuation of the echo in dB on the main path.
- 5 Data box with main data regarding echoes. In the list of echoes it shows the power, the delay in microseconds and the distance in kilometres to the echoes.
- 6 Signal status (searching/locked/multiplex name).



## 7 Softkeys menus.





### ■ Joystick functions:

- Joystick left/right (**Channel/Frequency** mode): It changes the channel/frequency (according to the tuning type selected).
- Joystick left/right (Echoes mode): It changes echo.
- Joystick up/down (Echoes mode): It changes zoom.

Remember to press the joystick to switch between the **Echoes** (EC) mode and the **Channel/Frequency** (CH/FR) mode.

### 5.4.3 Menu Options

At the bottom of the screen there are four menus available via the function keys.

-  F1 It displays the channel/frequency where is pointing the cursor, it allows the user to select a channel or frequency, a channel plan and access the tuning menu.
-  F2 It displays the selected transmission standard menu and accesses the signal parameters.
-  F3 It displays the Tools menu.
-  F4 It displays the Advanced menu. The ZOOM option changes the zoom on the echoes windows. Zooms are 1x, 2x, 4x and 8x.

## 5.5 MER by Carrier\*

\*. only available for RANGER *Neo* +

### 5.5.1 Description

The MER by Carrier function analyses continuously the measure of the MER value for each one of the carriers forming the selected channel and they are displayed in a graphic on screen. This tool is especially useful for the analysis of systems in which signals of different type and origin interfere with each other, as may occur during the transition from analogue to digital TV.





## 5.5.2 Operation

The **MER by carrier** tool is available for signals with carriers: **DVB-T**, **DVB-T2** and **DVB-C2**.

- 1 Connect the **RF** input signal to the equipment.
- 2 Select terrestrial band and tune a **DVB-T**, **DVB-T2** or **DVB-C2** digital signal.
- 3 Press the **Tools** key .
- 4 Select **MER by carrier** option.
- 5 The MER function appears on screen.
- 6 To exit press any key of mode (TV mode, Spectrum mode or Measurement mode).

### ► Screen Description

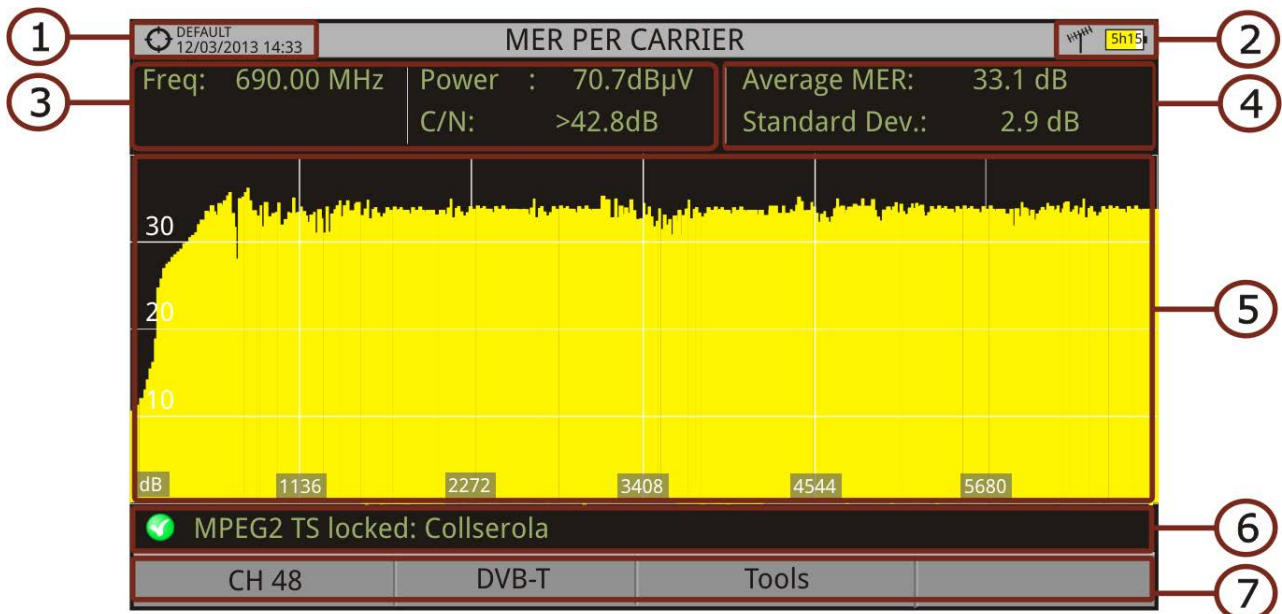



- 1 Selected installation; date and time.
- 2 Joystick active mode; Selected band, battery level.
- 3 Measurement values for the signal tuned at the frequency/channel selected.
- 4 Average measurement value and standard deviation value of MER.
- 5 **MER by carrier** graphic.
- 6 Signal status (searching/locked/multiplex name).
- 7 Softkeys menus.



- Joystick functions:
  - Joystick left/right: Channel/frequency change (according to the tuning mode).
- Axis description:
  - Axis X: Number of Carriers.
  - Axis Y: MER.

### 5.5.3 Menu Options

At the bottom of the screen there are three menus available via the function keys.

-  F1 It displays the channel/frequency where is pointing the cursor, it allows selecting channel plan and channel and access the tuning menu.
-  F2 It displays the selected transmission standard menu and accesses the signal parameters.
-  F3 It displays the Tools menu.

## 5.6 MEROGRAM\*

\*. only available for RANGER *Neo* +

### 5.6.1 Description

The MEROGRAMA function shows a graphical representation of the MER level for each carrier of the locked signal, which is superimposed over time. During the MEROGRAM function, maximum and minimum of some parameters and the time when they are reached are stored. This tool is especially useful for detecting sporadic problems over time.

### 5.6.2 Operation

The **MEROGRAM** function is available for signals with carriers: **DVB-T**, **DVB-T2** and **DVB-C2**.

- 1 Connect the **RF** input signal to the equipment.
- 2 Select the terrestrial band and tune a **DVB-T**, **DVB-T2** or **DVB-C2** channel or frequency.



- 3 Press the **Tools**  key.
- 4 Select the **MEROGRAM** function.
- 5 It shows the **MEROGRAM** function of the signal.
- 6 To exit press any key of mode (TV mode, Spectrum mode or Measurement mode). All data registered is cleaned after leaving.

► **Screen Description**

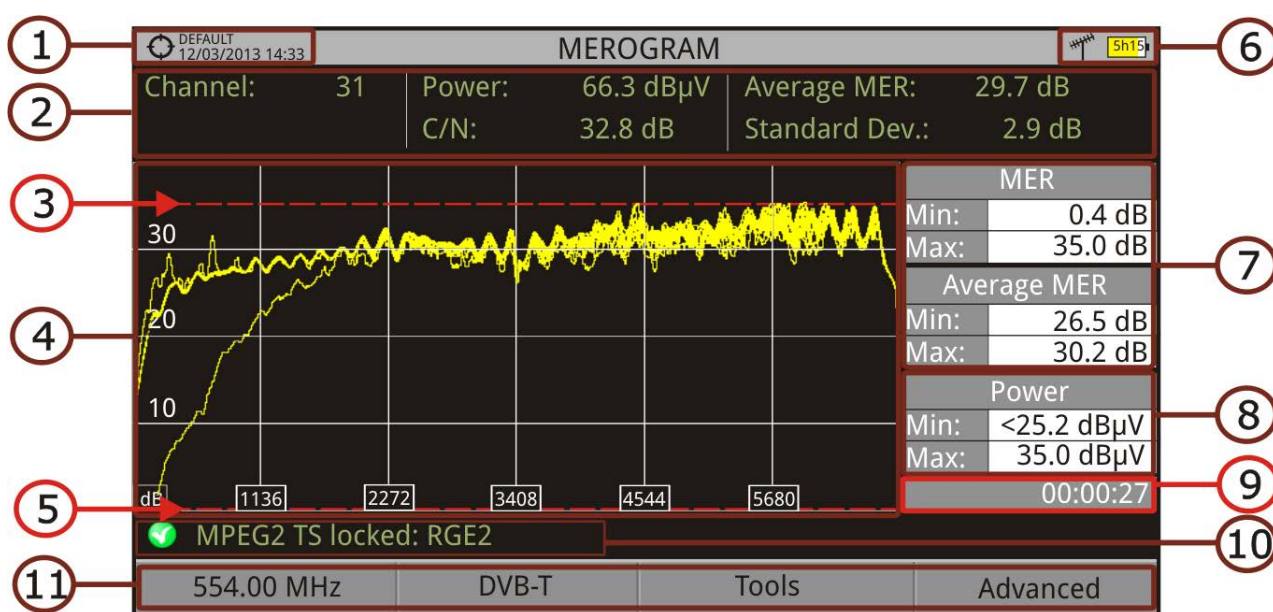

**Figure 64.**





- 1 Selected installation; date and time.
- 2 Measurement values for the signal tuned at the frequency/channel selected.
- 3 Maximum level of MER.
- 4 **MEROGRAM** graphic.
- 5 Minimum level of MER.
- 6 Selected band, battery level.
- 7 Maximum and minimum MER value and MER average over time.
- 8 Maximum and minimum value of the measure selected by the user in the option "User measure" (see next section).
- 9 Elapsed time after starting the **MEROGRAM** function.
- 10 Signal status (searching/locked/multiplex name).
- 11 Softkeys menus.



- Joystick functions:
  - No function in this tool.
- Axis Description:
  - Axis X: Number of Carriers.
  - Axis Y: Power.

### 5.6.3 Menu Options

At the bottom of the screen there are four menus available via the function keys.

-  It displays the channel/frequency where is pointing the cursor, it allows selecting channel plan and channel and access the tuning menu.
-  It displays the selected transmission standard menu and accesses the signal parameters.
-  It displays the Tools menu.
-  It displays the Advanced menu.

In the Advanced menu there are some options for the **MEROGRAM** function configuration. They are:

- User measure: It allows the user to select the measure to view on screen among the several available for each type of signal..
- Details: It allows the user to view on screen the date and time when maximum and minimum measures were reached. To quit this view press the key .
- Clear measures: It clears the **MEROGRAM** function, measurement and restarts the timer.

## 5.7 Spectrogram\*

\*. only available for RANGER *Neo* +

### 5.7.1 Description

The Spectrogram function shows a graphical representation of the spectrum superimposed over time of a channel or frequency selected by the user. During the Spectrogram, maximum and minimum of several measures and time are



registered. This tool is especially useful to analyse the behaviour of a spectrum over time, because sporadic and indeterminate anomalies can be detected.

### 5.7.2 Operation

The Spectrogram tool is available for all signals.

- 1 Connect the **RF** input signal to the equipment.
- 2 Select a channel or frequency.
- 3 Select the **SPAN** within the spectrogram will be displayed.
- 4 Press the **Tools** key .
- 5 Select the **Spectrogram** option.
- 6 It shows the **Spectrogram** of the signal.
- 7 To exit press any key of mode (**TV** mode, **Spectrum** mode or **Measurement** mode). All data registered is cleaned after leaving.

While using the Spectrogram function, if the signal unlocks, timer and measurement reset and they will start to register again when signal locks.

#### ► Screen Description

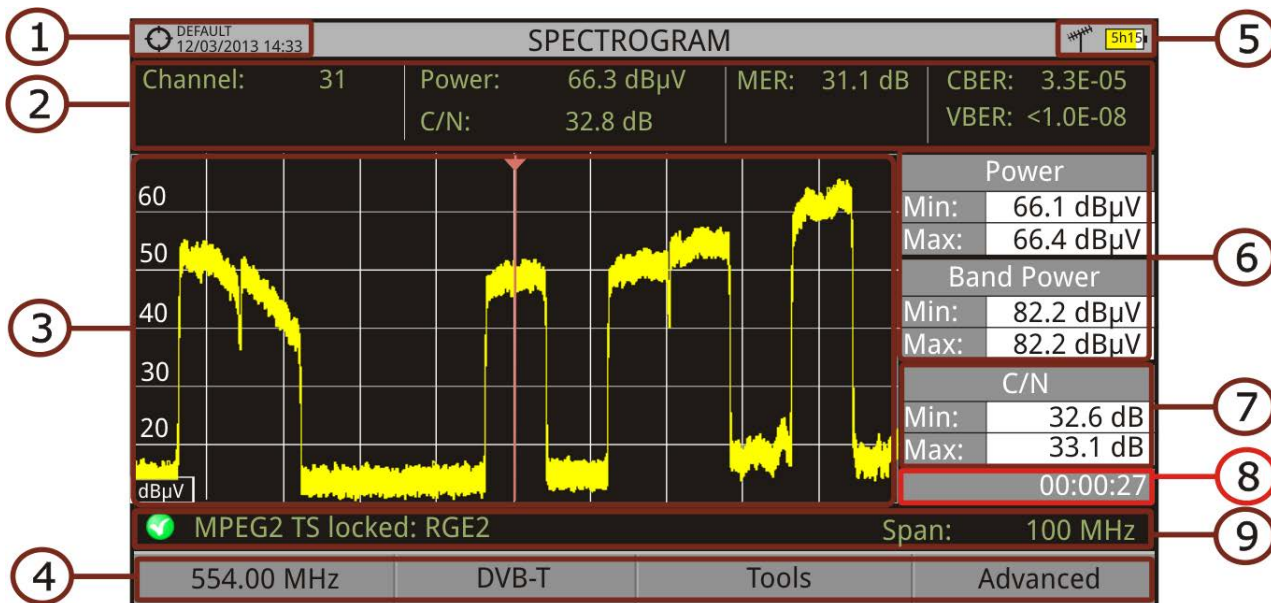

Figure 65.





- 1 Selected installation; date and time.
- 2 Measurement values for the signal tuned at the frequency/channel selected.
- 3 Spectrogram over time at the selected span.



- 4 Softkeys menus.
  - 5 Selected band, battery level.
  - 6 Maximum and minimum values of signal power and band power over time.
  - 7 Maximum and minimum value of the measure selected by the user in the option "User measure" (see next section).
  - 8 Elapsed time.
  - 9 Signal status (searching / locked / multiplex name / selected span).
- Joystick functions:
    - No function for this tool.
  - Axis description:
    - Axis X: Span (MHz).
    - Axis Y: Power.

### 5.7.3 Menu Options

At the bottom of the screen there are four menus available via the function keys.

-  It displays the channel/frequency where is pointing the cursor and access the tuning menu.
-  It displays the selected transmission standard menu and accesses the signal parameters.
-  It displays the Tools menu.
-  It displays the Advanced menu.

In the Advanced menu there are some options for the spectrogram configuration:

- User measure: It allows the user to select a measure to view on screen among the several available for each type of signal.
- Details: It allows the user to view on screen the date and time when maximum and minimum measures were reached. To quit this view press the key .



- Clear measures: It clears the spectrogram, measurement and restarts the timer.





## 5.8 Attenuation Test

### 5.8.1 Description

The Attenuation Test function allows the user to easily check the response of the telecommunications installations before antennas and headers are working. It allows the user to evaluate the response along the complete range of frequencies by measuring the losses (attenuation) in the distribution of TV signals, comparing reference levels at headend output and at each house antenna plugs.

### 5.8.2 Operation

Attenuation test function is available for all signals.

- 1 In **Settings**  select the terrestrial or satellite band.
- 2 Press the **Tools** key .
- 3 Select the **Attenuation Test** option.
- 4 The **Attenuation Test** function for the signal appears on screen.
- 5 First, set the parameters before the test, pressing the **Advanced**  key. Parameters to set are: Frequencies of pilot signals (pilot 0, pilot 1 and pilot 2), maximum attenuation and threshold attenuation (for more details refer to next section).
- 6 Then it is necessary to **Set References**. This requires a signal generator. We recommend to use of one of the PROMAX signal generators: **RP-050**, **RP-080**, **RP-110** or **RP-250** (depending on the frequency band).
- 7 Connect the generator and the meter where the origin of the signal distribution is in the installation (antenna, headend, etc.) or connect the generator directly to the RF input of the meter. If necessary, the meter can feed the generator using the **Supply Output** option from the **Settings** menu .
- 8 Active the signal generator and in the equipment, press the **Set Reference** key .
- 9 Once are set the references for the pilot signals, let the signal generator connected to the source point of the distribution system and take measurements in each user access point with the equipment.
- 10 In each measurement a message over each pilot signal indicates whether the measure "Pass" or "Fail" according to the parameters set.
- 11 The measurement data from the **Attenuation Test** can be saved through the **Datalogger** tool. To do this, when creating a new datalogger, in the option **Include Attenuation Tests**, select Terrestrial and/or Satellite. Then,



the user must perform a datalogger from the test point where he is performing the attenuation test. Another quick option it is to select the "Test & Go" function in the "Datalogger" menu. This option creates automatically one channel plan (TER ICT or SAT ICT according to the current band) and starts to save measurements. The data will be saved and can be checked and transferred to a PC. For more information, see "Datalogger" section under the "Tools" chapter. Also measurement data or screen image can be exported by pressing the **Export**  key (for more details refer to "[Screen and Data Capture \(Export key\)](#)" on page 113) and after that display the images or download the data files (in XML format).

**NOTE:** In both satellite and terrestrial band, the system saves the LNB state every time the user sets a reference and uses this value always that the equipment is working in this mode.

### ► Screen Description

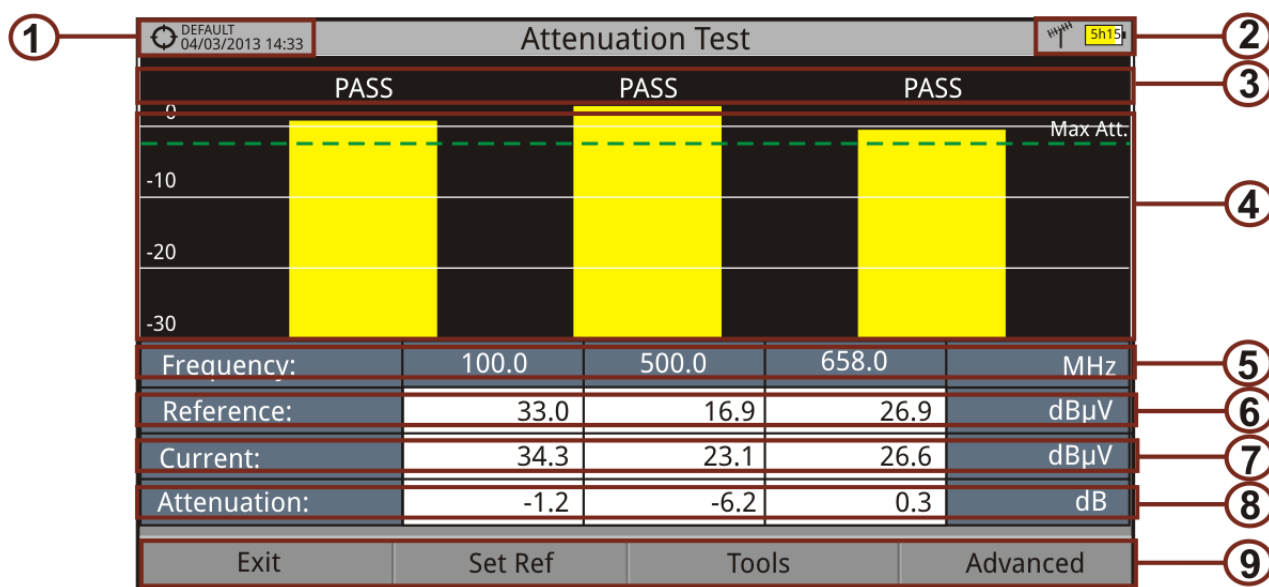

**Figure 66.**

- 1 Installation selected, date and time.
- 2 Selected band; battery level.
- 3 Status message depending on the attenuation level.
- 4 Power level of the signal.
- 5 Signal Frequency (MHz).
- 6 Power level of the reference signal obtained when setting the reference and used to calculate the attenuation level (dB $\mu$ V).
- 7 Power level of the test signal at the user access point (dB $\mu$ V).
- 8 Attenuation level (dB); Attenuation = Reference - Current.









## 9 Softkeys.

- Joystick functions:
  - No function for this tool.
- Axis description:
  - Axis X: Pilot signals.
  - Axis Y: Power.

### 5.8.3 Menu Options

In the bottom of the screen are four menu accessible via the softkeys.

-  Exits the tool.
-  Pressing this option the current power values are captured and they are assigned as reference values.
-  Access the Tools main menu.
-  Access the Advanced menu.

In the **Advanced** menu there are five parameters to set the attenuation test. They are:

- **Threshold Attenuation:** It defines the maximum difference that may exist between the pilot signal of higher level and the pilot signal of lower level. All pilot signals out of this range will be removed and not used as a pilot signal during the measurement process.
- **Maximum Attenuation:** It sets the attenuation level used by the equipment to show on screen if the signal passes or fails. When the attenuation level is below this value the message on screen is "**PASS**" and when it is above this value is "**FAIL**".
- **Pilot 0:** It defines the frequency of the pilot signal 0 (MHz).
- **Pilot 1:** It defines the frequency of the pilot signal 1 (MHz).
- **Pilot 2:** It defines the frequency of the pilot signal 2 (MHz).



## 5.9 Signal Monitoring\*







\*. only available for RANGER Neo +

### 5.9.1 Description

The Signal Monitoring tool allows monitoring one locked signal or a channel plan (several channels) by measuring its power and other parameters over time. All this data can be downloaded to a PC and exported to a file for later analysis.

### 5.9.2 Operation

The Signal Monitoring tool is available for all RF signals.

- 1 In Settings  select the source of signal RF and terrestrial or satellite band.
- 2 Access the Spectrum mode. Select the channel plan (key F1) and tune the signal for monitoring.
  - In case of tuning a **DVB-T2** signal, in the **Signal Parameters** menu  select the Profile (Base or Lite) and in the  key select the PLP identifier. User has to choose one profile and one PLP identifier per each monitoring.
- 3 Press the **Tools** key .
- 4 Select the **Signal Monitoring** option.
- 5 Select between monitoring a **single channel** or a **channel plan**.
- 6 The **Signal Monitoring** function appears on screen.
- 7 Before starting the monitoring, access the **Configuration** option in the **Advanced** menu  for settings (for more details refer to next section).
- 8 Access the **Advanced** menu  and press **Start** to start the signal monitoring. Before starting, it shows some warnings in case the signal is unlocked, to confirm the signal parameters and if the file name already existed.
- 9 In **Continuous** mode, the equipment takes samples automatically according to sample time (see next section). In **Manual** mode each time the user presses the joystick the equipment takes a sample. In **Schedule** mode it starts to take samples automatically at the end of the countdown to the starting time.
- 10 Access the **Advanced** menu  and press on **Stop** to finish the signal monitoring. Data obtained is automatically stored.



- 11 After stopped, it gives the option to access the Signal Monitoring Viewer that allows the user to watch the final results (for more details refer to ["Data Viewer" on page 102](#)).
- 12 You can also access data by pressing the **Installation Management** key  to check that the monitoring data file has been saved. This file is a "Signal Monitoring" type. To manage the data, see below the section "Data File Processing".

► **Screen Description**

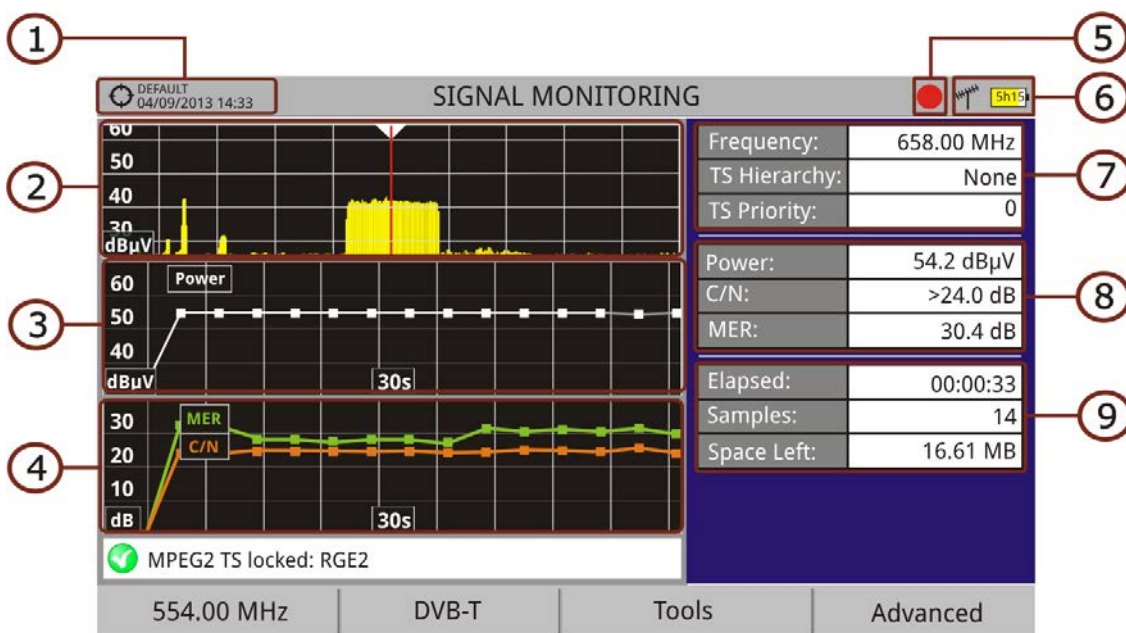

**Figure 67. Single Channel Monitoring**

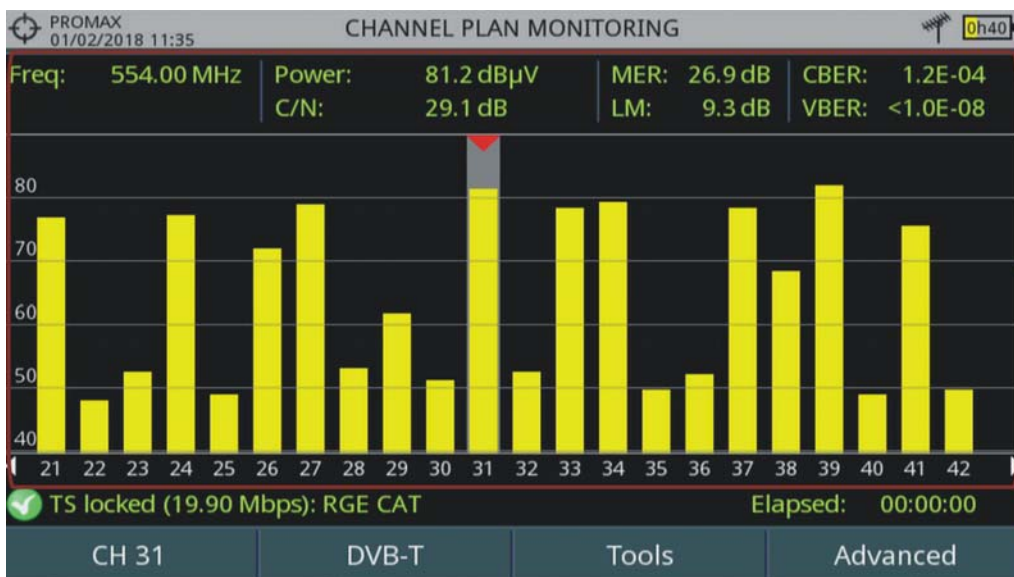

**Figure 68. Channel Plan Monitoring**





- 1 Selected installation; date and time.
- 2 Spectrum.
- 3 Power measurement over time (window size is span time set in configuration).
- 4 MER and C/N measurement over time (window size is span time set in configuration).
- 5 Indicator of signal monitoring started.
- 6 LNB, Selected band; battery level.
- 7 Signal information window 1:
  - **Frequency**: frequency at which signal is locked; **Profile** (only for DVB-T2 signals): Base or Lite; **PLP identifier** (only for DVB-T2 signals): identifier of the layer being measured, **TS Hierarchy** (table hierarchy at the transport stream) **TS Priority** (packet priority at the transport stream).
- 8 Signal information window 2:
  - Measurements of the signal over time.
- 9 Signal information window 3:
  - **File name**: Name of the current monitoring.
  - **Elapsed**: Time elapsed since the beginning of the monitoring.
  - **Samples**: Samples taken since the beginning of the monitoring.
  - **Space left**: Space left in the memory to save data.
- 10 Channels from the channel plan being monitored. Measurement data are from the selected channel (pointed by a red arrowhead).



- Joystick functions:
  - No function for this tool.
- Axis Description (Single channel monitoring screen):
  - Axis X: Window 1: Frequency; Window 2 and 3: Time.
  - Axis Y: Window 1 and 2: Power; Window 3: MER and C/N.

### 5.9.3 Menu Options

At the bottom of the screen there are four menus available via the function keys.

-  It displays the channel/frequency where is pointing the cursor and access the tuning menu.
-  It displays the selected transmission standard menu and accesses the signal parameters.
-  It displays the Tools menu.
-  It displays the Advanced menu.

In the **Advanced** menu there are some options for the **Signal Monitoring**. They are:

- **Start:** It starts the signal monitoring.
- **Stop:** It stops the signal monitoring.
- **Pause:** It stops the signal monitoring for a while until resuming.
- **Configuration:** It shows the settings window with some parameters (for more details refer to next section).
- **Audio:** It allows enable or disable audio. When this option is enabled, the user can listen to any service in the monitored signal, knowing about signal reception while driving or doing other tasks.



## 5.9.4 Settings

User can adjust some parameters on the Signal Monitoring:



**Figure 69. Settings for Single Channel Monitoring**

- **File Name:** User can give a name to the file where data is saved. All measurement will be stored on the data file. Be sure to change the file name when starting a new signal monitoring. If not, after a warning message, the new data file will be saved on the last one.
- **Comment:** User can write some comments about the monitoring.
- **Mode:** There are **three operation modes**:
  - Continuous: A sample is taken automatically every sample time.
  - Manual: A sample is taken every time that user presses the joystick.
  - Schedule: User defines starting time for monitoring. Then he must press on "Start" in Advanced menu (F4) to start the countdown to the starting time.
- **Sample Time:** Time between samples. Only when working in continuous or schedule mode. Minimum time is 1 second.
- **Span Time (only for single channel monitoring):** It is the width, in time, shown on screen for the X axis.
- **Save to:** There are **two** options: **Internal** or **USB**. For Internal option it saves the file with all data in the internal memory of the equipment. For USB option it saves the file with all data in a USB flash-drive connected to the port of the equipment.
- **GPS Alarm:** If this box is checked then it sounds a beep when the GPS is unlocked.



### 5.9.5 Data Viewer

The data viewer allows the user to watch the monitoring final results. It accesses directly when signal monitoring ends or also by opening the data file in the installation management screen.

#### ► Screen Description



**Figure 70.**

- 1 Selected installation; date and time.
- 2 Power measurement over time.
- 3 MER and C/N measurement over time.
- 4 Joystick mode selected: PA mode (panoramic) or MA mode (cursor movement).
- 5 LNB, selected band; battery level.
- 6 Signal information window 1: Measurement where the cursor is.
- 7 Signal information window 2: Date, time and elapsed time.
- 8 Scroll-bar: it shows position and size of the data displayed related to total data.
- 9 Time span of displayed data.
- 10 Menu Options:
  - F1: Exits the data viewer.
  - F2: It shows transmission parameters of the monitored signal.
  - F3: It shows the monitored channel or for channel plan it allows selecting the channel to view data.



■ Joystick functions:

- Joystick up/down: It increases / decreases zoom.
- Joystick left/right: In PA mode it moves time span along the total time. In MA mode it moves the cursor along the samples of the time span.
- Joystick Press: It switches between panoramic (PA) and movement (MA) mode.

## 5.9.6 Data File Processing

### ► Description

This document is an explanation about the process that is needed to be done in order to obtain a more comfortable view of the XML data obtained with the meter, when performing a Signal Monitoring.

Once you got the monitoring data, copy the XML data file from the equipment to a USB memory using the Installation Manager. See the equipment's documentation in how to get files from an Installation.

### ► Obtaining an excel file

For this section, you must have at least Excel 2003 or newer version. Excel 2007 (or later) is highly recommended to avoid macro problems.

- 1 First of all we need to locate the XML data file in the folder from which we want to work. There are no requirements needed to be satisfied. A file named COVERAGE.XSL must be placed in the same data file folder. That second file allows proper data formatting when processed by Excel.
- 2 Select the XML data file and then right click with the mouse button on the file name.
- 3 Choose the option "**Open with**" and then select Excel 2007 (or the available version).



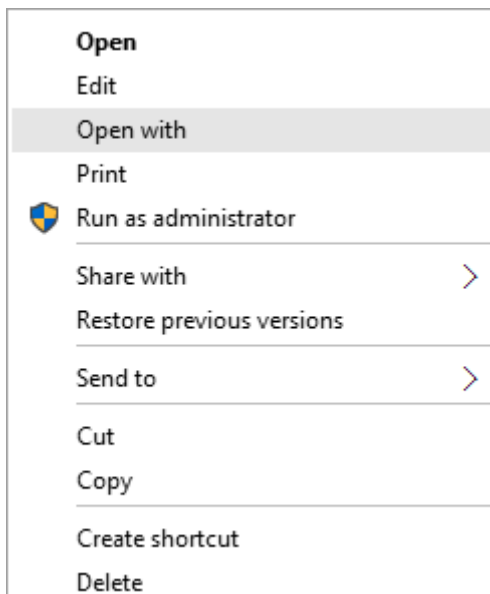

**Figure 71.**

- 4 When Excel tries to open the file it will ask you the import method to open the XML data file by this way:

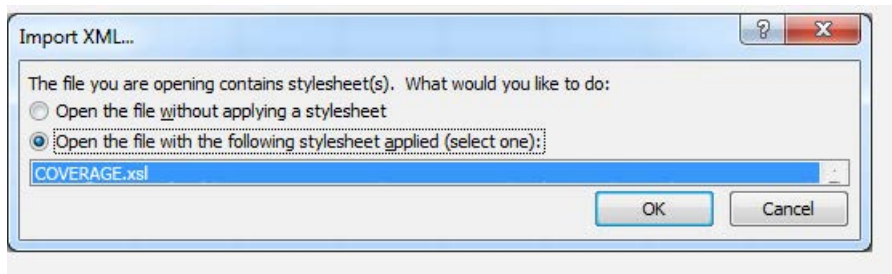

**Figure 72.**

- 5 You must choose the option in which a stylesheet is asked. It will appear as an option the "COVERAGE.xsl" file.
- 6 Now Excel is opening the XML data file using the format that the XSL file is providing. This step could take few seconds depending on the size of the XML data file.
- 7 At this point, you should have an excel file with three different sheets. Each sheet corresponds to a different view of the same data:
  - The first one will show you the generic signal information and the different coverage measures for each point acquired.
  - In the second one, you will find the same data but presented in a table format, more user friendly for working with graphs based on each measured parameter.



- 8 Now save the data as a true excel file. No specific name or path is required, but you must remember the path.

## 5.10 Datalogger



### 5.10.1 Description

The Datalogger function stores automatically measurements in a file set by the user (name, channel plan). User can store for each datalogger measurements taken at different test points of the selected installation. Measurements are made for all channels in the active channel plan, both analogue and digital. Each installation has its own datalogger files.

As an example, you can picture the Installation folder as a folder that includes all the measurements of a building. Within the installation folder the datalogger sub-folders would group the measurements for each apartment inside that building. Finally the test points would be the files with the measurements that would be taken in each one of the TV sockets inside the apartment.

### 5.10.2 Operation

#### ► Creating a new datalogger

- 1 First select one installation of the list of installations  and load it pressing the "Load" key . An installation contains the channel plans and DiSEqC commands selected by the user and it stores dataloggers and screenshots when it is selected (more information in chapter "Installations management").
- 2 Check the installation is selected. The name of the installation should appear on the upper left corner of the screen.
- 3 Press the : Tools key.
- 4 Press on the "Datalogger" option.
- 5 It displays a menu with the "New ...", "Test & Go" option and a list of all dataloggers at the selected installation.
- 6 Select "New ..." to create a new datalogger, select "Test & Go" to create a quick datalogger (see next) or select the file name of an existing datalogger (if the user want to save data on a specific datalogger already existing).



- 7 If "New ..." is selected, a installation wizard shows how to create a new datalogger. Follow its instructions:
  - **F4** Next: to move to the next screen.
  - **F3** Previous: to move to the previous screen.
  - **F1** Cancel: to cancel.
- 8 When creating a new datalogger through the wizard, the user can give a name to the datalogger.

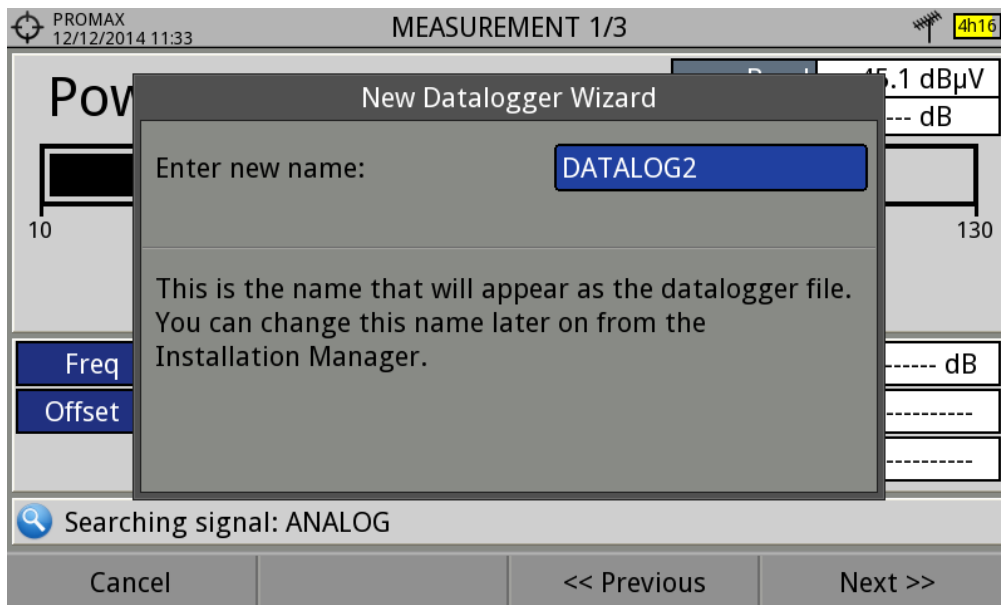

**Figure 73.**

- 9 Next, the user can select the terrestrial and/or satellite channel plan to use in the datalogger. The channel plans that are shown depends on the channel plans available for the current installation.



Figure 74.

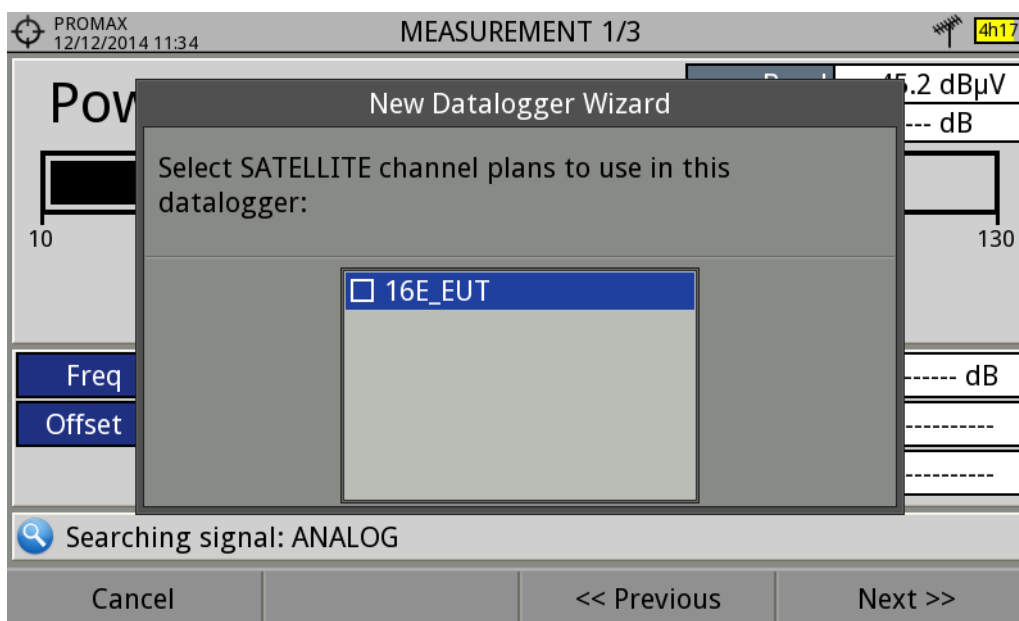
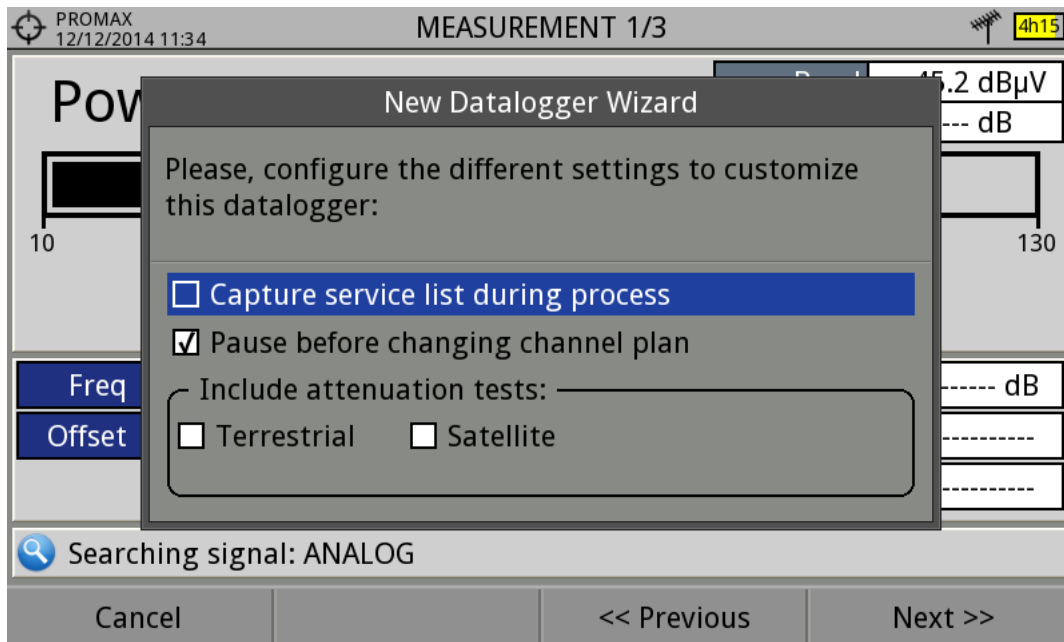

Figure 75.

- 10 In the next window, the user can select an option to capture de service list when performing the datalogger (this option slows down the process but provides more information). Another option allows the user to enable a pause between channel plans (the process stops until the user wants to carry on). There is also the option to perform a datalogger on the attenuation test, terrestrial or satellite (see section "Attenuation Test" under "Tools" for more information).



**Figure 76.**

- 11** At the last step, user can select to open the just created new datalogger (by default, this option is selected).
- 12** Once a new datalogger is created or selected an already existing one, it shows the datalogger viewer screen and measurements of test points can start.
- 13** If it is a new datalogger, in first place before starting the datalogger, the system will create a new test point (see next section). Test points represent a specific point such a TV antenna socket.



[Click here to watch this video: Datalogger](#)

### ► Starting a datalogger

- 1** After creating a new datalogger file or selecting an existing one, the user can start the datalogging process.
- 2** From the datalogger viewer screen, press the "Test point" key and from the menu select an existing test point using the "Jump to..." option or "Create new..." to create a new test point. If a new test point is created, user has to give it a name.

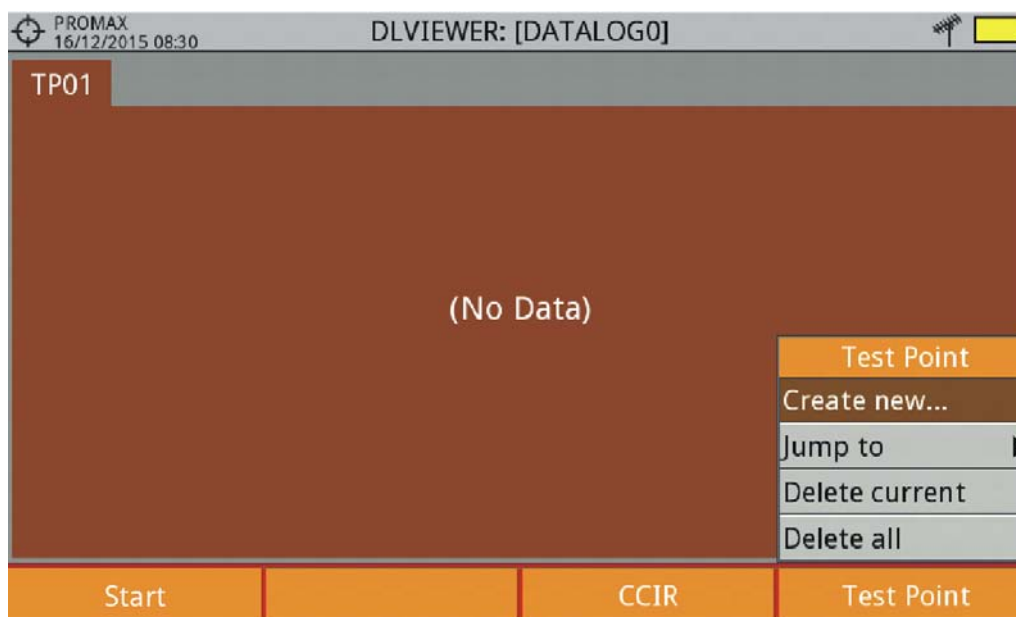

**Figure 77.**

- 3 Now datalogger is ready to start. Press the key **F1** and "Start". The datalogger process starts, during which all the measurements of all channels that are part of the datalogger and also the attenuation test are saved.
- 4 During datalogger, it catches the list of available services of all channels in the channel plan that are part of the datalogger (if this option was selected when creating the datalogger or if the "Datalogger PSI" option is enabled in the Preferences menu). If there is a change of channel plan during datalogger there will be a pause (if this option was selected when creating the datalogger). User can pause and resume the datalogger process at any time by pressing on the key "Pause" **F3**. If the "Attenuation Test" option was included when creating the datalogger, these measures will also saved.
- 5 At the end it saves the data and allows watching the results on screen by channel plan/attenuation test. To change the view of channel plan or attenuation test data press on the **F3** key. Data about terrestrial and satellite attenuation will appear as the option TER ICT and SAT ICT respectively.
- 6 It is also possible to download Datalogger files to a PC by the NetUpdate software (free download on the PROMAX website). Once downloaded, the program can generate reports with these files. This is not possible with the datalogger files exported directly to a USB (without using NetUpdate). Information of Service lists is in the XML files downloaded to the PC.

**NOTE:** To make a datalogger with the Field Strength tool, in first place user has to enable the field strength tool, and then to create a new datalogger file. The field strength data will be stored in this datalogger.



► Screen Description (Datalogger)

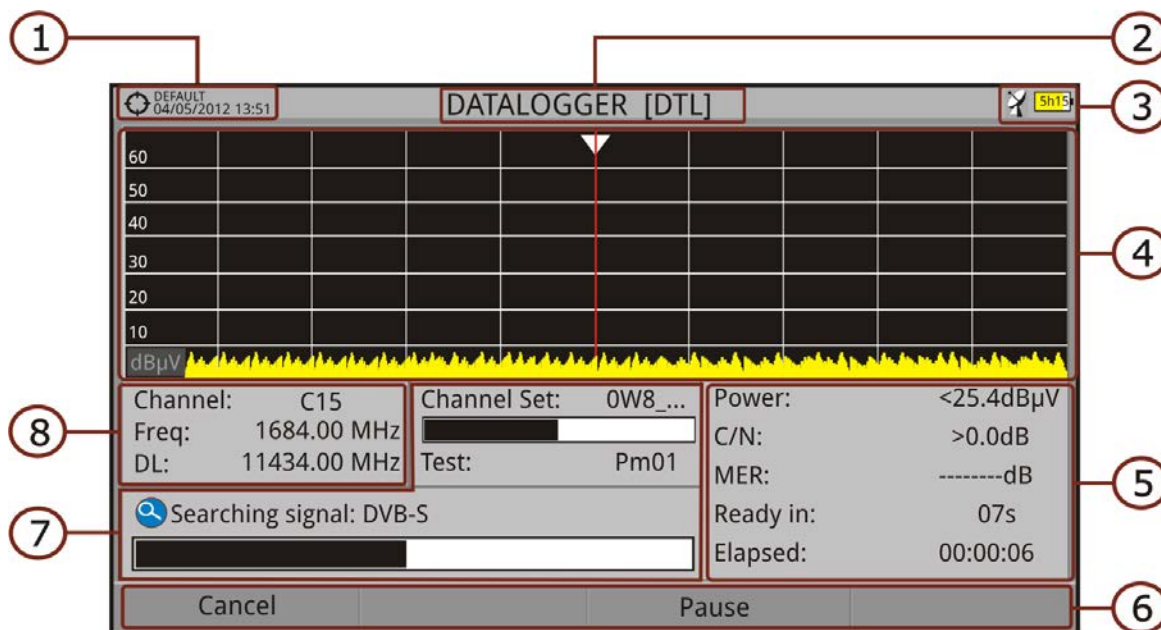

Figure 78.

- 1 Selected installation; date and time.
- 2 Current datalogger name.
- 3 Selected band; battery level.
- 4 Exploring the spectrum in real time.
- 5 Level/Power, C/N ratio, MER, time remaining to identify a channel, elapsed time since the start of the channel identification.
- 6 Softkey menus.
- 7 Current channel plan, progress bar in the current channel plan, selected test point.
- 8 Channel, frequency and Downlink.



► Screen Description (Data Viewer)

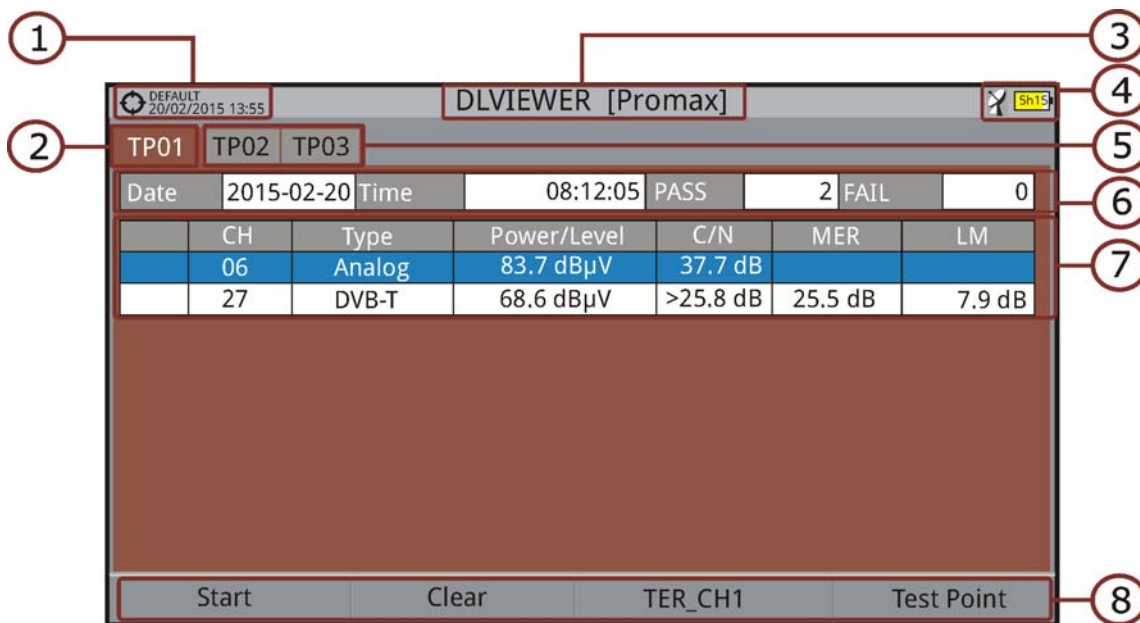

Figure 79. Channel Plan Data Viewer.

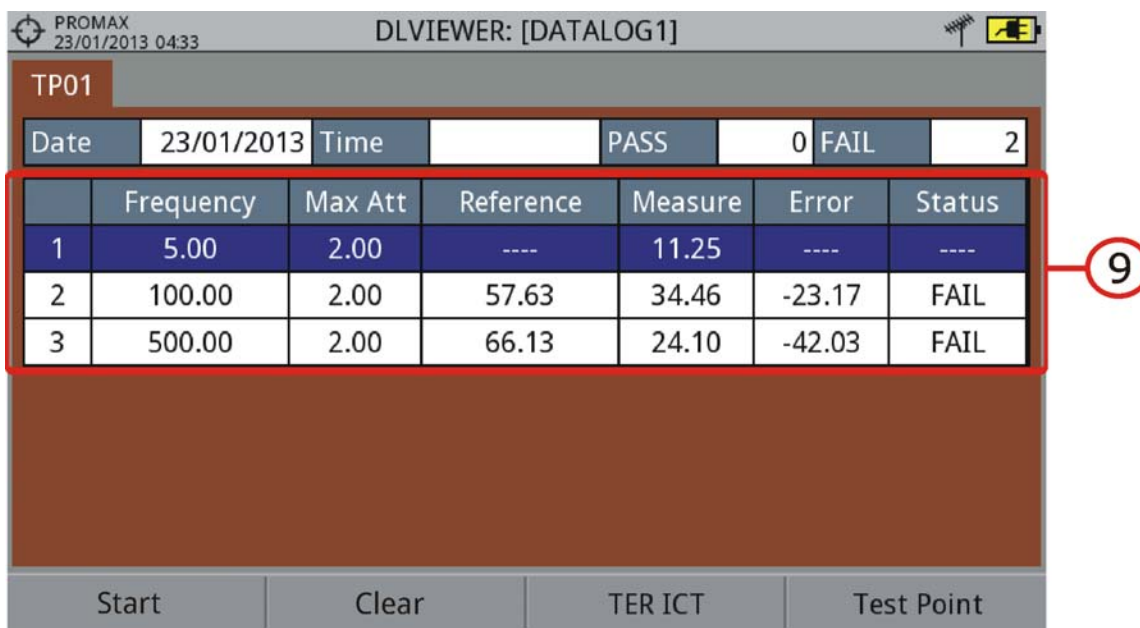

Figure 80. Attenuation Test Data Viewer.

- 1 Selected installation; date and time.
- 2 Tab identifying the displayed test point.
- 3 Current datalogger name.
- 4 Selected band; battery level.
- 5 Tab identifying each test point.









- 6 Date and time when the datalogger was created. Number of channels locked (PASS) or not locked (FAIL).
- 7 Data table with measurement data for each channel. In order from left to right: Colour identifying if the channel has been locked (WHITE) or not locked (RED) channel; signal type; power/level; Carrier/Noise (C/N) rate; MER; Link Margin. Move the joystick up or down to navigate along the measurement data. Press the joystick on a channel to display the signal parameters.

**NOTE:** When performing a datalogger for a DVB-T2 signal, the channel field will show channel name, profile and layer (PLP). This is show by letter "B" which stands for Base profile or "L" for Lite profile. The number indicates the amount of PLP.

- 8 Softkey menus.
- 9 Table with the measurement data for each pilot signal in the attenuation test. In order from left to right: number of pilot signal, pilot signal frequency, maximum attenuation allowed, reference level value, level value at the test point, error and signal status.

### 5.10.3 Menu Options

#### ► Data Viewer Menu

-  It starts the datalogger in the selected test point.
-  It clears all the acquired data.
-  It displays a menu with the available channel plans to select the channel plan whose data want to be displayed. Channel plans available are those that have been selected during the creation of the datalogger.
-  It contains four options:
  - Jump to: It allows selecting a test point.
  - Create New...: It creates a new test point.
  - Delete Current: It deletes the current test point.
  - Delete All: It deletes all test points of the datalogger.

#### ► Datalogger Menu Options

-  It cancels the datalogger.



-  It pauses datalogger until the user resumes by pressing again.

## 5.10.4 Test & Go

"Test & Go" function inside the "Datalogger" tool allows the user to create a quick datalogger by creating automatically a new datalogger, a new test point and then starting it.

Datalogger parameters are set automatically based on:

- File name: DL [current band - terrestrial or satellite][consecutive number].
- Channel plan: Current channel plan selected in the equipment.
- Test point: PM01.
- No capture of services list.

If "Test & Go" is performed when using the "Attenuation test" tool, then the datalogger created will be specific to save attenuation test data.

## 5.11 Screen and Data Capture (Export key)

### 5.11.1 Description

The Screen and Data Capture function captures what is displaying on screen at the moment. The capture can be an image, measurement data or both. This is set through the **Preferences** menu ("Export button" option).



Data capture is saved in a XML file with all data, measurements and text, that is on screen at this time. The image is saved in a PNG file.

Captures can be displayed on the equipment or also can be downloaded and displayed through an external software.





## 5.11.2 Operation



### ► Settings

- 1 Press the "Management Installation"  key for one second to enter "Preferences" menu.
- 2 Go to the label " **Tools**" and select your option in "**Export button**". There are three options available: Screen Only, Data Only or Screen+Data. "Screen Only" saves the screen image in PNG format. "Data Only" saves measurement data on screen in a XML file format. "Screen + Data" saves both screen and data.
- 3 Once selected, press  to save changes and  to exit "Preferences".

### ► Capture

- 1 Press the **Export** key  for one second when on screen appears the screen to be captured. The LED next to key lights.
- 2 A progress bar shows the progress of the capture process. When finished, the screen is captured and the LED is OFF.
- 3 Then the virtual keyboard appears with the default name assigned to the file. The filename for the screen capture is automatically generated with the following code: capture mode (SP for Spectrum mode, TV for TV mode, ME for Measurement mode), capture channel (CHXX) and a consecutive number.
- 4 Edit the name if necessary (see section "Virtual keyboard"). Then press : OK to end the capture or : Cancel for cancellation.

### ► Display

- 1 To display the screen captured press on the **Installations Management** key .
- 2 Select the installation where the capture was done and press  **Manage**.
- 3 Press  **Filter by type**. Select "Screen Shots" or "Data Captures" option. This shortens the list to the selected option.
- 4 It appears a list of all the captures.
- 5 Move up or down to find the file to be displayed.
- 6 Leave the cursor on the file to be displayed. It appears a progress bar that lasts a few seconds, depending on the size. Then the capture appears.



- 7 To see the capture in full screen just press the F4: **Options** key and then on the menu press "View in Full Screen". To exit the full screen view press any **softkey**.
- 8 To delete or copy the capture to a USB stick, select the capture by pressing the joystick, and then select the appropriate option from the menu : **File**.
- 9 Captures can also be displayed on a PC, by downloading the whole installation file using the NetUpdate software (see the NetUpdate manual for more information).



## 5.12 Explore Channel Plan

### 5.12.1 Description

The Explore Channel Plan function performs a scan of the selected channel plan. It detects where active signals are in a channel plan and in which channels of the current channel plan signal is received. With this information it explores these channels with signal, looking for any broadcast and identifying them.

### 5.12.2 Operation

The Explore Channel plan function is available for all signals.

- 1 Connect the **RF** input signal to the equipment.
- 2 Access Preferences by pressing the Installations key  for 1s.
- 3 At the 'Measures' tab check the minimum values for the signal to be identified during the scan (for more information refer to section: Preferences -> Measures options).
- 4 Press the **Tools** key .
- 5 Select the **Explore Channel Plan** option.
- 6 The first screen of **Explore Channel Plan** appears.

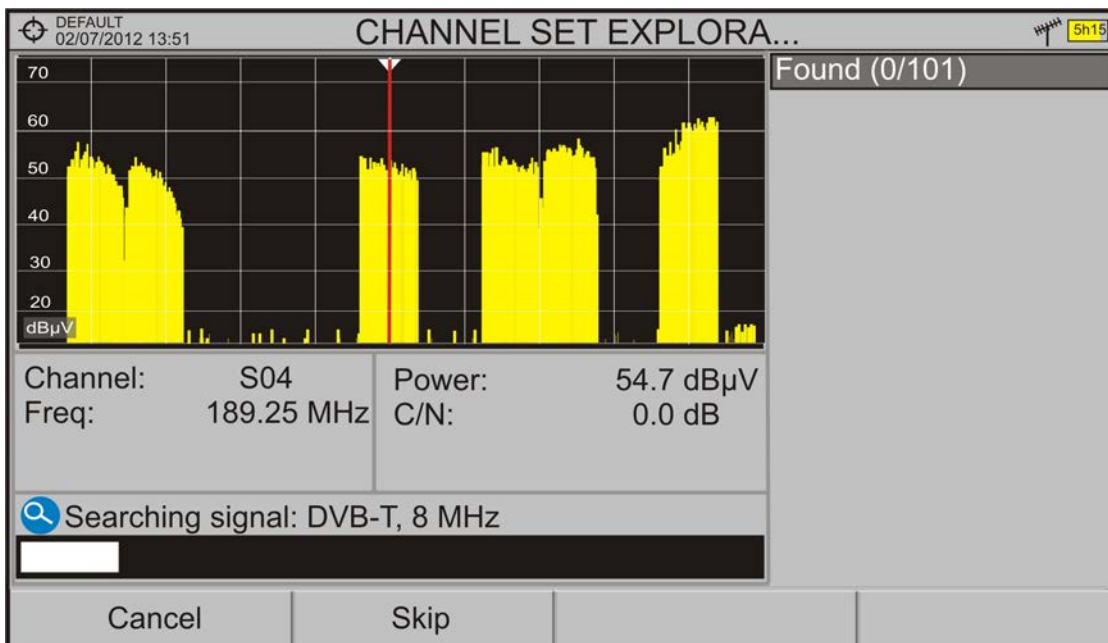

Figure 81.

7 After the exploration the following screen appears:

► Screen Description

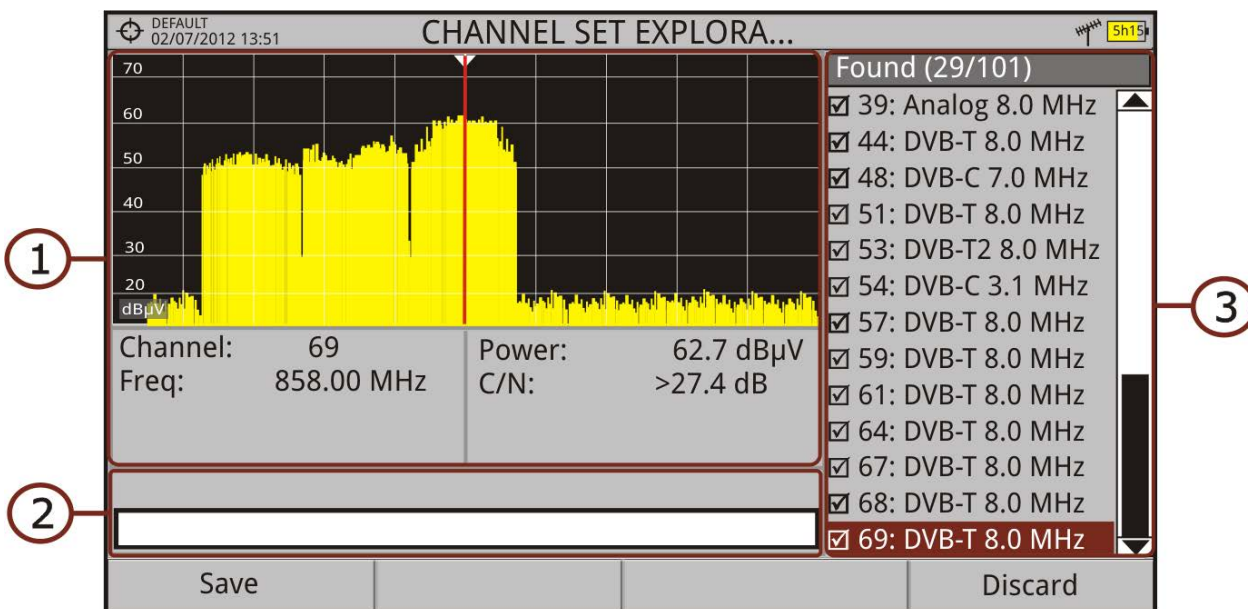

Figure 82.

1 **Spectrum and Measurement:** It shows the cursor scrolling through each of the channels of the channel plan. On the bottom of the screen the channel and frequency appears next to the Power/Level and the C/N ratio.



- 2 **Progress Bar:** It shows the signal type detected and the scan progress in real time. At the end a box shows a message informing the exploration process has finished.
- 3 **Channel plan:** At the end of the process it shows the channels that have been detected during the channel plan exploration. In parentheses shows the number of detected channels to total channels of the channel plan. When moving the cursor through the channels, the spectrum and measurement windows are dynamically updated for the selected channel. It allows you to select/unselect channels to save them as a new channel plan.

### 5.12.3 Menu Options

At the bottom are the function keys. They are detailed below.

- **F1 Cancel** (during the process): This option appears only while performing the exploration process. It cancels the exploration before finish. When pressing, a confirmation message appears before cancelling.
- **F1 Save** (at the end of the process): This option appears at the end of the exploration process. It saves the results obtained during the exploration as a new channel plan. The name of the original channel plan is assigned to the new one by default and the user can modify the name using the virtual keyboard that appears prior to saving. The new channel plan is now available in the list of channel plans in the installation and can be used as any other channel plan. After saving it becomes the selected channel plan to work with.
- **F2 Skip** (during the process): This option allows skipping the current channel and explore the next one in the channel plan.
- **F4 Discard** (at the end of the process): This option appears at the end of the exploration process. It discards the results obtained from the exploration.



[Click here to watch this video: Channel plan exploration](#)



## 5.13 Discover FM Stations

### 5.13.1 Description

The **Discover FM Stations** tool scans the FM band and creates a FM channel plan from scratch. Scanned frequency range is from 87 to 108 MHz.

### 5.13.2 Operation

To scan the FM band:

- 1 Connect the **RF** input signal to the equipment.
- 2 Press the **Tools** key .
- 3 Select the **Discover FM Stations** option.
- 4 The first screen of **Channel Plan Exploration** appears and the exploration starts.

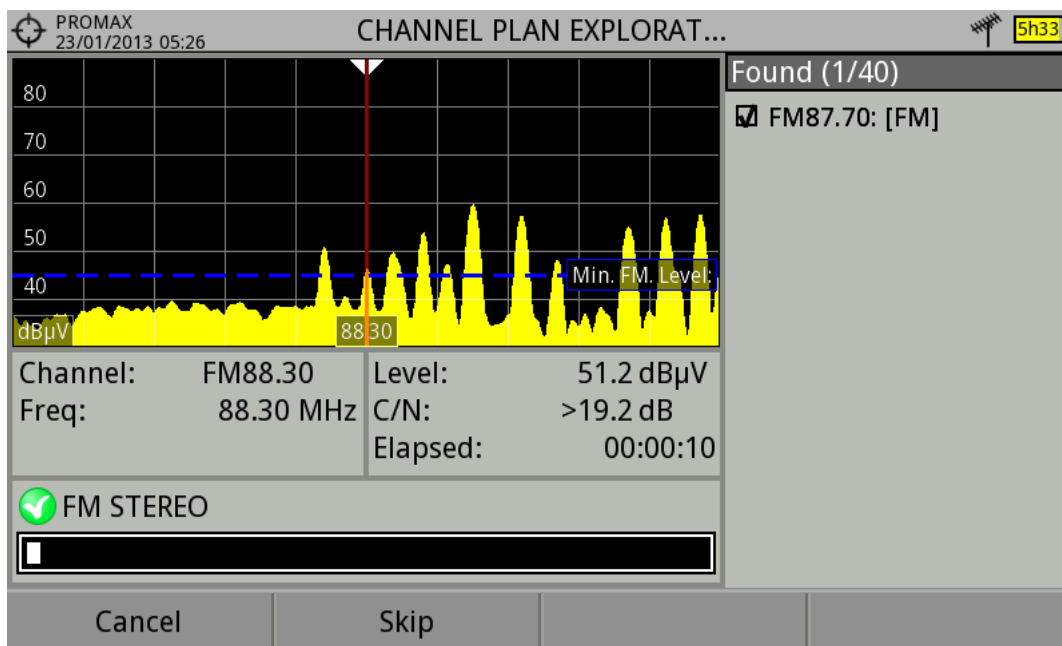
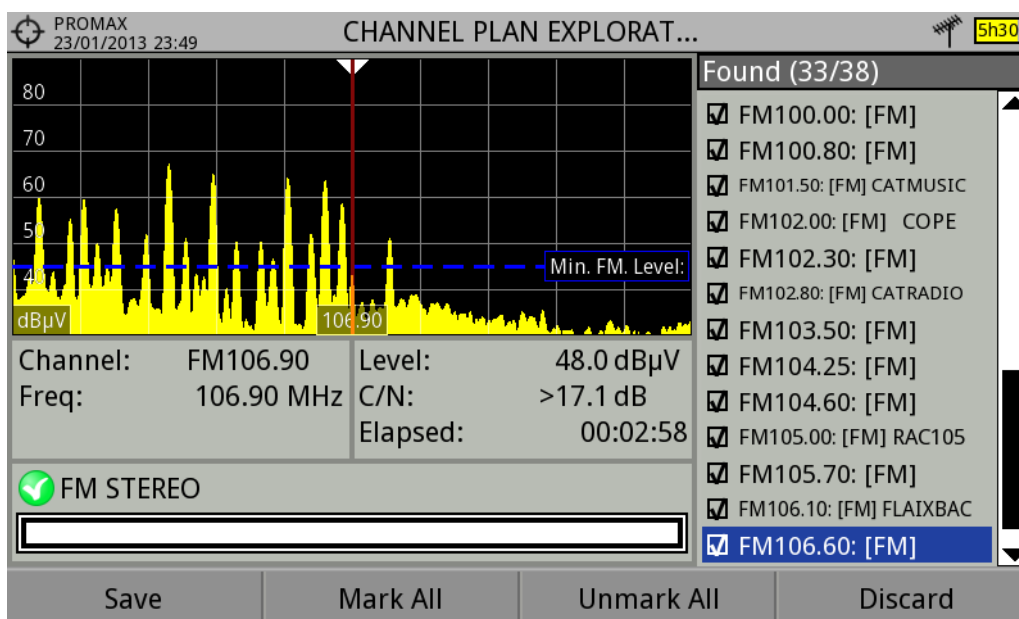

**Figure 83.**

- 5 After the exploration the following screen appears:



## ► Screen Description



**Figure 84.**

- 1 **Spectrum and Measurement:** It shows the cursor scrolling through each of the channels of the **FM** band. On the bottom of the screen the channel and frequency appears next to the Power/Level and the C/N ratio. In the spectrum area there is the **Minimum FM Level**. This line is the minimum signal level required to identify the FM signal. The channels below that signal level will not be identified. It can be configured in the "Measures" tab in "Preferences" .
- 2 **Progress Bar:** It shows the signal type detected and the scan progress in real time. At the end a box shows a message informing the exploration process has finished.
- 3 **Channel Plan:** It shows a list with the channels being detected during the exploration of the FM band. At the top and between parentheses there is the number of detected channels to total channels. When moving the cursor through the channels, the spectrum and measurement windows are dynamically updated for the selected channel. User can mark / unmark the FM channels to save in the channel plan.

### 5.13.3 Menu Options

Function keys are detailed below:

- **F1** Cancel (during the process): This option appears only while performing the exploration process. It cancels the exploration before finish. When pressing, a confirmation message appears before cancelling.





- **F1** Save (at the end of the process): It appears at the end of the exploration process. It saves the results obtained during the exploration. It is assigned a name by default to the channel plan but the user can modify the name using the virtual keyboard that appears prior to saving. Each channel takes its name from the service name extracted from RDS data (if available). The new channel plan is now available in the list of channel plans in the installation and can be used as any other channel plan. After saving it becomes the selected channel plan to work with.
- **F2** Skip (during the process): This option allows skipping the current channel and explore the next one.
- **F2** Mark All (at the end of the process): This option marks all the channels that appear on the channel list.
- **F3** Unmark All (at the end of the process): This option unmarks all the channels that appear on the channel list.
- **F4** Discard (at the end of the process): This option appears at the end of the exploration process. It discards the results obtained from the exploration.

## 5.14 **Field Strength**

### 5.14.1 **Description**

The Field Strength function allows the equipment to work as a field strength meter, measuring dB $\mu$ V per meter. To perform this type of measurement is needed to enter the calibration parameters of the antenna being used to receive the signal.

### 5.14.2 **Operation**

The Field Strength tool is available for all signals received by the RF input.

- 1 Connect the antenna to the **RF** input of the equipment.
- 2 Select a channel or frequency.
- 3 Press the **Tools** key.
- 4 Select the **Field Strength** option and in the drop down menu select **On**.



- 5 Select again the **Field Strength** option, now select the new option that appears, called **Configuration**.
- 6 In the configuration window enter the antenna calibration parameters, by hand or selecting one of the available antenna types (data of different antenna types should be imported by the user. Refer to the following section).
- 7 Now access the **Spectrum Analyzer** or **Measurement** mode to check the field strength measure shown as FSM (dB $\mu$ V/m). This measure replaces the power.

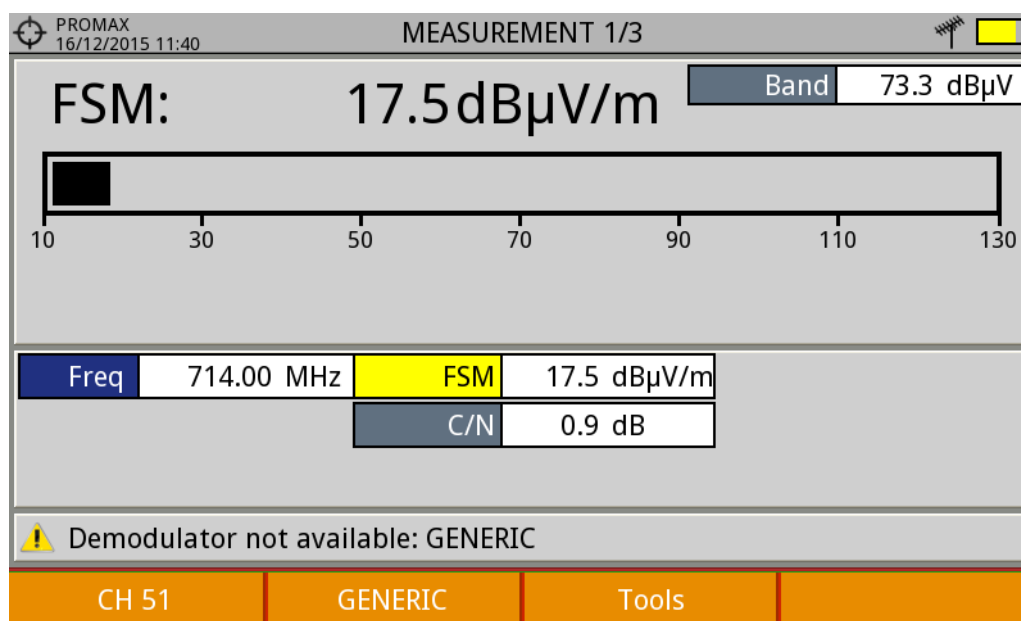

**Figure 85.**

- 8 To save FSM data, go to "Tools", select "Datalogger" and then "New" to create a new datalogger. Keep in mind that the "FSM" tool does not demodulate any signal, it only detects the transmitted energy, so it is identified as a GENERIC signal. For this reason only FSM data is saved for each channel (for more information refer to "Datalogger" chapter).
- 9 Once finished, return to the **Tools** menu and in the **Field Strength** option select **Off**.

**NOTE:** Some tools (Constellation, Echoes, MER by carrier, Merogram...) are disabled when the **Field Strength** option is enabled. Remember to turn off "FSM" option if you want to use these other tools.

### 5.14.3 Settings

The **Field Strength** configuration option allows the user to enter the correction factors for the antenna and cable used when measuring the field strength.



**Field Strength Configuration**

|  |   |
|--|---|
| <p><b>Antenna</b></p> <p>Type: <span style="border: 1px solid gray; padding: 2px;">Manual</span></p> <p>Factor (dB/m): <span style="border: 1px solid gray; padding: 2px;">0.0</span></p> <p>Detector Type: <span style="border: 1px solid gray; padding: 2px;">RMS</span></p> | <p><b>Cable</b></p> <p>Type: <span style="border: 1px solid gray; padding: 2px;">Manual</span></p> <p>Loss (dB): <span style="border: 1px solid gray; padding: 2px;">0.2</span></p> |
|--|---|

@794.00 MHz ==> 66.4(Level) + 0.0(k) + 0.2(loss) - 0.00(Z) = 66.6 dBμV/m

**Figure 86.**

Data fields to be filled are:

► **Antenna:**

- **Type:** In this box the user must select the type of antenna between manual and any other type of antenna available. If you select the manual antenna, you must enter the correction factor by hand. If you select an antenna type then the correction factors associated with each frequency are applied. These data are defined in the antenna file imported by the user (refer to next section to know how import antenna data).
- **Factor:** This is the correction factor (K) for the antenna at the measurement frequency.
- **Detector Type:** (PEAK/RMS). It allows the user to select between maximum PEAK detector or RMS detector. The maximum peak detector is mainly used for analogue modulated signals, while the RMS option is the right choice for digital modulated signals.

► **Cable**

- **Type:** In this box the user must select the type of antenna between manual and any other type of cable available. If you select the manual cable, you must enter cable loss by hand.
- **Loss (dB):** In this box the user must enter the estimated loss for the cable used to connect to the antenna.

At the bottom of the configuration window you can see the field strength in real time according to the current frequency and correction factors.

**5.14.4 Creating and Importing Calibration Tables**

The user can import the antenna calibration data obtained from the manufacturer. There is a template (available on the download area at PROMAX



website) that can be filled and imported into the equipment (this template has been created in an Excel file; the procedure explained below only works for the Excel 2007 version and above).

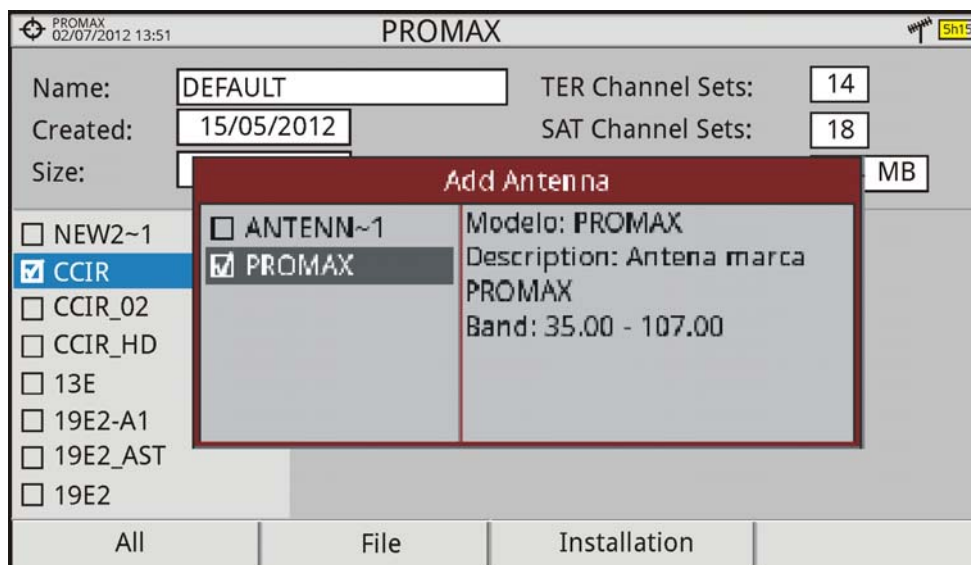

**Figure 87.**

Next are the steps to fill in the template data and import them to the equipment:







### ► Antenna Generator

- 1 Download the "Antenna XML Generator" template from the [PROMAX website](#).
- 2 In the "Model" box enter the name by which the antenna will be identified (maximum 8 characters).
- 3 In the "Description" box, type a description to identify the antenna.
- 4 In the "Impedance" box select the impedance of the antenna between 50 and 75 ohms.
- 5 In the "Height" box enter the antenna height in meters.
- 6 Now fill the calibration table of the antenna with the K factor according to frequency.
- 7 Do not change units when filling the table.
- 8 Extend or contract the calibration table to the number of filled lines.
- 9 After filling the calibration table, go to option "Save As -> Other Formats.
- 10 In the window that appears, edit the file name in "File name".





- 11 In the drop down menu "Save as type" select the "XML Data" option. Then click "Save".
- 12 If a warning message shows up, click "Continue".
- 13 Now the file is already generated with the selected name and the extension "xml".
- 14 Now just import it to your equipment and load the calibration table of the antenna in the installation.

### ► Import

- 1 Copy the generated file on a flash drive and connect it to the meter's USB port.
- 2 Press the **Installation Manager** key .
- 3 Press the Tools key .
- 4 Select "Import from USB" option.
- 5 The Import Files window appears. Select the generated file and press the  "Import" key.
- 6 Press the **Installation Manager** key , select the installation to which you want to add the antenna calibration table and press the  "Manage" key.
- 7 Press  key: "Installation" and select the "Add Antenna" option.
- 8 Select the antenna to be added and OK.
- 9 The antenna calibration table is now added to the installation.
- 10 Now this antenna will be available in the type of antenna field in the configuration menu of the "Field Strength" tool.

### ► Remove

- 1 Press the Installation manager key .
- 2 Press  "Tools" key.
- 3 Select "Installed Antennas" option.
- 4 Check the antenna to remove.
- 5 Press : "Remove" key.



## 5.15 Task Planner

### 5.15.1 Description

The **Task Planner** function allows the user to set-up a task list, selecting when to start, a repetition rate and other parameters. The equipment can be switched off after setting all parameters and it will wake-up, at the required time, to perform the scheduled tasks.

### 5.15.2 Operation

The Task Planner tool is available to run screenshots and dataloggers.

- 1 Press the **Tools** key.
- 2 Select the **Task Planner** option to access the Task Planner window that shows a list of scheduled tasks. In the right column and next to each task there is its status: if the date of the next execution appears then the task is pending; if "finished" appears then the task has been executed; if nothing appears then the task has not been scheduled.

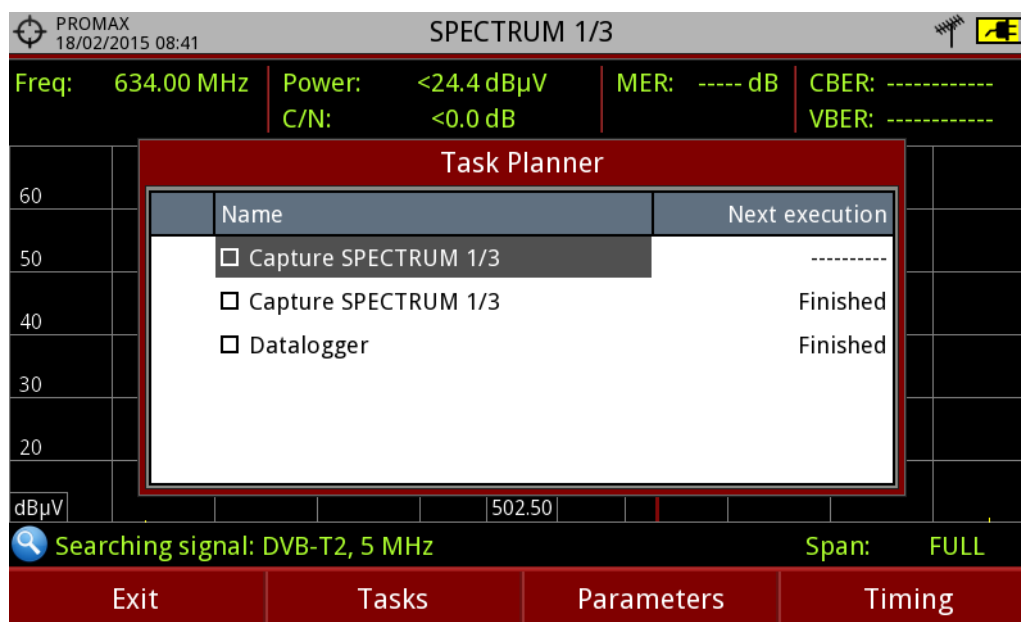

Figure 88.

- 3 To add a new task press **F2**: **Tasks** and select the "**Add**" option. It deploys a menu with three options: Capture, Datalogger and Monitoring\*.

\*. only available for RANGER Neo +

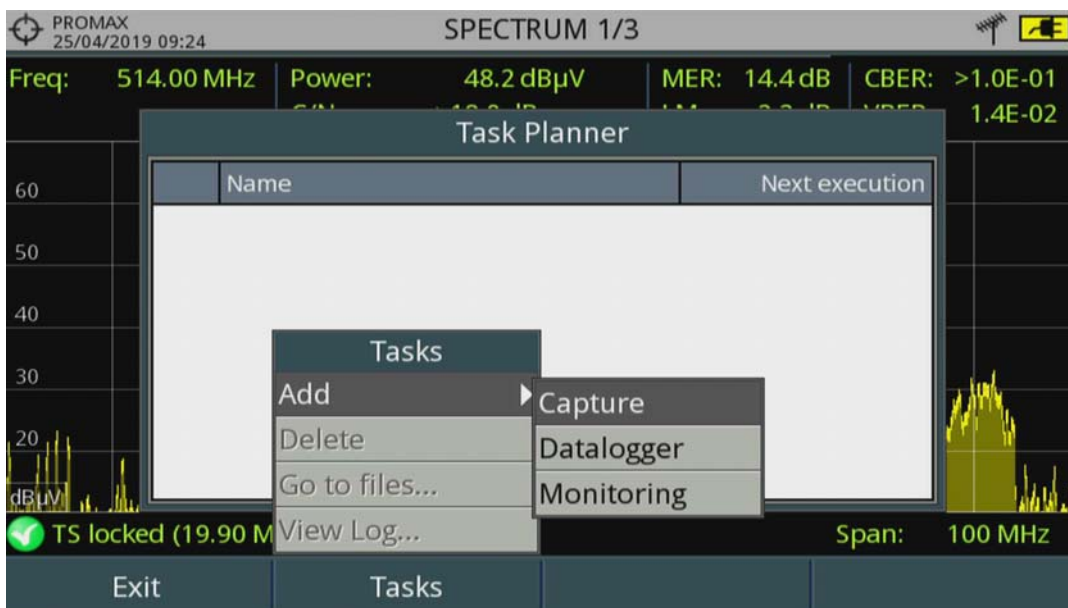

Figure 89.

- 4 The **"Capture"** option performs the capture task. The user can select the screen and type of capture. The screen options include any view in the three modes: Measurement, Spectrum or TV. The options for type of capture are: screen only, data only or screen+data (for more details refer to ["Screen and Data Capture \(Export key\)"](#) on page 113).

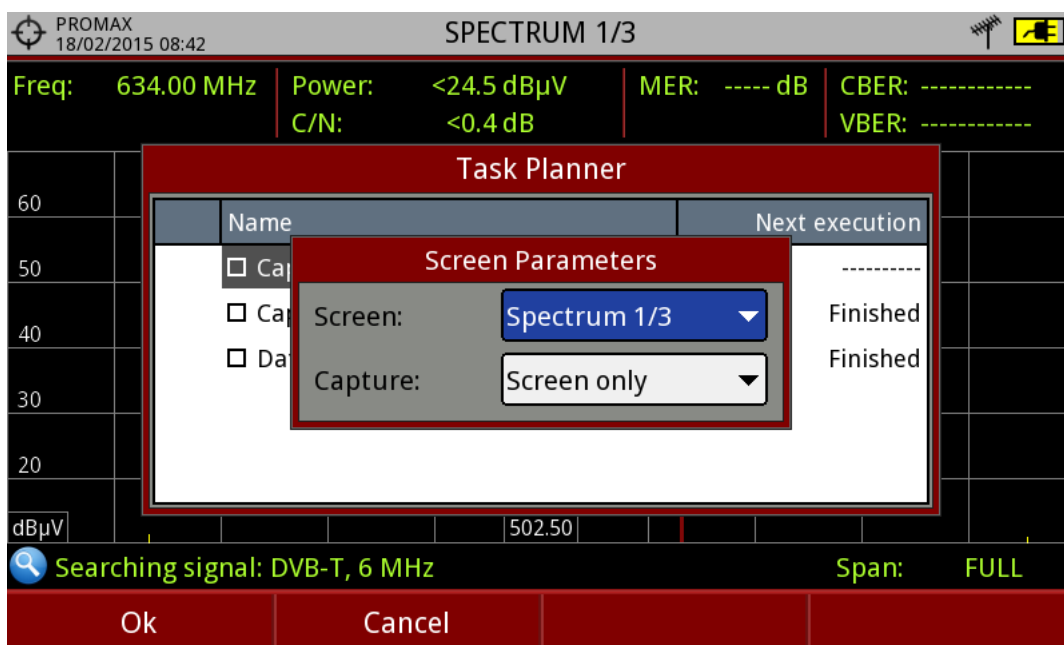



Figure 90.

- 5 The **"Datalogger"** option performs the datalogger task. The user must first select the datalogger from those available for the current installation. If there not any datalogger task available the user must create one (for more details refer to ["Datalogger"](#) on page 105).



- 6 The "**Monitoring**" option performs a monitoring task. The user must first select the monitoring from those available for the current installation and its duration (days, hours and minutes). If there is not any monitoring task available the user must create one using the webControl program (for more details refer to "[Monitoring](#)" on page 164).
- 7 After selecting the type of task, check the box next to it and press **F4**: **Timer** to schedule the time to execute the task (for more details refer to next section).
- 8 When saving the timer for the task, the upper right corner shows an icon of a clock  indicating that the equipment has tasks pending to execute.

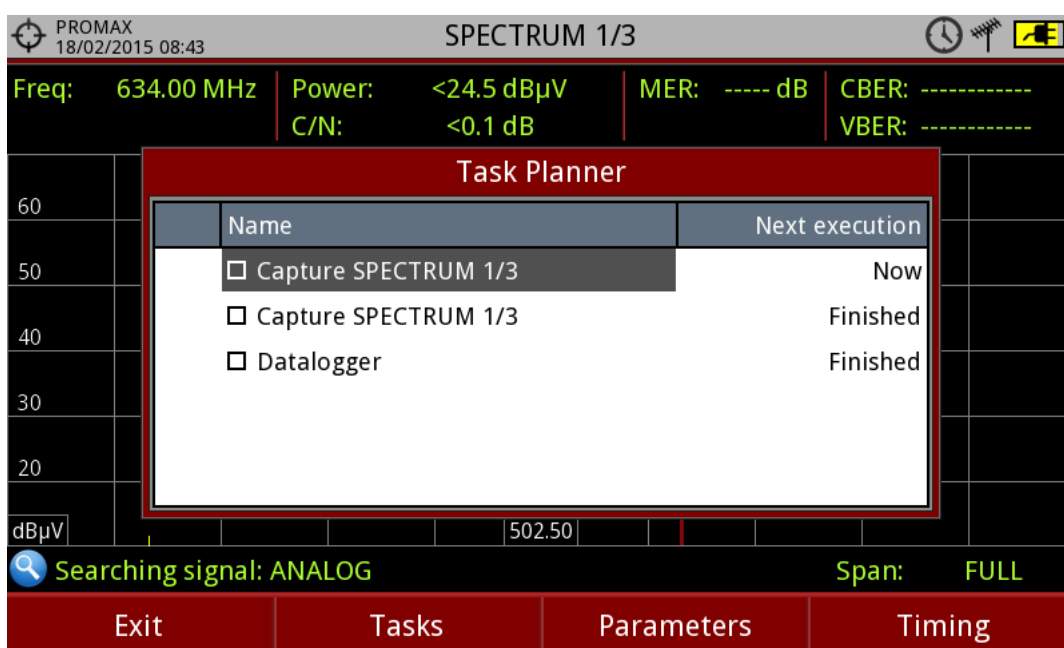

Figure 91.

- 9 To change any parameter of the task, check the box next to the task and press **F3**: **Parameters**.
- 10 To delete a task, check the box next to it and in **F2**: **Tasks**, press "**Delete**".
- 11 After setting up the tasks press **F1**: **Exit**. Since this moment the timer for task execution starts.
- 12 When the task is finished, the user can access the data through "**Go to file ...**" option in **F2**: **Tasks**. It will take you directly to the management installation window where the data for each installation are stored.
- 13 Once the task is completed, user can access a short log for each programmed task, just to know if each task has been successfully completed or to indicate if something prevented its execution. To access this function, from **Task Manager**, press **F2**: **Task** and then "**View Log...**".





**NOTE:** The equipment can be turned off after task planning as it will automatically turn on when the time to task execution comes.

Two tasks cannot be executed simultaneously.

It is recommended that the datalogger selected have not enabled the option to pause between channel plans, since in that case the process would stop during the execution of the task.

The filename for the screen capture is automatically generated with the following code: capture mode (SP for Spectrum mode, TV for TV mode, ME for Measurement mode), capture channel (CHXX) and a consecutive number.

5.15.3 Timer

The timer window contains several options for task scheduling.

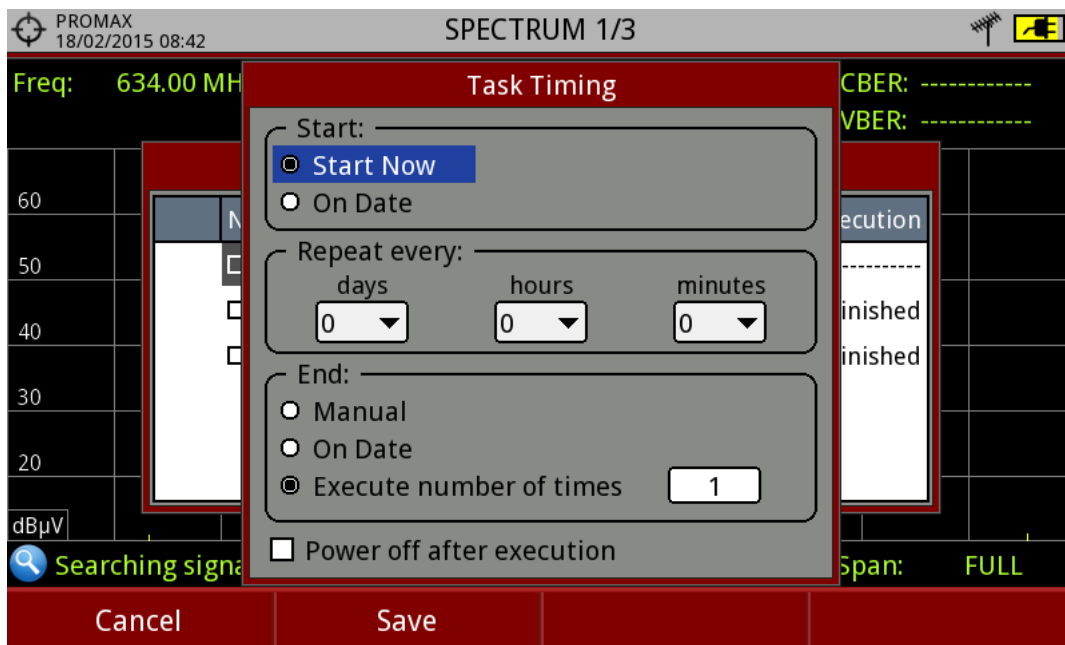

Figure 92.

- Start
  - Start Now: The task begins immediately after leaving the task planner.
  - On Date: The user selects the start date for the task (day / month / year) and time (hour: minute).
- Repeat every: The task repeats each cycle of time (days, hours and minutes).



- Stop
  - Manual: The user finishes the task.
  - On date: The user selects the stop date for the task (day / month / year) and (hour: minute).
  - Repeat a number of times: The task execution ends after the number of times set.
- Turn off after execution: By checking this option, the equipment turns off after the execution of the task..

## 5.16 Shoulders Attenuation \*

\*. only available for RANGER *Neo* +

### 5.16.1 Description

The Shoulders Attenuation function measures interferences in adjacent channels that look like shoulders.

Broadcast signals such as DVB-T, DVB-T2, ISDB-T or ATSC are constructed to follow strict RF requirements mostly aimed to ensure they occupy the bandwidth they have been assigned and they do not interfere with any other adjacent channels. In particular the shape of the signal spectrum must be within the limits of certain given masks specified in the different corresponding standards, i.e. ETR290 recommendations for DVB-T. The specific masks depend on the type of signal and standard.

Due mainly to nonlinearities in the power amplifiers the output RF signal contains unwanted band limit and out of band components, the shape of which has given rise to the term "shoulder", that tend to compromise the compliance with the mask limits.

### 5.16.2 Operation

Shoulders attenuation tool is available for digital terrestrial signals.

- 1 Shoulder attenuation should be measured at the output of the power amplifier right before sending the signal to the antenna through the net of passive devices. Because of the power level typically available at that point it is mandatory to use external power attenuators so that the level can be adapted to the maximum accepted by the analyzer.
- 2 Connect the signal to be measured to the RF input and tune a digital channel in terrestrial band.
- 3 Press the  Tools key.



- 4 Select the **Shoulders Attenuation** option and the **Shoulders Attenuation** screen shows up.

► **Screen Description**

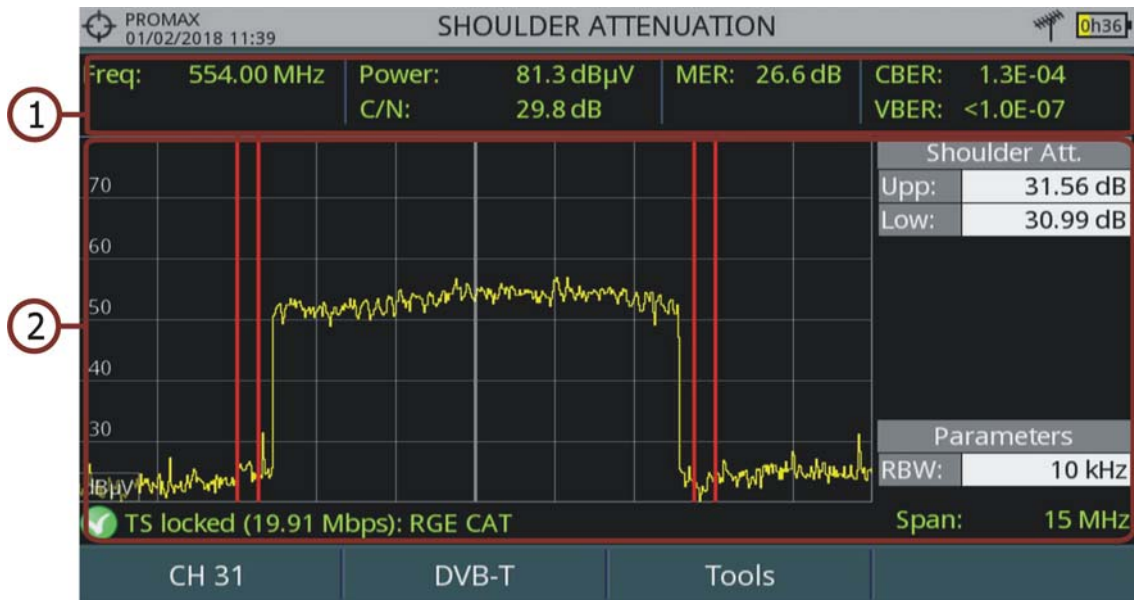

**Figure 93.**

- 1 Frequency / tuned channel; Power; C/N; MER; CBER; VBER of pilot signal.
- 2 Channel spectrum showing shoulder attenuation delimited by two vertical red markers. These markers delimit the area of calculation for Upper shoulder attenuation and Lower shoulder attenuation. The Parameters window shows the Resolution of the bandwidth.

**5.17 Service Recording**

**5.17.1 Description**



The Service Recording tool records in real-time one digital service from the transport-stream received that is shown on screen. This service is saved directly on the USB flash drive memory connected to the equipment. Afterwards that record can be played on a PC with a video player.

**5.17.2 Operation**

The **Service Recording** tool is available for all **digital** signals (except for DAB digital radio services).

- 1 Connect the signal to the equipment input.



- 2 Tune the channel and select the service to record.
- 3 Connect the adapter cable to the mini-USB port on the equipment and then connect a USB memory.
- 4 Press the key : **Tools** and select the PVR option.
- 5 The screen to record the service appears.
- 6 Start the recording by pressing the **RECORD** key .
- 7 End the recording by pressing the **STOP** key .
- 8 The recording file is saved in the PVR folder created by the equipment in the USB memory.
- 9 The file name is PVR plus a consecutive number and the file extension is TS.
- 10 The file can be played in a computer with a media player like VLC. This file cannot be played from the meter itself.



### ► Screen Description



**Figure 94.**





- 1 Installation selected; date and time.
- 2 Icons from left to right: recording; USB connected; selected band; battery level.
- 3 Recording Service.
- 4 Memory device where service is recorded: internal memory or USB



- 5 Window with some information about recorded files such as name, size and created date. It only shows files inside the memory device selected (internal memory or USB).
- 6 Size of recording file and time duration.
- 7 Window with information about the service being recorded: recording length, maximum bit rate, channel service recorded and free available memory.
- 8 Control keys:
  - : Recording
  - : Stop
- 9 Softkeys.
  - Joystick functions:
    - Joystick left/right: Navigation between the control keys.

### 5.17.3 Menu Options

At the bottom there are the function keys. They are.

-  Exit: Exits this function. If exits when it is recording it does not stop the recording. To stop press stop key.
-  Delete file: It deletes files selected on the recording files window (after a warning message).
-  Export to USB: It copies files selected to the USB.
-  Advanced: It allows user to select between record on internal memory or on USB.

### 5.18 Tilt\*

\*, only available for RANGER *Neo* +

#### 5.18.1 Description

The Tilt function displays on-screen, graphically and numerically, the difference in level between any four carriers. This function works for upstream and downstream band. **Tilt** is the difference in amplitudes between the minimum and maximum frequency that the system can compensate.



Typically, CATV networks transmit two pilot signals at the beginning and at the end of the band. These signals are the ones that can be tuned simultaneously on the screen. By this way you can evaluate the losses slope and therefore readjust equalizers of the amplifiers in order to compensate these losses and ensure a flat response along the band.

## 5.182 Operation

**Tilt** function is available for DVB-C and DVB-C2 signals.

- 1 Connect signal to input and check in Settings the source signal is RF and band is terrestrial.
- 2 Press **F3**: **Tools** and select Tilt & Scan option. Then select Tilt option.
- 3 Tilt function opens.
- 4 Enter two pilot frequencies at the start of the band (freq 1 and freq 2) and two pilot frequencies at the end of the band (freq 3 and freq 4).
- 5 Tilt appears on screen graphically and numerically.
- 6 Press Exit to quit this function.

### ► Screen Description

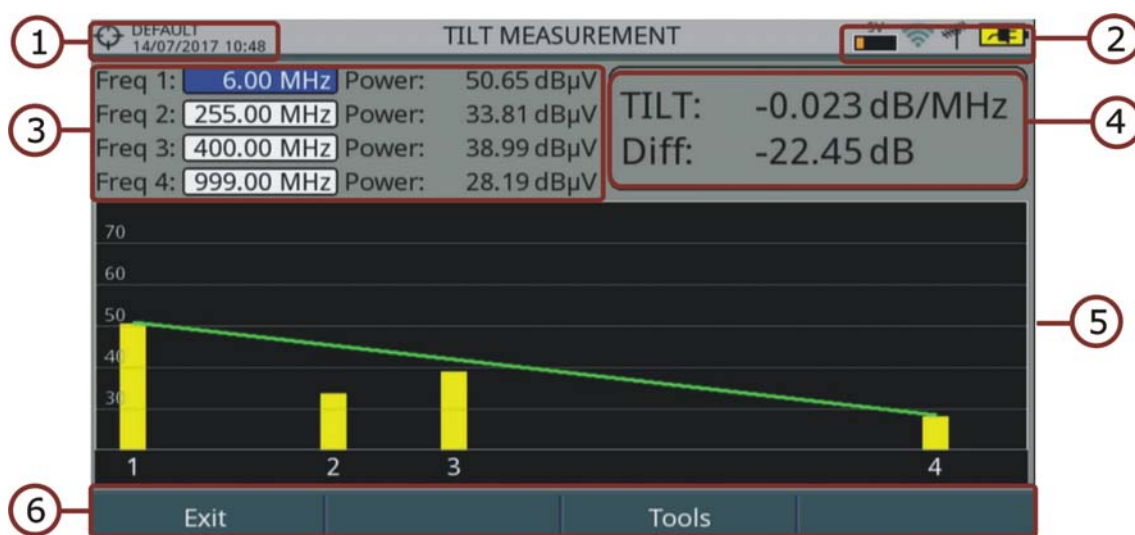

**Figure 95.**

- 1 Selected installation; date and time.
- 2 Icon area.



- 3 Pilot frequencies 1 to 4 and power level of each one. These frequencies can be selected by the user.
- 4 TILT value in dB/MHz and difference between pilot frequency 1 and pilot frequency 4 in dB.
- 5 Graphic bar for each frequency pilot power and resulting TILT.
- 6 Softkeys.
  - F1: Exits function.
  - F3: Access other tools.
- Joystick functions:
  - Joystick up/down: Change of pilot frequency.

## 5.19 Scan \*

\*. only available for RANGER *Neo* +

### 5.19.1 Description

The Scan function shows on screen the signal level in a graph bar for each one of the channels in the channel plan.

### 5.19.2 Operation

The **Scan** function is available for all DVB-C and DVB-C2 signals.

- 1 Connect signal to input and check in Settings the source signal is RF and band is terrestrial. Select channel plan and tune a channel.
- 2 Press : **Tools** and select Tilt & Scan option. Then select Scan option.
- 3 Scan function opens.



## ► Screen Description

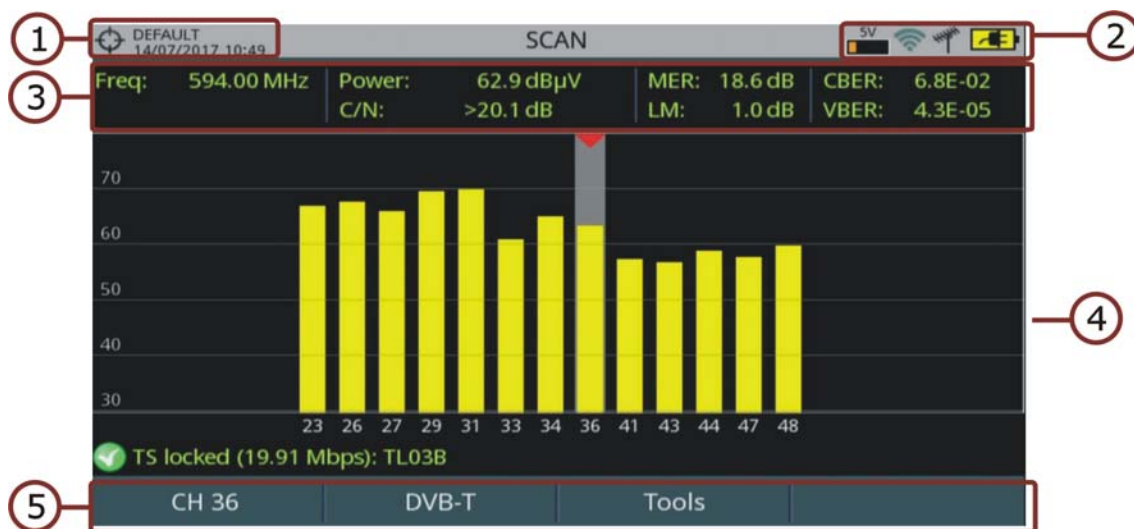

**Figure 96.**

- 1 Selected installation; date and time.
  - 2 Icon area.
  - 3 Frequency and measurement for the selected channel.
  - 4 Graphic bar of power for each channel in the selected channel plan. The shadow area with a red arrowhead shows the selected channel.
  - 5 Softkeys.
    - F1: Change of channel, channel plan or tune.
    - F2: Parameters for the tuned signal.
    - F3: Access tools.
- Joystick functions:
- Joystick left/right: Change channel.

## 5.20 Streaming V/A\*

\*. only available for RANGER Neo +

### 5.20.1 Description

The Streaming V/A function broadcasts video/audio from the meter to a PC using a data network.



### 5.20.2 Operation

The Streaming V/A function is available for all digital signals.







### ► Settings

- 1 Press "Installation management" key for one second to access the "Preferences" settings.
- 2 Go to "Streaming V/A" tab and set streaming parameters:
  - IP Address: It is the IP address of the computer where we are going to broadcast in streaming from the meter.
  - Port: Computer broadcasting IP port.
- 3 Once done, press  to save changes and  to quit "Preferences".

### ► Operation

- 1 Tune channel and service to broadcast in streaming.
- 2 Connect the Ethernet cable to meter using the IP CTRL port.
- 3 Press key : Tools.
- 4 Select Streaming V/A option. There are these options:
  - Start TS: It starts streaming the complete Transport Stream (all services).
  - Start Current Service: It starts streaming the selected service.
  - Stop: It stops streaming.
- 5 The icon  at the top right corner means streaming is working.
- 6 To watch streaming service from a computer you need a software that can play this type of service, such as VLC multimedia player (free software).
- 7 In VLC, open "Media" from tool bar and select "Open Network Stream".
- 8 In the box "Enter a network URL" enter this text **udp://@:1234** and press on "Play". "1234" is the port in the computer (see settings section). If everything is right, it will play the service on the computer screen.
- 9 If you are streaming the whole TS, open "Playback" from toolbar and select "Program". It will show all available TS services. Select the service to watch on screen.
- 10 To exit streaming, press : Tools, select "Streaming V/A" and then "Stop".





## 6 WIFI MONITORING

### 6.1 Introduction

WiFi allows connectivity and communication among devices in the 2.4 GHz and 5 GHz frequency band. These bands are used by several technologies simultaneously, such as Bluetooth, Wireless USB, Zigbee (used in Domotics), cordless phones, security cameras, microwave ovens, etc. which may interfere on WiFi devices. For this reason it is necessary to have a tool that can analyze all these signals to detect problems and ensure good level in WiFi communication.

On the panel side the equipment has two functions keys which give direct access to two functions to display WiFi signal.

- MEASUREMENT : Access the "Site Survey" screen which shows all access points (AP) and its characteristic parameters.
- SPECTRUM : Access the "WiFi Spectrum" screen which shows the spectrum signal over WiFi channels and detected Access Points.



### 6.2 Operation

- 1 Connect the USB WiFi adapter (supplied) to one of the two USB ports on the device. The "Wi-Fi Configuration" window pops up and it performs a Wi-Fi scan showing all networks detected. The WiFi icon will appear at the top of the screen. Press F1 to exit because it is not necessary to log in a WiFi network to use this tool.
- 2 Connect the RF omni-directional antenna (supplied) to the RF input. This antenna detects WiFi band spectrum.
- 3 Press "Settings" key to access Settings menu. In "Signal Source" select "WiFi".
- 4 Press "Settings" key again, access "Band" option and select a band from available WiFi\* bands.
- 5 The first screen is the "WiFi Spectrum" screen. This screen shows spectrum and access points over channels in the selected band. This spectrum is traced through signal coming from the RF input. So it shows any signal using this band, not only WiFi signals (for more details refer to next section).

---

\*. 5 GHz WiFi band available as an option for RANGER *Neo* +.



- 6 To display Access Points information, press Measurement key . Press "Advanced" key (F4) for more details about access points (for more details refer to next section).
- 7 To display the WiFi spectrum screen again press Spectrum key .
- 8 To start monitoring, select tuning mode whether to tune by access point (AP) or channel (CH) using the F1 "Tuning" menu (enabled tuning mode is shown on joystick icon). Then enter an access point or channel or navigate left / right through the access points / channels. Define the workspace using the span to focus on the desired APs.
- 9 To return to RF signal source press "Settings" key to access the Settings menu and in "Signal Source" option select "RF".

### 6.3 WiFi Access Point Connect

To connect to a WiFi access point you need to log in that network. Configuration window is available when the USB WiFi adapter is connected to the device. It shows up right after is connected. It is also available as an option in "Tools" menu (F3 key).

WiFi settings are:

- Band\*: Select the WiFi frequency band where to scan networks.
- DHCP: Enable this option to get automatically the proper IP address when the unit is first connected to your network. This option works if your router has enabled the DHCP protocol. Enable the DHCP protocol for proper IP configuration. If DHCP is OFF you should enter data in next fields.
- IP Address: IP address of the meter into the local network.
- Mask: Subnet mask of the equipment (usually 255.255.255.0).
- Gateway: It allows the meter to get out from the local network (if the network does not have gateway, use 0.0.0.0).

### 6.4 WiFi Spectrum

#### 6.4.1 Description

This function shows spectrum on the WiFi band over access points and also data and measurements such as power, identification and channel bandwidth. Set the screen to clearly see each channel occupation.

---

\*. 5 GHz WiFi band available as an option for **RANGER Neo +**



With this function you can determine the occupation of each channel, how many APs share the same spectrum and activity at any point on the spectrum.

All this information help user to determine the best place to place the AP or to analyze interferences on the spectrum.

To display the WiFi spectrum screen from the WiFi tuning mode, press the Spectrum key .

## 6.4.2 Screen Description

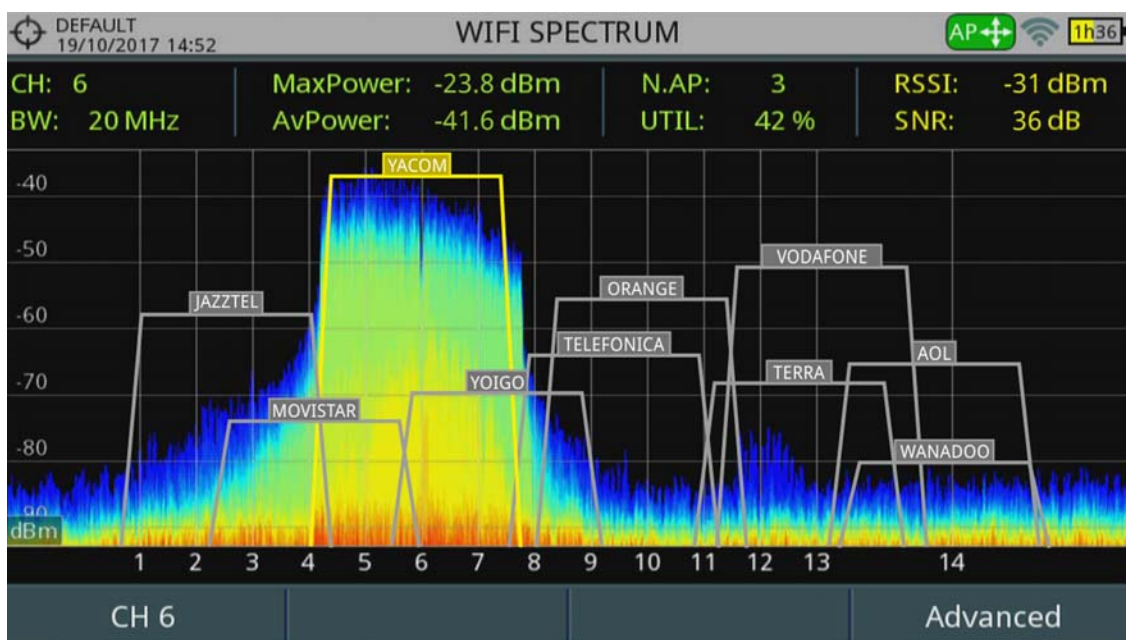

Figure 97.

### 1 Measurement

- CH:
  - When **tuning by Access Point** it shows the central channel for the Access Point selected. The Access Point selected is highlighted for easy identification.
  - When **tuning by Channel** it shows current channel. If selected channel is the central channel of an Access Point then the AP is highlighted and shows data for that Access Point.
- BW: It shows Access Point (AP) bandwidth. Bandwidth changes depending on the AP. Each AP can work in different bandwidths depending on standard and configuration.
- AvPower: RMS value of power detected (dBm) in the bandwidth occupied by the AP or channel selected.



- **MaxPower:** Maximum power detected (dBm) within the bandwidth occupied by the AP or channel selected.
- **N.AP:** Number of access points using the same channel. This number determines if the channel is very saturated. If it is used by more than one AP there may be times with a high percentage of use.
- **UTIL (%):** Percentage of channel used. It is a measurement based on how much time the channel is used. This measurement can help to decide if this channel can accept another AP.
- **RSSI (Received Signal Strength Indicator):** Power measured by the dongle (USB WiFi adapter) for the selected Access Point. The dongle measures the power of a single AP and the meter measures the power of an area of the spectrum where there may be several APs. For this reason and also for using different type of antennas on each device, the power measured by the dongle and by the spectrum may not match.
- **SNR (Signal to Noise Ratio):** SNR measured by the dongle (USB WiFi adapter) for the selected Access Point.

## 2 WiFi Spectrum

It shows WiFi channels within the WiFi band, Access Points detected and name, bandwidth and spectrum. Spectrum is drawn from the signal received by the omni-directional antenna connected to the RF input.

This screen allows you to know how busy each channel is, how many APs share spectrum, activity in each point of spectrum, etc. Spectrum not only shows WiFi signals but any signals that use this band, such as those coming from security video cameras, etc. which allows you to easily identify interferences in a network.

- **Joystick functions:**
  - Joystick press: It changes mode.
    - In tuning by Access Point: (-> AP -> SP ->).
    - In tuning by Channel: (-> CH -> SP ->).
  - Joystick left/right:
    - In AP mode: It changes Access Point.
    - In CH mode: It changes WiFi channel.
    - In SP mode: It changes span.
  - Joystick up/down: It changes reference level.



### 6.4.3 Menu Options

#### ► Tuning Menu (F1)

Press F1 to access this menu. It has some options to tune a channel or an access point. Tuning menu has these options:

- **Channel:** It allows you to select the channel to tune. After pressing it shows available channels to select.
- **Channel Plan:** This option allows the user to select a channel plan from the ones available for the current installation. It is necessary a Channel Plan to work on WiFi band. Load a WiFi channel plan if your installation does not have any (WIFI\_2\_4GHZ is available by default).
- **Tune by:** It allows the user to select between tuning by channel or tuning by access point.
  - Tuning by channel: It allows you to select a channel or jump from channel to channel by pressing left / right. When the channel corresponds to an Access Point central channel, the AP highlights and shows some information on screen (RSSI and SNR).
  - Tuning by AP: It allows you to select a AP or jump from AP to AP by pressing left / right. The selected AP highlights and shows some information on screen (RSSI and SNR).
- **Reference Level:** It allows you to edit the reference level. The reference level is the power range represented on the vertical axis. Reference level can also be change using joystick up/down.
- **Span:** It allows you to edit the span, which is the frequency range displayed on screen. Span can also be change using joystick left/right in SP mode.
- **Center Tuned Frequency:** When selecting this option, the channel / Access Point tuned (where the main cursor is pointing) is placed at center of the screen. This option does not work with FULL span.

#### ► Advanced Menu (F4)

Press F4 to access this menu. It has some options to display the spectrum.

- **Persistence samples:** It allows you to set retentive depth of spectrum. This option helps to identify level of channel usage by non-wireless signals such as those generated by microwave ovens or some wireless video cameras. The more presence of this type of signals in the channel, the brighter the spectrum will appear on screen.
- **Resolution Bandwidth:** Resolution filters available are: 100 kHz, 200 kHz\* and 1000 kHz\*\*. According to the filter being selected, that maximum and minimum span allowed is modified.



- Vertical Range:** It allows you to adjust vertical range on screen. Available values are 1, 2, 5 and 10 dB per division.

## 6.5 Site Survey

### 6.5.1 Description

This function shows a chart listing all Access Points detected and its main parameters.

To display the Site Survey screen from the WiFi tuning mode, press the Measurement key .

To display a detailed report about a selected Access Point, select one and press F4: Advanced \ View all parameters.

### 6.5.2 Screen Description

#### ► Access Points at Site Survey



| SSID       | BSS               | CH | RSSI (dBm) | Security | Device              |
|------------|-------------------|----|------------|----------|---------------------|
| JAZZTEL    | 01:23:45:67:89:ab | 1  | -86        | WPA      | Wireless Router ... |
| M OVI STAR | aa:bb:cc:dd:ee:ff | 2  | -72        | WPA2     | WAP6969N            |
| YACOM      | 98:76:54:32:10:fe | 3  | -84        | WPE      |                     |
| YOIGO      | a1:b2:c3:d4:e5:f6 | 4  | -74        | Ninguno  |                     |
| ORANGE     | 22:44:66:88:ab:cd | 5  | -70        | WPA      |                     |
| VODAFONE   | 13:57:92:46:80:31 | 6  | -88        | WPA      |                     |
| ARRAKIS    | ca:ac:ed:de:fb:bf | 7  | -78        | WPA      |                     |
| TELEFONICA | 57:26:21:44:a6:89 | 8  | -76        | WPA      |                     |
| TERRA      | 11:85:e5:74:0c:53 | 9  | -80        | WPA      |                     |
| WANADOO    | b4:07:32:41:a6:1c | 10 | -82        | WPA      |                     |

CH 1 | Advanced

Figure 98.

- \*. only available for RANGER Neo +
- \*\*.. only available for RANGER Neo +



- SSID (Service Set ID): Access Point Name.
- BSS (Basic Service Set ID): MAC of Access Point.
- CH: Central Channel of Access Point.
- RSSI: Power (in dBm) of AP received. This power is measured by the USB WiFi adapter.
- Security: Type of security to access the Access Point.
- Device: Name of device's manufacturer that provides infrastructure. Not always available.
- Joystick functions:
  - Joystick up / down: It changes Access Point.

### ► Access Point Report

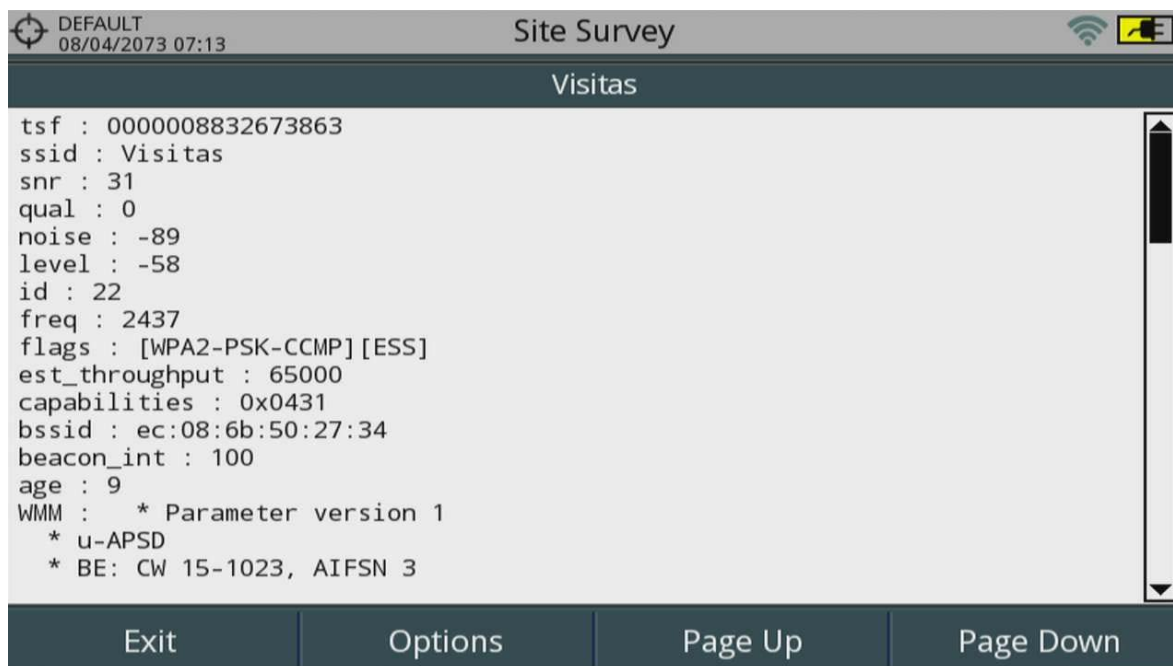

Figure 99.

- Joystick functions:
  - Joystick up / down: It scrolls along the report.

### 6.5.3 Menu Options

#### ► From Site Survey screen:

- Advanced Menu (F4).
  - View all parameters: It shows a detailed report about the access point selected.





► **From Access Point Report screen:**

- Exit (F1): Returns to the previous screen.
- Options (F2).
  - Copy to USB: If you insert a USB memory into a USB port you can copy the Access point report.
- Page Up / Page Down (F3/F4): It scrolls through the report.



## 7 OTT





### 7.1 Introduction

OTT or Over The Top refers to video, audio and other media services delivered directly to the user over the Internet, for Video on Demand or Live broadcasting. There are different standards being used to deliver OTT services. MPEG-DASH and HLS are the most popular. All OTT protocols address the fundamental problem of poor viewer tolerance to disruption or buffering during video play out caused by the naturally changing network conditions of the Internet

To solve these problems, the OTT servers provide the same audio / video fragments in different resolutions and bitrates so the user can select one or the other depending on the network conditions. This helps to decrease the annoying effect of buffering.

To know server's availability is important, so the client media player can select the right quality at a certain time. This information is contained in the HLS MANIFEST file or in the MPEG-DASH MPD file (Media Presentation Description). The meter can retrieve and display the information of these files and download the selected content by segments and also it shows the download bitrate in a graph.

### 7.2 Operation

- 1 Connect the OTT signal to the meter through the IP CTRL port.
- 2 Press "Settings" , and select OTT on "Signal Source".
- 3 First screen OTT 1/2 shows the log with some system messages. Press again on  to switch to screen OTT 2/2. This screen shows segments loading in sequence.
- 4 Press URL . It shows a list of available URL. Select one URL. It also allows the user to import a URL file from a USB pendrive by pressing  "Import from USB". The file to import must be named OTT with URL format and must be placed at the pendrive root.
- 5 The meter downloads the file (MANIFEST or MPD) from the URL. This file should contain a description of all content available on the server.
- 6 The meter validates the description file and shows basic information about the description file (type and profile). If there is any problem while downloading it will show a message on screen.
- 7 Then the meter selects one available stream and shows it on "Representation". OTT 1/2 screen shows detailed information about the



selected stream. OTT 2/2 shows the sequence of segment requests and result (OK, failed). To view the OTT segment download bitrate in a graph press .

## 7.3 Screen Description

### 7.3.1 OTT Mode

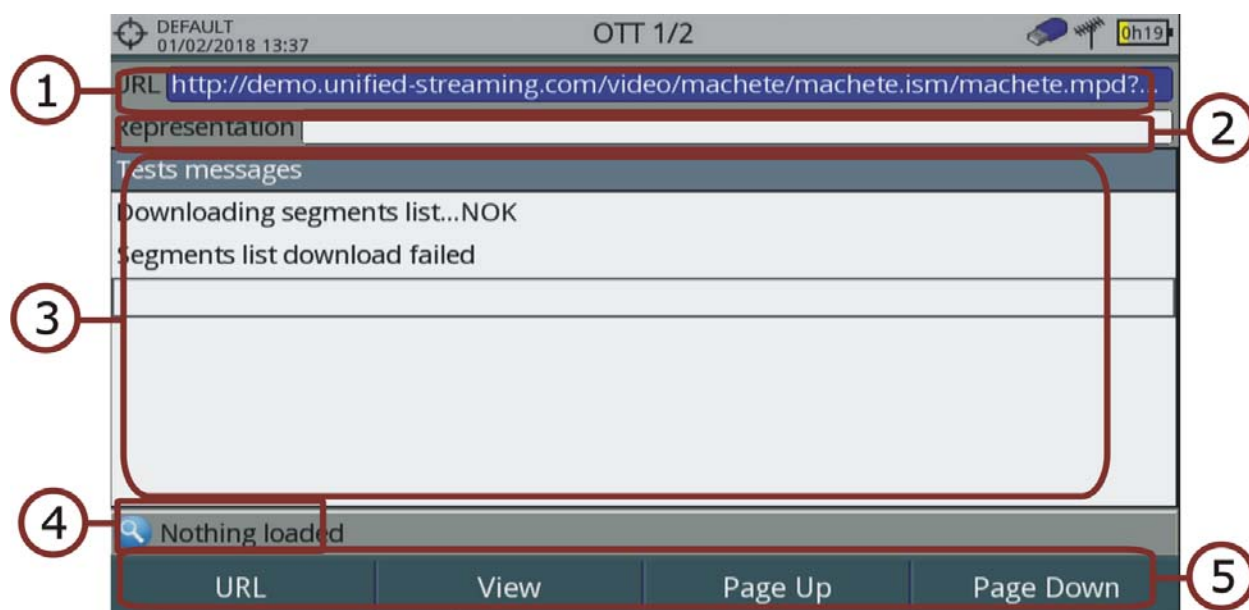

**Figure 100.**

- 1 URL selected.
  - 2 Representation selected (resolution and profile).
  - 3 System messages log.
  - 4 Standard status.
  - 5 Softkeys menus (for more details refer to ["Menu Options" on page 148](#)).
- Joystick functions:
- Joystick up/down: It scrolls screen up and down.

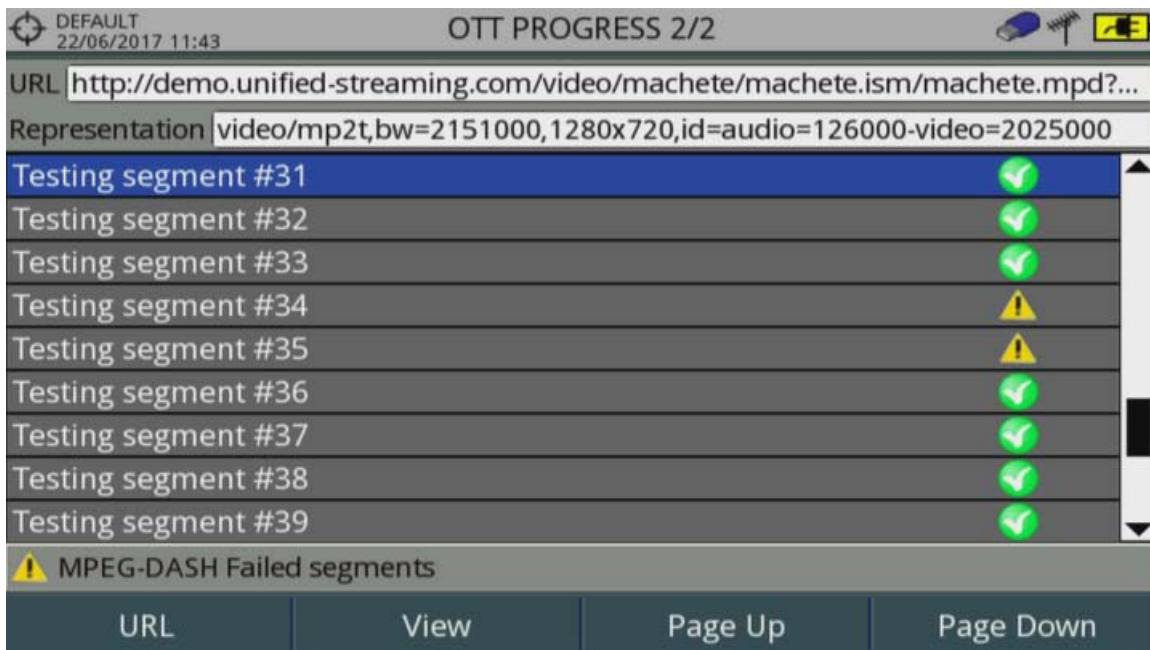

Figure 101. Log for Segment request and status

7.3.2 OTT Segment Bitrate

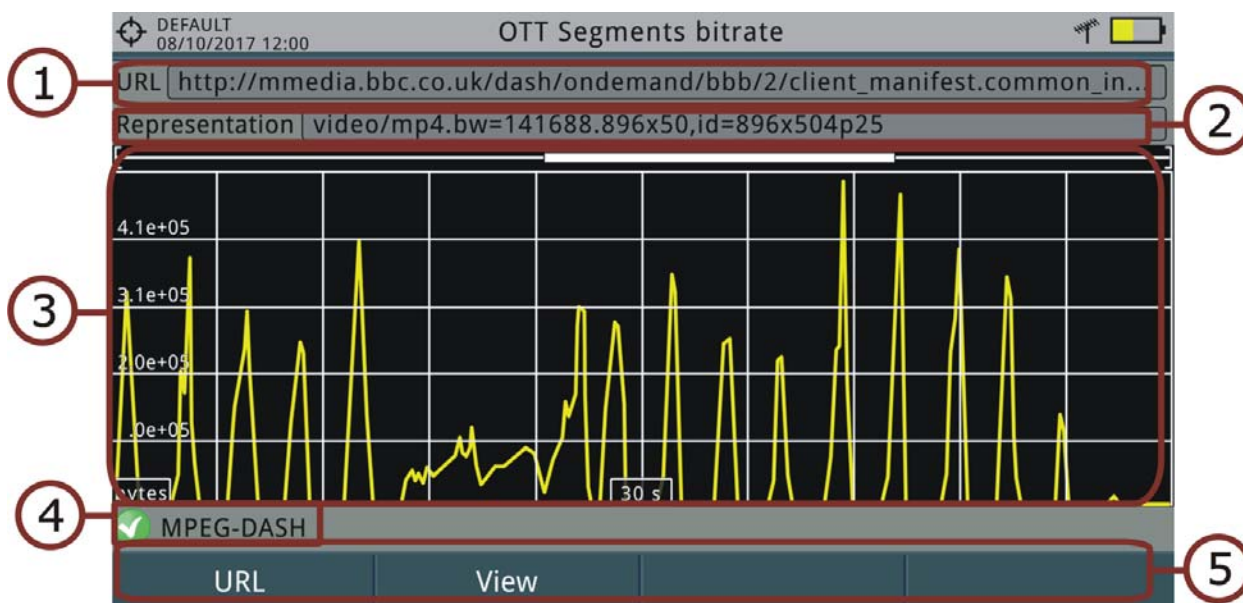

Figure 102.

- 1 URL selected.
- 2 Representation selected (resolution and profile).



- 3 Bitrate of segments download. Graph scrolls to right while segments downloading.
- 4 Standard status.
- 5 Softkeys menus (for more details refer to next section).
- Joystick functions:
  - Joystick up/down: Decreases/Increases time span.
- Axis description:
  - Axis X: Time Span (s).
  - Axis Y: Download size (bytes). This axis re-scales according to biggest value.

### 7.3.3 **Menu Options**

At the bottom of the screen there are some menus available via the function keys.

- **F1** URL: It shows a screen with a list of available URL from which download segments. It also allows you to import URLs from a file on a pendrive. This pendrive must have a file named OTT.URL on the root in order to be imported.
- **F2** View: There are two options:
  - Presentation Description: It shows a MPD file in text format.
  - Presentation Parameters: It shows most common MPD parameters.





## 8 INSTALLATIONS MANAGEMENT

### 8.1 Introduction

The Installations Management is a program embedded in the equipment that allows the user to easily create a file (installation) to individually store and manage data for each installation. Measurements, channel plans, screenshots and any other data associated with the installation will be stored in the folder corresponding to that installation. These measures can then be displayed and downloaded to a PC.

If the user does not create any file installation, the equipment stores measurements in the installation file by default (named "DEFAULT").

### 8.2 Operation

- 1 To access the Installations menu press the key .
- 2 It shows up a window with a list of all available installations. On the softkeys appears the options to manage these installations.
- 3 To exit the list of installations press the key .

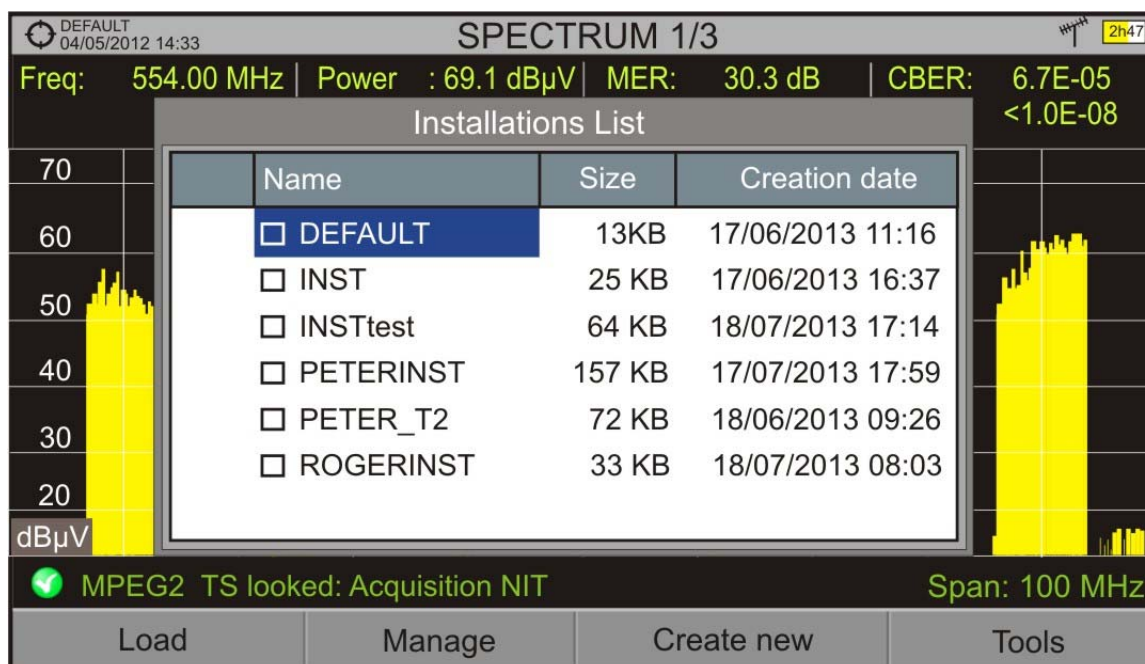







Figure 103.



There are the following options:

- **Load** : It loads the selected installation. To select a installation from the list, place the cursor on the installation and press the joystick, then press "Load"  to load it. Once loaded, the name of the installation appears on the upper left corner of the screen, accompanied by the symbol , that means that is the current installation. All measurements, screenshots, channel plans and other data since this moment will be stored in the current installation.
- **Manage** : It opens a window that displays all data of the current installation and from where they can be edited, changed or view (for more details refer to next section).
- **Create New** : It creates a new installation with the data introduced by the user (for more details refer to next section).
- **Tools** : It shows up a menu with some tools to use with the installations (see "Tools" section).

### 8.3 Installation Management

The DEFAULT installation is the installation preinstalled on the equipment. It is like any other installation and it can load channel plans, DiSEqC programs, etc. The DEFAULT installation can not be deleted or renamed.

In the list of installations, press on the option Manage  to access to the Installation manager screen:

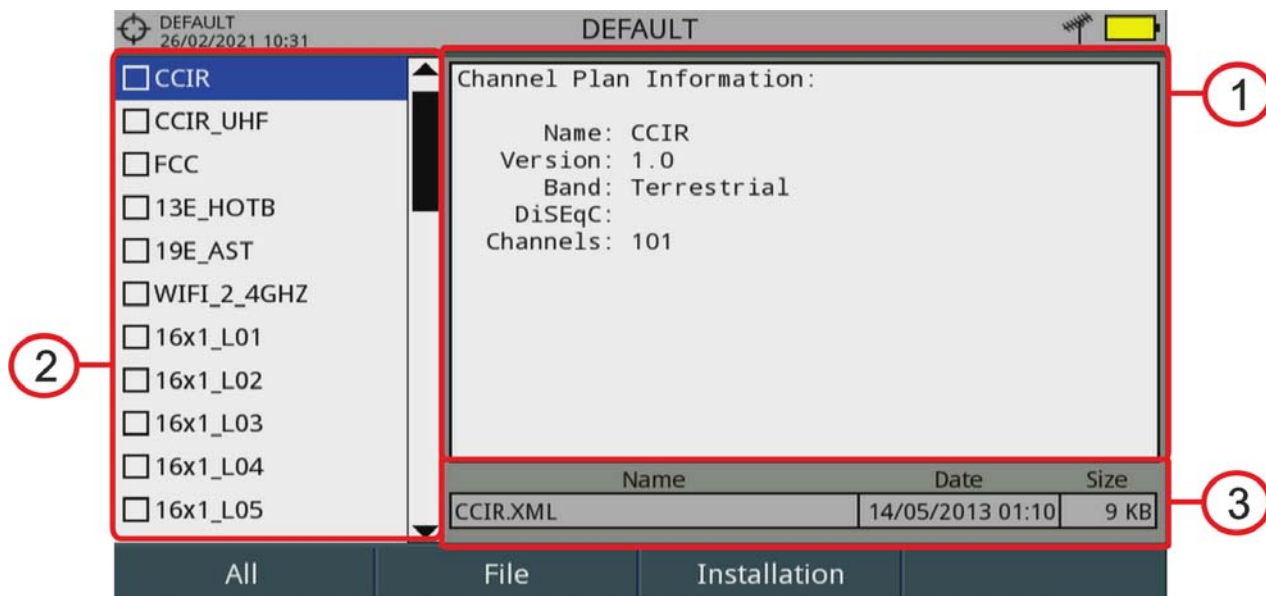

**Figure 104.**

The window is divided into three areas:

- 1** Display Area: It is the area where data file description is displayed. The file data is displayed only if the cursor is placed for a moment on the file name. For a screenshot, it displays a thumbnail of the full screen, as captured. In the remaining cases, it only shows some data description of the file type. If there is any extra option associated with the file, it will appear on the **F4** key
- 2** List of Files: It shows all types of data files in the selected installation. These can be: screenshots, channel plans, dataloggers, DiSeqC commands, data captures, signal monitoring, service databases and antennas. To move along this file list move the joystick up or down. Any of these files can be selected or deselected by pressing the joystick.
- 3** File Description Area: It shows file name, extension, creation date and time and size.

### ► Menu Options

The installation manager menu has four options linked with the softkeys. They are described below:

- **F1** Filter by Type: It shows all available file types in the current installation and the amount of them between brackets. User can filter by file type. The selected file type will be the only one available in the list of files. Available file types are: screenshots, channel plans, dataloggers,





DiSeqC commands, data captures, signal monitoring, service databases and antennas (or all).

- **F2** File
  - Mark All: It marks all files on the list of files area.
  - Unmark All: It deselects all files on the list of files area.
  - Delete: It deletes all selected files on the list of files area.
  - Copy to USB: It saves selected files on the list of files area to an USB stick connected to the equipment. If the name of the file to be copied is greater than 8 characters the system cuts it. If the file name is cut and matches with another one, then it is added a number to the name to make them different. For instance, 2 files with similar names, like FILENAME01 and FILENAME02 both files will be correctly copied with names FILENA~1 and FILENA~2. To keep the file names with more than 8 characters it is recommended to export the complete installation using the "Export to USB" option (see "Tools" section). The Datalogger files copied to the USB cannot be used to generate reports by the NetUpdate program. To do this the datalogger files must be exported directly through the NetUpdate program (for more details refer to NetUpdate manual on PROMAX website).
  
- **F3** Installation
  - Add Channel Plan: It opens a window to add a channel plan, terrestrial or satellite and band (for optical option), to the current installation.
  - Add Antenna: It allows the user to add an specific antenna among the ones available. To import an antenna refer to "Field Strength" section in chapter "Tools".
  - Add DiSEqC program: It allows the user to select and add to the current installation any DiSEqC program available in the equipment.
  
- **F4** Options: This option appears if there is any extra option associated with the file type.
  - See Full Screen: This option only appears if user selects an image in the list of files. It displays the selected image full screen.
  - DiSEqC Program: This option only appears if a satellite channel plan is selected in the list of files area. It allows the user to add a Diseqc program to the selected satellite channel plan from the list of diseqc programs available for the current installation.
  - Open File: This options appears if the file type selected is datalogger, data capture or signal monitoring. In case of data capture (if the capture was done in the Spectrum Analyzer mode) shows the spectrum reference. In case of signal monitoring it opens the signal monitoring viewer.

To get out from the Installation manager press any key to access MEASUREMENT, SPECTRUM or TV mode.



[Click here to watch this video: Installation manager](#)

## 8.4 New Installation

In the list of installations, when selecting the option Create New  it runs the installation wizard that helps to create a new installation.

- 1 During the process, the user has the option to edit the default name assigned or import data from another installation.
- 2 The user can select the channel plans (terrestrial and satellite) that will be used in that installation. At least one for each band has to be selected.
- 3 For satellite channel plans the user can select the Diseqc commands associated to the installation and also the satellite band (Ku-Ka or C band) and the frequencies of the LNB Oscillator.
- 4 During the creation process the softkeys functions are: Next (it goes to the next step), Previous (it goes to the previous step) or Cancel (it cancels the process).
- 5 When finish, the new installation created will be the current installation.

## 8.5 Tools

In the list of installations, when pressing the Tools  option it shows a menu with some options to edit the installation files:

- Mark All: It selects all installations in the list of installations.
- Unmark All: It deselects all installations in the list of installations.
- Archive: It compresses (using the ZIP algorithm) the selected installations to save more space. A zipped installation shows a box icon  at the left side in the list of installations. A zipped installation can be loaded as anyone else, but the load time can be slightly higher because previously it is unzipped automatically. Once the installation is unzipped the user must



re-zip it if necessary. To transfer an installation file from the equipment to a PC, it must have been previously zipped.

- **Delete:** It deletes the selected installations and all the files associated to them. The DEFAULT installation cannot be deleted.
- **Rename:** It edits the name of the installation selected in the list of installations. The installation by default DEFAULT cannot be renamed.
- **Export to USB:** It saves the installations files selected in the list of installations to an USB stick connected to the instrument. The installation file is exported in zip format.
- **Import from USB:** It imports installation files from a USB stick connected to the equipment. It has to use the same folder structure that is generated when exporting to USB (for more details refer to next section).
- **Installed Antennas:** It allows you to remove antenna files on the meter.



## 8.6 Importing Data from USB

The data import tool allows the user to import data files in a simple way from an USB flash drive to the equipment.

Data available to be imported are:

- Installations.
- Channel Plans.
- Antennas.

### ► Operation

- 1** Copy the file to be imported on a flash drive and plug it into USB port. The file must be in the proper format so the system can recognize it.
- 2** Press the Installation Management key .
- 3** Press the key  "Tools".
- 4** Select the "Import from USB" option.
- 5** The Import Files window appears. Select the file and press the  key: "Import".

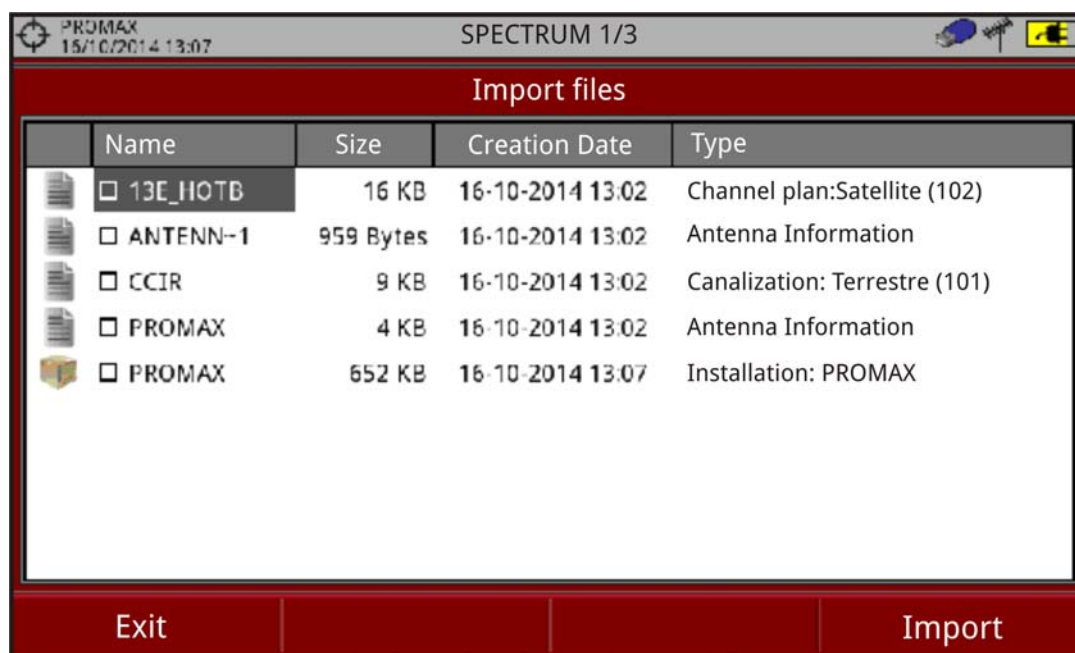

**Figure 105. Import Files window**

- 6 If the file import is successful then a window shows a confirmation message.



## 9 WEBCONTROL\*

### 9.1 Introduction

The webControl function allows you to connect remotely to the meter in order to visualize measurements and operate on it. The meter must be connected to an Ethernet network. To connect to meter from a remote access device use just a standard web browser.

WebControl tools are:

- Measurement and Spectrum: It shows spectrum and measurement from the tuned channel.
- TV Parameters: It shows data, video and audio from the tuned channel.
- Console: It emulates and allows you to interact with the meter in first person.
- Monitoring: It monitors parameters from channels selected by user.
- Historical Monitoring: It contains data from monitoring and they can be exported.
- Installations Management: It manages installation files and creates channel plans.
- Task Management: It allows the user to schedule some tasks.

Next section explains how to configure the meter to be able to connect remotely. Following sections explain each work mode.

### 9.2 Settings and Remote Access

#### ► Meter Settings

- 1 The meter can be connected to a data network via an Ethernet cable or via WiFi. To access the configuration parameters:
  - Ethernet network: From the meter, access the preferences options by pressing the "Installations"  key for 1 second. Go to the "Network" tab where you can find the configuration parameters to register in the network.
  - WiFi network: Connect the USB WiFi adapter and the WiFi configuration window will appear or you can also access through the "WiFi configuration" menu from the "Tools" button (F3).

---

\*. For RANGER Neo Lite only the Installations Management tool is available.



- 2 Select DHCP ON, if you connect the meter to a network with a router or server with DHCP protocol enabled. Then the network will set automatically the parameters in the meter. If not, follow the next steps to set the meter.
- 3 On "IP Address" box enter the meter IP. Use an IP in the same range used by your PC in the local network (if you do not know these data see "find out local network data" section). For instance, if the IP for your PC is 10.0.1.18, the meter must have a free IP in the same range, like 10.0.1.50.

**NOTE:** Another option is to keep the default configuration in the meter and set an IP in your PC in the same range as the meter. The default IP of the meter is 10.8.8.188\* so the PC should use a free IP in the same range, for example 10.8.8.50.

\*. For firmware versions prior to 26.8 the default IP is 10.0.6.198

- 4 In the "Mask" box, enter the mask value, which should be the same as the one used by the local network (usually 255.255.255.0; if you do not know these data see "find out local network data" section).
- 5 To connect the meter from an external network, fill in the "Gateway" with the info obtained from the local network.
- 6 Press on "Save" and then "Exit" to save changes and exit.
- 7 Connect the meter to a data network with Internet access. You can use an Ethernet cable connected to the IPCTRL port or in case of WiFi network, connect the USB WiFi adapter, select the network and enter the password.

#### ► Find out Local Area Network Data (LAN)

- 1 To obtain data from the Ethernet network where your meter is connected, you should use a PC connected to this same network.
- 2 From the PC click on Start menu in Windows. On the Search box write CMD and press Enter.
- 3 It opens a command line in a window. Write IPCONFIG and press enter.
- 4 It displays a window with some lines with info. On line "Local Network Ethernet Adapter" see line "IPv4 Address". This is the local IP for your PC. Write down this IP. Also write down "Subnet Mask" and "Default Gateway". This data is needed to configure the meter by hand.



### ► Remote Access

- 1 From a remote access device (PC, mobile device) run a standard web browser (Chrome recommended).
- 2 On the address bar write the address to remotely access the meter.
- 3 If the connection is successful, it should appear on screen the webControl welcome screen (see figure). This screen shows the meter model and serial number.

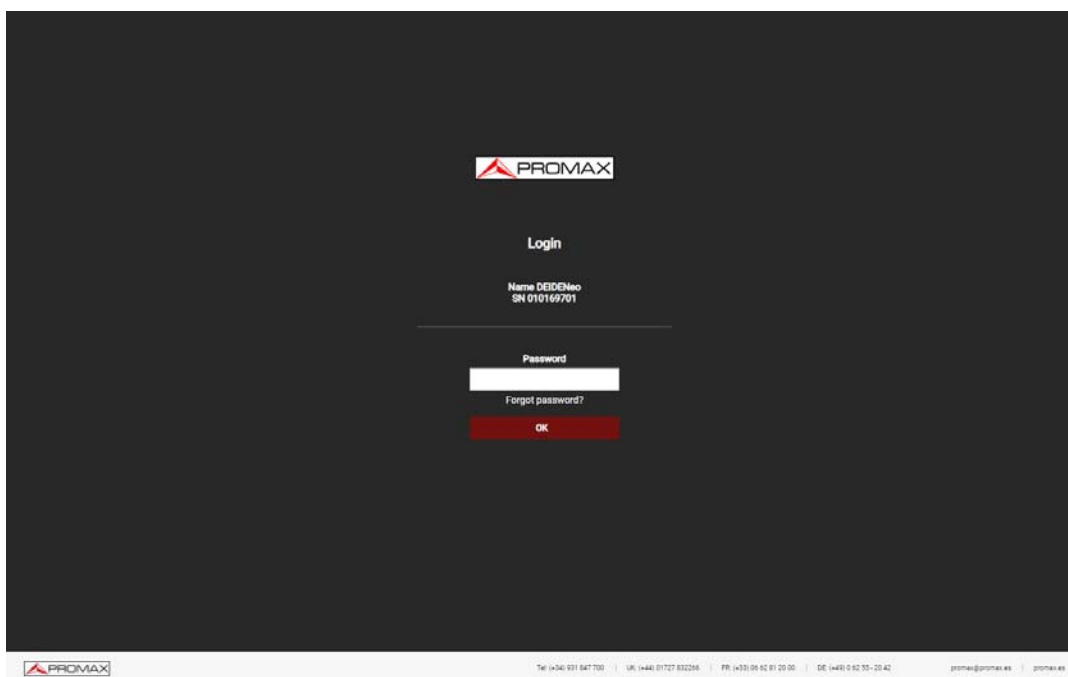

**Figure 106.**

- 4 Enter the password and press OK (password by default is **Password**).
- 5 To identify on the meter that it is connected to the webControl it shows this icon  on the top right corner.

**NOTE:** There are many ways to connect to the meter from an external network. If you have follow these instructions and you fail to connect the webControl, please contact PROMAX technical assistance and we will help you (promax@promax.es).

### ► Password Recovery

If after changing the webControl password you forget it, click on “forgot password?”. It opens a window with some instructions to reset the password. Follow these steps:



A one-time temporary password will be emailed to you, so that you can log in and modify your password.

- 1 Send an e-mail to the PROMAX technical assistance service (promax@promax.es) with the following information:
  - Contact details: Full name, company name and address, phone number and e-mail.
  - Internal number shown on the window.
  - Recovery code shown on the window.
- 2 Once this information is sent, it is checked and if everything is right, a temporary password is sent back. Write this password on the box "temporary password". This password is for one time use.
- 3 If you have access to the main screen go to "Config" on the upper right corner and click on "Change Password".
- 4 A window will appear to change the password. Enter the temporary password in the "Old password" box. Enter your new password in the "New password" box and again in the "Repeat new password" box. Press OK.

## 9.3 Measurements and Spectrum

### ► Description

Measurements and Spectrum screen shows real time spectrum and all measurements of the RF channel if it is tuned. It also allows modifying the reference level, span, type of tuning and channel plan among others. To communicate you need at least 200 kB/s of bandwidth.

To access this screen click on Measurement icon .





## ► Screen Description

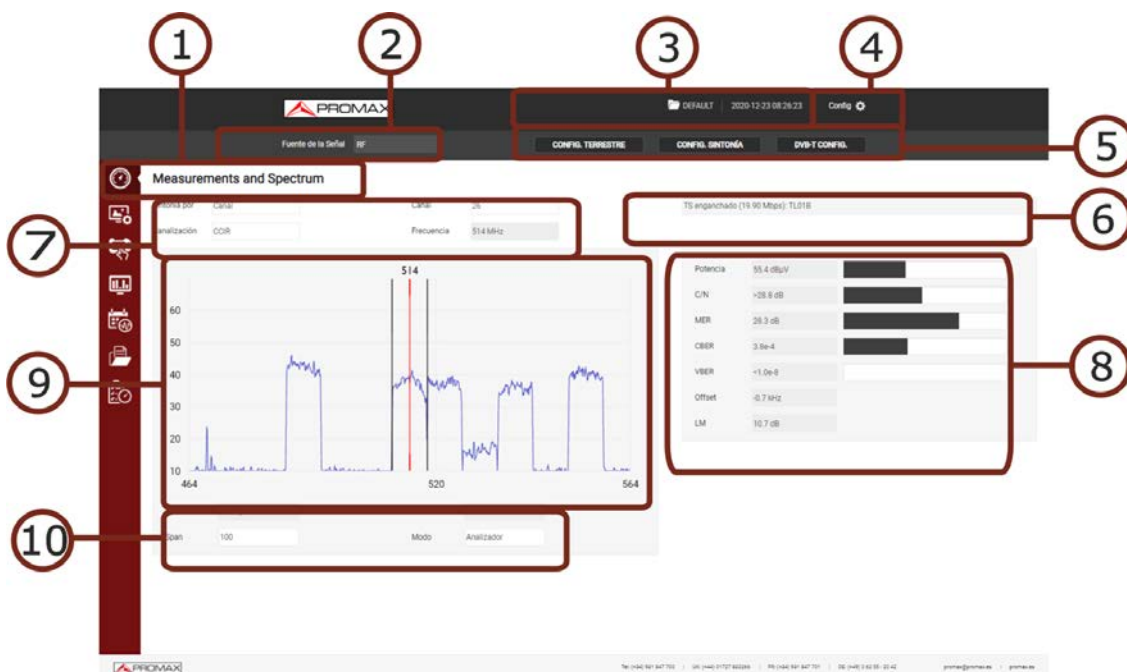

**Figure 107.**

- 1 Selected function (Measurements and Spectrum).
- 2 Source of Signal.
- 3 Selected installation and current date and hour\*.
- 4 Access to settings:
  - Change Password: It allows you to change your password.
  - Reboot Equipment: It allows you to reset your meter after confirmation.
  - About Equipment: It gives information about your meter: model name, serial number, release version / webControl version.
  - Logout: It exits your current session.
- 5 Signal settings. When clicking on a button it shows settings for the current signal and also they can be changed.
  - Terrestrial / Satellite settings (band; external power supply; power voltage; LNB drain).
  - Tuning type settings (tuning by channel/frequency; channel; channel plan; frequency).
  - Tuned signal parameters.
- 6 If shows if signal is locked/unlocked/searching. If it is locked it shows its multiplex.
- 7 Selection parameters: Tuning type, channel/frequency selection and channel plan.
- 8 Signal data: Power, C/N, MER, CBER, VBER, Offset, LM.

\*. In case you have the GPS option installed, it should appear your current geographic coordinates.



- 9 Spectrum graph.
- 10 Spectrum settings parameters: reference level, center frequency, span and analyzer (automatic reference level) / spectrum (reference level set by user) mode.

## 9.4 TV Parameters

### ► Description

TV Parameters screen shows important metadata that identifies the network (NID), (ONID), TS, Service, LCN, etc. and also a slide show of one service that belongs to the selected multiplex. To communicate you need at least 200 kB/s of bandwidth.

To access this screen click on TV icon .

### ► Screen Description

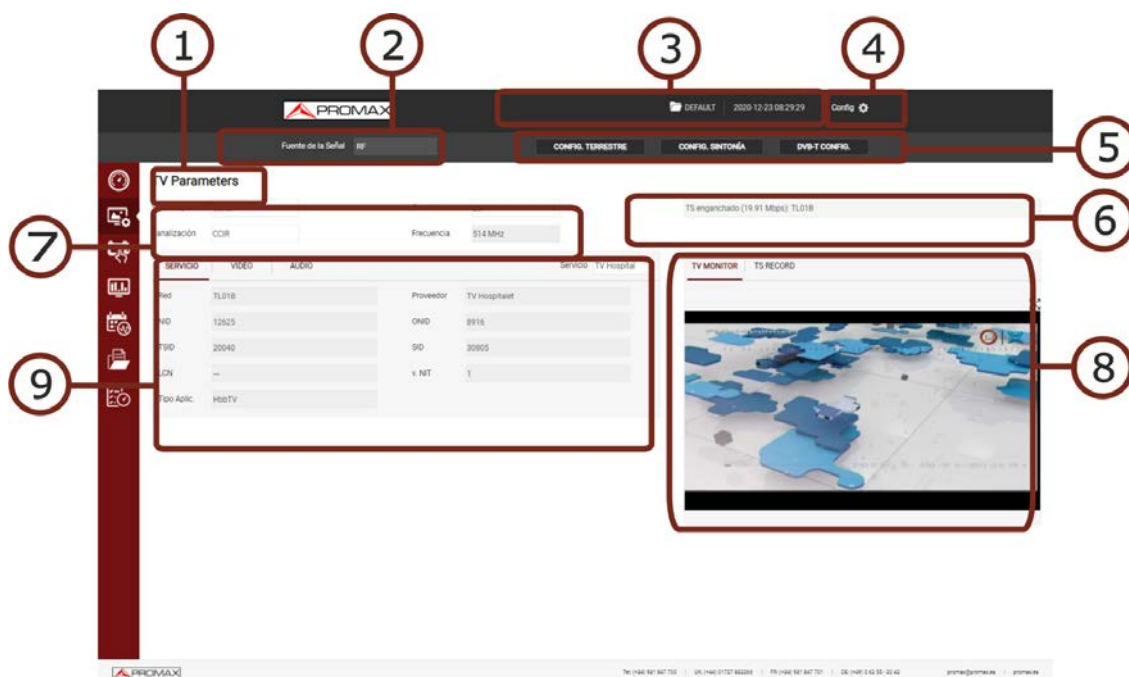



Figure 108.

- 1 Selected function (TV Parameters).
- 2 Source of Signal.
- 3 Selected installation and current date and hour\*.

\*. In case you have the GPS option installed, it should appear your current geographic coordinates.



- 4 Access to settings:
  - Change Password: It allows you to change your password.
  - Reboot Equipment: It allows you to reset your meter after confirmation.
  - About Equipment: It gives information about your meter: model name, serial number, release version / webControl version.
  - Logout: It exits your current session.
- 5 Signal settings. When clicking on a button it shows settings for the current signal and also they can be changed.
  - Terrestrial / Satellite settings (band; external power supply; power voltage; LNB drain).
  - Tuning type settings (tuning by channel/frequency; channel; channel plan; frequency).
  - Tuned signal parameters.
- 6 It shows if signal is locked/unlocked/searching. If it is locked it shows its multiplex.
- 7 Selection parameters: Tuning type, channel/frequency selection and channel plan.
- 8 This area allows you to select between two tabs:
  - TV Monitor: It shows a slideshow of the selected service from the channel locked. The symbol  shows the service full screen. If it is a DAB\* or FM signal, the audio is demodulated and can be listened to. If the DAB signal contains images they are also shown.
  - TS Record: It records the current service (service recording). The file is recorded on the meter itself or on a USB (check option "use USB"). To start recording, fill in the "description" field and click on the red button. It shows available time and space. To stop recording, press the red button again.
- 9 Service option shows the selected service and a list of available services in the channel. Each tab (service, video, audio) shows general details for the selected service and video and audio details.

## 9.5 Remote Console

### ► Description

Console screen allows you to interact remotely with the meter like you were in front of it. To communicate you need at least 3 MB/s of bandwidth. When the emulation is running no other webControl services are available.

---

\*. DAB available as an option for **RANGER Neo +**



To interact with the meter you can use the mouse pointer as a touch on screen and also meter controllers (joystick, function keys and shortcut keys) to access menus and options.

There are some limitations that we will try to solve in future versions. Currently audio is not available.

To access this screen click on Console icon .

### ► Screen Description



**Figure 109.**

- 1** Selected function (Console).
- 2** Selected installation and current date and hour\*.
- 3** Access to settings:
  - Change Password: It allows you to change your password.
  - Reboot Equipment: It allows you to reset your meter after confirmation.
  - About Equipment: It gives information about your meter: model name, serial number, release version / webControl version.
  - Logout: It exits your current session.
- 4** Start / Stop console emulation button.
- 5** Joystick. Click left, right, up or down to simulate joystick movement. Click on centre to simulate enter. You can use the joystick to move along the menus

\*. In case you have the GPS option installed, then it also appears current geographic coordinates.



and to select options. Also you can use your mouse pointer like a finger touch on screen.

- 6 Direct Access keys to access Installation management and Settings. Press for more than one second to access Preferences and Video / Audio settings.
- 7 Direct Access keys to access Measurement, Spectrum and TV mode.
- 8 Direct Access key to Screenshot (screenshot is saved on your remote device and data on the meter).
- 9 Softkeys or Function keys.

## 9.6 Monitoring

### ► Description

The Monitoring function allows you to monitor a signal according to certain parameters.

There are two monitoring types:

- Signal Quality Monitoring: The meter monitors certain signal quality parameters according to value ranges established by the user. If values are outside these margins, the system will notify the user.
- Mask Monitoring<sup>\*</sup>: The meter uses a spectrum captured by the user as a reference. A comparison is made between the reference spectrum and the current one, and if it exceeds the established margins, the system will notify the user.

To access this screen, click on the Monitoring icon .

Next it is explained how to use each monitoring type.

### 9.6.1 Signal Quality Monitoring

#### ► Description

The Signal Quality Monitoring function allows users to select and monitor channels from a channel plan by setting alarms on specific parameters.

When the monitoring has started, historical monitoring can be consulted, but the rest of webControl services are disabled.

---

\*. This function is available only for meters with the "Mask Monitoring" option installed. Contact PROMAX for more information.



Data is stored for 15 days. After that they are overwritten.

### ► Settings

- 1 In "Preferences", check date, time and time zone where the meter is located (for more details refer to ["?Time & Date Options" on page 41](#)) or synchronise time with a NTP server (for more details refer to ["?NTP Options" on page 45](#)).
- 2 In "Preferences", label "Utilities", option "Moni. ddbb loc." select where the monitoring data will be stored: internal memory or hard disk (for more details refer to ["?Tools Options" on page 42](#)).
- 3 You need a channel plan with special information for monitoring. To do that, create a new channel plan from an existing one using the "Explore channel plan" tool in the meter (["Explore Channel Plan" on page 115](#)). If existing channel plans are not enough you can create a new one from scratch from the "Create channel plan" function in the Installations Management (see next) or from a PC using the NetUpdate software (for more details refer to ["NetUpdate Connection" on page 190](#)).
- 4 Check measurement units (for more details refer to ["?Measurement Options" on page 42](#)).

### ► Operation

- 1 In "Monitoring type" box select "Signal Quality Monitoring".
- 2 In "Monitoring" dropdown menu, select an existing monitoring or create a new one by clicking "New".
- 3 If you create a new monitoring, a box will appear that allows you to select the channel plan that you want to monitor. Select the channel plan.
- 4 Next, the "Name" box appears. Write a name to identify the monitoring. In the "Description" box add additional information.
- 5 A list will appear with all channels in the channel plan. Alarms on each channel are available to be set.
- 6 To set an alarm from a channel, click on the cross icon next to channel. It drops down a list with all parameters available.
- 7 Each channel can be configured with this parameters:
  - Auto: The system automatically tunes the channel and takes measurements and reports an alarm when the user-defined condition is met.



- Manual: The system tunes the channel and waits during a time defined by user (in seconds). Then it takes measurements and reports an alarm when the user-defined condition is met.
  - Cycles: The system reports an alarm when the user-defined condition is met during a number of consecutive cycles defined by user. If this box is empty is equal to 1 cycle.
- 8** When the channel is deployed, the alarm configuration will appear:
- Status unlocked: This condition is always enabled and reports alarm when the channel is unlocked.
  - Parameter: Parameter to monitor.
  - OVER / UNDER: It indicates the condition to met in relation to the user-defined value.
  - Pre-alarm: Press on the switch and enter the value so when the condition is met it reports a pre-alarm. Value must be in decimal notation.
  - Alarm: Press on the switch and enter the value so when the condition is met it reports a pre-alarm. Value must be in decimal notation.
- 9** Configure each channel to be monitored.
- 10** When configuration is finished, press on "Save".
- 11** To start monitoring press on "Start Monitoring". Monitoring will start.
- 12** The active monitoring screen shows the measurements obtained and alarms and pre-alarms for the last cycle if there are any. Also it displays a bar graph with the measurements of the selected parameter. Under the bar graph it shows the monitoring channel, total monitoring time and cycle time. To select the parameter in the graph, select "Select Parameter". If you click on a channel, related information will appear.
- 13** Alarms are notified by sending e-mails to addresses from the e-mailing list. In order for the meter to send e-mails, the mail service must be configured in Preferences, SNMP tag (for more details refer to ["?SNMP Options" on page 45](#)).
- 14** To stop press on "Stop Monitoring" or cancel remote control on the meter.
- 15** Data obtained can be requested on "Historical Monitoring" screen.



## ► Screen Description

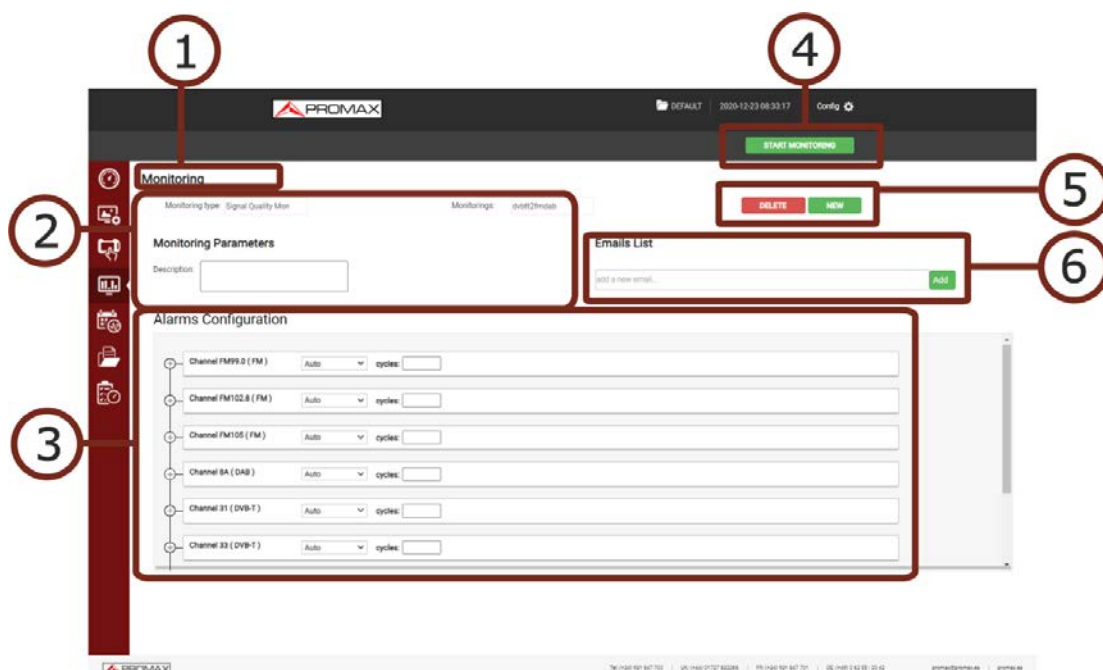

**Figure 110. Monitoring Edition / Creation**

- 1 Selected function (Monitoring).
- 2 Monitoring selection. On Monitoring type select "Signal Quality Monitoring". On "Monitorings" select one existing monitoring (previously, user must create a monitoring in order to show here). Below there is a text box to add a description to the monitoring.
- 3 Alarms configuration. It allows to select the Auto or Manual mode and cycles. If you click on the cross next to the channel, the available parameters of the channel will be displayed to set alarms. At the bottom there is the "Save" button to save all changes made.
- 4 When pressing on "Start Monitoring" it will start monitoring.
- 5 The "Delete" button deletes the selected monitoring and the button "New" creates a new monitoring.
- 6 It shows a list of e-mails. When an alarm is triggered, a notification is send to these e-mails. It allows you to add e-mails in the box "add a new email". To remove it press on the cross next to the e-mail. Parameters to set the e-mail server are in the meter's "Preferences" menu.





► Screen Description

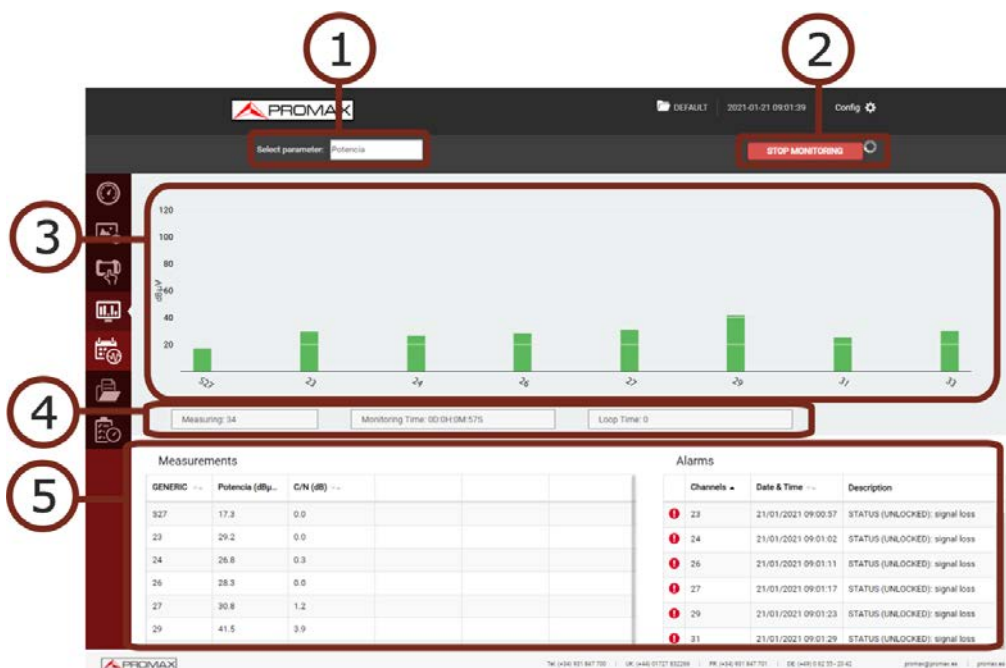

Figure 111. Monitoring started

- 1 Parameter selected shown on graphic bar.
- 2 Start / Stop monitoring.
- 3 Graphic bar of selected parameter. At the bottom the channel being measured. When pressing on a graphic bar channel it pops up a window with measurements. If there are too many channels to show on screen drag and drop to see the rest of them.
- 4 Current monitoring data: Monitoring channel, monitoring total time and cycle time.
- 5 Measurements and alarms window. Only shows alarms and measurements from the last cycle. On screen only appears the main measurements. When clicking on a channel it will show all measurements on that channel. Alarms table shows date and time of alarm and description. The icon indicates alarm. The icon indicates pre-alarm. Data is organized by type of signal and can be organised from lowest to highest or viceversa by pressing on the parameter at table heading.



## 9.6.2 Mask Monitoring\*

\*. This function is available only for meters with the "Mask Monitoring" option installed. Contact PROMAX for more information.

### ► Description

The Mask Monitoring function allows the user to save a spectrum in a specific frequency band and time. This spectrum will work as a reference or mask when comparing to other spectrum.

This function can be used to detect changes on broadcasts or when they appear or disappear.

The maximum number of records to store in the meter's internal database is 500.000. How long it takes to reach this number of records depends on different factors, especially the Time Period. Once this amount is exceeded, oldest records are overwritten. Data can be exported from the monitoring history to a CSV file.

### ► Settings

- 1 Check in "Preferences", date, time and time zone where the meter is located (for more details refer to ["?Time & Date Options" on page 41](#)) or synchronise time with a NTP server (for more details refer to ["?NTP Options" on page 45](#)).
- 2 In "Preferences", label "Utilities", option "Moni. ddbb loc." select where the monitoring data will be stored: internal memory or hard disk (for more details refer to ["?Tools Options" on page 42](#)).
- 3 Check measurement units (for more details refer to ["?Measurement Options" on page 42](#)).

### ► Operation

- 1 In "Monitoring type" box select "Mask Monitoring".
- 2 In "Monitoring" drop-down menu select an existing monitoring or create a new one by clicking "New".



- 3** When creating a new mask monitoring, fill in these fields:

  - *Name*: Name to identify your monitoring.
  - *Description*: Monitoring description.
  - *Units*: Measurement units (dBuV, ...).
  - *Time Period* (ms): It saves a spectrum each time period defined in this field.
  - *Num. Inputs*: The input number to be monitored.
  - *Input*: For each input fill in these fields:
    - *Name*: Name to identify this input.
    - *Detection Type*: Type of algorithm applied to detect differences between spectrum: FM (for FM signals); Max/Min (to detect differences between maximum and minimum values); % Deviation (percent deviation from spectrum outline). According to selected detection type, settings will be different.
  
- 4** Settings for alarms and to save spectrum:

  - **Alarm Thresholds**
    - **Min Threshold**: Signals that does not exceed this value will indicate that a station that had been previously detected has disappeared.
    - **Max Threshold**: Signals exceeding this value will be considered as an operating station.
    - **Reiteration**: Number of consecutive times that the threshold condition must be met to trigger the alarm.
  - **Spectrum**
    - **Start Freq**: Start frequency to monitor.
    - **End Freq**: End frequency to monitor.
    - **Reference Level**: It must be set to a proper level (according to the antenna) to avoid saturation or not viewing the signal.
    - **Average Count**: It allows the user to select the number of signal values to be used as average to establish the signal value that is displayed on the screen.
    - **Resolution Filter**: Bandwidth resolution filter.
    - **Video Filter**: It is the average of digital acquisitions of the signal. The lower this value, the faster the signal will be displayed but less clearly and vice versa.
  
- 5** Now press "*Acquire references*" to acquire a reference spectrum according to the settings.
  
- 6** After a few seconds the reference spectrum will appear. If the spectrum is not right, you can modify any parameter and press "*Acquire references*" again until you obtain a valid reference spectrum.
  
- 7** Once a proper reference spectrum has been obtained, save by pressing "*Save*".
  
- 8** Saved reference spectrum will appear on the box "*Mask Monitorings*".
  
- 9** To start a mask monitoring, select a reference spectrum in "*Mask Monitorings*", select an input and press "*Start Monitoring*" to start.



- 10 Monitoring screen shows measurements and alarms from the last cycle. When clicking on a channel it will show some additional info.
- 11 Alarms are notified by sending e-mails to addresses from the e-mailing list. In order for the meter to send e-mails, the mail service must be configured in Preferences, SNMP tag (for more details refer to ["?SMTP Options" on page 45](#)).
- 12 To stop press on "Stop Monitoring" or cancel remote control.
- 13 All saved data it is available on the "Historical Monitoring" screen.

### ► Mask Monitoring Screen Description (1/2)

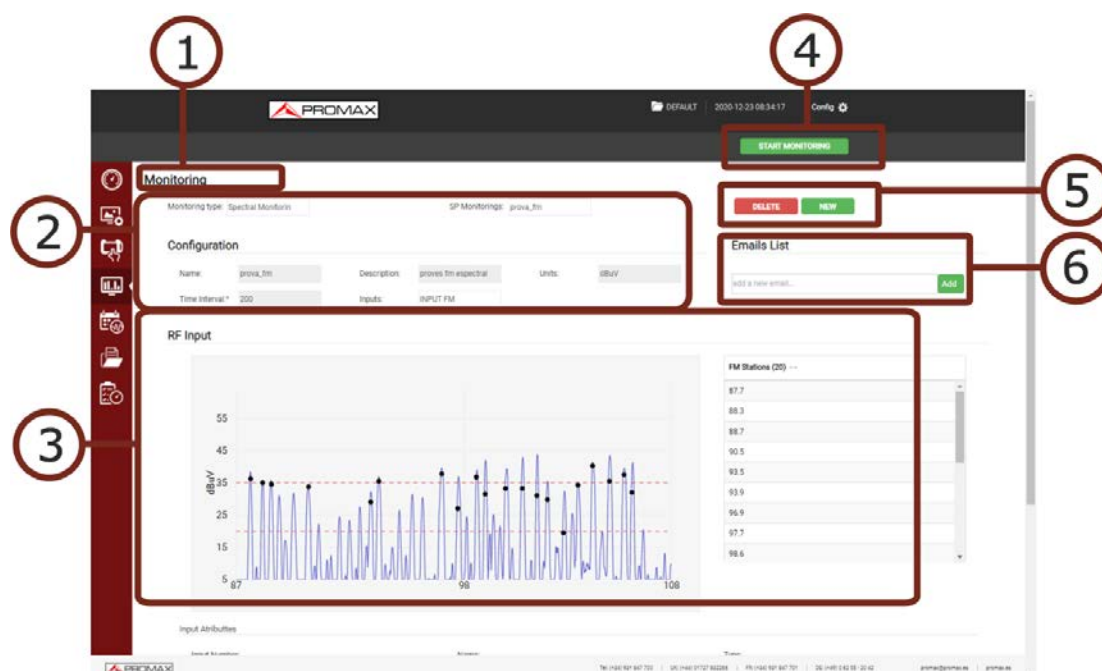

**Figure 112. Monitoring Creation / Edition**

- 1 Selected function (Monitoring).
- 2 Monitoring selection. In "Monitoring Type" select Mask Monitoring. In "Monitorings" box select monitoring to start (it must be a monitoring previously created in order to show here). Below there is a box with the monitoring description.
- 3 Reference spectrum and detected stations.
- 4 Start / Stop monitoring.
- 5 The "Delete" button deletes the selected monitoring and the button "New" creates a new monitoring.
- 6 It shows a list of e-mails. When an alarm is triggered, a notification is send to each one of these e-mails. It allows you to add e-mails in the box "add a



new email". To remove it press on the cross next to the e-mail. Parameters to set the e-mail server are in the meter's "Preferences" menu.

► Mask Monitoring Screen Description (2/2)

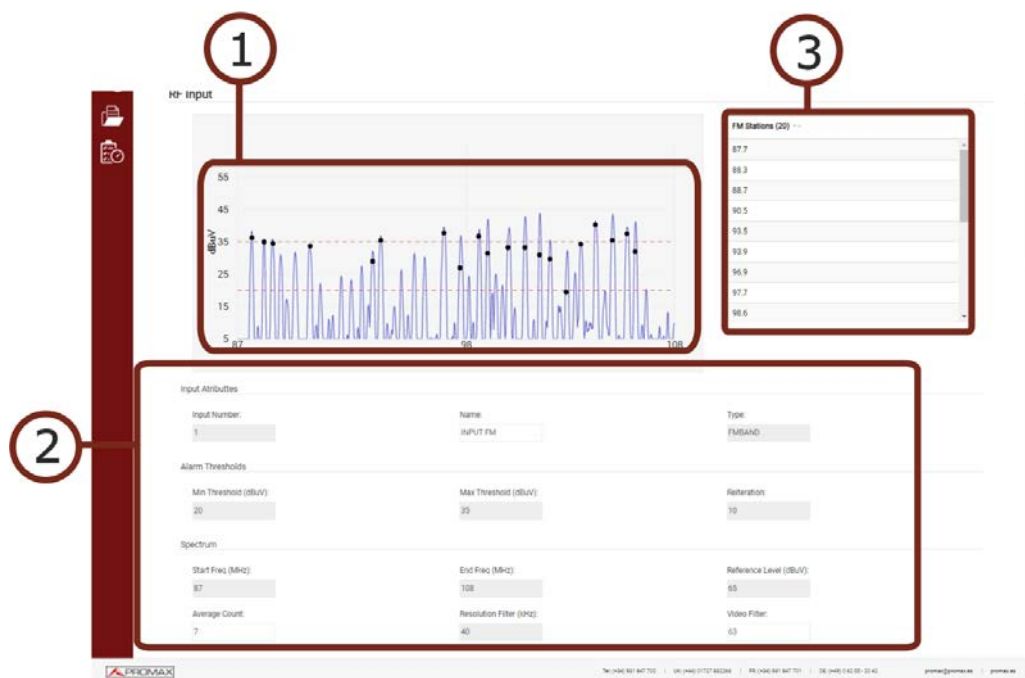

Figure 113. Mask Monitoring Creation / Edition

- 1 Reference Spectrum.
- 2 Settings parameters for reference spectrum.
- 3 Detected stations.



### ► Mask Monitoring in Operation Screen Description



**Figure 114. Mask Monitoring in Operation**

- 1 View Mode selection.
- 2 Start / Stop monitoring.
- 3 Monitoring parameters: Selected input, monitoring name, time period (ms) and time elapsed since monitoring start.
- 4 Spectrum at monitoring frequency band.
- 5 Alarm window. It shows alarm data from the last cycle with a description and date and hour when it was detected. Only shows active alarms. When the condition that trigger the alarm no longer met, then this alarm disappears in the next cycle, although it is stored in the database and can be consulted through the historical monitoring function.



## 9.7 Historical Monitoring

### ► Description

Historical Monitoring screen shows data obtained during monitoring. It stores all data about alarms, pre-alarms and system messages as memory problems, short-circuits, etc.

Historical monitoring can be consulted even if monitoring is working. It saves data for about 15 days. After this time data is overwritten.

To access this screen, click on the Historical Monitoring icon .

### 9.7.1 Historical Monitoring for Signal Quality

#### ► Operation

- 1 In "Monitoring type" box select "Signal Quality Monitoring".
- 2 In the "Monitoring" box select the monitoring from which you want to obtain data.
- 3 In the "Channels" box, select the channel from which you want to obtain data. For all channels select "All".
- 4 In the "Measurement" box select the parameter from which you want to obtain data. For all parameters select "All".
- 5 Select the start and end date and time for the monitoring data query. It must be the local date and time for meter.
- 6 Check the box "Measurements" or "Alarms" if you want to see the measurements, alarms or both.
- 7 Press "Done" and wait a few seconds to visualize data. Data for measurements is shown in the left column and for alarms in the right column.
- 8 To visualize data in graphic form press on label "Graph". This graph is displayed only if one single channel and one type of measurement is selected.
- 9 To export data to a CSV file, click on "Export to CSV".







measurements related to demodulation (MER, CBER...) will be empty. Measurement data keep units used when monitoring.

### 9.7.2 **Historial Monitoring for Mask Monitoring\***

\*. This function is available only for meters with the "Mask Monitoring" option installed. Contact PROMAX for more information.

#### ► **Operation**

- 1 In "Monitoring type" box select "Mask Monitoring".
- 2 In the "Mask Monitoring" box select the monitoring from which you want to obtain data.
- 3 In the "Inputs" box select the input from which you want to obtain data.
- 4 Select the start and end date and time for the monitoring data query. It must be the local date and time for meter.
- 5 Press "Done" and wait a few seconds to visualize data. All alarms triggered are shown on screen, with start and end date, channel and a description.
- 6 When clicking on start / end date on an alarm, it shows the spectrum graph when the alarm was triggered. When pressing on previous or next arrows you can see up to 50 graph spectrum previous and after to the alarm moment.
- 7 To export alarm data to a CSV file, press on "Export to CSV".



► Historical Mask Monitoring Screen Description

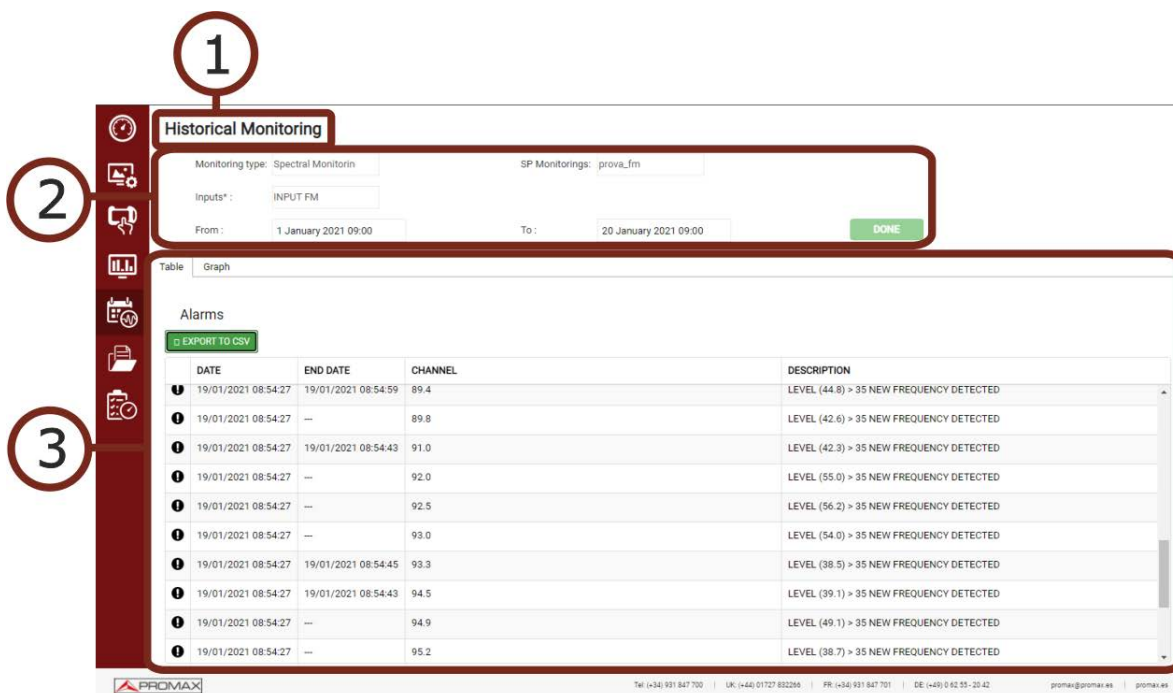

Figure 116. Data table from Historical Mask Monitoring

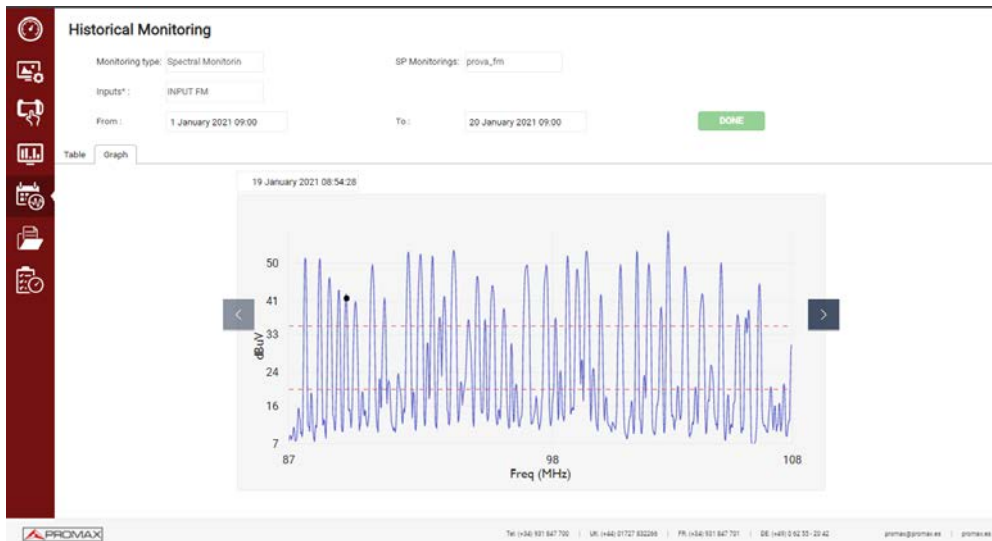

Figure 117. Mask Monitoring Spectrum Graph

1 Selected function (Historical Monitoring).



**2** Boxes to select query parameters from the historical data:

- Monitoring Type: Select “Mask Monitoring”.
- Monitoring: Select monitoring.
- Input: Select input.
- From / to : Select date range.
- Done: Press to run query.

**3** Data table / Data graph. Data table shows date start and data end for each alarm. When clicking on data and hour it shows the spectrum graph in that time moment (see figure). Measurement units are the same than the units selected when creating a monitoring.

## 9.8 Installations Management

### ► Description

Installations Management allows you to access the File Manager and the Create Channel Plan tool.

To access this screen, click on the Installations Management icon .

### 9.8.1 File Manager







This function allows you to manage files inside an installation (channel plans, screenshots, dataloggers, etc.).

### ► File Manager Operation









- 1** Press on tab “File Manager” to access the file manager. Wait for few seconds to system to read all files from the meter.
- 2** All installations are shown on the left side of the window. Each folder is for an installation. When clicking on a folder it deploys its content in a tree structure. The area on the right side shows the content inside the selected folder.
- 3** The padlock icon on an item means that it cannot be removed. If the padlock is on a folder it also means that its content cannot be change (nor deleted or added).
- 4** To make any action on an item use the tools bar or deploy the options menu by pressing the right button of the mouse. Next are described the most common options.







### ► Tools Bar:

-  Back: Back to the previous screen.
-  Forward: Back to the posterior screen.
-  Upload: It transfers a document from your PC to the meter. It shows a window where you can drag files, paste URLs or images or select files or folders from your PC.
-  Open: It opens a folder or downloads the selected file.
-  Download: It downloads a folder or file to your PC. When it is a folder or multiple files, it downloads a zipped file in TGZ format.
-  Delete: It deletes the folder or file selected.

### ► Options Menu (mouse right button):

-  Open: It opens a folder or downloads the selected file.
-  Download: It downloads a folder or file to your PC. When it is a folder or multiple files, it downloads a zipped file in TGZ format.
-  Preview: It shows file info.
-  Upload files: It transfers a document from your PC to the meter. It shows a window where you can drag files, paste URLs or images or select files or folders from your PC.
-  Delete: It deletes the folder or file selected.
-  Edit Channel Plan: It allows editing a channel of the equipment. It only works if a channel plan file (XML extension) is selected. The channel plan files are located in the CH folder (for more details see the next section).
-  Create Report: It generates a report in PDF format from the folder where the datalogger files are stored. To create a report, you must select the datalogger folder. These folders are inside the DATALOG folder.
-  Empty the folders: It removes all the content inside a folder.
-  Create archive: It creates a zip file from the files selected in TAR or GZIP format.



-  Extract files from archive: It unzips a zipped file in a new folder or in the current folder.
-  Select All: It selects all the files.
-  Invert selection: It reverts the current selection.
-  Get info: It shows some info about the selected file.

► **File and Installations Management Screen**

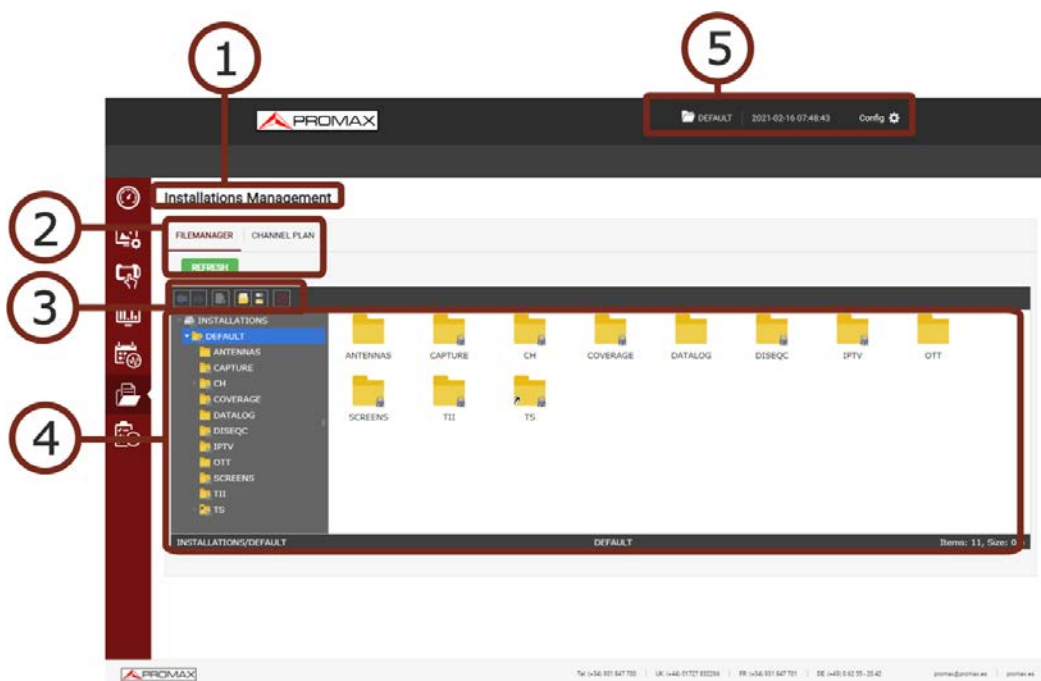

**Figure 118. File Manager**

- 1 Selected function (Installations Management).
- 2 Tabs to select the File Manager or the Channel Plan Creator.
- 3 Toolbar.
- 4 File navigation area.
- 5 Selected installation, current date and hour\* and access to settings:
  - Change Password: It allows you to change your password.
  - Reboot Equipment: It allows you to reset your meter after confirmation.

\*. In case you have the GPS option installed, then it also appears current geographic coordinates.



- About Equipment: It gives information about your meter: model name, serial number, release version / webControl version.
- Logout: It exits your current session.

## 9.8.2 Channel Plan Creator

This functions allows you to create a channel plan from scratch.

### ► Channel Plan Creator Operation

- 1 Press on the "Channel Plan" tab to access the channel plan creator. Press on "Create Channel Plan" button.
- 2 In the box "Name" enter the channel plan name. In the box "Band" enter the band (terrestrial or satellite). Next fill in the box "LNB" and "TV system". Parameters "Average Filter", "Video Filter", "Start Band Frequency" and "Stop Band Frequency" are specially indicated to use it for LTE signals.
- 3 Press the "Add Channel" button and enter one by one each channel that made the channel plan. Enter channel name, frequency and signal type for each channel.
- 4 Edit each parameter by clicking on it. Remove a channel clicking on the red cross.
- 5 Once finished press on "Download Channel Plan" to download it on your PC. By default the channel plan file is downloaded inside the folder "Downloads" in your PC. The file has XML format.
- 6 To use the new channel plan, upload it by means of the File Manager (see previous section). Get into the CH folder in your installation and select the folder TER or SAT according to terrestrial or satellite channel plan. The channel plan will be available for you.

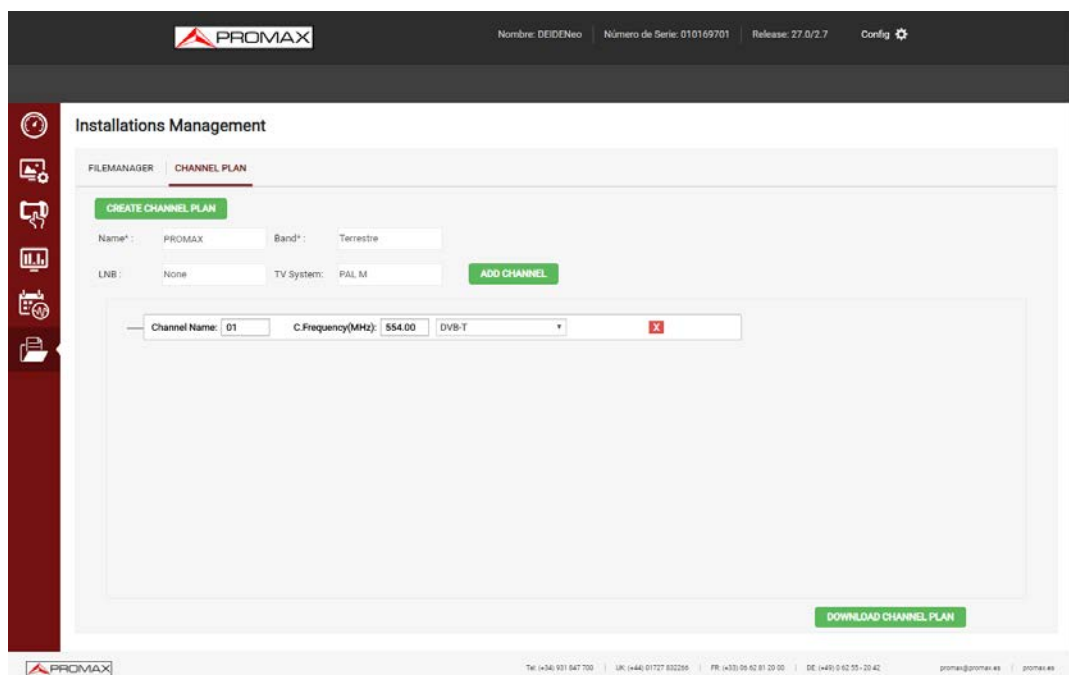

**Figure 119. Channel Creation**

### 9.8.3 Channel Plan Editor

This function allows you to edit channel plans.

#### ► Channel Plan Editor Operation

- 1 Files with channel plans are inside the "CH" folder. "SAT" sub-folder contains satellite channel plans, "TERR" sub-folder contains terrestrial channel plans and "AUX" contains other channel plans. Select the file that contains the channel plan to edit and press the right button on the mouse to select the "Edit channel plan" option.
- 2 The channel plan definition parameters and all the channels that form it will appear. From here you can edit any value by clicking on the box.
- 3 Channels can be modified by clicking on each parameter or deleted by pressing the red cross.
- 4 Once the channel plan is finished, click on "Download Channel Plan" to download it to the PC. By default the file with the channel plan is downloaded in the PC "Download" folder. The file is in XML format.
- 5 To use the channel plan on the meter use the File Manager to upload the XML file. It must be uploaded to the installation's CH folder and within the sub-folder TER, SAT or AUX depending on whether it is terrestrial, satellite or



auxiliary channel plan. The channel plan should now be available for use on the meter.

## 9.9 Task Management

### ► Description

The Task Management function allows you to configure a list of tasks and schedule when the task starts, the number of repetitions and other parameters. The meter can be turned off after configuring the tasks as it will automatically turn on to run the scheduled task.

From the meter itself, tasks can also be scheduled using the "Task Planner" tool, but the Task Management function from the webControl is more advanced and has more options.

When using the Task Management function from the webControl, the meter's Task Planner will be disabled. To use this tool again from the meter itself, all pending tasks must be deleted in Task Planner from the webControl.

To access this screen, click on the Task Management icon .

### ► Operation

**1** Press on "New Task".

**2** When creating a new task, fill in these fields:

- Task Type: Type of scheduled task. Options are:
  - Signal Quality Monitoring.
  - Mask Monitoring\*.
  - Datalogger (more details in ["Datalogger" on page 105](#)).
  - Capture (more details in ["Screen and Data Capture \(Export key\)" on page 113](#)).
- Type Configuration: It shows setting parameters according to selected task.
  - Signal Quality Monitoring: Selection of Quality Monitoring.
  - Mask Monitoring: Selection of Mask Monitoring.
  - Datalogger: Selection of Datalogger.
  - TS Record: Selection of channel and the complete transport stream or only one service.

---

\*. This function is available only for meters with the "Mask Monitoring" option installed. Contact PROMAX for more information.





- Capture: Selection of data capture, screenshot or both.
- Time Configuration: Date, time start and time end. If there is no finish date then check “Without expire date”.
- During: It allows you to select for how long run your task.
- Execute every: It allows you to select when to repeat your task.
- Repetition Type: It allows you to select time scale for repetition: hourly (minutes / hours repetition); weekly (week / day repetition); monthly (month / day repetition).

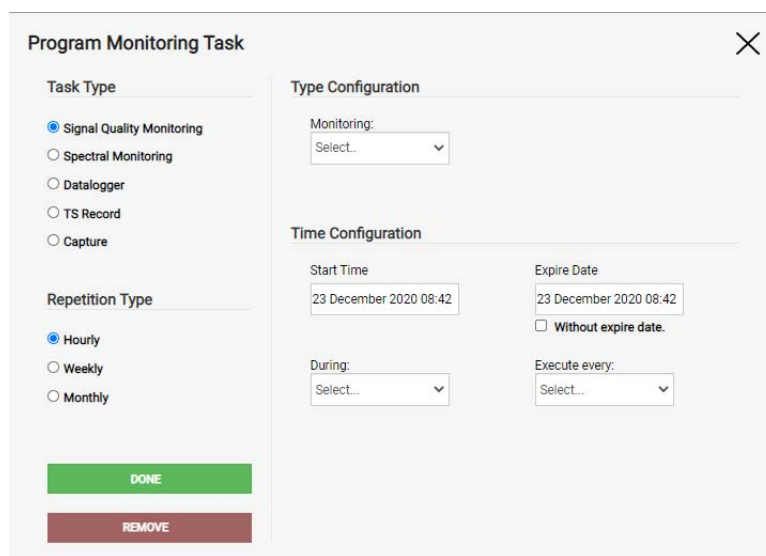

**Figura 120. Task Settings Screen**

- 3** Once the task has been set, press on “Done” to save it or “Remove” to remove it.
- 4** If one task tries to start when another task is running, the task will be cancelled on that repetition and will retry to run again on the next repetition if there is one.
- 5** To edit or view your task, click on the task list. To delete it, click on the trash can icon.
- 6** When the task reaches the end date, it is automatically remove from the task list.



## ► Task Management Screen Description

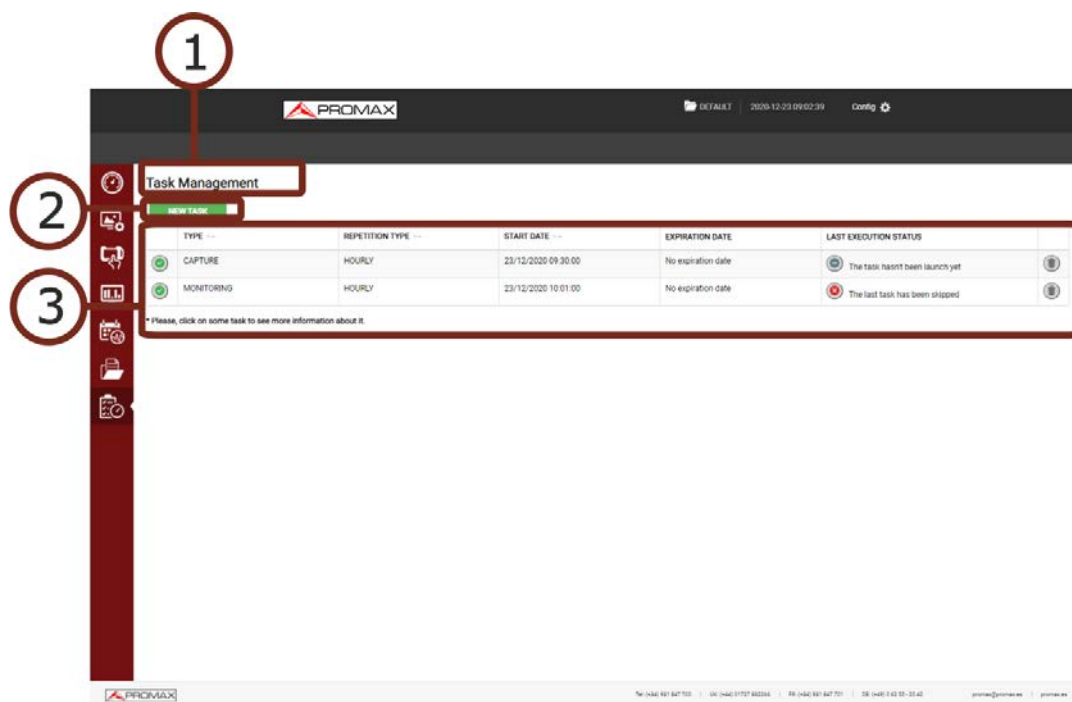

**Figura 121. Task Management**

- 1 Selected function (Task Management).
- 2 Button to set a new task.
- 3 Scheduled list task with info from each one: task type, repetition type, start date, expiration date and last execution status.



## 10 CONNECTING TO EXTERNAL DEVICES

### 10.1 Introduction

The meter can interact with external devices, sharing information through its interfaces. Connection types are:

- Input/output data via Ethernet port (IP CTRL).
- Input/output data via USB port.
- Video/Audio digital output via **HDMI** port.
- Video/Audio analogue input via **V/A** port.
- DiSEqC, SCD/EN50494 standard (also known as SatCR) and SCD2/EN50607 standard (also known as JESS) interface via **RF** connector.

Next is described each of these interfaces and their interaction with external devices.

### 10.2 USB Port

Devices that can connect the meter via USB port are:

- USB flash drive.
- USB WiFi adapter ("dongle").
- GPS signal receiver\*.

Both USB ports can be used for these devices.

#### 10.2.1 USB Flash Drive

This connection allows the user to copy files (screenshots, channel plans, dataloggers, DiSEqC commands and others) and export/import installations from the equipment to the USB and vice versa.





##### ► To copy some specific data from an installation

- 1 Connect the USB stick to the USB equipment port.



---

\*. available as an option for **RANGER Neo +**





- 2 USB icon should appear on the top right corner of the equipment. This icon indicates that an USB stick has been detected at the port.
- 3 Press the Installations key  and check the installation to download some of its data.
- 4 Press the key : Manage to access the data of the selected installation.
- 5 Press the key : Filter by type to select the type of list to view (list of all the files, only screenshots, only channel plans, only dataloggers or only DiSEqC commands).
- 6 Select the files from the list to be copied on the USB memory stick, by pressing the joystick or by pressing : File and selecting "Mark All" (it selects all files on the list displayed).
- 7 Once files are selected press : File and select the "Copy to USB" option. This option is enabled only if it detects that there is an USB connected to the equipment and if any file has been selected.
- 8 It shows a progress bar and a message informing that files are being copied to the USB.
- 9 When finish you can remove the USB stick memory directly from the equipment and connect it to a computer to view the files copied.
- 10 Default files are copied to the root directory of the USB memory. Screenshots appear with PNG extension and data with XML extension.

#### ► To export one or more complete installations

- 1 Connect the USB stick to the USB equipment port.
- 2 USB icon should appear on the top right corner of the equipment. This icon indicates that an USB stick has been detected at the port.
- 3 Press the Installations key  and check the installations to export.
- 4 Press the key : Tools and select Export to USB.
- 5 A progress bar and a message indicates that the files are being copied to the USB. The files are copied to the root directory of the USB in ZIP format.
- 6 When finish you can remove the USB stick memory directly from the equipment and connect it to a computer to view the files copied.
- 7 Unzip the installation file to access the data.



► **To import one installation**

- 1 Connect the USB stick to the USB equipment port.
- 2 USB icon should appear on the top right corner of the equipment. This icon indicates that an USB stick has been detected at the port.
- 3 Press the Installations key .
- 4 Press de key : Tools and select Import from USB.
- 5 A dropdown menu shows the installations identified in the USB memory. An installation can be imported if it has the same folder structure than when exporting. Select the installation to import from those available.
- 6 The import process starts. If the name of the installation matches with an existing one, it gives a warning before import.

## 10.2.2 **USB WiFi adapter (“dongle”)**

This connection is necessary for the use of the equipment as a WiFi meter (see [“WIFI MONITORING” on page 137](#) for more details) or to connect to a WiFi access point and use the meter remotely with the webControl tool (see [“WEBCONTROL” on page 156](#)).

## 10.2.3 **GPS Signal Receiver\***

\*. available as an option for **RANGER Neo +**

The GPS Signal Receiver is needed for the “Signal Coverage” tool. This tool takes measurements linked to a geographic position determined by the GPS receiver. Later on, all this data, measurements and GPS position can be downloaded to a PC and exported to a file for later analysis (see [“SIGNAL COVERAGE OPTION” on page 231](#) for more details).

## 10.3 **Ethernet Port**

► **Description**

This connection allows the communication between the meter and a device via an Ethernet cable using the IP CTRL port.

To communicate to the meter you can use any software to send remote control commands (such as hyperterminal or PuTTY) or the NetUpdate or webControl\*



software by PROMAX (for more details about webControl refer to ["WEBCONTROL" on page 156](#)).

### ► Meter Settings

- 1 From the meter access Preferences by pressing "Installations" key  for 1 second.
- 2 Go to "Network" where the parameters to login into a network are.
- 3 Select DHCP ON, if you connect the meter to a network with a router or server with DHCP protocol enabled. Then the network will set automatically the parameters in the meter. If not, follow the next steps to set the meter.
- 4 On "IP Address" box enter the meter IP. Use an IP in the same range used by the local network (if you do not know these data see "local network data"). For instance, if the IP for your PC is 10.0.1.18, the meter should have a free IP in the same range, like 10.0.1.50.
- 5 In the "Mask" box, enter the mask value, which should be the same as the one used by the local network (usually 255.255.255.0).
- 6 To connect the meter from an external network, fill in the "Gateway" with the info obtained from the local network.
- 7 Press on "Save" and then "Exit" to save changes and exit.

### ► Find out Local Network Data

- 1 To obtain data from the Ethernet network where your meter is connected, you should use a PC connected to this same network.
- 2 From the PC click on Start menu in Windows. On the Search box write CMD and press Enter.
- 3 It opens a command line in a window. Write IPCONFIG and press enter.
- 4 It displays a window with some lines with info. On line "Local Network Ethernet Adapter" see line "IPv4 Address". This is the local IP for your PC. Write down this IP. Also write down "Subnet Mask" and "Default Gateway". This data is needed to configure the meter by hand.

---

\*. only available for RANGER *Neo* +



## 10.3.1 NetUpdate Connection

### ► Description

The NetUpdate software is available for free on the download page at the [PROMAX website](#).

NetUpdate has the following functions:

- Update the firmware of the meter.
- Open/Receive/Save/Print data files captured with the Datalogger function.
- Transmit/Receive/Edit/Save channel plans.
- Create/Edit channel plans.

For more information about the NetUpdate program, see the user's manual, which is available on the [PROMAX website](#).



[Click here to watch this video: Creation of a channel plan](#)



[Click here to watch this video: Generating a measurement report](#)

### ► Operation

- 1 Install the NetUpdate program on the PC. All permissions requested during the installation must be approved for a correct operation of the program.
- 2 Switch off the meter. Use an Ethernet cable to connect the meter's IPCTRL port to a switch or to the PC's ethernet port. Switch on the meter.
- 3 Open the NetUpdate program. In the "Select Port" box select "Ethernet" option and press "Detect".
- 4 A window will appear where you must enter the same IP that you have set in the meter (in our example it would be 10.0.1.50) and then press OK.
- 5 If connection is successful, a confirmation window will appear and you will be able to see the meter data in the main NetUpdate window (for details



about NetUpdate program, download the manual from the PROMAX website).

## 10.3.2 Remote Control Command Connection

### ► Description

The design of this meter is based on a microprocessor which allows data to be exchanged between the meter and a remote controller (usually a personal computer). By this way, data can be obtained from the equipment and also control it remotely.

This protocol is controlled by software using a virtual serial port over an Ethernet port. Data and information are exchanged using messages consisting of ASCII alphanumerical characters. This method ensures easy carrying between different types of personal computers.

### ► Operation

- 1 Install a remote communication program to send commands, such as PuTTY or Hyperterminal.
- 2 Use an Ethernet cable to connect the meter's IPCTRL port to the PC's ethernet port.
- 3 Run the communication remote program. It should appear a window to enter the meter's IP (in our example it would be 10.0.1.8).
- 4 The meter's communication port is 2222. Enter this number in the box "port" at the remote communication program.
- 5 Select connection type: Telnet and press OK.
- 6 It should appear a window with a command line where you can write and send remote control commands (for more details refer to "Remote Control Commands" on PROMAX website).

## 10.4 HDMI Port

HDMI (High-Definition Multimedia Interface) is a compact audio/video interface for transmitting uncompressed digital data. HDMI supports, on a single cable, any TV or PC video format, including standard, enhanced, and high-definition video; up to 8 channels of digital audio.







This connection allows the equipment to interface with other High Definition equipment. It can also be very useful to check proper operation of the client's TV while on a service call. Everything that can be seen on the meter's screen is available through the HDMI.

This connection allows you to switch between the image from the meter to an auxiliary monitor by following these steps:

- 1 Connect the HDMI cable to the video/audio output connector, ensuring that the plug is fully inserted.
- 2 Connect the opposite end to the auxiliary monitor where video and audio of the equipment will be played.

## 10.5 Input Jack Connector

The V/A input connector allows connecting a video/audio analogue input signal. This connection allows the user to view an image on the meter screen coming from an external source by following these steps:

- 1 Connect the supplied jack 4V cable to the video/audio input connector, ensuring that the plug is fully inserted.
- 2 Connect the opposite end (RCA connector) to the source of video/audio.
- 3 Switch on the meter and select terrestrial band and analogue signal.
- 4 Select TV mode  and press key : Input.
- 5 From the menu, select "External". A message shows that the external input has been selected.
- 6 After a few seconds, the input image will be displayed on screen.
- 7 With the option : Aspect, you can select the aspect ratio of the image, between 4:3 and 16:9.



**NOTE:** If the equipment is displaying an external analogue video, it will not switch to internal video mode anymore when that external video is disconnected or lost.





## 10.6 RF Connector

### 10.6.1 DiSEqC Commands

The RF connector allows controlling an antenna using DiSEqC commands. DiSEqC (Digital Satellite Equipment Control) is a communication protocol between the satellite receiver and the installation accessories of satellite (switches, LNBS, etc.) proposed by Eutelsat, in order to standardize the diversity of switching protocols (13 to 18 V, 22 kHz) and meet the needs of the installations for the reception of digital TV.

- 1 Connect the RF cable to the RF connector for the input signal of the equipment.
- 2 Press the **Spectrum** key  to access the spectrum analyzer mode.
- 3 Press the **Settings** key  and select the satellite band.
- 4 From the **Settings** menu, select the polarization (horizontal/vertical) and the satellite band (high/low).
- 5 If necessary, enable the **Supply output** and select the supply voltage for the LNB.

**NOTE:** When tuning by channel is selected, polarization, satellite band and supply output cannot be changed, because these parameters are determined by the channel plan.



- 6 Select the option **DiSEqC mode**.
- 7 Two new functions appear on the softkeys: Command  and Software . DiSEqC programs appear classified in categories or folders.
- 8 Select the command or program and press the joystick to send it to the antenna. These commands or programs allow the user to control an antenna (for more information about DiSEqC commands and programs download document from [PROMAX website](http://PROMAX website)).

### 10.6.2 SCD / EN50494 (SatCR) Commands

By means of function SCD/EN50494 (international standard, also known as SatCR) it is possible to control the devices of a TV satellite installation that are compatible with this standard, which allows to concentrate downlink frequencies



(slots) by an only cable. By this way each user using a slot can tune and decode any signal present in the satellite.

- 1 Connect the RF cable to the RF connector for the input signal of the equipment.
- 2 Press the **Spectrum** key  to access the Spectrum analyzer mode.
- 3 Press the **Settings** key  and select the satellite band.
- 4 Select the polarization (horizontal/vertical) and the satellite band (high/low).
- 5 If necessary, enable the **Supply output** and select the supply voltage for the LNB.

**NOTE:** When tuning by channel is selected, polarization, satellite band and supply output cannot be changed, because these parameters are determined by the channel plan.

- 6 In the option SCD/EN50494, select ON to enable it. It appears the  icon at the top right corner.
- 7 Also in the SCD/EN50494 option, select **Configuration** to access SCD/EN50494 parameters.

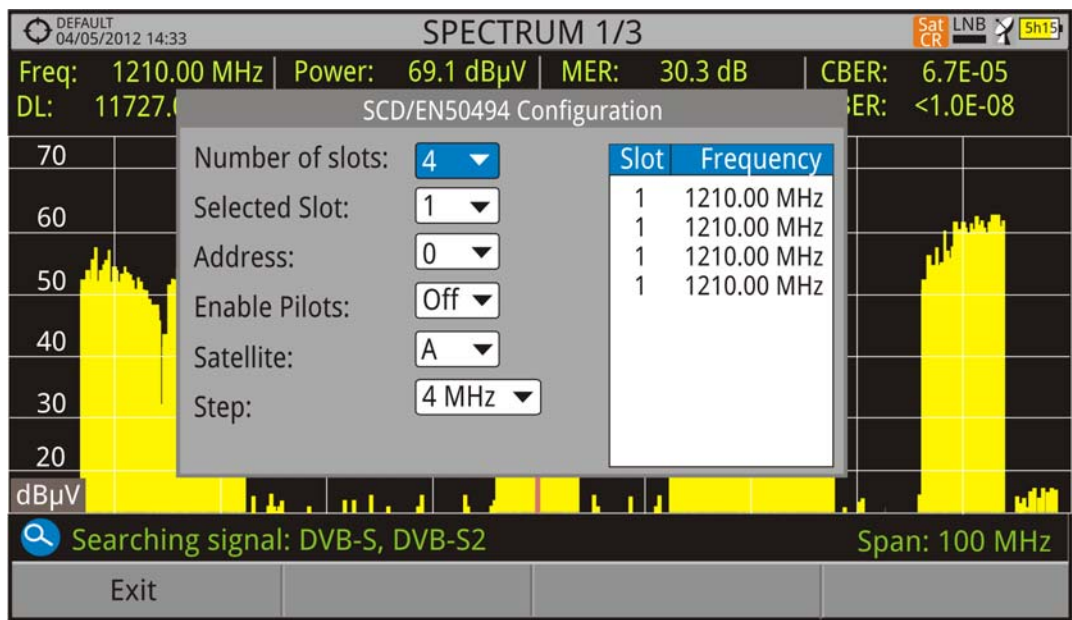

**Figura 122.**

The configuration window shows the options that user can modify: number of slots, slot selected, device address, pilot signal activation (when activating the SatCR device located in the headend, it emits a pilot signal with constant level for each downlink frequency to identificate available channels), selected satellite and frequency step. For each type of slot number unit there is a list of



independent frequencies to select. The user may have separate frequencies for 2, 4 or 8 slots units and these values are not lost when switching from one type to another.

- 8 Once SCD/EN50494 is configured, the user can select the slot by the "Tuning" key.

### 10.6.3 SCD2 / EN50607 (JESS) Commands

Through the SCD2/EN50607 (international standard, also known as JESS) function is possible to control the devices of a TV satellite installation that are compatible with this standard. This technology has two main functionalities: one for configuring headends, and another for configuring sockets. This technology requires bidirectional DiSEqC capabilities.

Thanks to its bidirectional DiSEqC capabilities, the meter can automatically read the configuration from any SCD2/EN50607 compatible unit connected to it. In case that no compatible device is detected, the meter allows the user to make a blind configuration of the unit without any confirmation other than spectrum reference.

For information about JESS technology, developed by JULTEC, refer to its website (<http://jultec.de/>).

- 1 Connect the RF cable to the RF connector for the input signal of the equipment.
- 2 Press the Spectrum key to access the spectrum analyzer mode.
- 3 Press the Settings key and select the satellite band. From the Settings menu, select the polarization (horizontal/vertical) and the satellite band (high/low).
- 4 If necessary, enable the Supply output and select the supply voltage for the LNB.

**NOTE:** When tuning by channel is selected, polarization, satellite band and supply output cannot be changed, because these parameters are determined by the channel plan.

- 5 In the option SCD2/EN50607, select ON to enable it. It appears the JESS icon at the top right corner of the screen.
- 6 Now the SCD2/EN50607 option shows a new menu. Select Configuration to access the configuration parameters. The user can select the power, central frequency, tone beacon and satellite for each band. The user can also select the number of user bands and the available satellites through the option "Configuration" on key **F2**.



INSTAL55 05/09/2014 12:45 SCD2/EN50607 CONFIGURATION JESS 13V 3h08

| UB   | Power    | Central Frequency | Tone Beacon | Satellite |
|------|----------|-------------------|-------------|-----------|
| UB_1 | Enabled  | 1076 MHz          | Off         | A         |
| UB_2 | Disabled | 1178 MHz          | Off         | A         |
| UB_3 | Disabled | 1280 MHz          | Off         | A         |
| UB_4 | Disabled | 1382 MHz          | Off         | A         |
| UB_5 | Disabled | 1484 MHz          | Off         | A         |
| UB_6 | Disabled | 1586 MHz          | Off         | A         |
| UB_7 | Disabled | 1688 MHz          | Off         | A         |
| UB_8 | Disabled | 1790 MHz          | Off         | A         |

Exit Configuration Send

**Figura 123.**

- 7 Also from option SCD2/EN50607, select Socket to access the configuration of socket. The user can select the user bands that should be enabled for the socket and to send them to configure the socket.

INSTAL55 05/09/2014 12:46 JESS 13V 3h07

Freq 1076.00 MHz Power: <33.9 dBμV MER: ----- dB CBER: -----  
 DI: 11258.00 MHz C/N: <0.5 dB VRFR: -----

SCD2/EN50607 SOCKET

Please select the User Bands that should be enabled for this socket. Then, press 'Send' to configure the socket

UB\_1  UB\_2  UB\_3  UB\_4  UB\_5  UB\_6  UB\_7  UB\_8  
 UB\_9  UB\_10  UB\_11  UB\_12  UB\_13  UB\_14  UB\_15  UB\_16  
 UB\_17  UB\_18  UB\_19  UB\_20  UB\_21  UB\_22  UB\_23  UB\_24  
 UB\_25  UB\_26  UB\_27  UB\_28  UB\_29  UB\_30  UB\_31  UB\_32

Searching signal: DSS, DVB-S, DVB-S2 Span: 100 MHz

Exit Send Mark All Unmark All

**Figura 124.**

- 8 Once it is configured, the user, through the key "Tuning" can select the user band.



- 9 User frequency tuned is stored for each User band (UB) and it is restored each time the multiswitch is being configured.

**NOTE:** When not detecting any SCD2 receiver, the function enters in a more basic mode, allowing sending configuration commands even with nothing connected. In that mode, the user can debug cable issues or even SCD2 units problems.

**NOTE:** For special devices that use non-standard commands, it has been added a channel bandwidth for every user band.



## 11 SPECIFICATIONS RANGER *Neo* Lite / + \*

### 11.1 General

#### ► Inputs and Outputs

| Parameter                           | Value                  | Additional Data  |
|-------------------------------------|------------------------|--|
| <b>RF Input</b>                     |                        |  |
| Input Connector                     | F male                 | 75 $\Omega$  |
| Maximum Signal                      | 130 dB $\mu$ V         |  |
| Maximum Input Voltage               | 50 V rms               | DC a 100 Hz; powered by the AL-103 power charger   |
|                                     | 30 V rms               | DC a 100 Hz; not powered by the AL-103 power charger   |
|                                     | 140 dB $\mu$ V         | Protected up to 30 seconds   |
| <b>Analogue Video Input</b>         |                        |  |
| Input Connector                     | Multipole Jack         | Zin=75 $\Omega$  |
| Sensibility                         | 1 Vpp                  | 75 $\Omega$ ; positive video   |
| <b>Analogue Audio Input</b>         |                        |  |
| Input Connector                     | Multipole Jack         | Zin=10k; same V/A input multipole jack   |
| <b>Digital Video / Audio Output</b> |                        |  |
| Output Connector                    | HDMI                   | 1080p Resolution   |
| <b>USB Interface 2.0</b>            |                        |  |
| Connector                           | USB type A             |  |
| Features                            | Mass Storage Host      | Can read and write on a pendrive USB CDC   |
|                                     | USB CDC                | CDC: Communication device class  |
| <b>IP Interface (control IP)</b>    |                        |  |
| Connector                           | RJ45                   | Labeled IP CTRL  |
| Type                                | Ethernet 10 / 100 Mbps | Ethernet connection is designed to work through a switch. We do not guarantee direct connection through a cable.                   |
| Communication Software              | webControl             | Functions: Measurement and spectrum, TV parameters, remote console, monitoring, historical monitoring and installation management. |
|                                     | Netupdate              | Functions: Installation management and firmware update.  |
| IP by default                       | 10.8.8.188             | 10.0.6.198 for firmware versions prior to 26.8   |

\*. These specifications are for models RANGER *Neo* Lite and RANGER *Neo* +. When a specification is for a specific model it is explained between brackets.



| Parameter   | Value  | Additional Data   |
|---|--|---|
| <b>WiFi Interface</b>                                       |  |   |
| Type  | Wireless standard 802.11 abgn                | Dongle-Wifi connected to USB port<br>Dongle must be validated by PROMAX |
| <b>Monitor Display</b>                                      |  |   |
| Monitor   | 7" TFT touch panel                           | Transmissive colour dot matrix type                                     |
| Aspect Ratio  | 16:9   |   |
| Format  | 800 x 480 dots                               | (R,G,B)(W) x (H)  |
| Brightness  | 300 cd/m <sup>2</sup>                        |   |
| <b>External Unit Power (through the RF input connector)</b> |  |   |
| Terrestrial Supply  | External                                     |   |
|   | 5 V  | Up to 500 mA  |
|   | 12 V   | Up to 500 mA  |
|   | 24 V   | Up to 250 mA  |
| Satellite Supply  | External                                     | Up to 500 mA  |
|   | 5 V  | Up to 500 mA  |
|   | 13 V   | Up to 500 mA  |
|   | 15 V   | Up to 500 mA  |
|   | 18 V   | Up to 500 mA  |
| 22 kHz Signal Voltage                                       | 0.65 V ± 0.25 V                              | Selectable in Satellite band  |
| 22 kHz Signal Frequency                                     | 22 kHz ± 4 kHz                               | Selectable in Satellite band  |
| DiSEqC Generator  | DiSEqC 2.2 (DiSEqC 1.2 commands implemented) | DiSEqC is a trademark of EUTELSAT                                       |
| SATCR / SCD (EN50494)                                       | Available                                    | DiSEqC 1.2  |
| dCSS / SCD2 (EN50607)                                       | Available                                    | Compatible with LNB SKY UK<br>According DiSEqC 2.x                      |

### ► Mechanical Features

| Parameter  | Value                 | Additional Data           |
|------------|-----------------------|---------------------------|
| Dimensions | 290x185x65 mm         | (W) x (H) x (D)           |
| Weight     | 1.6 kg                | Without installed options |
| Size       | 3,487 cm <sup>3</sup> |                           |

### ► Power Supply

| Parameter  | Value                          | Additional Data                        |
|--|--------------------------------|--|
| Internal Battery (for RANGER <i>Neo Lite</i> )       | 7.2 V; 6.6 Ah                  | Li-Ion battery                         |
| Internal Battery (for RANGER <i>Neo +</i> )          | 7.2 V; 13 Ah                   | Li-Ion Intelligent battery             |
| Battery Operation Time (for RANGER <i>Neo Lite</i> ) | > 2.5 hours in continuous mode | No EXTERNAL supply active              |
| Battery Operation Time (for RANGER <i>Neo +</i> )    | > 5 hours in continuous mode   | No EXTERNAL supply active              |
| Recharging time                                      | 3 hours up to 80%              | With meter off                         |
| External Voltage                                     | 12 V DC                        | Only using PROMAX supplied accessories |





| Parameter      | Value        | Additional Data  |
|----------------|--------------|--|
| Consumption    | 40 W         |  |
| Auto Power Off | Programmable | After the selected amount of minutes without operating on any control (disabled by user) |

### ► Operating Environmental Conditions

| Parameter              | Value              | Additional Data                                     |
|------------------------|--------------------|---|
| Altitude               | Up to 2000 m       |   |
| Temperature Range      | From 5 °C to 45 °C | Automatic disconnection by excess of temperature    |
| Max. Relative Humidity | 80%                | Up to 31°C; decreasing lineally up to 50% at 40 °C. |

**NOTE:** Equipment specifications are set in these environmental operating conditions. Operation outside these specifications is also possible. Please check with us if you have specific requirements.

### ► Included Accessories

| Parameter                              | Value                                 | Additional Data |
|--|---------------------------------------|-----------------|
| 1x O MT0170                            | Antenna Dual WiFi                     |                 |
| 1x O MF0213                            | USB WiFi adapter                      |                 |
| 1x OMF0214                             | USB cable                             |                 |
| 1x O CO6861                            | Aero SMA-H/BNC-M adapter              |                 |
| 1x CC-046                              | Jack 4V/RCA cable                     |                 |
| 1x AA-103                              | Car lighter charger                   |                 |
| 1x AL-103                              | External DC charger                   |                 |
| 1x AD-055                              | "F"/f-BNC/f adapter                   |                 |
| 1x AD-056                              | "F"/f-"DIN"/f adapter                 |                 |
| 1x AD-057                              | "F"/f-"F"/f adapter                   |                 |
| 1x CA-005                              | Mains cord                            |                 |
| 1x CB-086 (for RANGER <i>Neo</i> Lite) | Rechargeable Li+ battery 7,2 V 6.6 Ah | Built-in        |
| 1x CB-084 (for RANGER <i>Neo</i> +)    | Rechargeable Li+ battery 7,2 V 13 Ah  | Built-in        |
| 1x DC-300                              | Transport belt                        |                 |
| 1x DC-301                              | Carrying bag                          |                 |
| 1x DC-230 (for RANGER <i>Neo</i> +)    | Transport suitcase                    |                 |
| 1x DG0249 (for RANGER <i>Neo</i> Lite) | Quick Reference Guide                 |                 |
| 1x DG0251 (for RANGER <i>Neo</i> +)    | Quick Reference Guide                 |                 |
| 1x MN-001                              | Monopod                               |                 |

**NOTE:** It is recommended to keep all the packing material in order to return the equipment, if necessary, to the Technical Service.



## 11.2 Measurement Mode

### ► DVB-T

| Parameter                   | Value  | Additional Data   |
|-----------------------------|--|---|
| Modulation                  | COFDM  |   |
| Margin of power Measurement | 35 dBμV - 115 dBμV                           | 786 MHz, 8k, GI=1/4<br>64 QAM, CR=2/3<br>Sensitivity (QEF): 29 dBμV           |
| Measurement                 | Power, CBER, VBER, MER, C/N and Link Margin  | VBER measurement can go down to <1E-10; CBER measurement can go down to <1E-7 |
| Displayed Data              | Numeric and level bar                        |   |
| Carriers                    | 2k, 8k                                       |   |
| Guard Interval              | 1/4, 1/8, 1/16, 1/32                         |   |
| Code Rate                   | 1/2, 2/3, 3/4, 5/6, 7/8                      |   |
| Constellation               | QPSK, 16-QAM, 64-QAM                         |   |
| Bandwidth                   | 6, 7 and 8 MHz                               |   |
| Spectral inversion          | ON, OFF                                      | Auto  |
| Hierarchy                   | Indicates hierarchy mode                     |   |
| Cell ID                     | Detected from transmitter station            |   |
| TPS signalling              | Time slicing, symbol interleaver and MPE-FEC |   |
| Tuning Range                | 45 - 1000 MHz                                |   |

### ► DVB-T2

| Parameter                   | Value   | Additional Data  |
|-----------------------------|---|--|
| Profiles                    | T2-Base, T2-Lite  |  |
| Modulation                  | COFDM   |  |
| Margin of Power Measurement | 35 dBμV - 115 dBμV  | 786 MHz, 32k, GI=1/32<br>256 QAM Rotated, CR=3/5<br>Sensitivity (QEF): 30 dBμV |
| Measurement                 | Power, CBER, C/N, LBER, MER, Link Margin, BCH ESR, LDP Iterations and wrong packets | LBER measurement under 1E-10   |
| Displayed Data              | Numeric and level bar   |  |
| Carriers                    | 1k, 2k, 4k, 8k, 8k+ EXT, 16k, 16k+ EXT, 32k, 32k+ EXT                               |  |
| Guard Interval              | 1/4, 19/256, 1/8, 19/128, 1/16, 1/32, 1/128   |  |
| Bandwidth                   | 5, 6, 7 and 8 MHz   |  |
| Spectral Inversion          | ON, OFF   | Auto   |
| Pilot Pattern               | PP1 - PP8   |  |
| PLP Code Rate               | 1/2, 3/5, 2/3, 3/4, 4/5, 5/6  |  |
| PLP Constellation           | QPSK, 16QAM, 64QAM, 256QAM  |  |
| PLP Constellation Rotation  | ON, OFF   | Auto   |
| PLP ID                      | 0 - 256   |  |
| Cell ID                     | Detected from transmitter station   |  |
| Network ID                  | Detected from transmitter station   |  |
| T2 System ID                | Detected from transmitter station   |  |



| Parameter    | Value         | Additional Data |
|--------------|---------------|-----------------|
| Tuning Range | 45 – 1000 MHz |                 |

► DVB-C

| Parameter                                      | Value                                | Additional Data  |
|--|--------------------------------------|--|
| Modulation                                     | QAM                                  |  |
| Margin of Power Measurement                    | 45 - 115 dB $\mu$ V                  | 786 MHz<br>16 QAM Sensitivity (QEF): 30 dB $\mu$ V<br>32 QAM Sensitivity (QEF): 33 dB $\mu$ V<br>64 QAM Sensitivity (QEF): 36 dB $\mu$ V<br>128 QAM Sensitivity (QEF): 39 dB $\mu$ V<br>256 QAM Sensitivity (QEF): 42 dB $\mu$ V |
| Measurements                                   | Power, BER, MER, C/N and Link Margin |  |
| Displayed Data                                 | Numeric and level bar                |  |
| Demodulation                                   | 16/32/64/128/256 QAM                 |  |
| Symbol Rate                                    | 1000 - 7100 kbauds                   |  |
| Roll-off ( $\alpha$ ) factor of Nyquist filter | 0.15                                 |  |
| Spectral Inversion                             | ON, OFF                              | Auto   |
| Tuning Range                                   | 45 – 1000 MHz                        |  |

► DVB-C2

| Parameter                   | Value  | Additional Data   |
|-----------------------------|--|---|
| Modulation                  | QAM  |   |
| Margin of Power Measurement | 45 - 115 dB $\mu$ V  | 786 MHz, 32k, GI=1/128<br>1024 QAM Rotated, CR=9/10<br>Sensitivity (QEF): 48 dB $\mu$ V |
| Measurements                | Power, CBER, MER, C/N, LBER, BCH ESR, LDP Iterations and wrong packets |   |
| Displayed Data              | Numeric and level bar  |   |
| Carriers                    | 4k   |   |
| Guard Interval              | 1/64, 1/128  |   |
| Bandwidth                   | 6, 8 MHz   |   |
| Spectral Inversion          | ON, OFF  | Auto  |
| Pilot Pattern               | PP1 - PP8  |   |
| Code Rate PLP               | 2/3, 3/4, 4/5, 5/6, 8/9, 9/10  |   |
| PLP Constellation           | 64 QAM, 256 QAM, 1k QAM, 4K QAM  |   |
| Dslice PLP                  | 0 - 256  | Auto  |
| PLP ID                      | 0 - 256  |   |
| Cell ID                     | Detected from transmitter station                                      |   |
| Network ID                  | Detected from transmitter station                                      |   |
| C2 System ID                | Detected from transmitter station                                      |   |
| Tuning Range                | 45 – 1000 MHz  |   |

► Analogue TV

| Parameter          | Value                                   | Additional Data |
|--------------------|---|-----------------|
| Colour System      | PAL, SECAM and NTSC                     |                 |
| Standard Supported | M, N, B, G, I, D, K and L               |                 |
| Sensibility        | 40 dB $\mu$ V for a correct synchronism |                 |



► FM/RDS

| Parameter          | Value               | Additional Data         |
|--------------------|---------------------|-------------------------|
| Tuning range       | 45 - 1000 MHz       |                         |
| Tuning step size   | 10 kHz              |                         |
| Sensitivity        | 5 dB $\mu$ V        | 150 MHz (S+N/N = 40 dB) |
| Selectivity (mono) | $\pm$ 200 kHz 25 dB |                         |

► DVB-S

| Parameter                                      | Value                                 | Additional Data  |
|--|---------------------------------------|--|
| Modulation                                     | QPSK                                  |  |
| Margin of Power Measurement                    | 35 dB $\mu$ V - 115 dB $\mu$ V        | 2150 MHz, 27500 kSps, CR=2/3<br>Sensitivity (QEF): 29 dB $\mu$ V<br>18 dB $\mu$ V a 2.15 GHz / 2 MSs;<br>30 dB $\mu$ V a 2.15 GHz / 27 MSs;<br>33 dB $\mu$ V a 2.15 GHz / 45 MSs |
| Measurements                                   | Power, CBER, MER, C/N and Link Margin |  |
| Displayed Data                                 | Numeric and level bar                 |  |
| Symbol Rate                                    | 1 - 45 Mbauds                         |  |
| Roll-off ( $\alpha$ ) factor of Nyquist filter | 0.35                                  | Auto   |
| Code rate                                      | 1/2, 2/3, 3/4, 5/6, 7/8               |  |
| Spectral Inversion                             | ON, OFF                               |  |
| Tuning Range                                   | 250 – 2350 MHz                        | From 2150 to 2350 MHz does not meet sensitivity specifications   |

► DVB-S2

| Parameter                                      | Value   | Additional Data   |
|--|---|---|
| Modulation                                     | QPSK, 8PSK, 16APSK, 32APSK  |   |
| Margin of Power Measurement                    | 35 dB $\mu$ V - 115 dB $\mu$ V                                      | 2150 MHz, 27500 kSps, CR=2/3<br>Roll-off: 0,20<br><br>QPSK Sensitivity (QEF): 26 dB $\mu$ V<br>8PSK Sensitivity (QEF): 30 dB $\mu$ V<br><br>8PSK:<br>24 dB $\mu$ V a 2.15 GHz / 2 MSs;<br>34 dB $\mu$ V a 2.15 GHz / 27 MSs |
| Measurements                                   | Power, CBER, LBER, MER, C/N, BCH ESR, Wrong Packets and Link Margin |   |
| Displayed Data                                 | Numeric and level bar   |   |
| Symbol Rate                                    | 2 - 45 MSps   | QPSK, 8PSK, 16APSK, 32APSK  |
| Roll-off ( $\alpha$ ) factor of Nyquist filter | 0.20, 0.25 and 0.35   |   |
| Code rate (8PSK)                               | 1/2, 3/5, 2/3, 3/4, 4/5, 5/6, 8/9, 9/10                             |   |
| Code rate (QPSK)                               | 3/5, 2/3, 3/4, 5/6, 8/9, 9/10                                       |   |
| Code rate (16APSK)                             | 2/3, 3/4, 4/5, 5/6, 8/9, 9/10                                       |   |
| Code rate (32APSK)                             | 3/4, 4/5, 5/6, 8/9, 9/10  |   |
| Spectral Inversion                             | ON, OFF   | Auto  |
| Pilots   | Indicator   |   |



| Parameter    | Value          | Additional Data  |
|--------------|----------------|--|
| TS clock     | Available      | Warning message when the TS clock is too high                  |
| Tuning Range | 250 – 2350 MHz | From 2150 to 2350 MHz does not meet sensitivity specifications |

► DSS

| Parameter                                      | Value  | Additional Data  |
|--|--|--|
| Modulation                                     | QPSK   |  |
| Margin of Power Measurement                    | 35 dB $\mu$ V - 115 dB $\mu$ V               |  |
| Measurements                                   | Power, CBER, VBER, MER, C/N and Noise Margin |  |
| Displayed Data                                 | Numeric and level bar                        |  |
| Symbol Rate                                    | 20 Mbauds or variable                        | Auto detected  |
| Roll-off ( $\alpha$ ) factor of Nyquist filter | 0.2  |  |
| Code rate                                      | 1/2, 2/3, 6/7 and AUTO                       |  |
| Spectral Inversion                             | ON, OFF                                      | Auto   |
| Tuning Range                                   | 250 - 2350 MHz                               | From 2150 to 2350 MHz does not meet sensitivity specifications |

► DCII (DigiCipher 2)

| Parameter | Value                    | Additional Data                  |
|-----------|--------------------------|----------------------------------|
| DCII      | It plays video and audio | It does not show additional info |

## 11.3 Spectrum Analyzer Mode

► Digital Signal

| Parameter   | Value                          | Additional Data   |
|---|--------------------------------|---|
| <b>General Parameters</b>                               |                                |   |
| Markers   | 1                              | It displays frequency, level indication, level difference, frequency difference |
| Reference Level   | 60 dB $\mu$ V - 135 dB $\mu$ V | Adjustable in steps of 5 dB   |
| Spectrum Range  |                                | Span, dynamic range and reference level are variable by means of arrow cursors  |
| <b>Terrestrial</b>                                      |                                |   |
| Tuning range  | 5 - 1000 MHz                   | Continuous tuning from 5 to 1000 MHz  |
| Tuning mode   | Channel or frequency           | Channel plan configurable; tune step 50 kHz                                     |
| Tuning Accuracy   | $\pm$ 1163 kHz                 |   |
| Tuning Resolution                                       | 10 kHz                         |   |
| Resolution Bandwidth (RBW) (for RANGER <i>Neo</i> Lite) | 100 kHz                        |   |
| Resolution Bandwidth (RBW) (for RANGER <i>Neo</i> +)    | 100, 200, 1000 kHz             |   |



| Parameter  | Value                              | Additional Data                             |
|--|------------------------------------|---|
| Measurement Range                                | 20 dBµV - 130 dBµV                 | 3.16 µV a 3.16 V                            |
| Span (min-max)                                   | 10 MHz - 995 MHz                   | for RBW = 100 / 200 / 1000 kHz              |
| Digital channels measures                        | Channel power, C/N, MER, BER, LM   | According to modulation type                |
| <b>Satellite</b>                                 |                                    |   |
| Tuning range                                     | 250 - 2500 MHz                     |   |
| Tuning mode                                      | Intermediate frequency or downlink | Channel plan configurable; tune step 50 kHz |
| Tuning accuracy                                  | ± 2.6 kHz                          |   |
| Tuning Resolution                                | 10 kHz                             |   |
| Resolution Bandwidth (RBW) (for RANGER Neo Lite) | 100 kHz                            |   |
| Resolution Bandwidth (RBW) (for RANGER Neo +)    | 100, 200, 1000 kHz                 |   |
| Measurement range                                | 31 - 130 dBµV                      | 35.5 µV - 3.16 V                            |
| Span (min-max)                                   | 10 MHz - 2250 MHz                  | for RBW = 100 / 200 / 1000 kHz              |
| Digital Channel Measurements                     | Channel Power, C/N, MER, BER, LM   | According to modulation type                |

► Analogue Signal

| Parameter                      | Value  | Additional Data   |
|--------------------------------|--|---|
| <b>General Parameter</b>       |  |   |
| Attenuation scale              | Auto-range   |   |
| Numerical indication           | Absolute value according to selected units   |   |
| Graphical indication           | Analogue bar on screen   |   |
| Audible indicator              | Pitch sound  | Tone with pitch proportional to signal strength                 |
| <b>Terrestrial</b>             |  |   |
| Tuning Range                   | 5 - 1000 MHz   |   |
| Tuning Mode                    | Manual   |   |
| Tuning Resolution              | 10 kHz   |   |
| Measurement Range              | 15 dBµV - 130 dBµV   | 3.16 µV - 3.16 V  |
| Analogue channels measures     | Level, C/N, V/A  |   |
| Accuracy                       | ±1,5 dB  | 20 dBµV - 130 dBµV @ 990 MHz<br>10 µV - 3.16 V<br>23 °C ± 5 °C  |
| Out of range indication        | <, >   |   |
| <b>Satellite</b>               |  |   |
| Tuning Range                   | 250 - 2500 MHz   |   |
| Tuning Mode                    | Intermediate frequency or downlink   | Channel plan configurable                                       |
| Tuning Resolution              | 10 kHz   |   |
| Measurement Range              | 15 dBµV (250 – 1800 MHz)<br>20 dBµV (1800 – 2300 MHz)<br>24 dBµV (2300 – 2500 MHz) | 31.6 µV - 3.16 V  |
| Analogue channels measurements | Level, C/N   |   |
| Accuracy                       | ±1,5 dB  | 20 dBµV - 130 dBµV @ 2490 MHz<br>10 µV - 3.16 V<br>23 °C ± 5 °C |



| Parameter               | Value | Additional Data |
|-------------------------|-------|-----------------|
| Out of range indication | <, >  |                 |



## 11.4 TV Mode

### ► Video

| Parameter              | Value                           | Additional Data   |
|------------------------|---------------------------------|---|
| Codecs                 | MPEG-1                          |   |
|                        | MPEG-2                          | MP@HL (Main profile high level)                                     |
|                        | MPEG-4 AVC H.264                | High Profile Level 4.1; ; maximum bitrate 40 Mbps                   |
|                        | H.265 L4.1                      | Maximum bitrate according to specifications b HEVC High Profile 4.1 |
| Maximum Image Size     | 1920x1080x60p; 1280x720x60p/50p |   |
| Minimum Image Size     | 352x240x30p; 352x288x25p        |   |
| Bitrate                | 40 Mbps                         |   |
| Aspect Ratio           | 16/9; 4/3                       |   |
| SI/PSI Data            | Service list and main PIDs      |   |
| HD Video Resolution    | 1080, 720 and 576               | Progressive or interlaced   |
| HDMI Output Resolution | 1080p                           |   |

### ► Audio

| Parameter        | Value  | Additional Data   |
|------------------|--|-------------------|
| Codecs           | MPEG-1   |                   |
|                  | MPEG-2   |                   |
|                  | HE-AAC   |                   |
|                  | Dolby Digital and Dolby Digital +                        |                   |
| Demodulation     | According to the TV standard                             |                   |
| De-emphasis      | 50 $\mu$ s   | 75 $\mu$ s (NTSC) |
| Sound subcarrier | Digital frequency synthesis according to the TV standard |                   |

### ► Transport Stream

| Parameter              | Value  | Additional Data     |
|------------------------|--|---------------------|
| Communication Protocol | MPEG-2   |                     |
| Packets                | 188 or 204 bytes   | Automatic detection |
| Video Info             | Type, bitrate, format, aspect ratio, frequency, profile, PID |                     |
| Service Info           | Network, provider, NID, ONID, scrambled/free, TSID, SID, LCN |                     |
| Audio Info             | Type, bitrate, format, frequency, mono/stereo, language, PID |                     |

## 11.5 WiFi Analyzer Mode 2.4 GHz

| Parameter         | Value     | Additional Data |
|-------------------|-----------|-----------------|
| Band              | 2.40 GHz  |                 |
| Resolution Filter | 100 kHz   |                 |
| Reference Level   | Available |                 |





| Parameter           | Value                              | Additional Data          |
|---------------------|------------------------------------|--------------------------|
| RSSI                | Available (dBm)                    | Depending on WiFi dongle |
| SNR                 | Available (dB)                     |                          |
| Maximum Power       | +15 dBm                            | Measured over spectrum   |
| Average Power       | +15 dBm                            | Measured over spectrum   |
| Bandwidth           | Access Point Bandwidth             |                          |
| Access Point Number | Access Point number in the same BW |                          |

## 11.6 Tools

### ► Constellation

| Parameter      | Value   | Additional Data |
|----------------|---|-----------------|
| Type of Signal | DVB-T, DVB-T2, DVB-C, DVB-C2, DSS, DVB-S and DVB-S2 |                 |
| Displayed Data | I-Q Graph   |                 |

### ► Echoes

| Parameter         | Value   | Additional Data                            |
|-------------------|---|--|
| Type of Signal    | DVB-T, DVB-T2, DVB-C2                               |  |
| Measurement range | Depends on the standard, carrier and guard interval |  |
| Delay             | 0.1 - 224 us  | Typical configuration (DVB-T 8K, GI = 1/4) |
| Distance          | 0.3 - 67,2 km                                       | Typical configuration (DVB-T 8K, GI = 1/4) |
| Power Range       | 0 dBc - -30 dBc                                     | Typical configuration (DVB-T 8K, GI = 1/4) |
| Time scale        | 1/3 Symbol Period                                   |  |

### ► LTE Ingress Test

| Parameter      | Value  | Additional Data |
|----------------|--|-----------------|
| Type of signal | DVB-T, DVB-T2, DVB-C, DVB-C2                               |                 |
| Displayed Data | LTE band plus quality parameters for a selected TV channel |                 |

### ► Atenuación Test

| Parameter        | Value               | Additional Data |
|------------------|---------------------|-----------------|
| Test Frequencies | 3 selectable pilots |                 |



### ► Datalogger

| Parameter   | Value   | Additional Data  |
|-------------|---|--|
| Stored Data | Signal type, modulation parameters, all measures available for the detected signal type, and time stamp, PSI info for each measured channel | If GPS is connected to USB port, the equipment stamps GPS coordinates in each measurement made. For DVB-T2 signals it saves information from all PLPs. In case of Satellite signal it also saves polarization. |
| Timestamp   | Date and time at each measured channel  |  |

### ► Shoulders Attenuation\*

| Parameter | Value | Additional Data |
|-----------|-------|-----------------|
| TBD       | TBD   | TBD             |

## 11.7 Options\*

\*. expansion options only available for **RANGER *Neo* +**

### ► Fibre Optics

| Parameter  | Value   | Additional Data                               |
|--|---|---|
| Descriptive Code                                       | OP-001-PS   | It includes WiFi 5G, 2.6 GHz LTE and RF 6 GHz |
| <b>Selective Optical Power Meter</b>                   |   |   |
| Optical Measure bands                                  | 1310 nm ± 50 nm; 1490 nm ± 10 nm; 1550 nm ± 15 nm |   |
| Connector  | FC/APC  |   |
| Measurement Dynamic Range                              | - 49.9 dBm - +10 dBm                              | Accuracy ± 0,5 dB                             |
| Isolation between bands                                | > 45 dB   |   |
| <b>Optical to RF Converter</b>                         |   |   |
| Dynamic range of conversion                            | -5 dBm - +10 dBm                                  |   |
| RF Attenuation   | ON = 15 dB; OFF = 0 dB                            |   |
| RF band converted (Optical Cable and DTT links)        | 65 MHz - 1000 MHz                                 |   |
| RF band converted (Optical IF-Satellite Installations) | 950 MHz - 5450 MHz                                | for universal optical LNB                     |
| RF Output  | 65 MHz - 2150 MHz                                 |   |
| <b>6 GHz RF Auxiliary Input</b>                        |   |   |
| Connector  | SMA   |   |
| Frequency Bands  | Sub-Band 1: 2150 MHz - 3000 MHz                   |   |
|  | Sub-Band 2: 3400 MHz - 4400 MHz                   |   |
|  | Sub-Band 3: 4400 MHz - 6000 MHz                   |   |

\*. only available for **RANGER *Neo* +**



| Parameter                 | Value                        | Additional Data   |
|---------------------------|------------------------------|---|
| Dynamic Range             | 45 -105 dB $\mu$ V           | ATT OFF   |
|                           | 60 - 120 dB $\mu$ V          | ATT ON  |
| Span (min-max)            | 1 MHz - 250 MHz              | for RBW = 10 kHz  |
|                           | 2 MHz - 450 MHz              | for RBW = 20 / 30 / 40 kHz  |
|                           | 10 MHz - 1600 MHz            | for RBW = 100 / 200 / 1000 kHz (the maximum span might be smaller depending on the sub-band selected by the user. This value corresponds to the sub-band 3) |
| Conversion Gain           | 7 dB                         |   |
|                           | -8 dB                        |   |
| Flatness                  | $\pm$ 5 dB                   |   |
| Spurious                  | < 45 dB $\mu$ V              | (-65 dBm); typical value  |
| Inter-modulation Products | <15 dB                       | typical value   |
| Maximum Input Signal      | RF: 120 dB $\mu$ V; DC: 50 V |   |

#### ► WiFi 5G Analyzer and LTE 2.6 GHz

| Parameter        | Value     | Additional Data |
|------------------|-----------|-----------------|
| Descriptive Code | OP-001-WL |                 |
| TBD              | TBD       | TBD             |

#### ► DAB / DAB+

| Parameter              | Value               | Additional Data |
|------------------------|---------------------|-----------------|
| Descriptive Code       | OP-001-DAB          |                 |
| Combined Antenna Input | for Band III        |                 |
| DAB sensitivity        | up to 22 dB $\mu$ V | Typical Value   |
| Decodes Audio Services | up to 384 kbit/s    |                 |

#### ► Signal Coverage

| Parameter        | Value      | Additional Data |
|------------------|------------|-----------------|
| Descriptive Code | OP-001-GPS |                 |
| TBD              | TBD        | TBD             |



## 12 MAINTENANCE

### 12.1 Instructions for Returning by Mail

Instruments returned for repair or calibration, either within or out of the warranty period, should be sent with the following information: Name of the Company, name of the contact person, address, telephone number, receipt (in the case of coverage under warranty) and a description of the problem or the service required.

### 12.2 Considerations about the Screen

This paragraph offers key considerations regarding the use of the colour screen, taken from the specifications of the manufacturer.

In the TFT display, the user may find pixels that do not light up or pixels that are permanently lit. This should not be regarded as a defect in the TFT. In accordance with the manufacturer quality standard, 9 pixels with these characteristics are considered admissible.

Pixels which are not detected when the distance from the surface of the TFT screen to the human eye is greater than 35 cm, with a viewing angle of 90° between the eye and the screen should not be considered manufacturing defects either.

It is advisable a viewing angle of 15° in the 6.00 o'clock direction in order to obtain the optimum visualization of the screen.

### 12.3 Cleaning Recommendations

The equipment consists of a plastic case and a TFT screen. Each element has its specific cleaning treatment.

#### ► Cleaning the Screen

The TFT screen surface is VERY DELICATE. It has to be cleaned with a soft fabric cloth (cotton or silk), always making the same move from left to right and from top to bottom, without putting pressure on the screen.

The TFT screen has to be dry-cleaned or with a product specifically designed for TFT screens, by slightly dampening the cloth. NEVER use tap or mineral water, alcohol or conventional cleaning products, because they contain components that can damage the screen.

Turn off the equipment to locate dirt on the screen. After cleaning, wait a few seconds before turning on.



### ► **Cleaning the Plastic Case**

The equipment has to be disconnected before cleaning the case.

The case must be cleaned with a solution of neutral soap and water, using a soft cloth dampened with this solution.

Before use, the equipment has to be completely dry.

Never clean with abrasive soaps, chlorinated solvents or aromatic hydrocarbons. These products may degrade the case.



## i OPTICAL OPTION\*

### i.1 Description

This annex contains operating instructions for the next option:

- OP-001-PS.

This option expands the meter with these functions:

- Selective Optical Power Meter
- Selective Optical to RF Converter
- RF 6 GHz Input
- WiFi 5 GHz
- LTE 2,6 GHz

The evolution of the telecommunications market, more and more demanding in quality standards, speed, services and so on and also economical and competitiveness factors has changed the trend in telecommunications installations, and increasingly, fibre-optics is being imposed on traditional ADSL twisted-pair copper lines.

For this reason and in anticipation of an increase of fibre-optics installations, this option has been developed. It is applicable to the field strength meter and allows adapting it in order to work with fibre-optics networks.

The selective meter option allows measurements on optical fibre networks, which are necessary to certify an installation according to the parameters set by local policies.

The optical to RF selective converter has a photosensor for each wavelength, which obtains the RF signal carried by each one. With this module, user can measure terrestrial or cable (up to 1 GHz) networks or optical LNB for satellite antennas (up to 5.45 GHz), so that the installer does not need any additional equipment to measure this type of installations.

The 6 GHz auxiliary RF input option can be used among other applications to directly connect optical LNBs with 5.4 GHz output.

The 5 GHz WiFi option extends the WiFi Analyzer to the second frequency range used for WiFi.

---

\*. only available for **RANGER *Neo* +**



The 2.6 GHz LTE option expands the spectrum analyzer to the band 7 of LTE. Band 7 is defined by an uplink band between 2.5 and 2.57 GHz and a downlink band between 2.62 and 2.69 GHz. Band 7 of LTE is one of the most used globally since it allows to transmit with greater speed but at a shorter distance and is more exposed to suffer interference.

This expansion module is available for any unit (both for new equipment or to upgrade equipment owned).

## **i.2 Selective Optical Power Meter**

### **i.2.1 Description**

The selective meter consists, in first place, of a selective triple filter for 1310, 1490 and 1550 nm signals. The filter separates each wavelength and each one leads to an independent circuit with a photosensor, which obtains the RF signal that it carries. Next, a circuit measures the optical signal power received by the photosensor. The RF signal obtained for each wavelength goes to a band switch.

The band switch receives a signal and converts it to a frequency within the RF band (65 – 2150 MHz). In the case of a terrestrial/cable signal the signal is not converted since that signal is within the RF range.

After the conversion, the RF signal output is connected to the analyzer input connector and the measurement is performed in the usual way to an RF signal. In the conversion, bear in mind that for every unit of optical attenuation (one dB), occurs two dBs of power loss in RF. As an example, every 3 dB of optical attenuation for each splitter are equivalent to 6 dB of power loss for RF.

### **i.2.2 Optical Fibre Test**

#### **► Description**

The optical function of this module allows the user to certify a telecommunication installation by calibrating the signals at the installation and then measuring them in each of the user access points.

The optical module can measure simultaneously and in a selective way the three wavelengths used in optical fibre (1310, 1490 and 1550 nm). It has a selective receiver with a filter for each band that makes a real and very stable measurement of each wavelength. With this feature, user will be able to certify any installation according to the telecommunications infrastructure policies.



## ► Operation

To access the Fibre Optical Test tool:

- 1 Connect the **optical input** signal to the optical input of the equipment.
- 2 Press the **Tools** key .
- 3 Select the **Fibre Optic Test** option.
- 4 It appears the screen to perform the **Fibre Optic Test** on the signal.

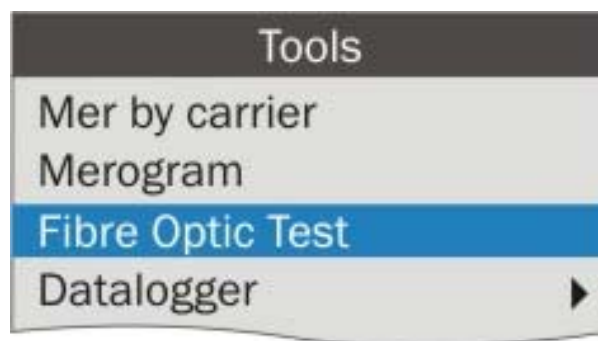

Figure 125.





► Screen Description

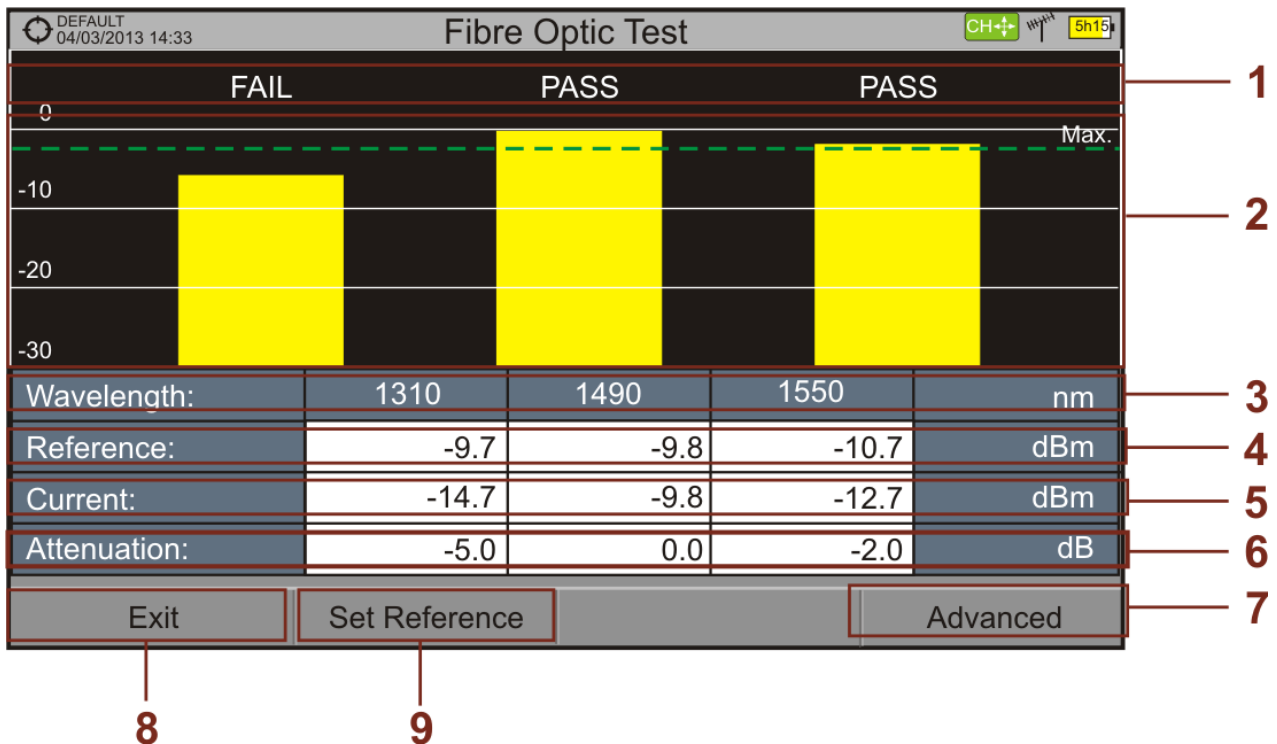





Figure 126.

- 1 Status message depending on the level of attenuation.
- 2 Power level of signal.
- 3 Wavelength of signal (nm).
- 4 Power level of reference signal, which is used to calibrate and calculate the attenuation level (dBm).
- 5 Power level of test signal at the user's access point (dBm).
- 6 Attenuation level (dB); Attenuation = Current - Reference.
- 7 "Advanced" key to access these options: Threshold attenuation and Max. attenuation (see Max. dashed line).
- 8 "Exit" button to exit the screen.
- 9 "Set Reference" key to calibrate the reference signal.



### ► Menu Options

On the bottom of the screen there are three menus accessible via function keys.

-  F1 It exits the tool.
-  F2 When pressing this key it uses the current values of power as a reference values.
-  F4 It accesses the Advanced menu.

In the **Advanced** menu there are two parameters to configure the fibre optical test. They are:

- **Threshold Attenuation:** It defines the maximum difference that can exist between the reference signal with the highest power level and the reference signal with the lowest power level. Any signal out of this range will be deleted and not used as a reference signal during the measurement process.
- **Max. Attenuation:** It defines the attenuation level used by the field meter to display the status message on screen. If the attenuation level is below this value the status message will be "**PASS**" and if it is above this value the status message will be "**FAIL**".

### i.2.3 **Practical Example: How to Certify a Fibre Optic Installation**

Next there is a step by step example to certify a telecommunication installation of optical fibre by using the optical module.

To make the required certification it is necessary:

- Field Strength Meter with optical module.
- A signal generator of the three wavelengths used in fibre optical installations in order to calibrate and measure (PROLITE-105).
- A pigtail with a **FC** to **SC** adapter.

#### ► Stage 1. Capturing reference measurements

- 1 Connect the **SC** pigtail end connector to the **PROLITE-105** output connector.



- 2 Connect the **FC** end of the pigtail to the optical input of the meter (see figure below).
- 3 Turn on the PROLITE-105 and the meter.
- 4 Press **F3** key to access the **Tools** menu.
- 5 Select the **Fibre Optic Test** option and press the joystick.
- 6 In the **PROLITE-105**, press once the **SEQ**  key to select the **SIMULTANEOUS** mode. This mode simultaneously sends three wavelengths signals.
- 7 In the meter, press the **F2** key Set Reference. All current values are captured, which will be used as reference values.
- 8 Now, user can proceed to **Stage 2** in order to measure the attenuation at each user's access point.



Figure 127.

### ► Stage 2. Attenuation Test Measurement

- 1 Connect the **PROLITE-105** in a source node of the transmission optical network, for example in a free strip of the main telecommunications cabinet of the building.



- 2 Keep the **PROLITE-105** in simultaneous mode for generating signals, so it **SIMULTANEOUSLY** generates all three wavelengths (1310 nm, 1490 nm and 1550 nm).
- 3 Connect the field strength meter to a receiving node of the optical network that is going to be measured, such as for example in a UAP (User Access Point).
- 4 Using the field strength meter, check measurements on the **Fibre Optic Test** screen.

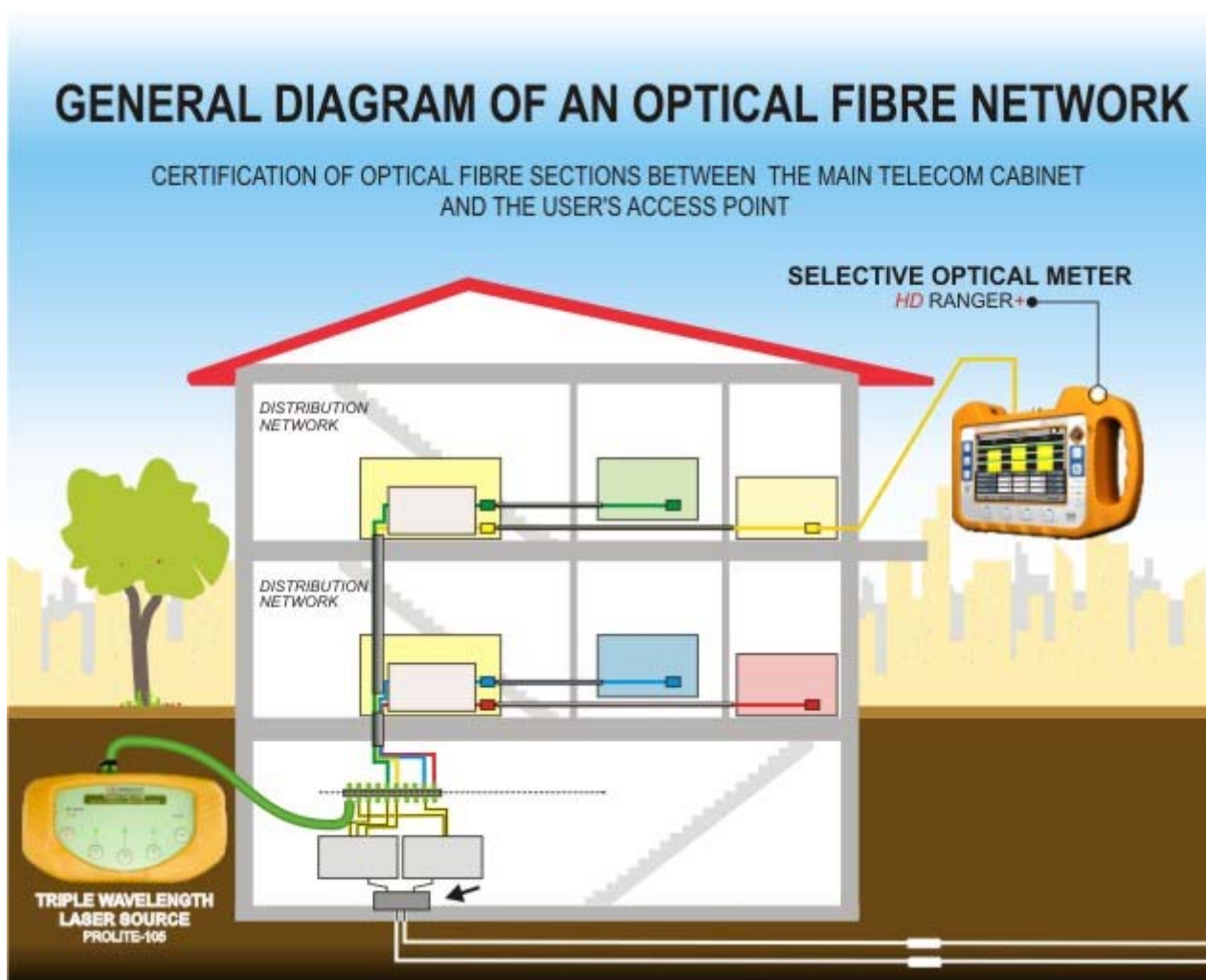

Figure 128.



**i.3 Selective Optical to RF Converter**

**► Description**

The selective optical to RF converter has a filter that separates each wavelength and directs it to an independent circuit with a photosensor, which obtains the RF signal that carries. The RF signal obtained for each wavelength passes to a band switch.

The band switch receives a signal and converts it to a frequency within the RF band (65 — 2150 MHz). In the case of a terrestrial / cable signal the signal is not converted since that signal is within the RF range. After the conversion, the RF signal output is connected to the analyzer input connector and the measurement is performed in the usual way to an RF signal. In the conversion, bear in mind that for every unit of optical attenuation (one dB), occurs two dBs of power loss in RF. As an example, every 3 dB of optical attenuation for each splitter are equivalent to 6 dB of power loss for RF.

**► Connection**

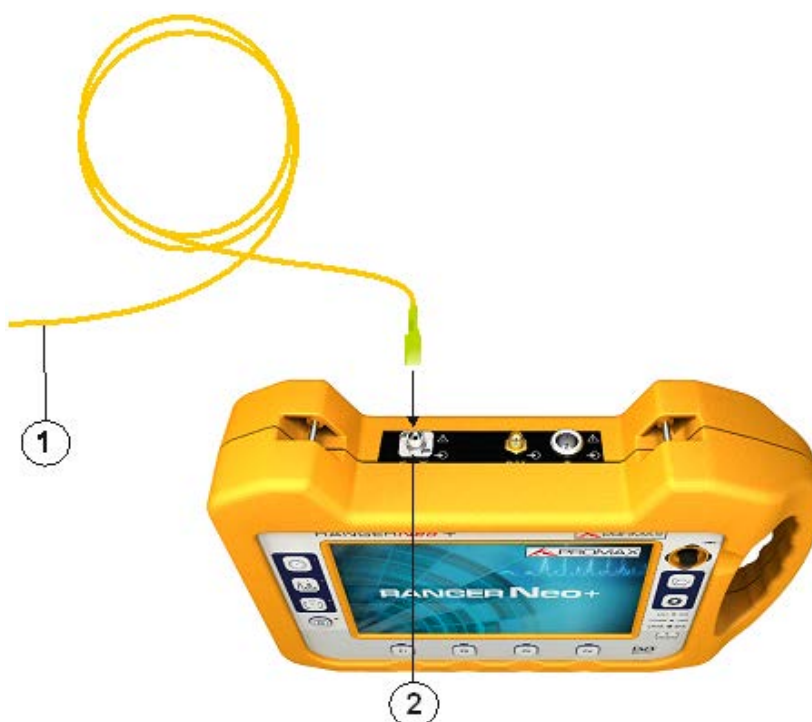

**Figure 129.**

- 1** Pigtail adapter (supplied with the module) releasing input optical signal to FC-APC input port.



## ► Settings

After the connection is made, the user can use the equipment for measurement of optical signals as if they were **RF** signals. Steps to measure a signal are as follows:

- 1 Press the Settings , key and in "Signal source" select "Fiber optic".
- 2 From Settings, select the corresponding band, whether terrestrial (for optical link) or satellite (for optical LNB). In the case of a satellite optical signal and frequency tuning, user has to select the signal type, characterized by the band (low/high) and the type of polarization (vertical/horizontal). In the case of a satellite optical signal and channel tuning, the parameters are defined by the channel (refer to the Settings menu section for more details).
- 3 Select the **Optical module** option and press the joystick.
- 4 It appears a window to enable the optical module and to configure additional parameters.
- 5 Select **Enable**.
- 6 At the top right area of the screen appears the **OPT** icon meaning there is external power.
- 7 It appears a window with some setting parameters.

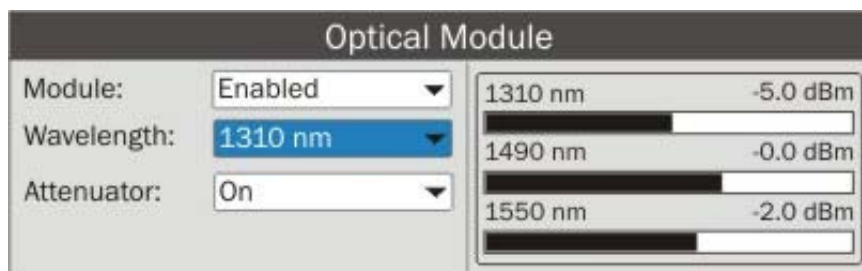

**Figure 130.**

In this window appears the level power for each wavelength and also the user can set two parameters:

- **Wavelength:** Wavelength selection at the **RF** output by the user among the three wavelength available: 1310, 1490 and 1550 nm.
- **Attenuator:** It can be enabled (ON) or disabled (OFF). When the attenuator is ON is 15 dB RF attenuation. When the attenuator is OFF is 0 dB RF attenuation. The attenuator must be adapted to the installation according to the RF power (modulation index).



**i.4 6 GHz Auxiliary RF Input**

**► Description**

The 6 GHz auxiliary RF input option can be used among other applications to directly connect optical LNBs with 5.4 GHz output. The RF input works for three bands:

- Band I From 2150 MHz to 3000 MHz
- Band II From 3400 MHz to 4400 MHz
- Band III From 4400 MHz to 6000 MHz

**► Connection**



**Figure 131.**

- 1** SMA Connector (RF aux. input signal).

**► Settings**

Follow these steps to set:

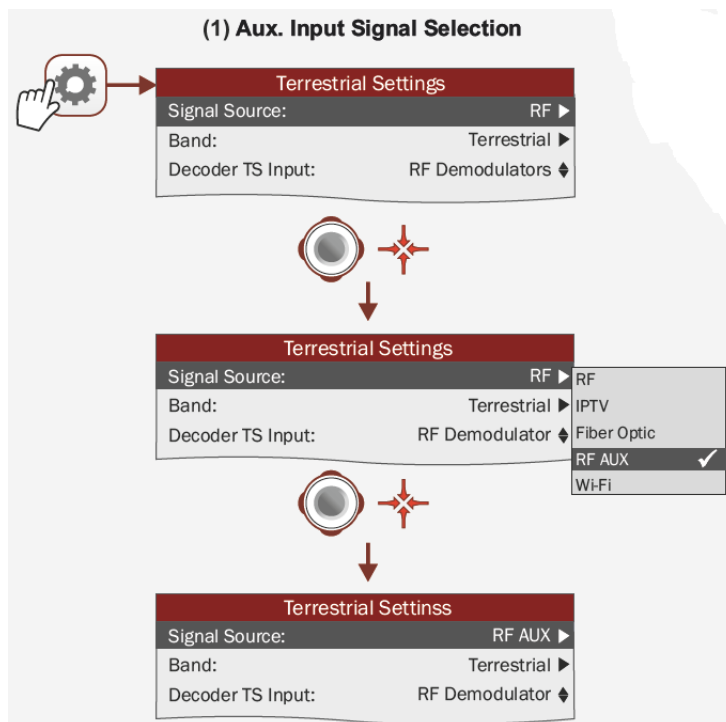

Figure 132. Auxiliary Input Signal Selection

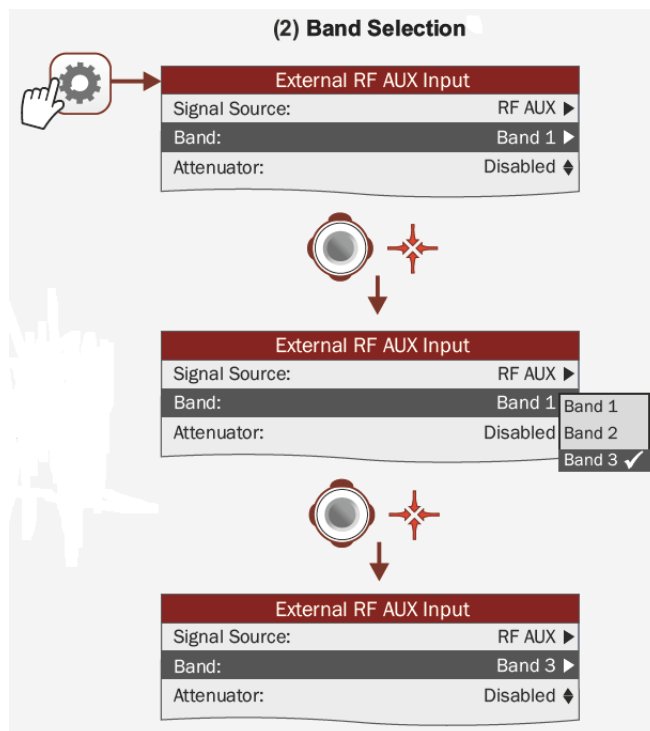

Figure 133. Band Selection





► Configuration

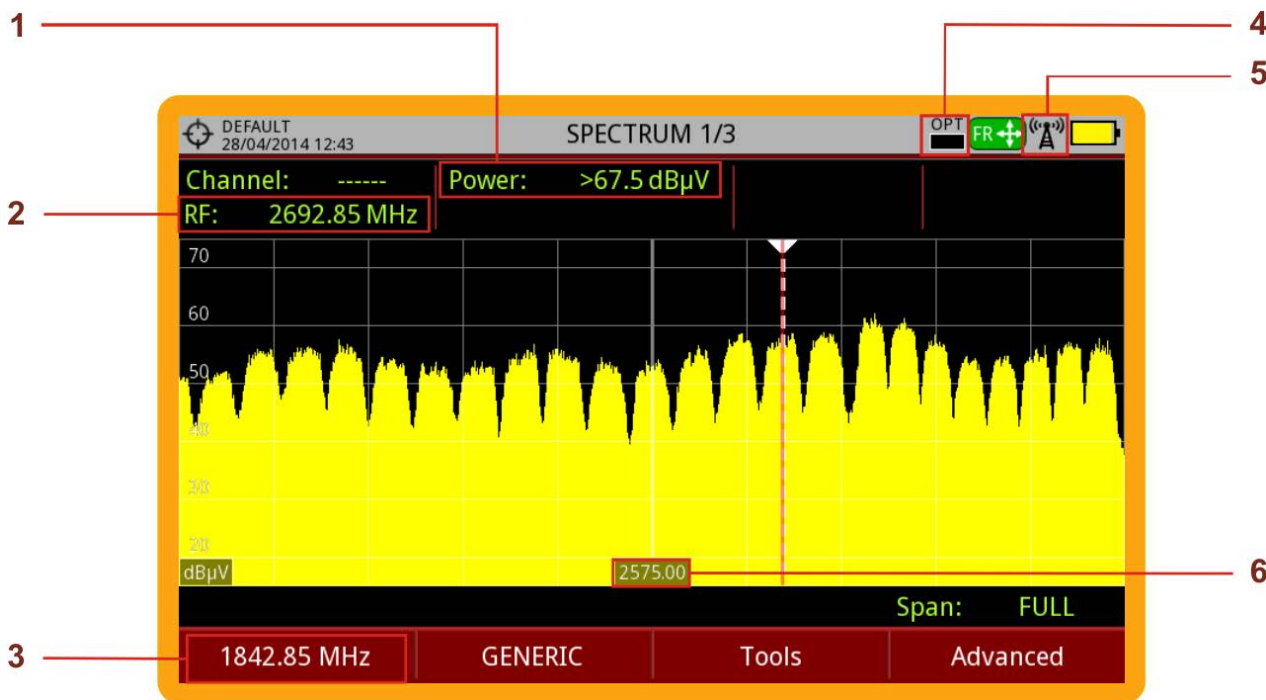

Figure 134.

- 1 Signal Power for RF Auxiliary Input
- 2 Signal Frequency for RF Auxiliary Input
- 3 Signal Frequency Input
- 4 Optical LNB Power Level
- 5 Auxiliary RF Input Enabled
- 6 Central Frequency

i.5 WiFi 5 GHz

► Description

The 5 GHz WiFi option extends the WiFi Analyzer to the second frequency range used for WiFi.

► Operation

- 1 Connect the USB WiFi adapter (supplied) to one of the two USB ports on the device. The "Wi-Fi Configuration" window pops up and it performs a Wi-Fi scan showing all networks detected. The WiFi icon will appear at the top of



the screen. Press F1 to exit because it is not necessary to log in a WiFi network to use this tool.

- 2 Connect the RF omni-directional antenna (supplied) to the RF input. This antenna detects WiFi band spectrum.
- 3 Press "Settings" key to access Settings menu. In "Signal Source" select "WiFi".
- 4 Press "Settings" key again, access "Band" option and select a band from available WiFi bands.
- 5 Press the F1 "Tuning" key and on "Channel Plan" select the WIFI 5 GHz. In case it is not available, go to "Installations management" , press F2: Manage and press F3: Installation. Press "Add Channel Plan" and select the WiFi 5GHz channel plan.
- 6 To start monitoring, first select tuning mode whether to tune by access point (AP) or channel (CH) using the F1 "Tuning" menu (enabled tuning mode is shown on joystick icon)
- 7 For more details about WiFi Monitoring refer to ["WiFi MONITORING" on page 137](#).

## i.6 LTE 2.6 GHz

### ► Description

The 2.6 GHz LTE option expands the spectrum analyzer to the band 7 of LTE. Band 7 is defined by an uplink band between 2.5 and 2.57 GHz and a downlink band between 2.62 and 2.69 GHz.

Band 7 of LTE is one of the most used globally since it allows to transmit with greater speed but at a shorter distance and is more exposed to suffer interference.

### ► Description

Follow the steps explained on LTE measurement section (["LTE Signals" on page 76](#)).



## ii WIFI 5 GHz+LTE 2.6 GHz+RF 6 GHz OPTION\*

### ii.1 Description

This annex contains operating instructions for the next option:

- OP-001-WL.

This option expands the meter with these functions:

- WiFi 5 GHz
- LTE 2,6 GHz
- RF 6 GHz Input

The 5 GHz WiFi option extends the WiFi Analyzer to the second frequency range used for WiFi.

The 2.6 GHz LTE option expands the spectrum analyzer to the band 7 of LTE. Band 7 is defined by an uplink band between 2.5 and 2.57 GHz and a downlink band between 2.62 and 2.69 GHz. Band 7 of LTE is one of the most used globally since it allows to transmit with greater speed but at a shorter distance and is more exposed to suffer interference.

The 6 GHz auxiliary RF input option can be used among other applications to directly connect optical LNBS with 5.4 GHz output.

This expansion module is available for any unit (both for new equipment or to upgrade equipment owned).

### ii.2 WiFi 5 GHz

#### ► Description

The 5 GHz WiFi option extends the WiFi Analyzer to the second frequency range used for WiFi.

---

\*. only available for **RANGER *Neo* +**



### ► Operation

- 1 Connect the USB WiFi adapter (supplied) to one of the two USB ports on the device. The "Wi-Fi Configuration" window pops up and it performs a Wi-Fi scan showing all networks detected. The WiFi icon will appear at the top of the screen. Press F1 to exit because it is not necessary to log in a WiFi network to use this tool.
- 2 Connect the RF omni-directional antenna (supplied) to the RF input. This antenna detects WiFi band spectrum.
- 3 Press "Settings" key to access Settings menu. In "Signal Source" select "WiFi".
- 4 Press "Settings" key again, access "Band" option and select a band from available WiFi bands.
- 5 Press the F1 "Tuning" key and on "Channel Plan" select the WIFI 5 GHz. In case it is not available, go to "Installations management" , press F2: Manage and press F3: Installation. Press "Add Channel Plan" and select the WiFi 5GHz channel plan.
- 6 To start monitoring, first select tuning mode whether to tune by access point (AP) or channel (CH) using the F1 "Tuning" menu (enabled tuning mode is shown on joystick icon)
- 7 For more details about WiFi Monitoring refer to ["WIFI MONITORING" on page 137](#).

## ii.3

### LTE 2.6 GHz

#### ► Description

The 2.6 GHz LTE option expands the spectrum analyzer to the band 7 of LTE. Band 7 is defined by an uplink band between 2.5 and 2.57 GHz and a downlink band between 2.62 and 2.69 GHz.

Band 7 of LTE is one of the most used globally since it allows to transmit with greater speed but at a shorter distance and is more exposed to suffer interference.

#### ► Description

Follow the steps explained on LTE measurement section (["LTE Signals" on page 76](#)).



This expansion module is available for any unit (both for new equipment or to upgrade equipment owned).

**ii.4 6 GHz Auxiliary RF Input**

**► Description**

The 6 GHz auxiliary RF input option can be used among other applications to directly connect optical LNBS with 5.4 GHz output. The RF input works for three bands:

- Band I From 2150 MHz to 3000 MHz
- Band II From 3400 MHz to 4400 MHz
- Band III From 4400 MHz to 6000 MHz

**► Connection**



**Figure 135.**

**1** SMA Connector (RF aux. input signal).



► Settings

Follow these steps to set:

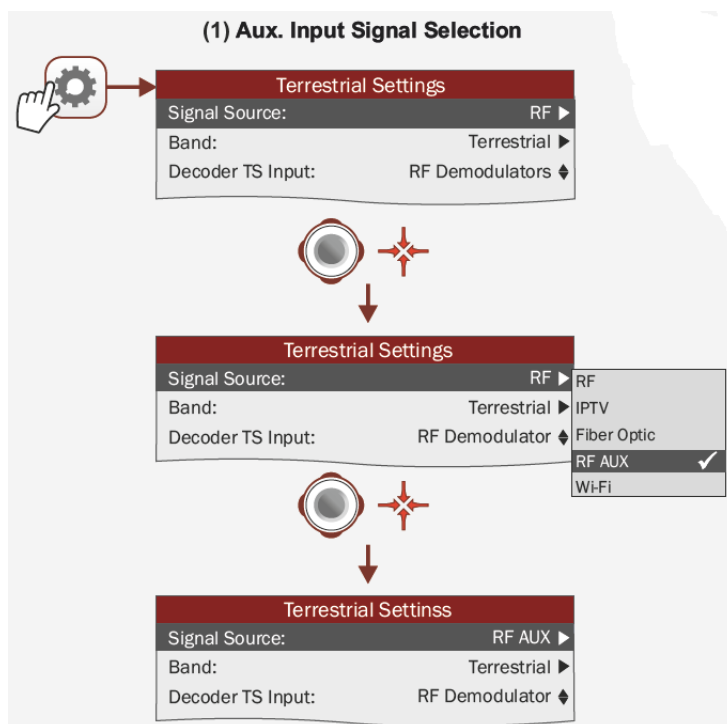

Figure 136. Auxiliary Input Signal Selection

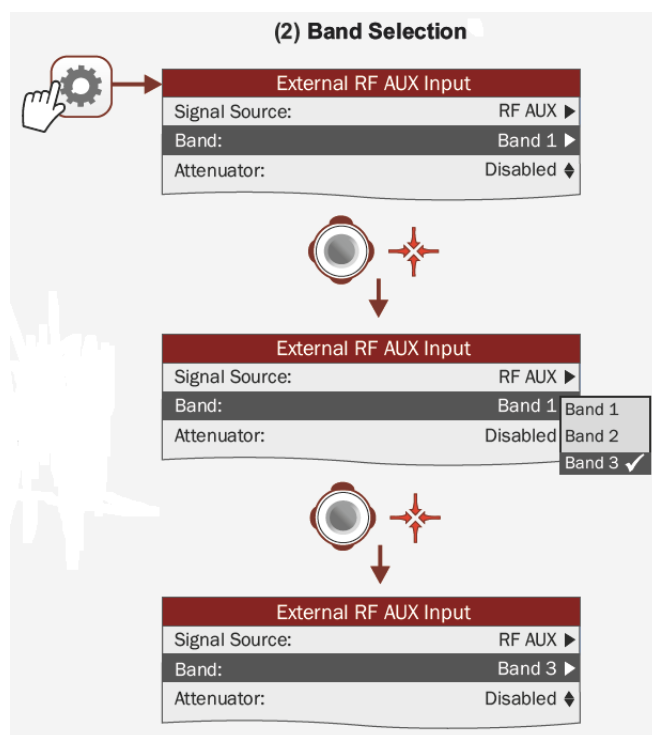

Figure 137. Band Selection



► Configuration

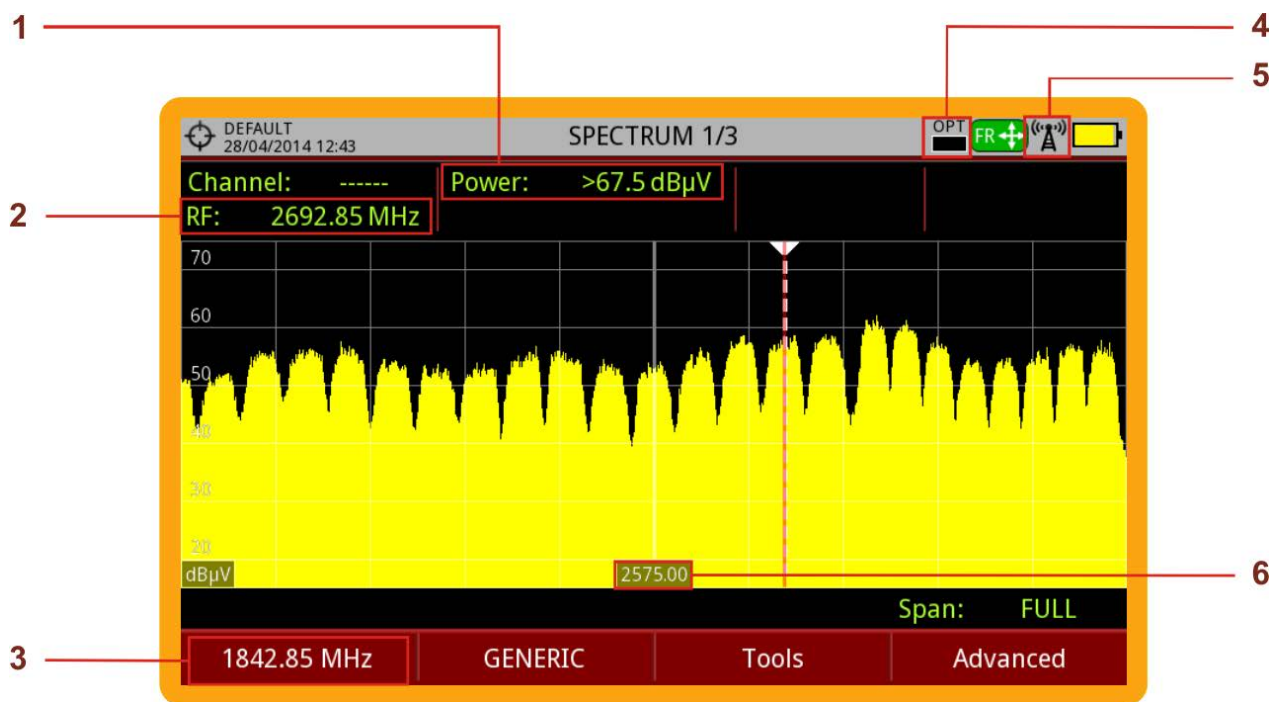

Figure 138.

- 1 Signal Power for RF Auxiliary Input
- 2 Signal Frequency for RF Auxiliary Input
- 3 Signal Frequency Input
- 4 Optical LNB Power Level
- 5 Auxiliary RF Input Enabled
- 6 Central Frequency



## iii SIGNAL COVERAGE OPTION\*

### iii.1 Description

This annex contains operating instructions for the next option:

- OP-001-GPS.

This option includes a GPS receiver to connect to the meter.

### iii.2 Signal Coverage

#### iii.2.1 Introduction



The Signal Coverage function allows the user to check signal for a tuned signal or a channel plan (several channels) by measuring power and other parameters over time.

The position where all these measurements are taken is determined by a GPS receiver. When the equipment locks a GPS signal, it automatically sets date and time using the GPS signal. As long as the GPS is locked, date and time is updated every hour.

All this data, measurements and GPS position can be downloaded to a PC and exported to a file for later analysis.

#### iii.3.1 Operation

The Signal Coverage tool is available for all RF signals.





- 1 Connect the GPS receiver to the meter.
- 2 In **Settings** menu  select the source of signal RF and terrestrial or satellite band.
- 3 Access the **Spectrum** mode and tune the signal for coverage study.
  - In case of tuning a **DVB-T2** signal, in the **Signal Parameters** menu  select the Profile (Base or Lite) and the PLP identifier. User has to choose one profile and one PLP identifier per each signal coverage analysis.

---

\*. only available for RANGER *Neo* +





- 4 Press the Tools key .
- 5 Select the **Signal Coverage** option.
- 6 Select between monitoring one single channel or one channel plan.
- 7 The **Signal Coverage** function appears on screen.
- 8 Before starting the signal coverage analysis, access the **Configuration** option in the **Advanced** menu  for settings (for more details refer to next section).
- 9 After settings, access the **Advanced** menu  and press on **Start** to start the signal coverage analysis. Before starting, it shows some warnings to confirm signal parameters (signal locked or unlocked, bandwidth and reference level) and if the file name already exists.
- 10 In **Continuous** mode, the equipment takes samples automatically according to settings (see next section). In **Manual** mode each time the user presses the joystick the equipment takes a sample. Measurements are linked to the GPS reference.
- 11 Access the **Advanced** menu  and press on **Stop** to finish the signal coverage analysis. Data obtained is automatically stored.
- 12 After stopped, it gives the option to access the Signal Monitoring Viewer that allows the user to watch the final results (for more details refer to ["Data Viewer" on page 237](#)).
- 13 You can also access data by pressing the **Installation List** key  to check that the monitoring data file has been saved. This file is a "Data Capture" type. To manage the data, see below the section "Data File Processing".



► Screen Description

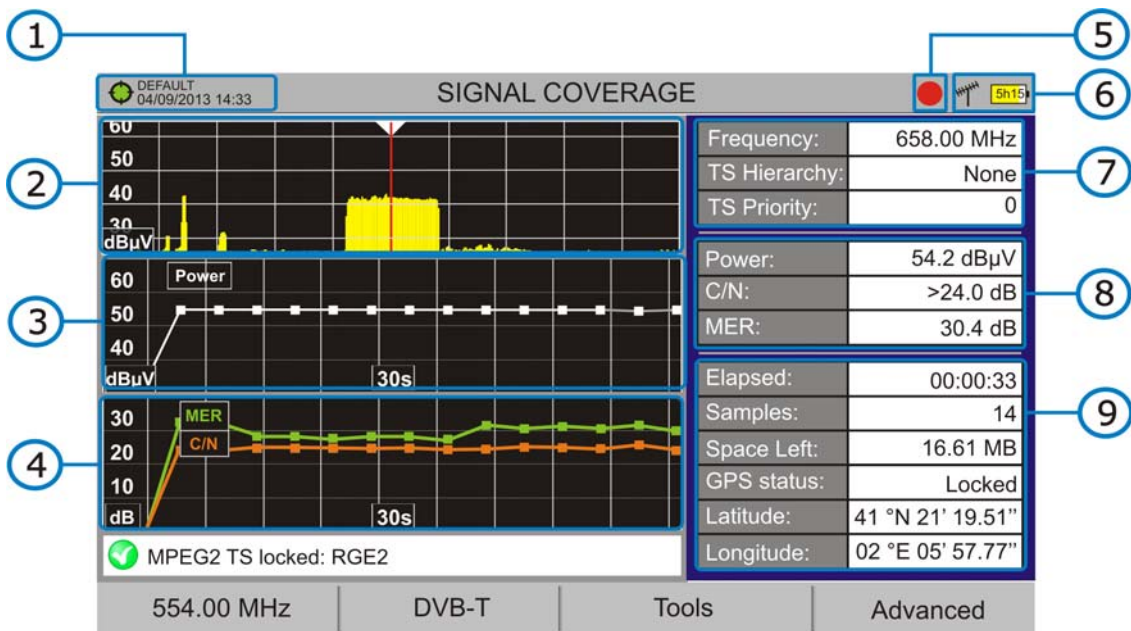

Figure 139. Signal Coverage for Single Channel

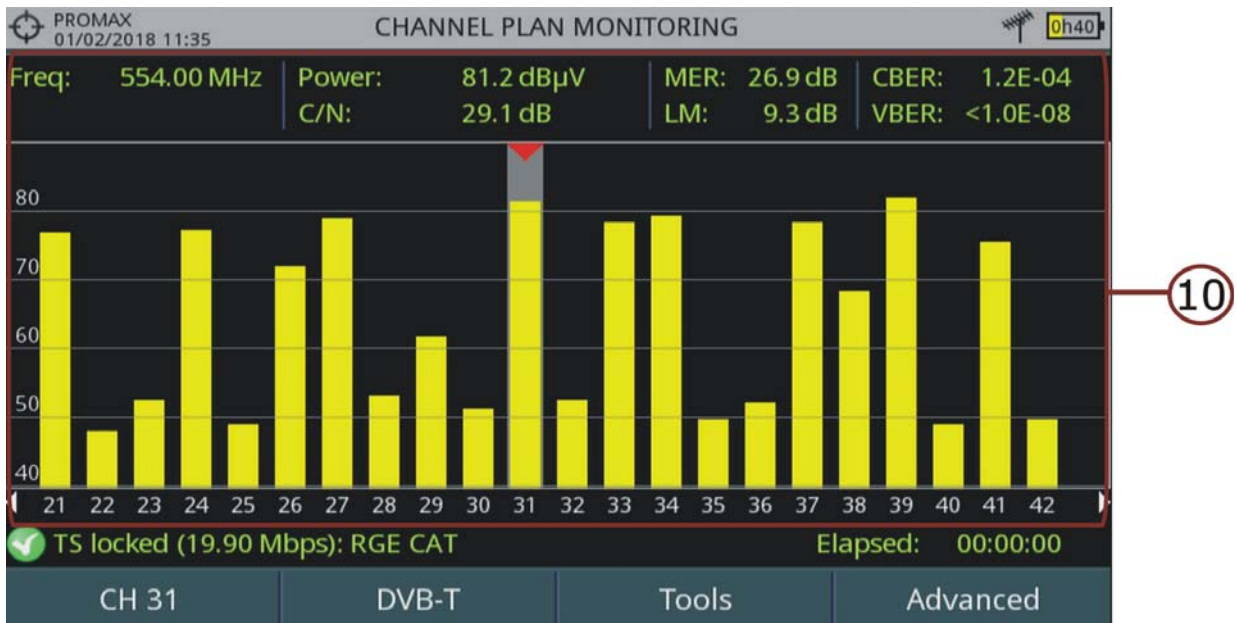

Figure 140. Signal Coverage for Channel Plan



- 1 Selected installation; date and time. The "Current installation" in green indicates the system has locked the GPS signal. The "Current installation" in red indicates that the system has not locked the GPS signal.
- 2 Spectrum.
- 3 Power measurement over time (span time is set in configuration).
- 4 MER and C/N measurement over time (span time is set in configuration).



- 5 Indicator of Signal coverage started.
- 6 LNB, Selected band; battery level.
- 7 Signal information window 1:
  - Frequency: frequency at which signal is locked; **Profile** (only for DVB-T2 signals): Base or Lite; **PLP identifier** (only for DVB-T2 signals): identifier of the layer being measured, **TS Hierarchy** (table hierarchy at the transport stream) **TS Priority** (packet priority at the transport stream).
- 8 Signal information window 2:
  - Measurement over time.
- 9 Signal information window 3:
  - File name: Name of current coverage file.
  - **Elapsed**: Time elapsed since the beginning of the coverage study.
  - **Samples**: Samples taken since the beginning of the coverage study.
  - **Space left**: Space left in the memory to save data.
  - **GPS status**: It shows if the GPS receiver is locked or unlocked.
  - **Latitude, Longitude**: It shows the latitude and longitude at the current position, if GPS is locked.
- 10 Channels from the channel plan being monitored. Measurement data are from the selected channel (pointed by a red arrowhead).
  - Joystick functions:
    - No function for this tool.
  - Axis Description (Single Channel Monitoring screen):
    - Axis X: Window 1: Frequency; Window 2 and 3: Time.
    - Axis Y: Window 1 and 2: Power; Window 3: MER and C/N.

### iii.3.2 Menu Options

At the bottom of the screen there are four menus available via the function keys.

-  It displays the channel/frequency where is pointing the cursor and access the tuning menu.
-  It displays the selected transmission standard menu and accesses the signal parameters.
-  It displays the Tools menu.



- **F4** It displays the Advanced menu.

In the **Advanced** menu there are some options for the **Signal Coverage**. They are:

- **Start**: It starts the signal coverage study.
- **Stop**: It stops the signal coverage study.
- **Pause**: It stops the signal monitoring for a while until resuming.
- **Configuration**: It shows the settings window with some parameters (for more details refer to next section).
- **Audio**: It allows enable or disable audio. When this option is enabled, the user can listen to any service in the monitored signal, knowing about signal reception while driving or doing other tasks.
- **GPS Status**: It shows a list and a graph with satellites detected to locate the GPS signal. It is also provided additional data such as longitude, latitude, date and universal time, visible satellites and GPS status (locked or not).

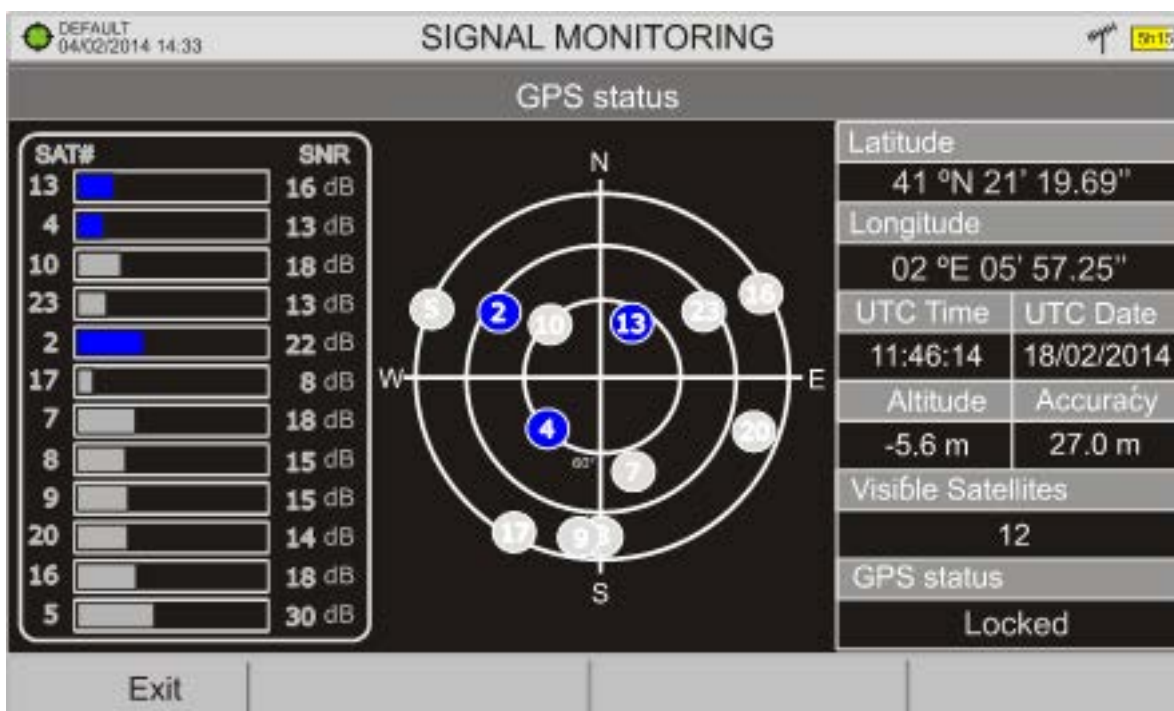
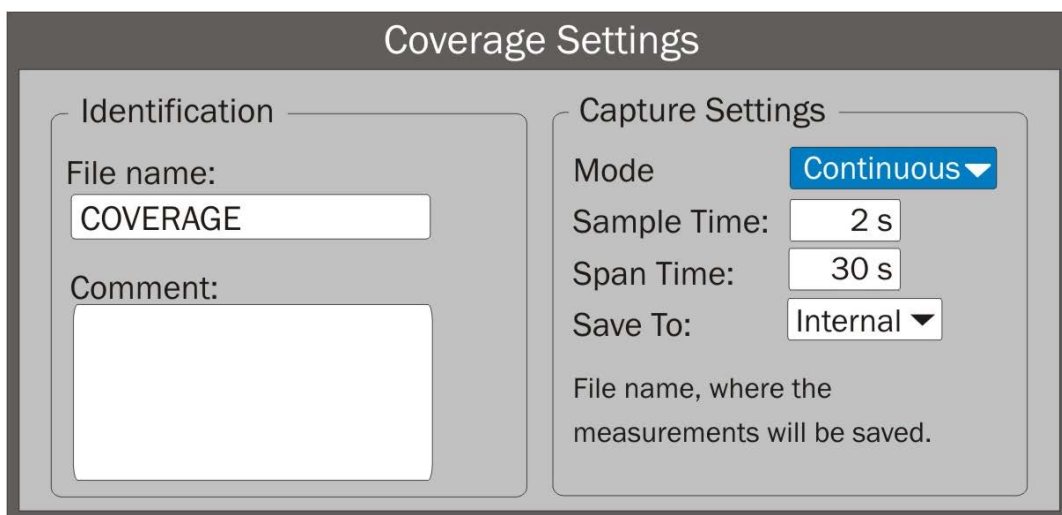

Figure 141.



### iii.3.3 Settings

User can adjust some parameters on the Signal Coverage analysis:



**Figure 142.**

- **File name:** User can give a name to the file where data is saved. All measurement will be stored on the data file. Be sure to change the file name when starting a new Signal coverage analysis. If not, a warning message appears before new data file will be saved on the last one.
- **Comment:** User can write some comments about the study.
- **Mode:** There are **three operation modes**:
  - Continuous: A sample is taken automatically every sample time.
  - Manual: A sample is taken every time that user presses the joystick.
  - Schedule: User defines starting time for monitoring. Then he must press on "Start" in Advanced menu (F4) to start the countdown to the starting time.
- **Sample Time:** Time between samples. Only when working in continuous or schedule mode. Minimum time is 1 second.
- **Span time (only for signal channel coverage):** It is the width, in time, shown on screen for the X axis.
- **Save to:** There are **two** options: **Internal** or **USB**. For Internal option it saves the file with all data in the internal memory of the equipment. For USB option it saves the file with all data in a USB flashdrive connected to the micro-USB port of the equipment.
- **GPS Alarm:** If this box is checked then it sounds a bip when the GPS is unlocked.



### iii.3.4 Data Viewer

The data viewer allows the user to browse along the final results. It opens directly after saving the data or by opening the associated data file (that is located in the installation manager).

#### ► Screen Description



**Figure 143.**

- 1 Selected installation; date and time.
- 2 Power measurement over time.
- 3 MER and C/N measurement over time.
- 4 Joystick mode selected: PA mode (panoramic) or MA mode (cursor movement).
- 5 LNB, selected band; battery level.
- 6 Signal information window 1: Measurement where the cursor is.
- 7 Signal information window 2: Date, time and elapsed time.
- 8 BScrollbar: it shows position and size of the data displayed related to total data.
- 9 Time span of displayed data.
- 10 Menu Options:
  - F1: Exits the data viewer.
  - F2: It shows transmission parameters of the monitored signal.
  - F3: It shows the monitored channel or for channel plan it allows selecting the channel to view data.



■ Joystick functions:

- Joystick up/down: It increases / decreases zoom.
- Joystick left/right: In PA mode it moves time span along the total time. In MA mode it moves the cursor along the samples of the time span.
- Joystick Press: It switches between panoramic (PA) and movement (MA) mode.

### iii.3.5 Data File Processing

#### ► Description

This document is an explanation about the process that is needed to be done in order to obtain a more comfortable view of the XML data obtained with the meter, with GPS option, when doing a Signal Coverage analysis.

Once you got the coverage data, copy the XML data file from the equipment to a USB memory using the Installation Manager. See the equipment's documentation in how to get files from an Installation.

#### ► Obtaining an Excel File

For this section, you must have at least Excel 2003 or newer version. Excel 2007 (or later) is highly recommended to avoid macro problems.

- 1 First of all we need to locate the XML data file in the folder from which we want to work. There are no requirements needed to be satisfied. A file named COVERAGE.XSL must be placed in the same data file folder. That second file allows proper data formatting when processed by Excel.
- 2 Select the XML data file and then right click with the mouse button on the file name.
- 3 Choose the option "**Open with**" and then select Excel 2007 (or the available version).

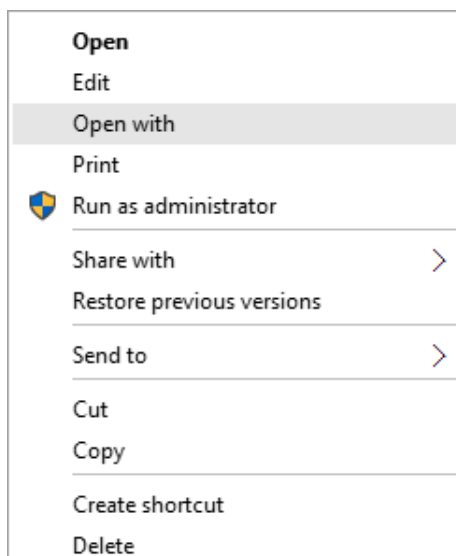

**Figure 144.**

- 4 When Excel tries to open the file it will ask you the import method to open the XML data file by this way:

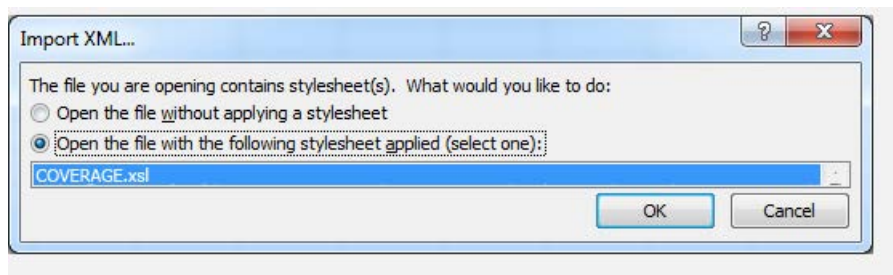

**Figure 145.**

- 5 You must choose the option in which a stylesheet is asked. It will appear as an option the "COVERAGE.xsl" file.
- 6 Now Excel is opening the XML data file using the format that the XSL file is providing. This step could take few seconds depending on the size of the XML data file.
- 7 At this point, you should have an excel file with three different sheets. Each sheet corresponds to a different view of the same data:
  - The first one will show you the generic signal information and the different coverage measures for each point acquired
  - In the second one, you will find the same data but presented in a table format, more user friendly for working with graphs based on each measured parameter.
  - The third one provides data in a format adapted for geolocation. Information is shown in terms of parameters required for presenting the measured data as a map layer (latitude, longitude, id, description and an





icon identifier number) as required for GIS and Google Earth technologies. This third sheet is formatted mainly to be compatible with main Google Earth format converters available in Internet

- 8 Now save the data as a true excel file. No specific name or path is required, but you must remember the path.

### iii.3.6 **Displaying Measurement in Google Earth**

Measurement taken with the **Signal Coverage** tool can be exported and displayed on Google Earth 3D maps.

- 1 Install **Google Earth** (<https://www.google.com/earth/>) on your PC.
- 2 Once measurements have been made and coverage data obtained, copy the generated data file (COVERAGE.XML) to a USB stick or to a PC (for more details refer to [“CONNECTING TO EXTERNAL DEVICES” on page 238](#)).
- 3 Access the KML Generator application by PROMAX (<http://www.promax.es/tools/kml-generator/>).
- 4 Click on the **KML Generator** screen and then a file explorer opens. Select your data file (COVERAGE.XML) exported from the meter.
- 5 If the file is correct it opens a window with a series of options that allow you to customize the visualization:
  - **Assign colors to the test points using a quality-based color scale:** It assigns a color (selected by the user) for the worst quality value and another color for the best quality value. For the intermediate values performs a gradation between both colors.
  - **Use a PASS/FAIL threshold:** It uses only two colors (selected by the user). A color for measures that are below a certain threshold value and another color for measures that are above that value.
  - **Quality parameter to use as reference:** Select the type of measurement (POWER, MER...) to show on the map.
  - **Bad quality test points color:** Select one color for bad quality points.
  - **Good quality test points color:** Select one color for good quality points.
  - **Value:** Define a value for bad quality and another for good quality points. These values are related to color above.
  - **Automatic:** If you check this option it uses the highest and / or lowest value detected in your exported data file.
  - **Threshold value:** It allows you to select the limit value to paint the measurements of one color or another.
  - **Generate and overlay a legend:** It shows a legend that provides information to understand the map.



- **Include test points with UNLOCKED signal (only for digital signals):** It shows all test points even if signal is not tuned.
  - **Add extra information to test points (all measurements, date and time):** It displays all measures for each test point also date and time when they were taken.
  - **Skip test points at the same physical location:** It only uses the first measure if are more than one with the same coordinates.
  - **Choose a marker style for test points geolocation:** Select the type of marker.
- 6 Once the configuration of the file is finished, click on the option "Download your KML file for Google Earth".
  - 7 Click on the downloaded file in KML format (COVERAGE.KML). It Should open the Google Earth program showing the measurement data over a 3D map.



## iv DAB/DAB+ OPTION\*

### iv.1 Description



This annex contains operating instructions for the next option:

- OP-001-DAB+: Measurement of DAB y DAB+ digital radio.



This function allows the user to detect, measure, analyze and visualise digital radio DAB and DAB+.

The DAB (Digital Audio Broadcasting) is a digital radio standard, designed for both home and portable receivers to broadcast terrestrial and satellite audio and also data. It works with Band III and L-Band frequencies.

The DAB+ is an evolution of DAB using the AAC + audio codec. It also includes Reed-Solomon error correction, which makes it more robust. DAB receivers are not compatible with DAB+ receivers.

Icons  or  identify when a service is DAB or DAB+.

### iv.2 Operation

- 1 Connect the RF input signal to the equipment.
- 2 Select RF source signal and terrestrial band in Settings  menu.
- 3 Lock the DAB/DAB+ signal.
- 4 To enable auto-detection for DAB/DAB+, access "Preferences" pressing the key  for one second and in the StealthID tab select the DAB option.

---

\*. only available for RANGER *Neo* +



iv.2.1 Measurement Mode

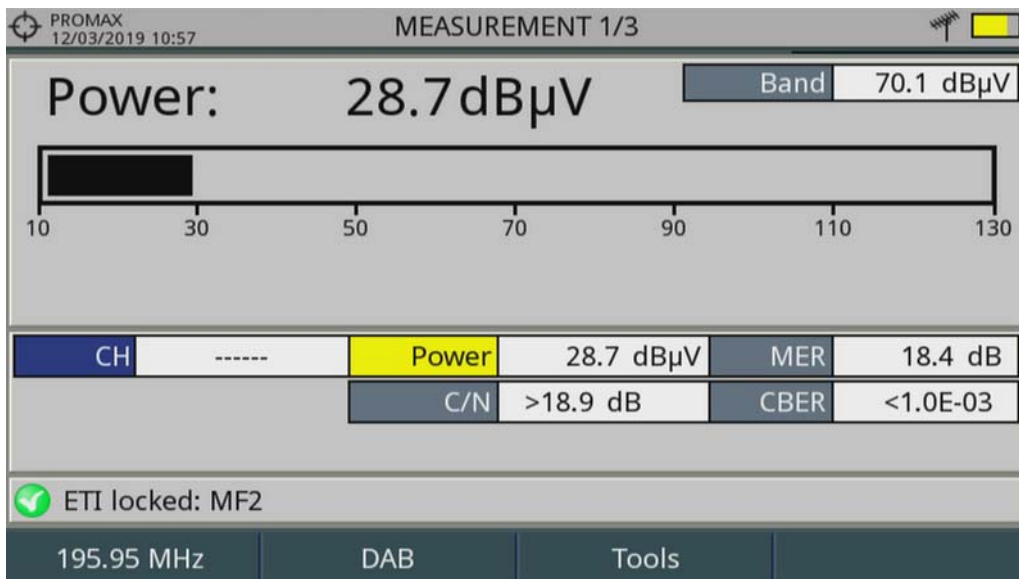

Figure 146. Measurement 1/3

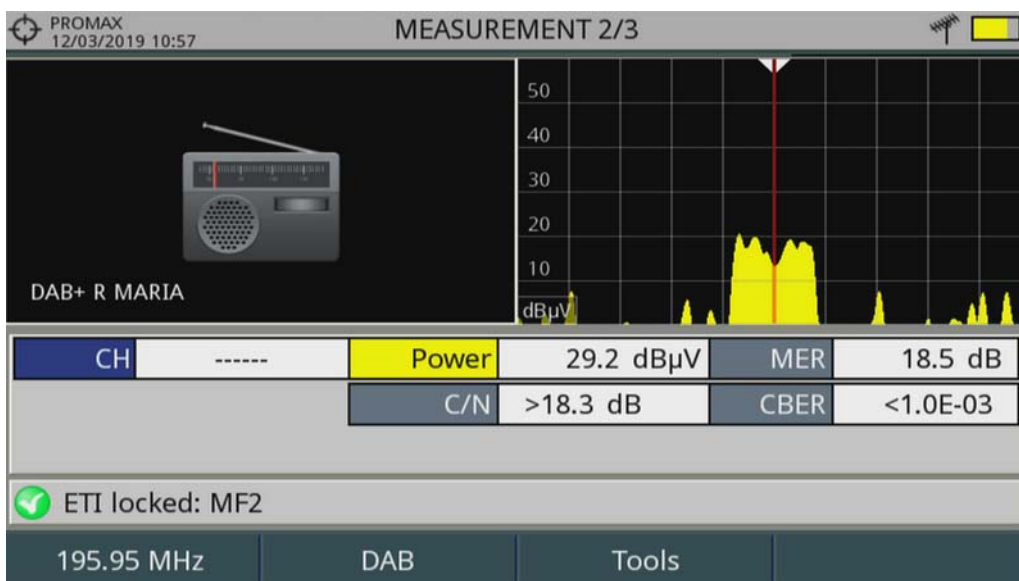

Figure 147. Measurement 2/3

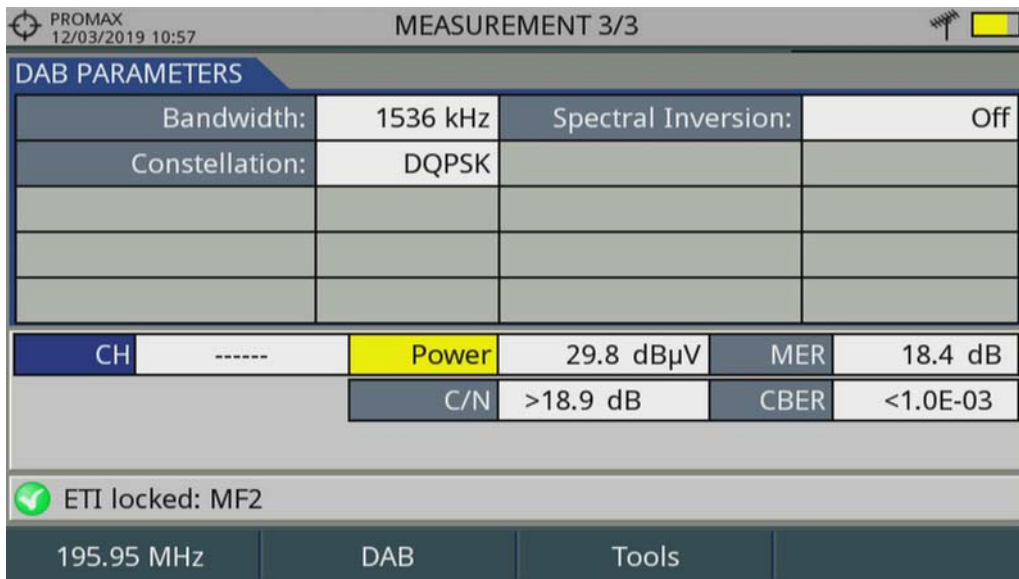

Figure 148. Measurement 3/3

iv.2.2 Spectrum Analyzer Mode

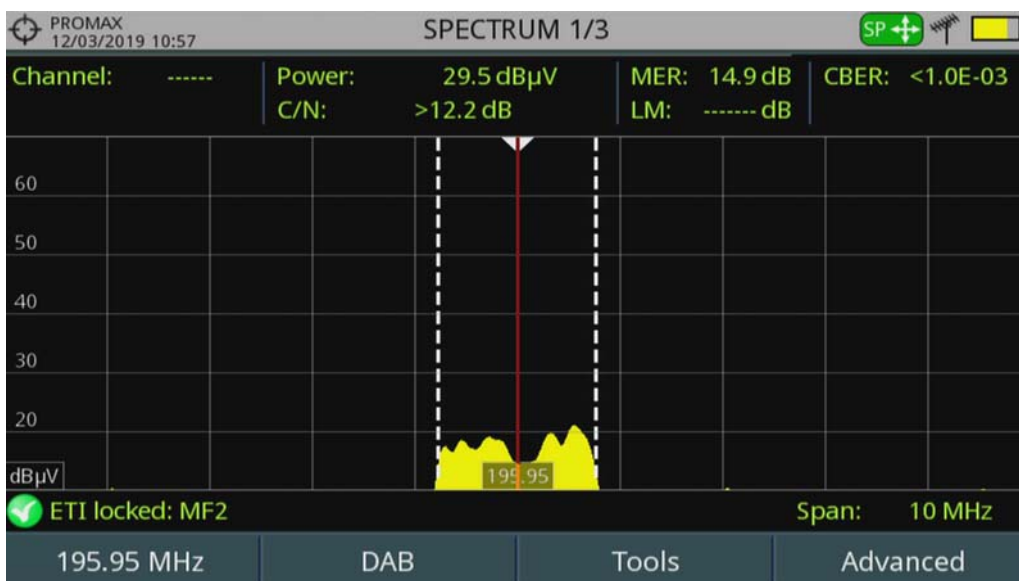

Figure 149. DAB Spectrum 1/3

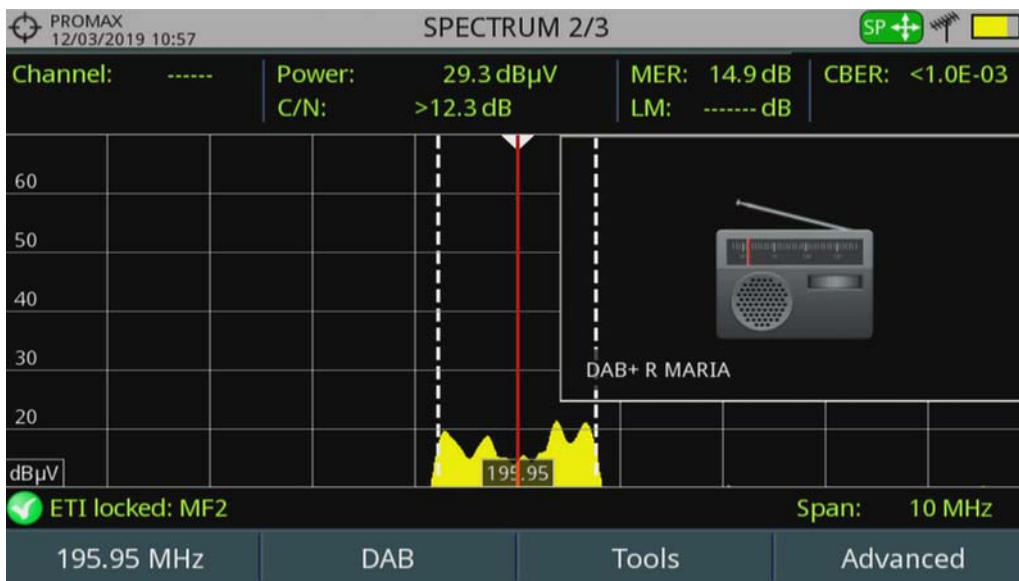

Figure 150. DAB Spectrum 2/3

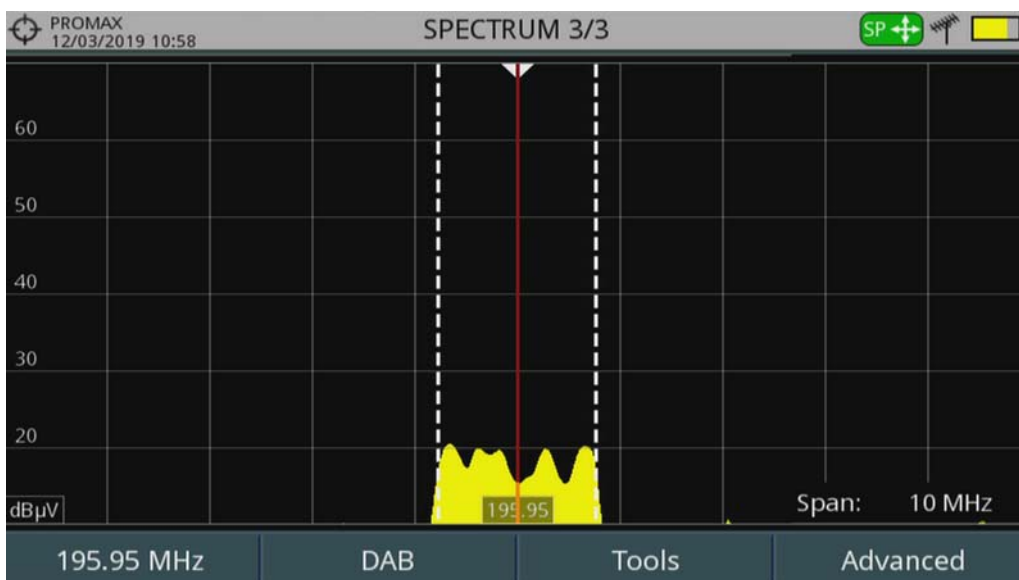

Figure 151. DAB Spectrum 3/3



iv.2.3 TV Mode



Figure 152. DAB 1/3

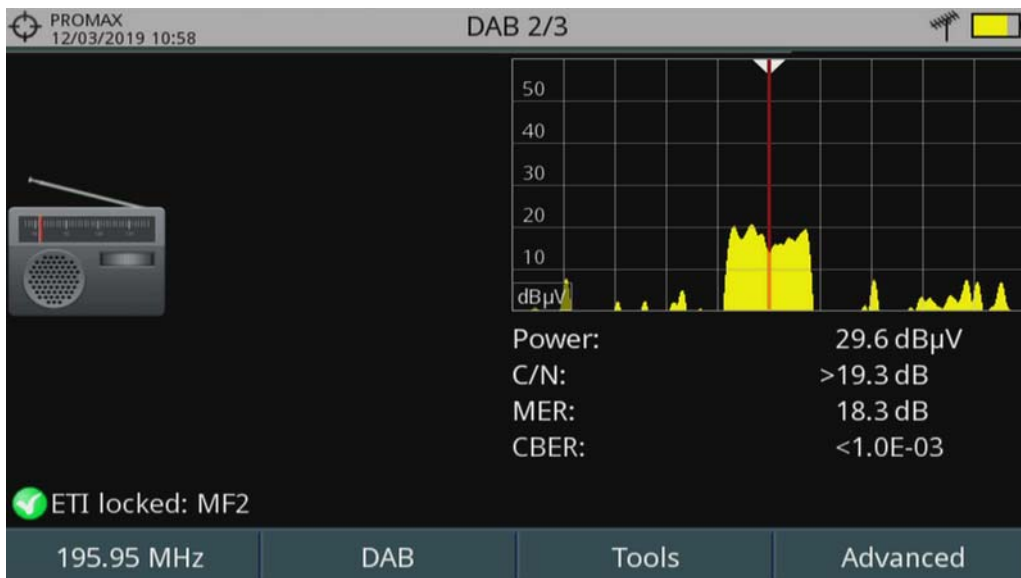

Figure 153. DAB 2/3



| Multiplex   |                         |           |                |
|---|-------------------------|-----------|----------------|
| Ensemble  | MF2                     | ID:       | 61437 (0xEFFD) |
| Service   | DAB+ R MARIA            | ID:       | 61421 (0xEFED) |
| Component   | DAB+ R MARIA            | ID:       | 2 (0x02)       |
| Content:  | Audio (1)               | Language: | Unknown (0x00) |
| Format:   | DAB+                    | Category: | Primary        |
| Audio:  | HE-AAC v2 64kbps Stereo |           |                |
| PTY:  | Religion (0x14)         |           |                |
| Radiotext (D...   |                         |           |                |
|  ETI locked: MF2 |                         |           |                |
| 195.95 MHz  |                         | DAB       |                |
| Tools   |                         | Advanced  |                |

Figure 154. DAB 3/3





## v RACK OPTION

### v.1 Introduction

This annex describes special features for the rack version of **RANGER *Neo*** equipment.

Each portable model has its counterpart in 4U rack format.

### v.2 Package Content

Check that your package contains the following elements:

- **RANGER *Neo* RACK** Analyzer.
- Mains cord.
- Dual WiFi Antenna.
- USB WiFi Adapter.
- Aero SMA-H/BNC-M adapter.
- "F" adapters:
  - "F"/f - BNC/f adapter.
  - "F"/f - DIN/f adapter.
  - "F"/f - "F"/f adapter.
- 4V/RCA Jack Cable.
- USB (A) - USB (A) cable.
- Quick Start Guide.

**NOTE:** Keep the original packaging, since it is specially designed to protect the equipment. You may need it in the future to send the analyzer to be calibrated.



### v.3 Power

The **RANGER Neo** RACK is powered to the mains via the mains cord. Ensure that your mains voltage is compatible.

#### ► Switching On:

- 1 Press the ON/OFF switch at the back of the equipment.
- 2 The boot screen appears and also a progress bar that indicates the system is loading. At the top left corner it shows the equipment model and release.
- 3 After the system loads, it shows the last status used (mode and screen).

#### ► Switching Off:

- 1 Press the ON/OFF switch at the back of the equipment.

### v.4 Equipment Details



Figure 155. Front View



Figure 156. Side View



Figure 157. Back View



## v.5 Specifications

### ► Power Supply

| Parameter        | Value          | Additional Data |
|------------------|----------------|-----------------|
| External Voltage | 110 - 230 V AC |                 |
| Consumption      | 40 W           |                 |

### ► Mechanical Features

| Parameter  | Value                  | Additional Data |
|------------|------------------------|-----------------|
| Dimensions | 482 x 177,6 x 238,7 mm | (W) x (H) x (D) |
| Rack Units | 4U                     |                 |

### ► Included Accessories

| Parameter                       | Value                    | Additional Data |
|---------------------------------|--------------------------|-----------------|
| 1x 0 MT0170                     | Antenna Dual WiFi        |                 |
| 1x 0 MF0213                     | USB WiFi adapter         |                 |
| 1x 0 MF0214                     | USB cable                |                 |
| 1x 0 CO6861                     | Aero SMA-H/BNC-M adapter |                 |
| 1x CC-046                       | Jack 4V/RCA cable        |                 |
| 1x AL-103                       | External DC charger      |                 |
| 1x AD-055                       | "F"/f-BNC/f adapter      |                 |
| 1x AD-056                       | "F"/f-"DIN"/f adapter    |                 |
| 1x AD-057                       | "F"/f-"F"/f adapter      |                 |
| 1x CA-005                       | Mains cord               |                 |
| 1x DG0317 (RANGER <i>Neo</i> +) | Quick Reference Guide    |                 |

**NOTE:** All other specifications are equal to the portable model and can be consulted on the Specifications chapter ([\\*SPECIFICATIONS RANGER Neo Lite / +\\* on page 198](#)).



## vi ADDITIONAL INFORMATION

### vi.1 Multimedia Content

On the PROMAX channel on Youtube you can find video tutorials and other audiovisual documents related to the field strength meter.

| Name  | Link  |
|---|---|
| <b>PROMAX channel on YOUTUBE</b>                | <a href="https://www.youtube.com/user/PROMAXElectronics">https://www.youtube.com/user/PROMAXElectronics</a>   |
| <b>Playlist: Field Strength Meter Tutorials</b> | <a href="https://www.youtube.com/watch?v=48kIYEAR_ZU&amp;list=PL3hht4WG655S6PXIzd3G9ItU2dBcamuOR">https://www.youtube.com/watch?v=48kIYEAR_ZU&amp;list=PL3hht4WG655S6PXIzd3G9ItU2dBcamuOR</a>   |
| <b>Playlist: NetUpdate4 Software</b>            | <a href="https://www.youtube.com/watch?v=akknHR3nhV8&amp;list=PL3hht4WG655SqAUWkyMG_uT9Ne6dnUOC4V">https://www.youtube.com/watch?v=akknHR3nhV8&amp;list=PL3hht4WG655SqAUWkyMG_uT9Ne6dnUOC4V</a> |

### vi.2 Additional Documents

On the PROMAX website you can find additional information to go deeper in some aspects related to the field strength meter.

| Name                               | Description  | Link  |
|------------------------------------|--|---|
| <b>PROMAX Download Area</b>        | Documentation related to PROMAX equipment  | <a href="http://www.promaxelectronics.com/ing/downloads/user-manuals">http://www.promaxelectronics.com/ing/downloads/user-manuals</a>   |
| <b>Signals Description</b>         | Brief definition of all signals and parameters detected by the meter                               | <a href="http://www.promaxelectronics.com/ing/downloads/user-manuals/ranger-neo-3/high-class-field-strength-meter-and-spectrum-analyzer">http://www.promaxelectronics.com/ing/downloads/user-manuals/ranger-neo-3/high-class-field-strength-meter-and-spectrum-analyzer</a> |
| <b>How to Point a Dish Antenna</b> | Explanation about how to use the meter to install and point a satellite dish                       | <a href="http://www.promaxelectronics.com/ing/downloads/user-manuals/ranger-neo-3/high-class-field-strength-meter-and-spectrum-analyzer">http://www.promaxelectronics.com/ing/downloads/user-manuals/ranger-neo-3/high-class-field-strength-meter-and-spectrum-analyzer</a> |
| <b>DiSEqC Commands</b>             | Description of DiSEqC commands for remote control of antennas                                      | <a href="http://www.promaxelectronics.com/ing/downloads/user-manuals/ranger-neo-3/high-class-field-strength-meter-and-spectrum-analyzer">http://www.promaxelectronics.com/ing/downloads/user-manuals/ranger-neo-3/high-class-field-strength-meter-and-spectrum-analyzer</a> |
| <b>Remote Control Commands</b>     | Description of remote commands for remote control of the meter                                     | <a href="http://www.promaxelectronics.com/ing/downloads/user-manuals/ranger-neo-3/high-class-field-strength-meter-and-spectrum-analyzer">http://www.promaxelectronics.com/ing/downloads/user-manuals/ranger-neo-3/high-class-field-strength-meter-and-spectrum-analyzer</a> |
| <b>NetUpdate Manual</b>            | Instructions manual about the NetUpdate software to update firmware and manage data from the meter | <a href="http://www.promaxelectronics.com/ing/downloads/user-manuals/ranger-neo-3/high-class-field-strength-meter-and-spectrum-analyzer">http://www.promaxelectronics.com/ing/downloads/user-manuals/ranger-neo-3/high-class-field-strength-meter-and-spectrum-analyzer</a> |

### vi.3 Social Networks

| Name           | Link   |
|----------------|--|
| <b>Twitter</b> | <a href="https://twitter.com/PROMAX_news">@PROMAX_news</a> |



| Name     | Link  |
|----------|---|
| LinkedIn | <a href="https://www.linkedin.com/company/1493234/">https://www.linkedin.com/company/1493234/</a>     |
| Facebook | <a href="https://www.facebook.com/promaxelectronics/">https://www.facebook.com/promaxelectronics/</a> |

## vii INDEX

4K [76](#)

Analogue Signal [58](#)

Antenna adding [152](#)

Antenna remove [154](#)

Aspect Ratio [58](#)

Audio [58](#)

Audio Signal [56](#)

Audio Tone [56](#)

Band selection [36](#)

Battery Time [41](#)

Beacon signal [74](#)

Brightness [38, 41](#)

CCTV [36](#)

Centre Frequency [66](#)

Channel Plan Adding [152](#)

Colour System [39](#)

Cursor [65](#)

Dashed BW [58](#)

Detector Type [57](#)

Discovered URLs [58](#)

DiSEqC [37](#)

Downlink [51](#)

e-mail, settings [45](#)

External Power Supply [36](#)

Generic Signal [73](#)

Google Earth 3D map [240](#)

Importing data from USB [154](#)

Installation creation [153](#)

Installation data export [186](#)

Installation edition [153](#)

Installation export [187](#)

Installation export from USB [154](#)

Installation export to USB [154](#)

Installation import [188](#)

Installations [32](#)

IRG Descriptor [75](#)

Joystick [29](#)

Keyboard Shorcuts [32](#)

LNB Drain [37](#)

LNB High Oscillator [38](#)

LNB Low Oscillator [38](#)

Locking a Signal [73](#)

LTE, medición de señales [76](#)

Marker [56](#), [66](#)

Marker Trace [57](#)

Max. Hold [57](#)

Measurement Mode Screens [59](#)

MEROGRAM [89](#)

Min. Hold [57](#)

Minimal FM Level [42](#)

Minimal Satellital Power [42](#)

Minimal Terrestrial Level [42](#)

Minimal Terrestrial Power [42](#)

Netupdate connection [190](#)

Network, parameters [45](#)

NTP Options [45](#)

NTSC [39](#)

Offset [42](#)

OTT description [145](#)

PAL [39](#)

Persistence of Spectrum [57](#)

Polarization [37](#)

Power Off [41](#)

Preferences [32](#)

Preferences Menu [39](#)

RACK, features [248](#)

RDS Data [72](#)

Reference Level [65](#)

Reference of Spectrum [58](#)

Remote Control Command [191](#)

Reset [14](#)

Resolution Bandwidth [57](#)

Satellite Identification [74](#)

SCD/EN50494 [37](#)

SCD2/EN50607 [37](#)

SECAM [39](#)

Service Selection [54](#)



Settings [32](#)  
Signal Coverage [231](#)  
Skin [41](#)  
SMTP, settings [45](#)  
Span [50](#), [65](#)  
Spectrogram [91](#)  
Streaming V/A [135](#)  
Supply voltages [36](#)  
Switching Off by hardware [13](#)  
Switching Off by software [13](#)  
Switching Off, Automatic [13](#)  
Switching On [13](#)

Tilt [132](#)  
Time & Date [41](#)  
Time settings [45](#)  
Tone Level [56](#)  
Touchscreen Calibration [41](#)  
TS Data [58](#)  
Tuned Audio Information [70](#)  
Tuned service information [69](#)  
Tuning by Channel [49](#)  
TV / Radio Mode Screens [67](#)

Vertical Range [58](#)  
Video & Audio Settings [38](#)  
Volume [38](#)

WebControl Historical Monitoring [174](#)  
WebControl Measurements and Spectrum [159](#)  
WebControl Monitoring [164](#)  
WebControl Remote Console [162](#)  
WebControl Settings [156](#)  
WebControl TV Parameters [161](#)  
Webcontrol, channel plan [165](#)  
Webcontrol, Mask Monitoring [169](#)  
Webcontrol, Signal Quality Monitoring [164](#)  
Webcontrol, Task Management [183](#)



5 Commonwealth Ave  
Woburn, MA 01801  
Phone 781-665-1400  
Toll Free 1-800-517-8431

 Visit us at [www.TestEquipmentDepot.com](http://www.TestEquipmentDepot.com)



---

**PROMAX TEST & MEASUREMENT**