

FRONT VIEW

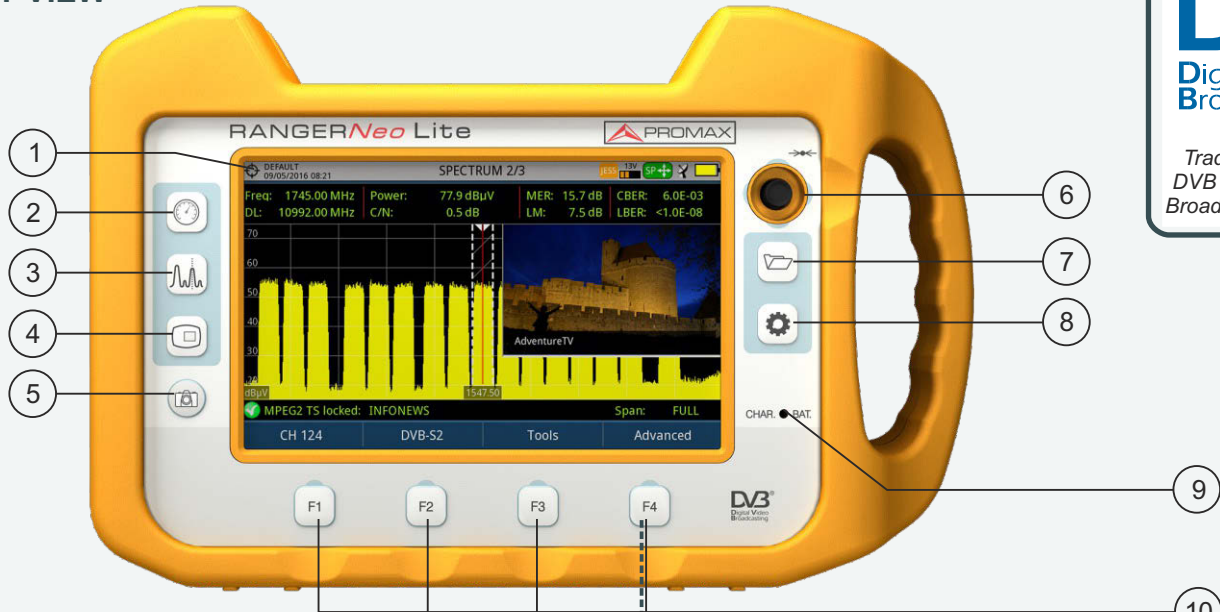

- | | |
|---|------------------------------------|
| ① TFT touch screen | ⑥ Joystick |
| ② Measurement key | ⑦ Installations management key |
| ③ Spectrum key | ⑧ Settings key |
| ④ TV Key | ⑨ Battery charging indicator |
| ⑤ Export (press>1s)
Reference (press<1s) | ⑩ Softkeys |
| | ⑪ Reset (press for 6s and release) |

SCREEN ICONS REFERENCE

STATUS BAR

- Battery charging**
- Battery not charging.** Yellow level indicates charge left
- USB** in serial port mode
- Satellite** band
- Current voltage, 22 kHz signal and **LNB** power level
- Terrestrial** band
- USB flash drive** inserted
- WiFi** signal source
- Current installation**
- Compressed installation**
- SatCR** (SCD/EN50494) commands enabled
- JESS** (SCD2/EN50607) commands enabled
- Joystick** multi-function enabled
Two-letter code indicates the exact function:
 - FR** Frequency tuning
 - CH** Channel tuning
 - SP** SPAN change
 - MK** Marker moving
 - EC** Echo change/zoom
 - AP** Access Point change

Task scheduled

SERVICE LIST SELECTOR

- Digital TV service**
- High Definition TV service**
- Digital radio**
- Data**
- Scrambled service**

DIALOG BOXES

- Error message**
- OK message**
- Question message**
- Warning message**

VIDEO & AUDIO SETTINGS MENU

- TFT backlight brightness
- Volume

ON: (<1s)

OFF: (2s)



RF ► SETTINGS

1

2 **Settings**

- Signal source: **RF** → WiFi
- Band: **Terrestrial** → Satellite

RF ► SCREENS

MEASUREMENT

1/3 FULL MEASUREMENT

Power:	69.2dBuV	Band:	82.3 dBuV
		LM:	14.1dB
Freq:	554.00 MHz	Power:	69.1 dBuV
Offset:	2 kHz	MER:	30.5 dB
		C/N:	34.7 dB
		CBER:	6.9E-05
		VBER:	1.8E-08

2/3 MEASUREMENT + TV + SPECTRUM

3/3 MEASUREMENT + PARAMETERS

DVB-T PARAMETERS			
Bandwidth:	8000 kHz	Spectral Inversion:	Off
FFT Mode:	8k	Guard Interval:	1/4
Constellation:	64QAM	Code Rate:	2/3
TS Hierarchy:	None		

SPECTRUM ANALYSER

1/3 SPECTRUM + MEASUREMENT

Freq:	554.00 MHz	Power:	69.1 dBuV	MER:	30.3 dB	CBER:	6.7E-05
		C/N:	36.2 dB	LM:	8.9 dB	VBER:	<1.0E-08

2/3 SPECTRUM + MEASUREMENT + TV

3/3 FULL SPECTRUM

TV MODE

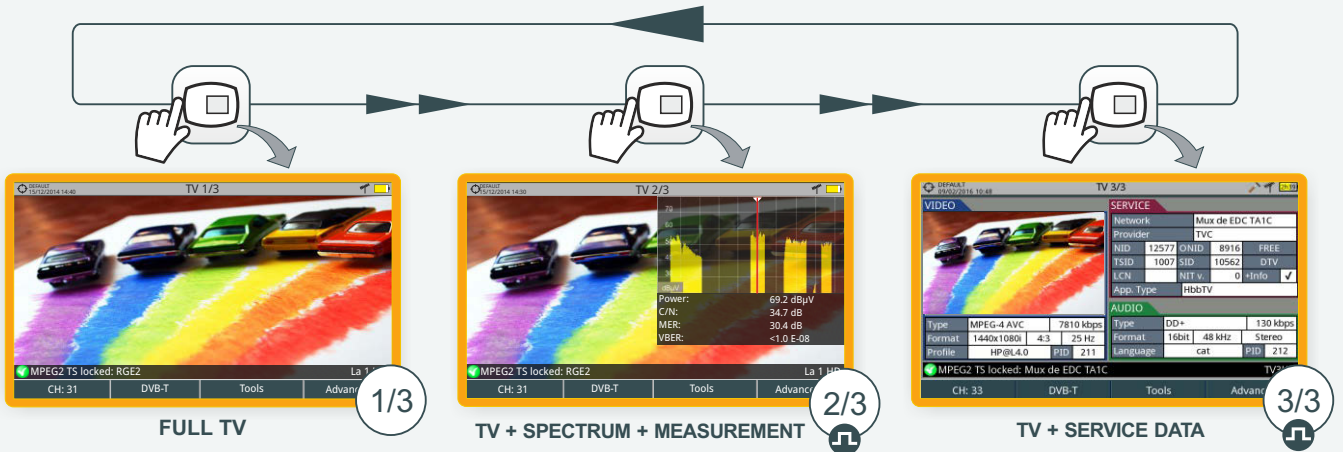

RF MENUS

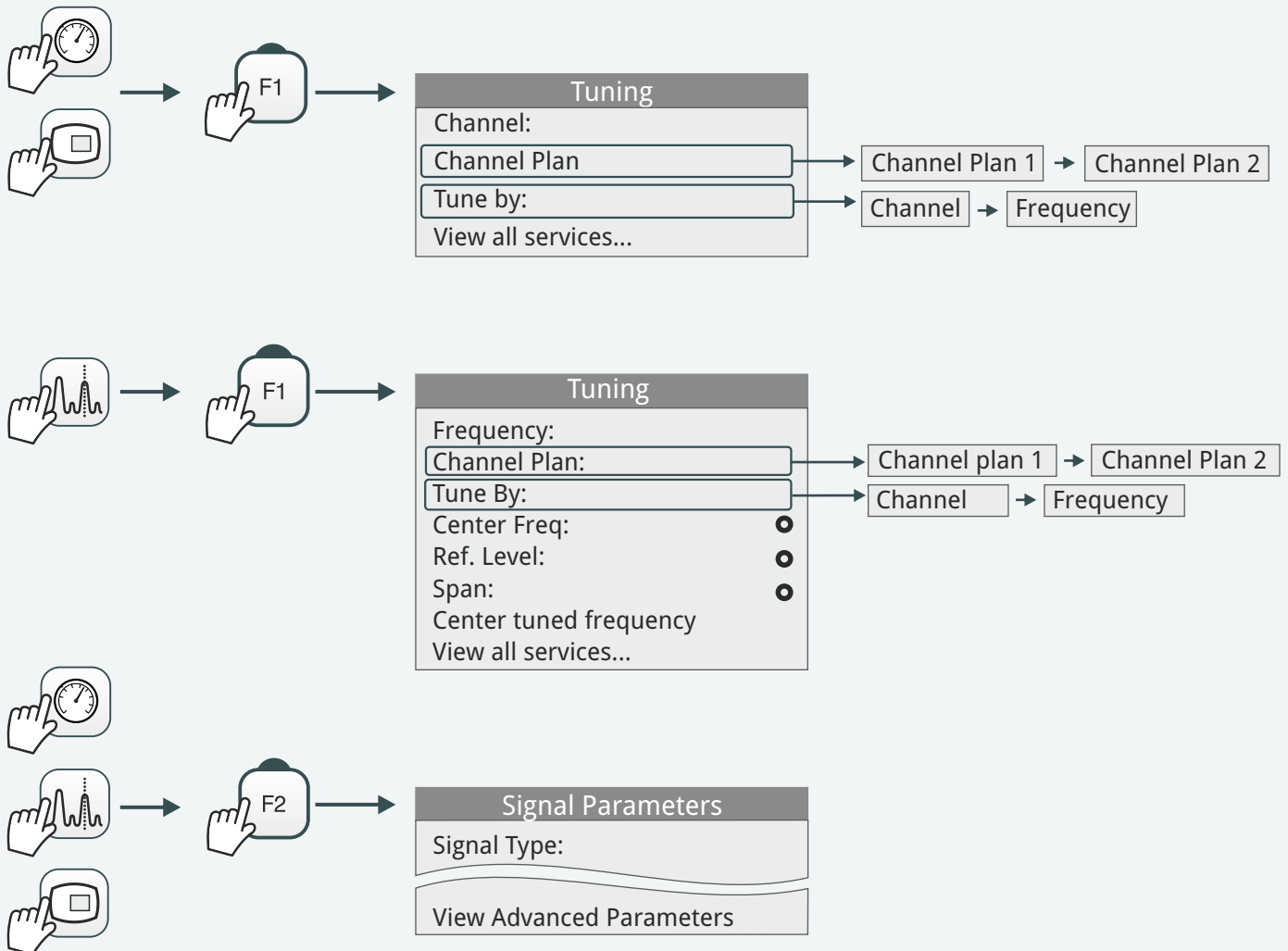

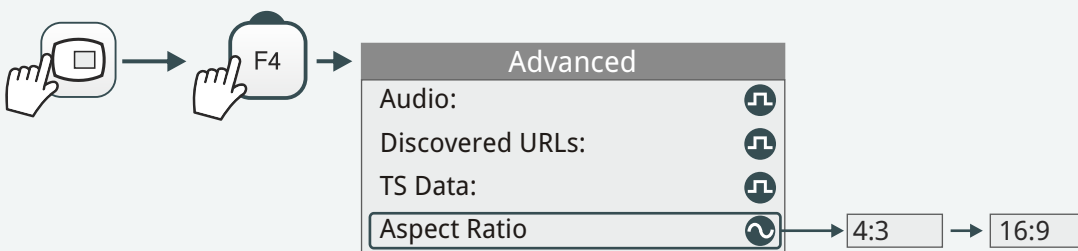
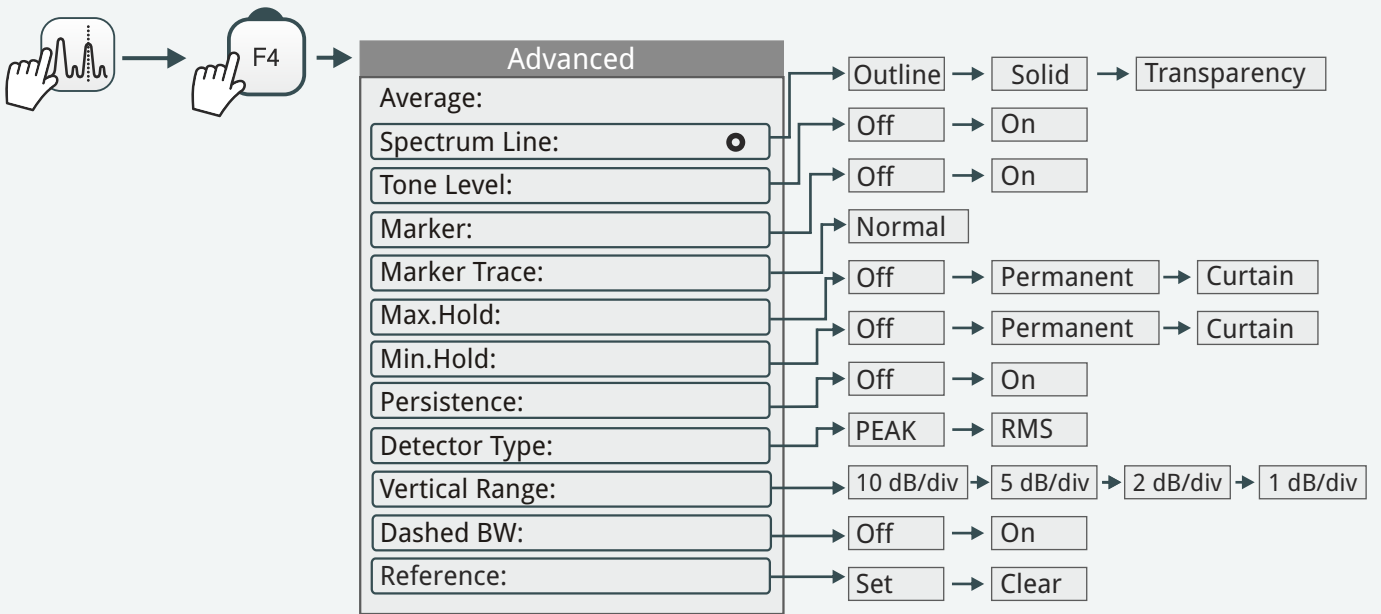
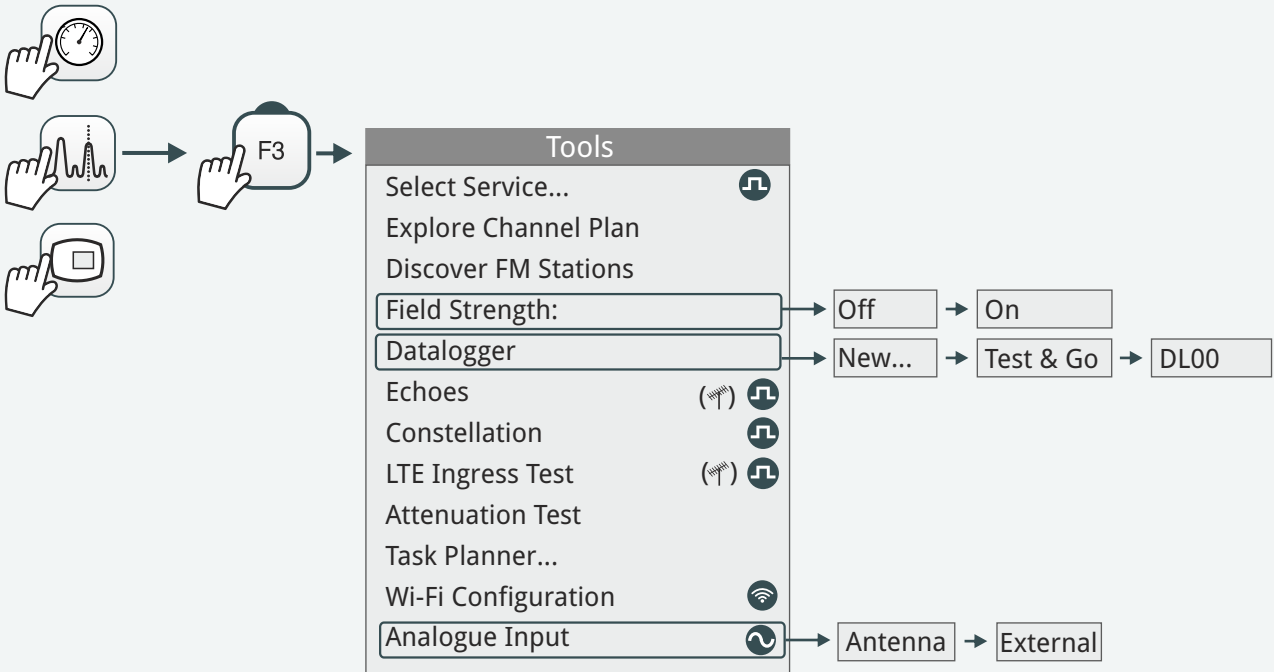

WIFI ► SETTINGS



WIFI ► SCREENS

► SITE SURVEY

PROMAX 22/12/2016 12:10		SITE SURVEY					
SSID	BSS	CH	RSSI(dBm)	Security	Device		
JAZZTEL	01:23:45:67:89:ab	1	-86	WPA	Wireless Router...		
MOVISTAR	aa:bb:cc:dd:ee:ff	2	-72	WPA2	WAP6969N		
YACOM	98:76:54:32:10:fe	3	-84	WPE			
YOIGO	a1:b2:c3:d4:e5:f6	4	-74	Ninguno			
ORANGE	22:44:66:88:ab:cd	5	-70	WPA			
VODAFONE	13:57:92:46:80:31	6	-88	WPA			
ARRAKIS	ca:ac:ed:de:fb:bf	7	-78	WPA			
TELEFONICA	57:26:21:44:a6:89	8	-76	WPA			
TERRA	11:85:e5:74:0c:53	9	-80	WPA			
WANADOO	b4:07:32:41:a6:1c	10	-82	WPA			

CH 1 Advanced



WIFI SPECTRUM

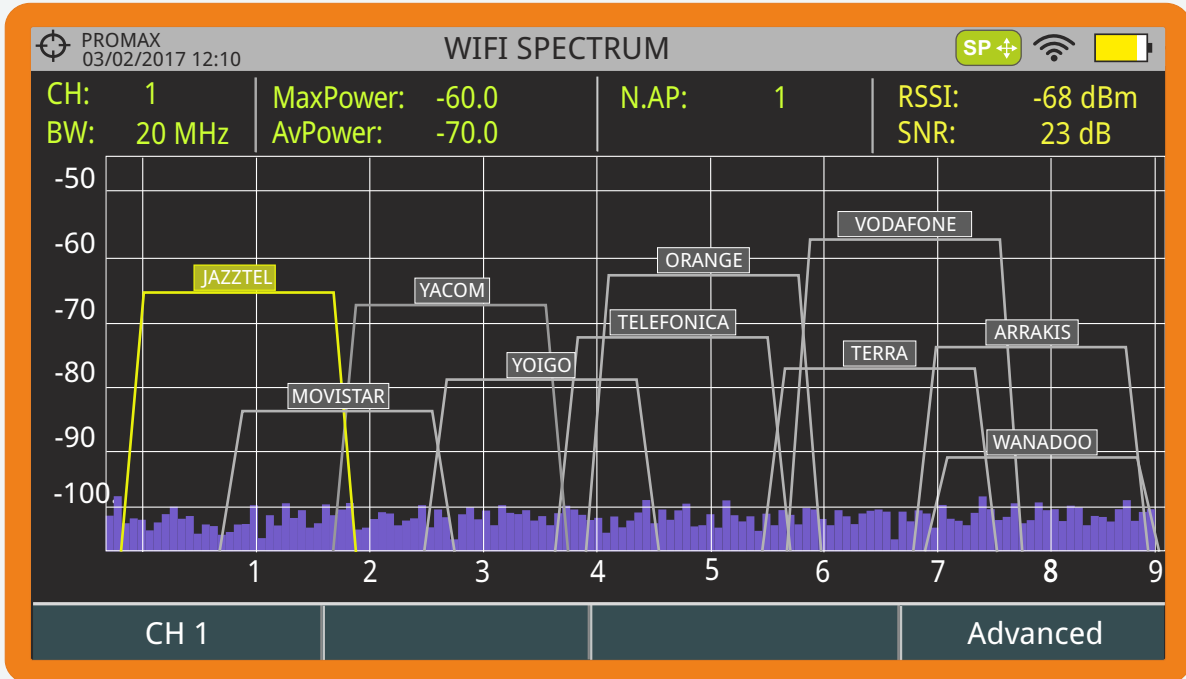

WIFI ► MENUS

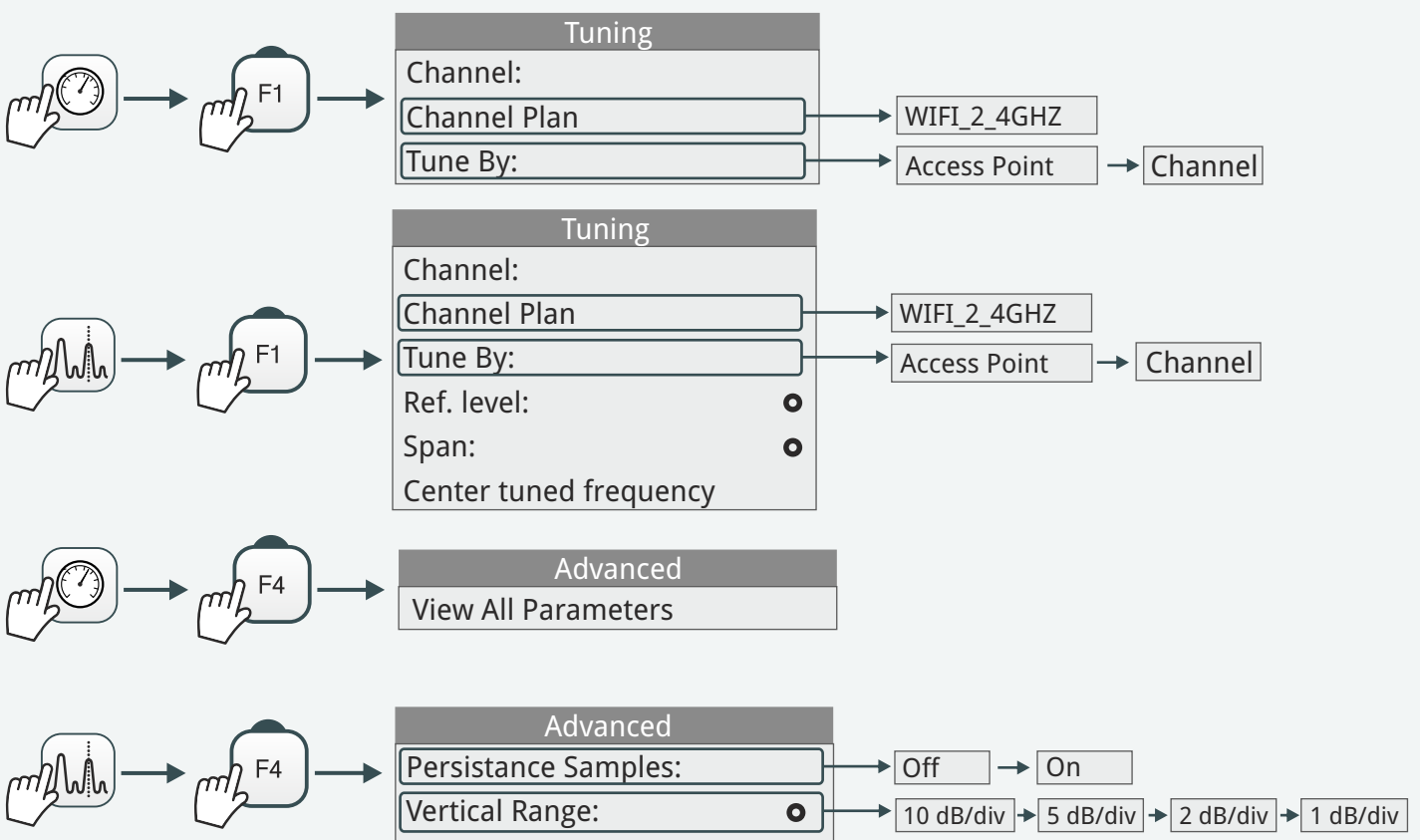



SETTINGS MENU

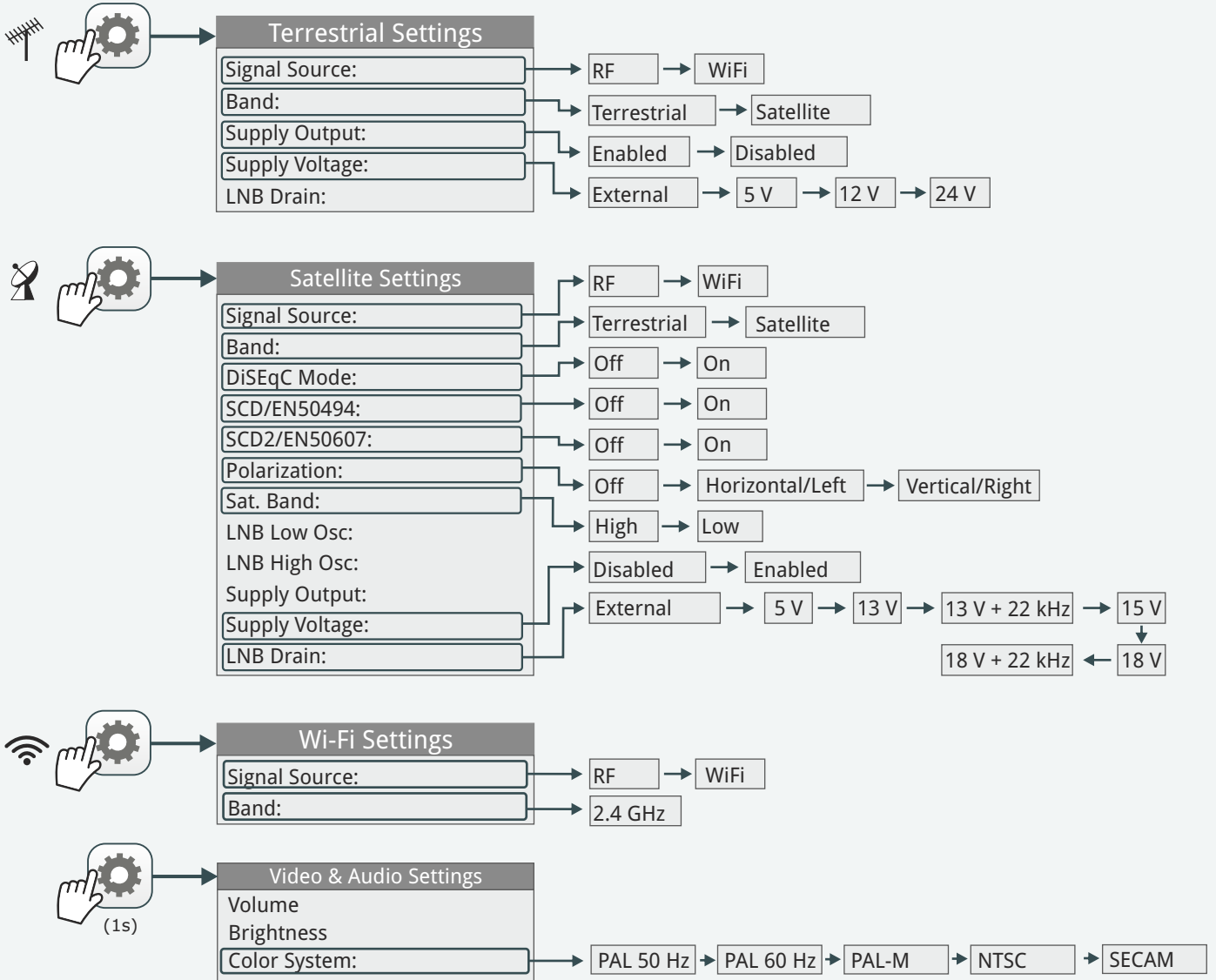

PREFERENCES MENU

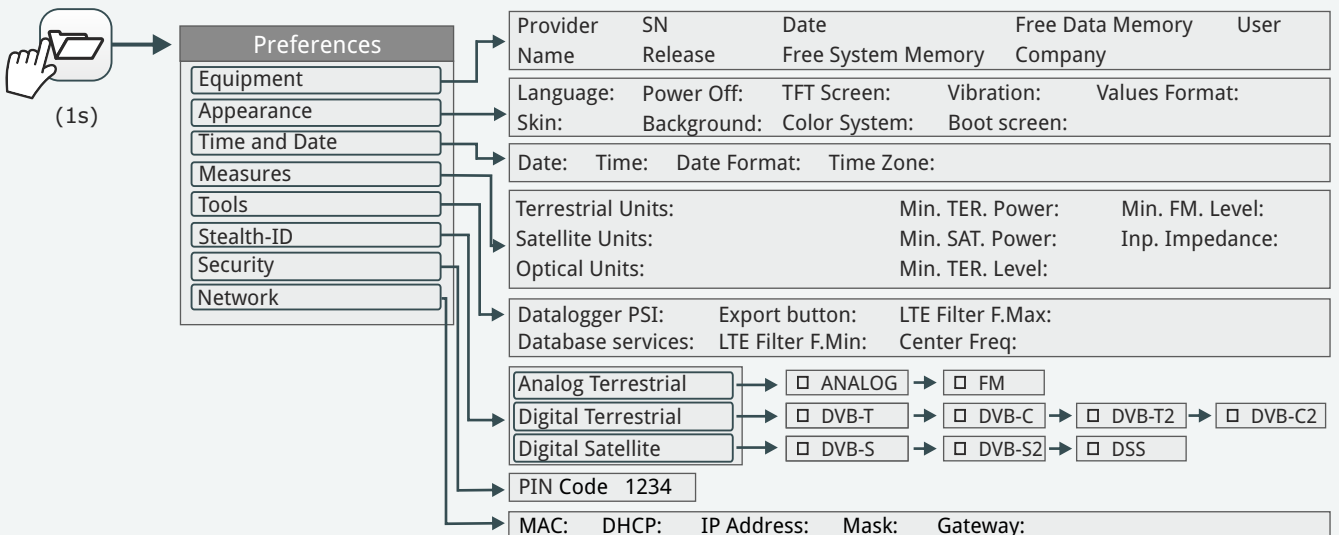

INSTALLATION MANAGEMENT

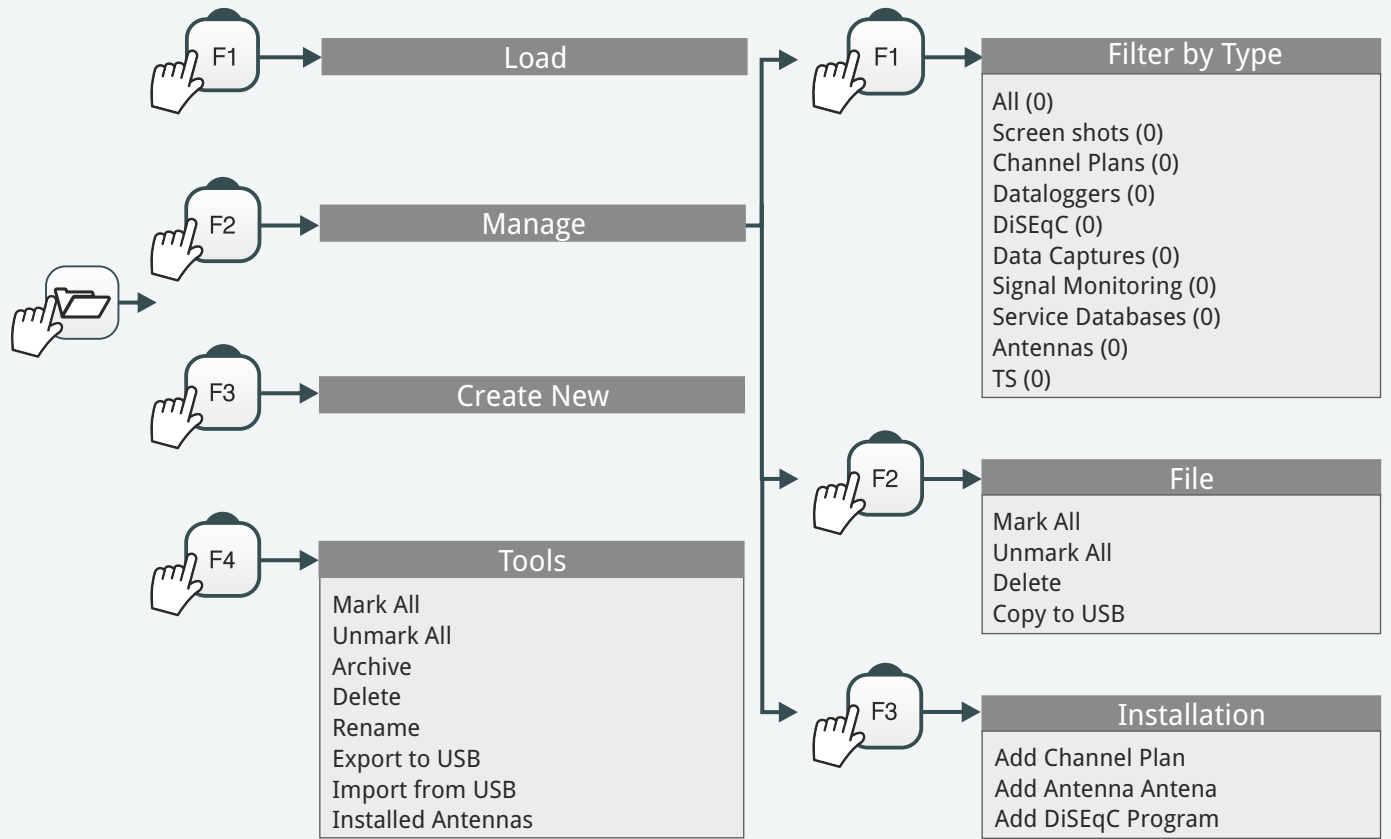

EXPORT* IMAGE / DATA / SPECTRUM

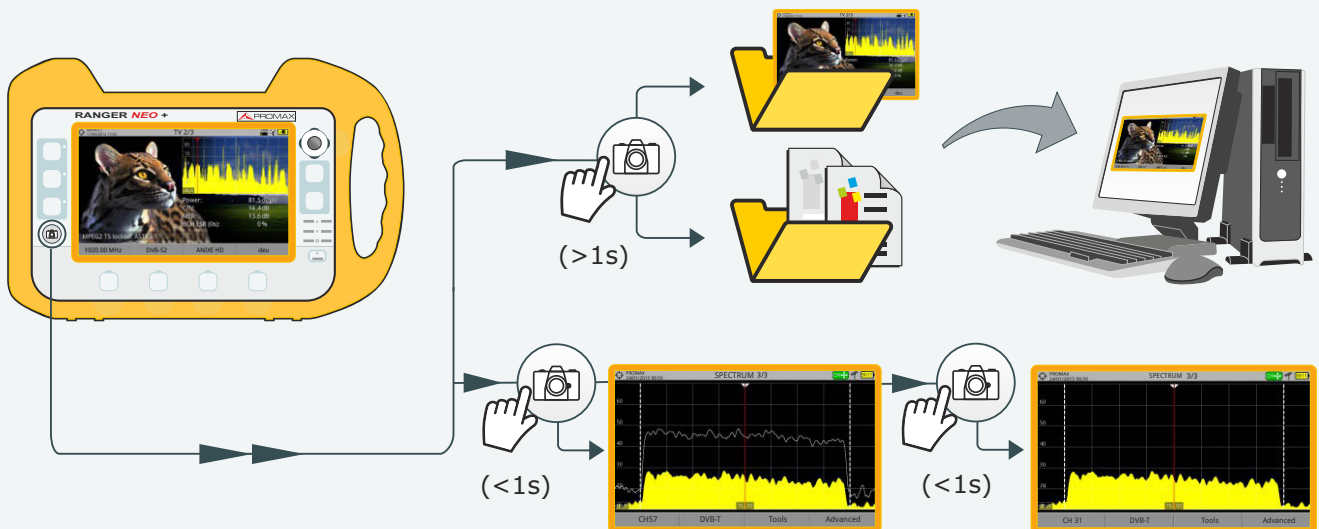

*Export settings in Preferences



▶ JOYSTICK

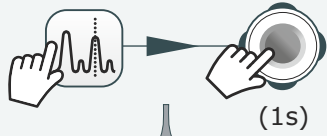

Joystick configuration

RefLevel+	RefLevel+
CH - ◀ CH +	Span - ◀ Span +
RefLevel-	RefLevel-

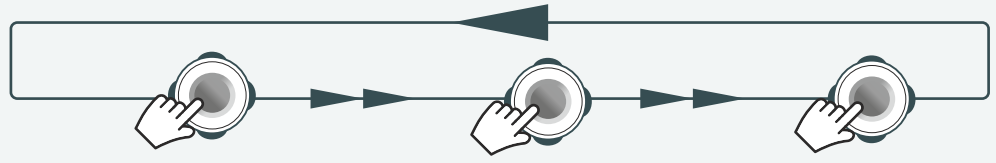

Access Point
change



Frequency
tuning



Channel
tuning



SPAN
Change



Marker moving
(Marker ON)

PARAMETER EDITION

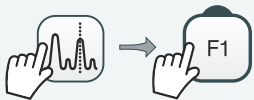

Tuning	
Channel:	44
Channel Plan	CCIR ▶
Tune By:	Channel ▶
Center Freq:	658.00 MHz ●



Tuning	
Channel:	44
Channel Plan	CCIR ▶
Tune By:	Channel ▶
Center Freq:	658.00 MHz ●

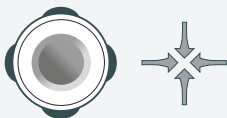

Tuning	
Channel:	44
Channel Plan	CCIR ▶
Tune By:	Channel ▶
Center Freq:	658.00 MHz ●



Tuning	
Channel:	44
Channel Plan	CCIR ▶
Tune By:	Channel ▶
Center Freq:	658.00 MHz ●



Tuning	
Channel:	44
Channel Plan	CCIR ▶
Tune By:	Channel ▶
Center Freq:	658.10 MHz ●

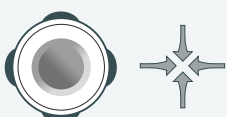

Tuning	
Channel:	44
Channel Plan	CCIR ▶
Tune By:	Channel ▶
Center Freq:	658.10 MHz ●

PARAMETER SELECTION

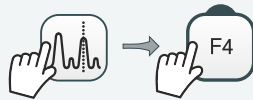

Advanced	
Average	0 ●
Spectrum Line	Outline ▾



Advanced	
Average	0 ●
Spectrum Line	Outline ▾

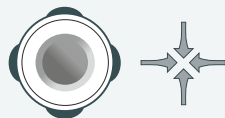

Advanced	
Average	0 ●
Spectrum Line	Outline ▾
	Outline
	Solid
	Trans.



Advanced	
Average	0 ●
Spectrum Line	Outline ▾
	Outline
	Solid
	Trans.

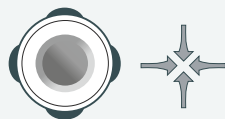

Advanced	
Average	0 ●
Spectrum Line	Solid ▾



TOUCH SCREEN

MENU SELECTION

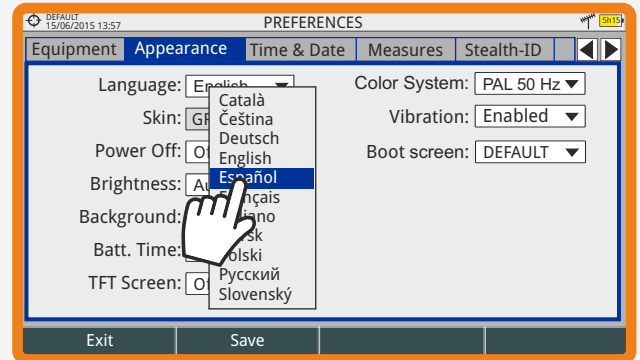
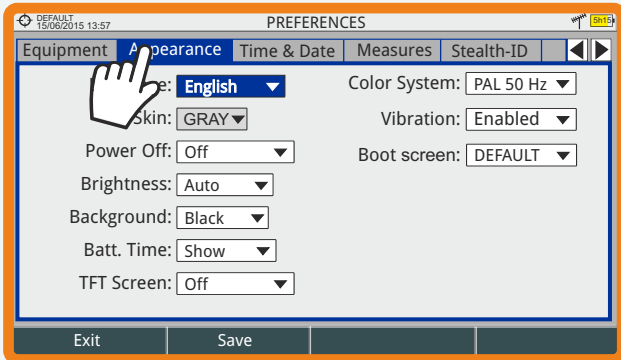

FREQUENCY SELECTION

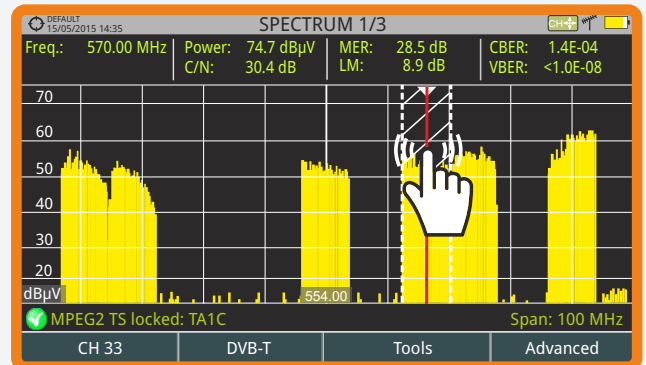
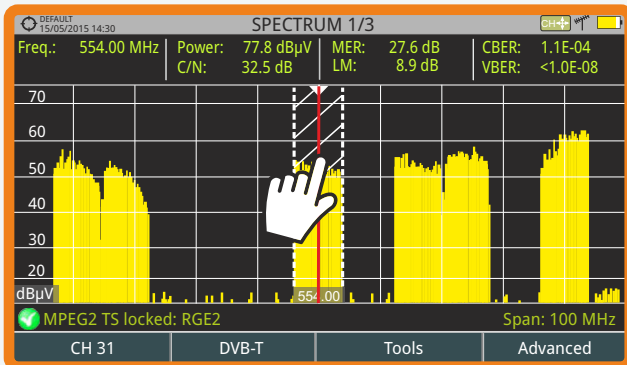

VIRTUAL KEYBOARD WRITING

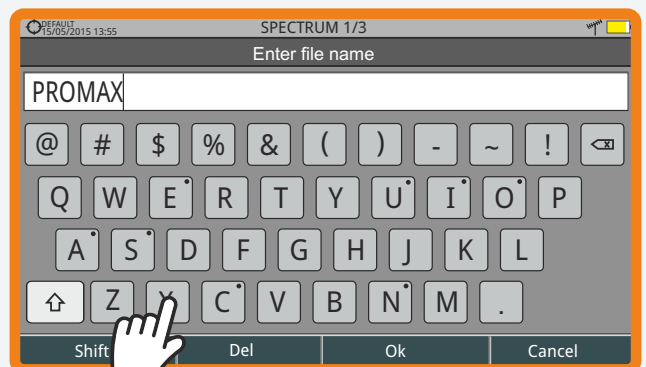
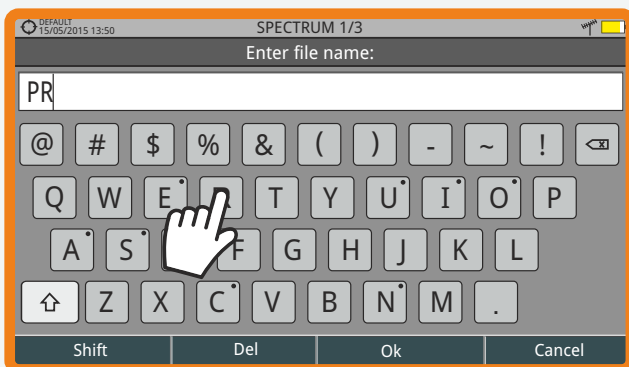

TOOLBAR

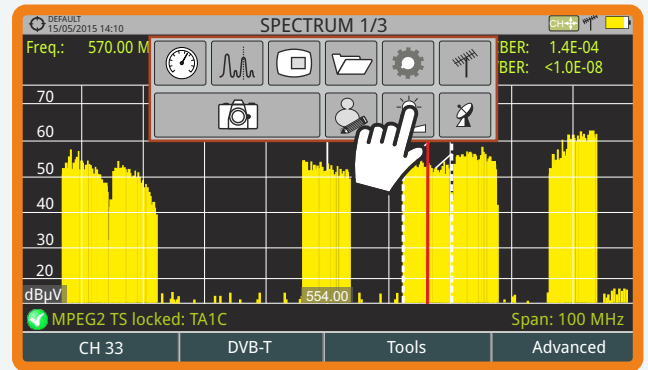
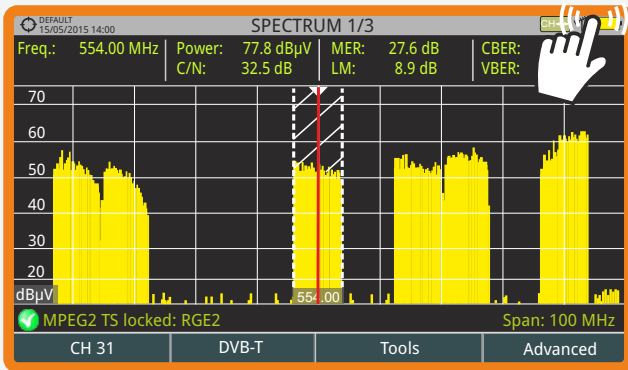

TOOLBAR ICONS

- Measurement Mode
- Spectrum Analyser Mode
- TV Mode
- Installations Management

- Settings
- Terrestrial Band
- Satellite Band

- Video & Audio Settings
- Preferences
- Screen Capture

MODE SCREENS

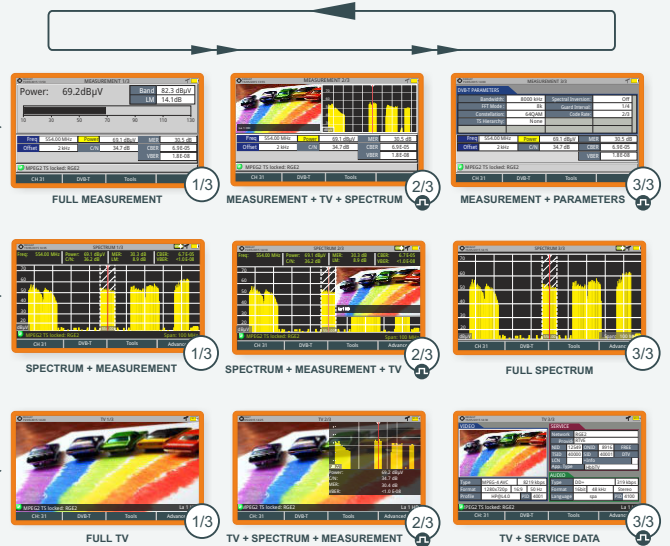
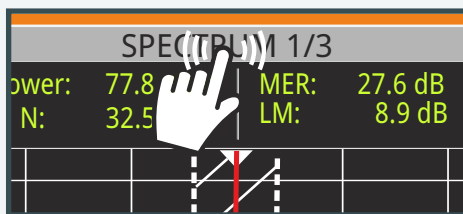

INSTALLATIONS MANAGEMENT

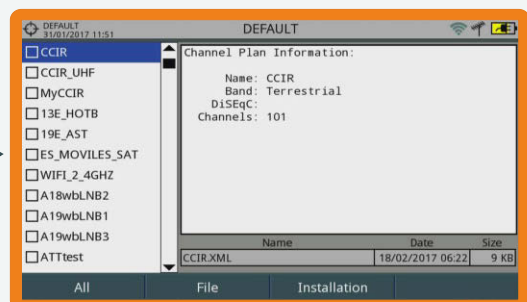
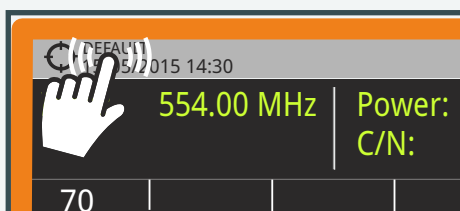

TOP VIEW

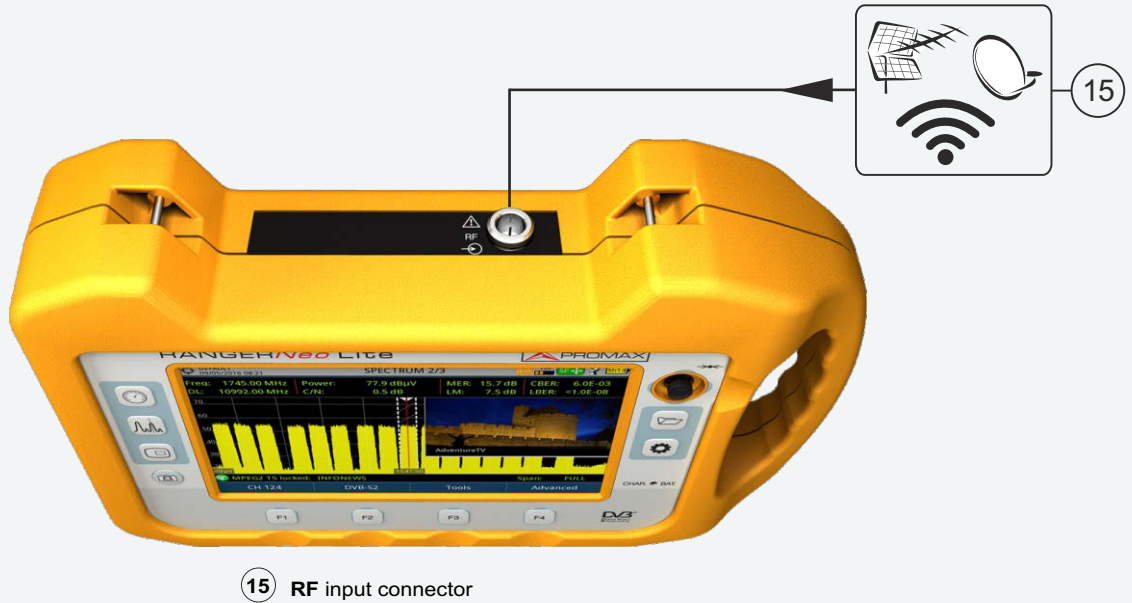

SIDE VIEW

- 16 Power input connector
- 17 ON/OFF button
- 18 Video/Audio input
- 19 HDMI output
- 20 USB connectors
- 21 ETHERNET connector for PC (NetUpdate)

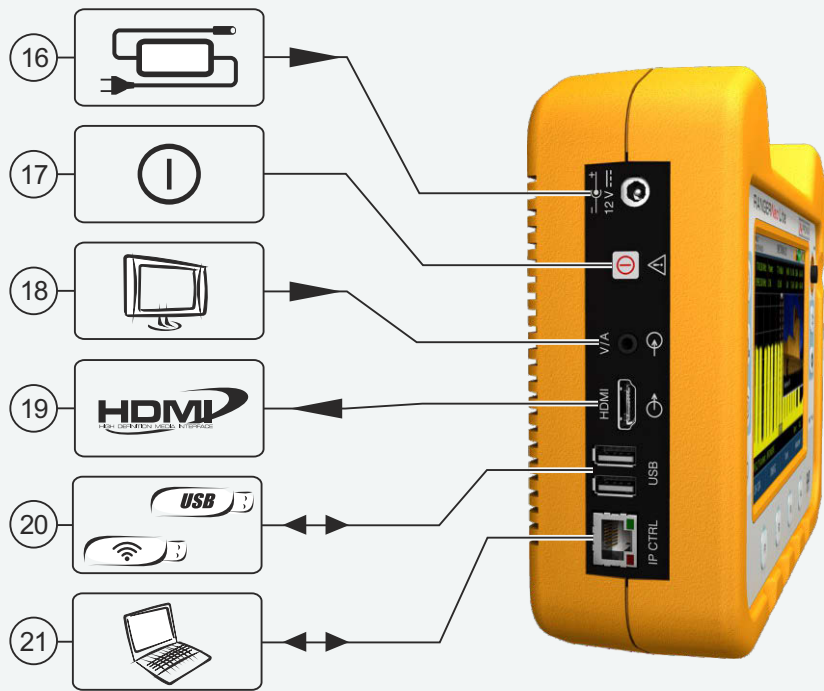

RESET

If the device crashes, press the ON/OFF button for 10 seconds. If the device does not respond then press the F4 key for 6 seconds and then release to reset (see user's manual for more information).

