

# ROBINAIR®

## Refrigerant Recovery Machine



### Model No. RG6

### Operating Manual

# SAFETY PRECAUTIONS



**WARNING : TO PREVENT PERSONAL INJURY AND / OR EQUIPMENT DAMAGE,**



**ALLOW ONLY QUALIFIED PERSONNEL TO OPERATE THIS UNIT.** Before operating the unit, read and follow the instructions and warnings in this manual. The operator must be familiar with air conditioning and refrigeration systems, refrigerants, and the dangers of pressurized components. If the operator cannot read this manual, operating instructions and safety precautions must be read and discussed in the operator's native language.



**PRESSURIZED TANK CONTAINS LIQUID REFRIGERANT.** Do not overfill storage vessels, because overfilling may cause explosion and personal injury or death. Do not recover refrigerants into nonrefillable containers; use only federally authorized refillable containers (DOT spec. 4BW or 4BA).



**HOSES MAY CONTAIN LIQUID REFRIGERANT UNDER PRESSURE.** Contact with refrigerant may cause personal injury. Wear protective equipment, including safety goggles and protective gloves. Disconnect hoses using extreme caution.



**AVOID BREATHING A/C REFRIGERANT AND LUBRICANT VAPOR OR MIST.** Exposure may irritate eyes, nose, and throat. To remove refrigerant from the A/C system, use only equipment certified for the type of refrigerant being removed. Use the unit in locations with mechanical ventilation that provides at least four air changes per hour. If accidental system discharge occurs, ventilate the work area before resuming service.



**TO REDUCE THE RISK OF FIRE, USE THE SHORTEST POSSIBLE EXTENSION CORD WITH A MINIMUM SIZE OF 14 AWG.** Using an undersized extension cord may result in electrical equipment failure.

**TO REDUCE THE RISK OF FIRE,** do not use the unit in the vicinity of spilled or open containers of gasoline or other flammable substances.



**CAUTION – DO NOT PRESSURE TEST OR LEAK TEST EQUIPMENT OR VEHICLE AIR CONDITIONING SYSTEMS WITH COMPRESSED AIR.** Some mixtures of air and refrigerant have been shown to be combustible at elevated pressures. These mixtures, if ignited, may cause injury or property damage.



**DO NOT MIX REFRIGERANT TYPES THROUGH A SYSTEM OR IN THE SAME CONTAINER.** Mixing of refrigerants causes severe damage to the unit and the system being serviced.



**HIGH VOLTAGE ELECTRICITY INSIDE THE UNIT HAS A RISK OF ELECTRICAL SHOCK.** Exposure may cause personal injury. Disconnect power before servicing the unit.

**Additional health and safety information may be obtained from refrigerant and lubricant manufacturers.**

---

## EXPLANATION OF SAFETY SIGNAL WORDS



**WARNING :** Indicates a potentially hazardous situation which, if not avoided, could result in death or serious injury.



**CAUTION :** Indicates a potentially hazardous situation which, if not avoided, may result in minor or moderate injury.

**CAUTION :** Used without the safety alert symbol indicates a potentially hazardous situation which, if not avoided, may result in property damage.

# TABLE OF CONTENTS

Safety Precautions . . . . .	.2
Explanation of Safety Signal Words . . . . .	.2
Understanding Refrigerant Recovery . . . . .	.4
Standard Operating Instructions . . . . .	.5
<i>Setup</i> . . . . .	.5
<i>Recovery Procedure</i> . . . . .	.6
<i>Purge the Unit.</i> . . . . .	.6
Operating Instructions for Bulk Liquid Systems . . . . .	.7
<i>Push – Pull Procedure</i> . . . . .	.7
<i>Liquid Recovery.</i> . . . . .	.7
<i>Vapor Recovery.</i> . . . . .	.8
Purge Non-Condensable Gas from a Storage Cylinder . . . . .	.8
Recovery Cylinder Information. . . . .	.9
Troubleshooting . . . . .	10
Replacement Parts. . . . .	11
Rebuild Kits and Accessories . . . . .	12
Maintenance . . . . .	13
<i>Installation of the Filter and Filter / Drier</i> . . . . .	13
<i>Burned-out System</i> . . . . .	13
<i>Storage</i> . . . . .	13
German. . . . .	15
Spanish. . . . .	29
French . . . . .	43
Warranty Statement . . . . .	Inside Back Cover

# UNDERSTANDING REFRIGERANT RECOVERY

*NOTE: Throughout this operating manual the term “unit” is used when referring to all models of RG6 refrigerant recovery machines.*

Refrigerant recovery is the process of taking refrigerant out of a system and storing it in a cylinder. The following information is critical to achieving the best refrigerant recovery results.

## Refrigerant

Identify the refrigerant type and quantity in the system to be serviced.

The unit is approved for use with the following category III, IV, and V refrigerants (per ARI-740) :

R-12, R-22, R-134a, R-401a, R-401b, R-401c, R-402a, R-402b, R-404a, R-406a, R-407a, R-407b, R-407c, R-407d, R-408a, R-409a, R-410a, R-411a, R-411b, R-412a, R-500, R-502, R-507 R-509

## Filters and Filter / Driers

**CAUTION : Filters prevent contamination from entering the unit, which reduces the risk of damage to the unit and the system being serviced.**

The unit is shipped with a filter screen installed behind the inlet fitting. Robinair strongly recommends that a clean filter screen be used for every service job. Failure to use a filter screen will invalidate your warranty.

Robinair also strongly recommends using a filter / drier (Part No. 100343; not provided) at the inlet fitting. Each in-line filter / drier must be labeled and used for only one type of refrigerant.

## Valves

**⚠ WARNING : To prevent personal injury, open service and cylinder valves SLOWLY to allow rapid shut-off of gas flow if necessary. Once it is determined there is no danger, the valves may be opened fully.**

Isolate large amounts of refrigerant and close valves after use, so if a leak should develop anywhere in the system, refrigerant will not escape to the atmosphere.

## Storage Cylinders

**⚠ WARNING : A storage cylinder is full when it reaches 80% volume. DO NOT OVERFILL. Due to liquid expansion, the cylinder could explode if filled to more than 80% volume, possibly causing personal injury and equipment damage. Use a scale, such as the TIF9010A, to avoid overfilling the storage cylinder.**

Robinair recommends using the optional 80% Capacity Shutoff Kit (p/n SK-5001) with this unit. After the kit is installed and used with a recovery cylinder having an

internal float switch, the unit automatically shuts down when the cylinder is 80% full. (Your unit is pre-wired at the factory for this kit.)

## Hoses

Hoses must be equipped with low-loss fittings and have pressure ratings appropriate for the refrigerant in the system being serviced.

## Shut-off Switch

This unit has an internal, high-pressure, shut-off switch. If system pressure rises above 550 psi, the unit shuts off. The shut-off switch automatically resets itself after pressure drops below 400 psi.

**⚠ WARNING : The internal pressure shut-off switch does NOT prevent cylinder overfill. If the system shuts off automatically and is connected to a cylinder, the cylinder may be dangerously overfilled. Take immediate measures to relieve the high pressure and / or cylinder overfill situation, or personal injury may result.**

## Push / Pull Procedure

When recovering large amounts of liquid (over 15 lbs.), use the Push / Pull method described in this manual.

## Maximum Vacuum and Recovery Rates

To achieve the deepest final vacuum, use an evacuated recovery cylinder. To maximize recovery rates :

- Use the shortest possible length of 3/8 in. or larger hose. (A hose no longer than 3 feet is recommended.)
- Remove unnecessary hose core depressors, and remove Schrader valves from port connections. Deformed rubber seals and core depressors in hoses, as well as faulty or unnecessary Schrader valves, can restrict flow.
- If you are certain the refrigerant in the system being serviced is clean or new, the filter screen may be removed from the inlet fitting.
- Purge the unit during the end of the vapor recovery phase, especially when recovering large amounts of vapor. Purge again after the recovery process is complete and the desired vacuum has been achieved. Refer to “Purge the Unit” at the end of the *Standard Operating Instructions* section of this operating manual.

## Maintenance

**CAUTION : Keep all connections to the refrigeration system dry and clean. Damage will occur if moisture is allowed to enter the system.**

# STANDARD OPERATING INSTRUCTIONS

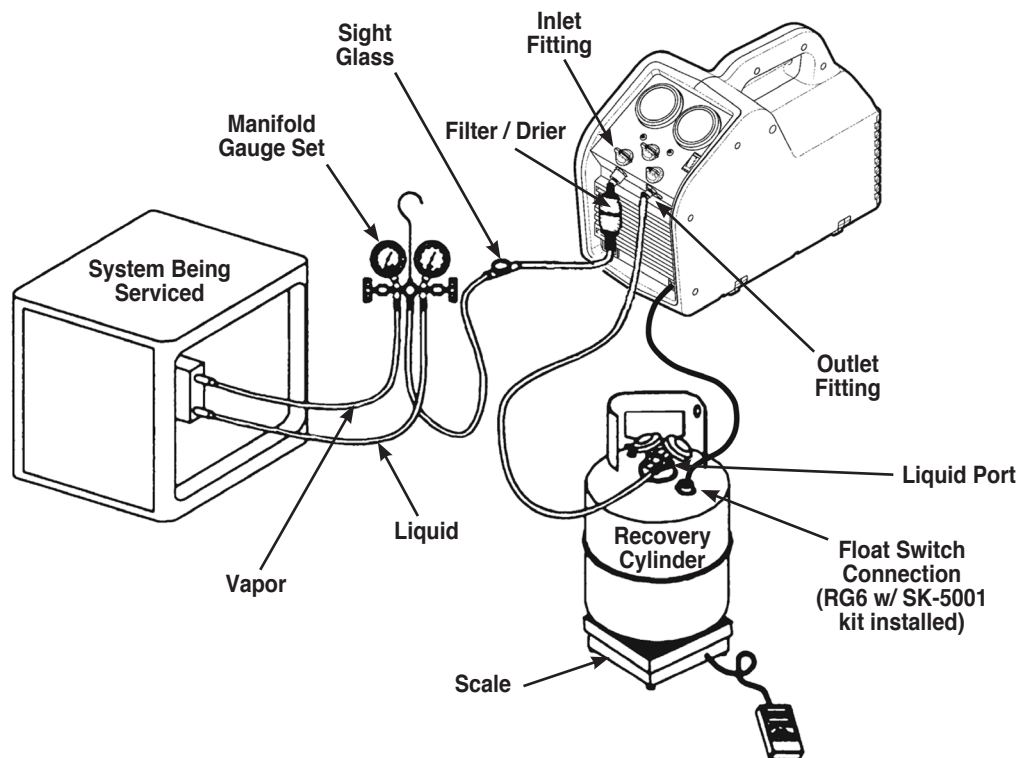

The following instructions are for a standard or “common” recovery procedure.

## Setup Procedure

1. Place the unit on a flat, level surface.
  2. Verify a clean filter screen is installed behind the inlet fitting.
  3. Connect a hose from the outlet fitting of the unit to the liquid port on the recovery cylinder.
  4. Connect a hose from the inlet fitting of the unit to the output port of a manifold gauge set. Robinair recommends using a sight glass and a filter / drier in this line.
  5. Connect a hose from the liquid (low pressure) side of the manifold gauge set to the liquid side of the system being serviced.
  6. Connect a hose from the vapor (high) side of the manifold gauge set to the vapor side of the system being serviced.
- RG6 with SK-5001 kit installed:** Attach tank connection harness (No. 549977) to float switch connection on the recovery cylinder.
7. Verify the inlet and outlet valves on the unit are closed.
  8. Place the recovery cylinder on a scale (such as TIF9010A) to avoid overfilling the cylinder.

**⚠ WARNING :** A storage cylinder is full when it reaches 80% volume. **DO NOT OVERFILL.** Due to liquid expansion, the cylinder could explode if filled to more than 80% volume, possibly causing personal injury and equipment damage.

## Tech Tips

The unit will perform at its peak when voltage entering the machine (while operating) is between 115–122 VAC.

Lower supply voltages may result in difficulty starting under high head pressure, reduced performance, and / or motor overheating.

Use an outlet that does not have other appliances (such as lights, machines, etc.) plugged into it.

Do not use an extension cord unless needed. If an extension cord is used, it must be 14 AWG minimum and as short as possible to reduce voltage drops.

# STANDARD OPERATING INSTRUCTIONS

## Recovery Procedure

1. Connect the unit to an appropriate 115 V outlet.
2. Slowly open the liquid valve of the recovery cylinder while watching hoses and connections for leaks.
3. Set the recover / purge valve on the unit to RECOVER.
4. Open the liquid valve on the manifold gauge set.  
*Note: Opening the liquid valve removes liquid from the system first, greatly reducing recovery time.*
5. Open the outlet valve on the unit.
6. Toggle the power switch to the ON position.
7. Slowly open the inlet valve on the unit. Note: If the unit begins to “knock”, slowly throttle back (close) the inlet valve until the noise stops.
8. Once the liquid has been removed from the system, open the vapor valve on the manifold gauge set to finish evacuating the system.
9. Run the unit until the desired vacuum is achieved.
10. Close the vapor and liquid valves on the manifold gauge set.
11. Turn the inlet valve on the unit to the CLOSED position.
12. Toggle the power switch OFF.

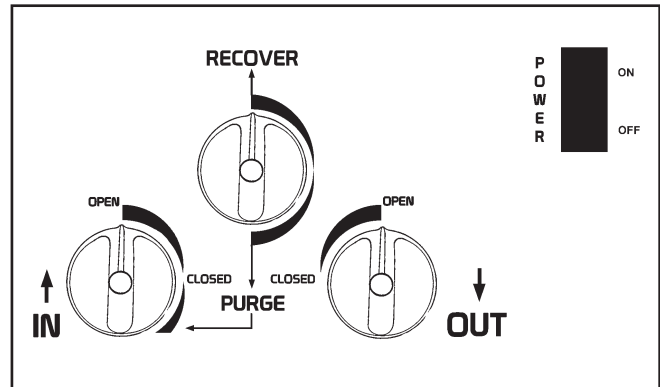

## Purge the Unit

**CAUTION : Purge the unit after a recovery procedure. Failure to purge the remaining refrigerant from the unit could result in acidic degradation of internal components, ultimately causing premature failure of the unit.**

1. Verify the liquid and vapor valves on manifold gauge set are closed (if applicable).
2. Close the valves on the system being serviced (if applicable).
3. Verify the outlet valve on the unit is open and the inlet valve is closed.
4. Verify the liquid valve on the recovery cylinder is open.
5. Turn the recover / purge valve to the PURGE position.
6. Toggle the power switch ON.
7. Slowly turn the inlet valve toward the PURGE position. As the inlet side pressure decreases, open the valve to the full purge position.
8. Run the unit until the desired vacuum is achieved.
9. Close the inlet and outlet valves on the unit.
10. Toggle the power switch OFF.
11. Close the ports on the recovery cylinder.
12. Turn the recover / purge valve to the RECOVER position.
13. Disconnect all accessories and replace the in-line filter.



### Tech Tip

If you have trouble starting or re-starting the unit due to high head pressure, first close the inlet valve. Then slowly turn the inlet valve toward the purge position until the inlet pressure rises. Close the inlet valve again and re-start the unit.



# OPERATING INSTRUCTIONS FOR BULK LIQUID SYSTEMS

## “Push – Pull” Procedure

The push – pull method removes bulk liquid from a system using the pressure differential created by the unit. This method works only with large systems where the liquid is readily accessible; it may not work on systems that contain less than 15 lbs. (6.8 kg) bulk liquid.

This method is used :

- on systems with receiver cylinders.
- on systems containing more than 20 lbs. (9.1 kg) of refrigerant.
- when transferring bulk liquid refrigerant from one cylinder to another.

## Liquid Recovery

1. Place the unit on a flat, level surface.
2. Connect a hose from the outlet fitting of the unit to the vapor port on the system being serviced.
3. Connect a hose from the inlet fitting of the unit to the vapor port of a recovery cylinder. Robinair recommends using a filter / drier in this line.
4. Connect a hose from the liquid side of the recovery cylinder to the liquid port of the system being serviced. Robinair recommends using a sight glass in this line as a method of determining when the liquid has been removed.
5. Place the recovery cylinder on a scale (such as TIF9010A) to avoid overfilling the cylinder.
6. Verify inlet and outlet valves on unit are closed.
7. Turn the recover / purge knob to RECOVER.
8. Open the recovery cylinder valves.
9. Open the outlet valve on the unit.
10. Toggle the power switch ON.
11. SLOWLY open the inlet valve on the unit.
12. When the weight reading on the scale stops increasing, close the inlet valve on the unit first; then close the liquid valve on the recovery cylinder.
13. Toggle the power switch OFF.
14. Close the valves on the recovery cylinder, and close the outlet valve on the unit.
15. Proceed to *Vapor Recovery*.

**RG6 with SK-5001 kit installed:** Attach tank connection harness (No. 549977) to float switch connection on the recovery cylinder.

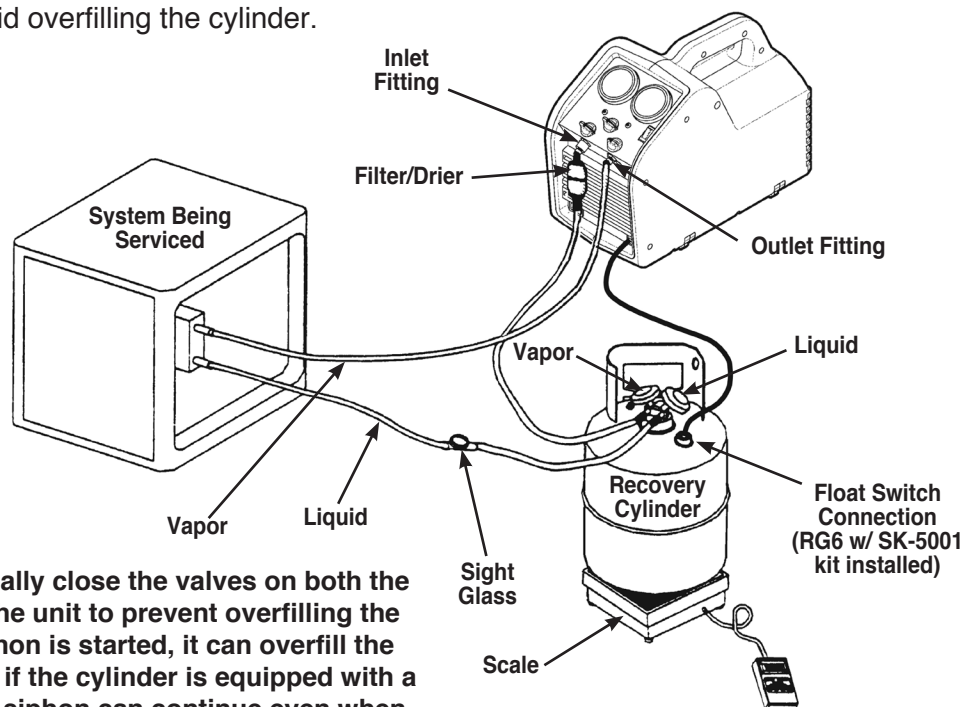

**⚠ WARNING :** Manually close the valves on both the storage cylinder and the unit to prevent overfilling the cylinder. Once the siphon is started, it can overfill the storage cylinder, even if the cylinder is equipped with a float level sensor. The siphon can continue even when the unit is turned off.

# OPERATING INSTRUCTIONS FOR BULK LIQUID SYSTEMS

## Vapor Recovery

1. Place the unit on a flat, level surface.
2. Connect a hose from the inlet side of the unit to the liquid port of the system being serviced.
3. Connect a hose from the outlet side of the unit to the liquid port on a recovery cylinder.

**CAUTION: The recovery cylinder should be on a scale to avoid overfilling the cylinder.**

4. Open the liquid valve on the recovery cylinder.
5. Turn the recover / purge knob to RECOVER.
6. Open the outlet valve on the unit.
7. Toggle the power switch ON.
8. Slowly open the inlet valve on the unit.
9. Run the unit until the desired vacuum is achieved.
10. Close the inlet and outlet valves on the unit.
11. Toggle the power switch OFF.
12. Close the ports on the recovery cylinder.



### Tech Tip

For a faster recovery procedure, recover from both the liquid and vapor ports of the system being serviced by using a tee fitting or manifold gauge set in the hose setup.

## PURGE NON-CONDENSABLE GAS FROM A STORAGE CYLINDER

1. Allow the storage cylinder to sit undisturbed for 24 hours to allow air to rise to the top.
2. Connect a manifold gauge set to the cylinder. Read the amount of pressure in the cylinder as indicated by the output pressure gauge.
3. Determine the ambient temperature in the room.
4. Refer to a refrigerant pressure/temperature chart and find the ambient temperature. Read across the chart to the corresponding pressure for the type of refrigerant in the cylinder. Determine how that relates to the reading on the gauge.
5. If the pressure reading in the cylinder is higher than the pressure shown on the chart, **VERY SLOWLY** crack open the vapor port valve. (This is done slowly to cause as little turbulence inside the cylinder as possible.)  
Watch the pressure on the gauge decrease. To prevent venting, add 4–5 psi (0.26–0.34 bar) to the pressure shown on the chart. When the gauge corresponds to that pressure, close the vapor port valve.
6. Allow the cylinder to sit for 10 minutes and then check pressure again.
7. Repeat the process, if necessary.



# RECOVERY CYLINDER INFORMATION

## Type of Cylinder

Use only authorized, refillable, refrigerant storage cylinders. Federal regulations require refrigerant to be transported only in containers meeting DOT specs. 4BW or 4BA.

NEVER use a standard disposable 30 lb. (13.6 kg) cylinder (the type of container in which new refrigerant is sold) to recover refrigerant.

## Working Pressure

Recovery cylinders are designed for different working pressures. Robinair strongly recommends the use of 400 psi (27.6 bar) cylinders.

**⚠ WARNING: To prevent personal injury, do not exceed the rated working pressure of the cylinder. At minimum, the RG6 requires the use of a 350 psi (24.1 bar) recovery cylinder.**

*NOTE: The use of a 400 psi (27.6 bar) cylinder is mandatory when recovering R-410A refrigerant. Refer to the Parts and Accessories section of this manual for more information.*

If you expect temperatures in excess of 135° F (57° C), consult the refrigerant supplier.

## Capacity

Safety codes state that closed cylinders should not be filled with liquid over 80% of volume. (The remaining 20% is called head pressure room.)

Do not exceed 80% of cylinder capacity. Robinair recommends the use of the TIF9010A Refrigerant Scale for monitoring cylinder capacity.

## Refrigerants

Cylinders and filter / driers should each be designated for only one type of refrigerant.

If you must use a cylinder previously used for a different refrigerant, prepare the cylinder by completely emptying it, perform an evacuation, purge it using dry nitrogen, and then perform another evacuation.





## Storage

Store refrigerant cylinders in a cool, dry place.

## Leakage

Some cylinders have valves that were not correctly seated when manufactured. Keeping caps on the valves will guard against refrigerant leakage.

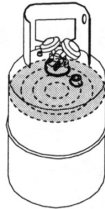
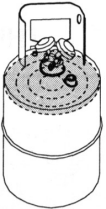
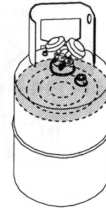
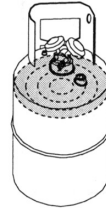
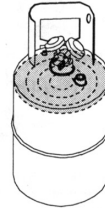
**⚠ WARNING : To prevent personal injury, never transport an overfilled cylinder. Refrigerant expands when it gets warm and may cause an overfilled cylinder to explode.**

Storage Cylinder Temperature	60°F 15.6°C	70°F 21.1°C	100°F 37.8°C	130°F 54.4°C	150°F 65.6°C
<b>STARTING WITH CYLINDER 80% BY VOLUME</b>					
<b>Space Occupied by Liquid</b>	<b>80%</b>	<b>81%</b>	<b>83%</b>	<b>90%</b>	<b>94%</b>
<b>STARTING WITH CYLINDER 90% BY VOLUME</b>					
<b>Space Occupied by Liquid</b>	<b>90%</b>	<b>92%</b>	<b>96%</b>	<b>100%</b>	

# TROUBLESHOOTING



**WARNING: TO PREVENT PERSONAL INJURY AND / OR EQUIPMENT DAMAGE,**



**ALLOW ONLY QUALIFIED PERSONNEL TO OPERATE AND REPAIR THIS UNIT.** Before operating or repairing the unit, read and follow the instructions and warnings in this manual. The technician must be familiar with air conditioning and refrigeration systems, refrigerants, and the dangers of pressurized components. If the technician cannot read this manual, operating instructions and safety precautions must be read and discussed in the technician's native language.

<b>Symptom</b>	<b>Possible Cause</b>	<b>Possible Solution</b>
<b>Unit will not turn on</b>	<ol style="list-style-type: none"> <li>1. Power cord not plugged in.</li> <li>2. Bad power outlet.</li> <li>3. Unit is in high-pressure shut-off.</li> <li>4. Motor is in thermal overload.</li> <li>5. Circuit breaker tripped.</li> </ol>	<ol style="list-style-type: none"> <li>1. <i>Check power cord at wall and unit.</i></li> <li>2. <i>Try a different outlet.</i></li> <li>3. <i>Reduce head pressure to below 400 psi (27.6 bar).</i></li> <li>4. <i>Allow motor / unit to cool down.</i></li> <li>5. <i>Check / reset circuit breaker.</i></li> </ol>
<b>Compressor tries to start, but just buzzes</b>	<ol style="list-style-type: none"> <li>1. Low voltage at power source.</li> <li>2. Extension cord too long, or too small.</li> <li>3. Head pressure too high.</li> </ol>	<ol style="list-style-type: none"> <li>1. <i>Locate / use better outlet.</i></li> <li>2. <i>Reduce length of extension cord. Increase size (gauge) of extension cord (14 AWG minimum).</i></li> <li>3. <i>Reduce head pressure. Turn inlet valve slightly past closed toward PURGE to equalize high-side / low-side pressure.</i></li> </ol>
<b>Unit pumps into high-pressure shut-off</b>	<ol style="list-style-type: none"> <li>1. Output valve on unit is closed.</li> <li>2. Recovery cylinder valve closed.</li> <li>3. Head pressure too high.</li> </ol>	<ol style="list-style-type: none"> <li>1. <i>Check output valve.</i></li> <li>2. <i>Check recovery cylinder valve.</i></li> <li>3. <i>Check output hoses for restrictions or kinks. Reduce head pressure.</i></li> </ol>
<b>Slow recovery</b>	<ol style="list-style-type: none"> <li>1. Trapped liquid in system.</li> <li>2. Restriction in refrigerant flow path.</li> </ol>	<ol style="list-style-type: none"> <li>1. <i>Momentarily cycle system compressor to move trapped refrigerant.</i></li> <li>2. <i>Check inlet hose for restrictions or kinks. Remove Schrader valves and core depressers from hoses (if possible). Use larger hoses.</i></li> </ol>
<b>Circuit breaker trips</b>	<ol style="list-style-type: none"> <li>1. Low voltage at power source.</li> <li>2. Extension cord too long, or too small.</li> <li>3. Excessive load on compressor / motor.</li> </ol>	<ol style="list-style-type: none"> <li>1. <i>Locate / use better outlet.</i></li> <li>2. <i>Reduce length of extension cord. Increase size (gauge) of extension cord (14 AWG minimum).</i></li> <li>3. <i>Reduce head pressure. Throttle inlet valve to reduce load on compressor.</i></li> </ol>

# REPLACEMENT PARTS

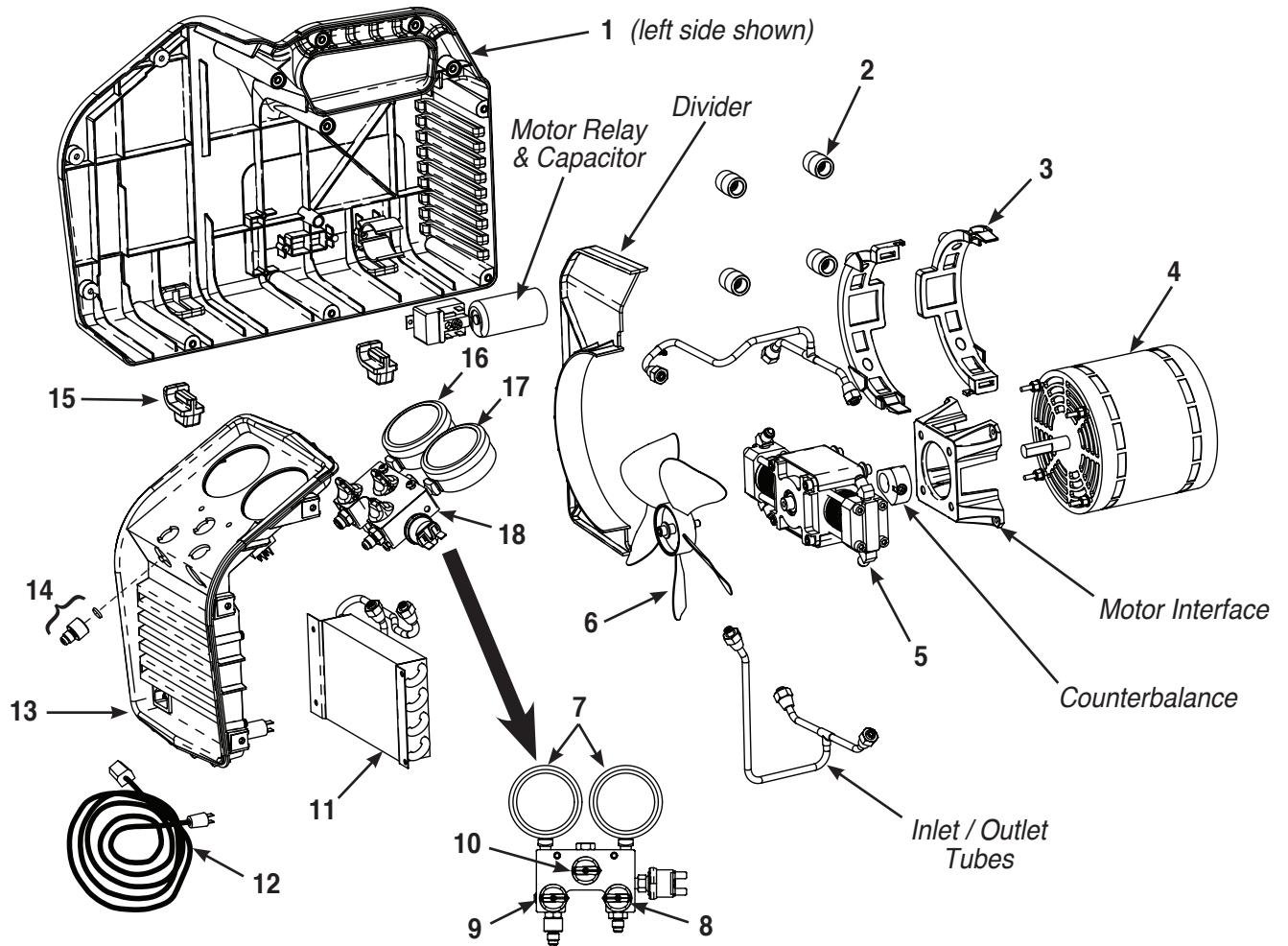

Item No.	Part No.	Qty.	Description
1	567913	1	Case Half (left)
	567915	1	Case Half (right)
2	550503	1	Grommet (1 ea.)
3	SK-6013	1	Motor Clamp Kit (4 pieces)
4	SK-6005	1	Motor Kit (includes motor, relay, capacitor, hardware)
5	SK-6023	1	Compressor Kit (includes compressor, hardware)
6	SK-6008	1	Fan Kit (includes fan, spacer mounting hardware)
7	GA1000	1	Gauge Lens (1 ea.)
8	100124	1	Manifold Knob (red)
9	100123	1	Manifold Knob (blue)
10	100122	1	Manifold Knob (black)
11	SK-6014	1	Condenser Kit (includes condenser assembly, hardware)

Item No.	Part No.	Qty.	Description
12	551628	1	Power Cord
13	SK-6012	1	Bezel Kit (includes bezel, power switch, circuit breaker, power entry module, hardware)
14	SK-6001	1	Inlet Fitting / Filter Screen Kit (includes inlet fitting, filter screen, o-ring)
15	550502	1	Foot (1 ea.)
16	SK-6003	1	Low-side Gauge Kit (includes low-side gauge, lens)
17	SK-6022	1	High-side Gauge Kit (includes high-side gauge, lens)
18	SK-6016	1	Manifold Kit (includes manifold assembly, hardware)

# REBUILD KITS AND ACCESSORIES

<b>Part No.</b>	<b>Description</b>
<b>SK-5001</b>	80% Tank Shut-off Kit
<b>SK-6001</b>	Filter Screen Replacement Kit
<b>SK-6002</b>	Filter / Drier Kit (includes filter / drier, 6 inch hose)
<b>SK-6005</b>	Motor Replacement Kit
<b>SK-6007</b>	Valve Rebuild / Replacement Kit (includes inlet /oulet valves and springs, o-rings)
<b>SK-6008</b>	Fan Replacement Kit
<b>SK-6012</b>	Bezel Replacement Kit
<b>SK-6014</b>	Condenser Replacement Kit
<b>SK-6015</b>	Piston Seal Rebuild Kit (includes piston seals, energizer o-ring, wear bands)
<b>SK-6016</b>	Manifold Replacement Kit
<b>SK-6023</b>	Compressor Replacement Kit
<b>SK-6022</b>	Gauge Replacement Kit
<b>TIF9010A</b>	Refrigerant Scale
<b>17572</b>	Recover Cylinder (50 lb. capacity, 400 psi working pressure, capacity sensor)
<b>SK-6013</b>	Motor Clamp Kit (4 pieces)

# MAINTENANCE

**⚠ CAUTION :** To prevent personal injury, disconnect the unit from the power supply before performing maintenance.

## Installation of the Filter and Filter / Drier

1. Before performing a refrigerant recovery, always inspect and clean the filter screen in the inlet fitting on the unit. Replace the filter screen (p/n SK-6001) if necessary. A filter screen greatly reduces the risk of damage to the unit by preventing foreign material from entering the unit and the system being serviced. Failure to use a filter screen will invalidate the warranty.

Robinair also strongly recommends using an in-line filter / drier (p/n 100343) in the inlet line.

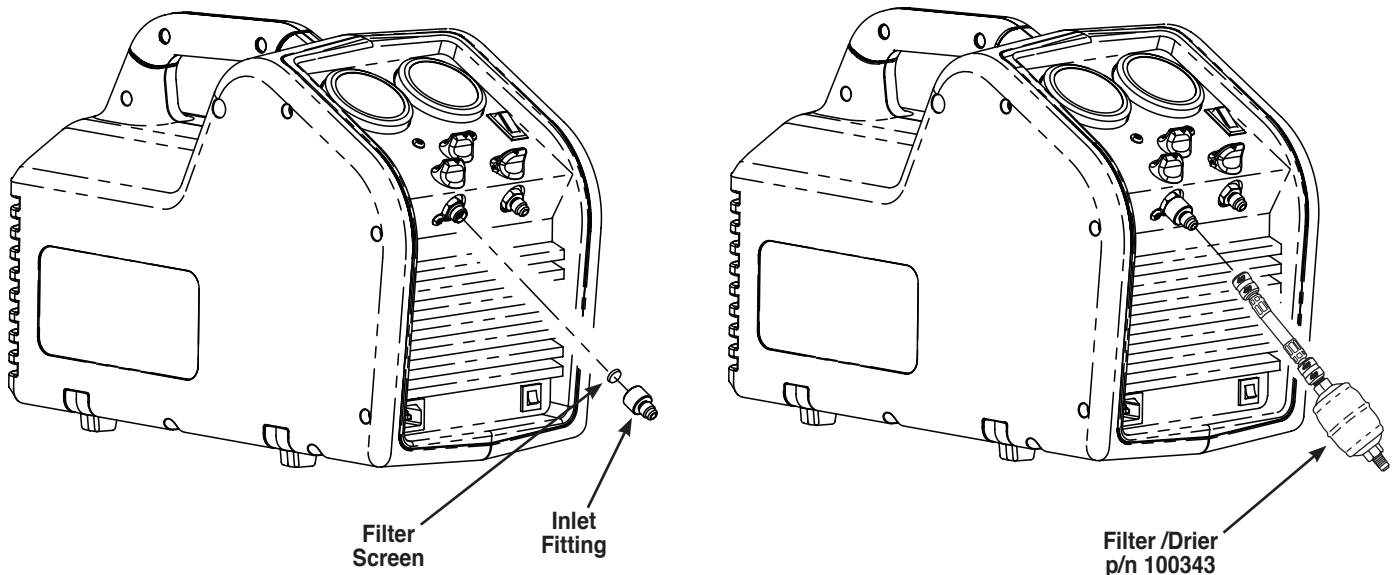

## Burned-out System

1. Use two high-acid capacity filter / driers in series when recovering from a “burned-out” system. Robinair recommends Alco type EK-162-F or Sporlan type C-162-F filters.

When you have finished recovering from the system, flush the unit with a small amount of clean refrigerant and refrigerant oil to purge any foreign substances left in the unit.

## Storage

1. Empty refrigerant from the unit into a storage cylinder. Liquid refrigerant left in the unit’s condenser may expand, causing damage to components.
2. Completely evacuate the unit of any residual refrigerant and purge it with dry nitrogen before putting it in storage for a long period of time.

## FULL ONE-YEAR LIMITED WARRANTY

Unit Serial No. \_\_\_\_\_

This product is warranted to be free from defects in workmanship, materials and components for a period of one year from date of purchase.

### The following restrictions apply:

1. This warranty is non-transferable. All warranty claims must be made within the warranty period. Proof of purchase must be supplied with the product when returned.
2. The warranty applies to product in normal use only, as described in this operating manual. The product must be maintained and serviced as specified.
3. If the product fails, it will be repaired or replaced at the option of the manufacturer (Robinair). Warranty service claims are subject to factory inspection for product defects. The manufacturer is the sole determiner of warranty coverage. If during the warranty evaluation it is determined that proper maintenance was not performed, or that the product has been used in any way other than the purpose for which it was designed, the manufacturer reserves the right to void the warranty.
4. Normal wear items (seals, filters, etc.) are specifically excluded from this warranty, unless found by the manufacturer to be defective.

This warranty does not apply if the product or product part is damaged by accident, misuse, tampering with, or modifying in anyway. The manufacturer is not responsible for any additional costs associated with a product failure including, but not limited to, loss of work time, loss of refrigerant, or unauthorized shipping and/or labor charges.

Use of this product with any unauthorized refrigerants or chemicals will void the warranty.

### Warranty Service:

1. Outside of the United States of America, contact your local Robinair distributor.
2. Inside the United States of America, call 1-800-327-5060 for a Return Material Authorization (RMA) number. Instructions on where to send the product will be provided.

## GARANTIE LIMITÉE COMPLÈTE D'UN AN

N° de série de l'appareil \_\_\_\_\_

Ce produit est garanti contre les défauts matériels et de fabrication pour une durée d'un an à compter de la date d'achat.

### Toutefois, les restrictions suivantes s'appliquent :

1. Cette garantie est non transférable. Toute réclamation au titre de la garantie doit être soumise durant la période de garantie. La preuve d'achat doit être fournie avec le produit lors d'un retour.
2. La garantie s'applique uniquement au produit utilisé dans des conditions de fonctionnement normales conformément au manuel d'utilisation. Il doit être entretenu et réparé conformément aux spécifications.
3. Si le produit fait l'objet d'une défaillance, il sera réparé ou remplacé à la discrétion du fabricant (Robinair). Les réclamations au titre de la garantie sont sujettes à l'inspection en usine du produit défectueux. La couverture de la garantie est à la seule discrétion du fabricant. Si l'évaluation de la garantie démontre qu'aucun entretien approprié n'a été effectué ou que le produit a été utilisé dans un but autre que celui pour lequel il a été conçu, le fabricant se réserve le droit d'annuler la garantie.
4. Les composants d'usure normale (joints, filtres, etc.) sont exclus de cette garantie, à moins que le fabricant ne constate qu'ils sont défectueux.

Cette garantie n'est pas applicable si le produit ou les éléments du produit sont endommagés à la suite d'un accident, d'un usage abusif, d'une altération ou d'une modification quelconque. Le fabricant ne peut être tenu responsable de tout coût supplémentaire lié à la défaillance du produit incluant, sans toutefois s'y limiter, les interruptions de fonctionnement, la perte de fluide frigorigène, la contamination des fluides frigorigènes et l'expédition et/ou les frais de main-d'œuvre soumis par des ateliers non autorisés.

L'utilisation de ce produit avec des fluides frigorigènes ou produits chimiques non autorisés annulera la garantie.

### Assistance à la garantie :

1. À l'extérieur des États-Unis, communiquez avec le concessionnaire Robinair de votre région.
2. Aux États-Unis, composez le 1-800-327-5060 pour obtenir un numéro d'autorisation de retour d'article. Des directives sur l'endroit où retourner le produit vous seront fournies.

## EINJÄHRIGE GARANTIE

Serien-Nr. des Geräts \_\_\_\_\_

Es wird garantiert, dass dieses Produkt während des Zeitraums von einem Jahr ab Kaufdatum frei von Material-, Komponenten- und Verarbeitungsfehlern ist.

### Es gelten folgende Beschränkungen:

1. Diese Garantie ist nicht übertragbar. Alle Garantieansprüche müssen innerhalb der Garantieperiode eingereicht werden. Beim Umtausch muss der Kaufbeleg vorgelegt werden.
2. Diese Garantie gilt für ein Produkt, das gemäß den Anweisungen in dieser Bedienungsanleitung verwendet wurde. Das Produkt muss gemäß den Anweisungen gewartet und instandgesetzt werden.
3. Bei einem Ausfall des Produkts wird es nach Ermessen des Herstellers (Robinair) repariert oder ausgetauscht. Reparaturansprüche unter der Garantie unterliegen einer werksseitigen Inspektion auf Produktschäden. Allein der Hersteller kann die Garantiedeckung bestimmen. Wenn im Laufe der Inspektion festgestellt wird, dass keine ordnungsgemäßen Wartungsarbeiten durchgeführt wurden oder dass das Produkt auf eine andere Art und Weise verwendet wurde als die, für die sie konzipiert wurde, behält sich der Hersteller das Recht vor, die Garantie für ungültig zu erklären.
4. Normale Verschleißteile (Dichtungen, Filter usw.) sind von der Garantie ausgeschlossen, es sei denn, sie wurden vom Hersteller für defekt befunden.

Diese Garantie wird ungültig, wenn das Produkt oder dessen Teile durch Unfall oder falschen Gebrauch beschädigt, manipuliert oder modifiziert wurde. Der Hersteller kommt nicht für Nebenkosten auf, die durch den Produktausfall entstehen, einschließlich, aber nicht beschränkt auf, Arbeitsaufwand, Verlust von Kältemittel oder nicht autorisierte Versand- und/oder Arbeitskosten.

Bei Verwendung dieses Produkts mit nicht zugelassenen Kältemitteln oder Chemikalien wird die Garantie ungültig.

### Reparaturen unter der Garantie:

1. Außerhalb der Vereinigten Staaten wenden Sie sich an Ihren Robinair Vertriebshändler.
2. Innerhalb der Vereinigten Staaten rufen Sie 1 800-327-5060 (gebührenfrei) an und lassen sich eine RMA-Nummer (Rücksendenummer) geben. Sie erhalten Anweisungen darüber, wohin Sie das Produkt senden können.

## GARANTÍA LIMITADA COMPLETA POR UN AÑO

Número de serie de la unidad \_\_\_\_\_

Se garantiza que este producto no posee defectos de mano de obra, materiales y componentes por el periodo de un año a partir de la fecha de compra.

### Aplican las siguientes restricciones:

1. Esta garantía no es transferible. Todo reclamo de garantía se debe hacer dentro del periodo de garantía. Se debe proveer un comprobante de compra con el producto al devolverlo.
2. La garantía aplica al producto en uso normal únicamente, como lo indica este manual de funcionamiento. El producto debe contar con un servicio y mantenimiento según lo especificado.
3. Si falla el producto, será reparado o reemplazado a discreción del fabricante (Robinair). Los reclamos de servicio de garantía están sujetos a inspección autorizada de defectos del producto. El fabricante es el único determinante de la cobertura de la garantía. Si durante la evaluación de la garantía se determina que no se ha llevado a cabo el mantenimiento apropiado, o que el producto ha sido utilizado para diferentes propósitos de los que fue diseñado, el fabricante se reserva el derecho de invalidar esta garantía.
4. Los elementos normales de desgaste (sellos, filtros, etc.) están específicamente excluidos de la garantía, a menos que el fabricante los encuentre defectuosos.

Esta garantía no se aplica si el producto o parte del producto es dañado accidentalmente, por uso inadecuado o ha sido alterado o modificado de cualquier manera. El fabricante no es responsable de los costos adicionales relacionados con fallas en el producto, que incluyen pero no se limitan a: tiempo improductivo, pérdida de refrigerante o envío no autorizado y/o cargos por mano de obra.

La utilización de este producto con cualquier refrigerante o químico no autorizado invalidará esta garantía.

### Servicio de garantía:

1. Fuera de los Estados Unidos de América, contacte a su distribuidor de Robinair local.
2. Dentro de los Estados Unidos de América, llame al 1-800-327-5060 para obtener un número de Autorización de retorno de material (RMA). Se proveerán instrucciones sobre a dónde enviar el producto.



# **ROBINAIR®**

Form No. 567912  
Rev. A, December 31, 2013  
© Bosch Automotive Service Solutions LLC

**Test Equipment  
Depot**  
  
**1-800-517-8431**

99 Washington Street  
Melrose, MA 02176  
Phone 781-665-1400  
Toll Free 1-800-517-8431

 Visit us at [www.TestEquipmentDepot.com](http://www.TestEquipmentDepot.com)