

SeeSnake® *MAX*™ r*M*200 Series



This manual covers the following drums:



⚠ WARNING!

Read this manual carefully before using this tool. Failure to understand and follow the contents of this manual may result in electrical shock, fire, and/or serious injury.

**Test Equipment
Depot**
1-800-517-8431

99 Washington Street
Melrose, MA 02176
Phone 781-665-1400
Toll Free 1-800-517-8431



Visit us at www.TestEquipmentDepot.com

Table of Contents

Introduction

Regulatory Statements 4
 Safety Symbols..... 4

General Safety Rules

Work Area Safety..... 5
 Electrical Safety..... 5
 Personal Safety 6
 Equipment Use and Care 6

Pre-Operation Inspection

Specific Safety Information

SeeSnake MAX rM200 Safety 7

Product Overview

Description 8
 Universal Specifications 9
 System Components 9
 rM200A Description..... 11
 D2A Specifications 11
 rM200B Description..... 12
 D2B Specifications 12

Operating Instructions

Placement 13
 Opening the rM200 Case 14
 Installing the Drum 14
 Routing the Camera 15
 Connecting to a SeeSnake Monitor 15

Inspection Overview

Best Practices..... 17
 Pipe Guides..... 18
 Drum Keypad..... 19
 Integrated Counter..... 20
 Display Features on Recorded Media..... 20
 Locating the Sonde 23
 Line Tracing the Push Cable 24
 Retrieving the Camera..... 24

Individual Components

Handles and Docks 25

Stow Bin 26

Self-Leveling Camera 26

System Cable Assembly 26

Bearings 27

Docking System

Mounting the CS6 onto the rM200..... 29

Mounting the CS65 onto the rM200..... 29

Maintenance and Support

Maintaining Drum Components 30

Cleaning 30

Accessories 31

Transport and Storage 31

Service and Repair 31

Disposal 31

Troubleshooting 32

Appendices

Appendix A: Docking Handle Installation 33

Appendix B: Stow Bin Instructions..... 35

Appendix C: Camera Removal 36

Appendix D: Camera Installation 37

Appendix E: Camera Fault Isolation 38

Introduction

The warnings, cautions, and instructions discussed in this manual cannot cover all possible conditions and situations that may occur. It must be understood by the operator that common sense and caution are factors that cannot be built into this product, but must be supplied by the operator.

Regulatory Statements

CE The EC Declaration of Conformity (890-011-320.10) will accompany this manual as a separate booklet when required.

FCC This device complies with Part 15 of FCC rules. Operation is subject to the following two conditions: (1) This device may not cause harmful interference, and (2) this device must accept any interference received, including interference that may cause undesired operation.

Safety Symbols

In this manual and on the product, safety symbols and signal words are used to communicate important safety information. This section is provided to improve understanding of these signal words and symbols.



This is the safety alert symbol. It is used to alert you to potential injury hazards. Obey all safety messages that follow this symbol to avoid possible injury or death.

⚠ DANGER

DANGER indicates a hazardous situation which, if not avoided, will result in death or serious injury.

⚠ WARNING

WARNING indicates a hazardous situation which, if not avoided, could result in death or serious injury.

⚠ CAUTION

CAUTION indicates a hazardous situation which, if not avoided, could result in minor or moderate injury.

NOTICE NOTICE indicates information that relates to the protection of property.



This symbol means read the operator's manual carefully before using the equipment. The manual contains important information on the safe and proper operation of the equipment.



This symbol means always wear safety glasses with side shields or goggles when handling or using this equipment to reduce the risk of eye injury.



This symbol indicates the risk of electrical shock.

General Safety Rules

⚠ WARNING



Read all safety warnings and instructions. Failure to follow the warnings and instructions may result in electrical shock, fire, and/or serious injury.

SAVE THESE INSTRUCTIONS!

Work Area Safety

- **Keep your work area clean and well lit.** Cluttered or dark areas invite accidents.
- **Do not operate equipment in explosive atmospheres, such as in the presence of flammable liquids, gases, or dust.** Equipment can create sparks which may ignite the dust or fumes.
- **Keep children and bystanders away while operating equipment.** Distractions can cause you to lose control.
- **Avoid traffic.** Pay attention to moving vehicles when using on or near roadways. Wear high-visibility clothing or reflector vests.

Electrical Safety

- **Avoid body contact with earthed or grounded surfaces such as pipes, radiators, ranges, and refrigerators.** There is an increased risk of electrical shock if your body is earthed or grounded.
- **Do not expose equipment to rain or wet conditions.** Water entering equipment will increase the risk of electrical shock.
- **Keep all electrical connections dry and off the ground.** Touching equipment or plugs with wet hands can increase the risk of electrical shock.
- **Do not abuse the cord.** Never use the cord for carrying, pulling, or unplugging the power tool. Keep cord away from heat, oil, sharp edges, and moving parts. Damaged or entangled cords increase the risk of electrical shock.
- **If operating equipment that is powered by an AC adapter in a damp location is unavoidable, use a ground fault circuit interrupter (GFCI) protected supply.** Use of a GFCI with an AC adapter reduces the risk of electrical shock.

Personal Safety

- **Stay alert, watch what you are doing, and use common sense when operating equipment.** Do not use equipment while you are tired or under the influence of drugs, alcohol, or medication. A moment of inattention while operating equipment may result in serious injury.
- **Dress properly.** Do not wear loose clothing or jewelry. Loose clothes, jewelry, and long hair can be caught in moving parts.
- **Practice good hygiene.** Use hot, soapy water to wash hands and other body parts exposed to drain contents after handling or using drain inspection equipment. To prevent contamination from toxic or infectious material, do not eat or smoke while operating or handling drain inspection equipment.
- **Always use appropriate personal protective equipment when handling and using equipment in drains.** Drains may contain chemicals, bacteria, and other substances that may be toxic, infectious, and cause burns or other issues. Appropriate personal protective equipment always includes safety glasses and may include a dust mask, hard hat, hearing protection, drain cleaning gloves or mitts, latex or rubber gloves, face shields, goggles, protective clothing, respirators, and steel toed, non-skid footwear.
- **If using drain cleaning equipment and drain inspection equipment at the same time, wear RIDGID drain cleaning gloves.** Never grasp the rotating drain cleaning cable with anything else, including other gloves or a rag which can become wrapped around the cable and cause hand injuries. Only wear latex or rubber gloves underneath RIDGID drain cleaner gloves. Do not use damaged drain cleaning gloves.

Equipment Use and Care

- **Do not force equipment.** Use the correct equipment for your application. The correct equipment does the job better and more safely.
- **Do not use equipment if the power switch does not turn it on and off.** Any equipment that cannot be controlled with the power switch is dangerous and must be repaired.
- **Disconnect the plug from the power source and/or the battery pack from the equipment before making adjustments, changing accessories, or storing.** Preventive safety measures reduce the risk of injury.
- **Store idle equipment out of the reach of children and do not allow persons unfamiliar with the equipment or these instructions to operate the equipment.** Equipment can be dangerous in the hands of untrained users.
- **Maintain equipment.** Check for misalignment or binding of moving parts, missing parts, breakage of parts, and any other condition that may affect the equipment's operation. If damaged, have the equipment repaired before use. Many accidents are caused by poorly maintained equipment.
- **Do not overreach.** Keep proper footing and balance at all times. This enables better control of the equipment in unexpected situations.
- **Use the equipment and accessories in accordance with these instructions, taking into account the working conditions and the work to be performed.** Use of the equipment for operations different from those intended can result in hazardous situations.
- **Use only accessories that are recommended by the manufacturer for your equipment.** Accessories that may be suitable for one piece of equipment may become hazardous when used with other equipment.
- **Keep handles dry, clean, and free from oil and grease.** Clean handles give better control of the equipment.

Pre-Operation Inspection

⚠ WARNING



To reduce the risk of serious injury from electrical shock or other causes, and to prevent damage to your equipment, inspect all equipment and correct any problems before each use.

To inspect all equipment, follow these steps:

1. Power off your equipment.
2. Disconnect and inspect all cords, cables, and connectors for damage or modification.
3. Clean any dirt, oil, or other contamination from your equipment to ease inspection and to prevent it from slipping from your grip during transport or use.
4. Inspect your equipment for any broken, worn, missing, misaligned, or binding parts, or any other condition which might prevent safe, normal operation.
5. Refer to the instructions for all other equipment to inspect and make sure it is in good, usable condition.
6. Check your work area for the following:
 - Adequate lighting.
 - The presence of flammable liquids, vapors, or dust that may ignite. If present, do not work in area until sources have been identified and corrected. The equipment is not explosion proof. Electrical connections can cause sparks.
 - A clear, level, stable, and dry place for the operator. Do not use the equipment while standing in water.
7. Examine the job to be done and determine the correct equipment for the task.
8. Observe the work area and erect barriers as necessary to keep bystanders away.

Specific Safety Information

⚠ WARNING



This section contains important safety information that is specific to the SeeSnake Max rM200. Read these precautions carefully before using the equipment to reduce the risk of electrical shock, fire, and/or serious injury.

SAVE ALL WARNINGS AND INSTRUCTIONS FOR FUTURE REFERENCE!

SeeSnake Max rM200 Safety

- **Read and understand this manual, the digital reporting monitor's manual, and the instructions for any other equipment you are using before operating the equipment.** Failure to follow all instructions may result in property damage and/or serious injury. Keep this manual with the equipment for future use.
- **Operating the equipment while in water increases the risk of electrical shock.** Do not operate the rM200 if operator or equipment are standing in water.
- **The digital reporting monitor's battery and other electrical equipment and connections are not waterproof.** Do not expose the equipment to wet locations.
- **The equipment is not designed to provide high voltage protection and isolation.** Do not use where a danger of high voltage contact is present.
- **To prevent damage to the rM200 and to decrease the risk of injury, do not expose the rM200 to mechanical shocks.** Exposure to mechanical shocks can damage equipment and increase the risk of serious injury.

Product Overview

Description

The SeeSnake® MAX™ rM200 series consists of the flagship reels, cameras, and push cables in the premier product family of SeeSnake MAX Diagnostic Systems.

The rM200 comes with your choice of drums from the D2 drum series, giving you on-the-job flexibility when the job demands a different push cable and camera combination.

The rM200 can be used with any SeeSnake monitor and is designed to dock with the CS6 and CS65 for convenient transport, operation, and storage.

Heavily tested for durability, the rM200's case helps protect your push cable, prolonging the life of your equipment. Keeping the push cable enclosed when not in use also helps keep surfaces around and between your work areas clean.

Each rM200 model include a built-in sonde which helps locate problems in the pipe. The rM200A and rM200B feature a FleXmitter® sonde inside the spring assembly. FleXmitter sondes have longer, more powerful antennae capable of putting out a stronger signal without inhibiting the camera's flexibility through turns. The sonde transmits a 512 Hz signal which can be detected by receivers such as the RIDGID SeekTech® SR-20, SR-24, SR-60, Scout™, or NaviTrack® II.

The rM200 is easy to transport with its handle assembly and wheels. One stow bin comes standard with each rM200. Store a paint can, gloves, business cards, wrenches, or any other tool you want to keep nearby in the stow bin. Additional stow bins can be ordered and up to two can be installed on the rM200.

The drum's integrated counter measures how far the camera has traveled inside the pipe. The water-resistant keypad lets you control the counter's functions, which include day, date, time, distance, and preset or custom text overlays.



Standard Equipment

- rM200 case
- D2 drum
- One (1) stow bin
- Operator's manual
- Product video
- Docking handle
- Shoulder strap
- Pipe guides

Universal Specifications	
SeeSnake system cable length	3 m [10 ft]
Case dimensions	
Length	527 mm [20.8 in]
Depth	349 mm [13.8 in]
Height	610 mm [24 in]
Wheels dimensions	
Width	35 mm [1.4 in]
Diameter	172 mm [6.8 in]
Pull handle dimensions	
Length	514 mm [20.3 in]
Height	508 mm [20 in]
Stow bin dimensions	
Width	241 mm [9.5 in]
Depth	159 mm [6.3 in]
Height	216 mm [8.5 in]
Operating environment	
Temperature ‡	-40°C to 55°C [-40°F to 131°F]
Storage temperature	-40°C to 65°C [-40°F to 149°F]
Ingress protection without monitor	IPx5
Depth rating	81 m [266 ft]
Relative humidity	5 to 95 percent
Altitude	4,000 m [13,123 ft]
‡ While the camera can function in extreme temperatures, some image quality changes may occur.	

System Components

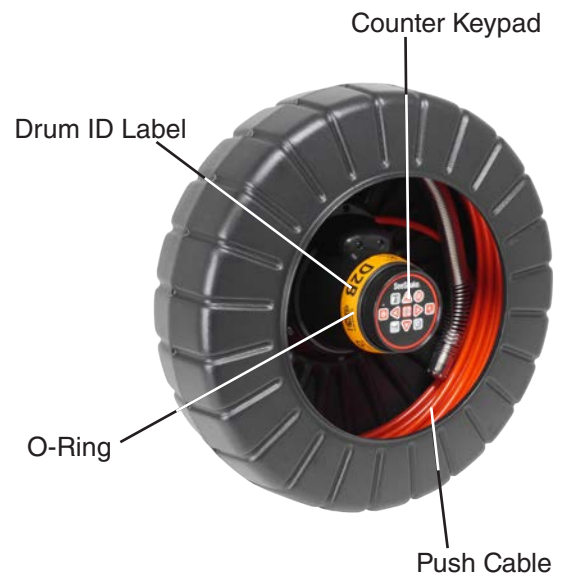
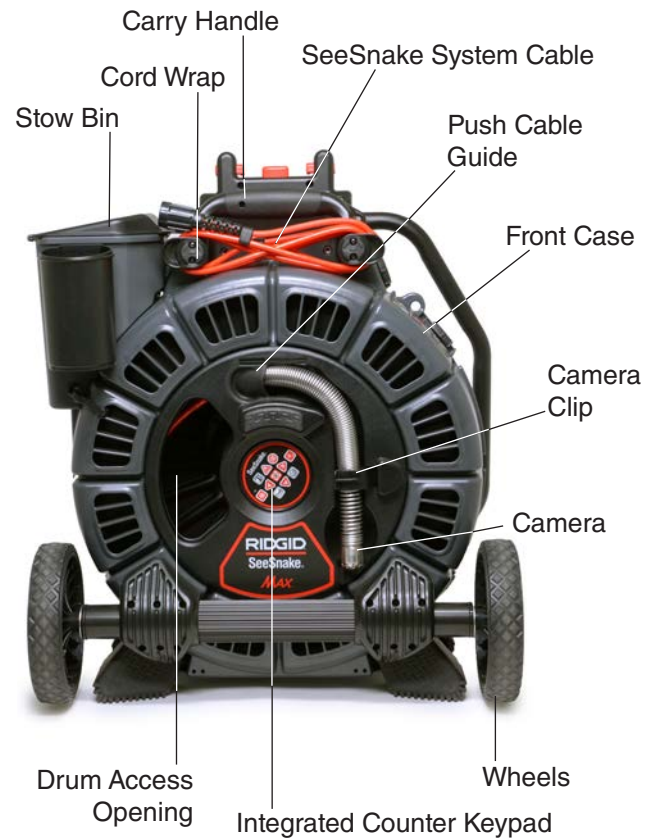

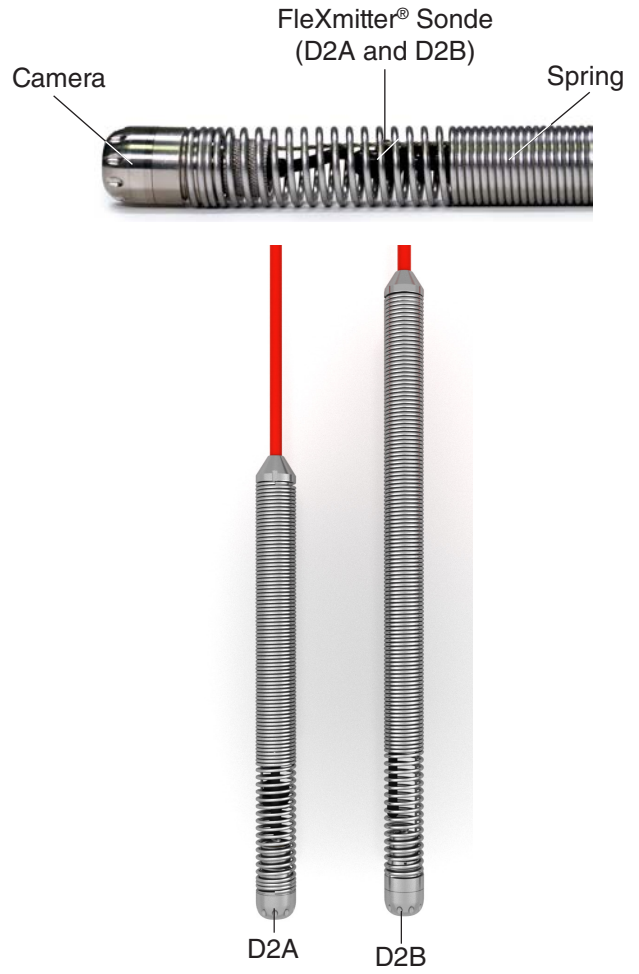
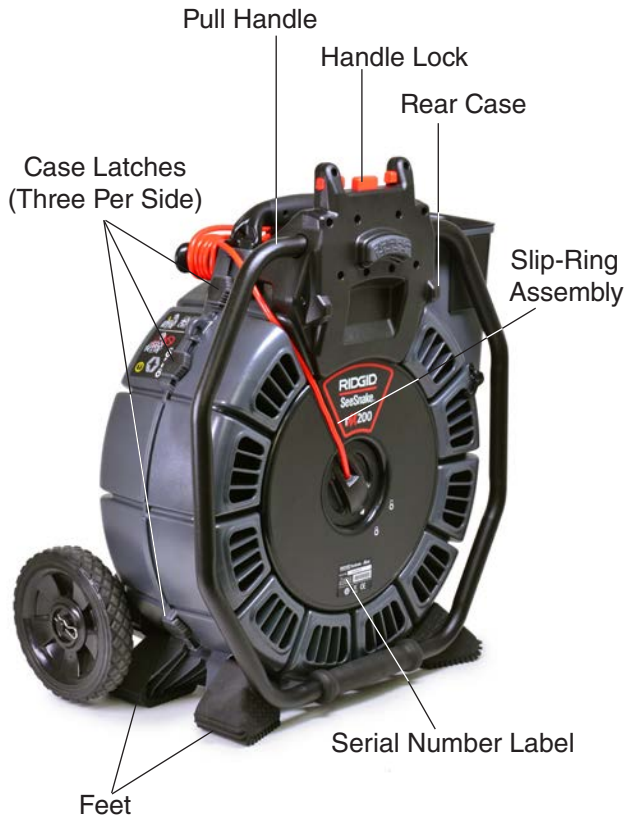

rM200A Description

The rM200A consists of the rM200 case with the D2A drum installed. A 61 m [200 ft] long, moderately stiff push cable makes the rM200A a versatile pipe inspection system.

The rM200A weighs 16.5 kg [36.4 lb], which includes the rM200 case, one stow bin, and the D2A drum.

The rM200A's self-leveling camera ensures a clear image through turns and long lines. The rM200A is best suited for lines 38 mm – 101 mm [1.5 in – 4 in] in diameter. When used with a 125 mm [5 in] pipe guide the rM200A's line capacity is 38 mm – 203 mm [1.5 in – 8 in]. Achievable push distance depends on pipe conditions.

A FleXmitter[®] sonde is built into the rM200A's spring. The sonde helps locate problems in the pipe.

D2A Specifications

Color ID	Red
rM200A system weight	16.5 kg [36.4 lb]
Drum weight	7.4 kg [16.3 lb]
Drum diameter	432 mm [17 in]
Camera	
View	Self-leveling
Length	26 mm [1 in]
Diameter	25 mm [1 in]
Light	6 LEDs
Sonde	
Type	FleXmitter [®]
Frequency	512 Hz
Resolution	
NTSC	656 × 492 pixels
PAL	768 × 576 pixels
Spring assembly	
Type	Single
Length	308 mm [12 in]
Push cable	
Length	61 m [200 ft]
Diameter	7.5 mm [0.3 in]
Fiberglass core diameter	3.5 mm [0.14 in]
Minimum bend radius	70 mm [2.8 in]
Pipe capacity	38 mm – 203 mm [1.5 in – 8 in]

rM200B Description

The rM200B consists of the rM200 case with the D2B drum installed. The rM200B has a 50 m [165 ft] long, stiff push cable and a longer spring with a second, shorter spring nested inside. The dual, nested spring gives the rM200B the ability to easily navigate multiple turns and transitions while maintaining the stiffness necessary to push through them and go farther down long lines.

The rM200B weighs 17.8 kg [39.2 lb], which includes the rM200 case, one stow bin, and the D2B drum.

No matter how many turns you push through, the rM200B's self-leveling camera ensures a clear image. The rM200B is best suited for lines 38 mm – 101 mm [1.5 in – 4 in] in diameter. When used with a 125 mm [5 in] pipe guide the rM200B's line capacity is 38 mm – 203 mm [1.5 in – 8 in]. Achievable push distance depends on pipe conditions.

A FleXmitter® sonde is built into the rM200B's spring. The sonde helps locate problems in the pipe.

D2B Specifications	
Color ID	Orange
rM200B system weight	17.8 kg [39.2 lb]
Drum weight	8.7 kg [19.2 lb]
Drum diameter	432 mm [17 in]
Camera	
View	Self-leveling
Length	26 mm [1 in]
Diameter	25 mm [1 in]
Light	6 LEDs
Sonde	
Type	FleXmitter®
Frequency	512 Hz
Resolution	
NTSC	656 × 492 pixels
PAL	768 × 576 pixels
Spring assembly	
Type	Dual, nested
Length	433 mm [17 in]
Push cable	
Length	50 m [165 ft]
Diameter	9 mm [0.4 in]
Fiberglass core diameter	4.5 mm [0.2 in]
Minimum bend radius	90 mm [3.5 in]
Pipe capacity	38 mm – 203 mm [1.5 in – 8 in]

Test Equipment Depot - 800.517.8431
 99 Washington Street, Melrose, MA 02176
TestEquipmentDepot.com

Operating Instructions

⚠ WARNING



Wear appropriate protective equipment such as latex or rubber gloves, goggles, face shields, and respirators when inspecting drains that might contain hazardous chemicals or bacteria. Always wear eye protection to protect against dirt and other foreign objects.

Do not operate equipment if operator or equipment are standing in water. Operating the equipment while in water increases the risk of electrical shock. Rubber-soled, non-slip shoes can help prevent slipping and electrical shock on wet surfaces.

Placement

Place the rM200 and monitor near the pipe entrance so you can manipulate the push cable while viewing the display. Lay the rM200 case on its back or position the pull handle as a kick stand to make sure the rM200 case does not tip during use.



Use the pull handle as a kick stand when performing an inspection on a rooftop, hillside, or in a location that requires overhead entry.



Note: Refer to the Handles and Docks section for instructions on how to lock the handle into different positions.

Opening the rM200 Case

⚠ WARNING

Follow these procedures for proper assembly and to reduce the risk of serious injury.

⚠ CAUTION

Make sure the camera is completely inside the drum before unlatching and opening the rM200 case. If the camera is not in the drum, the push cable can unwind and cause damage or serious injury.

NOTICE Do not open the rM200 case while the camera is stored in the camera clip. Secure the camera inside the drum.

Open the rM200 case to install the drum, replace the bearing, rewind the push cable, install the docking handle, and to maintain and clean the rM200 system.

To open the rM200 case, follow these steps:

1. Lock the pull handle against the rear case.
Note: Refer to the Handles and Docks section for instructions on how to position the handle.
2. Remove the stow bin.
Note: Refer to Appendix B for instructions on how to remove the stow bin.
3. Lay the rM200 case on its back.
4. Secure the camera in the drum by pushing it through the drum access opening.



5. Unwrap the SeeSnake system cable from the cord wrap.
6. Slide all six case latches toward the handle to unlock the rM200 case.
7. Lift handle to open.

Installing the Drum

The rM200 case gives you the ability to swap out the drum when the job requires a different push cable and camera combination.

To install the drum, follow these steps:

1. Open the rM200 case.
2. Place the drum in the rM200 case.
Make sure the bearing faces down and the counter keypad faces up.
3. Spin the drum to make sure the drum spins freely on the bearing.
4. Lock all six (6) of the rM200 case latches.

NOTICE The O-ring can fall out easily. Make sure the O-ring is properly installed before use.

Routing the Camera

If the camera is inside the drum, route the camera through the drum access opening and the push cable guide. Secure the camera in the camera clip when not in use.





Connecting to a SeeSnake Monitor

The rM200 can connect to any SeeSnake monitor with the SeeSnake system cable.

1. Unwrap the system cable from the cable wraps.
2. Pull back the outer locking sleeve on the system cable connector.
3. Align the connector ridge and plastic guide pin with the socket and push the connector straight in.
4. Tighten the outer locking sleeve.

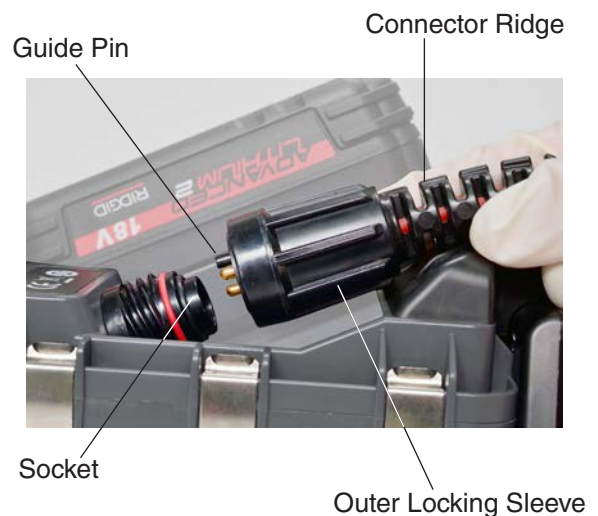
NOTICE Only twist the outer locking sleeve. To prevent damage to the pins, never bend or twist the connector.





5. Power on the system:
 - Press the Power key  to power on the system.
 - On a digital reporting monitor, press the Autolog key  to quick-start an inspection.

Note: For some digital reporting monitors, a USB drive must be inserted to capture media. Refer to the monitor's manual for more information about the benefits of Autolog video recordings.

Inspection Overview





The SeeSnake MAX rM200 can be used for basic or advanced pipe inspections. To perform a basic inspection, connect any SeeSnake monitor to the rM200, power on the system, push the push cable through the pipe, and observe the display. An advanced inspection requires a SeeSnake digital reporting monitor and additionally involves capturing media and delivering reports to your customer.

1. Place the rM200 near the pipe entrance. Make sure the system is stable and the drum can spin freely.
2. Connect the system cable to the digital reporting monitor.
3. Press the Power key  to power on the system. Alternatively, insert a USB drive into the monitor's USB port and press the Autolog key  to quick-start the inspection.
4. Release the camera clip and, if desired, install a pipe guide or camera head guide to keep the camera centered in the pipe. Make sure the camera lens is clean.
5. Carefully put the camera into the pipe. Protect the push cable from sharp edges at the pipe entrance.
6. Push the camera through the pipe and observe the display.
7. Advanced Options:
 - Set the system zero point, or take a temporary segment distance measurement.
 - Capture media.
 - Create on-screen custom overlay.
 - Locate an inspection point or path.
 - Create and deliver an inspection report to your customer on a USB drive.
8. When the inspection is complete, retrieve the camera and secure the spring in the spring clip.

Advanced Options

Both basic and advanced pipe inspections can include taking pipe segment distance measurements, adjusting the camera's LED brightness, or activating the sonde. Depending on your digital reporting monitor's features, you may also want to capture media and create reports.

Note: Refer to your digital reporting monitor manual for instructions on capturing media and creating reports.

- Press the Brightness key  to turn up the brightness of the camera LEDs so you can see farther down the pipe.
- Capture media of the inspection by pressing the Video key , Autolog key , or Photo key .
- Long press (>3 seconds) the Zero key  for three seconds to set the system zero point wherever you want to begin counting from.
- Use a RIDGID SeekTech locating receiver to locate a point of interest with the integrated 512 Hz sonde.
- Use a RIDGID SeekTech locating receiver with a transmitter to find the path of a pipe by line tracing the push cable.

Best Practices

Refer to the following tips and recommendations to perform the pipe inspection with efficiency and ease. Following these tips can increase the longevity and effectiveness of your equipment and prevent damage.

- **Run water through the pipe during the inspection to keep the camera system clean, make pushing the push cable easier, and allow longer pushes. Place a hose down the pipe or turn on a fixture. Shut off the water flow as needed for a clear view.**
- Apply a thin film of liquid detergent or soap on the camera to help keep the lens clear.
- Be careful when inspecting porcelain appliances. The camera may scratch the surface finish.
- Sharp edges at the pipe entrance can cut, kink, snag, or damage the push cable. Use extreme care and always keep one hand near the pipe entrance when pushing into the pipe to avoid damaging the push cable.
- Use rubber gripper-type gloves to manipulate the push cable, improve grip, and keep hands clean. Use a quick push to pop the camera around a bend such as a p-trap, tee, Y, or elbow. To pop around a bend, pull the camera back approximately 200 mm [8 in] and thrust it through in one motion. Do not use more force than is necessary.
- The video image is most stable and clear when moving the push cable backward in the pipe. When you have found an area of interest in the pipe, push the camera beyond it and then pull back.
- Dragging the push cable over sharp edges can damage the push cable. **Do not drag the push cable over sharp edges and do not pull or bend the push cable at sharp angles at the pipe entrance.**
- When pushing through porcelain surfaces, such as a toilet, use plastic or PVC tubing to protect the finish.
- Some inspection conditions can cause the spring to fold back so that the camera faces the wrong way. If the push cable is visible on the display, the spring has folded over on itself. Pull the push cable back. If necessary, pull the push cable all the way out of the pipe and attempt the inspection again.
- To keep the push cable from folding over on itself, only push short sections through the pipe at a time. If the push cable folds over on itself, it can snap or kink.
- Obstructions or excessive build up in the pipe can damage or prevent retrieval of the camera. **Do not use the camera to clear obstructions.**

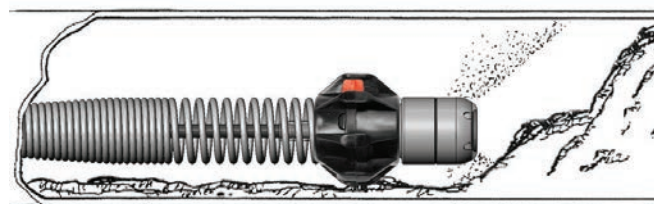

Pipe Guides

Pipe guides center the camera in the pipe, improve picture quality, and help keep the lens clear. Use pipe guides when possible to reduce wear and tear on the camera system.

Pipe guides can easily be installed, adjusted, and removed to provide better camera and push cable movement in the pipe. For small pipes, tubes, or voids, the camera head guide helps push the camera through stubborn fittings. For larger pipes, ball guides center the camera for better visibility and light illumination.



Without Pipe Guide



With Pipe Guide

Camera Head Guide Installation

Camera head guides can be used in smaller pipes to push the camera through stubborn fittings.

1. Loosen the screws on both sides of the guide until it slides easily onto the camera head.
2. Tighten the screws until the guide stays in place, but do not over-tighten.



Ball Guide Installation

Ball guides are designed to slip onto the spring and lock into place. Depending on work conditions, you can place a ball guide on the spring behind the camera to tilt the camera head upward to view the top of the pipe.

1. Make sure the ball guide is unlocked.
2. Slide the ball guide over the camera and onto the spring.



3. Press down on the blue locks to secure the ball guide onto the spring.
4. Slide the red locks over the blue locks to secure the ball guide into place.



Locked



Unlocked

NOTICE If a ball guide gets snagged in a pipe, it can fall off the spring. To avoid losing ball guides and obstructing the pipe, do not use excessive force to push through the pipe when you feel resistance.

Drum Keypad

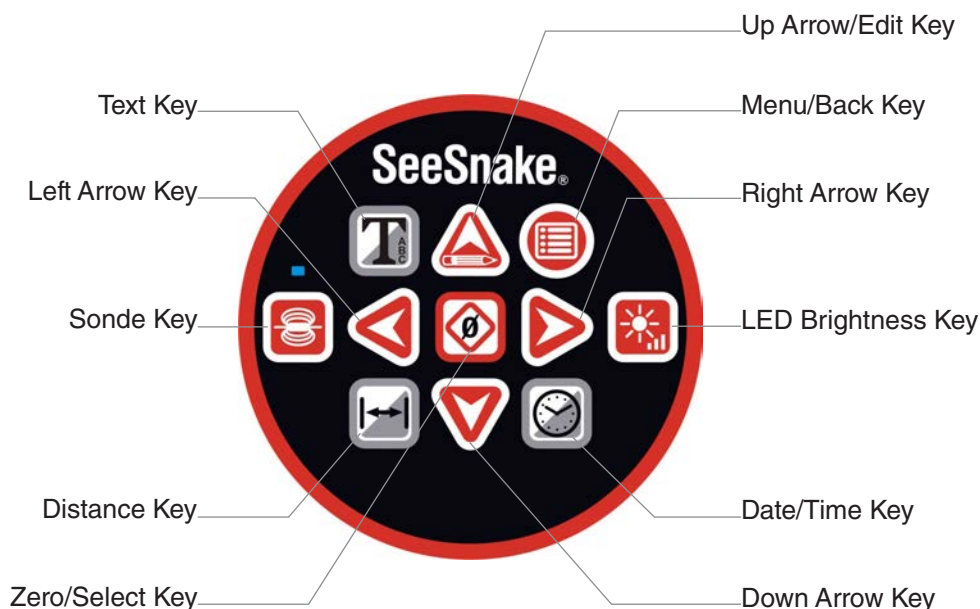

Drum Keypad		
Key		Meaning
	Menu/Back Key	Open the Main Menu and exit out of menus and screens.
	Zero/Select Key	Select a highlighted menu item or long press (>3 seconds) to set the system zero point. To measure a temporary zero point of the total length of push cable, press again for one second. Press a third time to return to the total length measurement.
	Sonde Key	Toggle the sonde on or off. When on, the LED above the key is lit.
	LED Brightness Key	Control the brightness of the LEDs in the camera. Press to increase or decrease brightness levels or press once and use the Arrow keys to adjust the brightness.
	Up Arrow/Edit Key	Navigate menu choices and text characters. Press to edit highlighted text. Refer to the On-Screen Text section for instructions on editing on-screen text.
	Left/Right Arrow Keys	Navigate menu choices and text characters.
	Down Arrow Key	Navigate menu choices and text characters.
	Text Key*	Toggle on or off to show or hide preset text or custom text.
	Date/Time Key*	Toggle on or off to show or hide the date and time of the inspection.
	Distance Key*	Toggle on or off to show or hide the integrated counter measurement.
*When toggled on, this feature is displayed on the monitor's recorded video and appears in the inspection report.		



Integrated Counter

The rM200 comes equipped with an integrated counter. The integrated counter measures the total length of the extended push cable.

Use of the integrated counter is not required, but it is useful to keep track of how far the push cable has gone in the line. The integrated counter can also measure the push cable's distance from a temporary zero point, such as a pipe head or joint, while still keeping track of the total length of the push cable.

Use the Zero key  on the rM200, if you have the rM200 with the counter keypad. If you have the rM200 without the counter keypad, zero the integrated counter with the monitor's keypad.

To measure the push cable with the integrated counter, follow these steps:

1. At any time during the inspection long press (>3 seconds) the Zero key  to set the system zero point.
2. Short press (<3 seconds) the Zero key  to set a temporary zero point at any time during the inspection. The temporary zero point measurement appears in brackets on-screen.



3. Press the Zero key  again for one second to clear the temporary measurement and return to the system measurement.

Display Features on Recorded Media

Three display features are controlled by the rM200 keypad. You can type text such as the pipe inspection location and company, display the integrated counter measurement, or display the date and time of the pipe inspection. These features can easily be toggled on and off for display during video recording of the pipe inspection and are burned onto the video recording.

Note: the display features on recorded media cannot be controlled by the monitor's keypad.

By default, the display features are turned off. The display features are useful if you are delivering a report to a customer that requires the pipe inspection address, distance, and date/time to be displayed on the recorded video.

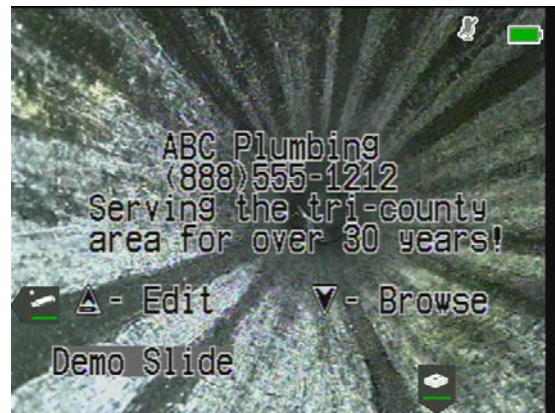

On-Screen Text

Toggle the text on and off of the monitor's screen by pressing the Text key **T** on the drum's keypad. Use the Arrow keys **◀▶** to scroll through preset pipe inspection text or to enter custom text such as the inspection address or your contact information.

To edit the preset pipe inspection text or create custom text, follow these steps:

1. Toggle the text on with the Text key **T**.
2. Use the Arrow keys **◀▶** to navigate to the text you want to edit.
3. Press the Up Arrow/Edit key **▲** when the text you want to edit is displayed on-screen.
4. Use the Arrow keys **◀▶** to scroll through and highlight specific characters.
5. When the character you want to edit is highlighted, press the Text key **T** to open the character options.



6. Use the Arrow keys **▲▼◀▶** to highlight the character you are inserting and press the Zero/Select key **0** to select it.
7. Press the Menu/Back key **⊙** to save and exit.

Note: Both the drum's keypad and the monitor can create on-screen text. It is recommended to use the monitor for on-screen text.

Integrated Counter Measurement

Toggle the integrated counter measurement on and off of the video recording by pressing the Distance key **Ⓜ** on the counter keypad. To display the integrated counter measurement on the video recording, press the Distance key **Ⓜ** prior to pressing the monitor's Video key **Ⓜ**.



If the integrated counter measurement is inaccurate, the push cable length may need to be adjusted. To adjust the push cable length, follow these steps:

1. Press the Menu/Back key **⊙** to open the rM200's Main Menu.
2. Use the Down Arrow key **▼** to highlight the Settings icon **Ⓜ** and press the Zero/Select key **0** to open the Settings menu.
3. Use the Down Arrow key **▼** to highlight the Push Cable Length icon **Ⓜ** and press the Zero/Select key **0** to open the Push Cable Length screen.











4. Use the Arrow keys **◀▶** to change the push cable length.





Inspection Date and Time

Toggle the date and time of the inspection to one of three different settings: date and time, date only, or time only. Press the Date/Time key  once for date and time, twice for date only, and three times for time only. To display the date and time of the inspection on the video recording, press the Date/Time key  prior to pressing the monitor's Video key .

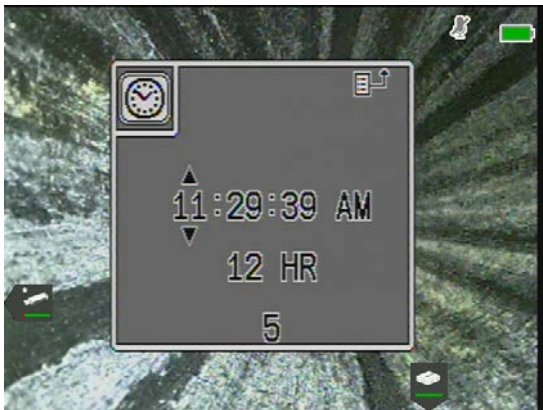





If the date and time is inaccurate, it may need to be adjusted. To adjust the date and time, follow these steps:

1. Press the Menu/Back key  to open the rM200's Main Menu.
2. Use the Down Arrow key  to highlight the Settings icon  and press the Zero/Select key  to open the Settings menu.
3. Use the Left or Right Arrow key   to highlight the Time icon  or the Date icon  and press the Zero/Select key  to open the highlighted icon's editing screen.



4. In both the Time screen and the Date screen use the Arrow keys     to change the Time and Date.

Main Menu

In the Main Menu you can edit on-screen text, view the rM200's information, and adjust the date, time, measurement units, and push cable length settings. Press the Menu/Back key  to open the rM200's Main Menu. Use the Arrow keys     to navigate the Main Menu and the Zero/Select key  to select options.









Select the Edit icon  to edit preset text and custom text. Refer to the On-Screen Text section for instructions on how to edit text using the counter keypad.



Select the Information icon  to view the Information screen. On the Information screen you can view the camera mode (NTSC or PAL), product version number, and the total number of feet the push cable has been pushed (both in and out of the drum).





Select the Settings icon  to open the Settings menu. In the Settings menu you can edit the time , date , measurement units , and push cable length . Use the Arrow keys  to navigate the menu and the Zero/Select key  to select options.



Note: Refer to the Integrated Counter Measurement and Inspection Date and Time sections for instructions on how to edit the time, date, and push cable length.

Locating the Sonde

You can use the integrated sonde to locate a point of interest in the pipe at any time during the inspection. The sonde is located in the spring and is assembled between the end of the push cable and the camera. The sonde transmits a locatable 512 Hz signal that can be detected by receivers such as the RIDGID SeekTech® SR-20, SR-24, SR-60, Scout™, or NaviTrack® II.

Press the Sonde key  to enable and disable the sonde. When the sonde is enabled, the LED by the key is lit and the sonde icon  displays. The 512 Hz sonde signal can cause interference lines that may be visible on captured media.

To locate the sonde, follow these steps:

1. Power on the receiver and set it to sonde mode.
2. Locate the sonde's general direction so you know which way the pipe goes:
 - Power on the sonde and push the push cable no more than 5 m [15 ft] into the pipe.
 - Sweep the horizon with the receiver in a slow arc.
3. The signal strength is highest where the receiver detects the sonde.

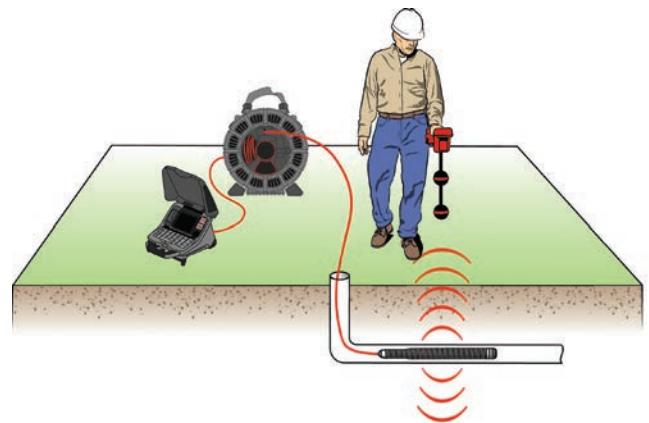

Note: For additional instructions on sonde locating, refer to the manual for the receiver model you are using.

Line Tracing the Push Cable

You can locate the path of a pipe by line tracing the push cable. This is especially useful for inspecting non-metallic or non-conductive pipes. Line trace the push cable by using a transceiver to induce current onto the push cable using a transmitter.

To line trace the push cable, follow these steps:

1. Push the transmitter's ground stake into the ground and clip one of the transmitter's leads to it.
2. Clip the other lead to the transmitter clip-on terminal on the back of the monitor.



3. Power on the transmitter and set your desired frequency. For best results, use frequencies 33 kHz and higher.
4. Power on the receiver and set it to the same frequency as the transmitter.
5. Trace the line.

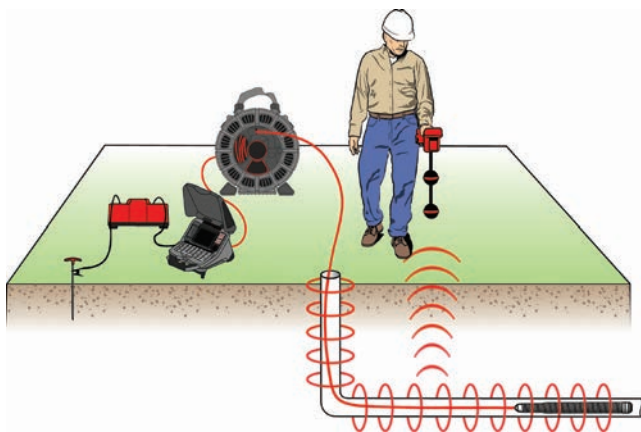

Note: For additional instructions on line tracing, refer to the manual for the transmitter and receiver models you are using.

Retrieving the Camera

After completing the inspection, pull the push cable back out of the pipe with slow, steady force and return it to the drum. Wipe the push cable with a paper towel or cloth as you withdraw it. If possible, continue running water down the pipe to clean the push cable.

To avoid damage to the camera or push cable, do not exert excessive force during retrieval. If the camera head is stuck behind a turn, you can pop the camera past the turn or run water down the pipe to lubricate the push cable.

NOTICE Gripping close to the rM200, always use short strokes to feed back small lengths of the push cable into the drum. Pushing back longer lengths of the push cable or forcing the push cable may cause it to loop, kink, or break.

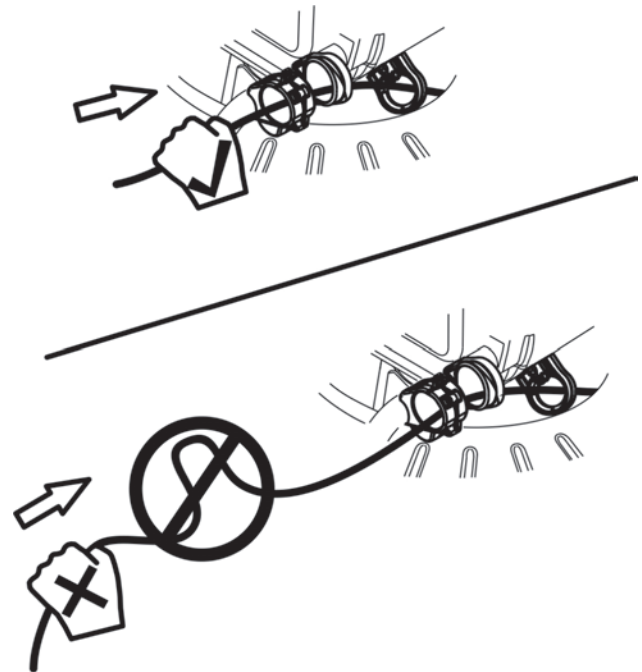

Individual Components

Handles and Docks

Carry Handle

The carry handle comes installed on the rM200 case. The carry handle can be removed and replaced with the docking handle for use with a compatible digital reporting monitor.



Docking Handle

The docking handle was designed specifically for use with SeeSnake digital reporting monitors, such as the CS6, and can be used in place of the carry handle.



Note: Refer to Appendix A for instructions on how to install the docking handle.

Pull Handle

The pull handle on the rM200 can be locked in four positions. Each position has a different purpose which increases usability and maneuverability.

- Midway for use as a kick stand.
- Upright to maneuver during transport.
- Against the rear case when in use.
- Against the front case for storage in small spaces and transport when going up or down ladders.

To position the pull handle, follow these steps:

1. Set the rM200 case on its feet.
2. Press the handle lock and position the handle.
3. Release the handle lock to lock the handle into place.



Stow Bin

The stow bin provides storage for gloves, a paint can, business cards, pipe wrenches, or other tools you want to keep nearby. The rM200 comes with one stow bin. Up to two (2) can be installed on the rM200.

Note: Refer to Appendix B for detailed instructions on how to install the stow bin.



Self-Leveling Camera

If using a drum that features a self-leveling camera, the bearings and weight of the self-leveling camera may create a swinging effect when you push the push cable through the pipe. The camera image settles quickly when the push cable is steady.

The self-leveling camera can be removed to troubleshoot problems, send for repair, or to replace. Refer to Appendices C and D for instructions on how to remove and install the camera head.

System Cable Assembly

The system cable assembly includes the following components:

- The system connector for connecting to SeeSnake digital reporting monitors.
- 3 m [10 ft] of system cable.
- The slip-ring assembly, which is made up of the slip-ring dial and the slip-ring cavity on the frame.

Before cleaning the rM200, ensure the slip-ring dial is locked **8** in the slip-ring cavity. Avoid getting the slip-ring assembly wet when cleaning.

NOTICE To avoid damaging the slip-ring contact pins or getting the internal electrical components wet, keep the slip-ring assembly locked.

Bearings

There are two bearings in the rM200 system. The bearings allow the drum to spin smoothly when pushing the cable and provide resistance when returning the push cable to the drum.

One bearing attaches to the rM200 case and is located inside the front case.



The second bearing attaches to the drum and is located on the drum's underside. Each rM200 model has a different bearing. The bearings can fall out. Do not substitute the bearings.

Replacing the Bearing

The bearing is on the underside of the drum. A different bearing comes with each D2 series drum. The bearing can become dirty and worn. To clean, rinse in warm water and a mild detergent.

To replace the bearing, follow these steps:

1. Open the rM200 case.
2. Lift the drum out of the rM200 case and turn over, with the counter keypad faced down.
3. Replace bearing.
4. Return the drum to the rM200 case and make sure the bearing faces down and the counter keypad faces up.
5. Spin the drum to make sure the drum spins freely on the bearing.
6. Lock all six (6) of the rM200 case latches.

NOTICE Do not use the rM200 without the bearing installed. If the bearing is missing, the push cable can damage or break.



System Cable Removal

1. Disconnect the system cable from the reporting monitor and remove the monitor from the docking system.
2. Unwrap the system cable from the cable wraps.
3. On the rear side of the rM200 case, turn the slip-ring dial counter-clockwise to the unlocked position **⓪**.
4. Pull straight out.

NOTICE Do not touch the contact pins inside the slip-ring dial. Stressing the contact pins can cause them to break.

Broken Contact Pin

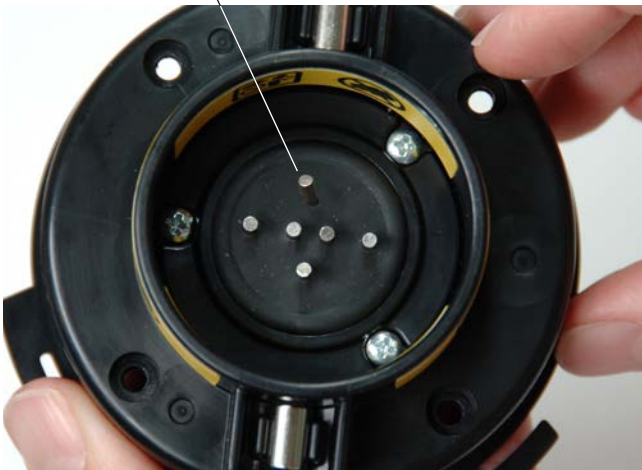

System Cable Installation

To install the system cable, follow these steps:

1. Align the arrow on the slip-ring dial with the unlock symbol **⓪** on the frame and insert the slip-ring dial into the slip-ring cavity.
2. Turn the slip-ring dial to the locked position **⓪**.



3. Hook the system cable into the frame hook and snap the cable anchor onto the frame.
4. Wrap the system cable around the cable wraps.

Docking System

⚠ WARNING

Carrying the system incorrectly can cause the digital reporting monitor to disengage from the docking system and may result in property damage and/or serious injury.

Mounting the CS6 onto the rM200



To mount the CS6 onto the rM200, follow these steps:

1. Place the CS6 handle into the rM200 docking handle.
2. Wrap the docking handle's Velcro® strap over the CS6's handle.

Note: The CS6 may fall out of the docking handle if it is not secured by the Velcro® strap.



Mounting the CS65 onto the rM200

To mount the CS65 onto the rM200, follow these steps:

1. Depress the red buttons on the rM200 so that they do not obstruct the CS65's kick stand.
2. Unfold the kick stand from the bottom of the CS65, and hold the system so that it is parallel to the back of the rM200. Place the CS65 onto the rM200.
3. Reset the red buttons on the rM200 so they lock the CS65 into place.



Removing the CS65 from the Docking System

To remove the CS65 from the rM200, simply depress the red buttons on the rM200 and remove the CS65. You may return the kick stand to its folded position.



Maintenance and Support

Maintaining Drum Components

Camera Head

The camera head requires little maintenance other than keeping the LED ring and sapphire window clean. Use a soft nylon brush, mild detergent, and rags to clean the camera.

Scraping tools may permanently scratch the camera. Scratches on the LED ring have a minimal effect on the camera's performance.

NOTICE Do not sand the LED ring to remove scratches. Sanding the LED ring can damage the watertight housing.

Spring

Stretch the spring end-to-end as far as it allows so you can visually inspect the inner components. Stir the spring in lukewarm water and a mild detergent to flush away debris.

Push Cable

Keep the push cable clean. Run a rag over the push cable as it goes back into the drum after each inspection to clean it and reduce debris accumulation.

Visually inspect the push cable for cuts and abrasions while pushing it back into the drum. Replace or repair the push cable if the outer jacket is cut or abraded.

Cleaning

For light cleaning, use a soft, damp cloth to wipe down the rM200. If desired, you can use a disinfectant.

To clean the rM200 case and drum, follow these steps:

1. Prepare:
 - Set the rM200 case on its feet and disconnect the system cable from the digital reporting monitor. Remove the monitor from the docking system.
 - Make sure the slip-ring dial is in the locked **8** position.
 - Push the camera through all three push cable guides and into the drum so the drum can spin freely.
2. Fill the bottom of the drum with lukewarm water and a mild detergent, then spin the drum to loosen grime. Tip the drum opening down to empty the water.
3. In a large area, pull the push cable through the guide and completely out of the drum. Do not try to coil the push cable outside of the drum.
4. Use a hose or pressure washer to clean the rM200 case and the empty drum while the drum is still in the rM200 case.
5. Thoroughly dry the rM200 case and the contact board on the drum's underside. Run a rag over the push cable while you push it back into the drum.

NOTICE Do not fill the drum with water while the rM200 case is on its back. Filling the drum with water when the rM200 case is on its back can cause the contact board on the underside of the drum to get wet.

High pressure water can damage the seals that protect the electronics inside the drum.

Using solvents to clean any part of the system can affect waterproofing.

Accessories

Only use accessories specifically designed and recommended for use with the rM200. Accessories designed for use with other tools may become hazardous when used with the rM200.

The following RIDGID products have been designed to function with the rM200:

- Pipe Guide Kit
- D2 Drum Series
- Stow Bin
- Shoulder Strap
- Docking Handle
- RIDGID SeekTech or NaviTrack Receivers
- RIDGID SeekTech or NaviTrack Transmitters
- RIDGID SeeSnake MAX monitors
- Original RIDGID SeeSnake monitors

Transport and Storage

Store and transport your equipment with the following in mind:

- Store in a locked area out of the reach of children and people unfamiliar with its purpose.
- Store in a dry place to reduce risk of electrical shock.
- Store away from heat sources such as radiators, heat registers, stoves, and other products (including amplifiers) that produce heat.
- Storage temperature should be -40°C to 65°C [-40°F to 149°F].
- Do not expose to heavy shocks or impacts during transport.

Service and Repair

Improper service or repair can cause the rM200 to be unsafe to operate.

Service and repair of the rM200 must be performed at a RIDGID Independent Authorized Service Center. To maintain the safety of the tool, make sure a qualified repair person services your equipment using only identical replacement parts. Discontinue using the rM200 and contact service personnel under any of the following conditions:

- If liquid has been spilled or objects have fallen into the equipment.
- If the equipment does not operate normally when operating instructions are followed.
- If the equipment has been dropped or damaged.
- If the equipment exhibits a distinct change in performance.

Disposal

Parts of the rM200 contain valuable materials that can be recycled. Dispose of the components in compliance with all applicable regulations. Contact your local waste management authority for more information.



For EC countries: Do not dispose of electrical equipment with household waste!

According to the European Guideline 2002/96/EC for Waste Electrical and Electronic Equipment and its implementation into national legislation, electrical equipment that is no longer usable must be collected separately and disposed of in an environmentally correct manner.

Troubleshooting

Problem	Probable Fault	Solution
No video feedback	No power to the SeeSnake monitor.	Check to make sure the power source is properly connected.
	Slip-ring assembly is broken or the connection is faulty.	Check all alignment and connection pins.
		Check placement and pin condition in the slip-ring assembly.
	SeeSnake system cable connection is faulty.	Check SeeSnake system cable connection. Make sure the connectors are pushed all the way in.
	Camera is faulty.	Isolate the fault to the camera. Refer to Appendix E for instructions.
No count measurement	Older SeeSnake monitors may not be compatible with the rM200's integrated counter.	Count measurements will show up on job reports, and may show up on the monitor during viewing. A new monitor may be required if capturing count measurements to media is necessary.

Appendices

Appendix A: Docking Handle Installation

⚠ CAUTION

Make sure the camera is completely inside the drum before unlatching and opening the rM200 case. The push cable can unwind and damage the push cable or cause serious personal injury when the camera is not in the drum.

To remove the carry handle and install the docking handle, follow these steps:

1. Lay the rM200 case flat with the rear case on the ground.
2. Push the camera through the push cable guide until it is completely inside the drum.



3. Unwrap the SeeSnake system cable from the cord wrap.
4. Remove the cord wrap attachments with a Phillips screwdriver and lift them from their sockets.



5. Slide all six case latches toward the handle to unlock the rM200 case.
6. Lift the front case and remove the carry handle.



7. Fit the docking handle into the grooves on the front case and place the nuts into the screw holes on the docking handle.

Note: The docking handle can be installed either direction. Position the docking handle according to the direction you want the monitor to face.



8. Reattach both sides of the cord wrap and screw into place.



9. Close the case and slide all six (6) case latches toward the wheels to lock the rM200 case.



Note: Always use the Velcro® to secure the monitor into the docking handle.

Test Equipment Depot - 800.517.8431
99 Washington Street, Melrose, MA 02176
TestEquipmentDepot.com

Appendix B: Stow Bin Instructions

Can Holder Orientation

NOTICE The can holder on the stow bin must be on the front side of the rM200 case so that it does not interfere with the pull handle.

To orient the can holder, follow these steps:

1. Remove the can holder (Item 1) and the replacement plate (Item 2) with a Phillips screwdriver from inside of the stow bin.



2. Install the can holder on the other side of the stow bin and screw the replacement plate into place.

Stow Bin Installation

To install the stow bin on the rM200 case, follow these steps:

1. Push the black button on the inside of the stow bin.



2. Align the groove on the underside of the stow bin (Item 1) with the eyelet on the rM200 case (Item 2). Push and fit into place.

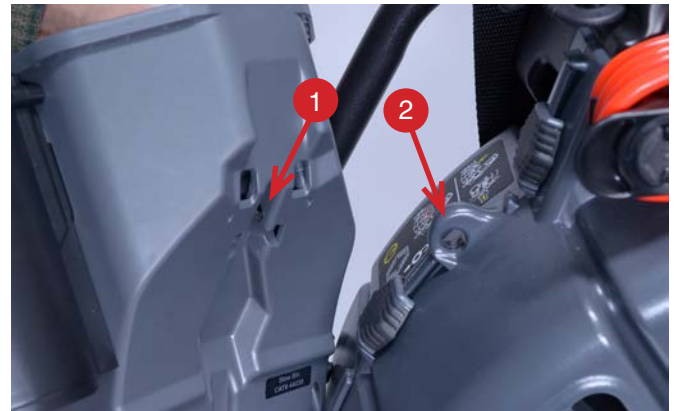

3. To secure the stow bin, pull and snap the front and back hooks into the closest groove on the rM200 case.



Note: The stow bin comes with two rubber plugs that can be inserted into the bottom of the main compartment and can holder. The can holders also contain a magnet at the bottom to securely hold can in place.

To remove the stow bin, follow these steps:

1. Unlatch the stow bin hooks from the rM200's front and rear case.
2. Push the black button on the inside of the stow bin.
3. Pull the stow bin straight off the rM200 case.

Appendix C: Camera Removal

1. Snap the included spanner wrench onto the spring, just behind the camera.



2. Align the notch inside the spanner wrench with the end of the spring coil.



3. Unscrew the spring from the camera.



4. Unscrew the locking sleeve from the camera.

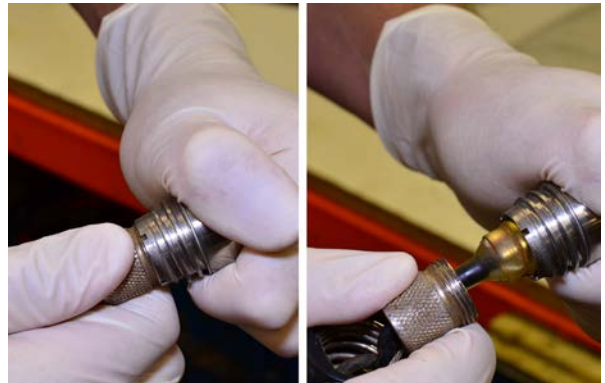

5. Pull the camera straight out of the sonde's socket.



NOTICE To avoid damaging the camera's connector pins, do not bend or twist while pulling the camera out of the connector.

Appendix D: Camera Installation

1. Align the camera head pins with the sonde's socket and push together.



2. Slide push cable locking sleeve onto the camera.



3. To make sure the safety cables end up relatively straight when you screw the camera onto the spring, back-twist the camera by approximately 1 ½ turns (counter-clockwise).



4. The sonde will twist when you thread the camera onto the spring. Rotate the camera one turn counter-clockwise to counteract the twisting and then thread onto the spring.



5. Thread the spring onto the camera until the end of the spring is flush against the camera head.



NOTICE Do not over-tighten the spring.

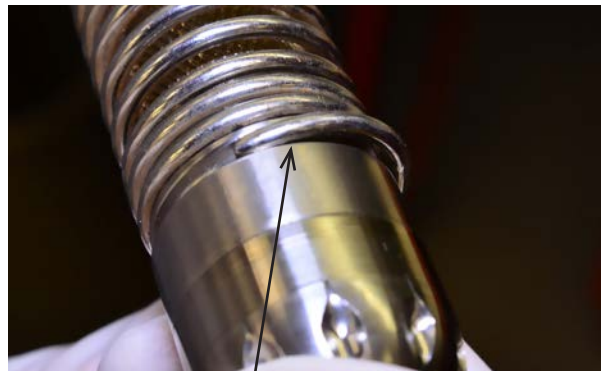

Over-Tightened Spring

Appendix E: Camera Fault Isolation

1. Remove the camera from the push cable.

Note: Refer to Appendix C for instructions on how to remove the camera.

2. Plug the camera directly into the monitor's system cable socket.



3. Press the Power key  to power on the system. Make sure there is video feedback and the LEDs flash.
 - If there is video feedback and the LEDs flash, the camera is working properly.
 - If there is no video feedback or if the LEDs do not flash, the camera is at fault.

© 2015 Ridge Tool Company. All rights reserved.

Every effort has been made to ensure that the information in this manual is accurate. Ridge Tool Company and its affiliates reserve the right to change the specifications of the hardware, software, or both as described in this manual without notice. Due to product development, the photos and other presentations specified in this manual may differ from the actual product.

RIDGID and the RIDGID logo are trademarks of Ridge Tool Company, registered in the USA and other countries. All other registered and unregistered trademarks and logos mentioned herein are the property of their respective owners. Mention of third-party products is for informational purposes only and constitutes neither an endorsement nor a recommendation.



EMERSON. CONSIDER IT SOLVED.™