

RM3548

Instruction Manual

RESISTANCE METER



EN

June 2021 Revised edition 4
RM3548A981-04 21-06H



How to use the Instruction Manual (this manual)

See below, as appropriate:

| | |
|--|--|
| Be sure to always read the following sections. | ▶ “Safety Notes” (p. 4) ▶ “Usage Notes” (p. 7) |
| When you wish to use the instrument immediately | ▶ “Overview” (p. 15) |
| When you need further information on the various functions | ▶ Refer to the “Contents” (p.i) and/or “Index” (p.Ind.1) to find the desired function. |
| To find out about instrument specifications | ▶ “Specifications” (p. 93) |
| If the instrument does not operate as intended or expected | ▶ “Troubleshooting” (p. 108) |
| For detailed information related to resistance measurement | ▶ “Appendix” (p. Appx.1) |

Contents

| | |
|----------------------------------|---|
| Introduction..... | 1 |
| Verifying Package Contents | 2 |
| Safety Notes..... | 4 |
| Usage Notes..... | 7 |

1 Overview **15**

| | |
|---|----|
| 1.1 Overview and Features..... | 15 |
| 1.2 Component Names and Operation Overview..... | 16 |
| ■ Power-on settings | 20 |
| 1.3 Flow of Measurement | 21 |
| 1.4 Screen Layout | 22 |
| 1.5 Checking the Measurement Target | 25 |

2 Preparing for Measurement **27**

| | |
|---|----|
| 2.1 Attaching the Strap..... | 28 |
| 2.2 Loading or Replacing the Batteries | 29 |
| 2.3 Connecting the Test Leads | 30 |
| 2.4 Connecting the Z2002 Temperature Sensor (When Using TC or ΔT) | 31 |
| 2.5 Turning the Power On/Off | 32 |
| ■ Turning the power on | 32 |
| ■ Turning the power off | 32 |
| ■ Automatic power off with auto power save (APS)..... | 33 |
| ■ Disabling auto power save (APS) | 33 |
| 2.6 Pre-measurement Inspection..... | 34 |

3 Basic Measurement **35**

| | |
|--|----|
| 3.1 Setting the Measurement Range | 36 |
| 3.2 Connecting the Test Leads to the Measurement Target | 38 |
| 3.3 Reading the Measured Value | 39 |
| ■ Switching the display..... | 39 |
| ■ Verifying measurement errors | 40 |
| ■ Holding a measured value | 42 |
| ■ Memorizing a measured value | 42 |

| | | |
|----------|--|-----------|
| 4 | Customizing Measurement Conditions | 43 |
| 4.1 | Using Zero Adjustment..... | 44 |
| 4.2 | Stabilizing Measured Values (Averaging Function)... | 49 |
| 4.3 | Compensating for Thermal Effects (Temperature Correction (TC))..... | 50 |
| 4.4 | Compensating for Thermal EMF Offset (Offset Voltage Compensation Function: OVC Function)..... | 51 |
| 4.5 | Setting the Delay Time for Measurement (Delay Function)..... | 53 |
| 4.6 | Switching the Measurement Current (In the 300mΩ Range)..... | 55 |
| 5 | Judgment and Conversion Functions | 59 |
| 5.1 | Judging Measured Values (Comparator Function).... | 60 |
| | ■ Judging based on upper and lower limit values (ABS mode) .. | 63 |
| | ■ Judging based on a reference value and allowable range (REF% mode) | 64 |
| | ■ Verifying a judgment with a sound (judgment sound function) . | 65 |
| | ■ Verifying a judgment on a handheld device (L2105 LED Comparator Attachment option) | 66 |
| 5.2 | Performing Temperature Rise Test (Temperature Conversion Function (ΔT)) | 67 |
| 5.3 | Measuring the Length of a Conductor (Length Conversion Function)..... | 69 |
| 6 | Panel Save and Load (Saving and Loading Measurement Conditions) | 71 |
| 6.1 | Saving Measurement Conditions (Panel Save Function) | 72 |
| 6.2 | Loading Measurement Conditions (Panel Load Function) | 73 |
| 6.3 | Clearing the Contents of a Panel..... | 74 |
| 7 | Memory Function (Saving and Exporting Measurement Data to a PC) | 75 |
| 7.1 | Saving Data at Specified Time (Manual Memory) | 77 |

| | | |
|-----------|---|------------|
| 7.2 | Saving Data Automatically When Measured Values Stabilize (Auto-Memory) | 78 |
| 7.3 | Saving Data at Fixed Intervals (Interval Memory Function) | 79 |
| 7.4 | Displaying Saved Measurement Data (Memory Display Function) | 81 |
| 7.5 | Clearing Measurement Data (Memory Clear) | 82 |
| 7.6 | Exporting Saved Measurement Data to a PC (USB Mass Storage Mode) | 86 |
| 8 | System Settings | 89 |
| 8.1 | Displaying the Date and Time Verification Screen ... | 89 |
| 8.2 | Setting the Clock | 90 |
| 8.3 | Initializing (Reset) | 91 |
| | ■ Default settings | 92 |
| 9 | Specifications | 93 |
| 9.1 | General Specifications | 93 |
| | ■ Measurement range | 93 |
| | ■ Measurement method | 93 |
| | ■ Measurement specifications | 93 |
| | ■ Accuracy | 96 |
| | ■ Functions | 97 |
| | ■ Interface | 104 |
| | ■ Environmental and safety specifications | 105 |
| | ■ Accessories | 105 |
| | ■ Options | 106 |
| 10 | Maintenance and Service | 107 |
| 10.1 | Troubleshooting | 108 |
| | ■ Q&A (frequently asked questions and answers) | 108 |
| | ■ Error display and actions | 114 |
| 10.2 | Repair and Inspection | 115 |
| 10.3 | Replacing Fuses | 116 |
| 10.4 | Disposing of the Instrument | 117 |

Appendix

Appx.1

Appx. 1 Block DiagramAppx.1
Appx. 2 Four-Terminal (Voltage-Drop) MethodAppx.2
Appx. 3 DC Method and AC MethodAppx.3
Appx. 4 Temperature Correction Function (TC)Appx.4
Appx. 5 Temperature Conversion (ΔT) FunctionAppx.7
**Appx. 6 Effect of Thermoelectromotive Force
(Thermal EMF).....Appx.8**
Appx. 7 Zero AdjustmentAppx.11
Appx. 8 Unstable Measurement Values.....Appx.17
Appx. 9 Locating Short-Circuits on a PC Board.....Appx.27
Appx. 10 Test Lead OptionsAppx.28
Appx. 11 Calibration.....Appx.30

Index

Ind.1

Introduction

Thank you for purchasing the HIOKI RM3548 Resistance Meter. To obtain maximum performance from the instrument, please read this manual first, and keep it handy for future reference.

Trademarks

Windows and Microsoft Excel are either registered trademarks or trademarks of Microsoft Corporation in the United States and other countries.

Verifying Package Contents

- When you receive the instrument, inspect it carefully to ensure that no damage occurred during shipping. In particular, check the accessories, panel switches, and connectors. If damage is evident, or if it fails to operate according to the specifications, contact your authorized Hioki distributor or reseller.
- When transporting the instrument, use the same packaging materials used for the delivery to you.

Check the package contents as follows.

- RM3548 Resistance Meter**

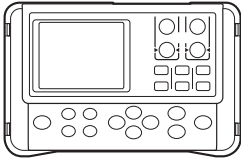

- Instruction Manual**

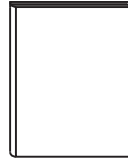

- L2107 Clip Type Lead (p. 30)**



- USB Cable (A-miniB type)**



- Z2002 Temperature Sensor (p. 31)**



- Strap**

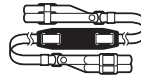

- LR6 Alkaline battery × 8**



- Spare fuse (F2AH/250 V)**



Options

The options listed below are available for the instrument. To order an option, please contact your authorized Hioki distributor or reseller. Options are subject to change. Please check Hioki's website for the latest information. (p. Appx.28)

- L2107 Clip Type Lead

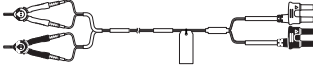

- 9453 Four-Terminal Lead

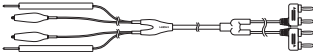

- 9465-10 Pin Type Lead

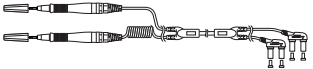

- Z2002 Temperature Sensor



- C1006 Carrying Case

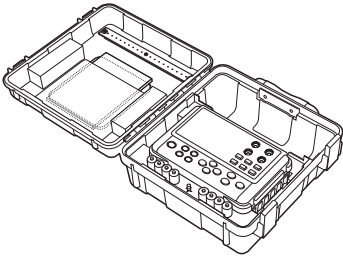

- 9467 Large Clip Type Lead

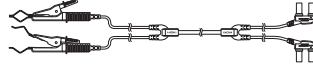

- 9772 Pin Type Lead

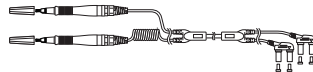

- 9454 Zero Adjustment Board



- L2105 LED Comparator Attachment

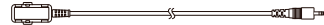

Safety Notes

The instrument is designed to conform to IEC 61010 Safety Standards, and has been thoroughly tested for safety prior to shipment. However, using the instrument in a way not described in this manual may negate the provided safety features.

Before using the instrument, be certain to carefully read the following safety notes.

DANGER



Mishandling during use could result in injury or death, as well as damage to the instrument. Be certain that you understand the instructions and precautions in the manual before use.

WARNING







With regard to the electricity supply, there are risks of electric shock, heat generation, fire, and arc discharge due to short circuits. If persons unfamiliar with electricity measuring instruments are to use the instrument, another person familiar with such instruments must supervise operations.



This manual contains information and warnings essential for safe operation of the instrument and for maintaining it in safe operating condition. Before using the instrument, be certain to carefully read the following safety notes.

Notation



In this manual, the risk seriousness and the hazard levels are classified as follows.

| | |
|---|---|
|  DANGER | Indicates an imminently hazardous situation that will result in death or serious injury to the operator. |
|  WARNING | Indicates a potentially hazardous situation that may result in death or serious injury to the operator. |
|  CAUTION | Indicates a potentially hazardous situation that may result in minor or moderate injury to the operator or damage to the instrument or malfunction. |
| IMPORTANT | Indicates information related to the operation of the instrument or maintenance tasks with which the operators must be fully familiar. |
|  | Indicates prohibited actions. |
|  | Indicates the action which must be performed. |
| * | Additional information is presented below. |
| p. | Indicates the location of reference information. |
| [] | An item enclosed by [] indicates a key name. |
| Unless otherwise noted, Windows XP, Windows Vista, Windows 7, and Windows 8 are referred to as “Windows”. | |

Symbols affixed to the instrument

| | |
|---|---|
|  | Indicates cautions and hazards. When the symbol is printed on the instrument, refer to a corresponding topic in the Instruction Manual. |
|  | Indicates a fuse. |
|  | Indicates DC (Direct Current). |

Symbols for various standards

| | |
|---|---|
|  | Indicates the Waste Electrical and Electronic Equipment Directive (WEEE Directive) in EU member states. |
|  | Indicates that the instrument conforms to regulations required by the EU Directive. |

Screen display

The instrument uses the following screen displays.

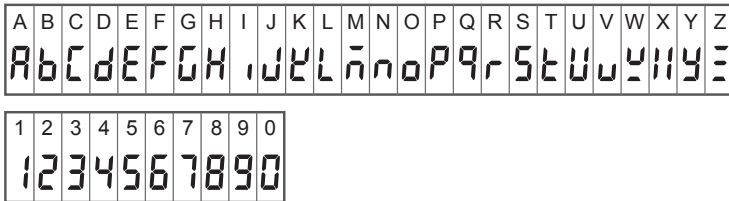

Accuracy

We define measurement tolerances in terms of f.s. (full scale), rdg. (reading) and dgt. (digit) values, with the following meanings:

| | |
|-------------|---|
| f.s. | (Maximum display value) This is usually the maximum display value. In the instrument, this indicates the currently used range. |
| rdg. | (Reading or displayed value) The value currently being measured and indicated on the measuring instrument. |
| dgt. | (Resolution) The smallest displayable unit on a digital measuring instrument, i.e., the input value that causes the digital display to show a “1”. |

See: “Accuracy calculation examples” (p. 96)

Usage Notes

Follow these precautions to ensure safe operation and to obtain the full benefits of the various functions.

Use of the instrument should confirm not only to its specifications, but also to the specifications of all accessories, options, batteries, and other equipment in use.

Checking before use

Before using the instrument the first time, verify that it operates normally to ensure that no damage occurred during storage or shipping. If you find any damage, contact your authorized Hioki distributor or reseller.

DANGER



Before using the instrument, check that the coating of the test leads or cables are neither ripped nor torn and that no metal parts are exposed. Using the instrument under such conditions could result in electrocution. Replace the test leads with those specified by our company.

Installation

Installation environment

Operating temperature and humidity ranges 0°C to 40°C 80%RH or less (no condensation)

Storage temperature and humidity ranges -10°C to 50°C 80%RH or less (no condensation)

Installing the instrument in inappropriate locations may cause a malfunction of instrument or may give rise to an accident. Avoid the following locations.

CAUTION



- Exposed to direct sunlight or high temperature
- Exposed to corrosive or combustible gases
- Exposed to water, oil, chemicals, or solvents
- Exposed to high humidity or condensation
- Exposed to a strong electromagnetic field or electrostatic charge
- Exposed to high quantities of dust particles
- Near induction heating systems (such as high-frequency induction heating systems and IH cooking equipment)
- Susceptible to vibration

IMPORTANT

Accurate measurement may be impossible in the presence of strong magnetic fields, such as near transformers and high-current conductors, or in the presence of strong electromagnetic fields such as near radio transmitters.

Handling precautions

WARNING



- Do not allow the instrument to get wet, and do not use it with wet hands. This may cause electric shock accident.
- Do not modify, disassemble, or repair the instrument. This may result in fire, electric shock accident, or injury.

CAUTION



- Do not place the instrument on an unstable or slanted surface. It may drop or fall, causing injury or instrument failure.
- To avoid any damage to the instrument, avoid any vibration or shock during transport or handling. Especially, be careful not to drop or fall the instrument which will cause shock.
- To avoid any damage to the instrument, do not input voltage or current to any measurement, TEMP.SENSOR, or COMP.OUT terminals.

Precautions during shipment

Observe the following during shipment.

Hioki cannot be responsible for damage that occurs during shipment.

CAUTION



- During shipment of the instrument, handle it carefully so that it is not damaged due to a vibration or shock.
- To avoid damage to the instrument, remove the accessories and optional equipment from the instrument during shipment.

If the instrument is not used for an extended period of time

IMPORTANT

To avoid corrosion and/or damage to the instrument due to battery leakage, remove the batteries from the instrument if it is to be kept in storage for an extended period.

Handling leads and cables

DANGER



To avoid electrical shock accident, do not short test leads where voltage is applied.

CAUTION



- Avoid stepping on or pinching the leads, which could damage the lead insulation.
- To avoid damaging the cables, do not bend or pull the base of cables and the leads.



- When removing a connector, hold its plug portion, not its cable, to prevent a wire disconnection.
- The ends of pin type leads are sharp. Be careful to avoid injury.
- Melted lead wire is dangerous because its metal part is exposed. Be careful not to allow contact between the lead wire and the heat generating portion.
- The Z2002 Temperature Sensor is precision-machined. Excessively high voltage pulses or static electricity may damage the sensor.
- Do not apply an excessive impact to the tip of the Z2002 Temperature Sensor or bent the lead wire. It may cause failure or wire disconnection.

IMPORTANT

- Do not use any test lead or temperature sensor other than the ones specified by our company. It may result in inaccurate measurement due to poor contact or other reasons.
- If the jack of a test lead or the temperature sensor is dirty, wipe it off. Otherwise, the contact resistance will increase, affecting the temperature measurement.
- Be careful so that the temperature sensor connector does not come off. (The temperature correction or conversion function will not work if the connector comes off.)

Before attaching the strap

CAUTION



Use the four attachment points on the instrument to attach the strap securely. Otherwise, the instrument may drop during carrying, damaging the instrument.

Batteries

WARNING



- Do not short circuit, charge, disassemble, or incinerate batteries. Doing so may cause an explosion and is dangerous.



- To avoid electric shock accident, remove any test leads before replacing batteries.
- After the replacement, be sure to reattach the cover.

CAUTION

Poor performance or damage from battery leakage could result. Observe the cautions listed below.





- Do not use both new and old batteries or different types of batteries together.
- Be careful to observe battery polarity. Otherwise, poor performance or damage from battery leakage could result.
- Do not use batteries after their recommended expiry date.
- Do not allow used batteries to remain in the instrument.







- To avoid corrosion and/or damage to the instrument due to battery leakage, remove the batteries from the instrument if it is to be kept in storage for an extended period.

IMPORTANT

- When  is lit, the battery becomes low. Replace the batteries as soon as possible. When  is blinking, the battery becomes too low for measurement. Replace the batteries.
- Be sure to turn the power off after using it.
- In this manual, the “batteries” are those used to power the instrument.
- Do not use any batteries other than the specified type (LR6 alkaline batteries). Ni-MH batteries may cause battery leakage, depending on the degree of battery charge and deterioration.
- Dispose of batteries in accordance with local regulations.

Remaining battery level indicator

| Indication | |
|---|---|
|  | The battery is fully charged. |
|  | As the remaining amount of batteries becomes low, the bars disappear from the left. |
|  | The battery becomes low. Replace the batteries as soon as possible. |
|  | (Blinking) There is no battery remaining. Replace the batteries with new ones. |

Before connecting test leads

DANGER



To avoid electric shock or short-circuit accident, turn any measurement target off before connecting test leads.

Before connecting the L2105 LED Comparator Attachment

CAUTION



- To prevent the instrument and the L2105 LED Comparator Attachment from breaking down, turn the power off before connecting the L2105 LED Comparator Attachment.
- The COMP.OUT terminal is for the L2105 only. Do not connect any terminal other than the L2105.
- Connect the temperature sensor securely. Otherwise, the specifications may not be met.
- When a tie band is used, do not tighten the test lead excessively. It could damage the test lead.
- Do not perform the following as they could damage the core or coating of a cable.
 - Twisting or pulling the cable
 - Connecting the cable around the L2105 LED Comparator Attachment by bending it compactly

Before connecting the Z2002 Temperature Sensor

WARNING



Connect the Z2002 Temperature Sensor securely. Otherwise, specifications may not be met or a failure may occur.

CAUTION



- To prevent the instrument and the Z2002 Temperature Sensor from breaking down, turn the power off before connecting the Z2002 Temperature Sensor.
- Insert the Z2002 Temperature Sensor all the way into the TEMP.SENSOR terminal. Otherwise, the measurement may have a large error.

IMPORTANT

If the jack of the Z2002 Temperature Sensor is dirty, wipe it off. Otherwise, the temperature measurement may have an error.

Measurement precautions

DANGER



To avoid electrical shock accident, do not short test leads where voltage is applied.

WARNING



- To prevent electric shock accident or damage to the instrument, do not apply voltage to any measurement terminal. To avoid electrical accident, remove power from the measurement target before measurement.

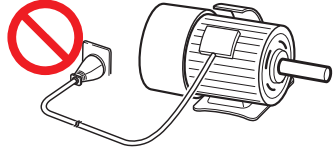

The measurement target is connected to power.

- Electrical sparks may occur at the moment of connecting/disconnecting the power cable to/from the measurement target. Do not use the instrument where combustible gases are generated.

CAUTION



- Do not measure a point where voltage is applied. When a motor is turned off, the motor does not stop immediately and is rotating inertially. And, in such a state, a large electromotive force is still being generated.

If a transformer or motor is measured immediately after a voltage withstand test, the instrument will be damaged due to induced voltage or residual charge.

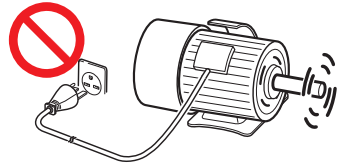

Rotating inertially

- When measuring a transformer or coil with an inductance of 5 H or more and with a resistance of 1Ω or less, do not use the $3m\Omega$ or $30m\Omega$ range in which a measurement current of 1 A flows. The instrument may be damaged.
- Do not attempt to measure the internal resistance of a battery. The instrument will be damaged. To measure internal resistance of a battery, use a HIOKI 3554, 3555, BT3562, BT3563, or 3561 Battery HiTESTER.

IMPORTANT

- The SOURCE terminals are protected with a fuse. If the fuse is broken, “FUSE” appears, and resistance cannot be measured. In such a case, replace the fuse. (p. 116)
- Since the instrument uses DC current for measurement, it may be affected by thermal EMF (thermoelectromotive force), resulting in a measurement error. If so, use the Offset Voltage Compensation function.
“4.4 Compensating for Thermal EMF Offset (Offset Voltage Compensation Function: OVC Function)” (p. 51)
“Appx. 6 Effect of Thermoelectromotive Force (Thermal EMF)” (p. Appx.8)
- When a power transformer or open solenoid coil with a high inductance, or the like is measured, the measured value may not stabilize. If so, connect a film capacitor of 1 μ F or so between the SOURCE A and B terminals.
- Ensure that the SOURCE-A, SENSE-A, SENSE-B, and SOURCE-B terminal connections are isolated from each other. If a core or shield wire touches another, the instrument will become unable to perform accurate four-terminal measurement, resulting in a measurement error.

Using the Z2002 Temperature Sensor** CAUTION**

The Z2002 Temperature Sensor does not have a waterproof construction. Do not put the sensor into water or any other liquid.

IMPORTANT

- When using the temperature correction function, wait until the measurement target and Z2002 Temperature Sensor come close enough to ambient temperature for the measurement. Otherwise, it may result in a large measurement error.
- Do not hold the Z2002 Temperature Sensor with a bare hand. It may cause enough noise pickup to destabilize the measurement.
- The Z2002 Temperature Sensor is designed for ambient temperature measurement. The temperature of a measurement target cannot be measured correctly even if the Z2002 Temperature Sensor is attached to its surface or other portion.
- Insert the Z2002 Temperature Sensor all the way into the TEMP.SENSOR terminal. Otherwise, the measurement may have a large error.

1 Overview

1.1 Overview and Features

1

The Hioki RM3548 employs the four-terminal method to highly accurately measure the DC resistance of measurement targets including motor and transformer windings, and welding, PC board patterns, fuses, resistors, and materials such as conductive rubber. The instrument allows temperature correction and so is especially suitable for measurement targets whose resistance values change with temperature.

Highly reliable specifications implemented in a compact, light-weight body

- 35,000-dgt. high resolution
- $0.1\mu\Omega$ resolution at 1 A measurement current

Neither a warm-up time nor zero adjustment is required before starting measurement

Simple temperature rise test (for temperature estimation during power stop)

- Temperature conversion and interval measurement functions
- Supports copying of measurement data file from the instrument memory to the PC

Well-designed instrument shaped for measuring without taking your hands and eyes off the target, making it ideal for maintenance and large product measurement

- Strap-attachable portable type
- Standard auto-memory and auto-hold, and optional L2105 LED Comparator Attachment

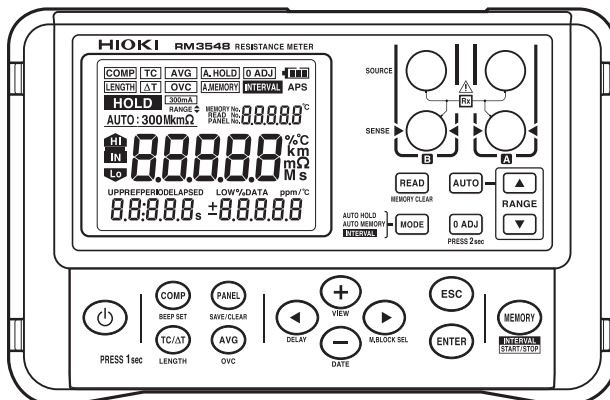

1.2 Component Names and Operation Overview

Front

Strap attachment holes (four) (p. 28)

Display (p. 22)

Measurement terminals (p. 30)

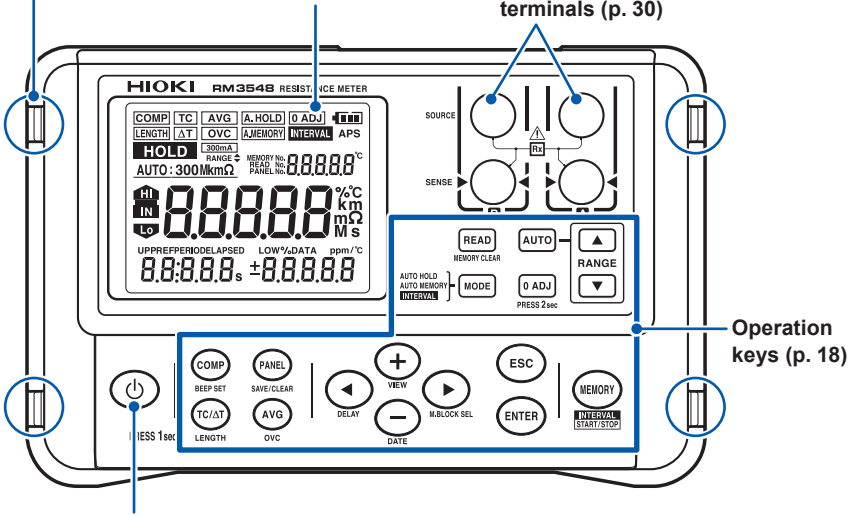

[POWER] key

Turns the power on/off. (p. 32)

Top view

COMP. OUT terminal

Connect an optional L2105 LED Comparator Attachment. (p. 66)

USB terminal

Connect a USB cable. (p. 86)

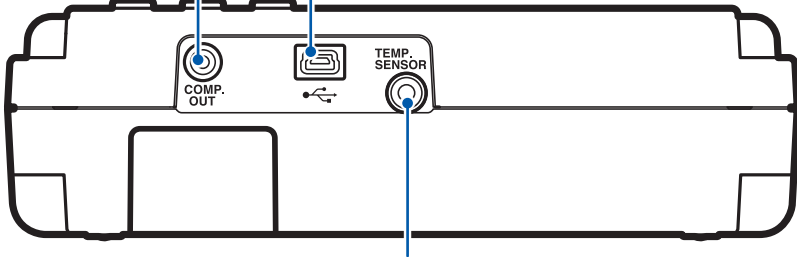

TEMP.SENSOR terminal

Connect the included Z2002 Temperature Sensor. (p. 31)

Back view

Fuse cover

Contains a fuse for measurement circuit protection. (p. 116)

Serial number

The 9-digit serial number indicates the year (first two digits) and the month of manufacture (next two digits). Do not remove this sticker as the number is important.



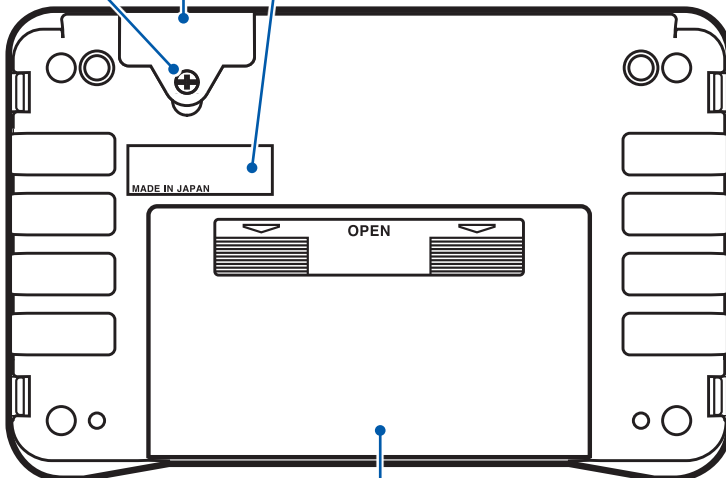







Set screw









Battery cover

Contains eight LR6 alkaline batteries. (p. 29)

Operation keys

| Key | Description |
|---|---|
|  <p>COMP BEEP SET</p> | <p>[COMP] key (p. 62)</p> <ul style="list-style-type: none"> • Comparator: oFF → ON (ABS mode) → ON (REF% mode) <p>[BEEPSET] key (press and hold) (p. 65)</p> <ul style="list-style-type: none"> • Judgment sound: oFF → Hi → in → Lo → Hi-Lo → ALL1 → ALL2 |
|  <p>TC/ΔT LENGTH</p> | <p>[TC/ΔT] key (p. 50) (p. 67)</p> <ul style="list-style-type: none"> • Temperature correction/conversion function: oFF → TC → ΔT <p>[LENGTH] key (press and hold) (p. 69)</p> <ul style="list-style-type: none"> • Length conversion function: oFF → ON |
|  <p>PANEL SAVE/CLEAR</p> | <p>[PANEL] key (p. 73)</p> <ul style="list-style-type: none"> • Panel load: Changes the panel No. "PrSEt" initializes the measurement conditions. <p>[SAVE/CLEAR] key (press and hold) (p. 72, p. 74)</p> <ul style="list-style-type: none"> • Saves and clears panels: SAve → CLr |
|  <p>AVG OVC</p> | <p>[AVG] key (p. 49)</p> <ul style="list-style-type: none"> • Averaging function: oFF → 2 → 5 → 10 → 20 <p>[OVC] key (press and hold) (p. 51)</p> <ul style="list-style-type: none"> • Offset voltage compensation (OVC) function: oFF → on |
|  <p>← DELAY</p> | <p>[←] key</p> <ul style="list-style-type: none"> • Moves to a different digit of the setting <p>[DELAY] key (press and hold) (p. 53)</p> <ul style="list-style-type: none"> • Delay function: PrSEt (factory default) → 10 ms → 30 ms → 50 ms → 100 ms → 300 ms → 500 ms → 1000 ms |
|  <p>→ M.BLOCK SEL</p> | <p>[▶] key</p> <ul style="list-style-type: none"> • Moves to a different digit of the setting <p>[M.BLOCK SEL] key (press and hold) (p. 76)</p> <ul style="list-style-type: none"> • Selects a memory block: A → b → C → d → E → F → G → H → J → L |
|  <p>+</p> <p>VIEW</p> | <p>[+] key</p> <ul style="list-style-type: none"> • Changes values and items <p>[VIEW] key (press and hold) (p. 39)</p> <ul style="list-style-type: none"> • Toggles the display: Temperature → no indicator → memory number (MEMORY No.) |
|  <p>-</p> <p>DATE</p> | <p>[-] key</p> <ul style="list-style-type: none"> • Changes values and items <p>[DATE] key (press and hold) (p. 89)</p> <ul style="list-style-type: none"> • Displays the date and time confirmation screen. |
|  <p>ESC</p> | <p>[ESC] key</p> <ul style="list-style-type: none"> • Cancels the setting (when in the setting screen) • Releases a HOLD state (if in a HOLD state) |
|  <p>ENTER</p> | <p>[ENTER] key</p> <p>Applies the setting</p> |

| Key | Description |
|--|--|
|   | <p>[MEMORY] key (p. 77)</p> <ul style="list-style-type: none"> Saves the measured values (manual memory) <p>[START/STOP] key (press and hold) (p. 79)</p> <ul style="list-style-type: none"> Starts/stops interval measurement (when in interval mode) |
|  | <p>[READ] key (p. 81)</p> <ul style="list-style-type: none"> Displays saved measurement data <p>[MEMORY CLEAR] key (press and hold) (p. 82)</p> <ul style="list-style-type: none"> Clears memory: LAsT (Latest data from the selected block) → bLoC (Selected block) → ALL (All data) |
|  | <p>[MODE] key (p. 42, p. 78, p. 79)</p> <p>Switches memory hold mode: oFF → A.HOLD (auto-hold) → A.HOLD,A.MEMORY (auto-memory) → INTERVAL (interval function)</p> |
|  | <p>[AUTO] key (p. 37)</p> <p>Turns on/off the auto range: AUTO lit → not lit</p> |
|  | <p>[0 ADJ] key (press and hold) (p. 44)</p> <p>Zero adjustment</p> |
|  | <p>[RANGE] key (p. 36)</p> <p>Measurement range: $3\text{m}\Omega \leftrightarrow 30\text{m}\Omega \leftrightarrow 300\text{m}\Omega \leftrightarrow 3\Omega \leftrightarrow 30\Omega \leftrightarrow 300\Omega \leftrightarrow 3\text{k}\Omega \leftrightarrow 30\text{k}\Omega \leftrightarrow 300\text{k}\Omega \leftrightarrow 3\text{M}\Omega$</p> |

Operation overview

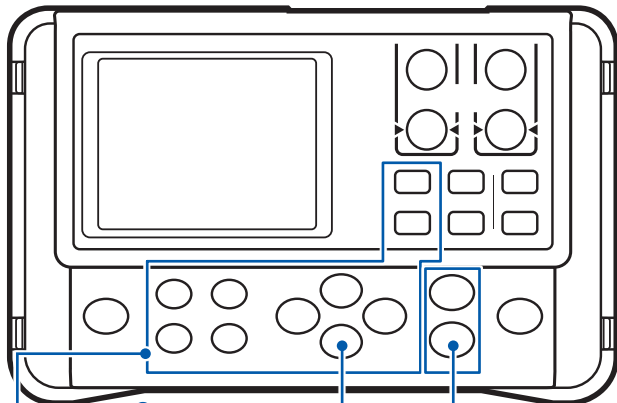

1 Select a function.

The function shown below each key can be selected by pressing and holding the key.

COMP — Name of the key that turns ON when it is pressed

BEEP SET — Name of the key that turns ON when it is pressed and held

2 Configure settings.

Changes items/values.

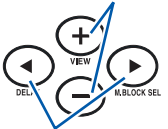

Moves digits.

3 Apply settings.



















ESC — Cancel

ENTER — Apply

Power-on settings

To perform one of the following settings, it is necessary to turn the power from off to on while holding-down a particular key.

For details, see the indicated page.

| | |
|--|--|
| Clearing zero adjustment (p. 48) |  +  |
| Switching to a different measurement current (p. 55) |  +  |
| Disabling auto power save (APS) (p. 33) |  +  |
| Changing the decimal point character or delimiter character for a CSV file (p. 88) |  +  |
| Setting the date and time (p. 90) |  +  |
| Clearing all measurement data saved (p. 85) |  +  |
| Resetting the current measurement conditions (p. 91) |  +  +  |
| Resetting the system (p. 91) |  +  +  +  |

1.3 Flow of Measurement

Before using the instrument, be sure to see “Usage Notes” (p. 7).

Preparing for measurement

1 Attach the strap. (p. 28)

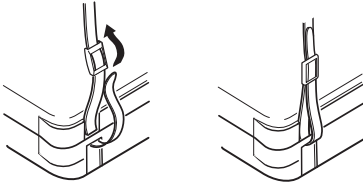

2 Load or replace the batteries. (p. 29)

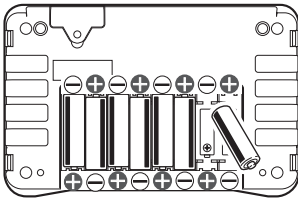

3 Connect the test leads. (p. 30)

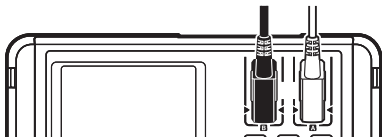

4 Connect a Z2002 Temperature Sensor. (p. 31)

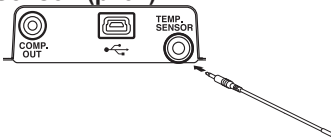

Measurement

1 Turn the power on and configure settings.* (p. 32)

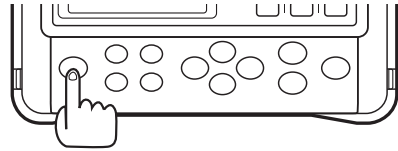

2 Connect the test leads to the measurement target. (p. 38)

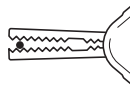
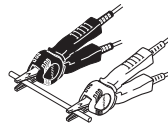

Clipping a thin wire (with the edge portion of the jaws)

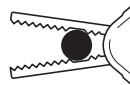

Clipping a thick wire (with the base, non-serrated portion of the jaws)

3 Read the measured value. (p. 39)

4 Remove the test leads from the measurement target and turn the power off. (p. 32)

* In the following cases, perform zero adjustment:

The display is not cleared due to thermal EMF or other factors. → The display will be changed to zero.

(Accuracy is not affected by whether or not the zero adjustment is performed.)

Thermal EMF can also be canceled by using OVC. (p. 51)

Four-terminal connection (called Kelvin connection) is difficult.

→ The residual resistance of the two-terminal connection wires will be canceled.

For zero adjustment procedures, see (p. Appx.11).

1.4 Screen Layout

Display (when the entire display is lit)

Displays measurement conditions, settings, measured values, memory numbers (MEMORY No.), panel numbers, comparator settings, judgment results, etc. For information on the error display, see “Error display and actions” (p. 114).

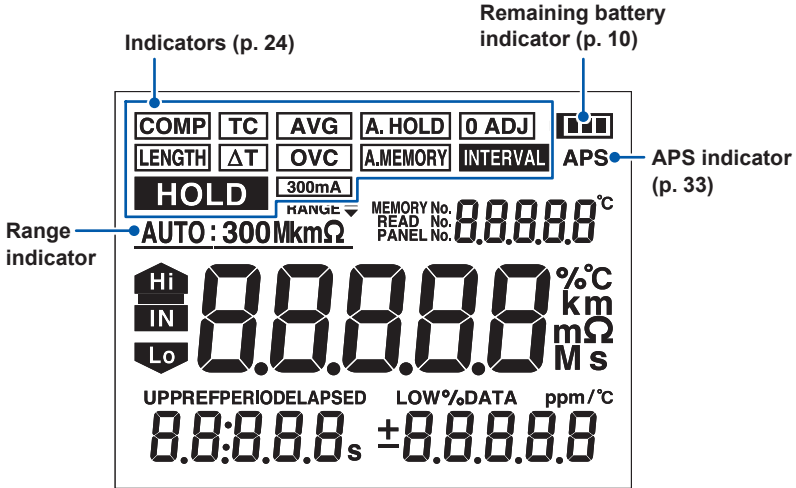

Resistance measurement screen

Using the [VIEW] key to switch the indicator display (p. 39)
 (Temperature, no indicator, memory number (MEMORY No.))

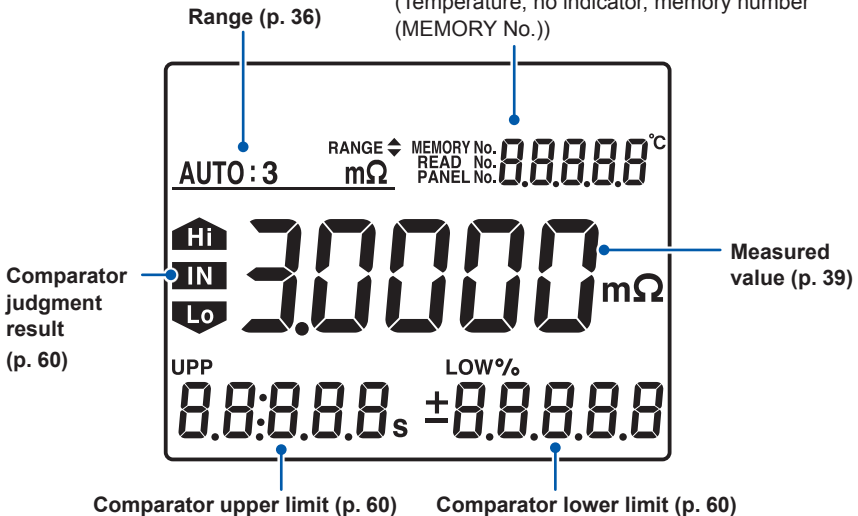

Length conversion measurement screen (p. 69)

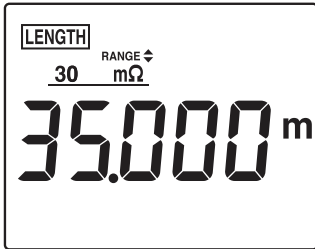

Temperature conversion (ΔT) measurement screen (p. 67)

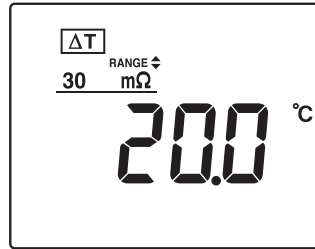

Interval measurement screen (p. 79)

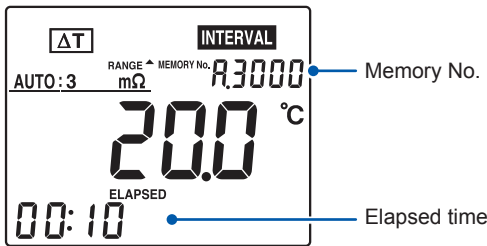

(The screen shows when ΔT is ON.)

Non-measured value display (see “Verifying measurement errors” (p. 40) for details)

Out-of-range

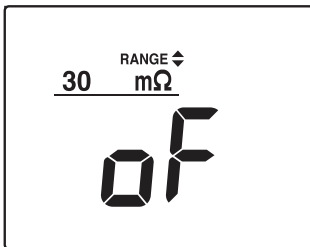

Current fault

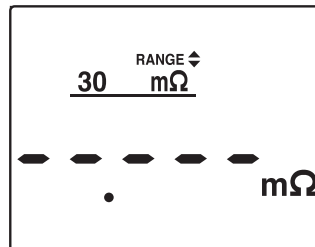

The protection function is working

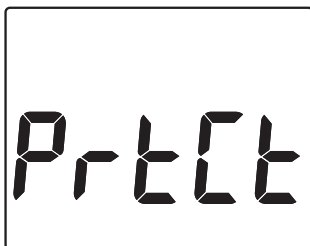



Fuse blown out



| Indicator | Description | See |
|-----------------|--|---------|
| COMP | Lit: The comparator function is enabled. Blinking: The processing of the key pressed cannot be performed because the comparator function is enabled. | (p. 62) |
| LENGTH | Lit: The length conversion function is enabled. Blinking: The processing of the key pressed cannot be performed because the length conversion function is enabled. | (p. 69) |
| TC | The temperature correction function is enabled. | (p. 50) |
| ΔT | Lit: The temperature conversion function is enabled. Blinking: The processing of the key pressed cannot be performed because the temperature conversion function is enabled. | (p. 67) |
| AVG | The measured value averaging function is enabled. | (p. 49) |
| OVC | The OVC function is enabled. | (p. 51) |
| A. HOLD | The auto-hold function is enabled. | (p. 42) |
| A.MEMORY | The auto-memory function is enabled. | (p. 78) |
| 0 ADJ | Lit: The zero adjustment function is enabled. Blinking: Zero adjustment is in progress. | (p. 44) |
| INTERVAL | Lit: The interval measurement function is enabled. Blinking: The processing of the key pressed cannot be performed because interval measurement is being performed or the interval measurement function is enabled. | (p. 79) |
| 300mA | The measurement current is set to Hi (300 mA) at the 300mΩ range. | (p. 55) |
| HOLD | The measured value is being held. | (p. 42) |
| Hi | The comparator judgment result shows "measured value > upper limit". | (p. 60) |
| IN | The comparator judgment result shows "lower limit ≤ measured value ≤ upper limit". | |
| Lo | The comparator judgment result shows "measured value < lower limit". | |
| RANGE ⇄ | The range can be changed. | (p. 36) |
| AUTO: | The auto range function is enabled. | (p. 60) |
| UPP | Comparator upper limit value | |
| LOW | Comparator lower limit value | |
| REF | Comparator reference value | |
| % | Comparator allowable range | |
| PERIOD | Retainable period of time (when in interval mode) | (p. 79) |
| ELAPSED | Measurement elapsed time (when in interval mode) | (p. 79) |
| DATA | Number of data items that can be retained | (p. 76) |
| ppm/°C | Temperature coefficient for temperature correction (when temperature correction is enabled) | (p. 50) |

1.5 Checking the Measurement Target

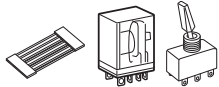
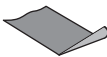
To carry out proper resistance measurement, change the measurement conditions appropriately according to the measurement target. Before starting measurement, use the examples recommended in the following table to configure the instrument.

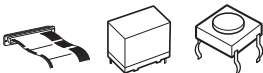
| Measurement target | Recommended settings (Bold indicates a change from the factory default.) | | |
|---|---|-------------|--|
| | Temperature correction (p. 50)/ Temperature conversion (p. 67) | OVC (p. 51) | Measurement current at 300mΩ range (p. 55) |
| Motor, solenoid, choke coil, transformer, wiring harness  | TC | OFF | Lo |
| For power Contact, wiring harness, connector, relay contact, switch  | *1 | ON | Lo |
| Conductive coating material, conductive rubber  | - | OFF | Lo |
| General resistance measurement Fuse, resistor, heater, wiring, welding  | *1 | ON | Lo |
| Temperature rise test (Motor, choke coil, transformer)  | ΔT^{*2} | OFF | Lo |
| Automobile ground wire | *1 | ON | Hi (300mA) |
| For signal Contact, wiring harness, connector, relay contact, switch  | If the instrument is used to measure the resistance of a signal contact, the contact status will be changed, because its open-circuit voltage and measurement current are both high. To measure a signal contact, use the RM3545. | | |

Checking the Measurement Target

- *1 When the measurement target significantly depends on temperature, use the temperature correction function.
- *2 The interval measurement function allows you to save a measured value every fixed interval. (p. 79)

IMPORTANT

If a measurement fails with the PrSEt (preset) delay setting, set a long enough delay time. (p. 53)

2

Preparing for Measurement

2

Before using the instrument, be sure to see “Usage Notes” (p. 7).

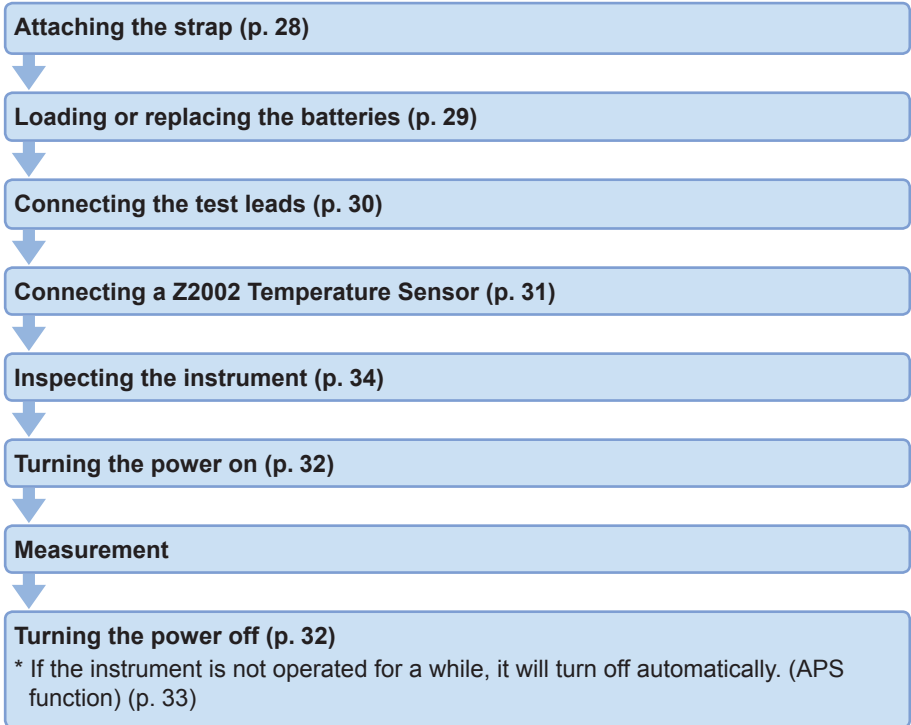

2.1 Attaching the Strap

Attaching the strap to the instrument allows you to use it with the strap around your neck. Follow the procedure below to attach the strap.

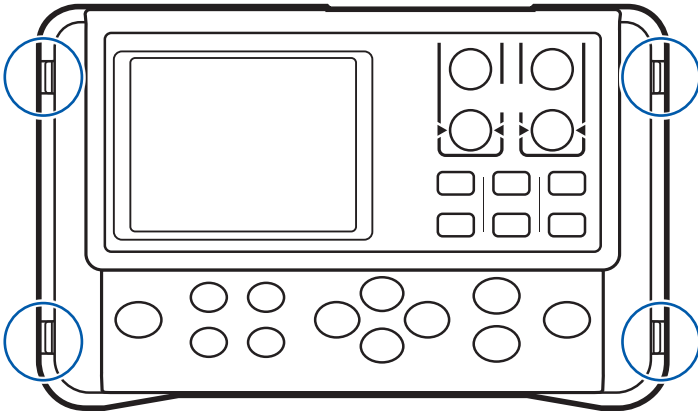
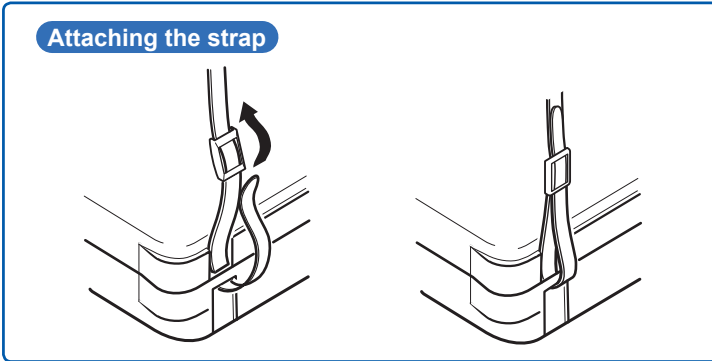

2.2 Loading or Replacing the Batteries

2

Before using the instrument for the first time, load the eight alkaline batteries (LR6). Before measurement, check that the instrument has sufficient remaining battery power. If the remaining battery level is low, replace the batteries. See the battery indicator to check the remaining battery level. (p. 10)

Preparations

- Alkaline battery (LR6) × 8

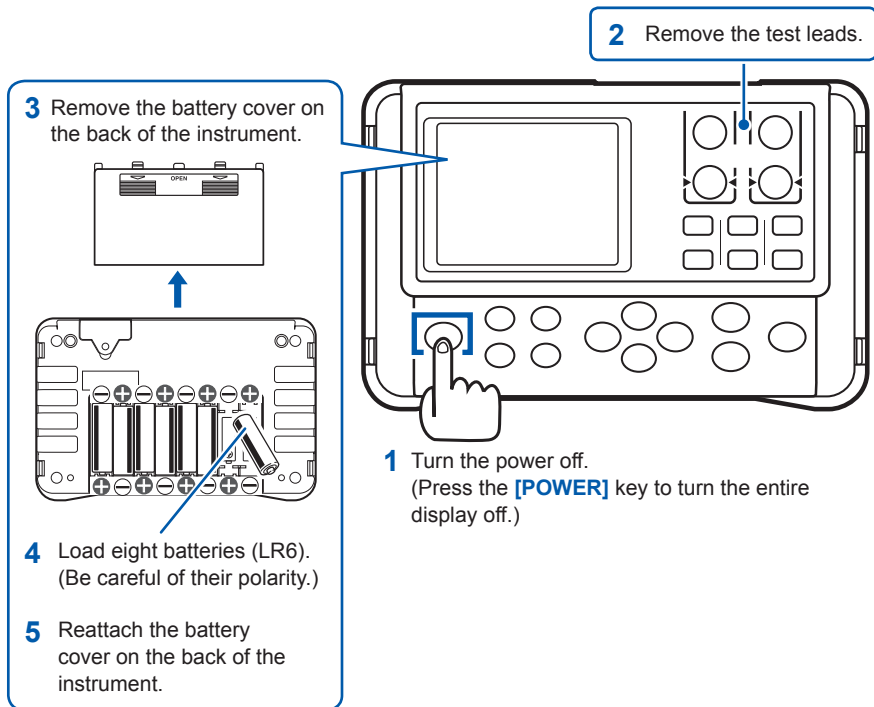

2.3 Connecting the Test Leads

Use the included L2107 Clip Type Leads or select from our wide range of optional test leads. For more information on the lead options, see “Options” (p. 3).

Test leads

(Example: L2107 Clip Type Leads)

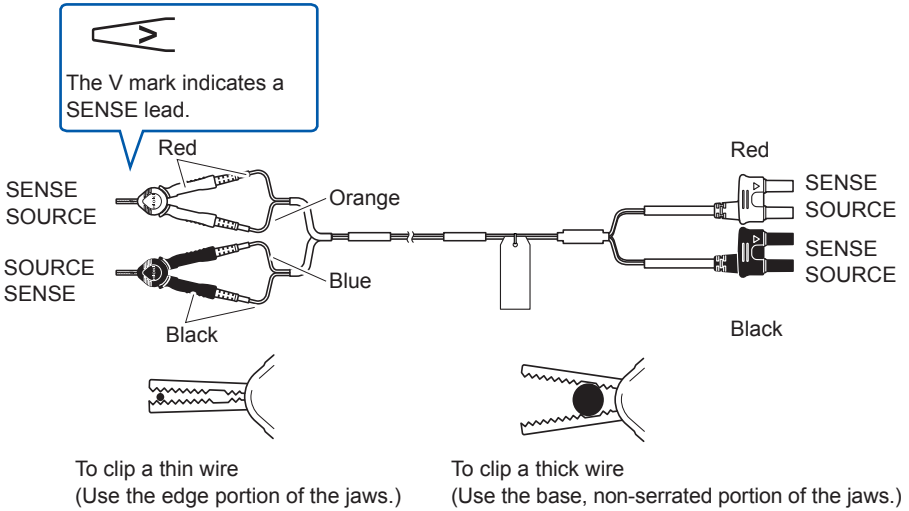

Connect the test leads to the instrument.

Connect the four terminals: SOURCE (A and B) and SENSE (A and B).

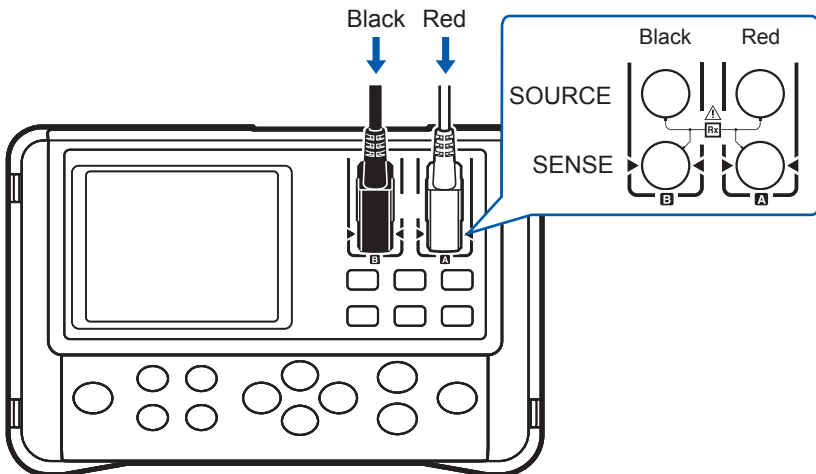

2.4 Connecting the Z2002 Temperature Sensor (When Using TC or ΔT)

2

Connect the Z2002 Temperature Sensor to the TEMP.SENSOR terminal.

Connection method

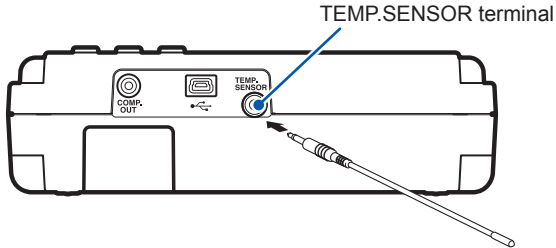

Fully insert the jack.

2.5 Turning the Power On/Off

Turning the power on

Press the **[POWER]** key to turn the power on. Hold the key down until the entire display turns on.

The diagram illustrates the power-on sequence. It starts with a self-test screen showing various instrument parameters like COMP, TC, AVG, A.HOLD, O ADJ, and a large display of '8888.88'. A hand is shown pressing the [POWER] key. Below this, the measurement screen shows 'AUTO: 3' and a reading of '30000 mΩ'. A second hand is shown pressing the [POWER] key again. A callout box titled 'If an error occurs during the self-test' shows the display reading 'Err 96' and notes that the error is displayed (p. 114).

Entire display lit

A self-test is started. The model name and version number are displayed during the self-test.

Measurement screen

[POWER] key

If an error occurs during the self-test

The error is displayed. (p. 114)

Turning the power off

Press the **[POWER]** key to turn the power off. Hold the key down until the entire display turns off.

The diagram shows the power-off sequence. A hand is shown pressing the [POWER] key. A callout box shows a greyed-out display area labeled 'Entire display off'.

Entire display off

[POWER] key

IMPORTANT

When the instrument is turned on again, it starts up with the previous state used immediately before turning it off.

Automatic power off with auto power save (APS)

When the instrument is not being used, the APS function automatically turns it off to reduce battery consumption.

APS function ON

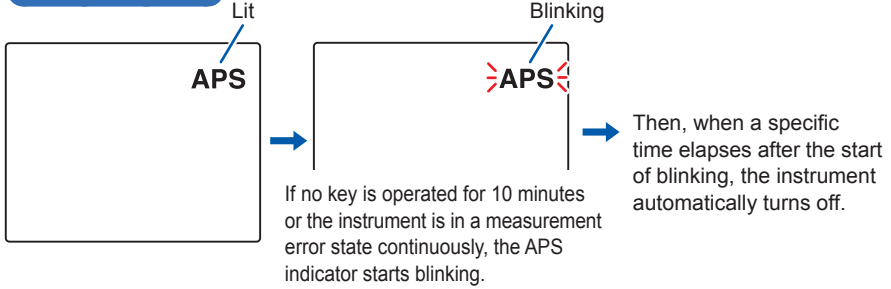

IMPORTANT

- During an interval measurement, the APS function automatically turns OFF. When the interval measurement ends, the APS function automatically turns ON.
- When the USB is connected, the APS function automatically turns OFF. When the USB is disconnected, the APS function automatically turns ON.

Disabling auto power save (APS)

To disable the APS function, press the **[POWER]** key while holding the **[MEMORY]** key down when the power is off.

The setting of the APS function is not saved. When the instrument is turned on again, the APS function is enabled again.

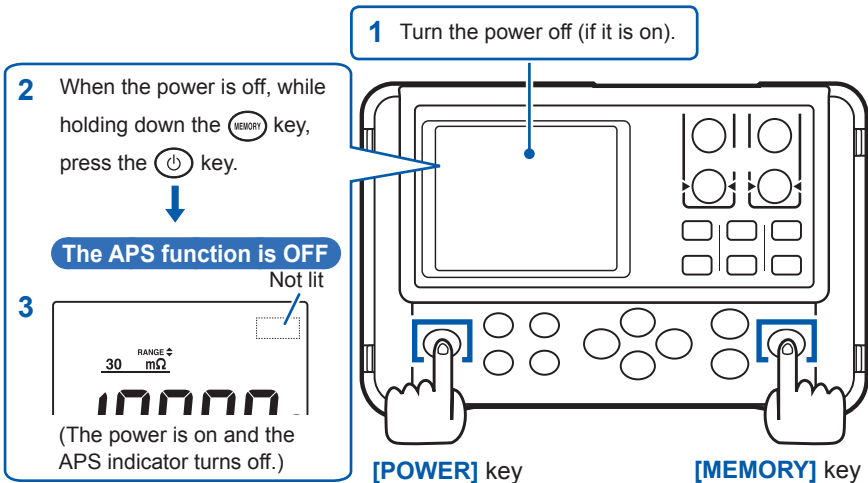



2.6 Pre-measurement Inspection

Before using the instrument, inspect it to verify that no damage has occurred during storage or transportation and it operates normally. If you find any damage, contact your authorized Hioki distributor or reseller.

Instrument and peripheral checking

| Inspection item | Action |
|--|---|
| Is there any damage or a crack in the instrument? Are the internal circuits exposed? | If any damage is found, do not use it. Return it for repair. |
| Is there any dust or contamination, such as pieces of metal, on any terminals? | If dust or contamination is adhered to a terminal, clean the terminal with a swab or the like. |
| Is the test lead coating broken or is the metal exposed? | If the coating of a test lead is broken, the measured value may become unstable or have an error. Replace the damaged test lead. |

Power-on checking

| Inspection item | Action |
|--|--|
| Is the remaining battery power sufficient? | The  indicator at the upper right of the display indicates the current status. If the indicator changes to  , the remaining battery level is low. Replace the batteries as early as possible. If the battery level becomes too low to continue with measurement, the  starts blinking. Replace the batteries. |
| Is anything missing from the screen? | Turn the power on to make sure that the entire display turns on. (p. 22) If there is anything missing, return the instrument for repair. |
| When you turn the power on, does the entire display turn on and then the model name and a measurement screen appear on the screen? | If the screen does not behave like this, the instrument may be damaged internally. Return it for repair. See: “10.1 Troubleshooting” (p. 108) “Error display and actions” (p. 114) |

3

Basic Measurement

Before measurement, be sure to see “Measurement precautions” (p. 12).

This chapter describes the basic operations for using the instrument.

- “3.1 Setting the Measurement Range” (p. 36)
- “3.2 Connecting the Test Leads to the Measurement Target” (p. 38)
- “3.3 Reading the Measured Value” (p. 39)

For information on how to customize measurement conditions, see “Customizing Measurement Conditions” (p. 43).

3.1 Setting the Measurement Range

Select a measurement range. Automatic range selection (the auto range) is also available.

IMPORTANT

When the auto range is used or the measurement range is set to 30mΩ or less, a maximum current of 1 A may constantly flow through the measurement target, and a maximum power of approximately 2 W may be applied*.

If there are any of the following concerns, depending on the level of the measurement current, select a range using a lower measurement current.

- The measurement target may melt (such as a fuse or inflator).
- The measurement target may heat up, causing a change in resistance.
- The measurement target may be magnetized, causing a change in inductance.

Within each of the measurement ranges, the power for the measurement target can be expressed by “resistance × (measurement current)²”. If the measurement range is deviated, the power may reach the value of “open-circuit voltage × measurement current” at maximum.

Before connecting the measurement target, be sure to check the measurement range.

* At the moment of connecting the measurement target, a maximum inrush current of 5 A flows.
(Convergence time: Approximately 1 ms for pure resistance)

Using the manual range

3mΩ ↔ 30mΩ ↔ 300mΩ ↔ 3Ω ↔ 30Ω ↔ 300Ω ↔ 3kΩ ↔ 30kΩ ↔ 300kΩ ↔ 3MΩ

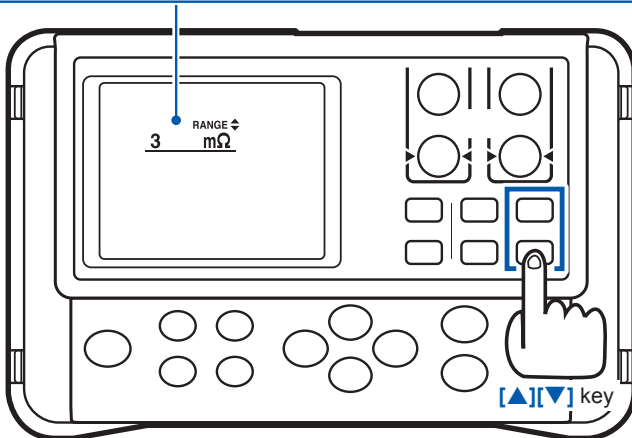

Using the auto range

Use the **[AUTO]** key to switch to the auto range. (The default setting is AUTO.)
When the instrument is in the auto range mode, AUTO is lit.

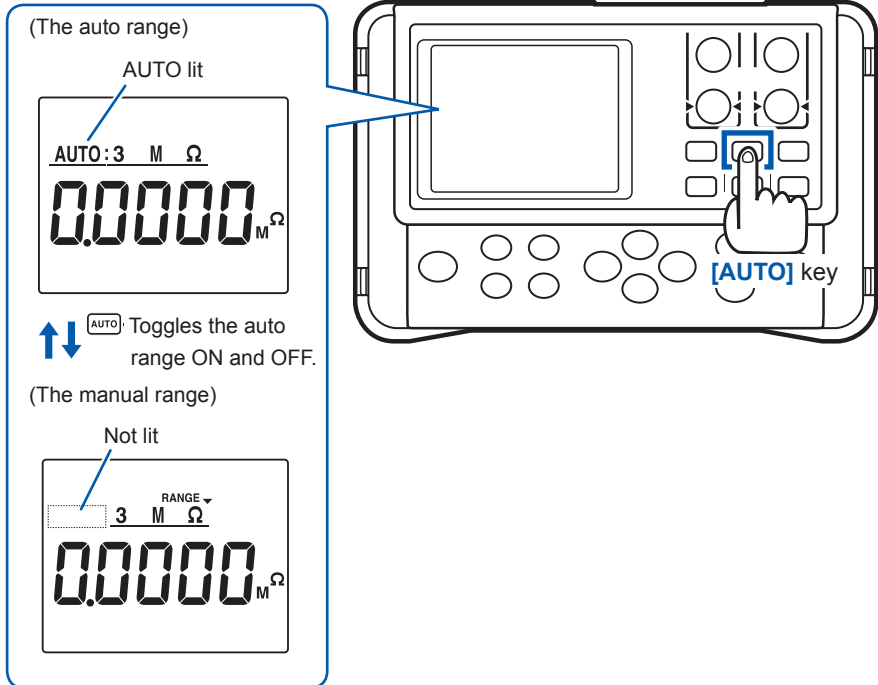

3

IMPORTANT

- When the range is manually changed in the auto range mode, the auto range is automatically disabled and the manual range is enabled.
- If the comparator function is turned ON, the range is fixed and cannot be changed. To change the range, turn the comparator function OFF or change the range in the comparator setting.
- Depending on the measurement target, the auto range may become unstable. In such a case, specify the range manually or increase the delay time. (p. 53)
For the measurement accuracy of each range, see “(1) Resistance measurement accuracy” (p. 93).

3.2 Connecting the Test Leads to the Measurement Target

Example: Using the L2107

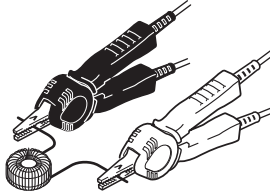

Example: Using the 9772

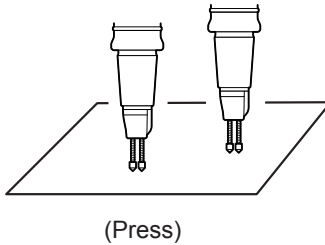

Example: Using the 9453

The SENSE terminals should be located inside the SOURCE terminals.

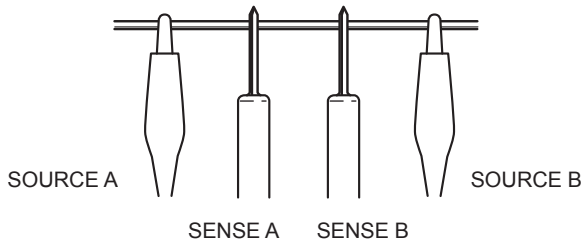

3.3 Reading the Measured Value

The instrument displays a resistance value.

If a non-resistance value is displayed, see “Verifying measurement errors” (p. 40).

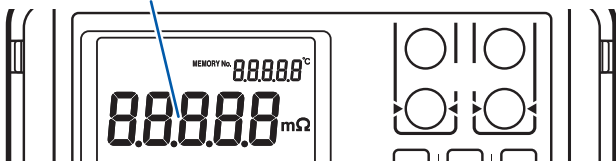

To convert the measured resistance value, see the following pages:

- “5.2 Performing Temperature Rise Test (Temperature Conversion Function (ΔT))” (p. 67)
- “5.3 Measuring the Length of a Conductor (Length Conversion Function)” (p. 69)

IMPORTANT

If the measured value has a negative sign (-), check the following:

- The SOURCE and SENSE lead connections are reversed.
→ Connect the leads correctly.
- After zero adjustment for a two-terminal measurement, the contact resistance has decreased.
→ Perform zero adjustment again.

Switching the display

Press and hold the **[+] (VIEW)** key to switch the type of information displayed on the upper right of the screen. (Temperature, no indicator, memory number (MEMORY No.))

The type of information displayed during measurements can be selected.

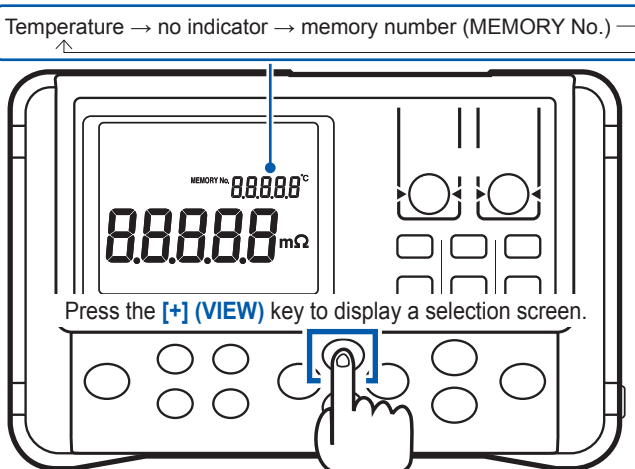

Press and hold

Verifying measurement errors

If a measurement is not performed correctly, the measurement error is displayed on the screen.

Out-of-range*1

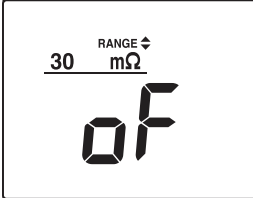

Indicates that the measurement or display range has been exceeded.

If oF is displayed, the comparator judgment is “Hi”, and if -oF is displayed, the comparator judgment is “Lo”.

In the same manner, oF is displayed when the temperature exceeds the measurement range during temperature measurement.

Current fault or not measured yet

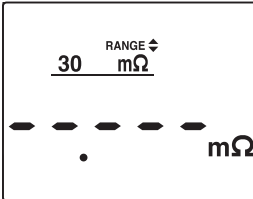

This screen is displayed in the following two cases.

If “-----” is displayed, comparator judgment is not performed.

1. Measurement current fault*2
Current cannot be supplied to the SOURCE A or SOURCE B terminals.
2. No measurement has been performed after changing a measurement condition.

The protection function is working

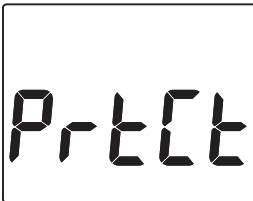

If an overvoltage is applied to a measurement terminal, the function for protecting the internal circuitry is activated in this instrument. If an overvoltage is accidentally applied, remove the test leads from the measurement target immediately. Measurement cannot be performed while the protection function is activated. In order to cancel the protection function, contact test lead A (red) to B (black) or turn the power off and on.

Fuse blown out



Each SOURCE terminal of the instrument is equipped with a fuse to protect against overvoltage input. If an overvoltage is accidentally applied and a fuse is blown, replace the fuse. (p. 116)

Z2002 Temperature Sensor not connected

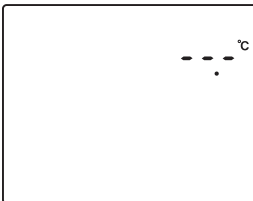

Temperature cannot be measured as the Z2002 Temperature Sensor is not connected. When TC or ΔT is not used, it is not necessary to connect the Z2002 Temperature Sensor. If the temperature is not to be displayed, switch the display by pressing the **[+]** (VIEW) key.

Temperature calculation error



The Z2002 Temperature Sensor is not connected even when TC or ΔT is ON, or oF is displayed for the temperature. Check the connection of the Z2002 Temperature Sensor.

IMPORTANT

If the measurement target is connected to the SOURCE terminal, but a SENSE terminal has a bad contact, the displayed measured value may be unstable.

3

*1 Out-of-range detection function

Examples detected as out-of-range

| Out-of-range detection | Measurement examples |
|---|--|
| The measurement range is exceeded. | 40m Ω is measured in the 30m Ω range. |
| The relative display (% display) of a measured value exceeds the display range (999.99%). | 500 Ω (+2400%) is measured with a reference value of 20 Ω . |
| The A/D converter input range is exceeded during a measurement. | Such an error occurs, for example, if a high resistance is measured in an environment with external noise. |
| The calculation result cannot be displayed. | The calculation result for the length conversion function exceeds 999.99 km. |

*2 Current fault detection function

Current fault examples

- The SOURCE A or SOURCE B probe is open.
- The measurement target has a broken wire (open-circuit work).
- The SOURCE A or SOURCE B wiring has a broken wire or a bad connection.

IMPORTANT

A wiring resistance exceeding the following value in each range causes a current fault, making the measurement impossible. In the 1 A measurement current range, reduce the resistance of the wiring and contact between the measurement target and test leads.

| Range [Ω] | 3m | 30m | 300m | 3 | 30 | 300 | 3k | 30k to 3M |
|--|-----|-----|------|---|-----|-----|-----|-----------|
| Wiring and contact resistance [Ω] | 0.5 | | 10 | | 100 | 2k | 800 | 2k |

The values listed above, which is for reference, indicate resistance values between the SOURCE B and SOURCE A, not including the measurement target.

Holding a measured value

The auto-hold function helps to verify a measured value. When the measured value becomes stable, the value is automatically held.

- 1 OFF → **Auto-hold (A.HOLD)** → Auto-memory (A.HOLD, A.MEMORY) → Interval (INTERVAL) → OFF

- 2  Cancel
 Apply

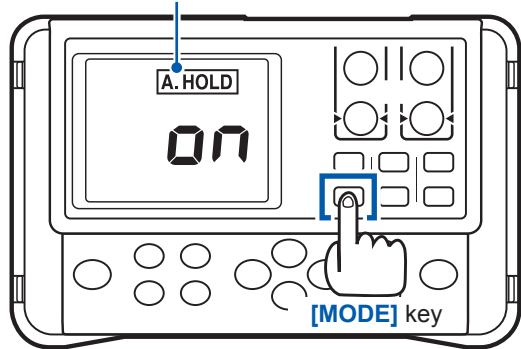

- 3 **During measurement (during release from HOL During HOLD**

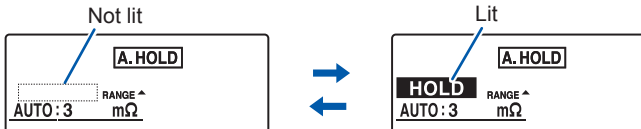

Release the test leads from the measurement target and contact the leads to the target again. The HOLD is released. You can also release the HOLD by changing the range or pressing the [ESC] key.

Memorizing a measured value

The memory function helps to verify a measured value later. It saves the displayed measured value.

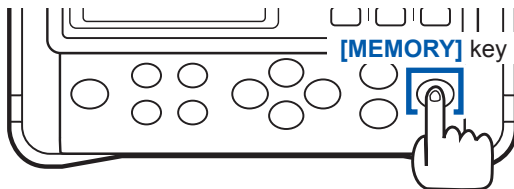

For more details about the memory function, see “7.1 Saving Data at Specified Time (Manual Memory)” (p. 77).

Before measurement, be sure to see “Measurement precautions” (p. 12).

This chapter describes the functions useful to perform more sophisticated and accurate measurement.

- “4.1 Using Zero Adjustment” (p. 44)
- “4.2 Stabilizing Measured Values (Averaging Function)” (p. 49)
- “4.3 Compensating for Thermal Effects (Temperature Correction (TC))” (p. 50)
- “4.4 Compensating for Thermal EMF Offset (Offset Voltage Compensation Function: OVC Function)” (p. 51)
- “4.5 Setting the Delay Time for Measurement (Delay Function)” (p. 53)
- “4.6 Switching the Measurement Current (In the 300mΩ Range)” (p. 55)

4.1 Using Zero Adjustment

In the following cases, perform zero adjustment:

(A resistance of up to $\pm 3\%$ f.s. can be canceled for any range.)

- The measurement value is not cleared due to thermal EMF or other factors.
→ The measurement value will be changed to zero.
Accuracy is not affected by whether or not the zero adjustment is performed.
The thermal EMF can also be canceled by using OVC. (p. 51)
- Four-terminal connection (called Kelvin connection) is difficult.
→ The residual resistance of the two-terminal connection wires will be canceled.
(p. Appx.24)

For instructions on how to perform zero adjustment correctly, see “Appx. 7 Zero Adjustment” (p. Appx.11).

Before zero adjustment

IMPORTANT

- When the ambient temperature changes or the test leads are replaced after zero adjustment, perform zero adjustment again. If zero adjustment is difficult because the Pin Type Lead 9465-10, 9772, or the like is used, use the standard Clip Type Lead L2107 to perform zero adjustment and then replace the lead with the Pin Type Lead.
- Perform zero adjustment for each range used. In the manual range mode, only the current range is adjusted to zero. In the auto range mode, all ranges are adjusted to zero.
- Zero adjustment values are held internally even if the instrument is power off, but they are not saved in the panel.
- When the offset voltage compensation (OVC) function is turned from ON to OFF or from OFF to ON, the zero adjustment is cleared. Perform zero adjustment again.
- When the measurement current is changed from Lo to Hi or from Hi to Lo, the zero adjustment is cleared. Perform zero adjustment again.
- When a lower resistance is measured after zero adjustment, the measured value will be negative.
Example: $2\text{m}\Omega$ is connected in the $300\text{m}\Omega$ range and then zero adjustment is performed.
→ If $1\text{m}\Omega$ is measured, $-1\text{m}\Omega$ is displayed.

Performing zero adjustment

1 Short the test leads.

L2107

Correct

Align the V symbols on the clips.

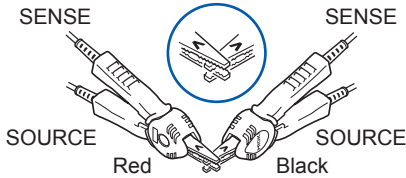

Incorrect

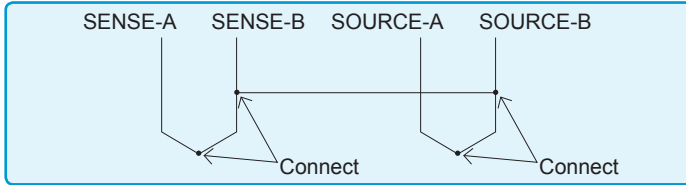
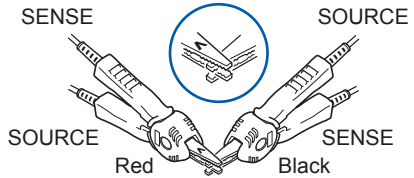

4

9453 (Option)

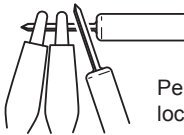

Perform zero adjustment while the alligator clips are located outside and the lead bar is located inside.

9465 (Option)

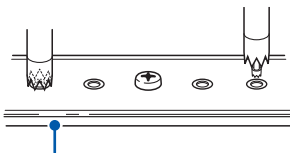

9454 Zero Adjustment Board (Option)

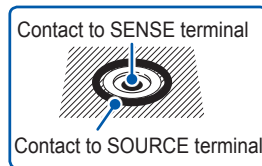

9772 (Option)

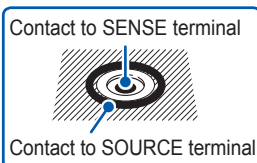

9454 Zero Adjustment Board (Option)

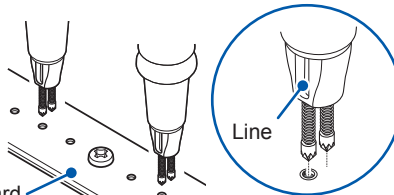

For the pin on the SENSE side, a line is attached to the base section.

When performing zero adjustment, be sure that this line faces the same direction on all of the pins.

2 Confirm that the measured value is within $\pm 3\%$ f.s.

If no measured value is displayed, make sure that the test leads are connected correctly.

If the connection is correct

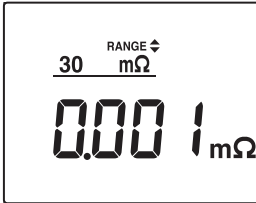

If the connection is wrong

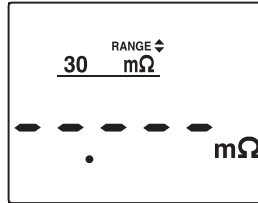

3 Press and hold the [0 ADJ] key to perform zero adjustment.

If it is difficult to press the key as the Zero Adjustment Board is used, press the [0 ADJ] key before shorting the measurement lead. Zero adjustment is automatically performed after the measured value is stabilized.

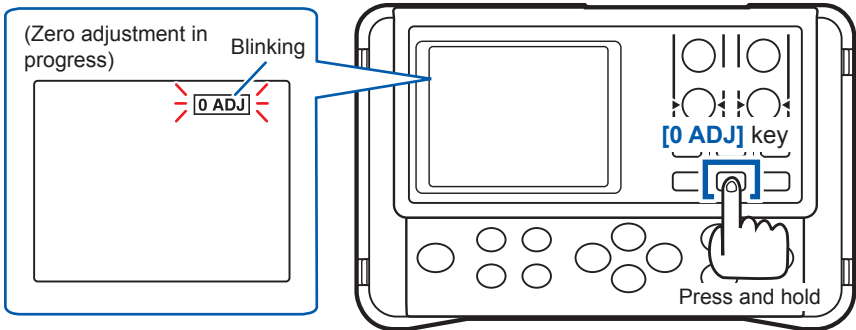

4 After zero adjustment

Zero adjustment has succeeded

The buzzer sounds and the measurement screen appears.

Indicator ON

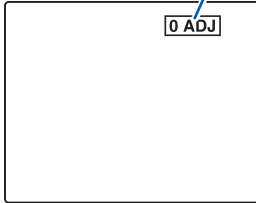

Zero adjustment has failed

The buzzer sounds and [FAIL] appears. Then, the measurement screen appears.

Indicator OFF

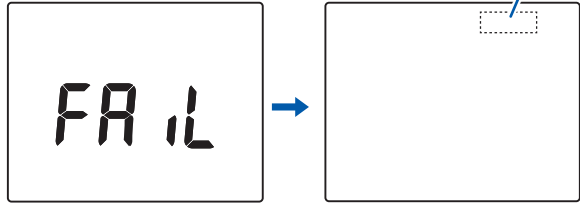

4

Zero adjustment failed

When zero adjustment cannot be performed, the measured value before zero adjustment already exceeds $\pm 3\%$ of the full scale of each range or the instrument is in a measurement error state. Perform zero adjustment with the correct wire connection again. If the resistance is too high (e.g., due to a self-made cable), zero adjustment cannot be performed. In such a case, try to minimize the wiring resistance. (p. 41)

IMPORTANT

- If zero adjustment fails in the auto range mode, the zero adjustment is cleared for all ranges.
- If zero adjustment fails in the manual range mode, the zero adjustment is cleared for the current range.

Clearing zero adjustment

When the power is off, while holding the **[0 ADJ]** key, press the **[POWER]** key to clear the zero adjustment for all ranges.

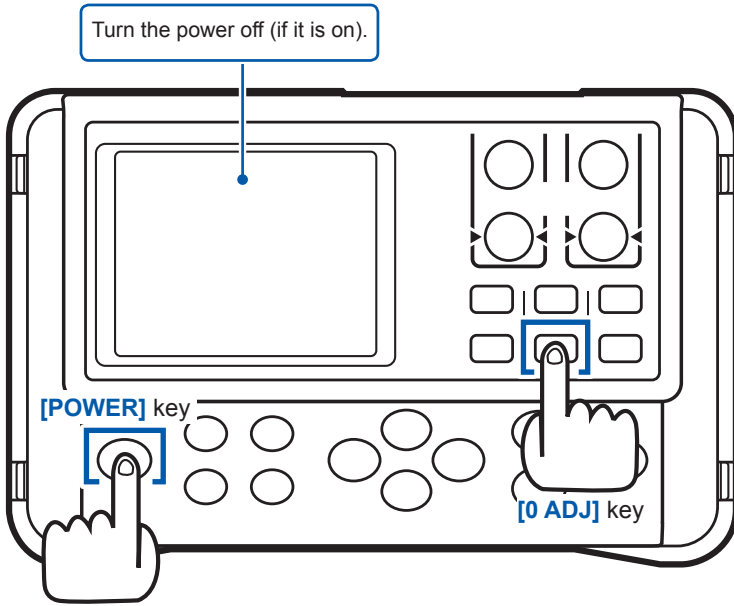

4.2 Stabilizing Measured Values (Averaging Function)

This function averages the measurement values in order to display a single value. It helps to stabilize fluctuations in the measured values.

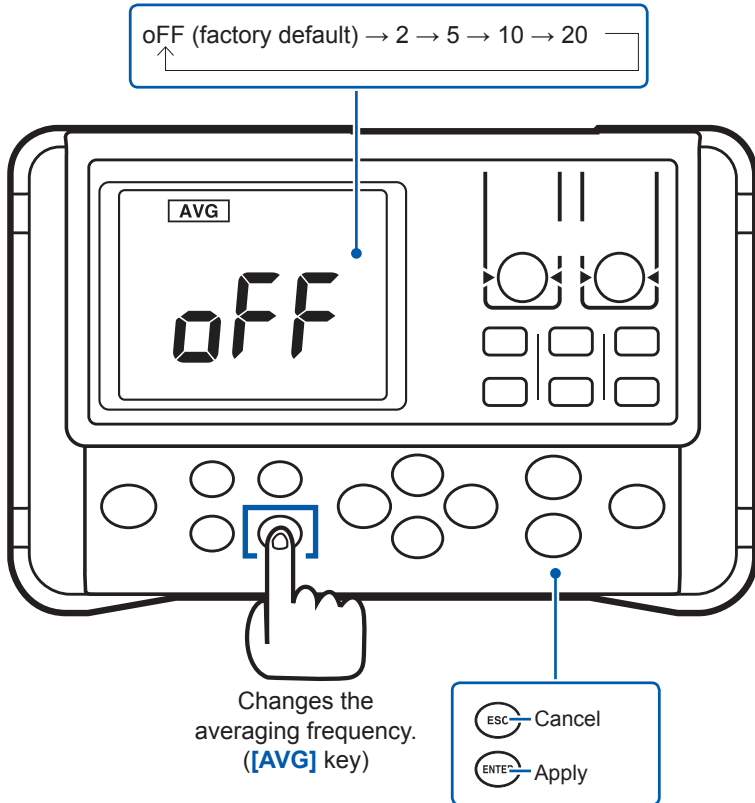

The averaging frequency can also be changed with \oplus \ominus .

4.3 Compensating for Thermal Effects (Temperature Correction (TC))

This function converts a measured resistance value, based on the reference temperature, to display the converted value. For the principles of temperature correction, see “Appx. 4 Temperature Correction Function (TC)” (p. Appx.4). To perform temperature correction, connect the Z2002 Temperature Sensor to the TEMP.SENSOR terminal on the side of the instrument. Before connecting the sensor, be sure to read “2.4 Connecting the Z2002 Temperature Sensor (When Using TC or ΔT)” (p. 31).

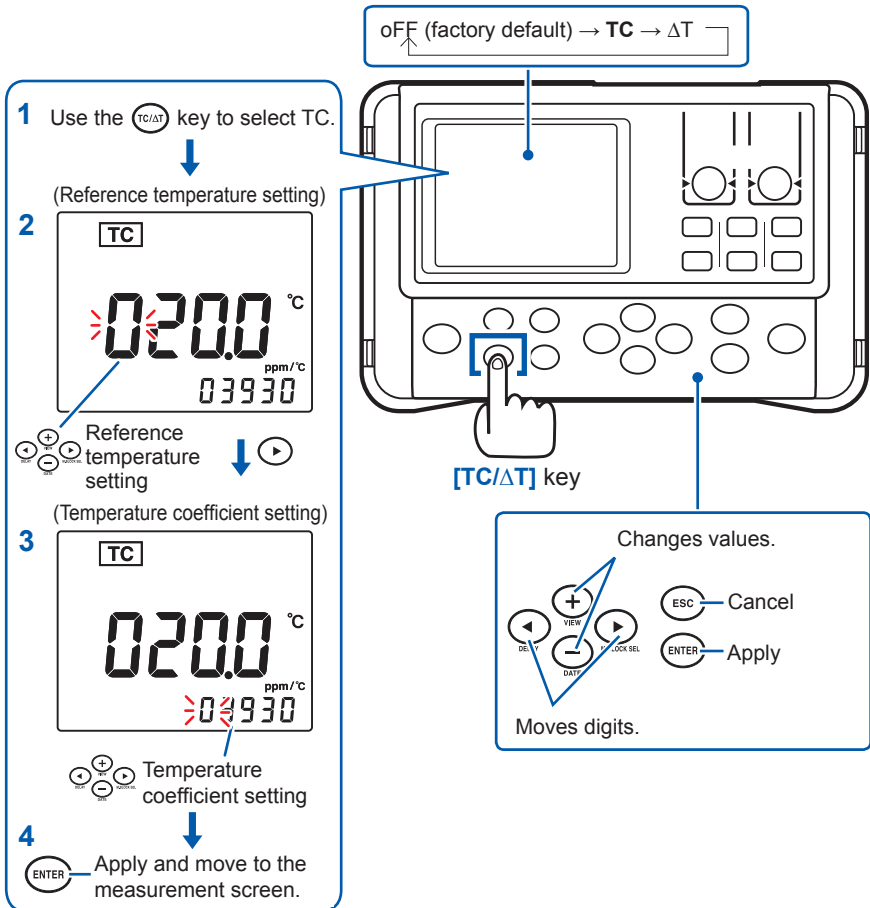

IMPORTANT

If “t.Err” is displayed, the Z2002 Temperature Sensor may not be connected, or oF is displayed for the temperature. Check the connection of the Z2002 Temperature Sensor.

4.4 Compensating for Thermal EMF Offset (Offset Voltage Compensation Function: OVC Function)

This function automatically compensates for an offset voltage caused by thermal EMF or an internal offset voltage.

(OVC: Offset Voltage Compensation)

See: “Appx. 6 Effect of Thermoelectromotive Force (Thermal EMF)” (p. Appx.8)

The function uses the resistance value measured when a measurement current flows, R_p and that measured when no measurement current flows, R_z , to display the actual resistance value $R_p - R_z$.

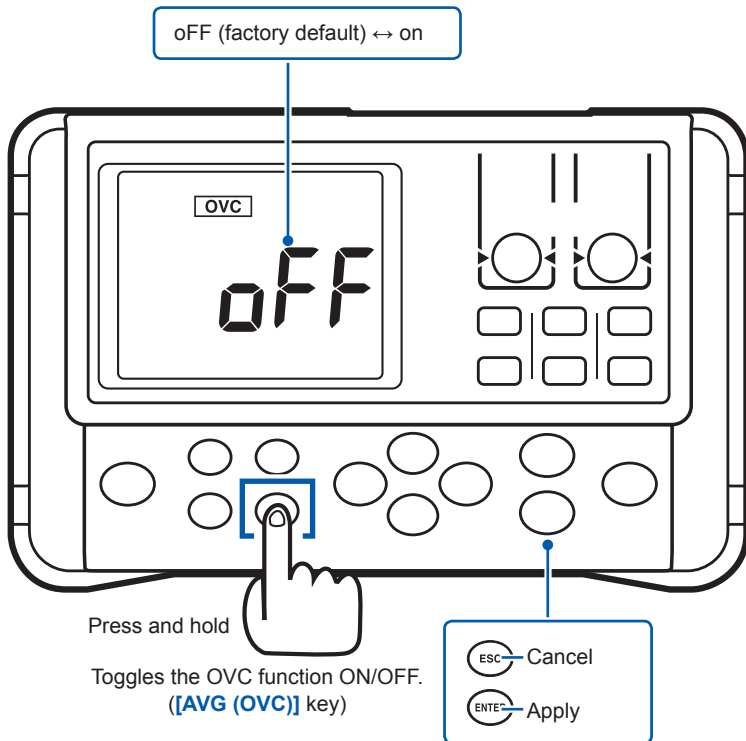

4

The OVC function can also be toggled ON/OFF with + -.

IMPORTANT

- When the offset voltage compensation function is ON (the OVC indicator is lit), the measured value will be slow to refresh.
- The OVC function cannot be used in the $3k\Omega$ range or higher. The function is automatically turned OFF.
- When the offset voltage compensation function is changed, the zero adjustment function is cancelled.
- When the measurement target has a high inductance, it is necessary to adjust the delay time. (p. 53)
Start with a longer delay time than necessary, and decrease the time gradually, watching the measured value.
- If the measurement target has a low heat capacity, the offset voltage compensation function may have no effect.

4.5 Setting the Delay Time for Measurement (Delay Function)

This function adjusts the time for measurement to stabilize by inserting a waiting period after use of the OVC or the auto range function to change the measurement current. When this function is used, the instrument waits for its internal circuitry to stabilize before starting measurement, even if the measurement target has a high reactance component.

The PrSEt (preset value) depends on the range used and the offset voltage compensation function.

Preset OVC delay value (factory default) (Unit: ms)

| Measurement current | Range | Delay time |
|---------------------|-----------------------------|------------|
| Lo | 3m Ω to 30m Ω | 200 |
| | 300m Ω to 3 Ω | 50 |
| | 30 Ω to 300 Ω | 30 |
| Hi | 300m Ω | 200 |

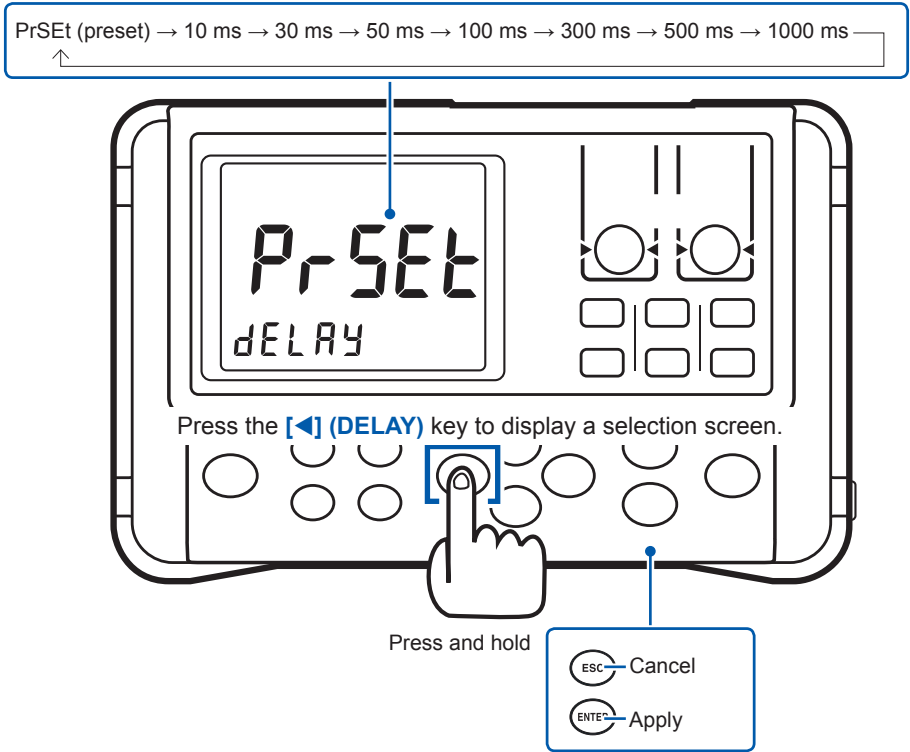

The delay time can also be specified with (+) (-).

Delay time guideline

- If the measurement target, for example, is an inductor that takes longer to stabilize after applying a measurement current, and it cannot be measured with the initial delay (preset), adjust the delay. Set the delay time to approximately ten times the following calculation so that the reactance component (inductance or capacitance) does not affect the measurement.

$$t = -\frac{L}{R} \ln\left(1 - \frac{IR}{V_0}\right)$$

- L*: Measurement target inductance
- R*: Measurement target resistance + lead wire resistance + contact resistance
- I*: Measurement current (see: "Accuracy" (p. 94))
- V₀*: Open-circuit voltage (see: "Accuracy" (p. 94))

- Start with a longer delay time, and decrease the time gradually, watching the measured value.
- As the delay is longer, the measured value display is slower to refresh.

4.6 Switching the Measurement Current (In the 300mΩ Range)

With this instrument, the measurement current for the 300mΩ range can be changed to 300 mA (100 mA at the time of shipment from the factory). This makes it possible to measure large current wiring under conditions that are similar to the actual usage conditions. It is also useful when performing measurement in an environment with external noise.*¹



IMPORTANT

- When the measurement current is set to 300 mA, a larger amount of power is consumed for the measurement target.
- If highly accurate measurement is required, use a measurement current of 100 mA.
- When the measurement current is changed, the zero adjustment values are cleared.

| Range [Ω] | 3m | 30m | 300m | 3 | 30 | 300 | 3k | 30k | 300k | 3M |
|-------------------------|----|-----|-------|-------|------|-----|-----|-------|------|-------|
| Measurement current [A] | 1 | | 300 m | 100 m | 10 m | | 1 m | 100 μ | 5 μ | 500 n |

Switching the Measurement Current (In the 300mΩ Range)

1 Turn the power off (if it is on).



2 Make sure that the power is off, and holding down the , press the  key.

3 When Lo is selected (100 mA)

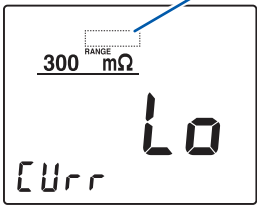
Not lit



The LCD screen displays '300 mΩ' with 'RANGE' above it. Below this, 'Lo' is shown in large digits. The text 'Curr' is visible at the bottom left. A blue arrow points from the 'Lo' text to the 'Not lit' label.

Use the  or  keys to toggle.

When Hi is selected (300 mA)

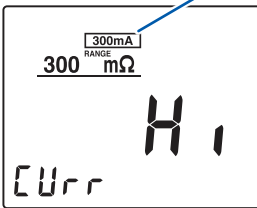

Blinking



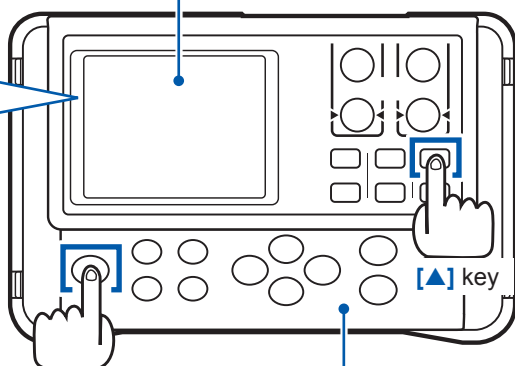

The LCD screen displays '300 mΩ' with 'RANGE' above it. A small box containing '300mA' is positioned above the '300' part of the range. Below this, 'Hi' is shown in large digits. The text 'Curr' is visible at the bottom left. A blue arrow points from the 'Hi' text to the 'Blinking' label.

4  Apply and move to the measurement screen.



The diagram shows the device's control panel. A hand is shown pressing the  key. Another hand is shown pressing the  key. A callout box labeled '[POWER] key' points to the power key. A callout box labeled '[▲] key' points to the view key. A callout box labeled '1 Turn the power off (if it is on).' points to the screen area.

[POWER] key

-  Cancel and move to the measurement screen.
-  Apply and move to the measurement screen.

When measurement is performed with the 300 mA measurement current, the 300 mA indicator lights up.

*¹ When measuring resistance for connection sections (e.g., connector contact, welded section, caulked section, screw-secured section) through which large current flows, such as power supply cables and ground cables, it is desirable that measurement be performed using the maximum current, as far as possible, that can actually flow through those sections. The following explains the reasons:

- Even in a connection completely free from abnormality, a relatively high resistance may be indicated at a lower measurement current.
This is due to an oxide film that is generated around the contact while it is not used.
- Even when it is judged that no abnormality is found using a small current, the connection sections are occasionally melted when a large current flows.
This problem occurs due to the Joule heat generated by a large current when a high resistance area is created locally.

Switching the Measurement Current (In the 300mΩ Range)

5

Judgment and Conversion Functions

This chapter describes the measured value judgment and conversion functions.

“5.1 Judging Measured Values (Comparator Function)” (p. 60)

“5.2 Performing Temperature Rise Test (Temperature Conversion Function (ΔT))”
(p. 67)

“5.3 Measuring the Length of a Conductor (Length Conversion Function)” (p. 69)

5.1 Judging Measured Values (Comparator Function)

This function judges a measured value to be Hi (measured value > upper limit), IN (upper limit \geq measured value \geq lower limit), or Lo (lower limit > measured value) against the set reference value, or upper or lower limit values.

- The judgment result can be verified on screen, with the buzzer (factory default is OFF), and the L2105 LED Comparator Attachment (option).

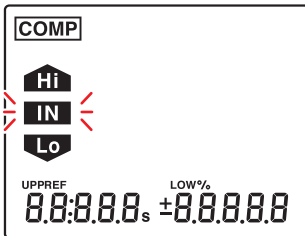

- There are two different judgment methods available: ABS mode and REF% mode.

IMPORTANT

- If ΔT or length conversion function is turned ON, the comparator function automatically turns OFF.
- If the comparator function is set to ON, it becomes impossible to change the range (including the auto range). To use the auto range or change the range, set the comparator function to OFF, and then use the **[AUTO]** key or **[▲][▼]** keys.
- If the comparator function is set to ON, the interval memory function becomes unavailable.

Before using the comparator function

- If no measured value appears, the comparator judgment is displayed as follows:
If a measurement error occurs, judgment is not performed. (p. 40)

| Display | Comparator judgment display (COMP lamp) |
|---------|---|
| oF | Hi |
| -oF | Lo |
| ----- | No judgment |

- If the power is turned off during a setting process, any setting changes are lost and the previous values remain valid. To apply the changes, press the **[ENTER]** key.

ABS (absolute value judgment) mode

Set the upper and lower limit values for judgment, as absolute values.

Example: Upper limit value 100.00mΩ
Lower limit value 80.00mΩ

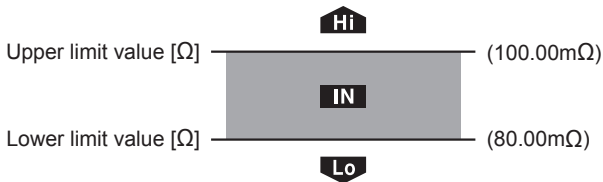
**REF% (relative value judgment) mode**

Set the allowable % of a reference value to determine the upper and lower limit values for judgment. In REF% mode, the upper and lower limit values cannot be set separately.

Example: Reference value..... 12.000kΩ
Upper and lower limit values..... ±1.00%

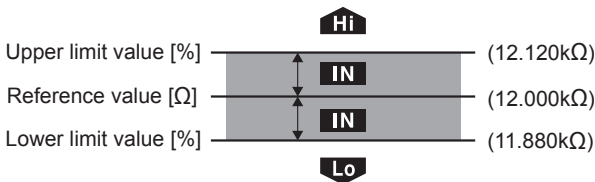

Turning the comparator function ON/OFF

oFF (factory default) → ON (ABS mode) → ON (REF% mode)

oFF

COMP

oFF

ABS mode (p. 63)

COMP

RANGE ▾
3 M Ω

UPP LOW M Ω

0.0000 0.0000

Upper limit value Lower limit value

REF% mode (p. 64)

COMP

RANGE ▾
3 M Ω

REF %

0.0000 ± 00.00

Reference value Allowable %

[COMP] key

ESC Cancel

ENTER Apply (To continue with the reference value and upper and lower limit setting process, do not press this key.)

Judging based on upper and lower limit values (ABS mode)

Upper and lower limit value setting

- 1 Use the **COMP** key to change the comparator to ABS mode (p. 62).

- 2 **RANGE** Change the range.
Unit of upper and lower limit values

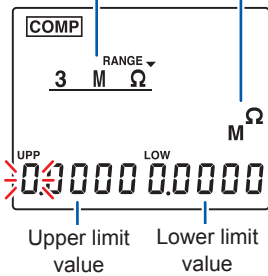

- 3 Upper and lower limit value setting

- 4 **ENTER** Apply the setting and move to the measurement screen.

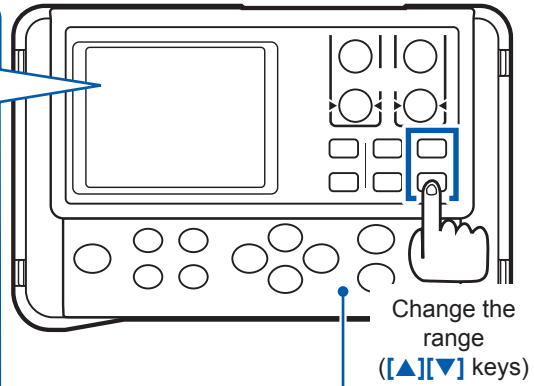

Changes values.

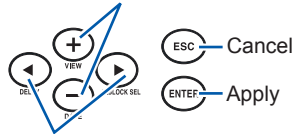

Changes settings, digits.

5

IMPORTANT

Any setting changes cannot be applied when: upper limit value < lower limit value.

Judging based on a reference value and allowable range (REF% mode)

In REF% mode, a measured value is displayed as a relative value. The upper and lower limit values cannot be set separately.

$$\text{Relative value} = \left(\frac{\text{Measured value}}{\text{Reference value}} - 1 \right) \times 100[\%]$$

Reference value and allowable % setting

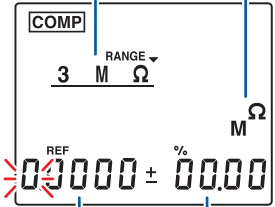
- 1 Use the **COMP** key to change the comparator to REF% mode. (p. 62) ↓
- 2 **RANGE** Change the range. Unit of reference value

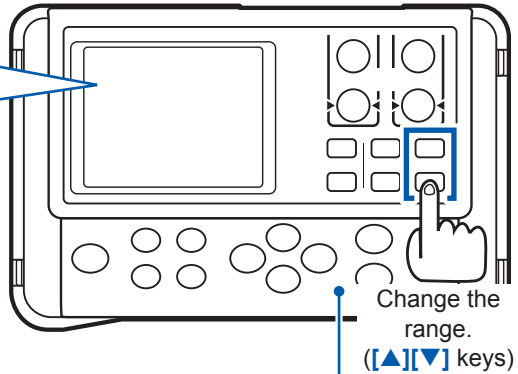
- 3 **Value setting**
- 4 **ENT/EF** Apply the setting and move to the measurement screen.

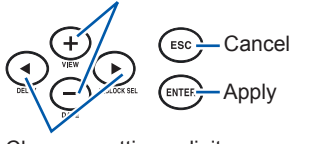

Changes values.



ESC — Cancel
 ENT/EF — Apply

Changes settings, digits.

IMPORTANT

The settings cannot be confirmed when the reference value is set to 0.

Verifying a judgment with a sound (judgment sound function)

This function sounds the buzzer, based on a comparator judgment result.

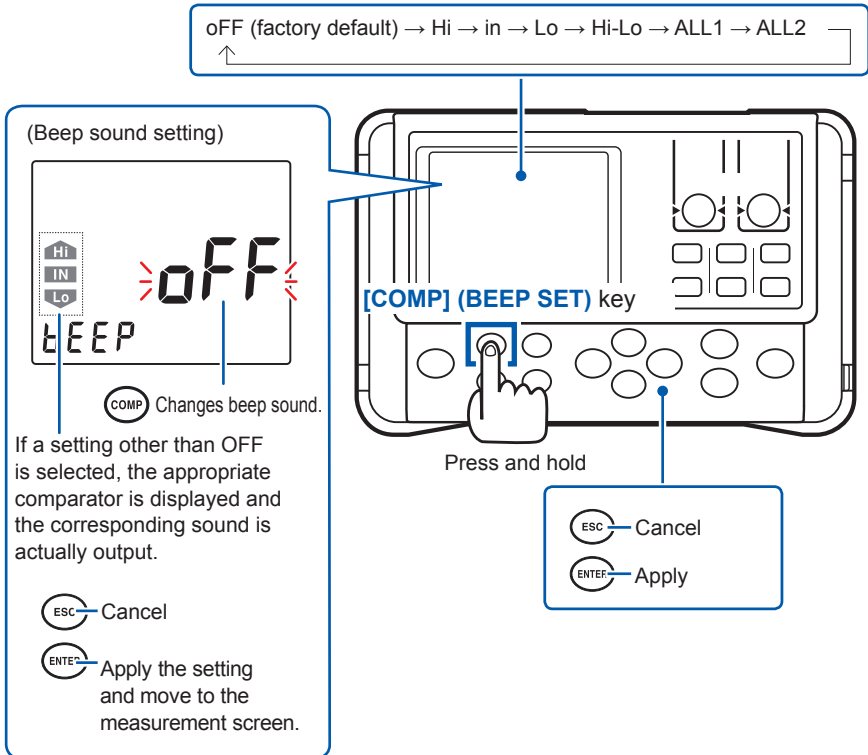

5

The judgment sound can also be selected with (+) (-).

Verifying a judgment on a handheld device (L2105 LED Comparator Attachment option)

By connecting an L2105 LED Comparator Attachment to the COMP.OUT terminal, you can obtain the judgment result on a handheld device. The lamp lights up in green for the IN judgment, and it lights up in red for either Hi or Lo judgment.

Before connecting the L2105 LED Comparator Attachment, be sure to read “Usage Notes” (p. 7).

Installing the L2105 LED Comparator Attachment

Install the L2105 LED Comparator Attachment wherever you desire.

Example: Install the L2105 LED Comparator Attachment to the test lead, by using the tie band or spiral tube attached with it.

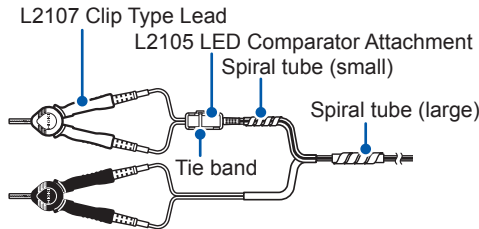

Connecting the L2105 LED Comparator Attachment to the instrument

Connect the L2105 LED Comparator Attachment to the COMP.OUT terminal. Insert the lamp all the way to the back.

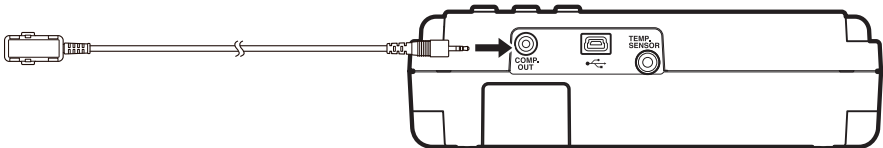

5.2 Performing Temperature Rise Test (Temperature Conversion Function (ΔT))

This function converts the change in the winding resistance into a temperature rise value, based on the temperature conversion principle (p. Appx.7). It can be used to estimate the temperature of the motor or the inside of the coil while the power is cut off based on the change in the winding resistance.

IMPORTANT

- To perform temperature conversion, connect the Z2002 Temperature Sensor to the TEMP.SENSOR terminal on the side of the instrument. Before connecting the sensor, be sure to read the following.
See: “2.4 Connecting the Z2002 Temperature Sensor (When Using TC or ΔT)” (p. 31)
- When ΔT is set to ON, the comparator function or TC cannot be turned ON. If length conversion function is set to ON, ΔT automatically turns OFF.
- If “t.Err” is displayed, the Z2002 Temperature Sensor may not be connected, or oF is displayed for the temperature. Check the connection of the Z2002 Temperature Sensor.

5

- (1) After the motor and coil are stabilized at room temperature, measure the resistance (R_1) and instrument ambient temperature (t_1), and then input these values to the instrument. (p. 68)
- (2) Disconnect the test lead from the measurement target.
- (3) After turning off the power, reconnect the test lead to the measurement target and then measure the temperature rise value (Δt_1 to Δt_n) at the preset intervals. (It can be measured easily if the interval memory function is used.) (p. 79)
- (4) Draw a line by connecting the collected temperature data (Δt_1 to Δt_n), and estimate the maximum temperature rise value (Δt).

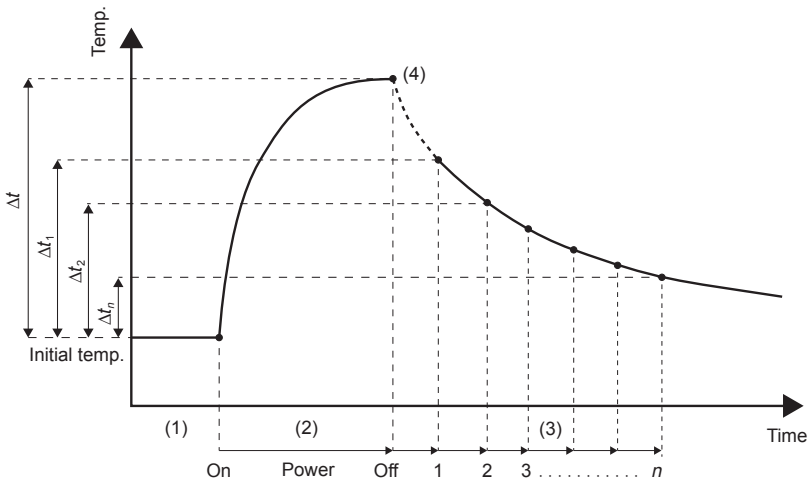

oFF (factory default) → TC → ΔT

- Use the **[TC/ΔT]** key to select ΔT .
- (Initial temperature t_1 setting)
Set the temperature plus/minus sign + (displayed as 0) / -.
Set the initial temperature.
- (Initial resistance value R_1 setting)
Changes decimal point position, units.
Set the initial resistance value.
- (Temperature coefficient reciprocal k setting)
Set the reciprocal (k) of the temperature coefficient.
- Apply the setting and move to the measurement screen.

Measurement screen (ΔT ON)

ΔT RANGE = 3 M Ω
23.0 $^{\circ}C$

$^{\circ}C$ display

[TC/ΔT] key

Changes values.

Changes settings, digits.

Guideline for k
IEC 60034 recommends the following:
• Copper: $k = 235$
• Aluminum: $k = 225$
Reference: "Appx. 5 Temperature Conversion (ΔT) Function" (p. Appx.7)

If you press the **[MEMORY]** key during setting, t_1 and R_1 are set to the values measured immediately before setting.

5.3 Measuring the Length of a Conductor (Length Conversion Function)

This function converts a resistance value to a length to display the length of the measurement target (such as a conductor).

Press and hold the **[TC/ΔT] (LENGTH)** key to display the ON/OFF setting screen for the length conversion function.

$$\text{Length [m]} = \frac{\text{Measured resistance } [\Omega]}{\text{Per meter resistance } [\Omega/\text{m}]}$$

Example: When the measured resistance is 15Ω and per meter resistance is 200mΩ/m

$$\text{Length [m]} = \frac{15 [\Omega]}{0.2 [\Omega/\text{m}]} = 75 [\text{m}]$$

IMPORTANT

When length conversion function is set to ON, the comparator cannot be turned ON. If ΔT is set to ON, length conversion function automatically turns OFF.

oFF ↔ ON (per meter resistance value setting)

1 Press and hold the [TC/ΔT] (LENGTH) key to select LENGTH.

2 (Per meter resistance value setting)

LENGTH

20000 Ω

+ Changes decimal point position, units.
-
OFF

Move to the value setting.

3

LENGTH

20000 Ω

+ Value setting
-
OFF

4 Apply the setting and move to the measurement screen.

Measurement screen (Length conversion function ON)

LENGTH

RANGE ↓
300 k Ω

2.100 km

Meter display

Press the [TC/ΔT] (LENGTH) key to display a selection screen.

Press and hold

- Changes decimal point position, units.
- Changes values.

ESC Cancel
ENTER Apply

Moves digits.

IMPORTANT

The display format (decimal point position and unit) automatically changes depending on the range and setting. For details, see the instrument specifications (p. 101). For some ranges, oF is always displayed, because the display range is exceeded, depending on the setting.

6

Panel Save and Load (Saving and Loading Measurement Conditions)

The panel save function can save up to nine sets of measurement conditions displayed at the time of the panel save operation, and the panel load function can load any set of the measurement conditions at any time. The panel data is retained even if the instrument is turned off.

- Press the **[PANEL]** key to display the panel load screen. (p. 73)
- Press and hold the **[PANEL] (SAVE/CLEAR)** key to display the setting screen for the panel save/clear function. (p. 72, p. 74)

Conditions that can be saved by panel save:
Resistance measurement range, averaging, delay, comparator, judgment sound, temperature conversion (ΔT), measurement current change, length conversion, temperature correction (TC), OVC, and memory mode

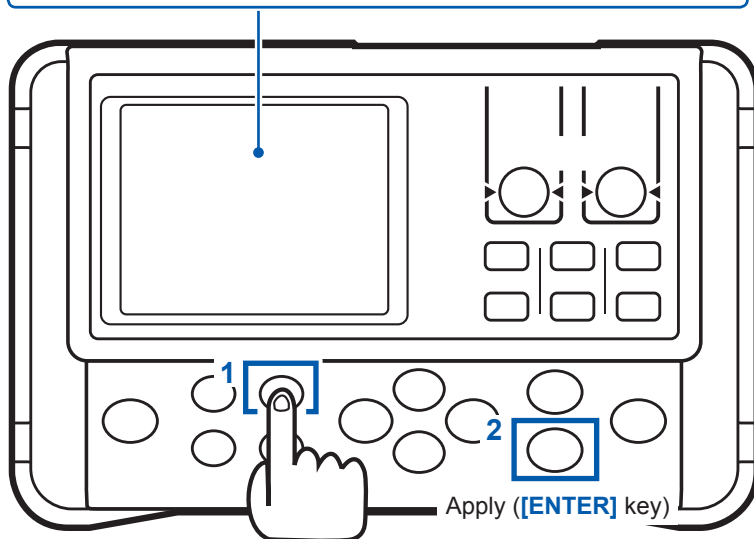

Panel load setting (**[PANEL]** key)

Panel save setting (Press and hold the **[PANEL] (SAVE/CLEAR)** key)

6.1 Saving Measurement Conditions (Panel Save Function)

This function saves the set of current measurement conditions.

1 Press and hold the **[PANEL]** (SAVE/CLEAR) key.

2 Select SAVE.

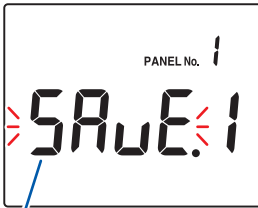

[PANEL] or **[+/-]** SAVE ↔ CLEAR toggle

↓ **[←/→]** Moves items.

3 Select a panel number.

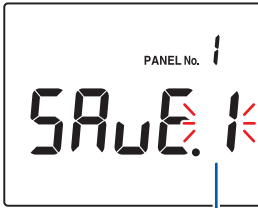

[PANEL] or **[+/-]** Change the panel number. (1 to 9)

4 **[ENTER]** Save and move to the measurement screen.

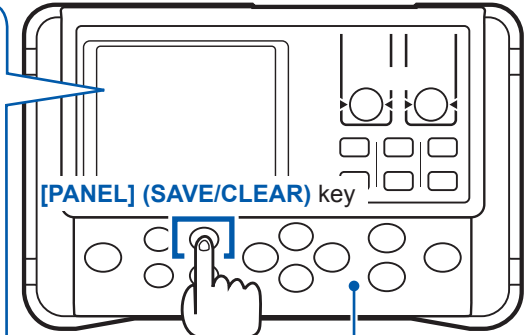

Press and hold

- Select SAVE.
- Select a panel number.



Moves items.

IMPORTANT

- If the already saved panel number is selected and the **[ENTER]** key is pressed, the existing contents are overwritten.
- Zero adjustment values are not saved.

6.2 Loading Measurement Conditions (Panel Load Function)

This function replaces the current measurement conditions with a saved set of measurement conditions.

1 Press the **[PANEL]** key.

2 Select a panel number.

[PANEL] OR $\begin{matrix} + \\ \text{NO} \\ - \end{matrix}$ Change the panel number. (1 to 9)

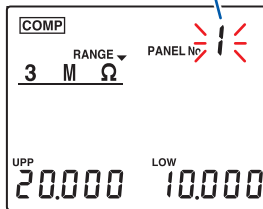

3 **[ENTER]** The measurement conditions are loaded and move to the measurement screen.

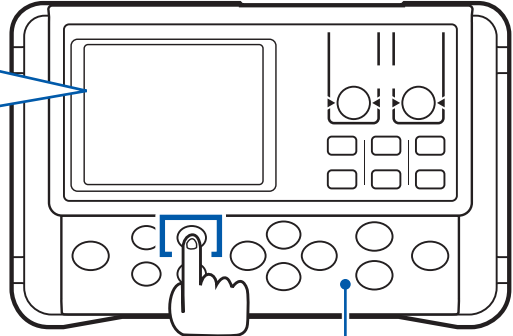

[PANEL] key

[ESC] Cancel
[ENTER] Apply and move to the measurement screen.

6

IMPORTANT

- If the number of a panel that is not saved is selected and the **[ENTER]** key is pressed, a warning sound is output.
- Zero adjustment values are not read. Zero adjustment can be performed both before and after panel loading.
- If **PANEL No.PrSet** is selected, the measurement conditions are initialized. (Preset load)

Also see "8.3 Initializing (Reset)" (p. 91) for initialization.

- The panel number is not displayed on the measurement screen.

6.3 Clearing the Contents of a Panel

- 1 Press and hold the  (SAVE/CLEAR) key.

- 2 Select CLEAR.

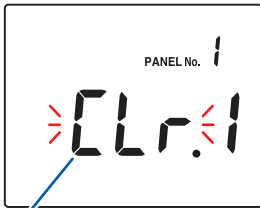



 SAVE ↔ CLEAR toggle

↓   Moves items.

- 3 Select a panel number.



 Change the panel number.
 (1 to 9)

- 4  Delete the panel and then move to the measurement screen.

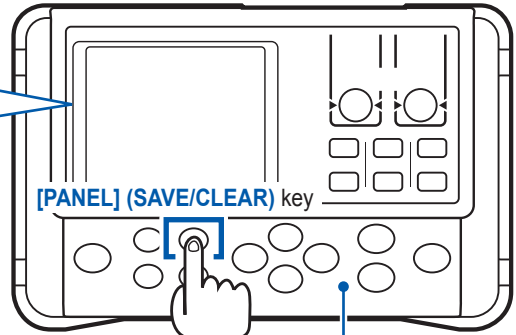

Press and hold

- Select CLEAR.
- Select a panel number.

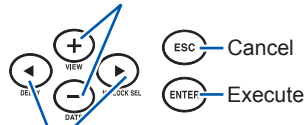

Moves items.

IMPORTANT

Once deleted, the contents of the panel cannot be restored.

7

Memory Function (Saving and Exporting Measurement Data to a PC)

What the memory function does

This function can save a value currently being measured. The saved data is held even if the instrument is turned off. There are three different saving methods:

- Manual memory (up to 1,000 entries) (p. 77)
- Auto memory (up to 1,000 entries) (p. 78)
- Interval memory (up to 6,000 entries) (p. 79)
- Data to be saved in the memory (Some items cannot be displayed only with the instrument.)

| | |
|----------------------------|--|
| Manual memory, auto memory | Date and time, measurement value, temperature, resistance measurement range, averaging, comparator, changed measurement current, temperature correction (TC), and OVC |
| Interval memory | Start date and time, measurement value, temperature, resistance measurement range, averaging, temperature correction (TC), temperature conversion (ΔT), and interval |

There are two different methods to view saved data.

- Displaying on the instrument (memory display function) (p. 81)
- Exporting to a PC (in USB mass storage mode) (p. 86)

Memory layout

| Memory block (10 blocks) | | | | | | | | | |
|---|----|----|----|----|----|----|----|----|----|
| A. | b. | C. | d. | E. | F. | G. | H. | J. | L. |
| (Maximum number of entries) | | | | | | | | | |
| Manual or auto memory: 100 entries per block, a total of 1,000 entries for all blocks | | | | | | | | | |
| Interval memory: A total of 6,000 entries for all blocks | | | | | | | | | |
| (The number of memory in each block is not fixed.) | | | | | | | | | |

* To save up to the maximum amount of memory shown above, all blocks should be used for the manual or auto-memory, or for the interval memory only. If both types of memory blocks exist, saving up to the maximum is not possible.

Memory blocks

In manual or auto memory mode, the block to save data can be selected. In interval mode, data is saved in an available free block when the interval starts. In interval mode, the memory block to save data cannot be specified.

Changing the memory block

1 Press and hold the **[▶]** (**M.Block SEL**) key.

2 Select a block.

Changes blocks.

▶ or +
-

MEMORY No. ~~A~~ 000 1

DATA 100

Number of saved entries

Number of entries that can be saved

3

ENTER Apply and move to the measurement screen.

Press and hold **[▶]** (**M.Block SEL**) key to display a selection screen.

ESC Cancel

ENTER Apply and move to the measurement screen.

No data saved

MEMORY No. ~~A~~ - - - -

DATA 100

No free memory available

MEMORY No. FULL

DATA 0

7.1 Saving Data at Specified Time (Manual Memory)

Press the **[MEMORY]** key to save the displayed measured value.

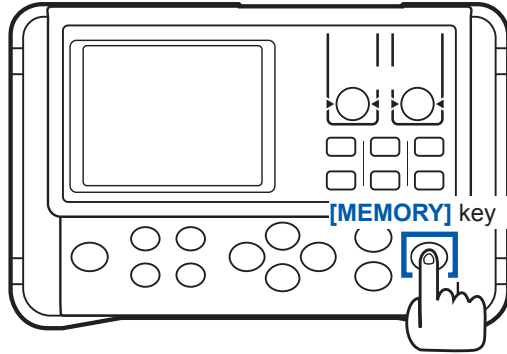

During measurement

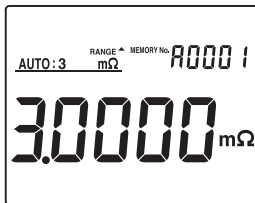

The memory No. blinks (during saving of data), and the next available memory number is displayed.

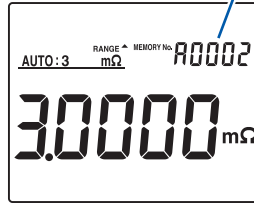

IMPORTANT

- If a measurement value being held is saved, the memory number to be used is displayed. When the hold is released, the next available memory number appears.
- The memory number is incremented by one each time data is saved, and cannot be specified. If data is accidentally saved, clear the last data item saved (latest data).

See: "7.5 Clearing Measurement Data (Memory Clear)" (p. 82)

7.2 Saving Data Automatically When Measured Values Stabilize (Auto-Memory)

When a measured value stabilizes, the value is automatically held and saved.

- 1 oFF → Auto-hold (A.HOLD) → **Auto-memory (A.HOLD, A.MEMORY)** → Interval (INTERVAL) → oFF

- 2
 - ESC — Cancel
 - ENTER — Apply

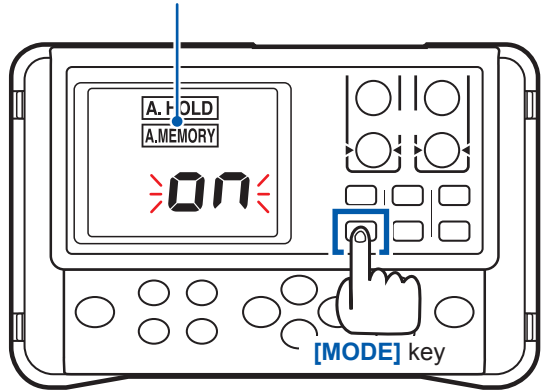

- 3

During measurement

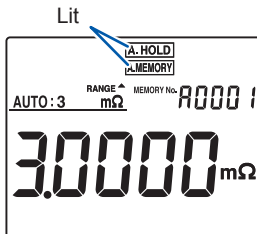

During auto-hold

The memory No. blinks (during saving of data), and the memory number used to save data is displayed.

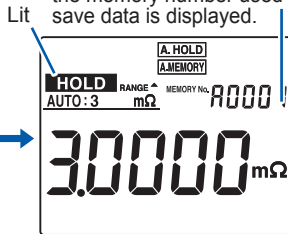

Hold released

Release the test leads from the measurement target and then contact the leads to the target again. The next measurement is started. (The hold state can also be released by changing the range or pressing the [ESC] key.)

The next memory No. is displayed during measurement

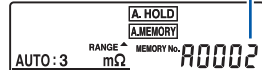

IMPORTANT

The memory number is incremented by one each time data is saved, and cannot be specified. If data is accidentally saved, clear the last data item saved (latest data). See: "7.5 Clearing Measurement Data (Memory Clear)" (p. 82)

7.3 Saving Data at Fixed Intervals (Interval Memory Function)

This function can save measured data at specified intervals. Using this function together with ΔT makes it easy to perform a temperature rise test (for estimation of power-off temperature).

Setting the interval memory

- 1 OFF → Auto-hold (A.HOLD) → Auto-memory (A.HOLD, A.MEMORY) → Interval (INTERVAL) → OFF

- 2 (Interval time setting)
Set the interval time.

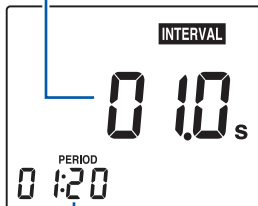

Time that data can be saved.
(Example: 01:20 indicates one hour and 20 minutes.)

ESC — Cancel

ENTER — Apply

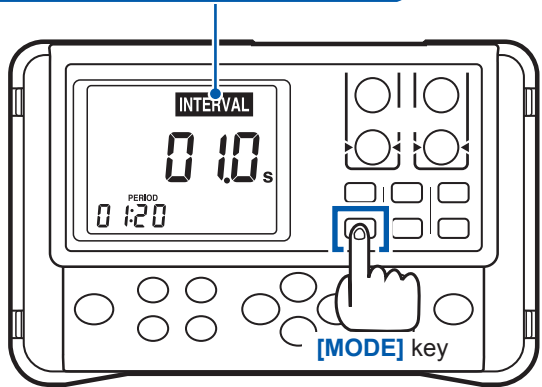

IMPORTANT

The time that data can be saved varies depending on the number of memory units already saved and the set interval time.

Measuring the interval memory

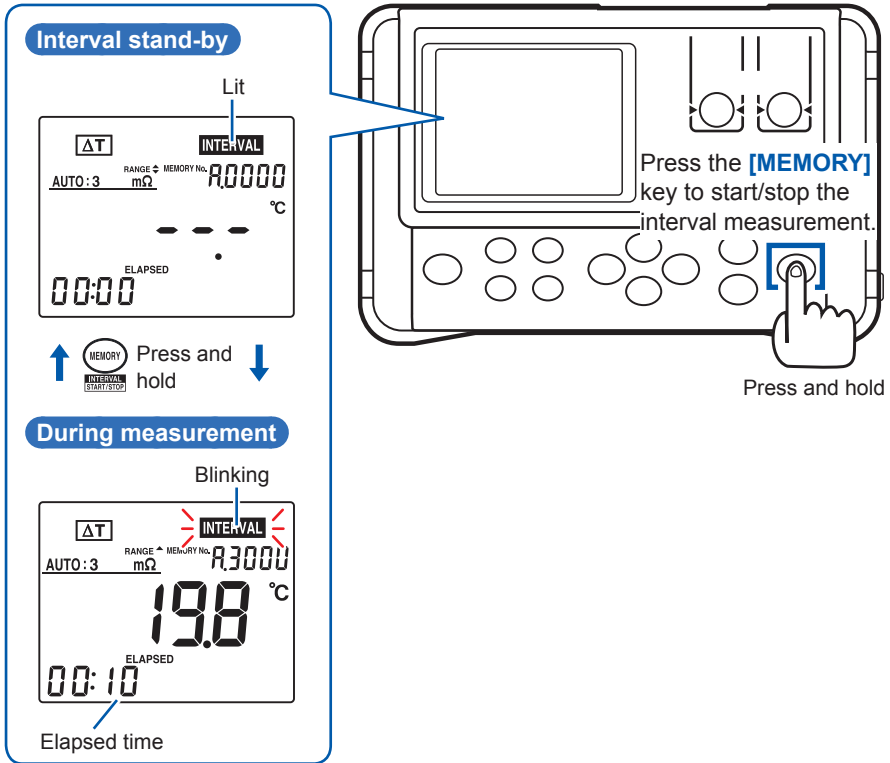

IMPORTANT

- When the memory becomes full, the interval measurement automatically stops. To start an interval measurement again, clear the memory.
- When an interval measurement starts, data is automatically saved in an available free block. The memory block used cannot be changed. When the interval measurement stops, the used memory block displays FULL.
- When the interval memory function is set to ON, the comparator function cannot be used. When the comparator is set to ON, the interval memory function cannot be used.
- If "----" (or other measured value error) is displayed after pressing the **[START]** key, saving of data does not start. After a measured value is displayed, saving of data starts.

7.4 Displaying Saved Measurement Data (Memory Display Function)

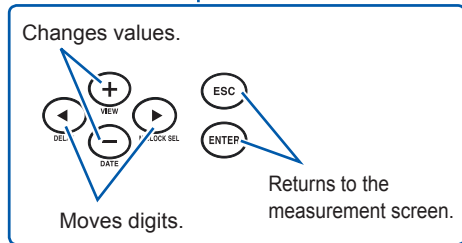
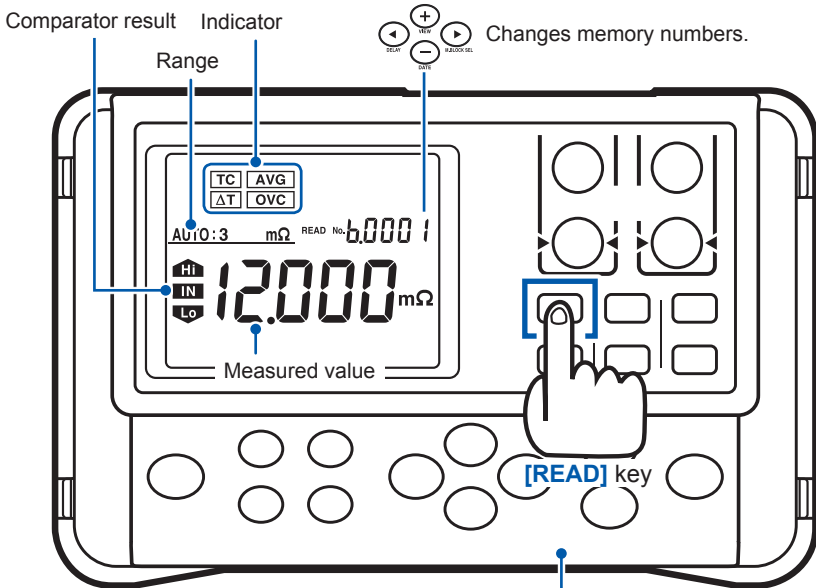

7.5 Clearing Measurement Data (Memory Clear)

There are three different methods to clear saved measurement data.

- Clearing only the last data (latest data) saved in a block
- Clearing an entire block
- Clearing all

Clearing only the latest data saved in a block (block selectable)
See: p. 83



Clearing an entire block of saved data
See: p. 84

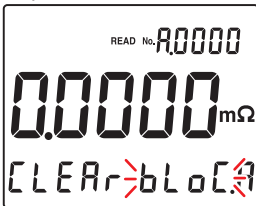

Clearing all data saved in the memory
See: p. 85



(All data can also be cleared by turning the power off, and then turning it on while holding down the **[READ]** key.)

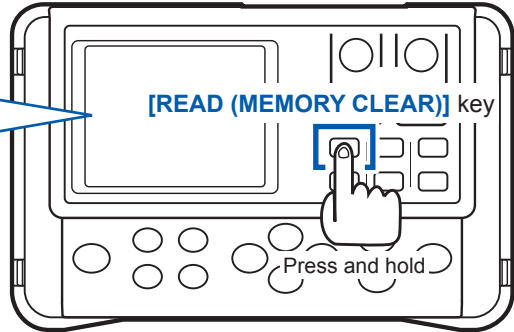

Clearing only the latest data saved in a block (block selectable)

This method clears only the latest data saved in a block. This method is useful, for example, when data is accidentally saved in manual or auto-memory mode.

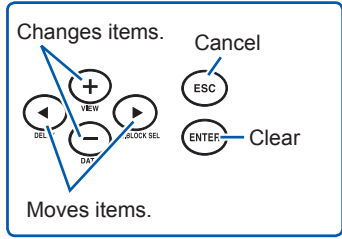
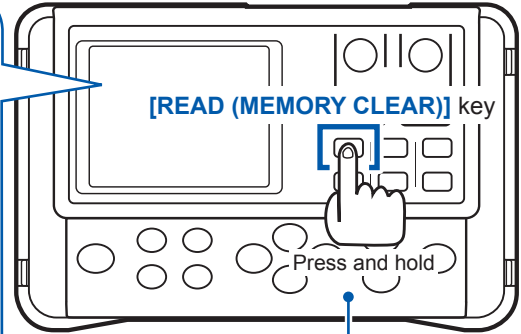
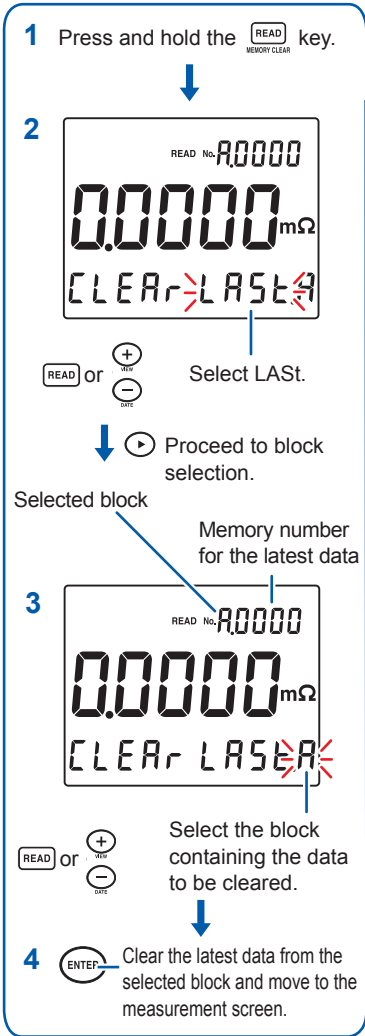

Clearing an entire block containing saved data

This method clears an entire block containing saved data.

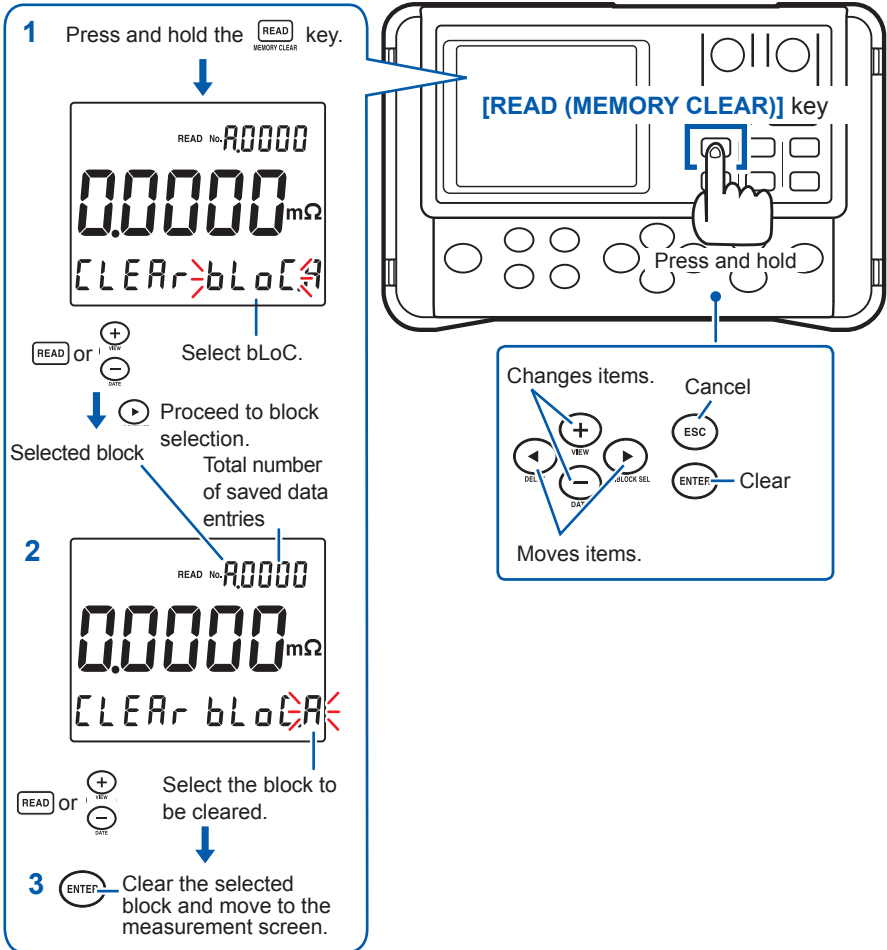

Clearing all saved data

This method clears all data saved in the instrument.

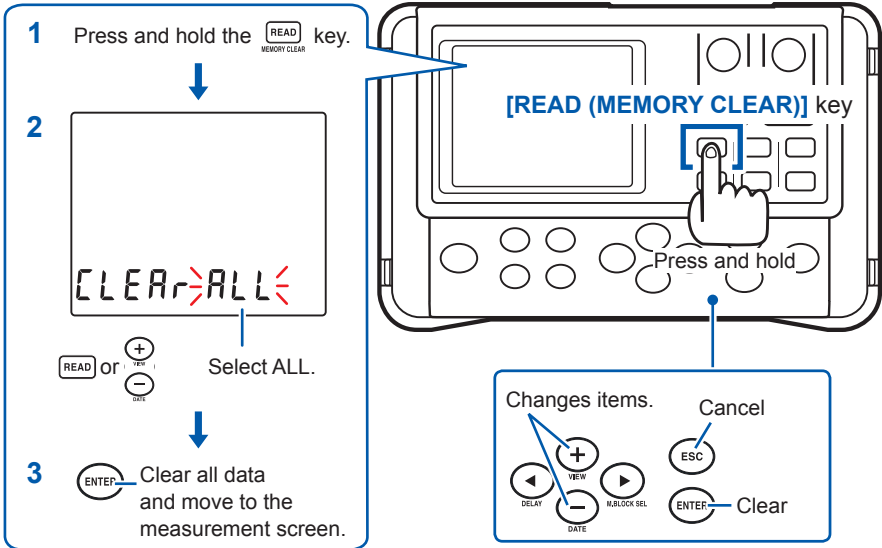

To delete all data as in the above method, press the **[POWER]** key while holding the **[READ]** key down when the power is off.

7.6 Exporting Saved Measurement Data to a PC (USB Mass Storage Mode)

Measured values stored in the memory are organized as files in CSV format. Data saved in the internal memory can be exported to a PC, using USB mass storage mode.

Connecting a USB cable

Be careful of the orientation of the USB cable plugs and connect the plugs to the instrument and PC.

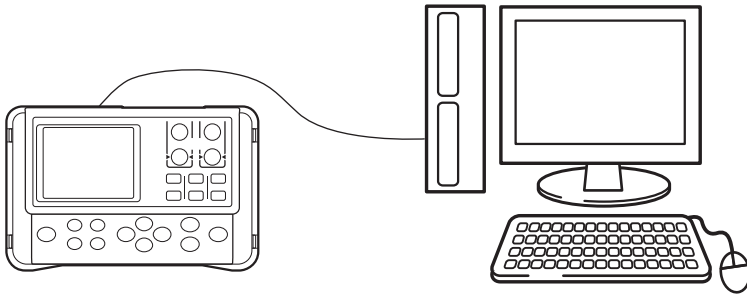

Removing the USB cable

To remove the USB cable connected to the instrument while the PC is running, use the “Safely Remove Hardware” icon on the PC.

Copying a file to the PC

1 Open [Start] → [My Computer] → [RM3548].

A memory block name is used as a file name.

Example: When the instrument memory is recognized as RM3548 (Z:)

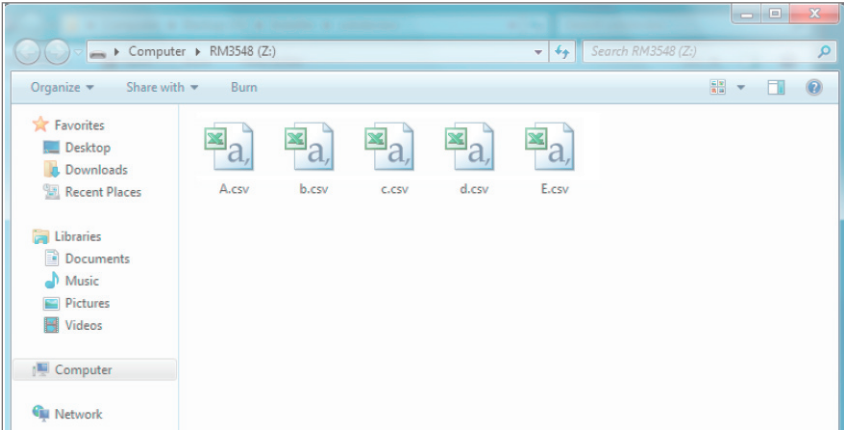

2 Copy a file to the PC and open the file with a text editor (such as Notepad) or spreadsheet program (such as Excel).

If the interval measurement is interrupted, the following end status is indicated at the end of the file.

- When there is no free memory available and no more data can be saved: MemoryFull
- When there is no remaining battery power and the power is turned off: BatteryLow

Example: When Excel is used to open the file

| | A | B | C | D |
|----|---------------|--------------|------------------|---|
| 1 | Model | HIOKI RM3548 | RESISTANCE METER | |
| 2 | Serial No. | 989899999 | | |
| 3 | DATE(Y-M-D) | 2013/1/1 | | |
| 4 | TIME | 10:00:00 | | |
| 5 | RANGE[Ohm] | OFF | | |
| 6 | AVS | AUTO | | |
| 7 | DELTA T | ON | | |
| 8 | RI [Ohm] | 68.62 | | |
| 9 | TI [C] | 25.4 | | |
| 10 | k | 235 | | |
| 11 | INTERVAL[sec] | 0.2 | | |
| 12 | | | | |
| 13 | DATA[C] | | | |
| 14 | 3.07E+01 | | | |
| 15 | 3.07E+01 | | | |
| 16 | 3.07E+01 | | | |
| 17 | 3.07E+01 | | | |
| 18 | 3.07E+01 | | | |
| 19 | 3.07E+01 | | | |
| 20 | 3.07E+01 | | | |
| 21 | 3.07E+01 | | | |
| 22 | 3.07E+01 | | | |
| 23 | 3.07E+01 | | | |

File created in interval memory mode

| | A | B | C | D | E | F | G | H | I | J | K | L | M | N |
|----|-------------|--------------|------------------|------|---------|--------|----------|----------|-------|------------|-----|-----|-----|-------|
| 1 | Model | HIOKI RM3548 | RESISTANCE METER | | | | | | | | | | | |
| 2 | Serial No. | 1E499 | | | | | | | | | | | | |
| 3 | DATE(Y-M-D) | TIME | DATA | UNIT | TEMP[C] | OOMP | UPP/REF | LOW/% | JUDGE | RANGE[Ohm] | TG | OVC | AVE | 300mA |
| 4 | 2013/1/1 | 9:50:41 | 7.51E+01 | Ohm | 25.4 | OFF | -- | -- | -- | 300 ON | OFF | 2 | -- | -- |
| 5 | 2013/1/1 | 9:50:42 | 7.51E+01 | Ohm | 25.4 | OFF | -- | -- | -- | 300 ON | OFF | 2 | -- | -- |
| 6 | 2013/1/1 | 9:50:43 | 7.51E+01 | Ohm | 25.4 | OFF | -- | -- | -- | 300 ON | OFF | 2 | -- | -- |
| 7 | 2013/1/1 | 9:50:44 | 7.51E+01 | Ohm | 25.4 | OFF | -- | -- | -- | 300 ON | OFF | 2 | -- | -- |
| 8 | 2013/1/1 | 9:50:47 | 3.48E+01 | Ohm | 25.4 | OFF | -- | -- | -- | 300 ON | OFF | 2 | -- | -- |
| 9 | 2013/1/1 | 9:50:51 | 9.40E+01 | Ohm | 25.4 | OFF | -- | -- | -- | 300 ON | OFF | 2 | -- | -- |
| 10 | 2013/1/1 | 9:50:58 | 1.72E+01 | Ohm | 25.4 | OFF | -- | -- | -- | 30 ON | OFF | 2 | -- | -- |
| 11 | 2013/1/1 | 9:51:01 | 1.72E+01 | Ohm | 25.4 | OFF | -- | -- | -- | 30 ON | OFF | 2 | -- | -- |
| 12 | 2013/1/1 | 9:51:30 | 4.88E+00 | Ohm | 25.4 | OFF | -- | -- | -- | 30 ON | OFF | 2 | -- | -- |
| 13 | 2013/1/1 | 9:51:54 | 4.88E+00 | Ohm | 25.4 | OFF | -- | -- | -- | 30 ON | OFF | 2 | -- | -- |
| 14 | 2013/1/1 | 9:52:13 | 9.61E+00 | Ohm | 25.4 | UPFLOW | 1.00E+01 | 8.00E+00 | IN | 30 ON | OFF | 2 | -- | -- |
| 15 | 2013/1/1 | 9:52:14 | 9.61E+00 | Ohm | 25.4 | UPFLOW | 1.00E+01 | 8.00E+00 | IN | 30 ON | OFF | 2 | -- | -- |
| 16 | 2013/1/1 | 9:52:15 | 9.61E+00 | Ohm | 25.4 | UPFLOW | 1.00E+01 | 8.00E+00 | IN | 30 ON | OFF | 2 | -- | -- |
| 17 | 2013/1/1 | 9:52:16 | 9.61E+00 | Ohm | 25.4 | UPFLOW | 1.00E+01 | 8.00E+00 | IN | 30 ON | OFF | 2 | -- | -- |
| 18 | 2013/1/1 | 9:52:17 | 9.61E+00 | Ohm | 25.4 | UPFLOW | 1.00E+01 | 8.00E+00 | IN | 30 ON | OFF | 2 | -- | -- |
| 19 | 2013/1/1 | 9:52:18 | 9.61E+00 | Ohm | 25.4 | UPFLOW | 1.00E+01 | 8.00E+00 | IN | 30 ON | OFF | 2 | -- | -- |
| 20 | 2013/1/1 | 9:52:18 | 9.61E+00 | Ohm | 25.4 | UPFLOW | 1.00E+01 | 8.00E+00 | IN | 30 ON | OFF | 2 | -- | -- |
| 21 | 2013/1/1 | 9:52:25 | 9.61E+00 | Ohm | 25.4 | UPFLOW | 9.00E+00 | 8.00E+00 | HI | 30 ON | OFF | 2 | -- | -- |
| 22 | 2013/1/1 | 9:52:26 | 9.61E+00 | Ohm | 25.4 | UPFLOW | 9.00E+00 | 8.00E+00 | HI | 30 ON | OFF | 2 | -- | -- |
| 23 | 2013/1/1 | 9:52:26 | 9.61E+00 | Ohm | 25.4 | UPFLOW | 9.00E+00 | 8.00E+00 | HI | 30 ON | OFF | 2 | -- | -- |

File created in auto- or manual memory mode

IMPORTANT

- No measurements or settings can be made during USB connection. They also cannot be made from the PC.
- The memory data is made read-only. No file can be changed or deleted from the PC. To delete a file, remove the USB cable and use the memory clear function on the instrument. (p. 82)

Changing the decimal point and delimiter characters for CSV files

You can select from three pairs of decimal point and delimiter characters to be used for CSV files.

Make sure that the power is off, and while holding down the **[MODE]** key, press the **[POWER]** key.

Decimal point and delimiter characters for CSV files

| Type | Decimal point | Delimiter | Extension |
|-------|---------------|-------------------|-----------|
| Type1 | . (period) | , (comma) | .csv |
| Type2 | , (comma) | (tab) | .txt |
| Type3 | . (period) | (space character) | .txt |

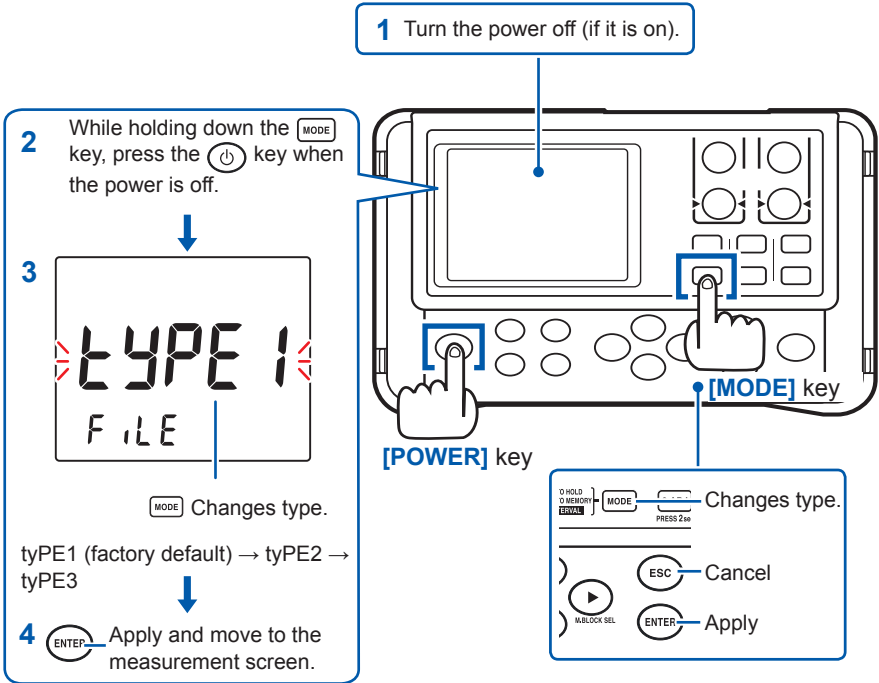

The type can also be changed with **[+]** **[-]**.

8

System Settings

8.1 Displaying the Date and Time Verification Screen

Press and hold the **[−] (DATE)** key to verify the date and time.

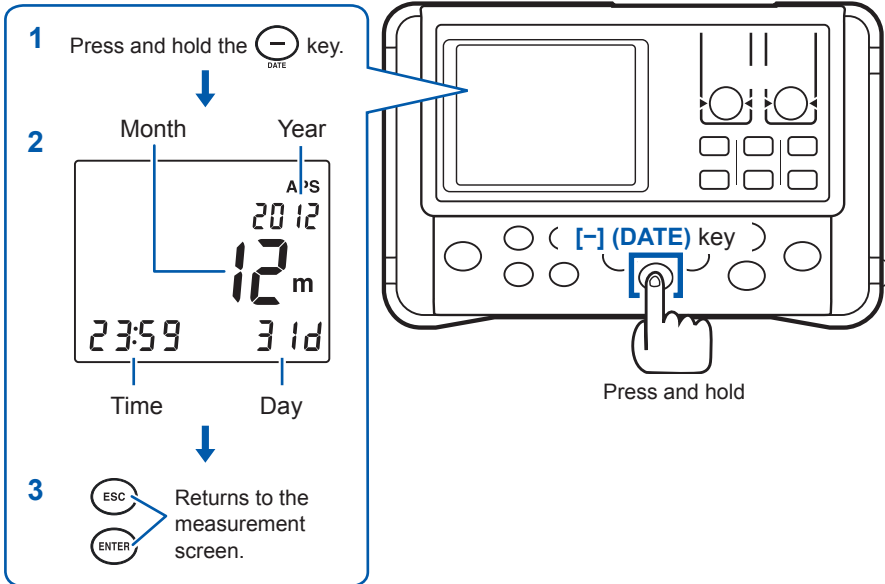



8.2 Setting the Clock

Set the date and time.

To display the time setting screen, press the **[POWER]** key while holding the **[-]** key down when the power is off.



1 Turn the power off (if it is on).

2 While holding down the  key, press the  key when the power is off.

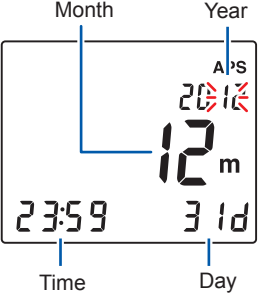
3



4  Apply and move to the measurement screen.

 Moves digits, items.
 Changes values.

[POWER] key **[-]** key

Changes values.

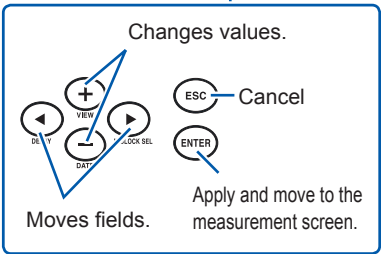

Moves fields. Apply and move to the measurement screen.

8.3 Initializing (Reset)

This function provides the following three types of reset:

- Memory clear: Initializes the memory that stores measurement data.
(This type of initialization is possible even if the power is on. (p. 82))

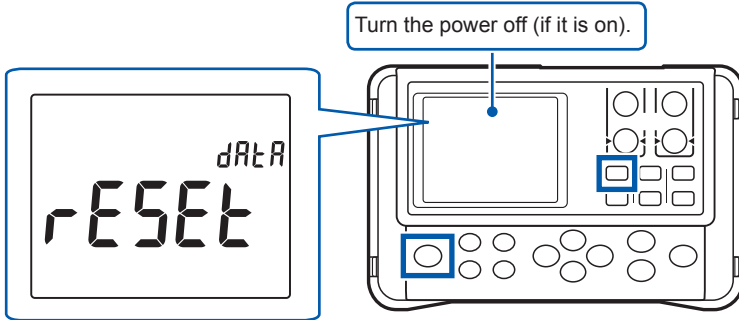

- Reset (to reset the current measurement conditions): Resets data and settings other than the panel data, saved measurement data, and the clock settings to the factory defaults.
(This type of initialization is possible even if the power is on. (p. 73))

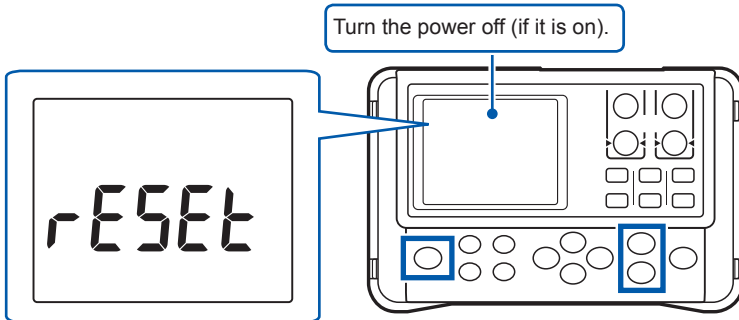

- System reset: Resets all settings other than the clock settings, including the panel data and saved measurement data, to the factory defaults.

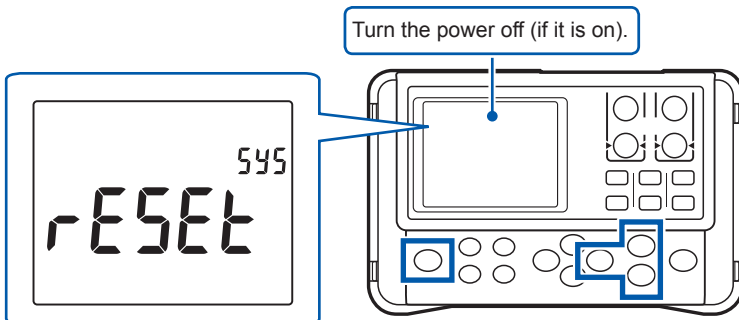

Default settings

| Function | Available settings | Default value | See |
|---|---|---------------|--------------------|
| Measurement range switch | AUTO/MANUAL | AUTO | (p. 36) |
| Measurement range | 3mΩ/30mΩ/300mΩ/3Ω/30Ω/300Ω/3kΩ/30kΩ/300kΩ/3MΩ | 3MΩ | (p. 36) |
| Display mode | None/Memory No./Temperature | Temperature | (p. 39) |
| Zero adjustment | OFF/ON | OFF | (p. 44) |
| Averaging | oFF/2/5/10/20 | oFF | (p. 49) |
| Temperature correction, temperature conversion (ΔT) | oFF/TC/ΔT | oFF | (p. 50) (p. 67) |
| Offset voltage compensation (OVC) | oFF/on | oFF | (p. 51) |
| Delay | PrSEt (factory default)/10 ms/ 30 ms/ 50 ms/ 100 ms/ 300 ms/ 500 ms/ 1,000 ms | PrSEt | (p. 53) |
| 300mΩ range measurement current switch | Hi (300 mA)/ Lo (100 mA) | Lo | (p. 55) |
| Comparator | oFF/ ON (ABS mode)/ ON (REF% mode) | oFF | (p. 60) |
| Judgment sound | oFF/Hi/in/Lo/Hi-Lo/ALL1/ALL2 | oFF | (p. 65) |
| Length conversion | oFF/ON | oFF | (p. 69) |
| Hold memory mode | oFF/A.HOLD (auto-hold)/A.HOLD,A.MEMORY (auto-memory)/INTERVAL (interval) | oFF | (p. 42) (p. 75) |
| Memory block | A/b/C/d/E/F/G/H/J/L | A | (p. 76) |

9 Specifications

9.1 General Specifications

Measurement range

0.000 0mΩ (3mΩ range) to 3.500 0MΩ (3MΩ range) (10 ranges)

Measurement method

Measurement signal Constant current

Measurement method DC four-terminal method

Measurement terminals Banana terminals

SOURCE A terminal Current detection

SOURCE B terminal Current source

SENSE A terminal Voltage detection

SENSE B terminal Voltage detection

Measurement specifications

(1) Resistance measurement accuracy

Accuracy guarantee conditions

Accuracy guarantee for temperature and humidity 23°C ± 5°C (73.4°F ± 41°F), 80%RH maximum

Accuracy warranty period One year

Temperature coefficient ±(1/10th of measurement accuracy) / °C is added in the temperature ranges of 0 to 18°C and 28 to 40°C.

Accuracy ± (%rdg.+%f.s.) (calculated as f.s. = 30,000 dgt. 0.010%f.s. = 3 dgt.)

| Range | Maximum measurement range ^{*1,2} | Measurement accuracy ^{*3} | Measurement current ^{*4} | Open-circuit voltage |
|-------|---|------------------------------------|-----------------------------------|----------------------|
| 3mΩ | 3.5000mΩ | 0.100 + 0.200 (0.100 + 0.020) | 1 A | 5.5 V _{MAX} |
| 30mΩ | 35.000mΩ | 0.100 + 0.020 (0.100 + 0.010) | | |
| 300mΩ | 350.00mΩ | 0.100 + 0.010 (0.100 + 0.010) | 300 mA | |
| | | 0.020 + 0.020 (0.020 + 0.010) | 100 mA | |
| 3Ω | 3.5000Ω | 0.020 + 0.007 (0.020 + 0.007) | 10 mA | |
| 30Ω | 35.000Ω | 0.020 + 0.007 (0.020 + 0.007) | 1 mA | |
| 300Ω | 350.00Ω | 0.020 + 0.007 (0.020 + 0.007) | 100 μA | |
| 3kΩ | 3.5000kΩ | 0.020 + 0.007 | 5 μA | |
| 30kΩ | 35.000kΩ | 0.020 + 0.007 | 500 nA | |
| 300kΩ | 350.00kΩ | 0.040 + 0.007 | | |
| 3MΩ | 3.5000MΩ | 0.200 + 0.007 | | |

^{*1} A negative value is up to -10%f.s.

^{*2} The maximum display range corresponds to the maximum measurement range.

^{*3} A lower-cell value enclosed by () applies when offset voltage compensation is enabled.

^{*4} The measurement current accuracy is ±5%.

(The following value is added as a rdg. error to the resistance measurement accuracy if temperature correction is being used.)

$$\frac{-\alpha_{t_0}\Delta t}{1 + \alpha_{t_0} \times (t + \Delta t - t_0)} \times 100[\%]$$

t_0 : Reference temperature [°C]

t : Current measured temperature [°C]

Δt : Temperature measurement accuracy

α_{t_0} : Temperature coefficient at t_0 [1/°C]

(2) Temperature measurement accuracy (thermistor sensor)

| | |
|----------------------------|-----------------|
| Accuracy guarantee | -10.0 to 99.9°C |
| Display range | -10.0 to 99.9°C |
| Measurement period (speed) | 200 ms ± 20 ms |
| Display refresh rate | Approx. 2 s |
| Accuracy warranty period | One year |

Accuracy when used with a Z2002 Temperature Sensor

| Accuracy | Temperature range |
|---|-------------------|
| $\pm(0.55+0.009 \times t-10)^{\circ}\text{C}$ | -10.0°C to 9.9°C |
| $\pm 0.50^{\circ}\text{C}$ | 10.0°C to 30.0°C |
| $\pm(0.55+0.012 \times t-30)^{\circ}\text{C}$ | 30.1°C to 59.9°C |
| $\pm(0.92+0.021 \times t-60)^{\circ}\text{C}$ | 60.0°C to 99.9°C |

t: Measurement temperature (°C)
The instrument accuracy is $\pm 0.2^{\circ}\text{C}$.

(3) Order of operation

1. Zero adjustment
2. Temperature correction
3. Length conversion

Accuracy

We define measurement tolerances in terms of f.s. (full scale), rdg. (reading), and dgt. (digit) values, with the following meanings:

| | |
|-------------|---|
| f.s. | (Maximum display value) Usually indicates the maximum display value. In the instrument, this indicates the currently used range. |
| rdg. | (Reading or displayed value) The value currently being measured and indicated on the measuring instrument. |
| dgt. | (Resolution) The smallest displayable unit on a digital measuring instrument, i.e., the input value that causes the digital display to show a "1". |

Accuracy calculation examples

(Numbers after the display digits are rounded off.)

1 Resistance measurement accuracy

Measurement conditions: 300mΩ range, current Lo (100 mA), OVC OFF, measurement target = 100mΩ

Resistance measurement accuracy: $\pm(0.020\%rdg. + 0.020\%f.s.)$

$$\pm (0.020\% \times 100m\Omega + 0.020\% \times 300m\Omega) = \pm 0.08m\Omega$$

2 Temperature measurement accuracy

Measurement conditions: Thermistor temperature sensor, measurement temperature = 35°C

Temperature measurement accuracy: $\pm(0.55 + 0.012 \times |t-30|)$

$$\pm (0.55 + 0.012 \times |35-30|) = \pm 0.61^\circ C$$

3 Additional temperature correction accuracy

Measurement conditions: Temperature coefficient = 3930 ppm/°C, reference temperature = 20°C, measurement temperature = 35°C

$$\text{Additional error} = \frac{-\alpha_{t_0} \Delta t}{1 + \alpha_{t_0} \times (t + \Delta t - t_0)} \times 100[\%]$$

$$\frac{-0.393\% \times (\pm 0.6)}{1 + 0.393\% \times (35 \pm 0.6 - 20)} = +0.222\%rdg., -0.223\%rdg.$$

Functions

(1) Resistance range switch

| | |
|-----------------|--|
| Mode | AUTO/MANUAL (Manual mode is always ON when the comparator function is ON.) |
| Default setting | AUTO |

(2) Measurement current switch

| | |
|---------------------|---|
| Operation | Toggles the measurement current in the 300mΩ range. |
| Measurement current | Hi: 300 mA/L0: 100 mA |
| Default setting | Lo |

(3) Display refresh rate

| OVC | Measured value display refresh rate |
|-----|-------------------------------------|
| OFF | Approx. 100 ms |
| ON | Approx. 230 ms |

(If OVC is ON, the delay multiplied by two is added.)

Guideline for integration time (detected voltage data read time): 100 ms

(4) Zero adjustment

| | |
|-----------------------|---|
| Operation | Cancels the internal offset voltage and residual resistance before measurement. |
| Setting | ON/OFF (clear): For each range |
| Zero adjustment range | $\pm 3\%$ f.s. maximum for each range (f.s.=30,000 dgt.) |
| Default setting | OFF |

(5) Averaging

| | |
|-----------------|----------------|
| Operation | Moving average |
| Setting | OFF/2/5/10/20 |
| Default setting | OFF |

(6) Delay

| | |
|-----------------|--|
| Operation | Adjusts the time for measurement to stabilize by inserting a waiting period after using the OVC or the auto range function to change the measurement current. Preset: Integration starts after the factory-default time (which varies with the range) elapses. Non-preset value: Integration starts after the specified time elapses (for all ranges). |
| Setting | Preset (factory default)/ 10 ms/ 30 ms/ 50 ms/ 100 ms/ 300 ms/ 500 ms/ 1,000 ms If the OVC delay is set to 100 ms or less in a range of 3mΩ, 30mΩ, or 300mΩ* (*300mΩ = Hi measurement current), the delay is always 200 ms. |
| Default setting | Preset |

Preset OVC delay value (factory default) (Unit: ms)

| Measurement current | Range | Delay time |
|---------------------|-------------|------------|
| Lo | 3mΩ to 30mΩ | 200 |
| | 300mΩ to 3Ω | 50 |
| | 30Ω to 300Ω | 30 |
| Hi | 300mΩ | 200 |

(7) Temperature correction (TC)

| | |
|------------------------|--|
| Operation | Converts the measured resistance to that of a desired temperature using a temperature coefficient and displays it. |
| Expression | $R_{t_0} = \frac{R_t}{1 + \alpha_{t_0}(t - t_0)}$ |
| | R_t : Measured resistance value (Ω) |
| | R_{t_0} : Corrected resistance value (Ω) |
| | t_0 : Reference temperature (°C) Setting range: -10.0 to 99.9°C |
| | t : Current measurement temperature (°C) |
| | α_{t_0} : Temperature coefficient (1/°C) at t_0 Setting range: -9,999 to 9,999 ppm/°C |
| Temperature correction | ON/OFF (ΔT is always OFF when TC = ON). |
| Default setting | OFF, t_0 : 20°C, α_{t_0} : 3,930 ppm/°C |

(8) Offset Voltage Compensation (OVC)

| | |
|-----------------|--|
| Operation | Eliminates the effects of offset voltage. Performs two measurements with different currents when OVC is ON. |
| Valid ranges | 3mΩ range to 300Ω range |
| Setting | ON/OFF |
| Default setting | OFF |

(9) Measurement error detection**Out-of-range detection**

| | |
|-----------|---|
| Operation | Displays an out-of-range error if any of the following conditions occurs: <ul style="list-style-type: none"> • The measurement range is exceeded. • The A/D converter input range is exceeded during a measurement. • A calculation result exceeds the maximum display digits. |
|-----------|---|

Current fault detection

| | |
|-----------|---|
| Operation | Detects an error in which a predetermined measurement current cannot be applied. This function cannot be disabled. |
|-----------|---|

Circuit protection detection

| | |
|-----------|---|
| Operation | Detects whether an overvoltage is applied, and stops the measurement until the power is turned off. This function cannot be disabled. The circuit is protected until 42.4 V peak AC, 60 V DC is reached. |
|-----------|---|

(10) Comparator

| | |
|-----------------|---|
| Operation | Compares the set value and measured value. |
| Setting | ON/OFF (The range is fixed when the comparator function is ON. The comparator function automatically turns OFF when ΔT or the length conversion function turns ON.) |
| Judgment method | REF% mode / ABS mode |
| Default setting | OFF, ABS mode |
| Judgment | Hi measured value > upper limit value IN upper limit value \geq measured value \geq lower limit value Lo lower limit value > measured value |

ABS mode

| | |
|-----------------------------------|--------------------------------------|
| Upper and lower limit value range | 0.0000m Ω to 9.9999M Ω |
| Default setting | 0.0000m Ω |

REF% mode

| | |
|---------|---|
| Display | Relative value display |
| | Relative value = $\left(\frac{\text{Measured value}}{\text{Reference value}} - 1 \right) \times 100[\%]$ |

| | |
|-----------------------------------|---|
| Relative value display range | -999.99% to 999.99% |
| Reference value range | 0.0001mΩ to 9.9999MΩ |
| Upper and lower limit value range | 0.00% to ± 99.99% |
| Default setting | Reference value: 0.0001mΩ, upper and lower limit value range: 0.00% |

(11) Judgment sound

| | |
|-----------------|--|
| Function | Sounds the buzzer, based on a comparator judgment result. |
| Setting | OFF / Hi / IN / Lo / Hi or Lo / ALL1 / ALL2 The ALL1 and ALL2 sounds differ between Hi, Lo, and IN. |
| Default setting | OFF |

(12) Temperature conversion (ΔT)

| | | | | | | | | | | | | | |
|------------------------------------|---|-----|-----------------------|------------------------------------|--|------------------|---|------------------------------------|--|------------------|---|----------------------|--|
| Operation | Converts a measured resistance value to a temperature, based on the fact that resistance depends on temperature, to display the temperature rise value. | | | | | | | | | | | | |
| Expression | $\Delta t = \frac{R_2}{R_1} (k + t_1) - (k + t_2)$ | | | | | | | | | | | | |
| | <table border="1"> <tr> <td>Δt:</td> <td>Temperature rise (°C)</td> </tr> <tr> <td>t₁: Setting range:</td> <td>Winding temperature (°C) (in a cool state) during initial resistance R₁ measurement -10.0 to 99.9°C</td> </tr> <tr> <td>t₂:</td> <td>Coolant temperature (°C) at the completion of the temperature rise test</td> </tr> <tr> <td>R₁: Setting range:</td> <td>Winding resistance (Ω) at temperature t₁ (in a cool state) 0.0001mΩ to 3.5000MΩ</td> </tr> <tr> <td>R₂:</td> <td>Winding resistance (Ω) at the completion of the temperature rise test</td> </tr> <tr> <td>k: Setting range:</td> <td>Reciprocal (°C) of temperature coefficient of conductor material at 0°C -999.9 to 999.9°C</td> </tr> </table> | Δt: | Temperature rise (°C) | t ₁ : Setting range: | Winding temperature (°C) (in a cool state) during initial resistance R ₁ measurement -10.0 to 99.9°C | t ₂ : | Coolant temperature (°C) at the completion of the temperature rise test | R ₁ : Setting range: | Winding resistance (Ω) at temperature t ₁ (in a cool state) 0.0001mΩ to 3.5000MΩ | R ₂ : | Winding resistance (Ω) at the completion of the temperature rise test | k: Setting range: | Reciprocal (°C) of temperature coefficient of conductor material at 0°C -999.9 to 999.9°C |
| Δt: | Temperature rise (°C) | | | | | | | | | | | | |
| t ₁ : Setting range: | Winding temperature (°C) (in a cool state) during initial resistance R ₁ measurement -10.0 to 99.9°C | | | | | | | | | | | | |
| t ₂ : | Coolant temperature (°C) at the completion of the temperature rise test | | | | | | | | | | | | |
| R ₁ : Setting range: | Winding resistance (Ω) at temperature t ₁ (in a cool state) 0.0001mΩ to 3.5000MΩ | | | | | | | | | | | | |
| R ₂ : | Winding resistance (Ω) at the completion of the temperature rise test | | | | | | | | | | | | |
| k: Setting range: | Reciprocal (°C) of temperature coefficient of conductor material at 0°C -999.9 to 999.9°C | | | | | | | | | | | | |
| ΔT display range | -999.9 to 999.9°C | | | | | | | | | | | | |
| Temperature conversion | ON/OFF (If ΔT is ON, the TC and comparator functions are always OFF. When the length conversion function is ON, ΔT automatically turns OFF.) | | | | | | | | | | | | |
| Default setting | OFF, t ₁ : 23.0°C, R ₁ : 1.0000Ω, k: 235.0 | | | | | | | | | | | | |

(13) Length conversion

| | |
|----------------------|---|
| Operation | Converts a measured value to a length for display. |
| Length display range | 0.0000 mm to 999.99 km (When the resistance is negative, a negative sign is also displayed.) |
| Setting | ON/OFF (If the length conversion function is ON, the comparator function is always OFF. When ΔT is ON, the length conversion function automatically turns OFF.) |
| Resistance per meter | 0.0001m Ω to 350.00 Ω |
| Default setting | OFF, 1 Ω |
| Display format | See the following table. |

| Range | Resistance per meter | | | |
|---------------|----------------------------|----------------------------|----------------------------|----------------------------|
| | 0.0001 to 0.0034m Ω | 0.0035 to 0.0350m Ω | 0.0351 to 0.3500m Ω | 0.3501 to 3.5000m Ω |
| 3m Ω | 0.0000 km | 000.00 m | 00.000 m | 0.0000 m |
| 30m Ω | 00.000 km | 0.0000 km | 000.00 m | 00.000 m |
| 300m Ω | 000.00 km | 00.000 km | 0.0000 km | 000.00 m |
| 3 Ω | *1 | 000.00 km | 00.000 km | 0.0000 km |
| 30 Ω | *1 | *1 | 000.00 km | 00.000 km |
| 300 Ω | *1 | *1 | *1 | 000.00 km |
| 3k Ω | *1 | *1 | *1 | *1 |
| 30k Ω | *1 | *1 | *1 | *1 |
| 300k Ω | *1 | *1 | *1 | *1 |
| 3M Ω | *1 | *1 | *1 | *1 |

*1 Out-of-range display

| Range | Resistance per meter | | | | |
|---------------|----------------------------|----------------------------|-------------------------------------|---------------------------|---------------------------|
| | 3.5001 to 35.000m Ω | 35.001 to 350.00m Ω | 350.01m Ω to 3.5000 Ω | 3.5001 to 35.000 Ω | 35.001 to 350.00 Ω |
| 3m Ω | 000.00 mm | 00.000 mm | 0.0000 mm | *1 | *1 |
| 30m Ω | 0.0000 m | 000.00 mm | 00.000 mm | 0.0000 mm | *1 |
| 300m Ω | 00.000 m | 0.0000 m | 000.00 mm | 00.000 mm | 0.0000 mm |
| 3 Ω | 000.00 m | 00.000 m | 0.0000 m | 000.00 mm | 00.000 mm |
| 30 Ω | 0.0000 km | 000.00 m | 00.000 m | 0.0000 m | 000.00 mm |
| 300 Ω | 00.000 km | 0.0000 km | 000.00 m | 00.000 m | 0.0000 m |
| 3k Ω | 000.00 km | 00.000 km | 0.0000 km | 000.00 m | 00.000 m |
| 30k Ω | *1 | 000.00 km | 00.000 km | 0.0000 km | 000.00 m |
| 300k Ω | *1 | *1 | 000.00 km | 00.000 km | 0.0000 km |
| 3M Ω | *1 | *1 | *1 | 000.00 km | 00.000 km |

*1 Out-of-range display

(14) Auto-hold function

| | |
|-----------------|--|
| Operation | Automatically holds the measurement value. The hold is released under the following condition: When measurement is performed after the test lead has been released once, or the range is changed, or the [ESC] key is pressed. |
| Setting | ON/OFF |
| Default setting | OFF |

(15) Memory

| | | |
|--------------------|---|--|
| Manual memory | Operation: | Stores a measured value when the MEMORY key is pressed. |
| | Saved contents: | Date and time, measurement value, temperature, resistance measurement range, averaging, comparator, changed measurement current, temperature correction (TC), and OVC |
| Auto-memory | Operation: | Stores a measured value after an auto-hold occurs. |
| | Saved contents: | Date and time, measurement value, temperature, resistance measurement range, averaging, comparator, changed measurement current, temperature correction (TC), and OVC |
| | Setting: | ON/OFF |
| Interval memory | Operation: | Stores a measured value for each interval. |
| | Saved contents: | Start date and time, measurement value, temperature, resistance measurement range, averaging, temperature correction (TC), temperature conversion (ΔT), and interval |
| | Setting: Interval: | ON/OFF 0.2 to 10.0 s (0.2-second step) |
| No. of memory | No. of blocks: | 10 |
| | Manual or auto-memory: | Up to 1,000 |
| | Interval: | Up to 6,000 |
| Memory data export | Display, USB mass storage (CSV or TXT file) | |
| Default setting | Auto-memory: | OFF |
| | Interval memory: | OFF |
| | Interval: | 0.2 s |
| Memory clear | Memory end/single block/all memory | |

(16) Panel save and panel load

| | |
|----------------|--|
| Operation | Saves or loads a set of measurement conditions by specifying the panel number. |
| No. of panels | 9 |
| Saved contents | Resistance measurement range, averaging, delay, comparator, judgment sound, temperature conversion (ΔT), changed measurement current, length conversion, temperature correction (TC), OVC, and memory mode |
| Panel clear | Clears a panel. |

(17) Clock

| | |
|-----------------------|--|
| Date and time display | Auto calendar, automatic leap year recognition |
| Time display | 24 hours |
| Clock accuracy | ± 4 minutes per month |
| Default setting | 00:00:00 January 1, 2013 |
| Backup battery life | Approx. 10 years (guideline for 23°C) |

(18) Reset**Reset**

| | |
|-----------|---|
| Operation | Reset all settings other than the panel and saved measurement data, and clock settings to the factory defaults. |
|-----------|---|





System reset

| | |
|-----------|--|
| Operation | Reset all settings except the clock settings, including the panel and saved measurement data, to the factory defaults. |
|-----------|--|

(19) Auto Power Save (APS)

| | |
|-----------|---|
| Operation | Automatically turns the power off if no key operation is performed or a measurement error state remains for 10 minutes. The APS function is automatically disabled during an interval measurement or USB connection. It can be disabled manually. |
|-----------|---|

(20) Remaining battery detection

| | |
|-----------|--|
| Operation | Displays the remaining battery power in three levels. <ul style="list-style-type: none">  10.0 V \pm 0.2 V or higher  8.5 V \pm 0.2 V to below 10.0 V \pm 0.2 V  8.0 V \pm 0.2 V to below 8.5 V \pm 0.2 V  Below 8.0 V \pm 0.2 V (The instrument is turned off.) |
|-----------|--|

(21) Self-test

| | |
|---------------|---|
| Power-on test | ROM/RAM check, check of fuse for measurement circuit protection |
|---------------|---|

Interface

(1) Display

| | |
|----------|--------------------------------|
| LCD type | LCD (monochrome, 212 segments) |
|----------|--------------------------------|

(2) Keys

COMP, PANEL, TC/ Δ T, AVG, +, -, ◀, ▶, ESC, ENTER, MEMORY, READ, MODE, 0ADJ, AUTO, ▼, ▲(range), Ⓞ (power)

(3) USB interface

| | |
|---------------------------|------------------------------------|
| Connector | Series mini-B receptacle |
| Electrical specifications | USB 2.0 (Full Speed) |
| Class | USB mass storage class (read only) |

(4) L2105 LED Comparator Attachment output

| | | |
|-----------------|--|-------|
| Output | Comparator result output (two levels: Hi and Lo/ IN) | |
| Output terminal | 3-pole earphone jack (ϕ 2.5 mm) | |
| Output voltage | 5 V DC \pm 0.2 V | 20 mA |

Environmental and safety specifications

| | |
|---|---|
| Operating environment | Indoors, pollution degree 2, altitude up to 2,000 m (6,562-ft.) |
| Storage temperature and humidity ranges | -10°C to 50°C (14°F to 122°F), 80%RH or less (non-condensing) |
| Operating temperature and humidity ranges | 0°C to 40°C (32°F to 104°F), 80%RH or less (non-condensing) |
| Applicable standards | Safety EN61010 |
| | EMC EN61326 |
| Power supply | LR6 alkaline battery × 8 |
| Rated power supply voltage | 1.5 V DC × 8 |
| Maximum rated voltage | 5 VA |
| Continuous operating time | Approx. 10 hours (when all new alkaline batteries are used) This assumes that a one-second measurement is performed every 10 seconds at the 3mΩ range. |
| Dimensions | Approx. 192 (W) × 121 (H) × 55 (D) mm (7.56" (W) × 4.76" (H) × 2.17" (D)) |
| Mass | Approx. 770 g (27.2 oz) |
| Product warranty period | 3 years |

Accessories

| | | |
|-------|--------------------------|---|
| L2107 | Clip Type Lead | 1 |
| Z2002 | Temperature Sensor | 1 |
| | LR6 alkaline battery | 8 |
| | Instruction Manual | 1 |
| | USB cable (A-miniB type) | 1 |
| | Strap | 1 |
| | Spare fuse (F2AH/250V) | 1 |

Options

| | |
|---------|---------------------------|
| L2107 | Clip Type Lead |
| 9453 | Four Terminal Lead |
| 9454 | Zero Adjustment Board |
| 9465-10 | Pin Type Lead |
| 9467 | Large Clip Type Lead |
| 9772 | Pin Type Lead |
| L2105 | LED Comparator Attachment |
| Z2002 | Temperature Sensor |
| C1006 | Carrying Case |

Calibration

IMPORTANT

Periodic calibration is necessary in order to ensure that the instrument provides correct measurement results of the specified accuracy.

The calibration frequency varies depending on the status of the instrument or installation environment. We recommend that the calibration frequency is determined in accordance with the status of the instrument or installation environment and that you request that calibration be performed periodically.

Cleaning

To clean the instrument or options, wipe it gently with a soft cloth moistened with water or mild detergent.

Wipe the display gently with a soft, dry cloth.

IMPORTANT

Never use solvents such as benzene, alcohol, acetone, ether, ketones, thinners or gasoline, as they can deform and discolor the case.

10.1 Troubleshooting

If the instrument appears to have failed, check “Q&A (frequently asked questions and answers)” below before contacting your authorized Hioki distributor or reseller.

Q&A (frequently asked questions and answers)

If none of the problems listed below applies to your case, contact your authorized Hioki distributor or reseller.

General problems

| No. | Problem | Check item | | Suspected cause→Action | See |
|-----|---|---------------------------------|---|---|----------|
| 1-1 | The instrument does not turn on (or the display remains blank). | | | The remaining battery level is insufficient. → Replace the batteries. | (p. 29) |
| 1-2 | The power turns off quickly. | What type of batteries is used? | Non-alkaline batteries | Do not use non-alkaline batteries. → Use alkaline batteries. | - |
| | | What is displayed? | The indicated remaining battery level is low. | The remaining battery level is insufficient. → Replace the batteries. | (p. 29) |
| | | | APS is lit. | APS (Auto Power Save) is working. → The instrument automatically turns off when no operation is performed for a while. APS can also be canceled. | (p. 33) |
| 1-3 | No key operations are possible. | What is displayed? | Setting screen | The instrument is waiting for Apply or Cancel command. → Press the ESC or ENTER key. | (p. 19) |
| | | | USB | No key operations are possible during a USB connection. → Remove the USB cable. | (p. 86) |
| | | | The INTERVAL indicator is blinking. | No key other than the STOP key works during interval measurement. → Press and hold the STOP (MEMORY) key to stop the interval measurement. | (p. 79) |
| | | | Others | Each function has an incompatible function. → See the table listing function limitations. | (p. 109) |

| No. | Problem | Check item | Suspected cause→Action | See |
|-----|--|--|--|---------------|
| 1-4 | The comparator judgment result indicator is not lit. | Is a measured value displayed? | Displayed The comparator function is set to OFF. → Turn the function ON. | (p. 60) |
| | | | Not displayed (or something other than a number or oF is displayed.) If no measured value is displayed, no judgment is performed and the lamp is not lit. | |
| 1-5 | The L2105 LED Comparator Attachment is not lit. | Is the comparator judgment result indicator on the instrument lit? | Lit The L2105 LED Comparator Attachment is not connected correctly. → Connect it to COMP.OUT correctly. | (p. 66) |
| | | | Not lit The cable is broken. → Replace the LED Comparator Attachment. → See the Q&A, "The comparator judgment result indicator is not lit". | - (p. 109) |
| 1-6 | No buzzer sound is heard. | What is the judgment sound setting? | OFF The function is set to OFF. → Turn the function ON. | (p. 65) |

Function limitations (√: Compatible, -: Incompatible)

| | COMP | TC | ΔT | LENGTH | RANGE change |
|--------------|------|----|------------|--------|--------------|
| COMP | | √ | - | - | - |
| TC | √ | | - | √ | √ |
| ΔT | - | - | | - | √ |
| LENGTH | - | √ | - | | √ |
| RANGE change | - | √ | √ | √ | |



Computer connection-related problems

| No. | Problem | Check item | | Suspected cause→Action | See |
|-----|--|--------------------------------------|-------------------------|--|---------|
| 2-1 | RM3548 does not appear on the PC. | What is displayed on the instrument? | “USB” is not displayed. | The connection has not been established. → Check that the connectors are fully inserted. → Insert a different USB memory device into the PC and check that the device is recognized by the PC. | (p. 86) |
| | | | Nothing is displayed. | → Turn the RM3548 on. | (p. 32) |
| 2-2 | No saved data is found. | | | A different drive is being viewed. → Access the RM3548 drive. | (p. 86) |
| | | | | No data is saved. → Remove the USB cable, check that data is saved on the instrument. If no data file is found, no data is saved. Attempt to save the data again. | (p. 75) |
| 2-3 | A file operation cannot be performed. • A file name cannot be changed. • File contents cannot be edited. • A file cannot be written to. • Data cannot be deleted. • Data cannot be cut. | | | The saved data file is read-only. → Copy the file to the PC, and then edit it on the PC. → Remove the USB cable and delete the saved data on the instrument. | (p. 86) |

Measurement-related problems

| No. | Problem | Check item | Suspected cause→Action | See | |
|-----------------|--|--|--|--|---------|
| 3-1 | The measured value does not stabilize. | Is it affected by noise? | It may be affected by noise. → See Appendix 8(1). (p. Appx.17) | | |
| | | What type is the test lead? | Clip type lead | → See Appendix 8(2). (p. Appx.20) | |
| | | | Two-terminal configuration from the middle | → See Appendix 8(8). (p. Appx.24) | |
| | | What type of target is being measured? | The target is wide or thick. | → See Appendix 8(3). (p. Appx.21) | |
| | | | The measurement target temperature has not stabilized (because it has just been produced or unpacked, or held with a hand). | → See Appendix 8(4). (p. Appx.23) | |
| | | | The heat capacity is low. | → See Appendix 8(5). (p. Appx.23) | |
| | | Transformer | The measurement is started before the measurement current stabilizes. → Increase the delay, or turn the OVC function OFF. | (p. 51) (p. 53) | |
| | | | Motor, choke coil, solenoid | The measurement is started before the measurement current stabilizes. → Increase the delay. | (p. 53) |
| | | How is TC set? | ON | The position of the Z2002 Temperature Sensor is not appropriate. → Bring the Z2002 Temperature Sensor closer to the measurement target. → Do not expose the Z2002 Temperature Sensor to airflow. | (p. 13) |
| | | | OFF | The resistance of the measurement target is changing due to temperature fluctuations (a change in the room temperature, for example). → Turn the temperature correction (TC) function ON. | (p. 50) |
| How is OVC set? | OFF | The measurement is affected by thermal EMF. → Turn the OVC function ON. | (p. 51) | | |

| No. | Problem | Check item | | Suspected cause→Action | See | |
|--|--|---------------------------------|-----|--|---|----------|
| 3-1 | The measured value does not stabilize. | Others | | A test lead is not connected. → Fully insert the test lead. → Replace the test lead. | (p. 30) | |
| | | | | A client-made lead with an excessively high contact resistance is used. → Increase the contact pressure. → Clean or replace the tip of the probe. | - | |
| | | | | A client-made lead with an excessively high wiring resistance is used. →Use a thicker and shorter wire instead. | - | |
| 3-2 | The measured value is quite different from the expected value. | How is the zero adjustment set? | ON | The zero adjustment is not correct. → Perform zero adjustment again or clear zero adjustment. | (p. 44) | |
| | | | OFF | <ul style="list-style-type: none"> The measurement is affected by wiring resistance in a two-terminal measurement. The measurement is affected by thermal EMF. → Perform zero adjustment. → Use the OVC function. | (p. 44) (p. 51) | |
| Also see the Q&A, “No. 3-1 The measured value does not stabilize.” (p. 111). | | | | | | |
| 3-3 | Measured value is not displayed. (For information on displayed measurement errors, also see p. 40.) | What is displayed? | | A test lead has a broken wire. → Replace the test lead. | (p. 30) | |
| | | | | A client-made lead with an excessively high contact resistance is used. → Increase the contact pressure. → Clean or replace the tip of the probe. | - | |
| | | | | A client-made lead with an excessively high wiring resistance is used. →Use a thicker and shorter wire instead. | - | |
| | | | | The measurement range is low. →Select a higher resistance range or the auto range. | (p. 36) | |
| | | | | Nothing is displayed. | The instrument is not set to a fixed range in the auto range mode. → See the Q&A, “No. 3-4 The instrument is not set to a fixed range in the auto range mode”. | (p. 113) |
| | | | | Nothing is displayed even when the test leads are short-circuited. | Fuse may be blown. → Turn the power on again and perform a self-test to confirm that the fuse is not blown. | (p. 32) |

| No. | Problem | Check item | | Suspected cause→Action | See |
|-----|--|---|--|---|-------------------------------|
| 3-4 | The instrument is not set to a fixed range in the auto range mode. | What type of target is being measured? | Transformer, motor | The measurement is started before the measurement current stabilizes. → Set the instrument to a fixed range. → Increase the delay. → Turn the OVC function OFF. | (p. 36) (p. 51) (p. 53) |
| | | Is it affected by noise? | It may be affected by noise. | → See Appendix 8(1). (p. Appx.17) | |
| 3-5 | Zero adjustment cannot be performed. | What is the pre-zero adjustment measured value? | The measured value has exceeded ±3% of the full scale of the range, or a measurement error has occurred. | There is a connection problem. → Make sure that the leads are connected correctly, and then perform zero adjustment again. If a client-made cable with a high resistance is used, zero adjustment will not succeed. In such a case, reduce the wiring resistance. | (p. 44) |
| 3-6 | Auto-hold does not work (or the hold is not released) | How is the measured value? | It does not stabilize. | See the Q&A, "No. 3-1 The measured value does not stabilize". | (p. 111) |
| | | | No change occurs. | The selected range is not appropriate. → Select the appropriate range or the auto range mode. | (p. 36) |
| 3-7 | Unable to perform measurement in a lower resistance range | | | The remaining battery level has been low. → In a lower resistance range, a maximum current of 1 A flows, which increases power consumption. Current may not be supplied even before the battery level indicator  starts to blink ( or  is displayed). Replace the batteries. | - |

Error display and actions

If the instrument or measurement status has a problem, one of the messages listed below will be displayed. When a repair is necessary, contact your authorized Hioki distributor or reseller.

- If the instrument appears to have failed, check “Q&A (frequently asked questions and answers)” (p. 108) before contacting your authorized Hioki distributor or reseller.
- If an error is indicated on the LCD display and a repair is necessary, contact your authorized Hioki distributor or reseller.

| Display | Meaning | Action |
|---------|--|--|
| FAiL | Execution error | The required action varies depending on what is being performed. (Example) Outside the zero adjustment range when this error is displayed while zero adjustment is being performed. |
| Err90 | Program ROM checksum error | The instrument has failed. Send it for repair. |
| Err91 | CPU RAM error | The instrument has failed. Send it for repair. |
| Err92 | SRAM read/write test error | The instrument has failed. Send it for repair. |
| Err93 | FRAM read/write test error | The instrument has failed. Send it for repair. |
| Err95 | Adjustment data error | The instrument has failed. Send it for repair. |
| Err96 | Configuration backup error | Perform a system reset. (p. 91) If the error is not recovered, the instrument has failed. Send it for repair. |
| Err99 | The clock is not set. When the [ENTER] key is pressed, the clock is initialized to 12-01-01 00:00:00. | The backup battery should be replaced. Contact your authorized Hioki distributor or reseller. |
| FUSE | A fuse is blown. | Replace the fuse. |
| PrtCt | The protection function is working. | If an overvoltage is accidentally applied, remove the test leads from the measurement target immediately. Measurement cannot be performed while the protection function is activated. In order to cancel the protection function, contact test lead A (red) to B (black) or turn the power off and on. |
| t.Err | When TC or ΔT is ON, the Z2002 Temperature Sensor is not connected or oF is displayed for the temperature. | Check the connection of the Z2002 Temperature Sensor. |

10.2 Repair and Inspection

Replacement parts and longevity

- The longevity of the instrument varies depending on the usage environment and frequency.

Note that operation within the following period of time is not guaranteed. When replacing the part, contact your authorized Hioki distributor or reseller.

- When transporting the instrument, also see “Precautions during shipment” (p. 8).

| Parts | Longevity |
|------------------------|---|
| Electrolytic capacitor | Approx. 10 years |
| Lithium battery | Approx. 10 years The instrument contains a lithium battery for clock backup. If the displayed date or time is significantly different from the actual time when the power is turned on, the battery should be replaced. Contact your authorized Hioki distributor or reseller. |

10.3 Replacing Fuses

If the fuse for the measurement circuit protection is broken, use the following procedure to replace the fuse.

WARNING

To avoid electric shock, turn the power off and remove the leads before replacing the fuse.



Replace the fuse only with one of the specified type, characteristics, rated current, and rated voltage. Do not use fuses other than those specified (especially, do not use a fuse with higher-rated current) or do not short circuit and use the fuse holder. Doing so may damage the instrument and result in personal injury.

Specified fuse: F2AH/250 V (with extinguishing material) $\phi 5 \times 20$ mm

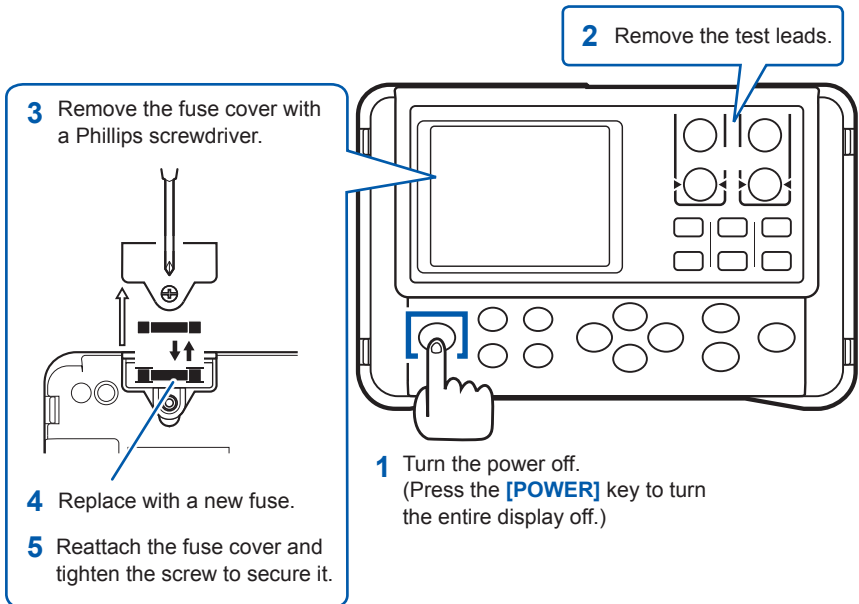

10.4 Disposing of the Instrument

- The instrument contains a lithium battery for backup. The life of the backup battery is approx. 10 years. If the displayed date or time is significantly different from the actual time when the power is turned on, the battery should be replaced. Contact your authorized Hioki distributor or reseller.
- When disposing of the instrument, remove the lithium battery and dispose of it according to the local regulations.

Removing the backup battery

⚠ WARNING



To avoid electric shock, remove all the alkaline batteries and test leads before removing the lithium battery.

- 1 Turn the power off.
(Press the **[POWER]** key to turn the entire display off.)
- 2 Remove the test leads.

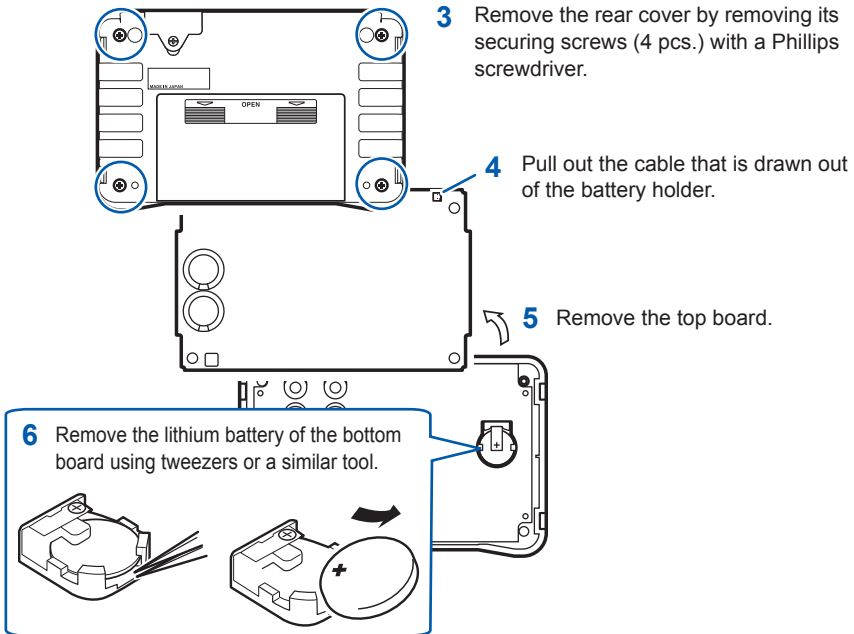

CALIFORNIA, USA ONLY

This instrument contains a CR Coin Lithium Battery which contains Perchlorate Material - special handling may apply. See www.dtsc.ca.gov/hazardouswaste/perchlorate

Appendix

Appx. 1 Block Diagram

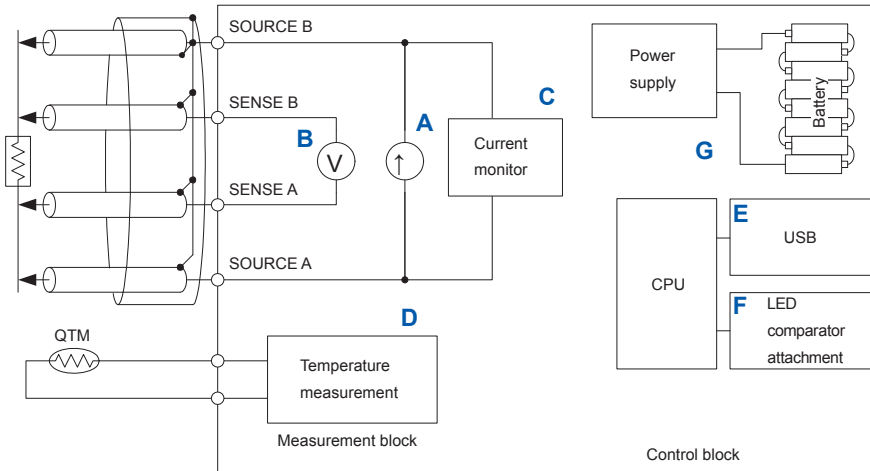

- Apply constant current determined by the measurement range from the SOURCE B terminal to the SOURCE A terminal, and measure the voltage between the SENSE B and SENSE A terminals. The resistance value ($R=V/I$) is obtained by dividing the measured voltage (V) by the constant current value (I). (A, B)
- The constant current source and voltmeter circuitry is designed not to be affected by contact resistance easily.
- During measurement, it is monitored whether normal constant current flow is present in the measurement target. (C)
- In addition to resistance, temperature is measured with a thermistor temperature sensor (Z2002 Temperature Sensor) at the same time. The measured temperature can be used to correct the resistance value. (D)
- With USB connection, the instrument acts as a mass storage device. Data can be exported to a PC easily. (E)
- The optional L2105 LED Comparator Attachment can be used to judge a measurement result without needing to watch the display.
- The instrument is powered by eight LR6 alkaline batteries. It is compact, but can use a large current of 1 A for measurement with a resolution of $0.1\mu\Omega$. (A, G)

Appx. 2 Four-Terminal (Voltage-Drop) Method

The accuracy of low resistance measurement is significantly affected by the resistance of wires between a measuring instrument and probes, and by the contact resistance between the probes and a measurement target.

Wiring resistance varies significantly, depending on the thickness and length of the wire. The cable used for resistance measurement is approx. 90mΩ/m for AWG24 (0.2sq) or approx. 24mΩ/m for AWG18 (0.75sq), for example.

Contact resistance depends on the degree of wear and contact pressure of the probes, and the measurement current. Even for a good contact, the resistance is several mΩ. It is not rare for the resistance to reach several Ω.

The four-terminal method is essential for measuring very small resistance values. With two-terminal measurements (Fig. 1), the resistance of the test leads is included in the measured resistance, resulting in measurement errors.

The four-terminal measurements (Fig. 2) consist of the current source terminals (SOURCE A and SOURCE B) to provide constant current, and voltage detection terminals (SENSE A and SENSE B) to detect voltage drop.

Because of the high input impedance of the voltmeter, measurement requires practically no current flow through the leads connecting the voltage detection terminals to the measurement target, practically eliminating the effects of lead and contact resistance on the measurement.

Two-terminal measurement method

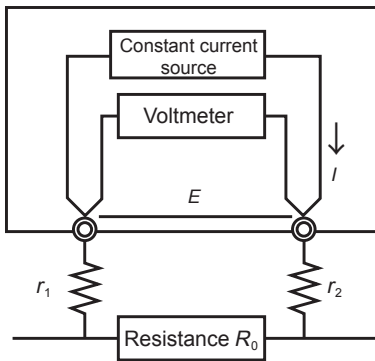

Fig. 1

Measurement current I flows through test object resistance R_0 as well as lead resistances r_1 and r_2 . The voltage to be measured is obtained by $E=I (r_1+R_0+r_2)$, which includes lead resistances r_1 and r_2 .

Four-terminal measurement method

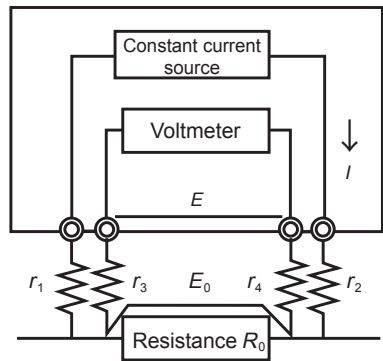

Fig. 2

Current I flows from r_2 through measurement target resistance R_0 to r_1 . The high input impedance of the voltmeter allows only negligible current flow through r_3 and r_4 . So the voltage drop across r_3 and r_4 is practically nil, and voltage E across the measurement terminals and voltage E_0 across test object resistance R_0 are essentially equal, allowing test object resistance to be measured without being affected by r_1 to r_4 .

Appx. 3 DC Method and AC Method

There are two resistance measurement (or impedance measurement) types: DC and AC.

- DC type
 - Resistance meters RM3542, RM3543, RM3544, RM3545, RM3548
 - Common digital multimeters
 - Common insulation testers
- AC type
 - Battery HiTesters 3561, BT3562, BT3563, 3554
 - Common LCR meters

DC resistance meters are widely used for measurement of general-purpose resistors, winding resistance, contact resistance, insulation resistance, etc. The DC type consists of an DC power supply and DC voltmeter. While its simple circuitry makes it easier to increase accuracy, it is prone to measurement errors due to electromotive force that may be present in the measurement path.

The AC type is used where measurement with direct current is not possible, including measurement of inductors, capacitors, and battery impedance. Essentially, an AC resistance meter is not affected by DC electromotive force, because it consists of an AC power supply and AC voltmeter. However, it is important to note that an AC resistance meter may indicate a different measurement value from a DC one, for example, due to an iron loss included in the series equivalent resistance of a coil.

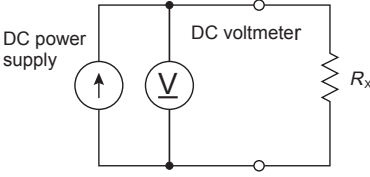
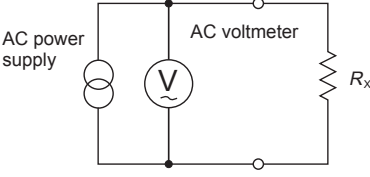
| | DC resistance meters | AC resistance meter |
|--------------------------------------|--|--|
| Measurement signal detection voltage | Direct current  | Alternating current  |
| Advantages | Capable of high-precision measurement | Capable of reactance measurement without being affected by electromotive force |
| Disadvantages | Affected by electromotive force, since DC-biased measurement is not possible. (However, the OVC function can be used to compensate for thermal EMF.) | Difficult to increase accuracy |
| Applications | DC resistance of windings such as transformers and motors, contact resistance, insulation resistance, and PCB track resistance | Electrochemical measurement of battery impedance, inductors, and capacitors |
| Measurement range | 10^{-8} to 10^{16} | 10^{-3} to 10^8 |
| Hioki measuring instruments | Resistance meters: RM3542 to RM3548 DMM: 3237 to 3238 Insulation testers: IR4000 series, DSM series | Battery HiTesters: 3561, BT3562, BT3563 LCR meters: IM3570, IM3533, IM3523, etc. |

Appx. 4 Temperature Correction Function (TC)

Temperature correction converts the value of a resistance that depends on temperature, such as that of a copper wire, to a resistance value at a particular temperature to display it.

Resistances R_t and R_{t_0} below are the resistance values of the measurement target (having resistance temperature coefficient at t_0 °C of α_{t_0}) at t °C and t_0 °C.

| | |
|--|---|
| $R_t = R_{t_0} \times \{1 + \alpha_{t_0} \times (t - t_0)\}$ | |
| R_t | Actual measured resistance [Ω] |
| R_{t_0} | Corrected resistance [Ω] |
| t_0 | Reference temperature [°C] |
| t | Current ambient temperature [°C] |
| α_{t_0} | Temperature coefficient at t_0 [1/°C] |

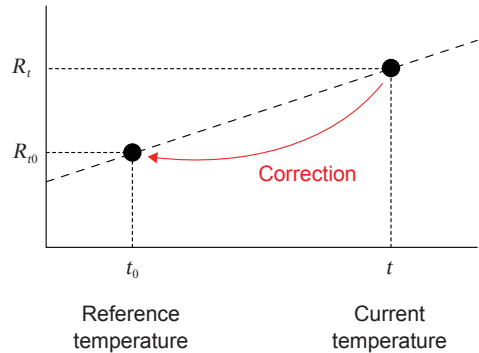

Example

If a copper test object (with a resistance temperature coefficient at 20°C of 3930 ppm) measures 100Ω at 30°C, its resistance at 20°C is calculated as follows:

$$\begin{aligned}
 R_{t_0} &= \frac{R_t}{1 + \alpha_{t_0} \times (t - t_0)} \\
 &= \frac{100}{1 + (3930 \times 10^{-6}) \times (30 - 20)} \\
 &= 96.22
 \end{aligned}$$

See “4.3 Compensating for Thermal Effects (Temperature Correction (TC))” (p. 50) for temperature correction settings and execution method.

IMPORTANT

- The temperature probe detects only ambient temperature; not surface temperature.
- Before measuring, place the temperature sensor as close to the measurement target as possible, and allow sufficient time for them to stabilize at ambient temperature.

Reference**Conductive properties of metals and alloys**

| Material | Content [%] | Density ($\times 10^3$) [kg/m ³] | Conductivity | Temp. Coeff. (20°C) [ppm] |
|--------------------------|--|---|------------------------------|------------------------------|
| Annealed copper wire | Cu > 99.9 | 8.89 | 1.00 to 1.02 | 3810 to 3970 |
| Hard-drawn copper wire | Cu > 99.9 | 8.89 | 0.96 to 0.98 | 3770 to 3850 |
| Cadmium copper wire | Cd 0.7 to 1.2 | 8.94 | 0.85 to 0.88 | 3340 to 460 |
| Silver copper | Ag 0.03 to 0.1 | 8.89 | 0.96 to 0.98 | 3930 |
| Chrome copper | Cr 0.4 to 0.8 | 8.89 | 0.40 to 0.50 0.80 to 0.85 | 2000 3000 |
| Carlson alloy wire | Ni 2.5 to 4.0 Si 0.5 to 1.0 | | 0.25 to 0.45 | 980 to 1770 |
| Annealed aluminum wire | Al > 99.5 | 2.7 | 0.63 to 0.64 | 4200 |
| Hard-drawn aluminum wire | Al > 99.5 | 2.7 | 0.60 to 0.62 | 4000 |
| Aldrey wire | Si 0.4 to 0.6 Mg 0.4 to 0.5 Al remaining portion | | 0.50 to 0.55 | 3600 |

Copper wire conductivity

| Diameter [mm] | Annealed copper wire | Tinned annealed copper wire | Hard-drawn copper wire |
|------------------------|----------------------|-----------------------------|------------------------|
| 0.01 to less than 0.26 | 0.98 | 0.93 | - |
| 0.26 to less than 0.29 | 0.98 | 0.94 | - |
| 0.29 to less than 0.50 | 0.993 | 0.94 | - |
| 0.50 to less than 2.00 | 1.00 | 0.96 | 0.96 |
| 2.00 to less than 8.00 | 1.00 | 0.97 | 0.97 |

The temperature coefficient changes according to the temperature and conductivity. If the temperature coefficient at 20°C is α_{20} and the temperature coefficient for conductivity C at $t^\circ\text{C}$ is α_{Ct} , α_{Ct} is determined as follows near the ambient temperature.

$$\alpha_{Ct} = \frac{1}{\frac{1}{\alpha_{20} \times C} + (t - 20)}$$

For example, the temperature coefficient of international standard annealed copper is 3930 ppm/°C at 20°C. For tinned annealed copper wire (with a diameter from 0.10 to less than 0.26 mm), the temperature coefficient α_{20} at 20°C is calculated as follows:

$$\alpha_{20} = \frac{1}{\frac{1}{0.00393 \times 0.93} + (20 - 20)} = 3650 \text{ ppm/}^\circ\text{C}$$

Appx. 5 Temperature Conversion (ΔT) Function

Utilizing the temperature-dependent nature of resistance, the temperature conversion function converts resistance measurements for display as temperatures. This method of temperature conversion is described here.

According to IEC 60034, the resistance law may be applied to determine temperature increase as follows:

| | |
|--|---|
| $\Delta t = \frac{R_2}{R_1} (k + t_1) - (k + t_2)$ | |
| Δt | Temperature increase [$^{\circ}\text{C}$] |
| t_1 | Winding temp. [$^{\circ}\text{C}$] (cool state) when measuring initial resistance R_1 |
| t_2 | Coolant temp. [$^{\circ}\text{C}$] at the end of temperature rise test |
| R_1 | Winding resistance [Ω] at temp. t_1 (cool state) |
| R_2 | Winding resistance [Ω] at the end of temperature rise test |
| k | Reciprocal [$^{\circ}\text{C}$] of temp. coefficient of conductor material at 0°C |

Example

With resistance R_1 of 200m Ω at initial temperature t_1 of 20°C , and measured resistance R_2 of 210m Ω at current ambient temperature t_2 of 25°C , the temperature increase value is calculated as follows:

$$\begin{aligned} \Delta t &= \frac{R_2}{R_1} (k + t_1) - (k + t_2) \\ &= \frac{210 \times 10^{-3}}{200 \times 10^{-3}} (235 + 20) - (235 + 25) \\ &= 7.75^{\circ}\text{C} \end{aligned}$$

Therefore, the current temperature t_R of the resistive body can be calculated as follows:

$$t_R = t_2 + \Delta t = 25 + 7.75 = 32.75$$

For a measurement target that is not copper or aluminum with a temperature coefficient of α_{t_0} , the constant k can be calculated using the formula shown for the temperature correction function and the above formula, as follows:

$$k = \frac{1}{\alpha_{t_0}} - t_0$$

For example, the temperature coefficient of copper at 20°C is 3930 ppm/ $^{\circ}\text{C}$, so the constant k in this case is as follows, which shows almost the same value as the constant for copper 235 defined by the IEC standard.

$$k = \frac{1}{3930 \times 10^{-6}} - 20 = 234.5$$

Appx. 6 Effect of Thermoelectromotive Force (Thermal EMF)

Thermoelectromotive force (thermal EMF) is the potential difference that occurs at the junction of two dissimilar metals, including between the probe tips and the lead wire of the measurement target. If the difference is sufficiently large, it can cause erroneous measurements. (Fig. 1)

The amplitude of thermal EMF depends on the temperature of the measurement environment, with the force generally being greater at higher temperature.

Increasing thermal EMF examples

- The measurement target is a fuse, thermal fuse, thermistor, bimetal, or thermostat.
- The voltage detection lines use a single stable relay as a contact.
- An alligator clip is used as a voltage detection terminal.
- A voltage detection terminal is held by hand.
- There is a large temperature difference between the measurement target and the instrument.
- Wire materials differ between terminal A and terminal B sides

In a resistance measurement, measurement current I_M is applied to measurement target R_x to detect voltage drop $R_x I_M$ across the target. In a low resistance measurement, the voltage $R_x I_M$ to be detected is naturally lower due to the low R_x . When the detected voltage is low, the measurement will be affected by thermal EMF that is generated between the measurement target and probes, and between the cables and the instrument, as well as the voltmeter offset voltage V_{EMF} . (Fig. 2)

If a measurement target is held by hand, the target will be warmed. A probe will also be warmed by holding it by hand. For these reasons, even if every care is taken, it will be difficult to control thermal EMF so that it does not exceed 1 μV .

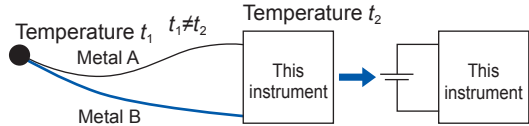

Fig. 1 Thermal EMF generation

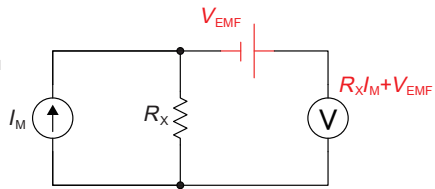

Fig. 2 Thermal EMF generation

As an example, if a measurement target with an actual resistance of $1\text{m}\Omega$ is measured with a measurement current of 100 mA in an environment with a thermal EMF of $10\ \mu\text{V}$, the instrument will indicate the following measured value. This is a significant error of 10% higher than the actual resistance.

$$\frac{1\text{m}\Omega \times 100\text{mA} + 10\ \mu\text{V}}{100\text{mA}} = 1.1\text{m}\Omega$$

The voltmeter offset voltage will also be very large, ranging between $1\ \mu\text{V}$ and $10\ \text{mV}$. This will cause a large low resistance measurement error.

To reduce the effects of thermal EMF, the following actions are possible:

1. Increasing the detection voltage by increasing the measurement current
2. Using zero adjustment to cancel thermal EMF
3. Changing the detection signal to AC

1 Increasing the detection voltage by increasing the measurement current

In the above thermal EMF example, assume that the measurement current is increased from $100\ \text{mA}$ to $1\ \text{A}$. The error will be reduced to 1%.

$$\frac{1\text{m}\Omega \times 1\text{A} + 10\ \mu\text{V}}{1\text{A}} = 1.01\text{m}\Omega$$

However, it is important to note that $R I^2$ power is applied.

2 Using zero adjustment to cancel thermal EMF

If current is blocked from being applied to measurement target R_x , the voltmeter will only be supplied with thermal EMF V_{EMF} . However, if the SOURCE terminals are made open-circuit, a current fault will be detected and a measured value will not be displayed.

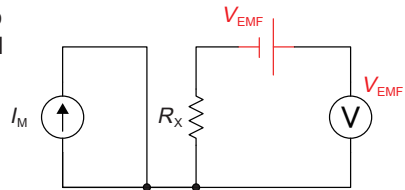

Fig. 3 Using zero adjustment to block current flow to R_x

Thus, thermal EMF can be canceled by shorting the SOURCE lines to block current flow to R_x and performing zero adjustment. (Fig. 3)

“3.3 Reading the Measured Value” (p. 39)

“Appx. 7 Zero Adjustment” (p. Appx.11)

3 Changing the detection signal to AC

Changing the detection signal to AC is a fundamental solution. Both the thermal EMF and voltmeter offset voltage can be treated as stable DC voltages as they are viewed for a short period of time in seconds. This allows frequency domain separation by changing the detection signal to AC. The Offset Voltage Compensation (OVC) function uses a pulse wave as a measurement current to eliminate thermal EMF (Fig. 4). Specifically, a resistance value that is not affected by thermal EMF is obtained by subtracting the voltage detected when the current is stopped from that detected when the measurement current is applied.

$$\frac{(R_x I_M + V_{EMF}) - (R_x I_0 + V_{EMF})}{I_M} = R_x \quad (I_0 = 0: \text{current stopped})$$

When the measurement target is inductive, it is necessary to set the delay (DELAY) between the current application and measurement. (p. 53)
 Set the delay so that the inductance does not affect the measurement result. Start with a longer delay time, and decrease the time gradually, watching the measured value.

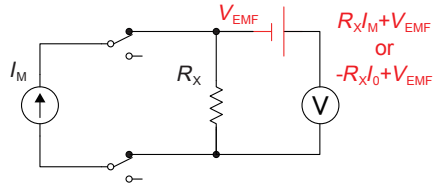

Fig. 4 EMF cancellation by current reversal

Appx. 7 Zero Adjustment

Zero adjustment is a function which adjusts the zero point by deducting the residual value obtained during 0Ω measurement. For this reason, zero adjustment must be performed when connection is made to 0Ω . However, connecting a sample with no resistance is difficult and therefore is not practical. In this respect, when performing the actual zero adjustment, create a pseudo connection to 0Ω and then adjust the zero point.

To create 0Ω connection state

If an ideal 0Ω connection is made, the voltage between SENSE A and SENSE B becomes 0 V according to the Ohm's law of $E = I \times R$. In other words, if you set the voltage between SENSE A and SENSE B to 0 V , this gives you the same state as a 0Ω connection.

To perform zero adjustment using the instrument

The instrument uses a measurement fault detection function to monitor the state of connection between the measurement terminals.

For this reason, when performing zero adjustment, you need to make connections between the terminals appropriately in advance. (Fig. 1)

First, short between SENSE A and SENSE B to set the voltage between them to 0 V . If lead resistances R_{SEA} and R_{SEB} of the cable are less than a few Ω , there will be no problem. As the SENSE terminals are voltage measurement terminals, almost no current I_0 flows. Therefore, in the $E = I_0 \times (R_{\text{SEA}} + R_{\text{SEB}})$ formula, $I_0 \approx 0$ is achieved; if lead resistances R_{SEA} and R_{SEB} are less than a few Ω , the voltage between SENSE A and SENSE B will become almost zero.

Next, make a connection between SOURCE A and SOURCE B. This is to avoid the display of errors when no measurement current flows. Lead resistances R_{SOA} and R_{SOB} of the cable must be less than the resistance for the flowing measurement current.

Furthermore, if you also monitor the connection between SENSE and SOURCE, you need to make connection between SENSE and SOURCE. If lead resistance R_{Short} of the cable has only a few Ω , there will be no problem.

If you perform wiring in the way described above, measurement current I flowing out from SOURCE B will go to SOURCE A but not to the lead of SENSE A or SENSE B. This enables the voltage between SENSE A and SENSE B to be kept accurately at 0 V , and appropriate zero adjustment becomes possible.

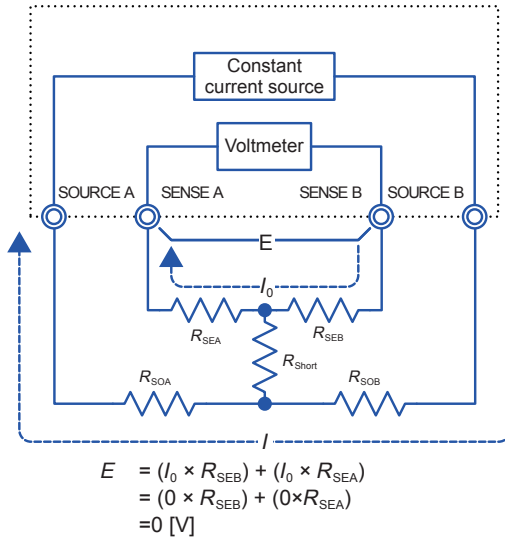

Fig. 1 Pseudo connection to 0Ω

To perform zero adjustment appropriately

Table 1 shows the correct and wrong connections. The resistances in the figure indicate lead resistances; there will be no problem if they are less than a few Ω respectively.

In (a), if you connect SENSE A and SENSE B as well as SOURCE A and SOURCE B respectively, and use one path to make a connection between SENSE and SOURCE, no potential difference occurs between SENSE A and SENSE B, and 0 V is input. This enables zero adjustment to be carried out correctly.

In (b), on the other hand, if you connect SENSE A and SOURCE A as well as SENSE B and SOURCE B respectively, and use one path to make a connection between A and B, $I \times R_{Short}$ voltage occurs between SENSE A and SENSE B. For this reason, the pseudo 0Ω connection state cannot be achieved and zero adjustment cannot be carried out correctly.

Table 1: Connection methods

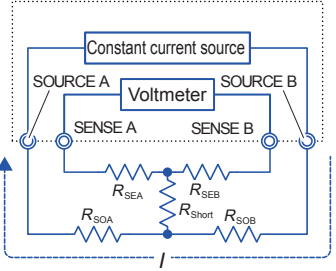
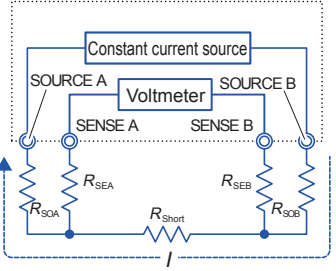
| Connection methods |  <p>(a) Use one point each between SENSE and SOURCE for connection</p> |  <p>(b) Use one point each between A and B for connection</p> |
|---|---|--|
| Resistance between SENSE A and SENSE B | $R_{SEA} + R_{SEB}$ | $R_{SEA} + R_{Short} + R_{SEB}$ |
| Measurement current I 's flow path | $R_{SOB} \rightarrow R_{SOA}$ | $R_{SOB} \rightarrow R_{Short} \rightarrow R_{SOA}$ |
| Voltage occurring between SENSE A and SENSE B | 0 | $I \times R_{Short}$ |
| As connection method for zero adjustment | Correct | Wrong |

To perform zero adjustment using a test lead

When you actually perform zero adjustment using a test lead, you may unexpectedly make the connection shown in Table 1 (b). Therefore, when performing zero adjustment, you need to pay sufficient attention to the connection state of each terminal.

Here, a L2107 Clip Type Lead is used as an example for the connection explanation. Table 2 shows the connection state of the tip of the lead and equivalent circuit in the respective correct and wrong connections. Table 1 (a) indicates the correct connection method, resulting in 0 V between SENSE A and SENSE B. However, Table 1 (b) shows the wrong connection method, resulting in 0 V not being obtained between SENSE A and SENSE B.

Table 2: Clip type lead connection methods used during zero adjustment

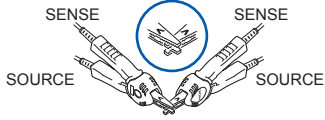
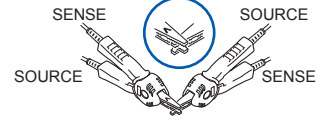
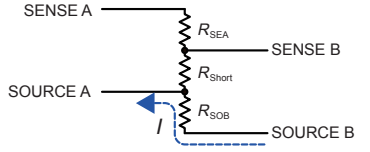
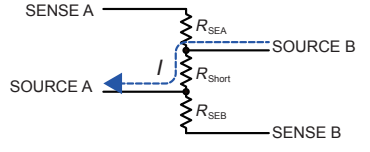
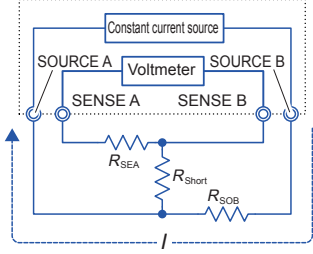
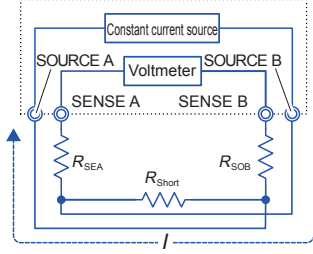
| Connection method | Correct | Wrong |
|--|---|--|
| Tip of lead |  |  |
| Equivalent circuit |  |  |
| Deformed equivalent circuit |  |  |
| As connection method for zero adjustment | Correct | Wrong |

To perform zero adjustment using 9454 Zero Adjustment Board

When performing zero adjustment, you cannot use a metal board or similar object to replace 9454 Zero Adjustment Board.

9454 Zero Adjustment Board is not just a metal board. Its structure consists of two layers of metal boards screwed at one point. The zero adjustment board is used when performing zero adjustment of a 9465-10 Pin Type Lead.

Table 3 shows cross sectional diagrams and equivalent circuits of the two connection methods: connecting a Pin Type Lead to the zero adjustment board, and connecting that to a metal board or similar object. Table 1 (a) (p. Appx.13) indicates the connection using the zero adjustment board, resulting in 0 V between SENSE A and SENSE B. However, Table 1 (b) (p. Appx.13) shows the connection using a metal board or similar object, resulting in 0 V not being obtained between SENSE A and SENSE B.

Table 3: Pin type lead connection methods in zero adjustment

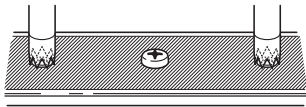
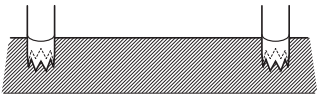
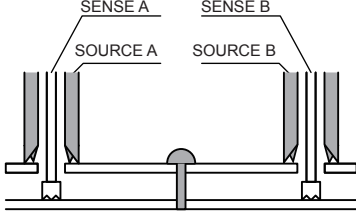
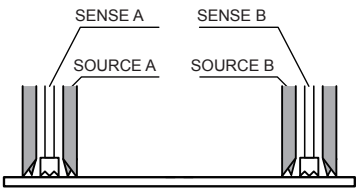
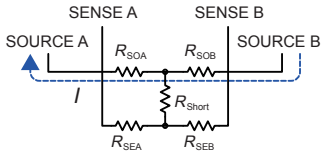
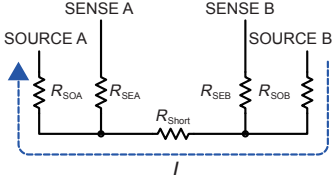
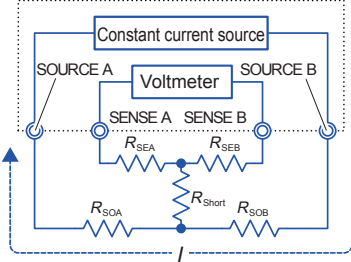
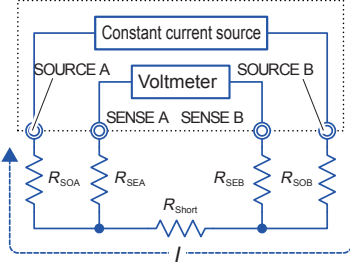
| | | |
|--|---|--|
| Connection method |  <p>If connection is made using 9454 Zero Adjustment Board</p> |  <p>If connection is made using metal board or similar object</p> |
| Tip of lead |  |  |
| Equivalent circuit |  |  |
| Deformed equivalent circuit |  |  |
| As connection method for zero adjustment | Correct | Wrong |

If zero adjustment is difficult when using a client-made test lead to perform measurement

When you perform zero adjustment using a client-made test lead to do measurement, connect the tip of the client-made test lead as shown in Table 1 (a). (p. Appx.13) However, if such a connection is difficult, you can try the following methods.

When DC resistance meter is used

The main purpose of performing zero adjustment is to remove the offset of the measurement instrument. For this reason, the value to be deducted as a result of zero adjustment almost does not depend on the test lead. Therefore, after using the standard test lead to make the connection shown in Table 1 (a) (p. Appx.13) and performing zero adjustment, you can replace it with a client-made test lead to perform measurement with the offset removed from the measurement instrument.

For an AC resistance meter (such as the HIOKI 3561, BT3562, or BT3563)

In addition to removing the offset of the measurement instrument, the other main purpose of performing zero adjustment is to remove the influence of the test lead shape. For this reason, when performing zero adjustment, try as much as possible to position the client-made test lead shape close to the measurement state. Then, you need to make the connection as shown in Table 1 (a) (p. Appx.13) and perform zero adjustment.

However, in AC resistance measurement with a HIOKI instrument, if the required resolution exceeds $100\mu\Omega$, the same zero adjustment method used in DC resistance meter may be sufficient.

Appx. 8 Unstable Measurement Values

If the measurement value is unstable, verify the following.

1 Effects of induced noise

A large amount of noise is generated by power cables, fluorescents, electromagnetic valves, computer displays, etc. Noise sources that will affect resistance measurement are as follows:

1. Electrostatic coupling from a high voltage line
2. Electromagnetic coupling from a high current line

For these types of noise, shielding or cable twisting helps to reduce the noise.

Electrostatic coupling from a high voltage line

Current flowing in from a high voltage line is influenced by the electrostatic capacitance coupled with it. As an example, if a 100 V commercial power supply line and resistance measurement lines are electrostatically coupled with a capacitance of 1 pF, a current of approx. 38 nA current will be induced.

$$I = \frac{V}{Z} = 2\pi \cdot 60 \cdot 1\text{pF} \cdot 100\text{V}_{\text{RMS}} = 38\text{nA}_{\text{RMS}}$$

When a 1Ω resistor is measured at 100 mA, the effect will only be 0.4 ppm and may be negligible.

However, if a 1MΩ is measured with 0.5 μA, the influence will be 8%. This shows that, when carrying out high resistance measurement, more attention should be given to electrostatic coupling from a high voltage line. Protecting the lines and measurement target with electrostatic shields will help. (Fig. 1)

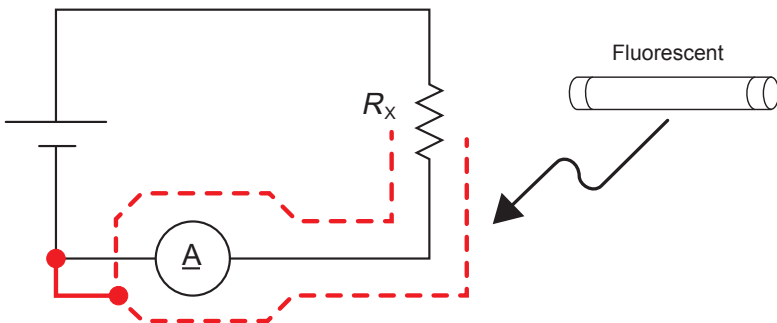

Fig. 1 Using electrostatic shields near a high voltage line

Electromagnetic coupling from a high current line

A magnetic field is generated by a high current line. A larger magnetic field is generated by transformers and choke coils with a large number of turns. Voltage induced by a magnetic field is influenced by distance and area. A voltage of 0.75 μV is generated on a 10 cm^2 loop that is 10 cm away from a 1 A commercial power supply line.

$$v = \frac{d\phi}{dt} = \frac{d}{dt} \left(\frac{\mu_0 I S}{2\pi r} \right) = \frac{4\pi \cdot 10^{-7} f I}{r}$$

$$= \frac{4\pi \cdot 10^{-7} \cdot 60\text{Hz} \cdot 0.001\text{m}^2 \cdot 1\text{A}_{\text{RMS}}}{0.1\text{m}} = 0.75 \mu\text{V}_{\text{RMS}}$$

When a 1m Ω resistance meter is measured with 1 A, the influence will be 0.07%. In higher resistance measurement, the detection voltage can be increased easily and the influence is negligible.

The influence of electromagnetic coupling can be reduced by keeping the noise generating line away from the voltage detection line and twisting the cables for each. (Fig. 2)

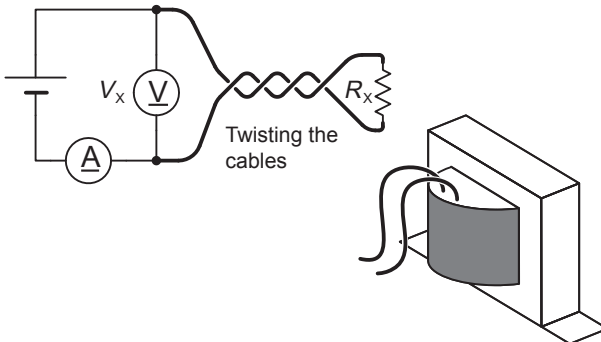

Fig. 2 Twisting cables near a high current line

Induced noise reduction for the instrument

In general, twist the four shielded cables and then connect the measurement target with the shield to the SOURCE B terminal as shown in Fig. 3. Fig. 3 shows a wiring example for leads whose structure is different from the included L2107 Clip Type Leads; however, it does not affect measurement.

In addition to the instrument, it is important to reduce noise from any noise sources in a similar way. Twisting a high current line around the instrument that may be a noise source and shielding a high voltage line will be more effective.

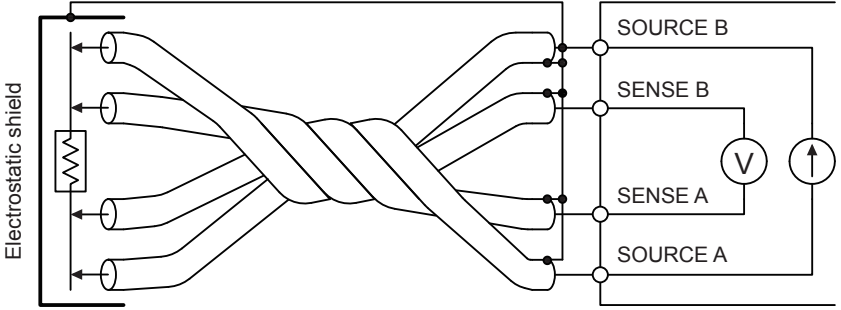

Fig. 3 Noise reduction for the instrument

When a commercial power supply is a source of induced noise

Induced noise caused by a commercial power supply can be generated by fluorescents and electrical appliances, as well as commercial power supply lines or power outlets. Noise caused by a commercial power supply depends on the power supply frequency, and it is generated at a frequency of 50 Hz or 60 Hz.

To reduce the effects of noise, the instrument uses an integration time consisting of an integral multiple of 50 Hz (20 ms) / 60 Hz (16.6 ms). (Fig. 4) For an environment with noise from other frequency components, take appropriate noise reduction measures and use the averaging function.

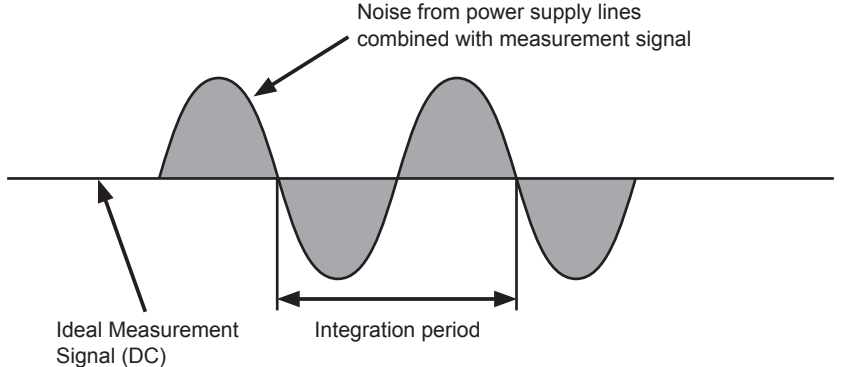

Fig. 4 Noise from a commercial power supply

2 Multi-point contacts with clip leads

The ideal conditions for four-terminal measurements are shown in Fig. 5: current flows from the far probe and voltage is detected with uniform current distribution.

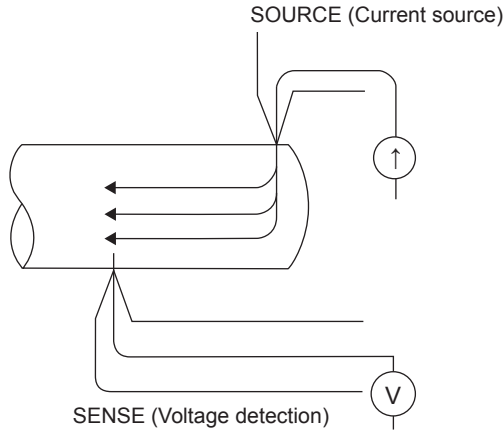

Fig. 5 Ideal four-terminal method

To facilitate measurement, the tips of the L2107 4-Terminal Probe are jagged. When a clip is engaged as shown in Fig. 6, measurement current flows from multiple points, and voltage is detected at multiple points. In such cases, the measurement value varies according to the total contact area.

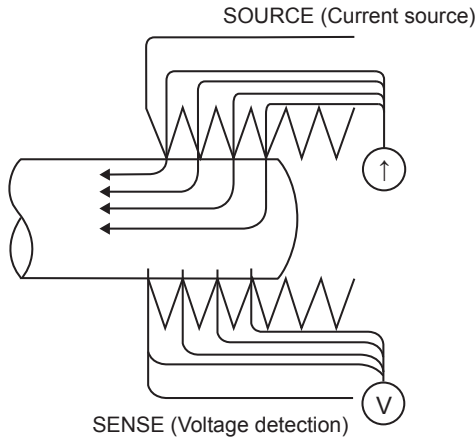

Fig. 6 Measurement with the L2107 4-Terminal Probe

Additionally, as shown in Fig. 7, when measuring the resistance of a 100 mm length of wire, the length between the nearest edges of the clips is 100 mm, but the length between the farthest edges of the clips is 110 mm. This means the actual measurement length (and value) has an uncertainty of 10 mm (10%). If measured values are unstable for this reason, measure with point contacts as much as possible.

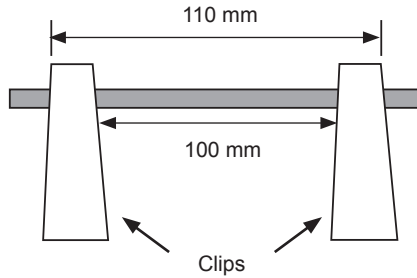

Fig. 7 Measuring resistance of an approx. 100 mm lead wire

3 Wider/Thicker measurement targets

If the measurement target has a certain width or thickness like boards or blocks, it will be difficult to measure accurately using clip type leads or pin type leads. By using such measurement probes, there may be a fluctuation of several percent to several tens of percent of the measured value due to contact pressure or contact angle. For example, when measuring a $W300 \times L370 \times t0.4$ mm metal board, the measured values are fairly different, even if measuring the same points, as shown below:

0.2 mm pitch pin type lead: 1.1m Ω
 0.5 mm pitch pin type lead: 0.92 to 0.97m Ω
 L2107 Clip Type Lead: 0.85 to 0.95m Ω

This does not depend on the contact resistance between probes and the measurement target, but on the current distribution on the measurement target.

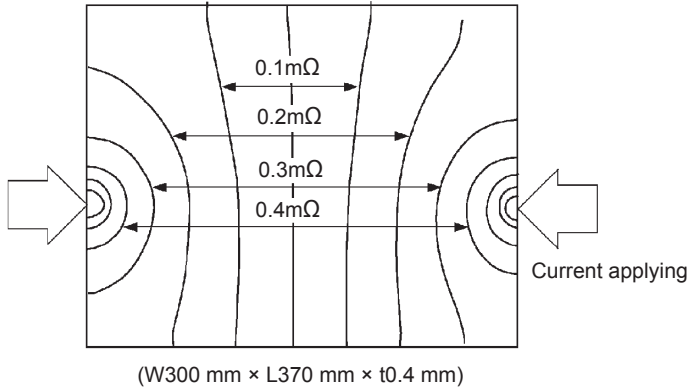

(Applying 1 A current on points on edges and plotting equivalent electric potential lines at each 50 μV level)

Fig. 8 Electric potential lines of a metal board

Fig. 8 shows an example of plotting the equivalent electric potential lines of a metal board. Similar to the relationship between atmospheric pressure distribution and wind on a weather forecast diagram, current density is higher in locations where the equivalent electric potential lines are narrowly spaced, and lower in locations where they are widely spaced. Through this example, it is shown that the electric potential slope is larger around current applying points. This phenomenon is caused by high current density while current expands on the metal board. Due to this phenomenon, measured values should be fairly different, even if the connected position difference is quite slight, when voltage detection terminals (of measurement probes) are placed near current applying points.

To avoid the effects of this phenomenon, it is recommended to detect the voltage inside of current applying points. Generally, when the voltage detection point is further inside the current application point than the measurement target width (W) and thickness (t), current distribution may be considered uniform. As shown in Fig. 9, SENSE terminals should be $3W$ or $3t$ mm or more inside from the SOURCE terminals.

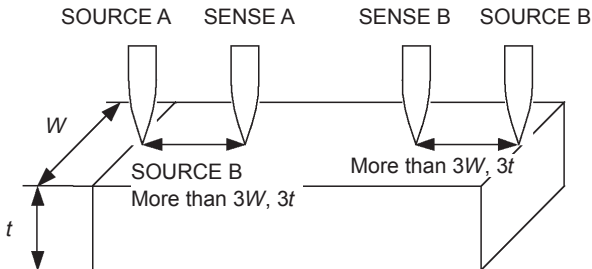

Fig. 9 Probe positions on wider/thicker measurement target

4 Unstable temperature of the measurement target

Copper wire has a temperature coefficient of about $0.4\%/^{\circ}\text{C}$. Just holding a copper wire in the hand raises its temperature, causing its resistance to be increased as well. When the hand is removed from the wire, temperature and resistance decrease. The temperature of recently varnished windings is extremely high, so the resistance tends to be relatively high. If the temperatures of a measurement target and probe are different, the Thermal-EMFs generated can cause a measurement error. To avoid such errors, allow the temperature of the measurement target to stabilize at ambient temperature.

5 Measurement target becomes warm

The maximum applied power to a measurement target by this instrument is determined as shown in the table below.

The resistance of measurement targets with small heat capacity can change due to heating.

| Range [Ω] | 3m | 30m | 300m | | 3 | 30 | 300 | 3k | 30k | 300k | 3M |
|-------------------------|-------|------|--------|-------|------|-------|--------|-------|-------|--------|-------|
| Measurement current [A] | 1 | | 300 m | 100 m | | 10 m | 1 m | | 100 μ | 5 μ | 500 n |
| Maximum power [W] | 3.5 m | 35 m | 31.5 m | 3.5 m | 35 m | 3.5 m | 0.35 m | 3.5 m | 350 μ | 8.75 μ | 875 n |

6 Measuring transformers and motors

If noise enters an unconnected terminal of a transformer or if motor rotor moves, measurements may be unstable due to induced voltage on the measured winding. Pay attention to the treatment of unconnected terminals on transformers and to motor vibration.

7 Measuring large transformers or motors

When measuring high-inductance (high-Q) measurement targets such as large transformers or motors, measured values may be unstable. The instrument performs measurement by constant current flow through the measurement target, but producing constant current becomes impossible as inductance approaches infinity. To obtain stability in a constant-current source with a large inductance, response time is sacrificed. If you find that resistance values are scattered when measuring large transformers or motors, please contact your local HIOKI distributor for further assistance.

8 Non-four-terminal measurements

The four-terminal method requires four probes to be connected to the measurement target. By measuring as shown in Fig. 10, the measured resistance includes that of the contacts between the probes and measurement target.

Typical contact resistance is several $m\Omega$ with gold plating, and several tens of $m\Omega$ with nickel plating.

With measurement values of several $k\Omega$ this would not seem to be a problem, but if a probe tip is oxidized or dirty, contact resistance on the order of a $k\Omega$ is not unusual. To maximize the opportunity for proper measurements, emulate the four-terminal method as closely as possible to the contact points of the measurement target. (Fig. 11)

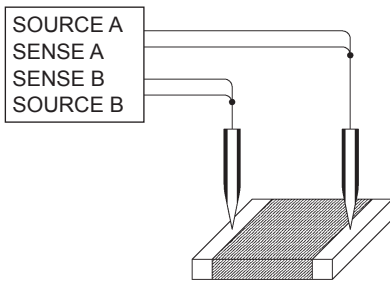

Fig. 10 Two-terminal measurement

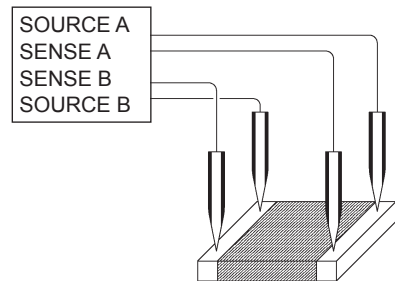

Fig. 11 Four-terminal measurement

9 Measuring a current sensing resistor (Shunt resistor)

When mounting a two-terminal current sensing resistor on a printed circuit board, it is typical to separate the current line and voltage detection line as shown in Fig. 12 in order to avoid the effects of wiring resistance. To ensure that the current will flow uniformly, it is necessary to use current lines that are the same width as the electrodes and to prevent bending of any tracks in the vicinity of the electrodes (Fig. 13). To test such a current sensing resistor, wire probes are typically used (Fig. 14). In this case, the measurement current gradually spreads out inside the current sensing resistor from the point of entry (SOURCE B) and then returns to the probe point (SOURCE A) (Fig. 15). When the voltage terminals (SENSE A and B) are placed near the current entry points (SOURCE A and B), where the current density is high, the reading will tend to be greater than the resistance value in the mounted state (Fig. 16).

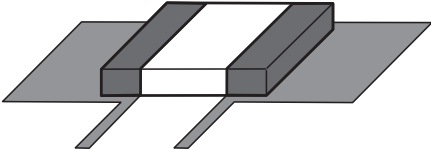

Fig. 12 Current sensing resistor mounted on a PC board

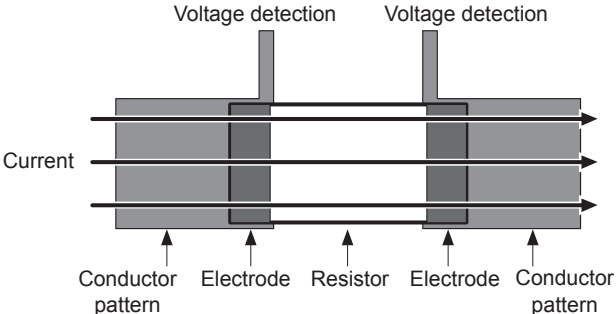

Fig. 13 Current flow in the mounted state

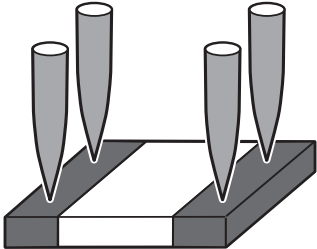

Fig. 14 Probing in the tested state

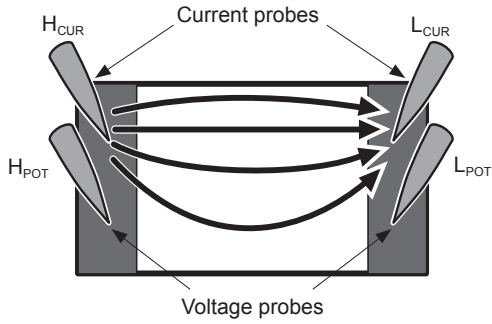

Fig. 15 Current flow in the mounted state

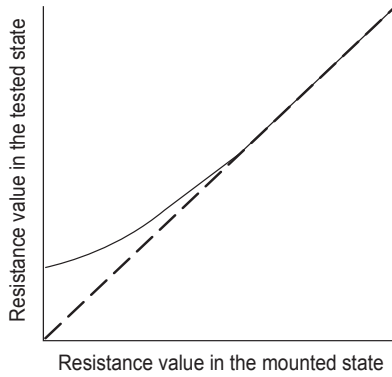

Fig. 16 Difference between the mounted state and tested state

Appx. 9 Locating Short-Circuits on a PC Board

Comparison with resistivity values in multiple areas helps to roughly locate short-circuits on a PC board (with no component mounted on it).

The example below assumes that there is a short-circuit between patterns X and Y.

- 1** Connect **SOURCE A** and **SOURCE B** to each of the patterns.
- 2** Connect **SENSE A** to a point near **SOURCE A**, and connect **SENSE B** to point (1).
- 3** Read the measured values, moving **SENSE B** to (1), to (2), to (3), and then to (4). A higher resistance value indicates that the point is further away from the short-circuit. Move the **SOURCE B** and **SENSE B** terminals to locate the short-circuit.

Example

- (1) $20\text{m}\Omega$
- (2) $11\text{m}\Omega$
- (3) $10\text{m}\Omega$
- (4) $10\text{m}\Omega$

These measured values imply that the short-circuit is near point (3).

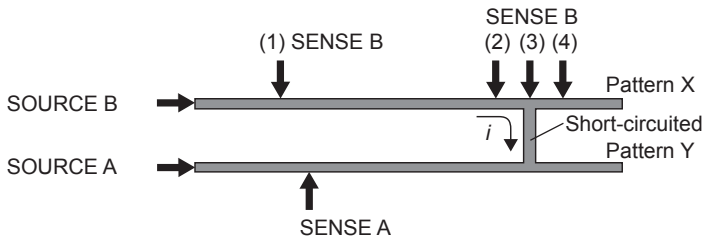

Appx. 10 Test Lead Options

The options listed below are available for the instrument. To order an option, please contact your authorized Hioki distributor or reseller. Options are subject to change. Please check Hioki's website for the latest information.

□ **L2107 Clip Type Lead**

These leads are equipped with a clip shaped edge. Four-terminal measurement can be performed just by clipping the measurement target. Bifurcation-to-probe length: approx. 130 mm Plug-to-bifurcation length: approx. 830 mm Diameter capable of clipping: approx. 0.3 to 5.0 mm

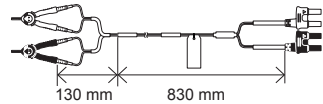

□ **9467 Large Clip Type Lead**

These leads are designed to attach to measurement target with large diameter contacts. Four-terminal measurement can be performed just by clipping the measurement target. Bifurcation-to-probe length: approx. 300 mm Plug-to-bifurcation length: approx. 880 mm Maximum clip diameter: approx. 28 mm

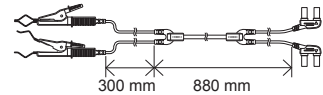

□ **9453 Four-Terminal Lead**

The SOURCE leads of this four-terminal lead set have covered alligator clips, and the SENSE leads have standard test probes. Use it for measuring printed circuit board pattern resistance, and where SOURCE and SENSE leads need to be connected separately. Bifurcation-to-probe length: approx. 280 mm Plug-to-bifurcation length: approx. 910 mm

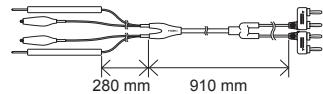

□ **9772 Pin Type Lead**

Measurement can be performed by pressing this lead onto the measurement target. The lead has a shape where the pins are aligned in parallel. As there is a wider gap between each pin compared to 9465-10, the pins are less likely to be influenced by current distribution.

Refer to “3 Wider/Thicker measurement targets” (p. Appx.21).

Bifurcation-to-probe length: approx. 100 mm (red), 550 mm at maximum (black)
 Plug-to-bifurcation length: approx. 1,660 mm
 Initial contact pressure: approx. 60g
 Total compression pressure: approx. 230 g (stroke: 3 mm)

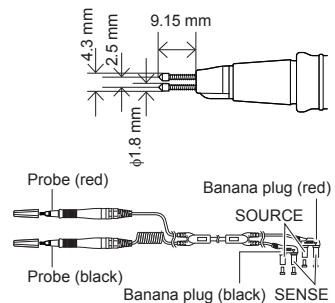

□ **9465-10 Pin Type Lead**

Measurement can be performed by pressing this lead onto the measurement target.

With the co-axial structure, the center is the SENSE terminal, while the outer periphery is the SOURCE terminal.

Bifurcation-to-probe length: approx. 100 mm (red), 550 mm at maximum (black)

Plug-to-bifurcation length: approx. 1,660 mm

Initial contact pressure: approx. 190 g

Total compression pressure: approx. 250 g (stroke: 1 mm)

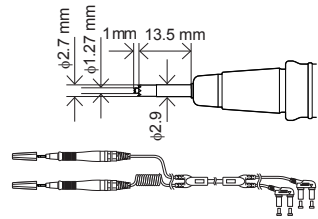

Appx. 11 Calibration

Calibration conditions

- Ambient temperature and humidity: 23°C ± 5°C, 80%RH or less
- External magnetic field: Environment close to the Earth’s magnetic field
- Initialization by reset

Calibration equipment

Please use the following for calibration equipment.

Resistance measurement

| Equipment | Calibration point | Manufacturer | Standard model name |
|-----------------------------|-------------------|-------------------|-------------------------|
| Standard resistor | 1mΩ | Alpha Electronics | CSR-1N0 or equivalent |
| Standard resistor | 10mΩ | Alpha Electronics | CSR-10N or equivalent |
| Standard resistor | 100mΩ | Alpha Electronics | CSR-R10 or equivalent |
| Multi-product calibrator | 3Ω | FLUKE | 5520A or equivalent |
| Multi-product calibrator | 30Ω | FLUKE | 5520A or equivalent |
| Multi-product calibrator | 300Ω | FLUKE | 5520A or equivalent |
| Multi-product calibrator | 3kΩ | FLUKE | 5520A or equivalent |
| Multi-product calibrator | 30kΩ | FLUKE | 5520A or equivalent |
| Multi-product calibrator | 300kΩ | FLUKE | 5520A or equivalent |
| Multi-product calibrator | 3MΩ | FLUKE | 5520A or equivalent |
| Resistance measurement lead | | HIOKI | 9453 Four-Terminal Lead |

If FLUKE 5520A is not available, use the following equipment.

| Equipment | Calibration point | Manufacturer | Standard model name |
|-------------------|-------------------|-------------------|-----------------------|
| Standard resistor | 1 Ω | Alpha Electronics | CSR-1R0 or equivalent |
| Standard resistor | 10 Ω | Alpha Electronics | CSR-100 or equivalent |
| Standard resistor | 100 Ω | Alpha Electronics | CSR-101 or equivalent |
| Standard resistor | 1k Ω | Alpha Electronics | CSR-102 or equivalent |
| Standard resistor | 10k Ω | Alpha Electronics | CSR-103 or equivalent |
| Standard resistor | 100k Ω | Alpha Electronics | CSR-104 or equivalent |
| Standard resistor | 1M Ω | Alpha Electronics | CSR-105 or equivalent |

| Equipment | Calibration point | Manufacturer | Standard model name |
|--------------------|------------------------------|-------------------|-------------------------|
| Dial type resistor | 30 Ω to 300k Ω | Alpha Electronics | ADR-6105M or equivalent |
| Dial type resistor | 3M Ω | Alpha Electronics | ADR-6106M or equivalent |

Temperature measurement (thermistor)

| Equipment | Calibration point | Manufacturer | Standard model name |
|--------------------------|-----------------------|--------------|---------------------|
| Multi-product calibrator | 25°C, 2186.0 Ω | FLUKE | 5520A or equivalent |

If the FLUKE 5520A cannot be used, please use the following equipment.

| Equipment | Calibration point | Manufacturer | Standard model name |
|--------------------|-----------------------|-------------------|-------------------------|
| Dial type resistor | 25°C, 2186.0 Ω | Alpha Electronics | ADR-6105M or equivalent |

Calibration point

| | Range | Calibration point | OVC |
|--------------------------------------|------------------------|---|---------|
| Resistance measurement | 3m Ω | 0 Ω , 1m Ω | ON, OFF |
| | 30m Ω | 0 Ω , 10m Ω | ON, OFF |
| | 300m Ω (300 mA) | 0 Ω , 100m Ω | ON, OFF |
| | 300m Ω (100 mA) | 0 Ω , 100m Ω | ON, OFF |
| | 3 Ω | 0 Ω , 1 Ω or 3 Ω | ON, OFF |
| | 30 Ω | 0 Ω , 10 Ω or 30 Ω | ON, OFF |
| | 300 Ω | 0 Ω , 100 Ω or 300 Ω | ON, OFF |
| | 3k Ω | 0 Ω , 1k Ω or 3k Ω | OFF |
| | 30k Ω | 0 Ω , 10k Ω or 30k Ω | OFF |
| | 300k Ω | 0 Ω , 100k Ω or 300k Ω | OFF |
| | 3M Ω | 0 Ω , 1M Ω or 3M Ω | OFF |
| Temperature measurement (thermistor) | | 2186.0 Ω input at 25°C | |

Connection method

HIOKI RM3548
(3mΩ to 300mΩ range)

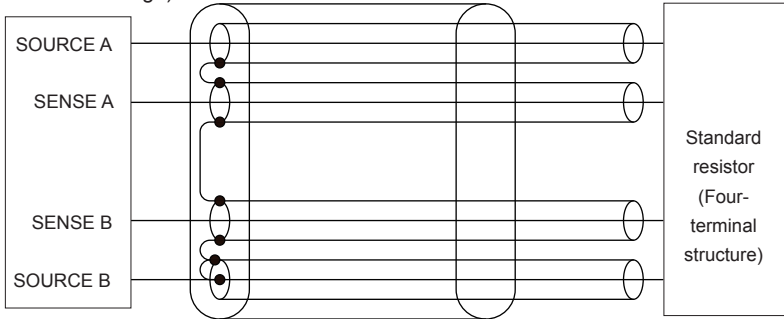

HIOKI 9453 Four Terminal Lead

HIOKI RM3548
(3Ω to 3MΩ range)

FLUKE
5520A

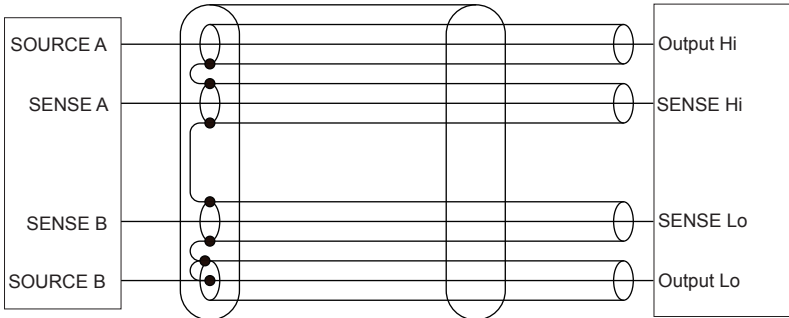

HIOKI 9453 Four Terminal Lead

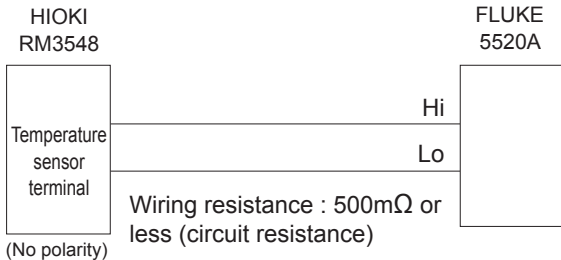

IMPORTANT

- For information on the wiring for 0Ω calibration, see “Appx. 7 Zero Adjustment” (p. Appx.11).
- Before calibration, take appropriate noise reduction measures.
In a highly noisy environment, the measured value may become unstable or inaccurate. In addition, the measurement error detection function may react and no measured value may be displayed.
See: “Unstable Measurement Values” (p. Appx.17)
- Do not use an alligator clip for the voltage detection terminal. The measured value may become inaccurate due to thermal EMF.

When using the YOKOGAWA 2792 for calibration

Use the separately sold 9453 Four Terminal Lead from Hioki.

Note that connection cannot be made with the L2107 Clip Type Lead.

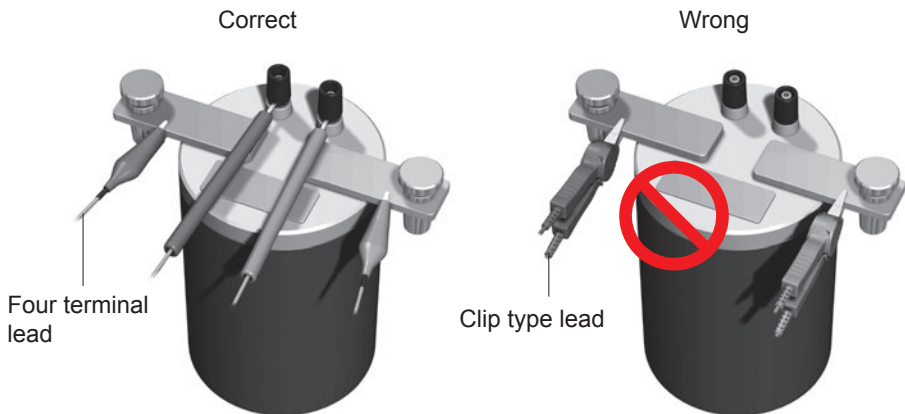

Index

Symbols

| | |
|----|----------------|
| - | 18 |
| ΔT | 24, 67, Appx.7 |
| + | 18 |

Values

| | |
|--------|----------------|
| 0ADJ | 19, 24, 46, 48 |
| 300 mA | 24 |

A

| | |
|-------------------------|--------|
| ABS mode | 61, 63 |
| Absolute value judgment | 61 |
| Accuracy | 96 |
| Resistance measurement | 93 |
| Temperature measurement | 95 |
| AC method | Appx.3 |
| A.HOLD | 24 |
| Allowable range | 64 |
| A.MEMORY | 24 |
| APS | 22 |
| AUTO | 19, 24 |
| Auto-memory | 78 |
| Automobile ground wire | 25 |
| Auto Power Save (APS) | 33 |
| Auto range | 37 |
| Averaging | 49 |
| AVG | 18, 24 |

B

| | |
|----------------|--------|
| Backup battery | 117 |
| Battery | 17, 29 |
| BEEPSET | 18 |
| Block diagram | Appx.1 |
| Blown out | 40 |

C

| | |
|------------------------------|--------------|
| Calibration | 107, Appx.30 |
| Choke coil | 25 |
| Circuit protection detection | 99 |
| Cleaning | 107 |
| Clip Leads | Appx.20 |
| Clock | |
| Setting | 90 |
| COMP | 18, 24 |

| | |
|-----------------------------|---------|
| Comparator | 60 |
| Does not lit | 109 |
| COMP. OUT terminal | 17 |
| Conductive coating material | 25 |
| Conductive rubber | 25 |
| Conductor length | 69 |
| Connector | 25 |
| CSV file | 88 |
| Current fault | 23 |
| Current fault detection | 41, 99 |
| Current sensing resistance | Appx.24 |

D

| | |
|----------------------|--------|
| DATA | 24 |
| DATE | 18 |
| Date and time | 89 |
| DC method | Appx.3 |
| Default settings | 92 |
| Delay | 18, 53 |
| Delay time guideline | 54 |
| Disposal | 117 |

E

| | |
|--------------------------|---------|
| ELAPSED | 24 |
| Electromagnetic coupling | Appx.18 |
| Electrostatic coupling | Appx.17 |
| ENTER | 18 |
| ESC | 18 |

F

| | |
|----------------------------|-----------------|
| Four-Terminal Measurements | Appx.24 |
| Four-Terminal Method | Appx.2 |
| Fuse | 17, 23, 25, 116 |

G

| | |
|--------------------------------|----|
| General resistance measurement | 25 |
|--------------------------------|----|

H

| | |
|---------|------------|
| Heater | 25 |
| Hi | 24, 56, 60 |
| HOLD | 24 |
| Holding | 42 |

I

| | |
|----|--------|
| IN | 24, 60 |
|----|--------|

Initialization..... 91
 Inspection 34
 Interval
 Interval measurement 23, 26
 Interval memory 79

J

Judgment..... 60
 Judgment methods 60
 Judgment sound 65

L

L2107 Clip Type Lead.....
 2, 3, 30, 38, 44, 45,
 105, 106, Appx.13, Appx.19,
 Appx.20, Appx.21, Appx.28, Appx.33
 LENGTH 18, 24
 Length conversion 23, 69
 Lo 24, 56, 60
 Lower limit 22

M

Manual memory 77
 Manual range 36
 M.BLOCK SEL 18
 Measured value
 Failure to display 112
 Failure to stabilize 111, Appx.17
 Holding 42
 Judging 60
 Memorizing 42
 Reading 39
 Saving 78
 Stabilizing 49
 Measurement conditions 43, 71
 Loading 73
 Saving 72
 Measurement current 25, 55
 Measurement data
 Clearing 82
 Measurement error 40
 Measurement range 36, 93
 Measurement screen 22
 Measurement target 25, Appx.21
 Becomes warm Appx.23
 Temperature does not stabilize Appx.23
 Memory 19, 75

Memory blocks 76
 Memory clear 19, 82, 91
 Memory display 81
 MODE 19
 Motor 25, Appx.23

N

Noise Appx.17, Appx.19
 No key operations are possible 108

O

Offset voltage compensation function 51
 Operation key 18
 Out-of-range 23, 40
 Out-of-range detection function 41, 99
 OVC 18, 24, 25, 51

P

Panel
 Clearing contents 74
 PANEL 18
 Panel load 73
 Panel save 72
 PC 86
 PC board Appx.27
 PERIOD 24
 Power 32
 Power contact 25
 Protection function 23

Q

Q&A 108

R

RANGE 19, 24
 READ 19
 REF 24
 Reference value 64
 REF% mode 61, 64
 Relative value judgment 61
 Relay contact 25
 Remaining battery 22
 Reset 91
 Resistor 25

S

| | |
|-----------------------|---------|
| SAVE/CLEAR | 18 |
| Screen layout..... | 22 |
| Self-test | 32 |
| Shunt resistance..... | Appx.24 |
| Signal contact..... | 25 |
| Solenoid..... | 25 |
| START/STOP | 19 |
| Strap..... | 28 |
| Switch..... | 25 |
| System..... | 89 |

T

| | |
|--|------------------------|
| TC..... | 24, Appx.4 |
| TC/ Δ T | 18 |
| Temperature coefficient for temperature correction..... | 24 |
| Temperature conversion.... | 23, 25, 67, Appx.7 |
| Temperature correction..... | 25, 50, Appx.4 |
| Temperature rise test..... | 25, 67 |
| TEMP.SENSOR terminal | 17 |
| Test leads | 9, 11, 30, 38, Appx.28 |
| Connecting..... | 30, 38 |
| Thermal EMF..... | 51, Appx.8 |
| Transformer | 25, Appx.23 |

U

| | |
|------------------------------------|----|
| UPP | 24 |
| Upper and lower limit values | 63 |
| Upper limit | 22 |
| USB mass storage..... | 86 |
| USB terminal | 17 |

V

| | |
|--------------------|--------|
| VIEW | 18, 22 |
| Voltage-drop | Appx.2 |

W

| | |
|---------------------|----|
| Welding..... | 25 |
| Wiring harness..... | 25 |

Z

| | |
|----------------------|-------------|
| Zero adjustment..... | 44, Appx.11 |
| Clearing | 48 |
| Performing | 45 |

Warranty Certificate

HIOKI

| | | |
|-------|---------------|--|
| Model | Serial number | Warranty period Three (3) years from date of purchase (___ / ___) |
|-------|---------------|--|

Customer name: _____
Customer address: _____

Important

- Please retain this warranty certificate. Duplicates cannot be reissued.
- Complete the certificate with the model number, serial number, and date of purchase, along with your name and address. The personal information you provide on this form will only be used to provide repair service and information about Hioki products and services.

This document certifies that the product has been inspected and verified to conform to Hioki's standards. Please contact the place of purchase in the event of a malfunction and provide this document, in which case Hioki will repair or replace the product subject to the warranty terms described below.

Warranty terms

1. The product is guaranteed to operate properly during the warranty period (three [3] years from the date of purchase).
If the date of purchase is unknown, the warranty period is defined as three (3) years from the date (month and year) of manufacture (as indicated by the first four digits of the serial number in YYMM format).
2. If the product came with an AC adapter, the adapter is warranted for one (1) year from the date of purchase.
3. The accuracy of measured values and other data generated by the product is guaranteed as described in the product specifications.
4. In the event that the product or AC adapter malfunctions during its respective warranty period due to a defect of workmanship or materials, Hioki will repair or replace the product or AC adapter free of charge.
5. The following malfunctions and issues are not covered by the warranty and as such are not subject to free repair or replacement:
 - 1. Malfunctions or damage of consumables, parts with a defined service life, etc.
 - 2. Malfunctions or damage of connectors, cables, etc.
 - 3. Malfunctions or damage caused by shipment, dropping, relocation, etc., after purchase of the product
 - 4. Malfunctions or damage caused by inappropriate handling that violates information found in the instruction manual or on precautionary labeling on the product itself
 - 5. Malfunctions or damage caused by a failure to perform maintenance or inspections as required by law or recommended in the instruction manual
 - 6. Malfunctions or damage caused by fire, storms or flooding, earthquakes, lightning, power anomalies (involving voltage, frequency, etc.), war or unrest, contamination with radiation, or other acts of God
 - 7. Damage that is limited to the product's appearance (cosmetic blemishes, deformation of enclosure shape, fading of color, etc.)
 - 8. Other malfunctions or damage for which Hioki is not responsible
6. The warranty will be considered invalidated in the following circumstances, in which case Hioki will be unable to perform service such as repair or calibration:
 - 1. If the product has been repaired or modified by a company, entity, or individual other than Hioki
 - 2. If the product has been embedded in another piece of equipment for use in a special application (aerospace, nuclear power, medical use, vehicle control, etc.) without Hioki's having received prior notice
7. If you experience a loss caused by use of the product and Hioki determines that it is responsible for the underlying issue, Hioki will provide compensation in an amount not to exceed the purchase price, with the following exceptions:
 - 1. Secondary damage arising from damage to a measured device or component that was caused by use of the product
 - 2. Damage arising from measurement results provided by the product
 - 3. Damage to a device other than the product that was sustained when connecting the device to the product (including via network connections)
8. Hioki reserves the right to decline to perform repair, calibration, or other service for products for which a certain amount of time has passed since their manufacture, products whose parts have been discontinued, and products that cannot be repaired due to unforeseen circumstances.

HIOKI E.E. CORPORATION

18-07 EN-3

Test Equipment Depot - 800.517.8431 - TestEquipmentDepot.com

HIOKI

1906 EN

Edited and published by HIOKI E.E. CORPORATION

Printed in Japan

- CE declarations of conformity can be downloaded from our website.
- Contents subject to change without notice.
- This document contains copyrighted content.
- It is prohibited to copy, reproduce, or modify the content of this document without permission.
- Company names, product names, etc. mentioned in this document are trademarks or registered trademarks of their respective companies.