



RXW Davis 0.01" or 0.2 mm Rain Gauge Sensor

Models:

- RXW-RGE-900 and RXW-RGF-900 (US)
- RXW-RGE-868 and RXW-RGF-868 (Europe)
- RXW-RGE-922 and RXW-RGF-922 (Australia/NZ)

Included Items:

- Cable ties
- Screws

Required Items:

- Electrical tape or weather-resistant cable ties

If mounting on pole or mast:

- 7/16 inch combination wrench

If mounting on flat surface:

- Drill with 5 mm (3/16 inch) drill bit
- Adjustable wrench

Accessories:

- Guy wire kit (M-GWA)
- 1.5 meter mast (M-MPB)
- Mast level (M-MLA)



This sensor measures rainfall and is designed to work with the HOBONet (HOBONet RX) Wireless Sensor Network in which data is transmitted wirelessly from the sensor mote across the network to the station and then uploaded to HOBOLink® web-based software. With HOBOLink, you can monitor sensor readings, view graphs, set up alarms, download data, and more.

Specifications

Sensor

Measurement Range	0 to 10.2 cm (0 to 4 in.) per hour, maximum 4,000 tips per logging interval
Accuracy	±4.0%, ±1 rainfall count between 0.2 and 50.0 mm (0.01 and 2.0 in.) per hour; ±5.0%, ±1 rainfall count between 50.0 and 100.0 mm (2.0 and 4.0 in.) per hour
Resolution	0.01 in. (RXW-RGE-xxx) or 0.2 mm (RXW-RGF-xxx)
Calibration	Requires annual calibration; can be field calibrated

Wireless Mote

Operating Temperature Range	Mote: -25° to 60°C (-13° to 140°F) with rechargeable batteries -40 to 70°C (-40 to 158°F) with lithium batteries
Radio Power	12.6 mW (+11 dBm) non-adjustable
Transmission Range	Reliable connection to 457.2 m (1,500 ft) line of sight at 1.8 m (6 ft) high Reliable connection to 609.6 m (2,000 ft) line of sight at 3 m (10 ft) high
Wireless Data Standard	IEEE 802.15.4
Radio Operating Frequencies	RXW-RGE-900 and RXW-RGF-900: 904–924 MHz RXW-RGE-868 and RXW-RGF-868: 866.5 MHz RXW-RGE-922 and RXW-RGF-922: 916–924 MHz
Modulation Employed	OQPSK (Offset Quadrature Phase Shift Keying)
Data Rate	Up to 250 kbps, non-adjustable
Duty Cycle	<1%
Maximum Number of Motes	50 motes per one RX Wireless Sensor Network
Battery Type/Power Source	Two AA 1.2V rechargeable NiMH batteries, powered by built-in solar panel or two AA 1.5 V lithium batteries for operating conditions of -40 to 70°C (-40 to 158°F)
Battery Life	With NiMH batteries: Typical 3–5 years when operated in the temperature range -20° to 40°C (-4°F to 104°F) and positioned toward the sun (see <i>Deployment and Mounting</i>), operation outside this range will reduce the battery service life With lithium batteries: 1 year, typical use
Memory	16 MB
Dimensions	Sensor: 16.5 cm opening diameter (6.5 in.) x 24 cm (9.5 in.) high; 214 cm ² (33.2 in. ²) collection area Cable length: 2 m (6.6 ft) Mote: 16.2 x 8.59 x 4.14 cm (6.38 x 3.38 x 1.63 inches)
Weight	Sensor and cable: 1.2 kg (2.7 lbs) Mote: 223 g (7.87 oz)
Materials	Sensor: UV-stabilized ABS plastic housing; tipping bucket mechanism with magnetic reed switch pivots on metal shaft Mote: PCPBT, silicone rubber seal
Environmental Rating	Sensor: Weatherproof Mote: IP67, NEMA 6
Compliance Marks	 RXW-RGE-900 and RXW-RGF-900: See last page  RXW-RGE-868 and RXW-RGF-868: The CE Marking identifies this product as complying with all relevant directives in the European Union (EU).  RXW-RGE-922 and RXW-RGF-922: See last page

Mote Components and Operation

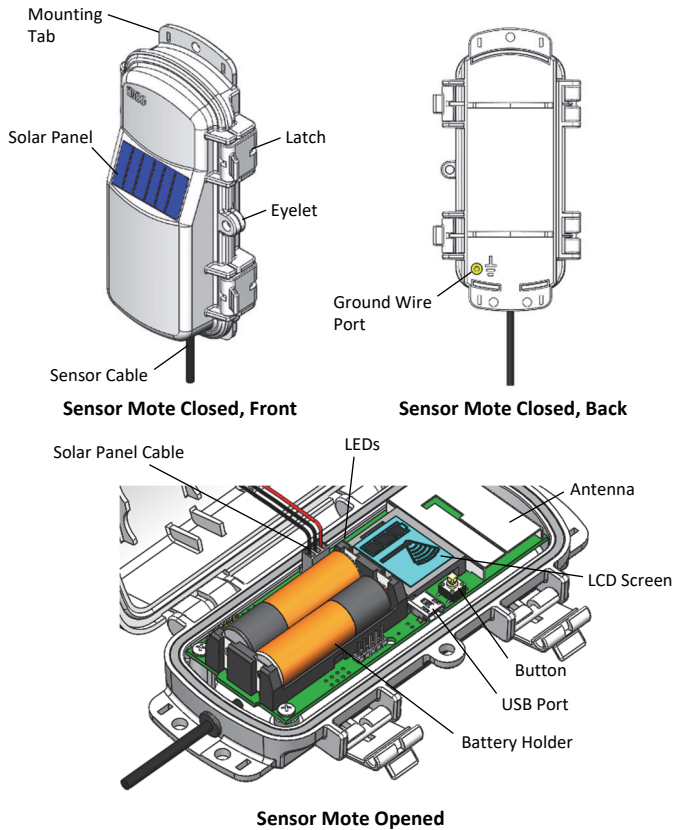

Mounting Tab: Use the tabs at the top and bottom of the mote to mount it (see *Deploying and Mounting*).

Solar Panel: Position the solar panel towards the sun to charge the mote batteries (see *Deploying and Mounting*).

Sensor Cable: This is the cable that connects the mote to the sensor.

Eyelet: Use this eyelet to attach a 3/16 inch padlock to the mote for security.

Latch: Use the two latches to open and close the mote door.

Ground Wire Port: Use this port to connect a ground wire (see *Deploying and Mounting*).

Antenna: This is the built-in antenna for the radio communications across the RX Wireless Sensor Network.

LEDs: There are two LEDs to the left of the LCD screen. The green LED blinks during the process of joining a network, blinking quickly while the mote searches for a network and then slowly as the mote registers with the network. Once the network registration process is complete, the blue LED blinks at 4 seconds to indicate normal operation. If the mote is not currently part of a network, the blue LED will be off. If the blue LED is on and not blinking, there is a problem with the mote. Contact Onset Technical Support.

Solar Panel Cable: This cable connects the built-in solar panel to the mote circuitry.

Battery Holder: The location where the batteries are installed as shown (see *Battery Information*).

USB Port: Use this port to connect to the mote to a computer via USB cable if you need to update the firmware (see *Updating Mote Firmware*).

Button: Push this button for 1 second to illuminate the LCD or 3 seconds for the mote to search for an RX Wireless Sensor Network to join (see *Adding the Mote to the RX Wireless Sensor Network*).

LCD Screen: The mote is equipped with an LCD screen that displays details about the current status. This example shows all symbols illuminated on the LCD screen followed by definitions of each symbol in the table.



LCD Symbol	Description
	The battery indicator shows the approximate battery charge remaining.
	This is a signal strength indicator. The more bars, the stronger the signal between motes. If there is no x icon next to the signal strength indicator, then the mote is part of a HOBOnet Wireless Sensor Network.
	An empty signal strength icon plus the x icon indicates that the mote is not currently part of a network. See <i>Adding the Mote to the HOBOnet Wireless Sensor Network</i> for details on how to add a mote to the network.
	When the mote is in the process of joining a network, the signal strength icon will blink and then the bars in the icon will cycle from left to right. The x icon will blink during the last step in the network registration process (see <i>Adding the Mote to the HOBOnet Wireless Sensor Network</i> for details).

Sensor Components and Operation

Rain enters the collector cone, passes through a debris-filtering screen, and collects in one chamber of the tipping mechanism. The tipping spoon tips when it has collected an amount of water equal to the increment in which the sensor measures (0.2 mm or 0.01 inch). As the spoon tips, it causes a switch closure and brings the second tipping spoon chamber into position. The rain water drains out through the screened drains in the base of the collector.

The sensor includes the components shown on the following diagrams. The sensor includes a hardware kit with the items most commonly needed for installation. The items you use from the kit depend on where you install the sensor. You may need to adapt or purchase additional hardware to fit your individual requirements.

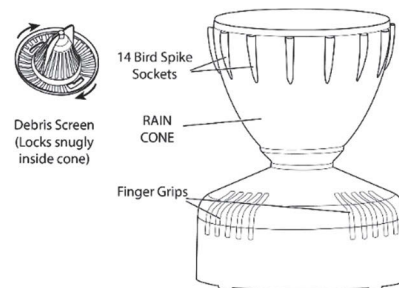

These are the internal components on the base.

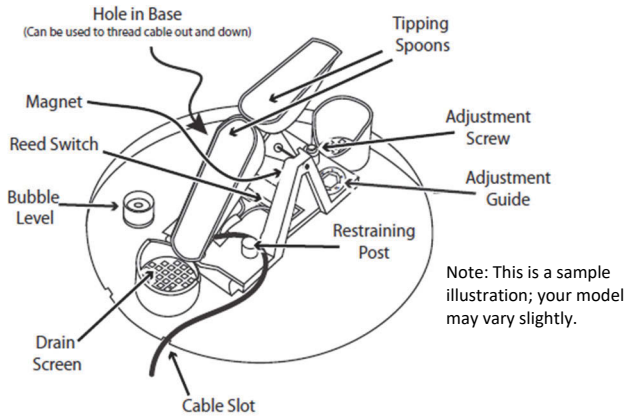

Adding the Mote to the HOBONet Wireless Sensor Network

The mote must join a HOBONet Wireless Sensor Network before it can begin measuring rainfall and transmitting data. This requires accessing the station and the mote at the same time so it is recommended that you complete these steps before deploying the mote.

Important: If you are setting up a new station, follow the instructions in the station quick start before setting up this mote

To add a mote to the network:

1. If the LCD is blank on the station, press any button to wake it up.
2. Press the Select button once (which shows the number of smart sensors installed) and then press it again to switch to the module with the manager (module 2 on RX2105 or RX2106 stations).

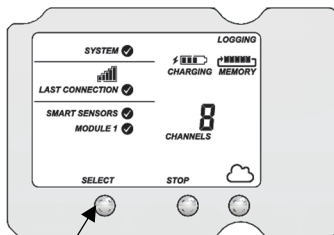

Press this button to view the module

3. Press the Search button (the magnifying glass). The magnifying glass icon will blink while the station is in search mode.

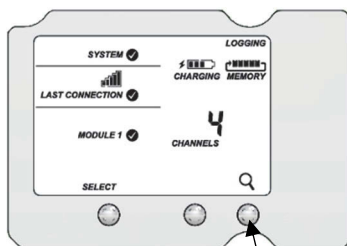

Press this button so the station is ready to have motes join the network

4. Open the mote door and install the batteries if you have not already done so.
5. Press the button on the mote for 3 seconds. The signal strength icon will flash and then cycle.

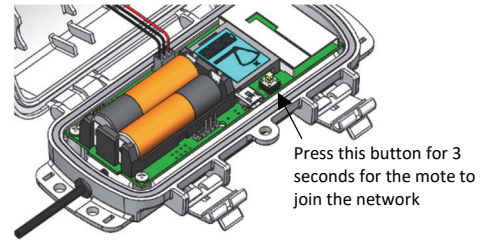

6. Watch the LCD on the mote.



This signal strength icon blinks while searching for a network.



Once a network is found, the icon will stop flashing and the bars will cycle from left to right.



This network connection "x" icon blinks while the mote completes the registration process, which may take up to five minutes.



Once the mote has finished joining the network, the "x" icon is removed and the channel count on the station LCD increases by two (one for rainfall and one for the mote battery).

The green LED blinks quickly while the mote searches for a network to join and then blinks slowly while it completes the network registration. Once the mote has finished joining the network, the green LED turns off and the blue LED then blinks indefinitely while the mote is part of the network.

Note: If the mote cannot find the network or has trouble remaining connected during this process, make sure the mote is in a vertical, upright position and within range of the station.

7. Press the Search button (the magnifying glass) on the station to stop searching for motes.

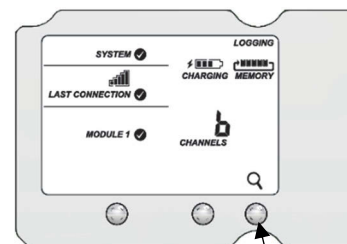

Press this button again to stop searching for motes

If you added more than one more mote to the network, then the total channel count on the station LCD for the manager

module will represent all measurement channels plus a battery channel for each mote in the RX Wireless Sensor Network.

Sensor measurements will be recorded at the logging interval specified in HOBOLink, transmitted to the station, and uploaded to HOBOLink at the next connection interval (readout). Use HOBOLink to monitor mote status and health. If a mote is temporarily offline, any logged data is saved until it is back online. In addition, if a mote is offline for 30 minutes, the station will automatically connect to HOBOLink and report the mote as missing. Once the mote is back online, any logged data will be uploaded the next time the station connects to HOBOLink.

See the HOBOLink Help for details on how to change the logging and connection intervals, view data, check mote status, add the mote to a map, and more.

Deployment and Mounting

Mounting and Positioning the Mote

- Mount the mote to a mast or pipe using cable ties or affix the mote to a wooden post or flat surface with screws. Insert the cable ties or screws through the holes on the mounting tabs.
- Consider using plastic poles such as PVC to mount the mote as certain types of metal could decrease signal strength.
- Make sure the mote remains in a vertical position once it is placed in its deployment location for optimal network communications.
- Make sure the mote door is closed, with both latches fully locked to ensure a watertight seal.
- Consider using a 3/16 inch padlock to restrict access to the mote. With the mote door closed, hook a padlock through the eyelet on the right side of the door and lock it.
- Position the mote towards the sun, making sure the solar panel is oriented so that it receives optimal sunlight throughout each season. It may be necessary to periodically adjust the mote position as the path of the sunlight changes throughout the year or if tree and leaf growth alters the amount of sunlight reaching the solar panel.
- Make sure the mote is mounted a minimum of 1.8 m (6 ft) from the ground or vegetation to help maximize distance and signal strength.
- Place the mote so there is full line of sight with the next mote. If there is an obstruction between two sensor motes or between the sensor mote and the manager, then use a repeater mounted on the obstruction. For example, if there is a hill between the sensor mote and the manager, place a repeater at the top of the hill between the sensor mote and the manager.
- There should not be more than five motes in any direction at their maximum transmission range from the manager. Data logged by a wireless sensor must travel or "hop" across the wireless network from one mote to the next until it ultimately reaches the manager connected to the station. To make sure the data can successfully travel

across the network, the mote should not be more than five hops away from the manager.

- The HOBONet Wireless Sensor Network can support a maximum of 50 motes.
- Use a #4-40 screw to attach a ground wire to the port on the back of the mote if you are deploying the mote in a location where lightning is a concern.

Sensor Mounting Guidelines

Use the following guidelines to determine the best location for installing the sensor.

- You must mount the rain gauge sensor so that it is level. As built-in bubble level is attached to the base to simplify this process.
- Be sure there is an unobstructed path for water runoff from the drain screens.
- The sensor contains a magnet-operated switch that may not operate correctly if you mount the rain gauge on or near any object that is attracted to a magnet.
- Exposure to winds can reduce the measured rainfall amounts. Mount the sensor where there are no obstructions of rainfall at low angles (such as trees, houses, fences) and as low as possible out of the wind.
- If installing the sensor on a sheet metal roof, insulate the unit by making a platform out of wood. Mount the base of the rain gauge at least 4 cm (1 inch) away from any steel or iron surface and make sure the reed switch is at least 4 cm (1 inch) away from any steel or iron objects (e.g. nails).
- For the most accurate rainfall measurements, it is recommended that you mount the sensor upslope, about 3 meters (10 feet) away from the tripod, on a 1.5 meter high mounting pole (M-MPB). Alternatively, you can mount the sensor on the tripod mast.
- Tall objects can interfere with accurate rain measurements. It is recommended that you place the rain bucket away from the obstruction by a distance greater than three times the height of the obstruction. If that is not possible, raise the rain bucket as high as possible to avoid shedding.
- Avoid splashing and puddles. Be sure the gauge is high enough above any surface that rain will not splash into the top of the collector.
- Vibration can significantly degrade accuracy of the tipping bucket mechanism. In windy locations make sure that the bucket will be vibration-free. Consider using guy wires to secure a pole or tower-mounted bucket.

Preparing the Sensor for Mounting

1. Remove the cone from the base by turning over the bucket. Rotate the base counterclockwise until the latches on the

cone line up with the latch openings in the base, then lift the base off the cone.

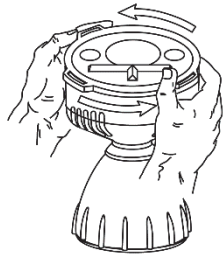

2. If the tipping bucket is secured to the base with a rubber band, remove it to release the bucket assembly.

Mounting the Sensor on a Wooden Post or Flat Surface

1. With a 5 mm (3/16 inch) drill bit, drill two holes approximately 54 mm (2-1/8 inches) apart. Use the metal backing plate as a guide when marking the holes and a carpenter’s level to ensure the holes are level.
2. Insert the 1/4 inch x 3 inch lag screws through the metal backing plate and the holes in the mounting base into the post. Make sure the base is level by checking the built-in bubble level.
3. Tighten the lag screws using an adjustable wrench or 7/16 inch wrench.

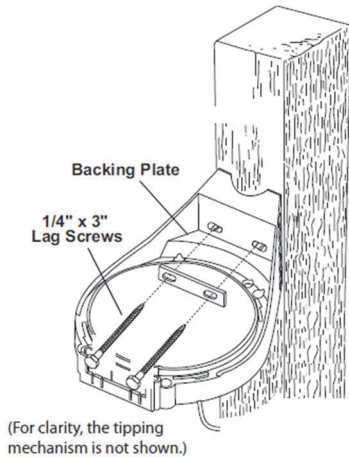

Mounting the Sensor on a Pole or Mast

With the supplied U-bolt, the rain collector can be mounted on a pole having an outside diameter ranging from 32 to 44 mm (1-1/4 to 1-3/4 inch). A larger U-bolt (not supplied) can be used to mount to a pole with a maximum outside diameter of 64 mm (2-1/2 inch).

To mount on a smaller pole, obtain a U-bolt that fits the base openings but has a shorter threaded section. If the included U-bolt is used with a smaller pole, the bolt will interfere with the rain collector cone.

Use the built-in bubble level to ensure the sensor is level.

1. While holding the mounting base against the pole, place the two ends of a U-bolt around the pole and through the two holes in the base.

2. Slide the metal backing plate over the bolt ends as they stick out toward the rain collector cone. Secure the backing plate with a washer, a lock washer, and a hex nut on each of the bolt ends. Adjust the height of the rain collector, then tighten the nuts.

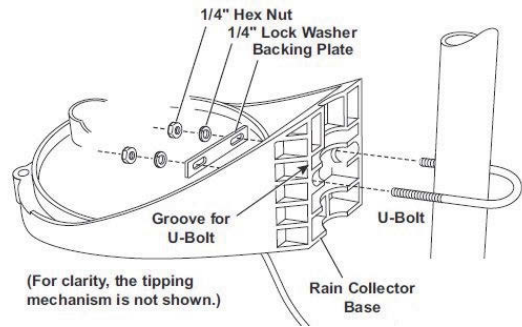

Completing the Sensor Installation

1. To use bird spikes, insert one spike into each socket around the rim of the cone. The sockets are tapered; push firmly or tap lightly with a hammer for a more secure fit. Be careful; bird spikes may be sharp. **Note:** If you choose not to install the bird spikes, we recommend that you keep the packet of spikes in case birds become a problem in the future.

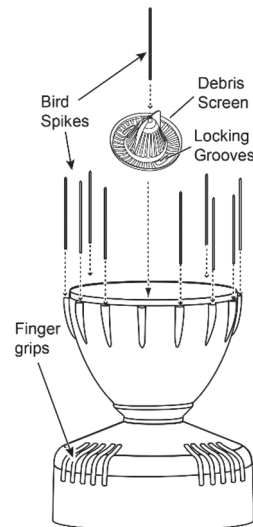

2. Place the cone back onto the base by putting the latches on the cone into the latch openings in the base and rotating the cone clockwise until the latches “lock” into place.
3. Place the debris screen, pointed end up, into the cone. The screen prevents large bits of debris from blocking the funnel hole. If bird nesting is a problem, you can place a spike in the hole on top of the debris screen. Note that using a bird spike in the debris screen may make the screen more likely to be blown over or out in a high wind gust.
4. To prevent fraying or cutting the cable where it is exposed to weather, secure it so it does not whip about in the wind. Use electrical tape or weather resistant cable ties to secure the cable. Place tape or ties approximately every 1 to 1.6 m (3 to 5 ft). Do not use metal staples to secure cables as they can cut the cables. Make sure there are drip loops on both sides of the sensor housing, which must also be mounted horizontally as described under *Sensor Mounting Guidelines*.

Maintenance

For greatest accuracy, you should thoroughly clean the sensor at least once or twice a year.

1. Separate the cone from the base.
2. Use a soft damp cloth to clean pollen, dirt, and other debris from the cone, cone screens, and bucket.
3. Use a pipe cleaner to clear the funnel hole in the cone and the drain screens in the base. When all parts are clean, rinse with clear water.
4. Reattach the cone and replace the screen.

The mote is designed for outdoor use, but should be inspected periodically. When inspecting the mote, do the following:

- Verify the mote is free of visible damage or cracks.
- Make sure the mote is clean. Wipe off any dust or grime with a damp cloth.
- Wipe off any water before opening the mote.
- Make sure the interior seal is intact and the latches are fully locked when the mote door is closed.

Field Calibration

The sensor is calibrated at the factory so the spoons tip (and record rainfall) for each 0.2 mm or 0.01 inch of rain. In some models, you can adjust the calibration slightly by using a 5 mm (3/16 inch) wrench to rotate the adjustment screws located underneath the tipping spoons (see diagram in *Sensor Components and Operation*). Do not touch the reed switch.

The adjustment guide embossed in the platform in some models shows how far you must rotate both screws in turn to effect a 1% and a 2% change.

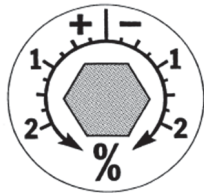

Moving the screws in the positive (+) direction causes the spoons to tip more times (i.e. give a larger count) for a given amount of water. Modify both adjustment screws by the same amount.

To check the accuracy of the sensor, compare it with a tube type rain gauge. Use a rain gauge with an aperture of at least 10.2 cm (4 inches). Any smaller and the readings obtained may not be accurate. Place the tube type rain gauge directly next to the sensor. Compare the totals on three storms to determine whether your rain collector needs calibration and by how much. Adjust the screws to fine-tune the reading for the next three storms if necessary.

Updating Mote Firmware

If a new firmware version is available for the mote, use HOBOLink to download the file to your computer.

1. In HOBOLink, go to Devices, then RX Devices, and click your station name.

2. On the station page, click Overview and scroll down to Device Information.
3. Click the Wireless tab. This icon  appears next to the mote if there is a new version of firmware available.
4. Click the firmware  upgrade link. Click Download and save the firmware .bin file to your computer.
5. Connect the mote to the computer with a USB cable (open the mote door and use the USB port to the right of the LCD). The blue LED is illuminated while connected.
6. The mote appears as a new storage device in the computer's file storage manager. Copy the downloaded firmware file to the new storage device (the mote). The blue LED will blink slowly while the file is copying.
7. After the file is copied to the mote, the LED will stop blinking and remain a steady blue. Eject the storage device from the computer and disconnect the cable from the mote. The firmware installation process will begin automatically on the mote. The blue LED will blink rapidly while the firmware is installed. Once the firmware installation is complete, the LCD symbols return and the mote will automatically rejoin the network.

Notes:

- Mac® users: A message may appear indicating the disk has not ejected properly when disconnecting the mote from the computer. The mote is operational and you can ignore the message.
- If the blue LED turns off abruptly while copying the file or installing the firmware, a problem has occurred. Contact Onset Technical Support for help.

Battery Information

The mote uses two 1.2 V rechargeable NiMH batteries, charged by the built-in solar panel. The quality and quantity of solar light can affect whether the battery is sufficiently charged to last through the night and cloudy periods. Make sure the mote is placed in a location that will receive several hours of sunlight each day. If the mote does not receive enough sunlight to recharge the batteries, the battery life is estimated at 3–4 months. When batteries are regularly recharged, expected battery life is estimated at 3–5 years. Battery life varies based on the ambient temperature where the mote is deployed, the logging interval, the number of tripped alarms, and other factors. Deployments in extremely cold or hot temperatures can impact battery life. Estimates are not guaranteed due to uncertainties in initial battery conditions and operating environment.

Mote operation will stop when battery voltage drops to 1.8 V. Mote operation will return if the battery recharges to 2.3 V. If the batteries are unable to be recharged, replace them with fresh rechargeable batteries. **Note:** if you install used rechargeable batteries that together are less than 2.3 V, the mote will not resume operation.

To replace rechargeable batteries:

1. Open the mote door.
2. Remove the old batteries and install fresh ones observing polarity.

3. Make sure the solar panel cable is plugged in.

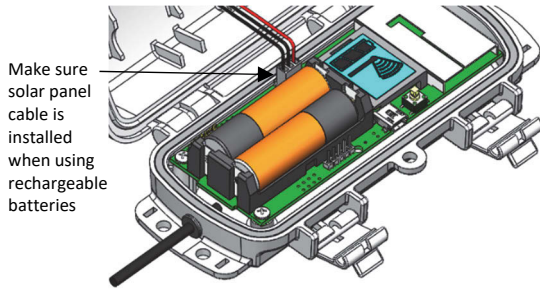

The mote contacts the network once the new batteries are installed. The green LED blinks quickly while the mote searches for a network to join and then blinks slowly while it completes the network registration. Once the mote has finished joining the network, the green LED turns off and the blue LED then blinks indefinitely while the mote is part of the network.

Lithium Batteries

You can use two 1.5 V lithium batteries (HWSB-LI) for operation at the extreme ends of the mote operating range. Lithium battery life is estimated at 1 year, but varies based on the ambient temperature where the mote is deployed, the logging interval, the number of tripped alarms, and other factors. Estimates are not guaranteed due to uncertainties in initial battery conditions and operating environment. When using lithium batteries, you must disconnect the solar panel cable because the batteries will not be recharged.

To install lithium batteries:

1. Open the mote door.
2. Remove any old batteries and install the new ones observing polarity.

3. Push in the side tab of the solar panel cable connector and pull the connector out of the cable port.
4. Place the connector in the slot on the inside of the mote door. Make sure the solar panel cables are tucked inside the door so that they do not interfere with the interior seal when the mote is closed.

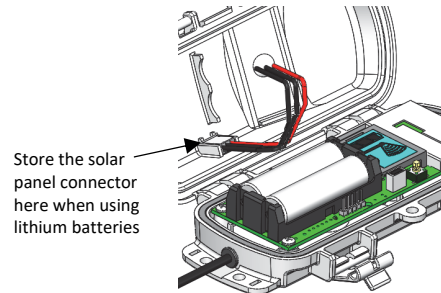

The mote contacts the network once the new batteries are installed. The green LED blinks quickly while the mote searches for a network to join and then blinks slowly while it completes the network registration. Once the mote has finished joining the network, the green LED turns off and the blue LED then blinks indefinitely while the mote is part of the network.

⚠ WARNING: Do not cut open, incinerate, heat above 85°C (185°F), or recharge the lithium batteries. The batteries may explode if the mote is exposed to extreme heat or conditions that could damage or destroy the battery cases. Do not mix battery types, either by chemistry or age; batteries may rupture or explode. Do not dispose of the logger or batteries in fire. Do not expose the contents of the batteries to water. Dispose of the batteries according to local regulations for lithium batteries.

Federal Communication Commission Interference Statement

This equipment has been tested and found to comply with the limits for a Class B digital device, pursuant to Part 15 of the FCC Rules. These limits are designed to provide reasonable protection against harmful interference in a residential installation. This equipment generates uses and can radiate radio frequency energy and, if not installed and used in accordance with the instructions, may cause harmful interference to radio communications. However, there is no guarantee that interference will not occur in a particular installation. If this equipment does cause harmful interference to radio or television reception, which can be determined by turning the equipment off and on, the user is encouraged to try to correct the interference by one of the following measures:

- Reorient or relocate the receiving antenna
- Increase the separation between the equipment and receiver
- Connect the equipment into an outlet on a circuit different from that to which the receiver is connected
- Consult the dealer or an experienced radio/TV technician for help

This device complies with Part 15 of the FCC Rules. Operation is subject to the following two conditions: (1) This device may not cause harmful interference, and (2) this device must accept any interference received, including interference that may cause undesired operation.

FCC Caution: Any changes or modifications not expressly approved by the party responsible for compliance could void the user's authority to operate this equipment.

Industry Canada Statements

This device complies with Industry Canada license-exempt RSS standard(s). Operation is subject to the following two conditions: (1) this device may not cause interference, and (2) this device must accept any interference, including interference that may cause undesired operation of the device.

Avis de conformité pour l'Industrie Canada

Le présent appareil est conforme aux CNR d'Industrie Canada applicables aux appareils radio exempts de licence. L'exploitation est autorisée aux deux conditions suivantes : (1) l'appareil ne doit pas produire de brouillage, et (2) l'appareil doit accepter tout brouillage radioélectrique subi, même si le brouillage est susceptible d'en compromettre le fonctionnement.

To comply with FCC and Industry Canada RF radiation exposure limits for general population, the logger must be installed to provide a separation distance of at least 20cm from all persons and must not be co-located or operating in conjunction with any other antenna or transmitter.