

**HOBO RXW Repeater****Models:**



- RXW-RPTR-900 (US)
- RXW-RPTR-868 (Europe)
- RXW-RPTR-922 (Australia/NZ)

Included Items:

- Cable ties
- Screws

The HOBO RXW Repeater is designed to work with the HOBOnet Wireless Sensor Network in which data is transmitted wirelessly from sensor motes across the network to the RX3000 station and then uploaded to HOBOLink® web-based software. The repeater is ideal when there is an obstruction between motes and the station or for extending the transmission range of motes in the network. With HOBOLink, you can monitor the network, view graphs, set up alarms, download data, and more.

Specifications

Operating Temperature Range	-25° to 60°C (-13° to 140°F) with rechargeable batteries -40 to 70°C (-40 to 158°F) with lithium batteries
Radio Power	12.6 mW (+11 dBm) non-adjustable
Transmission Range	Reliable connection to 457.2 m (1,500 ft) line of sight at 1.8 m (6 ft) high Reliable connection to 609.6 m (2,000 ft) line of sight at 3 m (10 ft) high
Wireless Data Standard	IEEE 802.15.4
Radio Operating Frequencies	RXW-RPTR-900: 904–924 MHz RXW-RPTR-868: 866.5 MHz RXW-RPTR-922: 916–924 MHz
Modulation Employed	OQPSK (Offset Quadrature Phase Shift Keying)
Data Rate	Up to 250 kbps, non-adjustable
Duty Cycle	<1%
Maximum Number of Motes	50 motes per one RX Wireless Sensor Network
Battery Type/ Power Source	Two AA 1.2V rechargeable NiMH batteries, powered by built-in solar panel or two AA 1.5 V lithium batteries for operating conditions of -40 to 70°C (-40 to 158°F)
Battery Life	With NiMH batteries: Typical 3–5 years when operated in the temperature range -20° to 40°C (-4°F to 104°F) and positioned toward the sun (see <i>Deployment and Mounting</i>), operation outside this range will reduce the battery service life With lithium batteries: 1 year, typical use
Dimensions	16.2 x 8.59 x 4.14 cm (6.38 x 3.38 x 1.63 inches)
Weight	219 g (7.74 oz)
Materials	PCPBT, silicone rubber seal
Environmental Rating	IP67, NEMA 6
Compliance Marks	 RXW-RPTR-900: See last page  RXW-RPTR-868: The CE Marking identifies this product as complying with all relevant directives in the European Union (EU).  RXW-RPTR-922: See last page

Components and Operation

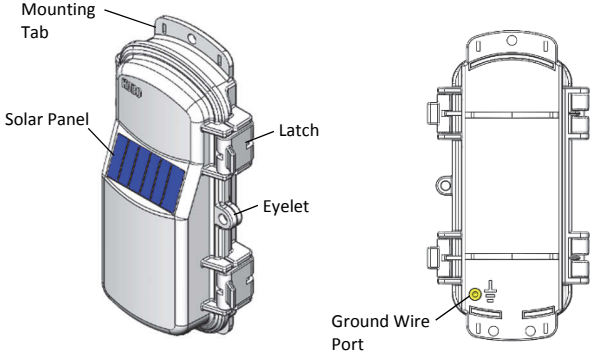

Repeater Closed, Front

Repeater Closed, Back

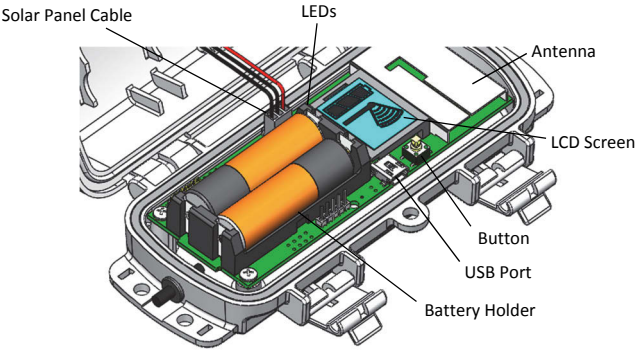

Repeater Opened

- Mounting Tab:** Use the tabs at the top and bottom of the repeater to mount it (see *Deploying and Mounting*).
- Solar Panel:** Position the solar panel towards the sun to charge the repeater batteries (see *Deploying and Mounting*).
- Eyelet:** Use this eyelet to attach a 3/16 inch padlock to the repeater for security.
- Latch:** Use the two latches to open and close the repeater door.
- Ground Wire Port:** Use this port to connect a ground wire (see *Deploying and Mounting*).

- Antenna:** This is the built-in antenna for the radio communications across the RX Wireless Sensor Network.
- Solar Panel Cable:** This cable connects the built-in solar panel to the repeater circuitry.
- LEDs:** There are two LEDs to the left of the LCD screen. The green LED blinks during the process of joining a network, blinking quickly while the repeater searches for a network and then slowly as the repeater registers with the network. Once the network registration process is complete, the blue LED blinks at 4 seconds to indicate normal operation. If the repeater is not currently part of a network, the blue LED will be off. If the blue LED is on and not blinking, there is a problem with the repeater. Contact Onset Technical Support.

- Battery Holder:** The location where the batteries are installed as shown (see *Battery Information*).
- USB Port:** Use this port to connect to the repeater to a computer via USB cable if you need to update the firmware (see *Updating Repeater Firmware*).
- Button:** Push this button for 1 second to illuminate the LCD or 3 seconds for the repeater to search for an RX Wireless Sensor

Network to join (see *Adding the Repeater to the RX Wireless Sensor Network*).

LCD Screen: The repeater is equipped with an LCD screen that displays details about the current status. This example shows all symbols illuminated on the LCD screen followed by definitions of each symbol in the table.



LCD Symbol	Description
	The battery indicator shows the approximate battery charge remaining.
	This is a signal strength indicator. The more bars, the stronger the signal between nodes. If there is no 'x' icon next to the signal strength indicator, then the repeater is part of an RX Wireless Sensor Network.
	An empty signal strength icon plus the 'x' icon indicates that the repeater is not currently part of a network. See <i>Adding the Repeater to the RX Wireless Sensor Network</i> for details on how to add it to the network.
	When the repeater is in the process of joining a network, the signal strength icon will blink and then the bars in the icon will cycle from left to right. The 'x' icon will blink during the last step in the network registration process (see <i>Adding the Repeater to the RX Wireless Sensor Network</i> for details).

Adding the Repeater to the RX Wireless Sensor Network

The repeater must join an RX Wireless Sensor Network before it can begin transmitting data. This requires accessing the RX3000 station and the repeater at the same time so it is recommended that you complete these steps before deploying the repeater.

Important: If you have not configured the RX3000 station with the RXW Manager, follow the instructions in the RX3000 Quick Start before continuing.

To add a repeater to the RX Wireless Sensor Network:

1. If the LCD is blank on the RX3000 station, press any button to wake it up.
2. Press the Select button once (which shows the number of smart sensors installed) and then press it again once if the HOB0 RXW Manager is installed in the left slot (module 1) or twice if it is installed on the right slot (module 2).

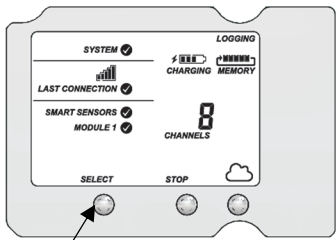

Press this button to view the module where the RXW Manager is installed

- 3. Press the Search button (the magnifying glass). The magnifying glass icon will blink while the RX3000 is in search mode.

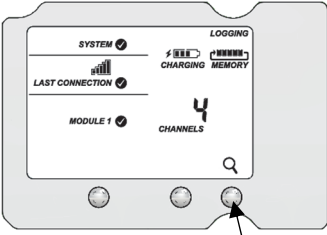

Press this button so the station is ready to have the repeater join the network

- 4. Open the repeater door and install the batteries if you have not already done so.
- 5. Press the button on the repeater for 3 seconds. The signal strength icon will flash and then cycle.

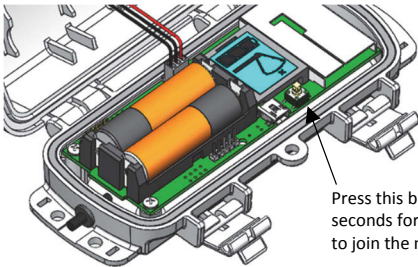

Press this button for 3 seconds for the repeater to join the network

- 6. Watch the LCD on the repeater.

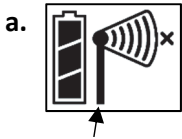

This signal strength icon blinks while searching for a network.

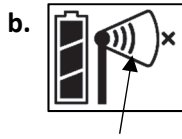

Once a network is found, the icon will stop flashing and the bars will cycle from left to right.



This network connection "x" icon blinks while the repeater completes the registration process, which may take up to five minutes.



Once the repeater has finished joining the network, the "x" icon is removed and the channel count on the station LCD increases by one for the repeater battery.

This process may take up to five minutes. The green LED blinks quickly while the repeater searches for a network to join and then blinks slowly while it completes the network registration. Once the repeater has finished joining the network, the green LED turns off and the blue LED then blinks indefinitely while the repeater is part of the network.

Note: If the mote cannot find the network or has trouble remaining connected during this process, make sure the mote is in a vertical, upright position and within range of the station.

- 7. Press the Search button (the magnifying glass) on the RX3000 station to stop searching for repeaters.

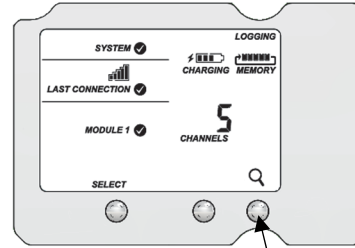

Press this button again to stop searching for the repeater

When you are finished adding repeaters and wireless sensors to the network, the total channel count on the RX3000 station LCD for the RXW Manager module will represent the measurement channels from all motes plus a battery channel for each mote (including repeaters) in the RX Wireless Sensor Network.

Use HOBOLink to monitor repeater status. See the HOBOLink Help for details on how to check status, add the repeater to a map, and more.

Deployment and Mounting

When to Use a Repeater

- Motes cannot transmit data to each other if there is an obstruction between them, such as a hill or mountain in the example diagram below on the left. If there is an obstruction in the path of two sensor motes or between a sensor mote and the RXW Manager, then use a repeater mounted on the obstruction between the two as shown in the diagram below on the right.



- If the distance between two motes is greater than the recommended transmission range in the specifications, then you may need to add a repeater between them.
- If the signal between two motes is weak (consistently one bar on the LCD) even though the motes are within the recommended transmission range, add a repeater between them.

Mounting and Positioning the Repeater

- Mount the repeater to a mast or pipe using cable ties or affix the repeater to a wooden post or flat surface with screws. Insert the cable ties or screws through the holes on the mounting tabs.
- Consider using plastic poles such as PVC to mount the repeater as certain types of metal could decrease the signal strength.

- Make sure the repeater remains in a vertical position once it is placed in its deployment location for optimal network communications.
- Make sure the repeater door is closed, with both latches fully locked to ensure a watertight seal.
- Consider using a 3/16 inch padlock to restrict access to the repeater. With the repeater door closed, hook a padlock through the eyelet on the right side of the door and lock it.
- Position the repeater towards the sun, making sure the solar panel is oriented so that it receives optimal sunlight throughout each season. It may be necessary to periodically adjust the repeater position as the path of the sunlight changes throughout the year or if tree and leaf growth alters the amount of sunlight reaching the solar panel.
- Make sure the repeater is mounted a minimum of 1.8 m (6 feet) from the ground or vegetation to help maximize distance and signal strength.
- There should not be more than five motes in any direction at their maximum transmission range from the RXW Manager. Data logged by a wireless sensor must travel or “hop” across the wireless network from one mote to the next until it ultimately reaches the RXW Manager at the RX3000 station. To make sure the data can successfully travel across the network, the mote should not be more than five hops away from the manager.
- The RX Wireless Sensor Network can support a maximum of 50 motes.
- Use a #4-40 screw to attach a ground wire to the port on the back of the repeater if you are deploying it in a location where lightning is a concern.

Maintenance

The repeater is designed for outdoor use, but should be inspected periodically. When inspecting the repeater, do the following:

- Verify the repeater is free of visible damage or cracks.
- Make sure the repeater is clean. Wipe off any dust or grime with a damp cloth.
- Wipe off any water before opening the repeater.
- Make sure the interior seal is intact and the latches are fully locked when the repeater door is closed.

Updating Repeater Firmware

If a new firmware version is available for the repeater, use HOBOLink to download the file to your computer.

1. In HOBOLink, go to Devices > List and click your station name.
2. On the station page, click Overview and scroll down to Device Information.
3. Click the Wireless tab. This icon  appears next to the mote if there is a new version of firmware available.

4. Click the firmware  upgrade link. Click Download and save the firmware .bin file to your computer.
5. Connect the mote to the computer with a USB cable (open the mote door and use the USB port to the right of the LCD). The blue LED is illuminated while connected.
6. The mote appears as a new storage device in the computer’s file storage manager. Copy the downloaded firmware file to the new storage device (the mote). The blue LED will blink slowly while the file is copying.
7. After the file is copied to the mote, the LED will stop blinking and remain a steady blue. Eject the storage device from the computer and disconnect the cable from the mote. The firmware installation process will begin automatically on the mote. The blue LED will blink rapidly while the firmware is installed. Once the firmware installation is complete, the LCD symbols return and the mote will automatically rejoin the network.

Notes:

- **Mac® users:** A message may appear indicating the disk has not ejected properly when disconnecting the mote from the computer. The mote is operational and you can ignore the message.
- If the blue LED turns off abruptly while copying the file or installing the firmware, a problem has occurred. Contact Onset Technical Support for help.

Battery Information

The repeater uses two 1.2 V rechargeable NiMH batteries, charged by the built-in solar panel. The quality and quantity of solar light can affect whether the battery is sufficiently charged to last through the night and cloudy periods. Make sure the repeater is placed in a location that will receive several hours of sunlight each day. If the repeater does not receive enough sunlight to recharge the batteries, the battery life is estimated at 3–4 months. When batteries are regularly recharged, expected battery life is estimated at 3–5 years. Battery life varies based on the ambient temperature where the repeater is deployed, the logging interval, the number of tripped alarms, and other factors. Deployments in extremely cold or hot temperatures can impact battery life. Estimates are not guaranteed due to uncertainties in initial battery conditions and operating environment.

Repeater operation will stop when battery voltage drops to 1.8 V. Repeater operation will return if the battery recharges to 2.3 V. If the batteries are unable to be recharged, replace them with fresh rechargeable batteries. **Note:** if you install used rechargeable batteries that together are less than 2.3 V, the repeater will not resume operation.

To replace rechargeable batteries:

1. Open the repeater door.
2. Remove the old batteries and install fresh ones observing polarity.

3. Make sure the solar panel cable is plugged in.

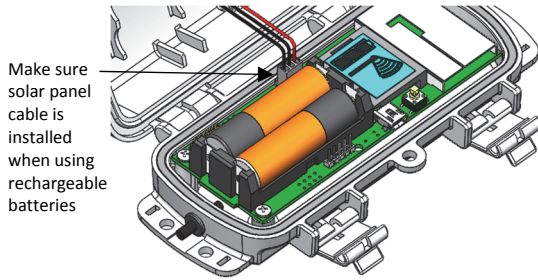

The repeater contacts the network once the new batteries are installed. The green LED blinks quickly while the repeater searches for a network to join and then blinks slowly while it completes the network registration. Once the repeater has finished joining the network, the green LED turns off and the blue LED then blinks indefinitely while the repeater is part of the network.

Lithium Batteries

You can use two 1.5 V lithium batteries (HWSB-LI) for operation at the extreme ends of the repeater operating range. Lithium battery life is estimated at 1 year, but varies based on the ambient temperature where the repeater is deployed, the logging interval, the number of tripped alarms, and other factors. Estimates are not guaranteed due to uncertainties in initial battery conditions and operating environment. When using lithium batteries, you must disconnect the solar panel cable because the batteries will not be recharged.

To install lithium batteries:

1. Open the repeater door.
2. Remove any old batteries and install the new ones observing polarity.

3. Push in the side tab of the solar panel cable connector and pull the connector out of the cable port.
4. Place the connector in the slot on the inside of the repeater door. Make sure the solar panel cables are tucked inside the door so that they do not interfere with the interior seal when the repeater is closed.

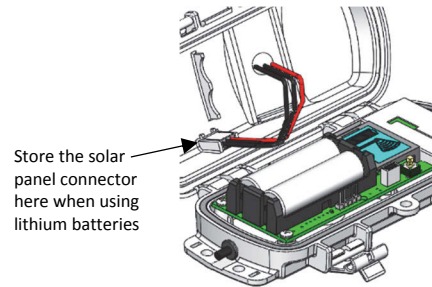

The repeater contacts the network once the new batteries are installed. The green LED blinks quickly while the repeater searches for a network to join and then blinks slowly while it completes the network registration. Once the repeater has finished joining the network, the green LED turns off and the blue LED then blinks indefinitely while the repeater is part of the network.

⚠ WARNING: Do not cut open, incinerate, heat above 85°C (185°F), or recharge the lithium batteries. The batteries may explode if the repeater is exposed to extreme heat or conditions that could damage or destroy the battery cases. Do not mix battery types, either by chemistry or age; batteries may rupture or explode. Do not dispose of the logger or batteries in fire. Do not expose the contents of the batteries to water. Dispose of the batteries according to local regulations for lithium batteries.

Federal Communication Commission Interference Statement

This equipment has been tested and found to comply with the limits for a Class B digital device, pursuant to Part 15 of the FCC Rules. These limits are designed to provide reasonable protection against harmful interference in a residential installation. This equipment generates uses and can radiate radio frequency energy and, if not installed and used in accordance with the instructions, may cause harmful interference to radio communications. However, there is no guarantee that interference will not occur in a particular installation. If this equipment does cause harmful interference to radio or television reception, which can be determined by turning the equipment off and on, the user is encouraged to try to correct the interference by one of the following measures:

- Reorient or relocate the receiving antenna
- Increase the separation between the equipment and receiver
- Connect the equipment into an outlet on a circuit different from that to which the receiver is connected
- Consult the dealer or an experienced radio/TV technician for help

This device complies with Part 15 of the FCC Rules. Operation is subject to the following two conditions: (1) This device may not cause harmful interference, and (2) this device must accept any interference received, including interference that may cause undesired operation.

FCC Caution: Any changes or modifications not expressly approved by the party responsible for compliance could void the user's authority to operate this equipment.

Industry Canada Statements

This device complies with Industry Canada license-exempt RSS standard(s). Operation is subject to the following two conditions: (1) this device may not cause interference, and (2) this device must accept any interference, including interference that may cause undesired operation of the device.

Avis de conformité pour l'Industrie Canada

Le présent appareil est conforme aux CNR d'Industrie Canada applicables aux appareils radio exempts de licence. L'exploitation est autorisée aux deux conditions suivantes : (1) l'appareil ne doit pas produire de brouillage, et (2) l'appareil doit accepter tout brouillage radioélectrique subi, même si le brouillage est susceptible d'en compromettre le fonctionnement.

To comply with FCC and Industry Canada RF radiation exposure limits for general population, the logger must be installed to provide a separation distance of at least 20cm from all persons and must not be co-located or operating in conjunction with any other antenna or transmitter.