

FRONT VIEW



Trademark of the DVB - Digital Video Broadcasting Project

- | | |
|-------------------|-----------------------------|
| ① RF signal input | ④ USB connector |
| ② Detect | ⑤ External power input 12 V |
| ③ Identify | ⑥ Adjust |

SCREEN ICONS REFERENCE



Manual Power Off.



USB connected to the PC.



Battery level



22 kHz signal activated.



Charging battery.

18/13/OFF

LNB power supply (13 V, 18 V or OFF).



The DVB-S, DVB-S2 or DSS has not been synchronized.







The DVB-S, DVB-S2 or DSS has been synchronized.

When using the **SATHUNTER+**, it may appear on the display some messages and icons, depending on the status or event is taking place. These messages and icons are detailed below:

"LOW BATTERY"	-
"VERY LOW BATTERY"	The equipment will be switched off automatically.
"LNB SHORT CIRCUIT"	The LNB can be short circuit.
"LNB OVER CURRENT"	The LNB has a high consumption.
"MANUAL POWER OFF"	The instrument has to be switched off by hand.
"AUTO POWER OFF"	The instrument will switched off after five minutes of inactivity.
"BATTERY MODE"	-
"UPDATE MODE"	-
"NETWORK NOT FOUND"	-
"SERVICES NOT FOUND"	-
"LNB NOT DETECTED"	Power level is below the minimum necessary to detect a LNB (this value can be adjusted by software, usually 10%).
"FULL BATTERY"	-
"MPEG-2 NOT DETECTED"	It is not detecting the Transport Stream signal MPEG-2.
"LOADING NETWORK"	-
"LOADING SERVICES"	-
"HIGH TEMPERATURE"	The running temperature is too high. The equipment must be switched off for a while. If the problem persist, contact with the technical support.

OPERATION

Turn on the **SATHUNTER+** pressing ,  or  for two seconds. If you press  or  for more than five seconds, it starts in manual power off mode.

DETECTION

Plug the **SATHUNTER+** to the antenna socket and turn the antenna until the **SATHUNTER+** shows the maximum power on the display.

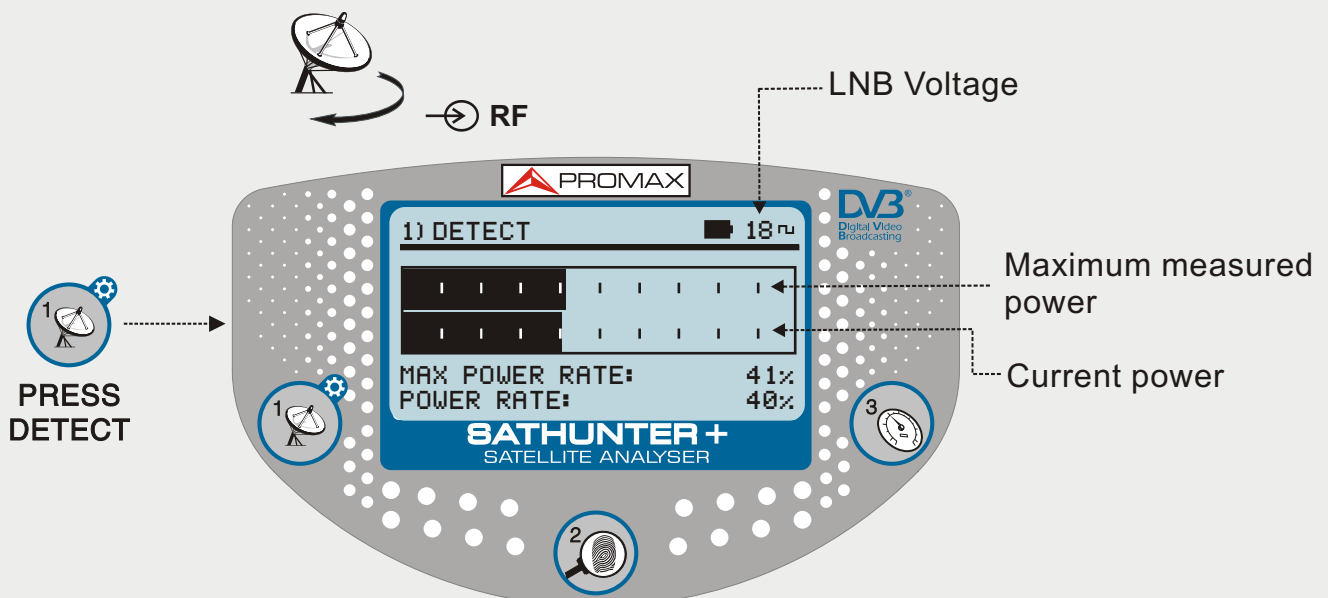

2 IDENTIFICATION

Press and wait until locking the signal. The display will show the parameters of the test point (name and frequency), the channel tuned and its services. To change to another stored channel press again.

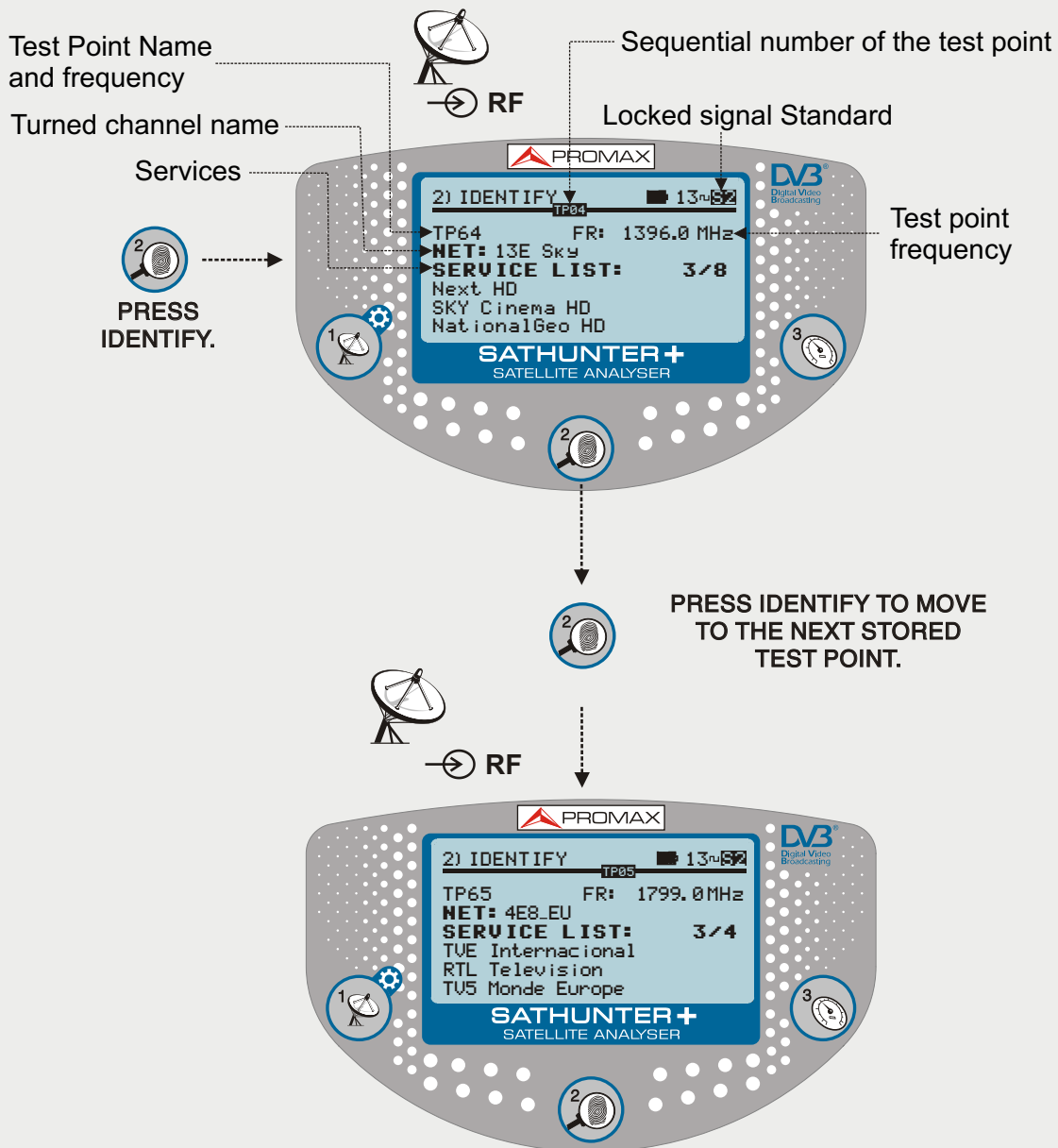

3 ADJUST

Press to perform fine-tuning. Check that every user's access point in the installation is meeting the criteria established by current regulations. To measure another stored channel, press again until finding the channel you are looking for. In case not locking the signal, it shows the **Signal to Noise Ratio (SNR)**.

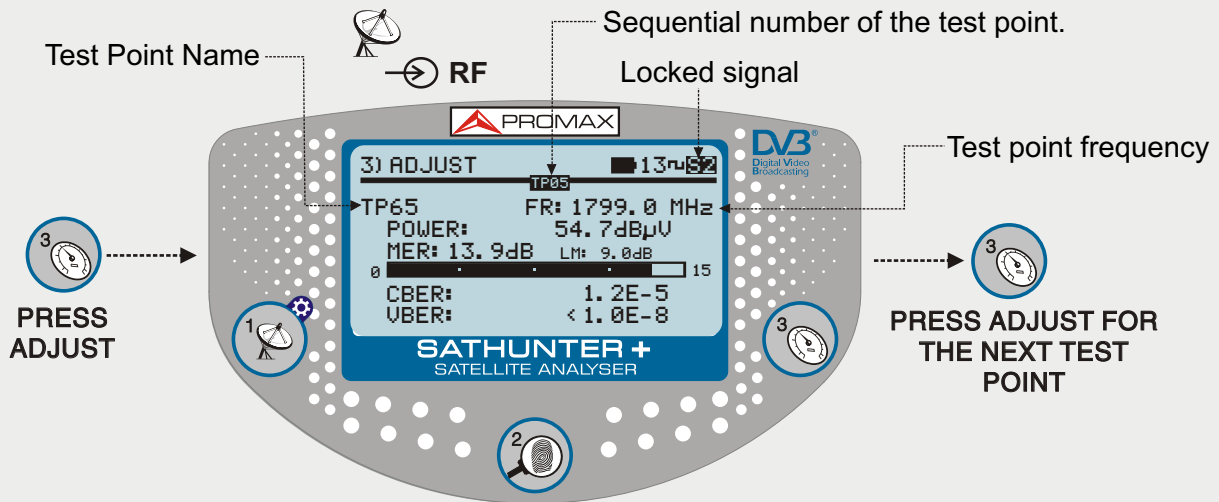

Turn off the **SATHUNTER+** by pressing or for three seconds.

CONFIGURATION

At the **DETECTION** screen, press and hold until appears the configuration menu.

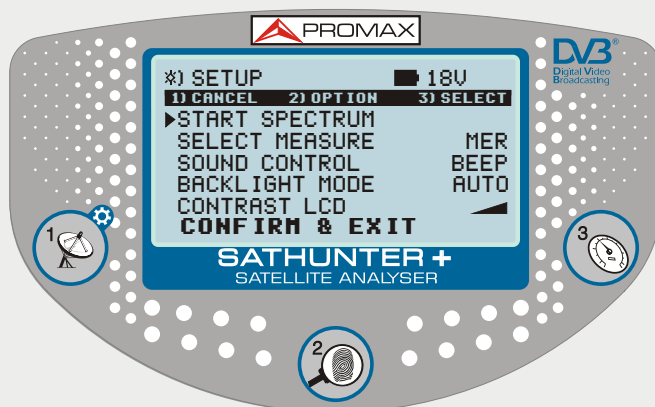

- Exits the configuration menu without saving changes.
- Scrolls along the menu options.
- Changes the parameter / Accepts.

Start Spectrum: It starts the Spectrum Analyser.

Select Measure: Select measurement you want larger on the screen.

Confirm & Exit: It applies and saves the changes made and exits the configuration menu.