

SBS Wireless Modules

Individual Cell Monitors (Accessory for Compatible Battery Capacity Testers)



During capacity testing, the wireless modules measure each cell's voltage and wirelessly send the data back to the paired load bank. All voltage values are displayed on the load bank's LCD screen and listed in the test report, which is created with the computer software. Wireless modules make it easy to locate failed or problematic cells in the battery bank.

Features

- Real-time cell voltage measurement during discharge test
- Advanced technology that wirelessly communicates readings between modules and load bank
- Wide range for 1.2/2V or 2/6/12V battery applications
- One module supports voltage measurements for up to 4 cells
- Supports monitoring up to 120 cells/batteries in a single test
- Protective storage included

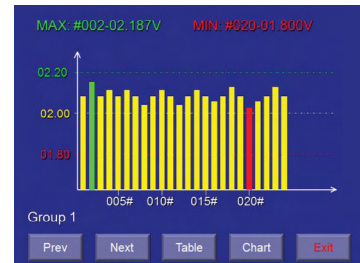
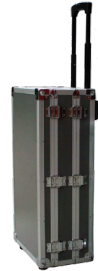

Voltage bar chart on load bank screen

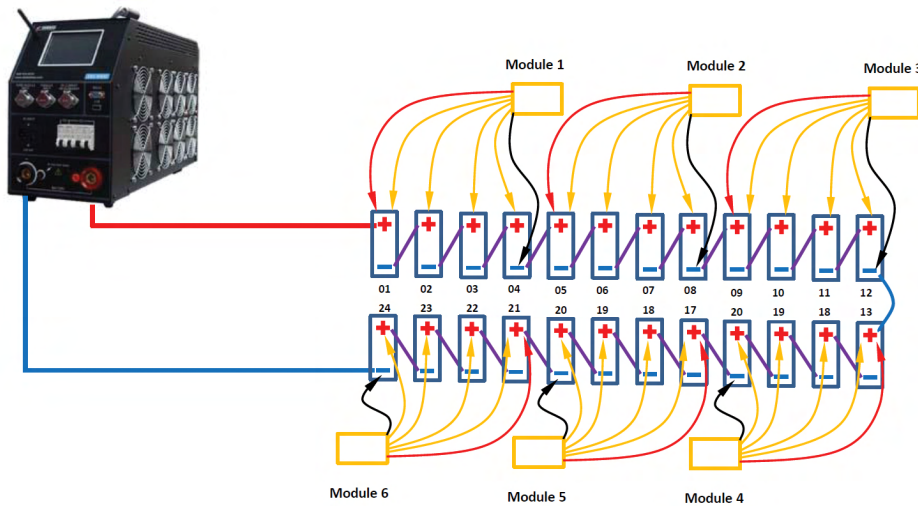

Specifications

Type	SBS-2/6/12	SBS-1.2/2
Support Cell Voltage	2/6/12V	1.2/2V
Wires	Six (1 Red, 1 Black, 4 Yellow)	Five (4 Red, 1 Black)
Power Supply Wire	Red & Black Operating Voltage: 5-24 V Max. Voltage: <400V	Red No. 1 & Black Operating Voltage: 3.5-20 V Max. Voltage: <60V
Measure Voltage Range	0-16 V for each channel	0-5 V for each channel
Accuracy and Resolution	±0.5%, 0.01 V	±0.5%, 0.01 V
Dimensions / Weight	3.9 x 2.6 x 1.3 in. (100 x 65 x 32 mm) / 0.66 lb. (0.3 kg)	
Operation Temp. / Storage Temp. / Humidity	23° to 122° F (-5° to 50° C) / -40° to 158° F (-40° to 70° C) / 5% - 95% RH	

Connection Drawings

**SBS-2/6/12
For Lead Acid Battery Monitoring**



**SBS-1.2/2
For Single-Cell Monitoring**



Monitoring 2Volt Cells with 2/6/12V Module

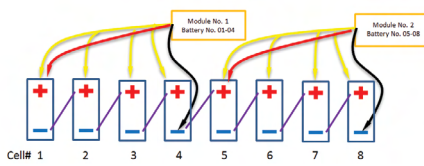

Monitoring 6 or 12V Blocks with 2/6/12V Module

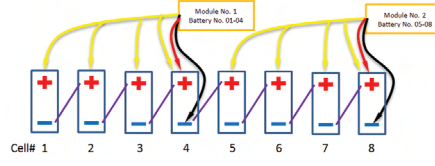

Monitoring 1.2 or 2V Cells with 1.2/2V Module

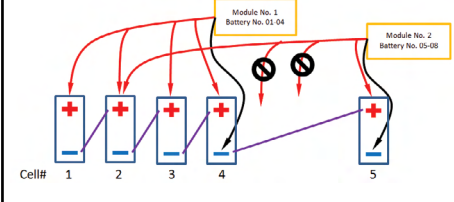
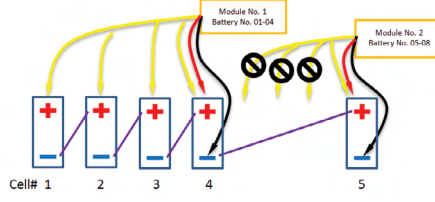
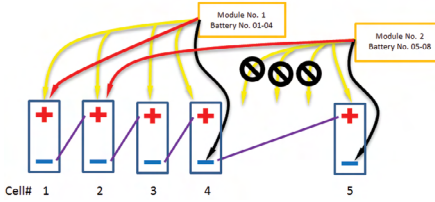
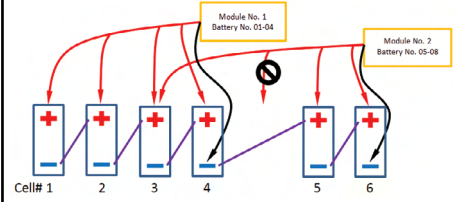
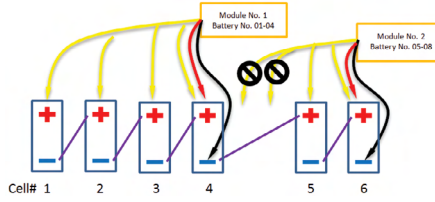
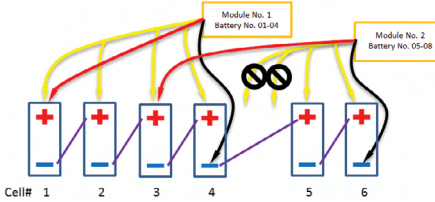
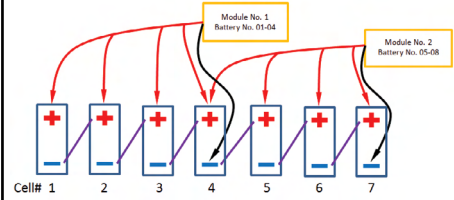
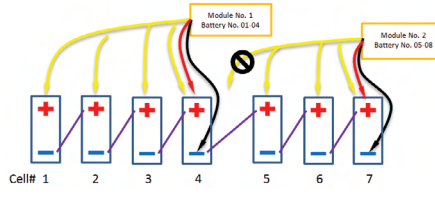
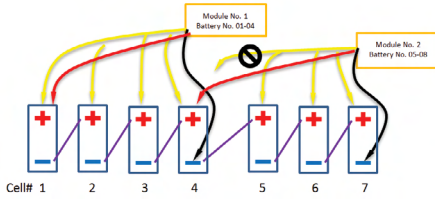
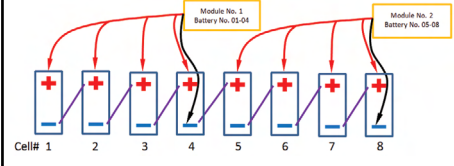

Wireless Load Bank Module Kits Ordering Information

Battery Type	DC Voltages of Systems to be Tested	Module Package(s) Required (Part No.)	Qty. of Modules (+2 spares)
Lead Acid Only (2/6/12V)	12-125 Vdc	MODULE-2/6/12-15	15
	12-250 Vdc	MODULE-2/6/12-30	30
NiCd/Single Cell LA Only (1.2/2V)	12-125 Vdc	MODULE-1.2/2-25	25
	12-250 Vdc	MODULE-1.2/2-30	30