

SeeSnake® microReel

Inspection System



RIDGID[®]

**Test Equipment
Depot**
1-800-517-8431

99 Washington Street
Melrose, MA 02176
Phone 781-665-1400
Toll Free 1-800-517-8431



Visit us at www.TestEquipmentDepot.com

Table of Contents

Recording Form for Machine Serial Number	1
Safety Symbols	2
General Safety Information	
Work Area Safety	2
Electrical Safety	2
Personal Safety	2
Equipment Use and Care.....	2
Service	3
Specific Safety Information	3
SeeSnake microReel Inspection System Product Safety	3
Description, Specifications And Standard Equipment	
Description	4
Specifications.....	4
Standard Equipment	4
Icon Legend	4
microReel System Components	5
Assembly	
Camera Head Routing	5
Opening The Case.....	6
Installing System Cable	7
Reversing/Installing The Display Cradle (microEXPLORER Camera Monitor)	7
Connecting microEXPLORER Camera Monitor to microReel System	8
microReel System Ball Guides	8
Installing Ball Guides	8
Pre-Operation Inspection	8
Work Area And Equipment Set Up	9
Setting Up The microReel System.....	9
CountPlus Settings	10
Operating Instructions	11
Performing An Inspection.....	11
Using The CountPlus Counter Option	12
Locating The microReel System Sonde.....	14
Retrieving The Camera	14
Cleaning Instructions	15
Accessories	15
Transport And Storage	16
Service and Repair	16
Disposal	16
Troubleshooting	16
Lifetime Warranty	Back Cover

Safety Symbols

In this operator's manual and on the product, safety symbols and signal words are used to communicate important safety information. This section is provided to improve understanding of these signal words and symbols.

 This is the safety alert symbol. It is used to alert you to potential personal injury hazards. Obey all safety messages that follow this symbol to avoid possible injury or death.

 **DANGER** DANGER indicates a hazardous situation which, if not avoided, will result in death or serious injury.

 **WARNING** WARNING indicates a hazardous situation which, if not avoided, could result in death or serious injury.

 **CAUTION** CAUTION indicates a hazardous situation which, if not avoided, could result in minor or moderate injury.

NOTICE NOTICE indicates information that relates to the protection of property.



This symbol means read the operator's manual carefully before using the equipment. The operator's manual contains important information on the safe and proper operation of the equipment.



This symbol means always wear safety glasses with side shields or goggles when handling or using this equipment to reduce the risk of eye injury.



This symbol indicates the risk of electrical shock.

General Safety Rules

WARNING

Read all safety warnings and instructions. Failure to follow the warnings and instructions may result in electric shock, fire and/or serious injury.

SAVE THESE INSTRUCTIONS!

Work Area

- **Keep work area clean and well lit.** Cluttered or dark areas invite accidents.
- **Do not operate equipment in explosive atmospheres, such as in the presence of flammable liquids, gases, or dust.** Equipment can create sparks which may ignite the dust or fumes.
- **Keep children and by-standers away while operating equipment.** Distractions can cause you to lose control.

Electrical Safety

- **Avoid body contact with earthed or grounded surfaces such as pipes, radiators, ranges and refrigerators.** There is an increased risk of electrical shock if your body is earthed or grounded.
- **Do not expose equipment to rain or wet conditions.** Water entering equipment will increase the risk of electrical shock.
- **Do not abuse the cord. Never use the cord for carrying, pulling or unplugging the equipment. Keep cord away from heat, oil, sharp edges or**

moving parts. Damaged or entangled cords increase the risk of electric shock.

- **If operating equipment in a damp location is unavoidable, use a ground fault circuit interrupter (GFCI) protected supply.** Use of a GFCI reduces the risk of electric shock.
- **Keep all electrical connections dry and off the ground. Do not touch equipment or plugs with wet hands.** This reduces the risk of electrical shock.

Personal Safety

- **Stay alert, watch what you are doing and use common sense when operating equipment. Do not use equipment while you are tired or under the influence of drugs, alcohol or medication.** A moment of inattention while operating equipment may result in serious personal injury.
- **Use personal protective equipment. Always wear eye protection.** Protective equipment such as dust mask, non-skid safety shoes, hard hat, or hearing protection used for appropriate conditions will reduce personal injuries.
- **Do not overreach. Keep proper footing and balance at all times.** This enables better control of the equipment in unexpected situations.

Equipment Use And Care

- **Do not force equipment. Use the correct equipment for your application.** The correct equipment will

do the job better and safer at the rate for which it is designed.

- **Do not use equipment if the switch does not turn it ON and OFF.** Any equipment that cannot be controlled with the switch is dangerous and must be repaired.
- **Disconnect the plug from the power source and/or the battery pack from the equipment before making any adjustments, changing accessories, or storing.** Such preventive safety measures reduce the risk of injury.
- **Store idle equipment out of the reach of children and do not allow persons unfamiliar with the equipment or these instructions to operate the equipment.** Equipment can be dangerous in the hands of untrained users.
- **Maintain equipment.** Check for misalignment or binding of moving parts, missing parts, breakage of parts and any other condition that may affect the equipment's operation. If damaged, have the equipment repaired before use. Many accidents are caused by poorly maintained equipment.
- **Use the equipment and accessories in accordance with these instructions, taking into account the working conditions and the work to be performed.** Use of the equipment for operations different from those intended could result in a hazardous situation.
- **Use only accessories that are recommended by the manufacturer for your equipment.** Accessories that may be suitable for one piece of equipment may become hazardous when used with other equipment.
- **Keep handles dry and clean; free from oil and grease.** Allows for better control of the equipment.

Service

- **Have your equipment serviced by a qualified repair person using only identical replacement parts.** This will ensure that the safety of the equipment is maintained.

Specific Safety Information

WARNING

This section contains important safety information that is specific to this equipment.

Read these precautions carefully before using the SeeSnake® microReel Inspection System to reduce the risk of electrical shock, fire or other serious personal injury.

SAVE THESE INSTRUCTIONS!

Keep this manual with the equipment for use by the operator.

If you have any question concerning this Ridge Tool product.

SeeSnake microReel Inspection System Product Safety

- **An improperly grounded electrical outlet can cause electrical shock and or severely damage equipment.** Always check work area for a properly grounded electrical outlet. Presence of a three prong or GFCI outlet does not insure that the outlet is properly grounded. If in doubt, have the outlet inspected by a licensed electrician.
- **Do not operate this equipment if operator or machine is standing in water.** Operating machine while in water increases the risk of electrical shock.
- **The microReel System camera and pushrod are waterproof. The monitor and other electrical equipment and connections are not.** Do not expose the equipment to water or rain. This increases the risk of electrical shock.
- **Do not use where a danger of high voltage contact is present.** The equipment is not designed to provide high voltage protection and isolation.
- **Read and understand this operator's manual, the monitor operators' manual, and the instructions for any other equipment in use before operating the microReel System.** Failure to follow all instruction may result in property damage and/or serious personal injury.
- **Always use appropriate personal protective equipment while handling and using equipment in drains.** Drains may contain chemicals, bacteria and other substances that may be toxic, infectious, cause burns or other issues. Appropriate personal protective equipment always includes safety glasses, and may include equipment such as drain cleaning gloves or mitts, latex or rubber gloves, face shields, goggles, protective clothing, respirators and steel-toed footwear.
- **If using drain cleaning equipment at the same time as using drain inspection equipment, only wear**

RIDGID Drain Cleaning Gloves. Never grasp the rotating drain cleaning cable with anything else, including other gloves or a rag. They can become wrapped around the cable, causing hand injuries. Only wear latex or rubber gloves under RIDGID Drain Cleaner Gloves. Do not use damaged drain cleaning gloves.

- **Practice good hygiene.** Use hot, soapy water to wash hands and other exposed body parts exposed to drain contents after handling or using drain inspection equipment. Do not eat or smoke while operating or handling drain inspection equipment. This will help prevent contamination with toxic or infectious material.

Description, Specifications And Standard Equipment

Description

The SeeSnake® microReel Inspection System is a portable pipe inspection diagnostic reel and camera. It comes with a sonde (transmitter) within the camera head and there is also an optional CountPlus counter to measure the pushrod distance traveled. The microReel has a unique removable cable drum, for convenience in cleaning or replacing pushrods. It also has a removable system cable, enabling the microReel to be configured for use with any SeeSnake® camera control units (CCU) or for use with the lightweight hand-held microEXPLORER™ Digital Inspection Camera monitor.

The microReel uses a 100 foot (30 meters) pushrod of more rigid design than the microDrain pushrod. Where the microDrain pushrod is built for maneuverability and short runs through toilets and P Traps, the microReel has a stiffer pushrod design that makes it suited for longer runs in pipes 1½" to 4" (3.8 to 10.2 cm) in diameter.

DO NOT ATTEMPT to negotiate toilet traps with the microReel pushrod. It is less flexible than its cousin the SeeSnake microDrain™ pushrod and will not handle the close tight turns of a standard P-trap, closet bend or S-trap which the microDrain may pass through.

With an appropriate SeeSnake control unit, the operator can connect an external Line Transmitter and use a standard locator to line-trace the path of the microReel push cable in a pipe.

Specifications

Weight12.2 lbs (5.5 kg) (with microEXPLORER Camera Monitor),
10.3 lbs. (4.7 Kg) (without microEXPLORER Camera Monitor)

Dimensions:

Length13.25" (33.6 cm)
Depth.....6.6 " (16.7 cm)
Height.....14.2" (36 cm) (without microEXPLORER Camera Monitor Cradle)

Line Capacity.....1½" to 4" (3.8 to 10.2 cm)

Maximum Run100' (30 m)

Sonde Transmitter.....512Hz

Reel & Frame

Diameter12.75" (32 cm)

Camera Diameter0.98" (25 mm)

Camera Length.....1.48" (37.6 mm)

Push Cable Diameter0.265" (6.7 mm)

Video656 x 492 NTSC
768 x 576 PAL

Number Of Pixels323K NTSC
442K PAL

Lighting.....6 High Flux LEDs

Operating Environment:

Temperature32° to 115° F (5°C to 46°C)

Humidity5% to 95%

Storage Temperature....-4°F to 158°F (-20°C to 70°C)

Waterproof Depth266' (81 m)

The microReel System is protected under pending U.S. and International patent applications.

Standard Equipment

- Operator's Manual
- Instructional DVD
- Ball Guides
- Sonde (Transmitter)

Icon Legend



Slip-Ring Unlock Position



Slip-Ring Lock Position

microReel System Components

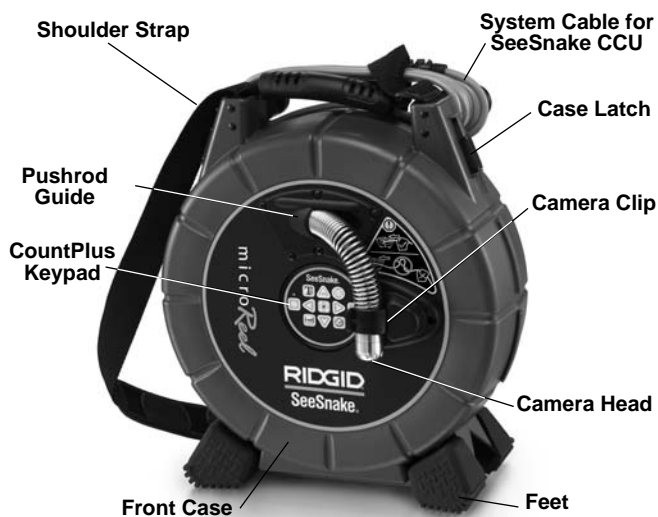

Figure 1 – Front View (SeeSnake Configuration)



Figure 2 – Rear View (microEXPLORER Camera Monitor Configuration)



Figure 3 – Opening The Case

Assembly

⚠ WARNING

To reduce the risk of serious injury during use, follow these procedures for proper assembly.

Camera Head Routing

1. Set the unit on a level surface laying it on its side.
2. Unfasten the case latches on either side of the microReel (Figure 4).



Figure 4 – Unlatching the microReel Case

3. Open the case carefully and only far enough to slip the camera out through the cable guide. When routing the camera head out through the cable guide be careful to **avoid letting the pushcable spring out of the drum** or uncoil freely. Close the case and secure the camera head in the provided clip.



Figure 5 – Open Drum Carefully To Route Cable



Figure 6 – Do Not Open Case Completely

4. Close and re-latch the case.



Figure 7 – Camera Head Properly Routed

Opening the Case

Never open the latches with the camera on the outside of the case. Move the camera all the way inside the case by pushing it back through the cable guide BEFORE you undo the latches.

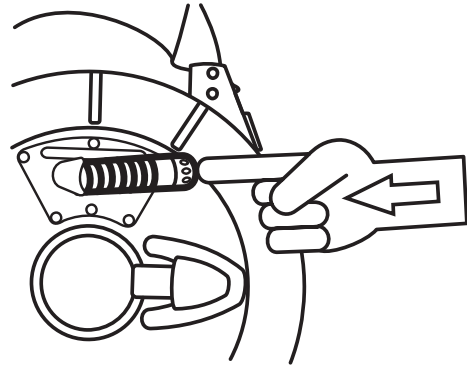

Figure 8 – ENSURE CAMERA IS INSIDE THE DRUM COMPLETELY BEFORE YOU UNDO LATCHES AND OPEN THE CASE. This will reduce the risk of the cable springing out and becoming kinked.



Figure 9 – Do Not Open Case with Camera Outside

If the camera is still led out through the pushrod guide when the case is opened, the cable may be drawn up above the lip of the drum. It may spring free and uncoil from the drum. If this happens, it may kink.

Feed the pushrod back in carefully. Do not twist or bend the pushrod sharply when coiling it back into the drum. Compressing or forcing an improperly coiled cable may cause it to break.



Figure 10 – Do Not Allow Cable to Uncoil Freely

Installing System Cable

If the system cable slip-ring module is not installed, squarely insert the slip-ring module into the hub and twist it clockwise until it locks into position. (See Figure 11.)



Figure 11 – Locking The Slip Ring Module Cover

NOTICE Do NOT touch the contact pins in the slip-ring module. This can cause the contact pins to break.

The contact pins will not break under normal use, correctly connected. However pressing sideways on them can cause them to break, as shown in Figure 12.

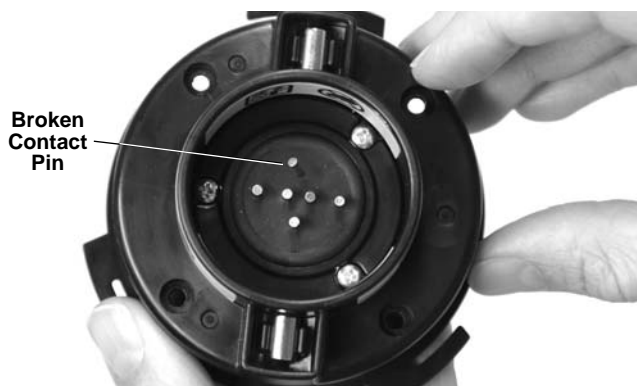

Figure 12 – Broken Contact Pin

Reversing/Installing The Display Cradle (microEXPLORER Camera Monitor)

If you are using the microReel with the microEXPLORER Camera monitor unit, you may find it more convenient to have the microEXPLORER Camera monitor facing the other way when it is seated in its cradle. To reverse the orientation of the cradle, do the following:

1. Remove the microEXPLORER Camera monitor display from the cradle. With a Philips head screwdriver, remove four screws holding the cord-wrap arms and cradle to the case. Remove the cord-wrap arms and the screws (Figure 13).



Figure 13 – Cradle Support and Cord-Wrap Arms

2. Use one of the screws to remove the nuts from the back side of the cradle. The nuts are friction-fitted into the holes on the opposite side of the cradle from the cord-wrap arms. By inserting a screw from the back and threading it two or three turns into the nut, you can pull the nut out.
3. Without taking the nut off the screw, insert the screw and nut into the hole on the opposite side of the cradle from which the screw was removed. Firmly seat the screw into the friction-fit at the bottom of the hole.
4. Unthread the screw. Repeat for each of the remaining three nuts.
5. Position the cord-wrap arm and cradle on the rear of the case, facing in the opposite direction. Make sure the cord-wrap horns point outward.
6. Start each screw into its nut by hand. Tighten the screws with the screwdriver.
7. Replace the display unit in the cradle.

Use a similar process for installing the display cradle.

Connecting microEXPLORER Camera Monitor to microReel System

Align the microEXPLORER Camera Connector Plug with the plug on the microEXPLORER Camera and slide straight in, seating it squarely. The curved face of the connector plug on the system cable faces upward, sliding under the forward edge of the microEXPLORER Camera monitor when fully seated (See Figure 14).

NOTICE Do not twist the connector plug. Doing so may damage the plug.



Figure 14 – Connecting the microEXPLORER Camera Monitor

microReel System Ball Guides

Ball guides are designed to help center the camera in pipes of various sizes, and keep the camera clear of bottom sludge in the pipe. By bringing the camera head closer to the center of the pipe they improve picture quality, allowing the camera to see equally in all directions and help keep the camera lens clear during inspections (Figure 16).

Ball guides should be used when possible, because they reduce wear and tear on the camera system. If you run into difficulty moving the camera head through a particular pipe, the centering guides can be easily removed. The placement of the guides can be adjusted along the length of the camera head to best suit the job. For example, you may find that placing centering guides near the front end of the camera may bias the camera head upward. This could be beneficial if you need to see the top of the pipe during your inspection. Ball guides can also help negotiate some passages.

The ball guides supplied with the microReel are identical in function but of slightly different diameter and will not fit properly on the microDrain System camera.

Installing Ball Guides

The ball guides supplied with the microReel System are designed to slip easily onto the camera spring and lock into place. The ball guide has two red sliding locks and two blue latches.

1. Slide the red slide locks away from the blue latches on both sides of the guide (Figure 15).

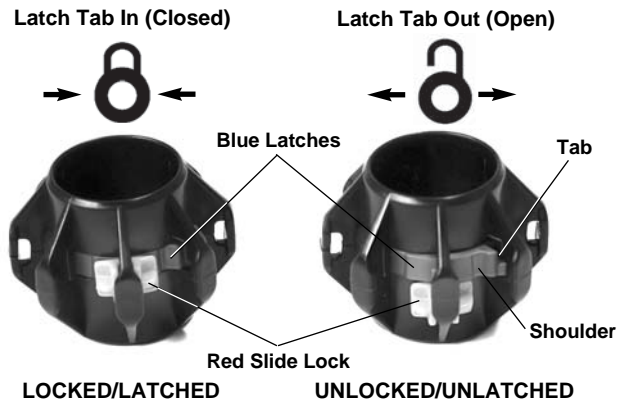

Figure 15 – Ball Guide Installation

Spread blue latch tabs apart to unlatch; press shoulders toward each other to latch.

2. Press the small tabs on the blue latches so they click outward (away from each other).
3. Slide the ball guide into desired position over the camera head.
4. Press down on the shoulders of the blue latches so the latches are pressed in toward each other, and engage into the spring.
5. Slide the two red sliding locks back over their respective blue latches so they cannot pop out in use.

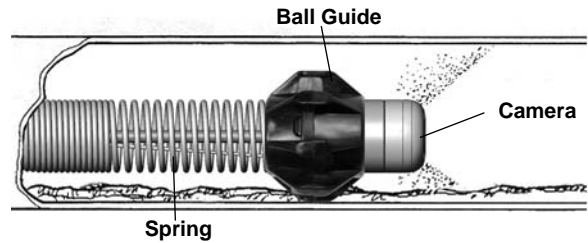

Figure 16 – Ball Guide In Use

Pre-Operation Inspection

⚠ WARNING



Before each use, inspect your microReel System camera and reel and correct any problems to reduce the risk of serious injury from electrical shock or other causes and prevent machine damage.

1. Confirm that the power is off and if used with a camera control unit (CCU) other than the MicroEXPLORER Camera monitor confirm that the CCU is not connected to the unit. Inspect the system cable and connectors for damage or modification.
2. Clean any dirt, oil or other contamination from the microReel System to aid in inspection and to prevent the unit from slipping from your grip while transporting or using.
3. Inspect the microReel System for any broken, worn, missing, misaligned or binding parts, or any other condition which might prevent safe, normal operation. Confirm that the unit is properly assembled. Make sure that the drum turns freely. Inspect the pushrod for any cuts, breaks, kinks or ruptures.
4. Inspect any other equipment being used per its instructions to make sure it is in good usable condition.
5. If any problems are found, do not use the unit until the problems are corrected.

Work Area and Equipment Set Up

⚠ WARNING



Set up the microReel System and work area according to these procedures to reduce the risk of injury from electrical shock, fire, and other causes, and to prevent damage to the microReel System.

Always wear eye protection to protect your eyes against dirt and other foreign objects.

1. Check work area for:
 - Adequate lighting.
 - Flammable liquids, vapors or dust that may ignite. If present, do not work in area until sources have been identified and corrected. The microReel System is not explosion proof. Electrical connections can cause sparks.
 - Clear, level, stable dry place for machine and operator. Do not use the machine while standing in water. If needed, remove the water from the work area.
 - Clear path to electrical outlet, if used for the CCU,

that does not contain any potential sources of damage for the power cord.

2. Inspect the work to be done. If possible, determine the drain access point(s), size(s) and length(s), presence of drain cleaning chemicals or other chemicals, etc. If chemicals are present, it is important to understand the specific safety measures required to work around those chemicals. Contact the chemical manufacturer for required information.
If needed, remove fixture (water closet, sink, etc.) to allow access.
3. Determine the correct equipment for the application. The microReel System is made for:
 - 1½" to 4" (3.8 to 10cm) lines up to 100' (30m) long.
 - Inspection equipment for other applications can be found by consulting the Ridge Tool Catalog.
4. Make sure all equipment has been properly inspected.
5. Evaluate the work area and determine if any barriers are needed to keep bystanders away. Bystanders can distract the operator during use. If working near traffic, erect cones or other barriers to alert drivers.

Setting Up The microReel System

Connections

If using the microReel with a microEXPLORER Camera monitor, no additional connections beyond those described in the assembly section are needed when setting up the unit for an inspection.

When using with SeeSnake camera control units (CCU's), unwrap the system cable from the cord wrap on the microReel case. Attach the system cable connector to the matching connector on the CCU. Align the guide pin on the cable connector with the guide socket in the CCU connector and push the cable connector straight in. A ridge molded into the outside of the cable connector will point up when the guides are properly aligned. Tighten the outer locking sleeve on the cable connector to retain the system cable in place. **Do not twist the cable while tightening the locking sleeve. This can damage the cable.** See *Figure 17 and 18.*

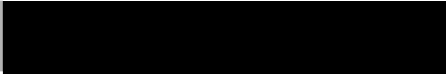

Figure 17 – Connecting To A SeeSnake CCU

Preferably, lay the microReel on its back with the camera unit and pushrod on top. There are foot pads provided on the cord wrap to allow placement in this position. This position provides the greatest stability and helps to prevent tipping of the reel during use.

CountPlus Settings

The CountPlus is a distance-counter option which can be purchased with the microReel. It can track the total length of pushrod that has been run out of the drum or measure distance between two points in a pipe, starting from some local zero-point selected during the inspection (such as a pipe head or joint). The CountPlus can also display overlays of text messages such as labels of pipe line features. Press on the CountPlus Menu Key , to bring up the Main Menu screen with three icons on it.



Figure 18 – microReel System Connected to SeeSnake® DVDPak CCU



Figure 19 – Main Menu

If using a microReel System set up for use with a microEXPLORER Camera monitor, it can be converted for use with other SeeSnake CCU's (or vice versa) by changing the system cable as detailed in the assembly section.

Set up the microEXPLORER Camera monitor or CCU as per its instructions. If using the microEXPLORER Camera monitor or a battery powered CCU, make sure that the required batteries are fully charged and installed.

Placement

1. Place the microEXPLORER Camera monitor or CCU monitor to allow easy viewing while manipulating the pushrod and camera. Usually right next to the entry point for the pushrod is a good choice. The location should not be wet or allow the monitor unit to get wet during use.
2. Set the microReel behind or to one side of the operator. Allow enough room for ample pushrod to be used for grasping and manipulating without excess dragging on the ground. When properly located, push cable will only come off the reel when you pull it.

The CountPlus interface allows you to set up and modify a number of important parameters for use with your SeeSnake system.

These include:

- System Time
- System Date
- Reel and Cable
- Units of Measure

You will also need to be familiar with:

- Setting Up Text Slides
- Creating a New Slide
- Editing an Existing Slide
- Choosing a Slide for Display
- Turning Slide Display On or Off
- Deleting a Slide

These are described in the separate CountPlus manual. Please read the complete CountPlus manual and ensure you are familiar with its operation when doing an inspection with a SeeSnake microReel System.

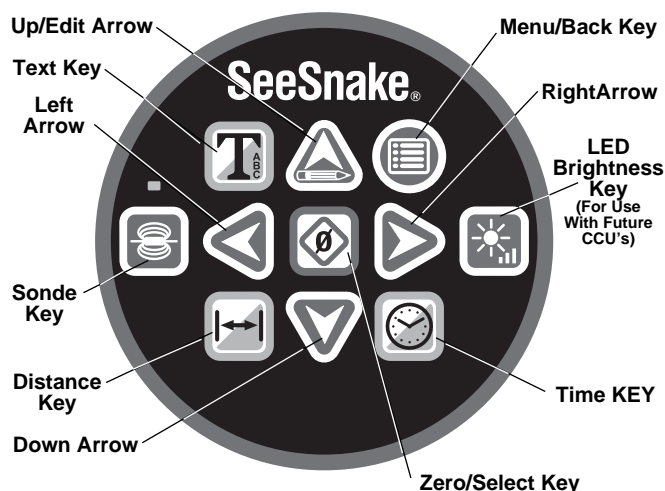

Figure 20 – Optional CountPlus Keypad Callout

Operating Instructions

⚠ WARNING



Always wear eye protection to protect your eyes against dirt and other foreign objects.

When inspecting drains that might contain hazardous chemicals or bacteria, wear appropriate protective equipment, such as latex gloves, goggles, face shields or respirators, to prevent burns and infections.

Do not operate this equipment if operator or machine is standing in water. Operating machine while in water increases the risk of electrical shock. Rubber soled, non-slip shoes can help prevent slipping and electric shock, especially on wet surfaces.

Follow operating instructions to reduce the risk of injury from electrical shock and other causes.

Performing An Inspection

1. Make sure all equipment is properly set up.
2. Pull several feet of pushrod from the reel. Make sure the camera window is clean. In some cases, a slight film of detergent on the window may minimize debris sticking to the window. Place the camera unit into the line to be inspected.

NOTICE DO NOT ATTEMPT to negotiate toilet traps with the microReel pushrod. It is less flexible than the

microDrain System pushrod and will not handle the close tight turns of a standard P-trap, closet bend or S-trap which the microDrain may pass through. The microReel is designed for longer inspection runs and can readily negotiate normal 90° and 45° joints.

3. Turn the CCU on. As per the specific CCU operator manual, adjust the camera head LED lighting brightness and the display image. As the pipe material and other factors vary, it may be necessary to make adjustments as the drain is being inspected. For instance, white PVC pipe requires less light than black PVC. Slight adjustments in lighting brightness can be used to highlight issues discovered during an inspection. Always use the least amount of lighting to maximize picture quality and reduce heat build up.
4. If recording the inspection, follow the instructions in the specific CCU Operator's manual.
5. If possible, run water through the system during the inspection. This helps to keep the system clean and makes pushing the pushrod easier. It also helps to orient the image to the bottom of the pipe. This can be done by placing a hose down the line or turning on a fixture/flushing a toilet. The flow can be shut off as needed for viewing.
6. Grip the pushrod and carefully start to feed it into the drain to be inspected. It is recommended that rubber gripper type gloves be used to manipulate the pushrod. They improve grip and help to keep hands clean.



Figure 21 – Using The microReel

When pushing the pushrod in to the line, keep the pushrod clear of any sharp edges on the inlet that could cut, grab or damage the pushrod. Grasp and push short sections of pushrod at a time and keep your hands near the inlet to better control the pushrod and prevent it from folding over, snapping, cutting the pushrod jacket or other damage. Cutting the pushrod jacket could increase the risk of electrical shock.

As the pushrod is fed into the line, watch the monitor to know what is coming. When the lights are set at less than maximum setting, it may help to occasionally turn the brightness up to see what is coming further down the line. Be aware of obstructions (such as crushed pipe) or excessive hard build up in the line that could prevent retrieval of the camera. Do not try to use the camera head to clear obstructions. The microReel System is a diagnostic tool, not a drain cleaner. Using the camera head to clear obstructions could damage the camera head or cause it to be caught in the obstruction, preventing removal (Figure 22).

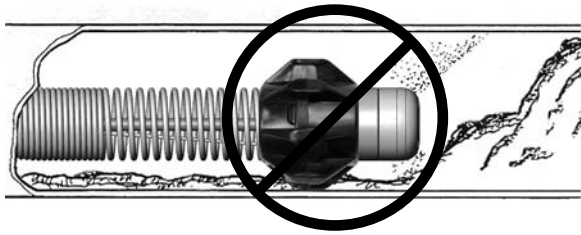

Figure 22 – Encountering An Obstruction – Do Not Use Camera Head To Clear Obstructions

Most of the time a slow steady push through the system works the best. At changes in direction such as P-traps, Tee's, Y's, elbows, etc., it may be necessary to use a quick push to “pop” the camera head around the bend. This is done by pulling the camera head back from the bend approximately 8" (20 cm) and giving it a quick thrust through the bend. Be as gentle as possible, and use no more force than required to do this. Excessive force can damage the camera head. Do not hammer or snap the camera through bends. Do not force the camera head through if there is a large amount of resistance. Be especially careful through Tee's, as the pushrod could fold over in the Tee and make retrieval difficult or impossible.

The microReel can travel through multiple 45 and 90 degree bends and Y-junctions. DO NOT force it through a P-trap or T-fitting if there is a large amount of resistance. The microReel should not be used to inspect toilet traps, as the bends are too extreme for the pushrod to navigate safely.

Watch to make sure that the drum does not hang up during use. If the drum hangs up and the pushrod continues to be pulled from the reel, the pushrod will tighten around the hub of the drum and cause the pushrod to jam in the drum and stress the pushrod.



Figure 23 – Avoid Pulling At Sharp Angles

When inspecting the line, moving the camera head past the area to be inspected and slowly pulling it back may give better results. Usually pulling the camera head back allows for more controlled and consistent viewing. When pulling the pushrod, keep clear of any sharp edges and do not pull at sharp angles to the inlet to prevent damage to the pushrod (Figure 20). If needed, jiggle the camera head in any standing water to rinse any debris from the camera window.

Depending on what is encountered during the inspection, it may help to add, remove or change the position of ball guides on the camera head. Ball guides may be able direct the camera towards a section of the line (such as the top), raise the camera head out of the liquid in the pipe, or help negotiate bends. (See Figure 24). See the Assembly Section for information on ball guide attachment.

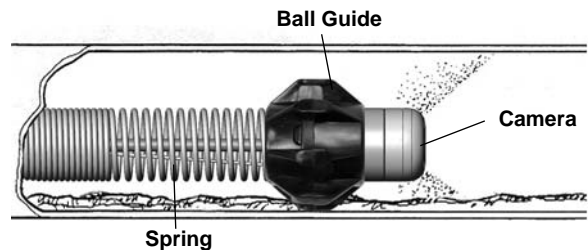



Figure 24 – Ball Guide In Use

Using The CountPlus Counter Option

With the SeeSnake connected and powered on, use the Distance Key  and the Time Key  to set the display with the information you prefer.



- a. The Time Key will toggle the display between Date, Date and Time, Time or No Date and Time displayed. Press the key once for each step through the choices.
- b. The Distance Key will toggle the display of distance on the screen between on and off.
- c. The distance counter will show the distance in the units set in the Tools  /Units  menu.



Figure 25 – Display Screen with Slide Text, Time and Distance Shown
(Distance measured from system zero-point)

NOTE! When using with the microEXPLORER Camera Monitor if the counter information is not visible on the screen try zooming the image out by pressing the down arrow on the face of the microEXPLORER Camera unit.

System Zero-Point and Local Zero Point

The counter, as shown in Figure 25, starts from zero when the system is powered on. This is called the system zero-point. You can change the physical point the system starts measuring from by powering the system off, running the cable in or out to the desired starting point, and powering on from that point. The counter resets to zero when the system is powered on again.

Resetting the System Zero-Point: You can also reset this system zero point at anytime with a long press (> 3 seconds) on the Zero Key. It is good practice to do this, for example, at the entrance to a pipe.

Setting a Local Zero-Point: In addition, while it is operating, the SeeSnake can be made to also start counting from any custom “local zero-point” you select with a second counter.

1. To begin a separate distance count from a selected point, such as a junction within a pipeline, press the Zero/Select Key  briefly. The distance display will re-set to [0.0]. The square brackets indicate that you are measuring from a local zero-point rather than the system zero-point.
 - a. Once you start measuring cable feed from a local zero-point, do not press the Zero Key again until you have completed the measurement you are working on, as pressing it will reset the custom zero-point again and lose the measurement you have been taking.

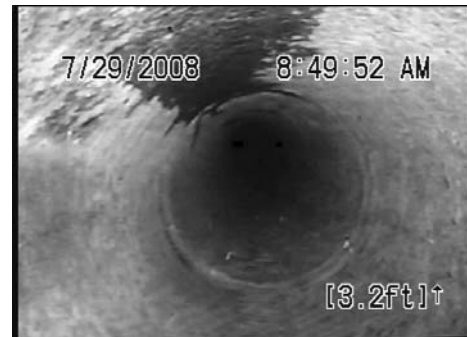



Figure 26 – Measuring from a Local Zero-Point

- b. As a precaution you may want to write down the system measurement's value just before setting a new local zero point. (This will enable you to compute the distance manually using the system count, if you reset the local zero-point accidentally).
- c. Once you are finished measuring, pressing the Zero Key  will now toggle the display back to the system count or create a new local [0.0] point.

Getting Consistent Measurements

Make sure all the cable is in the reel before powering up the system. Wait for the initialization screen to disappear before moving the camera head from the guide hoop. This takes about 10 seconds.

Avoid moving the reel once you have started your measurements.

Make sure the cable length, cable diameter and drum-size settings are correct for your system.

If the system is shut down or loses power for more than 10-20 seconds the SeeSnake microReel may re-zero its system zero point of reference, and any local zero-point count will be lost.

When spooling the cable into the drum, maintain a uniform friction or drag on the cable to ensure it does not bunch up in the drum.

Accuracy In general use, the SeeSnake reported distance will be accurate to within 3 feet (1 meter). This accuracy depends on cable tension, correct reel settings and other factors.

For greatest accuracy:

1. Make sure the camera head is in or nearly in the guide hoop when powering up. This ensures the distance computing is done from a full reel.
2. For measurements starting from somewhere other than the reel, such as the head of a drain line, reset the “system zero” point with a long press (> 3 seconds) on the Zero Key, or use the “local zero” option (by pressing the Zero/Select key) briefly, rather than

powering up with a significant length of cable already run out.

A “dead battery” icon will appear at start-up if the CountPlus’ battery has died.

A “+” sign will appear after the distance measurement on-screen if the measured distance exceeds the selected cable length chosen in set-up.

Locating The microReel System Sonde

MicroReel systems are equipped with a Sonde (In Line Transmitter) just behind the camera head. If equipped with a Sonde, a locating unit can be used to detect the Sonde and locate features in the drain being inspected.

Controlling the Sonde from a SeeSnake CCU is described in the Operator’s Manual for the CCU and depends on the model being used. The Sonde is turned ON or OFF by pressing the Sonde key on the CountPlus keypad. Typically, the Sonde can be turned ON and OFF from the CCU. If you are using the microREEL System with the microEXPLORER Camera monitor, the Sonde is activated by turning the LED brightness control down to zero. Once the Sonde has been located, the LEDs can be returned to their normal brightness level to continue the inspection.

When the microReel System Sonde is turned on, a locator such as the RIDGID SR-20, SR-60, Scout, or NaviTrack® II set to 512 Hz will be able to detect it. The most workable approach to tracking the Sonde is to run the pushrod into the pipe about five or ten feet (1.5 to 3 meters) and use the locator to find the Sonde’s position. If desired, you can then extend the pushrod a similar distance further down-pipe and locate the Sonde again starting from the previous located position.

To locate the Sonde, turn the locator on and set it to Sonde mode. Scan in the direction of the Sonde’s probable location until the locator detects the Sonde. Once you have detected the Sonde, use the locator indications to zero in on its location precisely. For detailed instructions on Sonde locating, consult the Operator’s Manual for the locator model you are using.

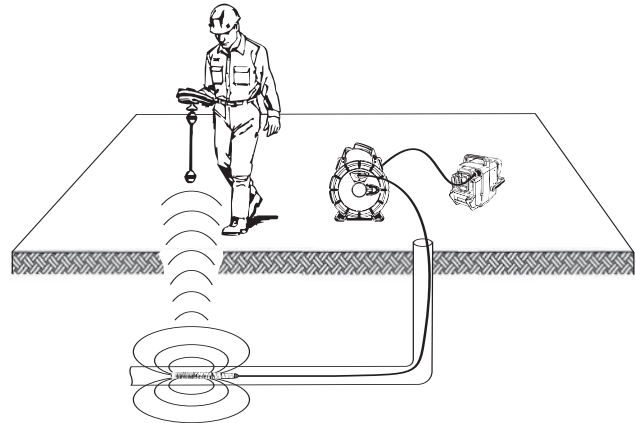

Figure 27 – Locating the microReel Sonde

Retrieving The Camera

Once the inspection has been completed, pull the pushrod back with slow, steady force. Continue running water down the line if possible to help clean the pushrod. A towel can be used to wipe off the pushrod as it is withdrawn.

Pay attention to the force required to withdraw the pushrod. The pushrod may get hung up while being retrieved, and may need to be manipulated as done during insertion. Do not force the pushrod or exert excessive force. This could damage the camera or pushrod. When pulling the pushrod, keep clear of any sharp edges and do not pull at sharp angles to the inlet to prevent damage to the pushrod.

As the pushrod is withdrawn from the inlet, keep your hand close to the microReel and use short strokes to feed it back into the drum. (Figure 28-29)



Figure 28 – Proper Technique For Pushing Cable Back Into Drum



Figure 29 – Allowing cable to loop may kink the cable while pushing into drum

NOTICE ALWAYS use short strokes to feed back small lengths of the pushrod back into the drum. Pushing back longer lengths of pushrod or forcing the pushrod may cause it to loop, kink and break. Laying the microReel drum on its back offers more stability when retrieving the cable.

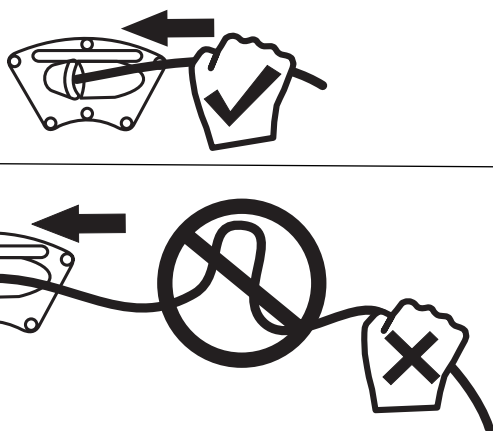

Figure 30

Cleaning Instructions

⚠ WARNING

Make sure that the system cable is disconnected from the CCU prior to cleaning to reduce the risk of electrical shock.

Clean the microEXPLORER Camera monitor or CCU as per its operators manual. Prior to cleaning the microReel, remove the microEXPLORER Camera monitor from the display cradle. Do not allow the microEXPLORER Camera monitor or CCU to get wet during cleaning.

The microReel System can be cleaned by wiping with a soft, damp cloth. Do not use any solvents to clean the microReel System. They can damage the unit. If desired, a disinfectant can be used on the microReel System.

The drum and cable may be removed and the interior of the drum cleaned with a hose or pressure wash. The outside of the drum can be cleaned by wiping with a soft, damp cloth. Avoid hosing the contact board on the back of the drum.

Accessories

⚠ WARNING

The following accessories have been designed to function with the microReel System. Other accessories suitable for use with other equipment may become hazardous when used with the microReel System. To reduce the risk of serious injury, only use accessories specifically designed and recommended for use with the microReel System, such as those listed below.

Catalog #	Description
33108	microReel/microDrain Interconnect Cable (SS CCU version)
33113	microReel/microDrain Interconnect Cable (mEXP CCU version)
35338	microReel L100 Ball Guides (2 pack)
34878	microReel/microDrain microEXPLORER Dock
35113	microDrain D30 Drum Only
35123	microDrain D30S Drum Only w/Sonde
34623	US microReel L100 Drum Only w/Sonde
34628	EU microReel L100 Drum (230V)
35243	US microReel L100C Drum Only w/Sonde + Counter
35248	EU microReel L100C Drum Only (230V)
Various	RIDGID SeekTech® or NaviTrack® Locators
Various	RIDGID SeekTech® or NaviTrack® Transmitters
Various	RIDGID SeeSnake Camera Control Units
30063	RIDGID microEXPLORER Digital Inspection Camera
33103	MicroDrain Reel (microEXPLORER NTSC)
33138	MicroDrain Reel (microEXPLORER PAL)

Transport And Storage

Do not expose to heavy shocks or impacts during transport. If storing for an extended period, remove batteries. Store in environments within temperature range of -4°F to 158°F (-20°C to 70°C).

Service And Repair

⚠ WARNING

Improper service or repair can make the microReel unsafe to operate.

Service and repair of the microReel System must be performed by a RIDGID Independent Authorized Service Center.

For information on your nearest RIDGID Independent Service Center or any service or repair questions.

Disposal

Parts of the microReel System contain valuable materials and can be recycled. There are companies that specialize in recycling that may be found locally. Dispose of the components in compliance with all applicable regulations. Contact your local waste management authority for more information.



Do not dispose of electrical equipment with household waste!

According to the European Guideline 2002/96/EC for Waste Electrical and Electronic Equipment and its implementation into national legislation, electrical equipment that is no longer usable must be collected separately and disposed of in an environmentally correct manner.

Chart 1 Troubleshooting

PROBLEM	PROBABLE FAULT LOCATION	SOLUTION
Camera video image not seen.	No power to SeeSnake CCU or microEXPLORER Camera monitor connector. Connections faulty. Monitor set to wrong source. Batteries low.	Check power is correctly plugged in. Check switch on monitor/display unit. Check alignment and pins of connection to microReel System unit from camera control or display unit. Check orientation, seating, and pin condition in the SeeSnake connection. Set video source as described in display unit manual. Recharge or replace batteries.
SOS blinking on LCD. (Some SeeSnake CCUs.)	No video signal.	Check source setting of monitor and re-seat cable connection.



99 Washington Street
Melrose, MA 02176
Phone 781-665-1400
Toll Free 1-800-517-8431

Visit us at www.TestEquipmentDepot.com