

5 Commonwealth Ave
Woburn, MA 01801
Phone 781-665-1400
Toll Free 1-800-517-8431

Visit us at www.TestEquipmentDepot.com



USER MANUAL

Si-CA 030 GAS ANALYZER



Table of contents

1. Safety instructions.....	5
1.1 Warnings.....	5
1.2 Environment protection	5
1.3 Symbols used	5
2. Introduction	6
2.1 Analyzer description	6
2.2 Main features.....	7
3. First Start-up	9
4. Features	10
4.1 General features.....	10
4.2 Dimensions	10
4.3 Parameter specifications	11
5. Perform a flue gas analysis.....	12
5.1 Prepare the instrument before the analysis.....	12
5.2 Perform a gas analysis	12
5.3 Perform a draft measurement	13
5.3.1 Perform a draft measurement with the flue gas probe	13
5.3.2 Perform a draft measurement with the draft probe	13
5.4 Save the analysis	13
5.5 Print the analysis results	13
6. Set the general parameters of the analyzer.....	14
6.1 Set the time	14
6.2 Set the time zone	14
6.3 Set the date	14
6.4 Set the language	14
6.5 Set the country.....	14
6.6 Set the autozero.....	14
6.7 Set the purge time.....	15
6.8 Set the brightness of the screen.....	15
7. Set the parameters of the analysis	16
7.1 Set the fuel	16
7.1.1 Create a fuel	17
7.2 Set the CO pump cut-off level.....	17
7.3 Set the Reference O ₂	17
7.4 Set the NOx factor.....	18
7.5 Set the Smoke/soot index	18
7.6 Set the alarms	18
7.7 Zero draft sensor	19
7.8 Set the atmospheric pressure	19
7.9 Set the air temperature.....	19
7.10 Set the display configuration.....	20
8. Set the measuring unit.....	21
9. Set the printer	22
9.1 Set the printer connection.....	22
9.2 Set the number of copies.....	22
10. Analyzer information.....	23
10.1 Service and Calibration	23
10.1.1 Calibration information.....	23
10.1.2 Service center contact.....	23
10.1.3 Perform calibration	23
10.2 Gas sensor information.....	23

10.3 Other information.....	24
11. Perform other measurements.....	25
11.1 Perform a CO monitoring.....	25
11.2 Heat exchanger integrity test.....	25
11.3 Perform a measurement of smoke/opacity.....	25
11.3.1 Perform the measurement.....	25
12. Maintenance of the analyzer.....	26
12.1 Life-time of the sensors.....	26
12.2 Replace used sensor.....	26
12.3 Cleaning the analyzer.....	26
12.4 Replace filter inside the water trap.....	27
13. Optional accessories.....	28
14. Spare parts.....	29

1. Safety instructions

Before using the device, please read carefully this user manual. It delivers important information about the device operations, maintenance and storage.

1.1 Warnings

- Interior or exterior use.
- Do not expose the probe tip to an open flame.
- Control device sealing with the probe.
- Respect the range of the device measurement (0 to 60 bar).
- After measurement and before clearing the device and accessories, wait for the probe to cool down. A hot probe can cause burns.
- Condensate contains a low level of acidity, do not touch directly the condensate. Make sure no condensate is leaking into the device.
- This device has been developed for the measurement of flue gas parameters. It must not be used in any other purpose.
- This device has been developed, produced and sold exclusively to trained and qualified experts in the field of HVACR and combustion emissions monitoring. Appropriate training might be necessary in order to guarantee a riskless use of this instrument. Sauermann is not responsible for any possible accident during its use.
- Please always use the device in accordance with its intended use and within parameters described in the technical features in order not to compromise the protection ensured by the device.
- When using the device, the safety of the system integrating the device is the responsibility of the system assembler.
- This device can pose a risk for wearers of pacemakers. Respect a distance of at least 10 cm (4") between the device and the wearer.
- Respect a safety distance with other electronic apparel like computers, credit cards, computer or TV screens which could be damaged by the magnetic field of the apparel.
- Only the accessories provided with the device or available as an option must be used.
- Do not use the device if it is damaged or if it operates abnormally. Inspect the device before every use. In case of doubt, please contact Sauermann's After-sales service.
- Do not authorize pressures beyond the device limits. Please refer to the technical features described in this user manual.
- The device must not be exposed to rain or any other humid environments (> 85 %RH).
- Do not use the device next to explosive and corrosives gases, vapour or dust.
- Do not place your fingers in movable zones of the device (articulations).
- The device must not be used in ATEX zones according to applicable standards.
- Do not store the device with solvents. Do not use desiccants. Do not use isopropanol.
- Do not obstruct the ventilation outflows of the device.
- During use, keep inspecting the device and accessories for effective operation and your own safety.
- Do not give this product to a child.
- If the device falls or in case of similar inconveniences, or if an irregular malfunction appears, please send back the device to Sauermann After-sales service for a technical check and to ensure your own safety.
- If the battery or a cell leaks, be sure to remove it wearing protective gloves. Respect the legislation in force on the treatment of electronic waste.

1.2 Environment protection

Send back the device at its end of working life to a waste collection center for electrical and electronic components (according to local regulations), or send it back to Sauermann to ensure a required waste collection in the respect of the environment.

1.3 Symbols used

For your safety and in order to avoid any damage of the device, please follow the procedure described in this user manual and read carefully the notes preceded by the following symbol:



The following symbol will also be used in this user manual:

Please read carefully the information notes indicated after this symbol.



2. Introduction

2.1 Analyzer description

The Si-CA 030 is a flue gas analyzer for emissions monitoring of boiler, engine, & other combustion applications with two or three gas sensors. Its main features are the following :

- Gas sensor options include O₂, CO, NO
- Draft/pressure measurements
- Large color screen
- Calculated values include combustion efficiency ,excess air and CO₂
- Mobile phone App for remote display and control

 **This gas analyzer is designed to measure parameters of flue gas in exhaust stream of combustion equipment. It can not be used in a permanently way and/or used as an alarm system.**



1. Handle
2. Positioning cone (Adjustable)
3. Flue gas probe
4. Large color screen
5. Up key
6. Down key
7. OK key
8. Menu key
9. On/off key



1. Min-DIN connection for optional CO and CO₂ ambient air probes
2. Thermocouple connection for air temperature
3. Thermocouple connection for flue gas temperature
4. P- connection
5. P+ connection
6. Gas connection (Coming from water trap)
7. USB connection

2.2 Main features

• Screen

Color screen, 7.1 cm (2.8"), 320 x 240 pixels with backlight. It allows to display measured parameters in a more comfortable format for the operator.

• Battery charger

The instrument is supplied with a 5 V, 2 A power adapter to charge the internal batteries. The current loading is indicated by a battery symbol on the top right of the screen. To ensure a complete charge, the battery charging time is 6.5 hours. The voltage of the power supply is 100-240 VAC, 50/60 Hz. The USB cable included with the analyzer connects the power supply to the device.

• Flue gas suction pump

The pump, inside the gas analyzer, is a diaphragm pump with a motor. It is energized in direct current directly by the instrument in a way to get an optimal suction of flues gases.

• Flue gas probe

Probe in stainless steel with a handle in plastic, with a standard length of 18 or 30 cm (7" or 12") and with an adjustable positioning cone to maintain the contact tip inside the duct. The probe is connected to the instrument by 2 or 3 m (6.6' or 10') of dual hose. Other probe lengths (including 75 cm) are available as options.

• Interchangeable measurement sensors

The analyzer uses electrochemical sensors to measure the oxygen (O₂) and the carbon monoxide (CO) and nitric oxide (NO). Regularly recharge the battery to guarantee an optimal operating of the electrochemical sensors. It is absolutely necessary to avoid falling to 0% battery as this would irreversibly damage the cells.

• Temperature sensors

Flue gas temperature is measured with a thermocouple integrated in the contact tip. The connection to the analyzer is made thanks to a single male type K thermocouple (nickel-nickel chromium) connector for measurements up to 1250 °C (2282 °F).

The instrument has a NTC thermoresistance sensor for the measurement of internal temperature; this sensor is also used for the measurement of ambient temperature.

If a temperature control of the combustive air must be performed directly by the supply duct (e.g. room sealed boiler), a TcK temperature probe can be used. It is recommended to perform this measurement to make the efficiency calculation of the installation more precise.

• Pressure sensors

The standard semiconductor type pressure sensor can measure draft and differential pressure (deltaP) for a range of ±200 mbar (±80 in WC).

• Supply input of flue gases and +/- pressure

There are two hose connections to the bottom of the analyzer. One comes from the water trap assembly and connects to the gas inlet (labelled "G" and colored black) while the other connects to the high pressure inlet (labelled "P+" and colored orange).

• Fuel types

The analyzer is supplied with technical data which characterizes the most common fuels. It is also possible to add user defined fuels and their corresponding coefficients if needed.

• Calibration certificate

The analyzer is calibrated by comparison with standard of metrology laboratories, which are periodically certified closed to laboratories known at the international level. Each analyzer is supplied with its calibration certificate in which, for each measured parameter, are indicated the nominal value, the one measured, the admitted error limits and the found error.

• Conformity and standards

The analyser complies with 2015/863 EU (RoHS 3). Document available on request. Moreover, the analyser complies with EN 50379-1 and EN 50379-2, UNI 10389, UL & cUL Certification, BS 7967:2015, BS EN 50543:2011, UNE 60670-10 and ES.02173.ES.

Hereby, Sauermann Industrie SAS declares that the radio equipment type Si-CA 030 is in compliance with Directive 2014/53/EU. The full text of the EU declaration of conformity is available at the following internet address:

www.sauermanngroup.com

• Water trap

The analyzer has an external water trap assembly that hangs directly below the analyzer. The flue gas is cooled and dried in the lower chamber. Accumulated condensate must be manually drained as needed. The upper chamber has a filter cartridge to remove dust and particulates from the flue gas. The filter should be replaced periodically as needed.



THE WATER TRAP MUST BE IN VERTICAL POSITION AT ALL TIMES DURING OPERATIONS FOR OPTIMAL PERFORMANCE!

The water trap must be emptied before storing it in the transport case.

• Measured and calculated values

The following parameters are displayed according to your analyzer model:

- **O₂**: Direct O₂ sensor measurement (also for Heat Exchanger Test)
- **CO**: Direct CO sensor measurement (also for Heat Exchanger Test)
- **NO**: Direct NO sensor measurement
- **NO_x**: Calculated NO_x value
- **CO(O₂)**: Corrected CO sensor measurement for chosen O₂ Ref. level
- **NO(O₂)**: Corrected NO sensor measurement for chosen O₂ Ref. level
- **CO₂**: Calculated CO₂
- **Eff. (η)**: Net Combustion Efficiency
- **Eff. (η+)**: Gross Combustion Efficiency
- **Loss (Q)**: Stack Heat Losses (net)
- **Loss (Q+)**: Stack Heat Losses (gross)
- **CE (η_c)**: Condensation efficiency calculated according to the UNI 10389-1 standard
- **X Air**: Calculated excess air
- **Lambda**: Calculated lambda value (for air to fuel ratio)
- **Air Ind (n)**: Calculated air index
- **CO:CO₂**: Calculated CO to CO₂ Ratio, also called poison index
- **ΔP**: Differential pressure (also for Gas Tightness Test)
- **Draft**: Draft (stack static pressure) measurement
- **T flue**: Flue gas temperature
- **T air**: Air temperature
- **ΔT**: Differential temperature
- **T dp**: Calculated dew point temperature
- **CO AF**: Calculated CO Air Free = CO corrected for 0.0% O₂ Ref. level
- **COcorr**: Calculated value for Corrected CO = Lambda x Measured CO
- **CO Amb**: Ambient CO measurement using external probe
- **CO₂ Amb**: Ambient CO₂ measurement using external probe
- **CO Monitor (Current & Max)**: CO measurement for room safety
- **Pump Flow Rate**: Measured flow rate of flue gas through the analyzer
- **ΔO₂**: O₂ Variance during Heat Exchanger Integrity Test
- **ΔCO**: CO Variance during Heat Exchanger Integrity Test
- **O₂ Reference**: Input for O₂ Reference Level
- **Smoke/Soot**: Smoke index value
- **Atmospheric Pressure**: Input for Atmospheric Pressure



DO NOT insert the gas probe in the flue/chimney/stack. Keep  pressed for 3 seconds to turn on the analyzer.



Press Down key to go to "Start" then press OK.



Select your country pressing Up and Down keys and validate with OK.



Select your language pressing Up and Down keys and validate with OK.

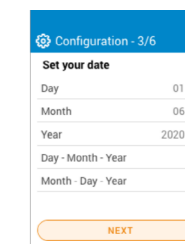

Set the date pressing OK on each line, use Up and Down keys to select the correct item and validate with OK then go to "Next".

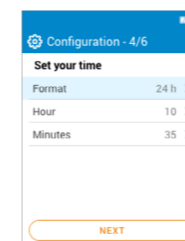

Set the time pressing OK on each line, use Up and Down keys to select the correct item and validate with OK then go to "Next".

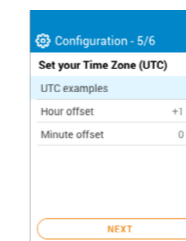

Set your time zone pressing OK on each line, use Up and Down keys to select the correct item and validate with OK then go to "Next".

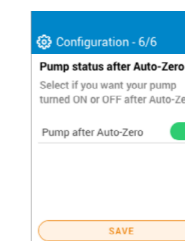

Select if you want your pump turned ON or OFF after Auto-Zero pressing OK then go to "Save".

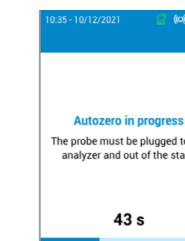

Autozero is in progress.

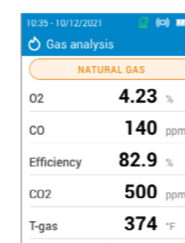

The probe can be inserted in the chimney. The analyzer displays the measurements.



The settings done during the first start-up can be reselected at a later time using the Settings menu.

4. Features

4.1 General features

Dimensions	19.4 x 9.9 x 4.9 cm (7.5 x 3.5 x 4.9")
Weight	350 g (12 oz)
Display	Color display screen; Size: 320 x 240 pixels
Keypad	5 keys
Material	ABS-PC
Protection	IP42
Connection	Wireless: class 2 range, range frequency from 2402 MHz to 2480 MHz with a transmit power of 1 dBm. Range up to 15 m (50 ft), depending on smartphone radio strength. Minimum required versions: Android 8.0, iOS 12.4, BLE 4.0 Low Energy USB
Power supply	Rechargeable battery, USB power supply Li-Ion 5100 mA/h 3.6 V battery / Power supply voltage of the mains unit: 100-240 Vac, 50-60 Hz Mains unit: 5 Vdc/2A
Battery	Battery life > 8 h; Charging time: Fully charge: < 6.5 h; 50%: < 2.5 h
Environmental conditions of use	Temperature: from -5 to 45 °C (23 to 113 °F), Hygrometry: in non-condensing conditions (< 85% RH) Maximum altitude: 2000 m (6561')
Storage temperature	From -20 to 50 °C (-4 to 122 °F)
Languages	English, French, German, Spanish, Italian, Dutch, Portuguese, Chinese
European Union Directives	2014/53/EU (RED); 2015/863 EU (RoHS 3)
Regulations	EN 50379-1 and EN 50379-2; UNI 10389; UL & cUL Certification; BS 7967:2015; BS EN 50543:2011; UNE 60670-10; ES.02173.ES

4.2 Dimensions

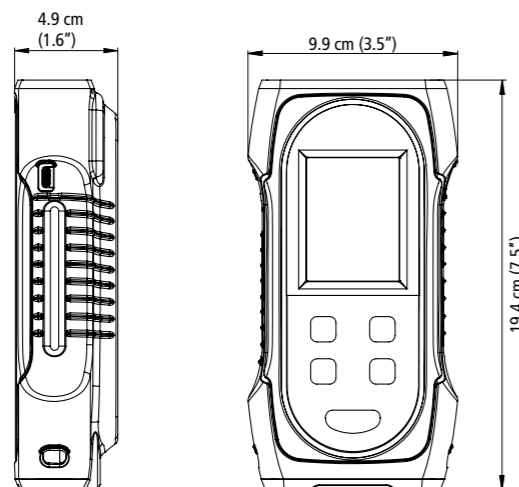

4.3 Parameter specifications

Parameter	Sensor	Measuring range	Resolution	Accuracy ¹	Response time
O ₂	Electrochemical	0 to 25%	0.01%	±0.2% vol	T ₉₀ < 30 s
CO	Electrochemical	0 to 8000 ppm	1 ppm	±8 ppm < 160 ppm ±5% rdg up to 2000 ppm ±10% rdg > 2000 ppm	T ₉₀ < 40 s
CO ₂	Calculated	0 to 99.9%	0.1%	-	-
NO	Electrochemical	0 to 5000 ppm	1 ppm	±5 ppm < 100 ppm ±5% rdg > 100 ppm	T ₉₀ < 40 s
NO _x	Calculated	0 to 7500 ppm	1 ppm	-	-
Flue temperature	TcK	-20 to +1250 °C -4 to +2282 °F	0.1 °C 0.1 °F	±2 °C or ±0.5% rdg ² ±3.6 °F or ±0.5% rdg ³	-
Air temperature	NTC or TcK	-20 to +120 °C -4 to +248 °F	0.1 °C 0.1 °F	±2 °C ±3.6 °F	-
Differential temperature	Calculated	0 to 1250 °C 0 to 2282 °F	0.1 °C 0.1 °F	-	-
Pressure/Draft	Semiconductor	-200 to +200 mbar -80 to +80 inH ₂ O	0.01 mbar 0.001 inH ₂ O	±1% rdg ±0.03 mbar ±1% rdg ±0.012 inH ₂ O	-
Excess air	Calculated	0 to 999%	1%	-	-
Efficiency	Calculated	0 to 100% (Gross/HHV ⁴)	0.1%	-	-
Efficiency (condensation)	Calculated	0 to 125% (Net/LHV ⁵)	0.1%	-	-

¹ All accuracies indicated in this document were stated in laboratory conditions at 20 °C (68 °F) and can be guaranteed for measurement carried out in the same conditions.

² Accuracy given for the analyzer only.





³ Accuracy given for the analyzer only.

⁴ For Higher Heating Value

⁵ For Lower Heating Value

5. Perform a flue gas analysis

5.1 Prepare the instrument before the analysis

-  During the measurement, the analyzer must be in vertical position to keep the water trap vertical. Do not hold the analyzer in inclined or horizontal position.
-  Before the 1st use of the analyzer, a full charge of the battery should be made for 12 hours.
-  Empty the water trap if any condensate is inside it.
-  In case of any default or damage of the instrument, Sauermann After-sales service shall be contacted. On the back of the analyzer, there is a label with the analyzer serial number. This number shall be communicated for every operation (technical operation or request of spare parts). This number is also available in "Analyzer information" menu (see page 23).

5.2 Perform a gas analysis

- Connect the flue gas probe to the analyzer. (Two hoses + thermocouple)
- Turn ON the instrument.
- Wait for the end of the autozero cycle.

Gas analysis screen is displayed.

- Insert the probe in the flue/stack as suggested on the figure.

- Press Menu icon .

The screen with the different possible item menu is displayed.

- Go to "Gas analysis" and validate with OK.

The screen displays the measured values.

- Go to the name of combustible fuel currently used on the top of the screen and press OK.

The list of available combustibles is displayed .

- Select the required combustible fuel and back to the Gas Analysis screen with Menu key.

The screen displays values of the different parameters of the analysis.

- Perform measurement for at least 3 minutes until measurements stabilize.

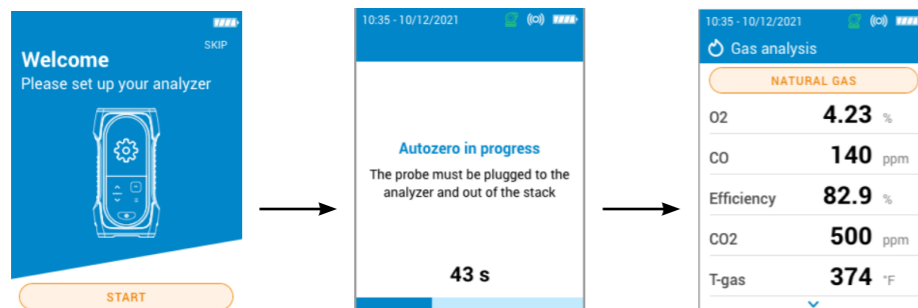
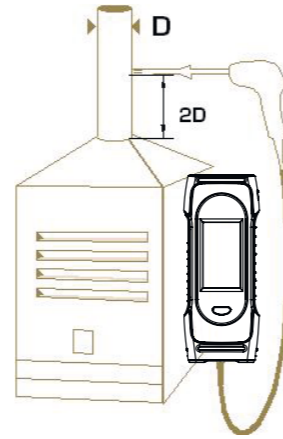

-  It is recommended to purge the analyzer with fresh air for at least 10 minutes after each use before completely shutting off the analyzer.

5.3 Perform a draft measurement

During the flue gas analysis, the analyzer can measure the draft. This draft can be measured by the flue gas probe or the draft probe.

5.3.1 Perform a draft measurement with the flue gas probe

- Disconnect the water trap connector from the gas connection of the analyzer.
- Plug the water trap connector with the blue cap.

The analyzer displays the draft without the influence of the main pump.

5.3.2 Perform a draft measurement with the draft probe

The draft measurement can be performed thanks to the draft probe available as option.

-  If the draft probe is used, it will be necessary to drill another hole dedicated to this draft measurement in the duct.

- Disconnect the P+ connector of the flue gas probe from the analyzer.
- Connect this connector to the blocked connection of the draft probe.
- Connect the orange connector of the draft probe to the P+ connection of the analyzer.
- Insert the draft probe into the duct.

5.4 Save the analysis

During the combustion gas analysis, when measurements are constant, it is possible to save the gas analysis data to a previously created data folder or to a newly created folder. To save data, use the Sauermann Combustion app.

5.5 Print the analysis results



It is possible to print the results on the ticket with the optional printer accessory.

The printer must be connected via the wireless connection to the analyzer. See page page 22 to connect and set up the printer.

6. Set the general parameters of the analyzer

The Settings menu allows to set the general parameters of the analyzer:

- Time
- Time zone
- Date
- Language
- Country
- Wireless connection
- Autozero
- Purge time
- Brightness

 Any changes made to settings are automatically saved when you exit the screen with menu icon 

6.1 Set the time

“Settings > General” screen is displayed.

- Go to “Time” and press OK.
- Select the hour format (24 hours and AM or PM) with arrow keys and validate with OK.
- Set hour and minute with arrow keys and validate with OK.

6.2 Set the time zone

“Settings > General” screen is displayed.

- Go to “Time Zone” and press OK.
- Set the hour offset and minute offset with arrow keys and validate with OK.

6.3 Set the date

“Settings > General” screen is displayed.

- Go to “Date” and validate with OK.
- Press OK on “Day” line.
- Use arrow keys to select the day and press Menu key.
- Repeat the procedure for “Month” and “Year” lines.
- Press OK on line “Month-Day-Year” or “Day-Month-Year” to select your date format.

6.4 Set the language

“Settings > General” screen is displayed.

- Go to “Language” and validate with OK.
- Go to the required language among English, French, Spanish, Italian, German, Portuguese and Chinese and validate with OK.

6.5 Set the country

“Settings > General” screen is displayed.

- Go to “Country” and validate with OK.
- Go to the required from available list. If desired country is not on list, then select area of the world (EMEA, AMERICAS, APAC) show at the bottom of the country list and validate with OK.

6.6 Set the autozero

This part allows to set the autozero duration.

“Settings > General” screen is displayed.

- Go to “Autozero” and validate with OK.
- Go to the required autozero duration: 30 s, 60 s, 120 s or 180 s and validate with OK.

 The manufacturer recommendation is a minimum of 60 seconds for most applications.

6.7 Set the purge time

This part allows to set the purge time duration.

“Settings > General” screen is displayed.

- Go to “Purge time” and validate with OK.
- Go to the required purge time duration: 15 s, 30 s, 60 s or 120 s and validate with OK.

6.8 Set the brightness of the screen

“Settings > General” screen is displayed.

- Go to “Brightness” and validate with OK.
- Press OK to activate or deactivate the brightness.
- Press Menu button to save selection and exit screen.

7. Set the parameters of the analysis

This menu allows for settings the following items regarding the analysis:

- Fuel
- CO pump cut-off level
- Reference O₂
- NOx factor
- Smoke/soot
- Alarms
- Pump after autozero
- Zero draft sensor
- Atmospheric pressure
- Air temperature
- Display configuration

 Any changes made to settings are automatically saved when you exit the screen with menu icon 

7.1 Set the fuel

This part allows to select the required fuels for the gas analysis but it also allows to add customized fuels. The default list of fuels is dependent on the country selected. Possible fuels listed include the following:

- Natural Gas (B)
- Natural Gas (H)
- Natural Gas (L) Groningue
- Natural Gas North America
- #2 Oil / Domestic
- #3 Oil / Heavy
- #6 Oil / RFO
- Propane
- Butane
- LPG
- Biofuel 5%
- Diesel
- Coke Gas
- Biogas
- Firewood 20% (Soft)
- Firewood 50% (Soft)
- Firewood 20% (Hard)
- Firewood 50% (Hard)
- Wood Chips / Pellets 8%
- Cannel Coal
- Low Volatile Coal
- Hog Fuel
- Peat
- Biomass

"Settings > Analysis" screen is displayed.

- Go to "Fuel" and press OK.
- Go to the required fuel and press OK.

The following information about the fuel is displayed: A1, B, K, CO₂t(%), V dry gas (m³/ucb), M air (kg/ucb), MH₂O (kg/ucb) and PCI (MJ/ucb).

- Press OK to tick the "Select fuel" box.

7.1.1 Create a fuel

It is possible to create up to five customized fuel.

"Settings > Analysis" screen is displayed.

- Go to "Fuel" and press OK.
- Press Up key to go to "Add fuel" on the top of the screen and press OK.
- With Up and Down keys, enter the following features of the fuel: A1, B, K, CO₂t(%), V dry gas (m³/ucb), M air (kg/ucb), MH₂O (kg/ucb) and PCI (MJ/ucb).
- Go to Next and press OK to advance to next fuel coefficient screen.
- Go to Save and press OK to save the fuel.

The customized fuel is then integrated at the end of the fuel list.

 If a very specific fuel must be created, please contact the Sauermann Service Center for further information.

A customized fuel can be deleted:

- Go to the name of the customized fuel on the fuel list and press OK. Features of this fuel are displayed.
- Go to "Delete" on the top of the screen and press OK.

7.2 Set the CO pump cut-off level

This part allows to define the CO pump cut-off level. The pump will turn off when the measured CO exceeds this threshold to protect the CO sensor from over-saturation.

"Settings > Analysis" screen is displayed.

- Go to "CO pump cut-off level" and press OK.
- Use arrow and OK keys to enter the required level between 1000 and 8000 ppm.
- Press Menu button to save value and exit screen.

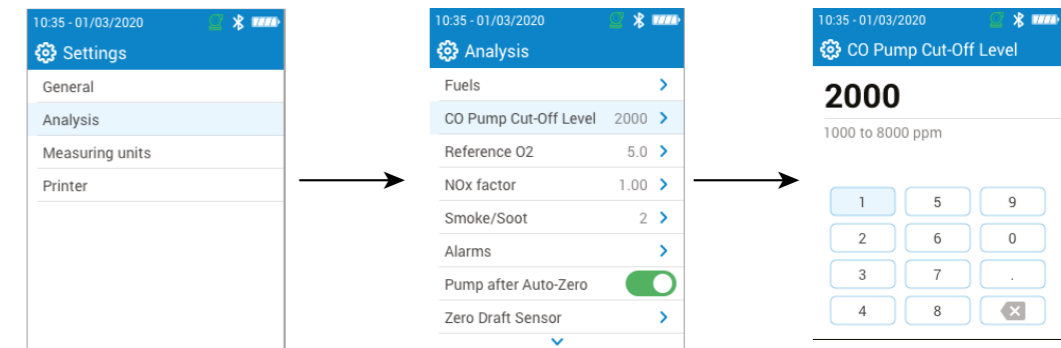

7.3 Set the Reference O₂

This part allows to set the oxygen reference level to use when corrected emissions calculations are needed.

"Settings > Analysis" screen is displayed.

- Go to "Reference O₂" and press OK.
- Use arrow and OK keys to enter the required reference O₂ in percentage between 0.0 and 20.9%.
- Press Menu button to save value and exit screen.

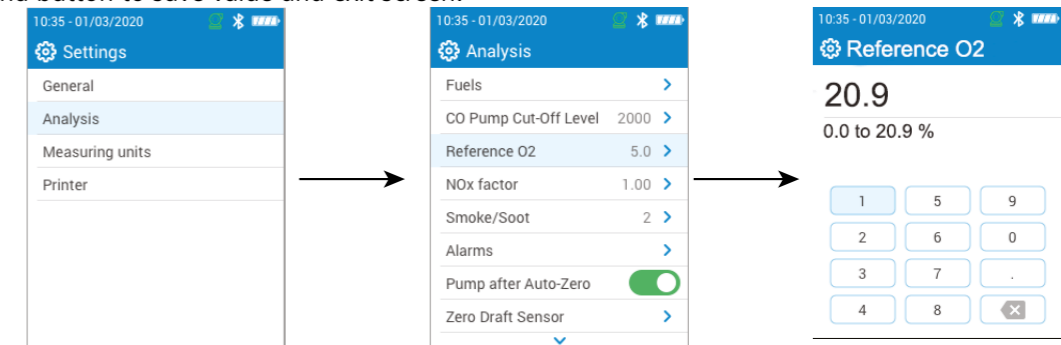

7.4 Set the NOx factor

This part allows to set the NOx factor, which is the assumed NO to NO₂ ratio used to calculate NOx.

"Settings > Analysis" screen is displayed.

- Go to "NOx factor" and press OK.
- Use arrow and OK keys to enter the required NOx factor in percentage between 1.00 and 1.50.
- Press Menu button to save value and exit screen.

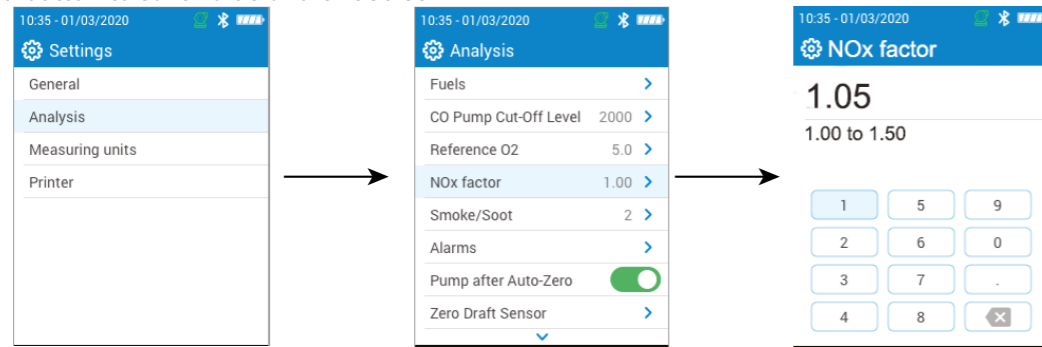

7.5 Set the Smoke/soot index

This part allows to enter the smoke or soot index obtained with an external pump (available as option). An inputted smoke value will be included with saved data points.

"Settings > Analysis" screen is displayed.

- Go to "Smoke/soot" and press OK.
- Use arrow and OK keys to enter the smoke/soot index between 0 and 9.
- Press Menu button to save value and exit screen.

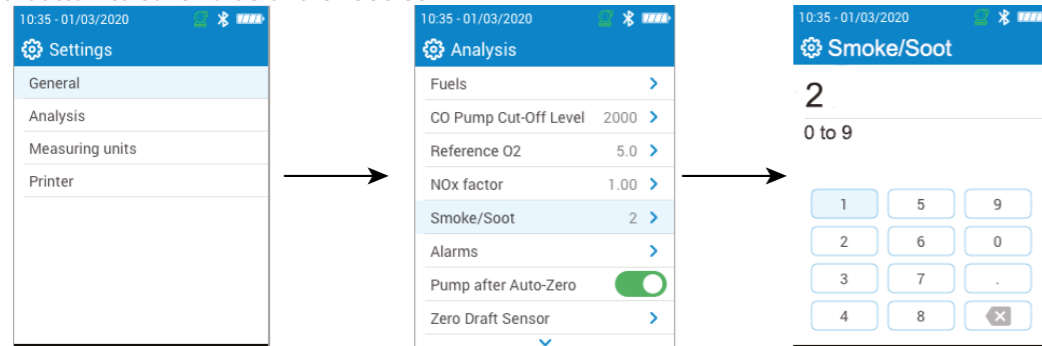

7.6 Set the alarms

This part allows to set an alarm for every parameters measured and calculated by the analyzer.

This alarm can be rising (the alarm of the instrument is activated when the measured value exceeds the defined threshold) or falling (the alarm of the instrument is activated when the measured value is below the defined threshold).

A maximum of 5 different alarms can be set.

"Settings > Analysis" screen is displayed.

- Go to "Alarms" and press OK.
- Go to one of the five listed alarms to first set it up and press OK.
- Go to "Parameter" line and press OK.
- Go to the parameter in which the alarm will be activated and press OK.
- Go to "Value", press OK and enter the value with arrow and OK keys.
- Press Menu key.
- Select either high threshold or low threshold alarm.
- Repeat the procedure for other alarms as needed.
- Press OK on "Activate" line to activate the alarm.

Alarms can be revised later (for example, different threshold value) if needed.

i During the measurements, an alarm remains ON even if the measurement goes below or above the threshold value until it is acknowledged.

If the alarm is acknowledged and the value is always in alarm, the alarm remains ON.

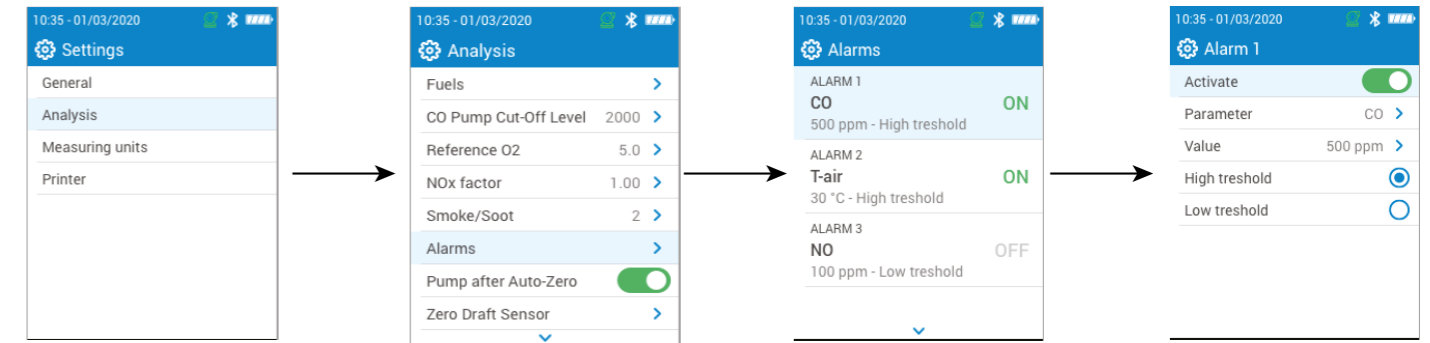

7.7 Zero draft sensor

This part allows to re-zero the draft sensor.

"Settings > Analysis" screen is displayed.

- Go to "Zero Draft Sensor" and press OK.
- Remove the smoke probe from the stack and leave the analyzer pressure connectors free of use.
- Press OK to launch the auto-zero of the draft/pressure sensor.

The analyzer re-zeroes the draft sensor.

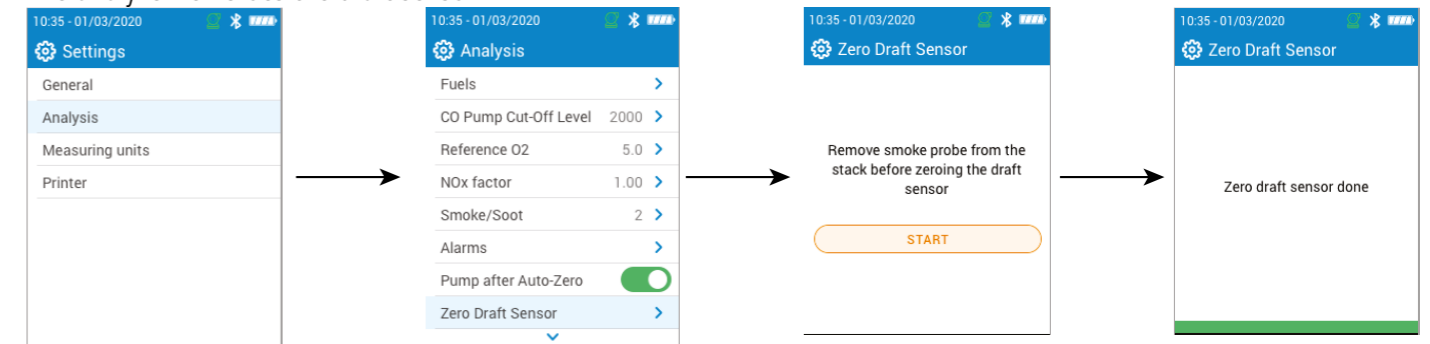

7.8 Set the atmospheric pressure

This part allows to set the atmospheric pressure in which measurements are performed. This value is taken into account in calculations such as the smoke velocity. It is set to 1013 mbar by default.

"Settings > Analysis" screen is displayed.

- Go to "Atmospheric pressure" and press OK.
- Use arrow and keys to set the atmospheric pressure between 500 and 1100 mbar.
- Press Menu button to save value and exit screen.

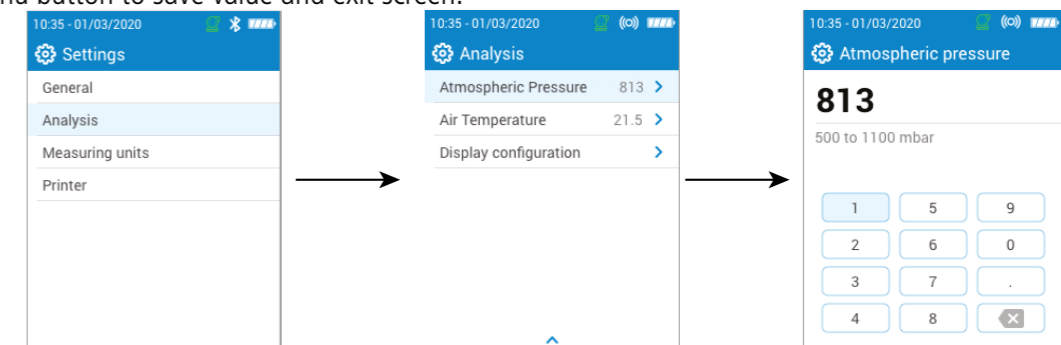

7.9 Set the air temperature

This part allows to set the air temperature for the incoming air into the combustion equipment if known.

This value is obtained by three different ways:

- by an external probe if this optional probe is connected
- entered by the user if no probe is connected
- by the internal NTC sensor of the analyzer if no probe is connected and if no value entered

To enter an air temperature:

"Settings > Analysis" screen is displayed.

- Go to "Air temperature" and press OK.

- Use arrow and keys to enter the required air temperature.
- Press Menu button to save value and exit screen.

If the external probe or the internal sensor sensor is used, just activate the air temperature.

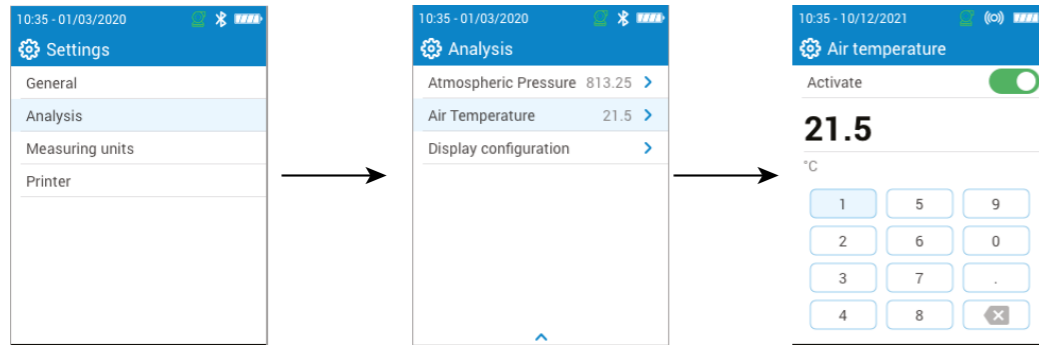

7.10 Set the display configuration

This section is used to organize the display of values on the gas analysis screen.

“Settings > Analysis” screen is displayed.

- Go to “Display configuration” and press OK.
- Go to the parameter boxes for the parameters that are to be shown on the gas analysis screen.
- Use up and down arrows to move values up or down on the gas analysis screen to put the parameters in the desired segmental order.

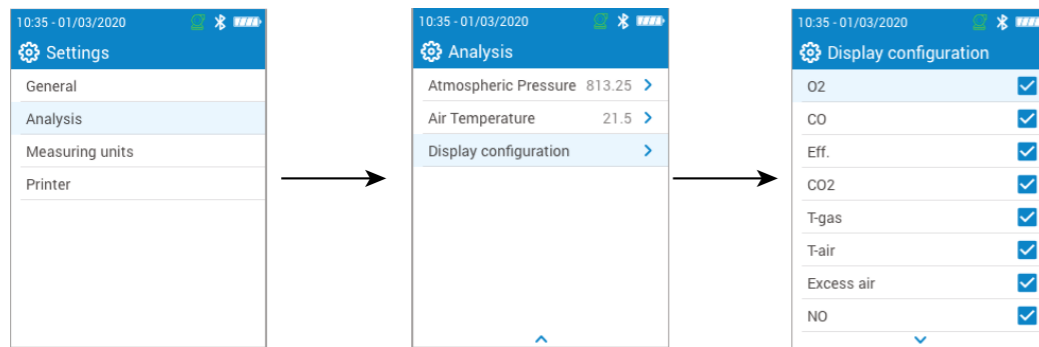

8. Set the measuring unit

This part allows to define the measuring unit for each parameter measured or calculated by the analyzer.

The following unit is available according to the parameter:

- Temperature: °C, °F
- Pressure: mbar, iwG (inches water gauge), mmwg, mmHg, Pa, hPa, kPa, psi
- Gas concentrations: ppm, mg/m³, %, mg/kWh, g/GJ, g/m³, g/kWh, g/hp
- Excess air: %, --- (ratio)

“Settings” screen is displayed.

- Go to “Measuring units” and press OK.
- Go to the required parameter to set and press OK.
- Select the required unit in the list using arrow keys and validate with OK.
- Press Menu to save selection and exit screen.

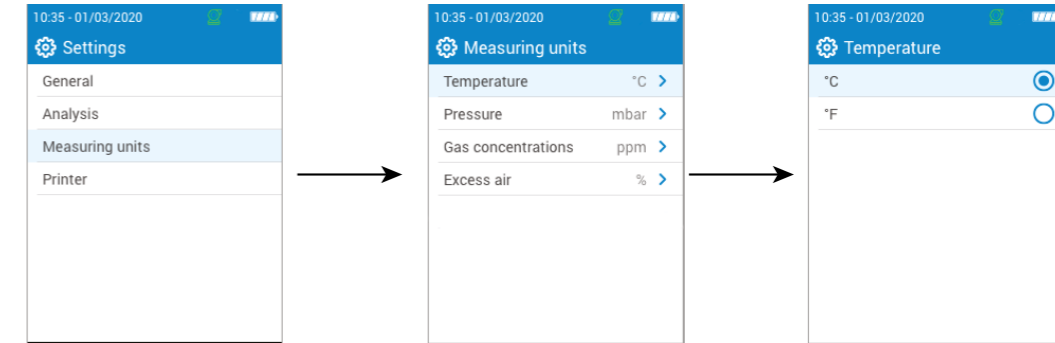

9. Set the printer

This part allows for settings the printer specifications: printer connection, custom header and number of copies.

This printer is available as option.

9.1 Set the printer connection

"Settings > Printer" screen is displayed.

- Turn on your wireless printer.
- Go to "Printer" and press OK.
- Go to "Printer connection" and press OK.
- Activate the "Wireless printer mode" button.
- Go to "Search for printers" and press OK.

The analyzer searches for available printers and then displays the results.

- Go to the required printer and press OK.
- Go to "Connect" and press OK.



The analyzer can not be connected to the app or the printer at the same time. If the analyzer is connected to the app, disconnect it from the app and then search again for printers.

9.2 Set the number of copies

It is possible to set the number of copies that will be printed.

"Settings > Printer" screen is displayed.

- Go to "Number of copies" and press OK.
- Use up and down arrows to define the number of copies. Maximum number of copies is five.
- Press Menu button to save selection and exit screen.

10. Analyzer information

This part gives information about the analyzer:

- Service and Calibration
- Gas sensor information
- Model number
- Serial number
- Firmware version
- Battery status

10.1 Service and Calibration

10.1.1 Calibration information

This screen gives calibration information about gas sensors installed into the analyzer.

"Service / Calibration" screen is displayed.

- Go to "Calibration Information" and press OK.

The following information is displayed for each installed gas sensor that can be selected:

- Date of last service center calibration
- Date of last user calibration
- Due date of next service center calibration
- Go to "Contact Service Center" at the bottom of the screen and press OK, the address where the analyzer should be sent is displayed.

10.1.2 Service center contact

"Service / Calibration" screen is displayed.

- Go to "Service Center Contact" and press OK to display the contact information of the Sauer mann Service Center.

10.1.3 Perform calibration

This screen allows the user to perform a calibration on a gas sensor.



The calibration must be performed by a qualified technician.

"Service / Calibration" screen is displayed.

- Go to "Perform Calibration" and press OK.
- Enter the code to access to calibration.



To get your code, please contact the Service Contact. Our team will explain how to get this code.

- Go to the gas sensor on which the calibration must be applied and press OK.
- Enter the new reference value of the gas then go to "Apply span gas and Start" and press OK.

The analyzer performs the measurement and displays the following information:

- Measurement
- Sensor current
- Reference value
- Apply calibration span gas to analyzer. Once 'Measurement' stabilizes, press OK to "Validate Measurement".

10.2 Gas sensor information

This screen gives information about the gas sensors installed on the analyzer.

"Analyzer information" screen is displayed.

- Go to "Gas sensor information" and press OK.
- Go to the gas sensor on which information must be displayed and press OK.

The following information is displayed:

- Type of sensor
- Measuring range of sensor

- Date of last calibration
- Date of installation
- Output current (in units of micro amps)
- Sensor life estimation

10.3 Other information

Analyzer information screen also gives the following information:

- Model number
- Serial number
- Firmware version
- Battery status



Please provide the model number and serial number for contact with the manufacturer or the Service Center.

11. Perform other measurements

The analyzer can perform other measurements than a gas analysis:

- CO monitor
- Gas/pump flow rate
- Heat exchanger integrity test

11.1 Perform a CO monitoring

- Connect a CO probe (available as option) to the DIN connection on the bottom of the analyzer or use the internal CO sensor already installed in the analyzer.
- Turn on the analyzer.
- Press **"Menu"** then go to **"Other Measurements"** and press OK.
- Go to **"CO monitor"** and press OK.

The measurement is launched, the instrument displays the current level of CO, the maximum level of CO, and the duration of the test (max duration: 59 m 59 s). The maximum CO level and duration are reset each time the CO Monitor screen is entered.

11.2 Heat exchanger integrity test

This test provides information to help determine if there might be a crack or leak in the heat exchanger and/or combustion chamber.

"Other measurements" screen is displayed.

- Go to **"Heat Exchanger Integrity Test"** and press OK.
- Insert the sampling probe into the exhaust flue/pipe.
- Turn on the heating equipment (with the blower off) and let the O₂ & CO measurements stabilize on the analyzer screen.
- Press OK to start the Heat Exchanger Integrity Test on the analyzer before the blower turns on. Make sure the blower turns on during the first 30 seconds of the test period.

The results of the test will calculate the amount the O₂ and CO measurements varied during the 60 second test period. The greater the variances, the more likely there is to be a crack or abnormality with the heating system that should be investigated by a heating professional.

11.3 Perform a measurement of smoke/opacity

It is possible to enter in the analyser one smoke/opacity index performed thanks to opacity pump available as option. The smoke/opacity index consists of the measurement of solid waste of combustion in the flue with a pump and a filter of measurement. The filter coloration is compared with a table reference composed by 10 greyed areas numbered from 0 to 9.

11.3.1 Perform the measurement



Preliminary operation: to avoid the condensation in the pump, it is necessary to breathe in WITH-OUT FILTER fresh air before performing a measurement

- Put the paper filter in the pump.
- Pump out flue gas in the middle of the flue.

The necessary gas volume for a measurement of opacity corresponds to about 10 pump aspirations.

- Compare the filter clogging to the reference table to determine the smoke/opacity index.
- Make the same operation several times if necessary, replace the filter each time.

12. Maintenance of the analyzer

12.1 Life-time of the sensors

Gas sensors are electrochemical type: inside them, in the presence of gas to detect, a chemical reaction occurs that causes an emission of electrical current. The electric current strength detected by the instrument is converted into a corresponding gas concentration. The life-time of the sensor is strongly linked to the reagent consumption present in the sensor. As their consumption increases, features of the sensor are getting worse until their exhaustion, after which it is necessary to replace it. To ensure the measurement accuracy, sensors have to be calibrated only in Assistance center qualified by Sauermann.

Sensor	Average life-time	Required calibration
O ₂	4 to 5 years	Annual
CO	2 to 5 years	Annual
NO	2 to 5 years	Annual

 Regularly recharge the battery to guarantee optimal operations of the electrochemical sensors. Do not leave the instrument an empty battery charge. Make sure the battery is always charged even during a long period of non use.

12.2 Replace used sensor

Follow this procedure to replace a used sensor:
The analyzer must be turned OFF.

- Remove the protective rubber holster.
- Turn the analyzer on its back side.
- Open the analyzer by removing 4 screws with cruciform (Philips) screwdriver. The back shell can then be lifted up.
- Pull up white rubber cap with used sensor in it (1) off the electronic board (2).
- Remove the used sensor from the white rubber cap (3).
- Connect the new sensor (4) on the electronic board and put back the white rubber cap (5) until it touches the electronic board.

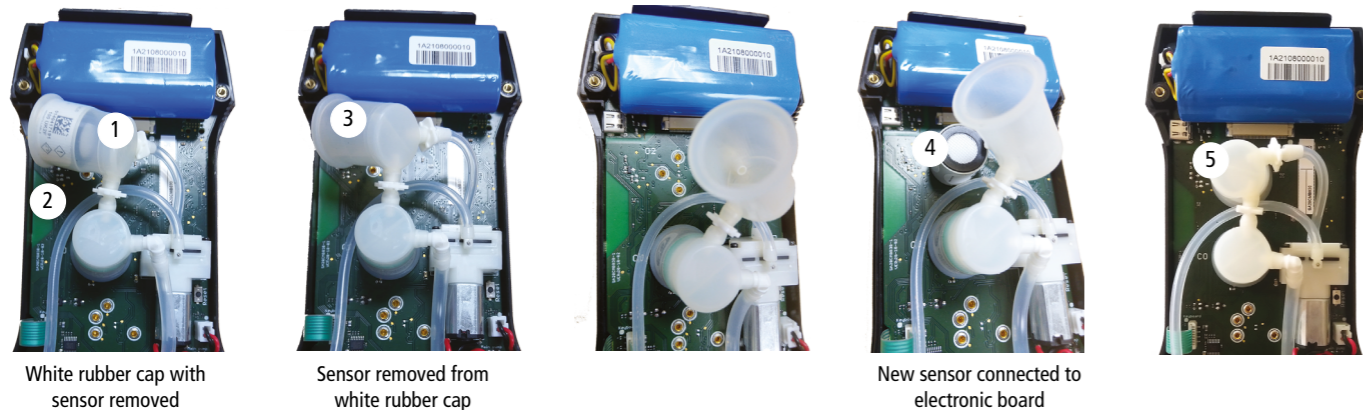

12.3 Cleaning the analyzer

Clean the analyzer housing with a damp cloth. Use distilled water.

 Do not use isopropanol.

 Sensors have very accurate locations, see the following locations defined for each sensor:

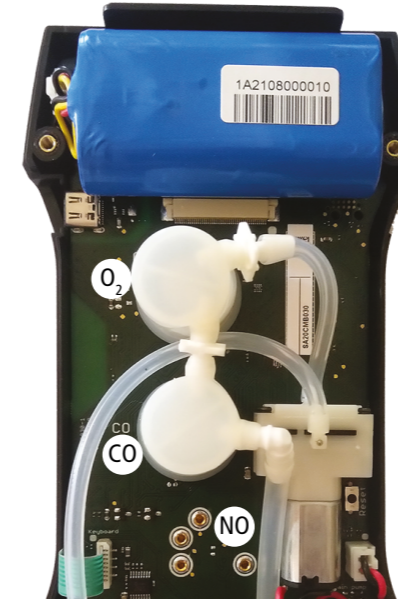

- O₂ sensor must be in O₂ position
- CO sensor must be in CO position
- NO sensor must be in NO position

When a sensor has been replaced, it is possible to check the proper functioning of this new sensor by going in the "Information" menu of the analyzer. It is normal that a sensor that has just been installed gives the following message: "Current Error", it is necessary to wait a few time to stabilize the polarization of the sensor.

Here are the stabilization times for each sensor:

- O₂: 2 hour
- CO: 2 hours
- NO: 24 hours

12.4 Replace filter inside the water trap







Follow this procedure to replace the filter inside the water trap:

- Disconnect the smoke probe from the analyzer.
- Turn the lower part (2) of the water trap to the left to detach it from the upper part (1).
- Remove the part (3) by pulling it slightly.
- Remove the used filter (4) and replace it by a new one.
- Replace the part (3).
- Turn the lower part (2) of the water trap to the right to fix it on the upper part (1).
- Make sure O-ring is seated properly in the lower part of water trap



13. Optional accessories

The following accessories are available:

Part number	Description	Illustration
27521	NO sensor for NOx	
27532 (180 mm) 27533 (300 mm) 27534 (750 mm)	180, 300 and 750 mm probes available	
27546	Remote wireless printer	
27537	3 m dual hose extension	
27538	Differential pressure hose kit	
24646	Smart air temperature probe with 2 m cable	
11994	Manual smoke pump kit	
SC0110B	CO ambient probe	
SC0112B	CO ₂ ambient probe	
26811	SCU (Sample Conditioning Unit)	

14. Spare parts

The following spare parts are available:

Item number	Description
27695	Upper Shell Assembly for Si-CA 030, with protective glass, keyboard and normative label
27696	Lower Shell Assembly for Si-CA 030, with magnets
27697	Bottom Shell Piece with Hose & Tc Connection Ports
27698	NO sensor chamber for Si-CA 030
27699	Cell chamber (silicon) for Si-CA 030
27703	Main PCB board for Si-CA 030
27704	Daughter board for Si-CA 030 for additional CO/CO ₂ ambient probes
27705	Rechargeable Battery Pack for Si-CA 030
27706	Keyboard for Si-CA 030
27707	Main gas sampling pump for Si-CA 030
27729	Filter that mounts inside the water trap
27730	O-Ring for Water Trap
27732	Pneumatic Hose Connector, with Orange O-Rings
27733	Pneumatic Hose Connector, with Black O-Rings
27734	Pneumatic Hose Connector, with Green O-Rings
27738	Protective Rubber Holster/Boot for Si-CA 030
27740	Water Trap with internal filter (without hose/connector)
27741	Water Trap with internal filter, short hose, & gas hose connector
27742	Cap to allow for measuring draft when the analyzer pump is on
27743	Color display screen for Si-CA 030