



DATA SHEET

Si-CA 030

Residential & commercial combustion analyzer
The latest in combustion analysis technology

Compact, Light and Durable Design



Up to three gas sensors O₂, CO, and NO (for NOx)



Color display screen



Lightweight, only 12oz (350g)



Auto pump cut-off for high CO levels



CO sensor measurement up to 8,000 ppm



Automatic logging & report creation



Note: Phone not included.



- Predictive maintenance with estimated sensor life & calibration reminders
- Draft & differential pressure measurements
- Calculated CO₂% value
- NOx capable with NO sensor

- Quick and easy pump On/Off control
- Combustion efficiency & excess air calculations
- CO safety monitoring in ambient air
- Protective rubber holster
- Extended warranties available

Dimensions

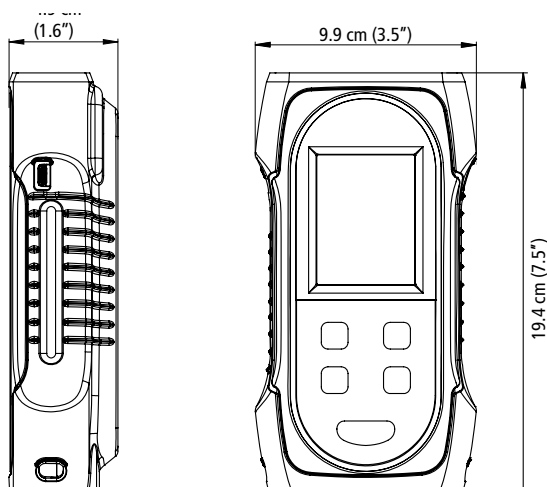

Compact design



Parameter specifications

Parameter	Sensor	Measuring range	Resolution	Accuracy ⁽¹⁾	T ₉₀ response time
O ₂	Electrochemical	0 to 25%	0.01%	±0.2% vol	< 30 s
CO	Electrochemical	0 to 8000 ppm	1 ppm	±8 ppm < 160 ppm ±5% rdg up to 2000 ppm ±10% rdg > 2000 ppm	< 40 s
CO ₂	Calculated	0 to 99.9%	0.1%	-	-
NO (optional)	Electrochemical	0 to 5000 ppm	1 ppm	±5 ppm < 100 ppm ±5% rdg > 100 ppm	< 40 s
NOx (optional)	Calculated	0 to 7500 ppm	1 ppm	-	-
Flue temperature	TcK	-4 to 2282 °F -20 to 1250 °C	0.1 °F 0.1 °C	±3.6 °F or ±0.5% rdg ⁽²⁾ ±2 °C or ±0.5% rdg ⁽²⁾	-
Air temperature	NTC or TcK	-4 to 248 °F -20 to 120 °C	0.1 °F 0.1 °C	±3.6 °F ±2 °C	-
Differential temperature	Calculated	0 to 2282 °F 0 to 1250 °C	0.1 °F 0.1 °C	-	-
Pressure/Draft	Semiconductor	-80 to 80 inH ₂ O -200 to 200 mbar	0.001 inH ₂ O 0.01 mbar	±1% rdg ±0.012 inH ₂ O ±1% rdg ±0.03 mbar	-
Excess air	Calculated	0 to 999%	1%	-	-
Efficiency	Calculated	0 to 100% (Gross/HHV ⁽³⁾)	0.1%	-	-
Efficiency (condensation)	Calculated	0 to 125% (Net/LHV ⁽⁴⁾)	0.1%	-	-

⁽¹⁾All accuracies indicated in this document were stated in laboratory conditions at 20 °C (68 °F) and 1013 mbar and can be guaranteed for measurement carried out in the same conditions.

⁽²⁾Accuracy given for the analyzer only.

⁽³⁾For Higher Heating Value / ⁽⁴⁾For Lower Heating Value

General features

Dimensions	7.5 x 3.5 x 4.9" (19.4 x 9.9 x 4.9 cm)
Weight	12oz (350g)
Display	Color display screen; Size: 320 x 240 pixels
Keypad	5 keys
Material	ABS-PC
Protection	IP42
Connection	Wireless: class 2 range, range frequency from 2402 MHz to 2480 MHz with a transmit power of 1 dBm. Range up to 50 ft (15 m), depending on smartphone radio strength. Minimum required versions: Android 5.0, iOS 12.4, BLE 4.0- USB
Power supply	Rechargeable battery, USB power supply Li-Ion 5100 mA/h 3.6 V battery / Power supply voltage of the mains unit: 100-240 Vac, 50-60 Hz Mains unit: 5 Vdc/2A
Battery	Battery life > 8 h; Charging time: Fully charge: < 6.5 h; 50%: < 2.5 h
Environmental conditions of use	Temperature: from (-5 to 45 °C), Hygrometry: in non-condensing conditions (< 85% RH) Maximum altitude: 6561' (2000 m)
Storage temperature	From -4 to 122 °F (-20 to 50 °C)
Languages	English, French, German, Spanish, Italian, Portuguese
European Union Directives	2014/53/EU (RED); 2015/863 EU (RoHS 3)
Regulations	EN 50379-1 and EN 50379-2; UNI 10389; UL & cUL Certification; BS 7967:2015; BS EN 50543:2011; UNE 60670-10; ES.02173.ES

Apps

- Free apps for iOS & Android mobile devices
- Fast, easy wireless connection
- Remote live view of combustion analysis data as list or graph
- Remote control to change settings
- Data saving, including automatic logging
- Report creation in PDF, CSV (for Excel) and XML formats
- Databases for customers, operators, & equipment



Download app

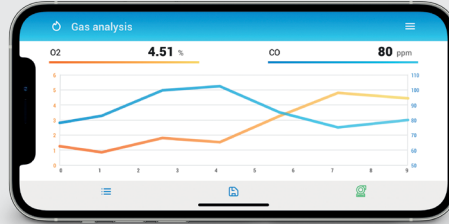

Graph view

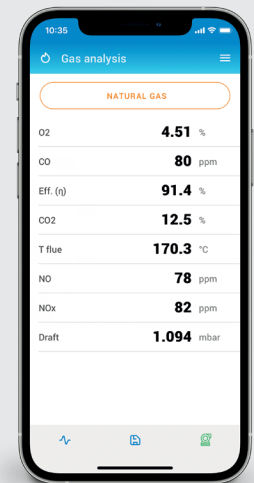

Data view

Example of analyzer screens

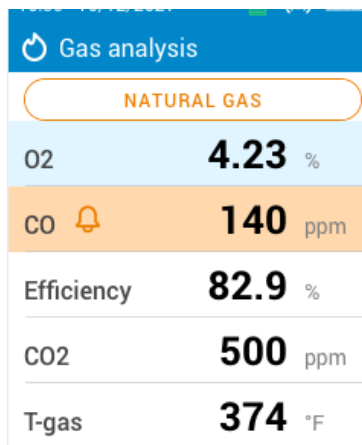
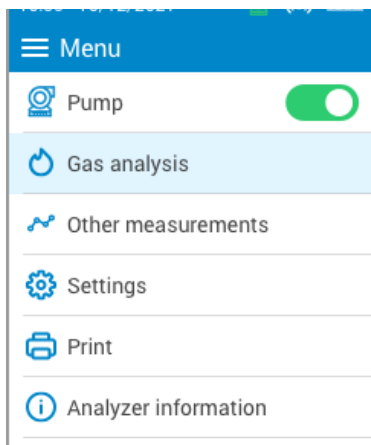

Alarm ID	Parameter	Threshold	Status
ALARM 1	CO	500 ppm - High threshold	ON
ALARM 2	T-air	30 °C - High threshold	ON
ALARM 3	NO	100 ppm - Low threshold	OFF

Si-CA 030 kit content

- Si-CA 030 analyzer
- O₂ & CO gas sensors (NO optional)
- Protective rubber holster
- Flue gas probe with dual hose
- Water trap with filter
- AC power supply / charger
- USB cable
- Mobile app
- Internal wireless communication module
- Carrying case or box packaging
- Quick Start Guide
- Calibration certificate



Ordering Information

Product	Item #	Description
Si-CA 030 Kit 2AC	27495	Si-CA 030 Gas Analyzer Kit 2AC, two gas sensors (O2, CO), 7» (180mm) Probe, cardboard box packaging
Si-CA 030 Kit 2AS	27496	Si-CA 030 Gas Analyzer Kit 2AS, two gas sensors (O2, CO), 7» (180mm) Probe, vinyl carrying case
Si-CA 030 Kit 2AH	27497	Si-CA 030 Gas Analyzer Kit 2AH, two gas sensors (O2, CO), 7» (180mm) Probe, ABS hard plastic case
Si-CA 030 Kit 2BS	27498	Si-CA 030 Gas Analyzer Kit 2BS, includes two gas sensors (O2, CO), 12» (300mm) Probe, vinyl carrying case
SICA 030 KIT 3AC	27500	Si-CA 030 Gas Analyzer Kit 3AC, three gas sensors (O2, CO, NO), 7" (180mm) Probe, cardboard box packaging
SICA 030 KIT 3AS	27501	Si-CA 030 Gas Analyzer Kit 3AS, three gas sensors (O2, CO, NO), 7" (180mm) Probe, vinyl carrying case
SICA 030 KIT 3AH	27502	Si-CA 030 Gas Analyzer Kit 3AH, includes three gas sensors (O2, CO, NO), 7" (180mm) Probe, ABS hard plastic carrying case
Si-CA 030 Kit 3BS	27503	Si-CA 030 Gas Analyzer Kit 3BS, includes three gas sensors (O2, CO, NO), 12» (300mm) Probe, vinyl carrying case











Maintenance

We carry out calibration, adjustment and maintenance of your devices to guarantee a consistent and accurate level of quality of your measurements. As part of Quality Assurance Standards, we recommend annual recalibration and maintenance check-up.

Warranty

Devices have 2-year guarantee against any manufacturing defect (return to our After-Sales Service required for appraisal).

Optional accessories

Part number	Description	Image
27521	NO sensor for NOx	
27532 (180 mm) 27533 (300 mm) 27534 (750 mm)	180, 300 and 750 mm probes available	
27546	Remote wireless printer	
27537	3 m dual hose extension	
27538	Differential pressure hose kit	
24646	Smart air temperature probe with 2 m cable	
11994	Manual smoke pump kit	
27547	CO ambient probe	
27548	CO ₂ ambient probe	
26811	SCU (Sample Conditioning Unit)	



5 Commonwealth Ave
Woburn, MA 01801
Phone 781-665-1400
Toll Free 1-800-517-8431

[Visit us at www.TestEquipmentDepot.com](http://www.TestEquipmentDepot.com)