

## Noise Dose Meter Model SL400

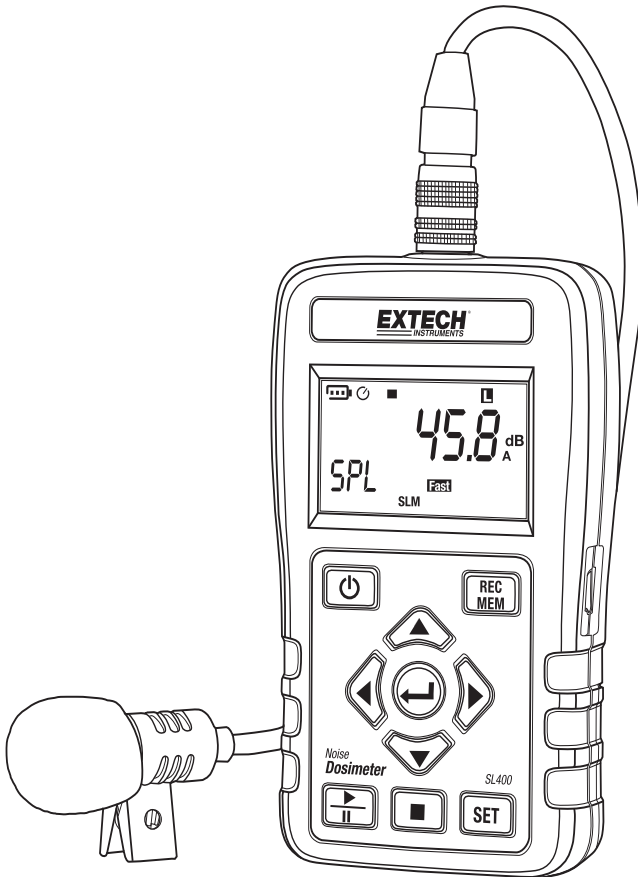

## Introduction

---

Thank you for selecting the Extech Instruments Model SL400. This device is shipped fully tested and calibrated and, with proper use, will provide years of reliable service. Please visit our website to check for the latest version of this User Guide, Product Updates, Software, and Customer Support.

## Safety

---

**CAUTION:** Avoid taking measurements in humid or wet environments.

**WARNING:** Ensure that the ambient humidity conditions are within those specified and referenced in the *Environmental Conditions* section.

**WARNING:** Avoid taking measurements in the presence of:

- Explosive gases
- Combustible gases
- Steam
- Excessive dust

**CAUTION:** Do not operate the instrument in ambient temperature and humidity conditions beyond those recommended and referenced in the *Environmental Conditions* section.

**ATTENTION:** Keep the microphone dry and avoid severe vibration.

**ATTENTION:** Wind blowing across the microphone can add extraneous noise. If the instrument is used in windy conditions, use the supplied microphone windscreen to prevent undesirable signals.

The following symbols are used:



**Caution:** Incorrect use may damage the instrument.



The instrument conforms to the CE standard

## Supplied Accessories

- User's manual
- Carrying case
- 9V battery
- Microphone and windscreen
- PC Software
- MINI USB Cable (Mini B type)

# Description





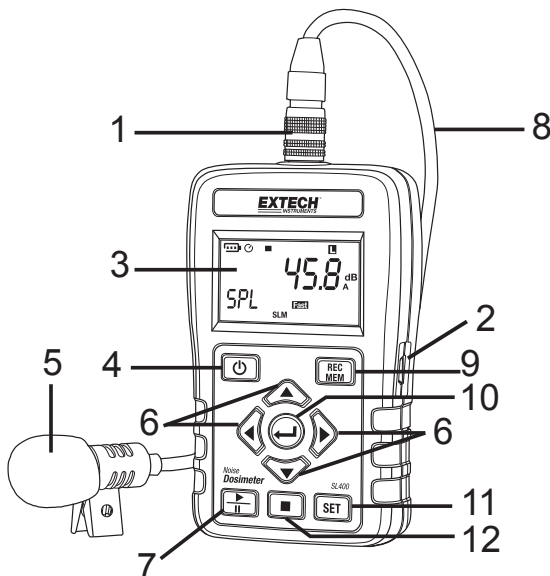

## Meter Description

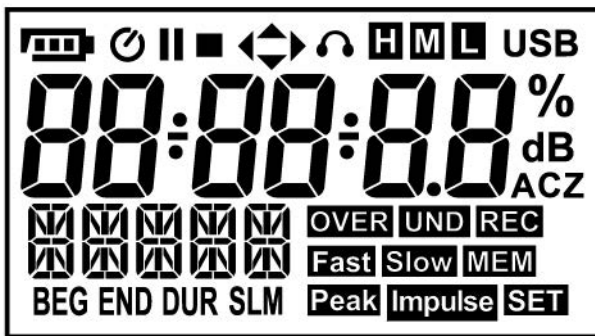
1. Microphone Connector
2. USB Interface
3. LCD Display
4. Power Button
5. Microphone and wind screen
6. Navigation Buttons
7. Start / Pause Button
8. Microphone Cable
9. REC/MEM Button
10. ENTER Button
11. SET Button
12. Stop Button



## Display Description



-  Battery Status
-  Auto Power Off Enabled
-  Pause
-  115dB indicator (SPL)
-  Stop
-  140 dB indicator (Peak)

▶  
USB

H

M

L

8

M

SLM

%

dB

A

C

Z

Fast

Slow

Impulse

OVER

UND

REC

BEG

MEM

END

SET

DUR

Start  
USB Interface

SPL High dB Range (70~140)

SPL middle dB Range (50~110)

SPL low dB Range (30~90)

dB level

Testing mode  
Sound Level Meter mode

Noise Dose %

Sound Level dB unit

A weighting

C Weighting

Z Weighting

Fast response

Slow Response

Impulse Weighting

Over Range

Under Range

Solid: Auto record standby; Flashing: Recording

Start test time (begin)

View recorded data

Stop test time

SET mode

Test duration

## Set Mode



---

Press the **SET** button to enter set mode. There are a total of seven functions in set mode: Test Mode, Power Off, Sampling Time & Auto Record, Real Time Clock, 94dB Offset Adjust, Noise Standard, and SLM function.

Press the **SET** button to move to the next parameter or Press enter  to exit set up mode.

### Test Mode Set





Press the  or  button to change the test mode between NDM (Noise Dose Meter) and SLM (Sound Level Meter).

Press the **SET** button to move to the next parameter or Press enter  to exit set up mode.

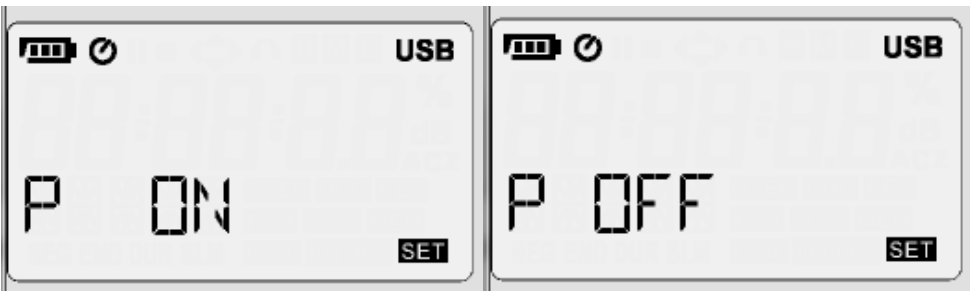
### Auto Power Off Set



Press the  or  button to enable or disable Auto Power Off Function.

Auto Power Off will turn off the meter in 15 minutes if the meter is not recording data.

Press the **SET** button to move to the next parameter or Press enter  to exit set up mode.

## Sampling Time & Auto Record Set



Use the ◀ or ▶ button to select either Auto Recording set or Sampling time.

Use the ▲ or ▼ button to enable or disable Auto record (On or Off) or to adjust the sampling time. The minimum sampling time (interval rate) is 1 reading per second. The maximum sampling time is 23 hours, 59 minutes, and 59 seconds.

Press the SET button to move to the next parameter or Press enter ⏎ to exit set up mode.

## Real Time Clock Set

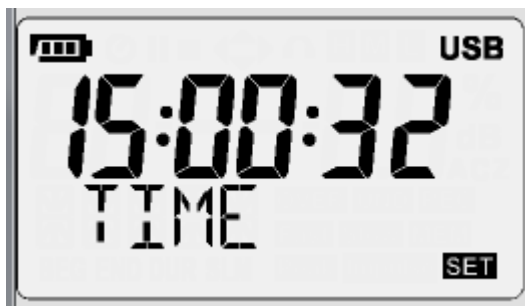

Press the ◀ or ▶ button to select the option to adjust the Real time clock (24 hour).

Use the ▲ or ▼ button to adjust the time digits.

Press the SET button to move to the next parameter or Press enter ⏎ to exit set up mode.



## 94dB Offset Adjust (Calibration)



See section on meter calibration before proceeding with this parameter.  
Press the **SET** button to move to the next parameter or Press enter  to exit set up mode.



## Noise Standard Set



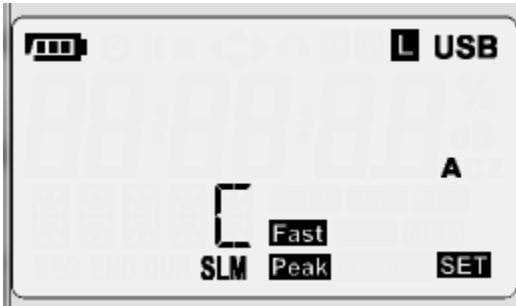

Press the  or  button to select a NDM testing regulatory body abbreviation: OSHA, MSHS, DOD, ACGIH, ISO85, ISO90, and USER.  
Press the **SET** button to move to the next parameter or Press enter  to exit set up mode.

## SLM Function Set



Press the  or  button to change a test function. These include:

- **H**, **M**, and **L**
- **Fast**, **Slow**, and **Impulse**
- **A**, **C**, and **Z**
- Peak C and Peak Z

Press the  or  button to select the next test parameter:

Time weighting	(Fast, Slow, or Impulse),
Frequency weighting	(A, C or Z),
Peak frequency measurement	(C or Z).
Sound level range	(high, medium, or low)
High –	70 to 140dB
Medium –	50 to 110dB
Low -	30 to 90dB

Press the **SET** button to move to the next parameter or Press enter  to exit set up mode.



## Calibration

---



### Automatic Mode Calibration

Set the meter to **SLM mode, A weighting, High range, and Slow.**

Attach a 94.0dB (1000Hz) sound calibrator to the microphone.

Enter **SET** mode and go to the parameter **94ADJ**.

Press the Run  key to start the automatic offset routine and wait for the flashing dB number to appear.

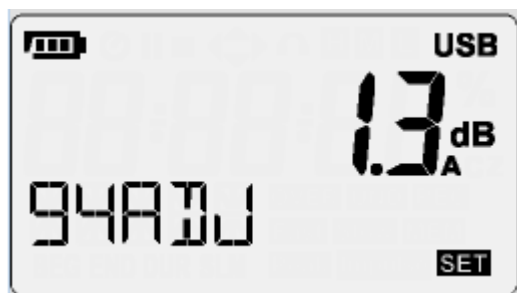

Press the Enter  key to save the entry and to get back to the measure window.  
The meter should now read 94.0dB (+/- 0.1dB).

If the measured value does not equal 94.0 (+/- 0.1dB), run the 94ADJ routine again.

Press the Enter  key to save the entry and to get back to the measure window.

## Manual Mode Calibration

Set the meter to SLM mode, A weighting, High range, and Slow.

Attach a 94.0dB (1000Hz) sound calibrator to the microphone and wait for about 1 minute and note the sound value on the display. Write down the value.

Calculate the value of the offset from the displayed value to the sourced noise level.

In this example the value is +1.3 (94.0dB sourced, and 92.7dB displayed)

Enter **Set** mode and go to the parameter **94ADJ**.

Using the Up and down arrows set the offset according to the offset calculated.

In this example – set 94ADJ to 1.3



Press the Enter  key to save the entry and to get back to the measure window.



The meter should now read 94.0dB (+/- 0.1dB).

## Operation

---

### Sound Level Measurement Procedures



Press the  button to turn on the meter. The LCD will display the **SPL** symbol, with SLM on the lower line. If SLM is not visible press SET and NDM will appear, press the Down arrow  to change to SLM and press enter  to exit.

Press the  button to scroll through the available test functions for this mode: SPL, Leq, SEL, and PKMAX.

Press the  button to begin testing. Press the  button again to pause testing.

If the reading exceeds the high testing range, the LCD display will show **OVER**. If the reading is below the low testing range, the LCD display will show **UND**.

The Leq integral time is the same value as the sampling time setting.

When the sampling time is set to zero, the integration time continues until the user exits the mode.

Press the  button to stop the test.

**Caution:** Wind blowing across the microphone can add extraneous noise. When there is wind present higher than 10 m/s, the windscreen must be used to prevent undesirable signals. Keep the microphone dry and avoid severe vibrations.

Note: setup of the meter can also be performed through the software.

## Auto Data Recording



Press the  button to enable the auto data record function. The **REC** symbol will flash on the LCD display. The bottom left of the LCD display will show **WRITE**, at each sample interval to indicate that the data was written to the meter's internal memory.

## Erase memory

When the bottom left of the LCD displays **FULL**, the internal memory is full. The auto function cannot be used until the data stored in memory is downloaded and cleared.

Note: The memory can only be downloaded and erased using the software.

## Manual - Single Data Point Recording





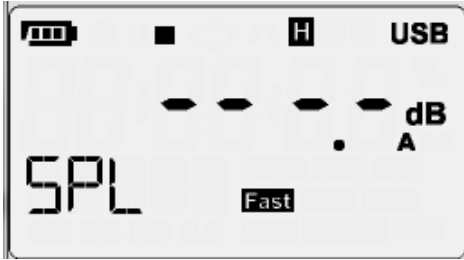

Press the  button to store the displayed reading. The **REC** symbol will flash. The bottom left of LCD display will show **WRITE**, indicating that the single data point was written to the meter's internal memory.

Note: Single Data Point recording does not function while the meter is in Auto Data Recording mode.



To view manually recorded data, see the heading **View Logged Sound Level Readings** or **View Logged DOSE readings**.

## Noise Dose Measurement Procedures







Press the  button to turn on the meter. The LCD will display the SPL (sound pressure level icon). If SLM is showing in the lower line, Press SET and press the down arrow  to change SLM to NDM. Press the Enter button  to exit setup. Press the  button to enable noise dose testing. Press the  button again to pause testing. Press  to stop testing.

Press the  button to scroll the available test options: SPL, Dose%, LPMAX, LPMIN, PKMAX, LEQ, SEL, LEP8, TWA8, LVAG, LN5%, LN10%, LN50%, LN90%, and LN95%.

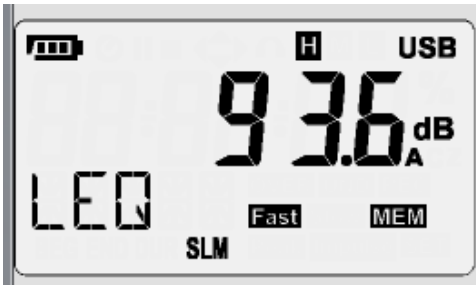

Press the  button to view the start test time and date. Press the  button to change the view from time to date and back to the time display. The time format is HH:MM:SS and the date format is YY-MM-DD.

## View Logged Sound Level Readings



For Sound level readings, SLM must appear on the lower line. Press and hold the  button for more than 1 sec to enter the viewing mode. Press the  or  button to scroll through the readings.

Press the  button to select the dose record information (Noise Dose Meter mode): Test mode, Start Time, Test duration, Total pause time, Test end time.

Press the  button to view the test start date, Press the  button to view the test start time. The time format is HH:MM:SS and the date format is YY-MM-DD.

Press and hold the  button for more than 1 sec again to exit the logged data viewing mode.



## View Logged DOSE readings





**Note: It is best to view the DOSE data from the software interface.  
Refer to the SL400 Software Help guide.**

For DOSE noise readings, SLM must NOT appear on the lower line. If SLM appears on the bottom line, change the mode to NDM in Setup mode.

Press and hold the  button for more than 1 sec to enter the viewing mode.

Press the  or  button to scroll through the Dose recording log.

Press the  button to select the dose test options: SPL, Dose%, LPMAX, LPMIN, PKMAX, LEQ, SEL, LEPS, TWA8, LVAG, LN5%, LN10%, LN50%, LN90%, and LN95%.

Press the  button to view the test start time, Press the  button to view the test start date. The time format is HH:MM:SS and the date format is YY-MM-DD.

Press and hold the  button for more than 1 sec again to exit the logged data viewing mode.

## Graphic Window Mode

Right-click on the image and choose VIEW and uncheck Graphic Window mode for full view.

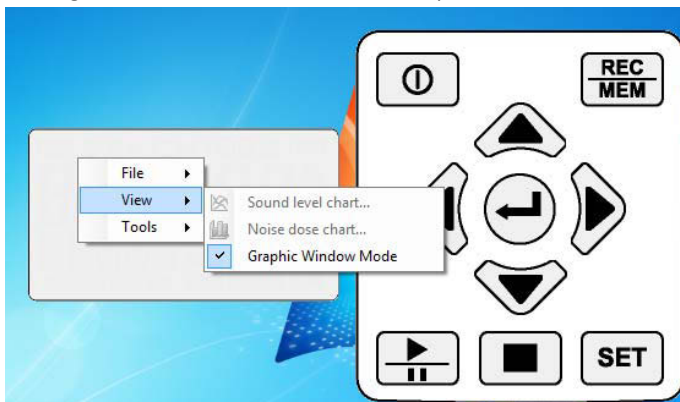

## Definitions

### Measurement Parameters

Test Function	Screen parameter	Explanation
SPL	LAFp	Sound pressure level (SPL)
SPL	LASp	Sound pressure level (SPL)
SPL	LCFp	Sound pressure level (SPL)
SPL	LCSp	Sound pressure level (SPL)
SPL	LZFp	Sound pressure level (SPL)
SPL	LZSp	Sound pressure level (SPL)
Leq	LAFq	Equivalent continuous level for the duration of the measurement for A weighting
Leq	LCFq	Equivalent continuous level for the duration of the measurement for C weighting
Leq	LZFq	Equivalent continuous level for the duration of the measurement for Z weighting
SEL	LAE	Frequency weighted sound exposure level for the duration of the measurement for A weighting
SEL	LCE	Frequency weighted sound exposure level for the duration of the measurement for C weighting
SEL	LZE	Frequency weighted sound exposure level for the duration of the measurement for Z weighting
Peak	Lcpeak	Instantaneous C peak level

# Maintenance

---

## Battery Replacement

When the battery icon () appears on the LCD, the battery must be replaced. Turn off the meter and remove the rear battery cover. Remove battery from the battery holder and insert a new 9V battery (Alkaline) observing correct polarity. Re-install the battery cover.

- Please dispose of batteries responsibly; observe all regulations.
- Never dispose of batteries in a fire; batteries may explode or leak.



All EU users are legally bound by the Battery Ordinance to return all used batteries to community collection points or wherever batteries / accumulators are sold! Disposal in household trash or refuse is prohibited!

**Disposal:** Follow the valid legal stipulations in respect of the disposal of the device at the end of its lifecycle

## Cleaning

To clean the instrument, use a soft dry cloth to remove dust from the meter housing. Do not touch the microphone sound entry port. Never use wet cloths, solvents, or liquids to clean the meter housing.

## A, C, and Z Weighting Considerations

The A weighting curve is based on *40 Phon fletcher-Munson Equal Loudness Contour*. For noise assessments of the effects of noise on human hearing, the A weighting mode is recommended.

The C weighting mode is recommended for machine sound monitoring (steady, drone type).

The Z weighting offers a linear signal response that is not processed through the meter's filter. Z weighting is suitable for monitoring electrical signals (AC or DC signals for research purposes, for example).

# Appendix A

---

## Dose Standards Selection list

OSHA	Occupational Safety and Health Administration (USA)
MSHA	Mine Safety and Health Administration (USA)
DoD	Department of Defense (USA)
ACGIH	American Conference of Governmental Industrial Hygienists (USA)
ISO85	European
ISO90	European
User	User defined parameters (settings can be saved to a file Import/Export)



## Specifications

Display	LCD type (MAX reading 999999)
Display Refresh Rate	1 reading/second
Standards	IEC 61252-1993 IEC 61672-1-2003 ANSI S1.25-1992 ANSI S1.4-1983 ANSI S1.43-1997
Microphone	1/2 inch Electret condenser microphone
Measurements (NDM)	SPL, DOSE%, LPMAX, LPMIN, PKMAX, LEQ, SEL, LEP8, TWA8, LAVG, L5%, L10%, L50%, L90%, L95%
Measurements (SLM)	SPL, LEQ, SEL, PKMAX
Display Range	30dB to 90dB (L) 50dB to 110dB (M) 70dB to 140dB (H)
Primary RMS Range @1KHZ	41dB to 86dB (L) 55dB to 106dB (M) 75dB to 125dB (H)
Maximum Peak C Weighting Sound Level Measurement	90~143 dB
Dynamic Range	60 dB
Accuracy	±1.4dB@94dB /1KHZ
Internal memory	MAX Datalogger data:10000(NDM); 999,999(SLM)
Time Weighting	Fast, Slow, Impulse
Frequency Weighting	A/C/Z
Frequency Range	20Hz~8KHz
Starting Time	<10 Second
Battery data	24 hour battery life; 9V Alkaline battery
Dimensions	107(L) x 65(W) x 33(H) mm; 4.21(L) x 2.56(W) x 1.30(H) in.

## Microphone

- Diameter: ½ inch
- Polarization voltage: 0V
- Dynamic range: 25 dB ~ 140dB
- Sensitivity:  $-32 \pm 3$  dB (250Hz 0dB = 1V/Pa)
- Free field frequency response:  $\pm 2$ dB (25Hz ~ 12.5kHz)

Frequency (kHz)	Pressure deviation
0.25	0.0
1	-0.1
2	-0.5
3	-0.6
4	-0.9
5	-1.2
6	-1.7
7	-2.2
8	-2.8
9	-3.3
10	-4.1
12.5	-6.0

## Input Interface

The front is PLT83RFR, the signal input receptacle

1. GND
2. Power (+)
3. N.C.
4. Power (-)

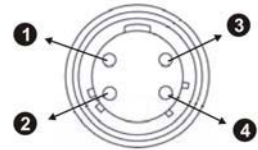

## Environmental

Environmental conditions: temperature  $23^{\circ}\text{C} \pm 5^{\circ}\text{C}$  ( $73.4^{\circ}\text{F} \pm 9^{\circ}\text{F}$ ), relative humidity < 80%.

- For inside use, max altitude 2000m (6562 ft.)
- Reference temperature  $23^{\circ} \pm 5^{\circ}\text{C}$  ( $73.4^{\circ}\text{F} \pm 9^{\circ}\text{F}$ )
- Operating temperature  $5 \sim 40^{\circ}\text{C}$  ( $41 \sim 104^{\circ}\text{F}$ )
- Operating humidity <80% RH
- Storage temperature  $-10 \sim 60^{\circ}\text{C}$  ( $14 \sim 140^{\circ}\text{F}$ )
- Storage humidity <70%

## EMC

This instrument was designed in accordance with EMC Standards in force and its compatibility has been tested in accordance with EN61326-2 (2006).

**Copyright © 2016 FLIR Systems, Inc.**

All rights reserved including the right of reproduction in whole or in part in any form