

# SP7001

# SP7002

# NON-CONTACT CAN SENSOR

Instruction Manual

# SP7100

# SP7150

# CAN INTERFACE

# SP9200

# SP9250

# SIGNAL PROBE

# HIOKI



5 Commonwealth Ave  
Woburn, MA 01801  
Phone 781-665-1400  
Toll Free 1-800-517-8431

Visit us at [www.TestEquipmentDepot.com](http://www.TestEquipmentDepot.com)

 **Be sure to read this manual before using the instrument.** ▶ p.7

 **When using the instrument for the first time**

Part Names and Functions ▶ p.10

Preparing Before Use ▶ p.15

Functionality ▶ p.27

 **Troubleshooting**

Maintenance and Service ▶ p.43

# EN





# Contents

Introduction.....	1		
About the Notations Used in This Manual.....	2		
Verifying Package Contents.....	3		
Options.....	5		
Operating Precautions .....	7		
<b>1 Overview</b> .....	<b>9</b>		
1.1 Product Overview and Features.....	9		
1.2 Part Names and Functions .....	10		
SP7001/SP7002 Non-Contact CAN Sensor .....	10		
SP7100 CAN Interface.....	11		
SP7150 CAN Interface.....	12		
SP9200 Signal Probe.....	13		
SP9250 Signal Probe.....	13		
1.3 LED Lighting/Flashing Specifications.....	14		
<b>2 Preparing Before Use</b> .....	<b>15</b>		
2.1 Preparations.....	15		
2.2 Connecting the Signal Probes.....	16		
2.3 Connecting the Non-Contact CAN Sensor.....	17		
2.4 Connecting the Ground Terminal .....	18		
2.5 Connecting the CAN Interface.....	20		
2.6 Supplying Power.....	21		
2.7 Connecting the Signal Probes to the CAN bus.....	22		
When using the SP9200 .....	22		
When using the SP9250 .....	24		
2.8 Inspecting the Product Before Use.....	25		
<b>3 Functionality</b> .....	<b>27</b>		
3.1 Switching the Non-Contact CAN Sensor's Signal Detection Sensitivity.....	27		
3.2 Probe Setting Function (Automatic Polarity Selection) .....	28		
3.3 Output Bus Error Detection Function .....	29		
<b>4 Specifications</b> .....	<b>31</b>		
4.1 SP7001/SP7002 Non-Contact CAN Sensor .....	31		
4.2 SP7100 CAN Interface .....	34		
4.3 SP7150 CAN Interface .....	37		
4.4 SP9200 Signal Probe .....	40		
4.5 SP9250 Signal Probe .....	41		
4.6 SP9900 Split Cable (dedicated option for SP7100).....	42		
<b>5 Maintenance and Service</b> .....	<b>43</b>		
5.1 Troubleshooting .....	45		
CAN signal detection is unstable. ....	45		
You are unable to detect CAN signals stably when using the product in an environment where it is exposed to vibrations, for example in road testing.....	46		



# Introduction

Thank you for choosing the Hioki SP7001/SP7002 Non-Contact CAN Sensor, SP7100/SP1750 CAN Interface, and SP9200/SP9250 Signal Probe. Keep this manual accessible so that you can take full advantage of the product's functionality throughout its service life.

Be sure to review the following documentation before using the product:

Document	Content	Paper edition	Electronic edition
<b>Instruction Manual (this manual)</b>	The Instruction Manual contains detailed instructions about how to use the product. The most recent version can be downloaded from Hioki's website.	–	✓
<b>Quick Start Manual</b>	The Quick Start Manual provides a brief overview of how to use the product.	✓	–
<b>Operating Precautions (0990A905)</b>	"Operating Precautions" contains important information about how to use the product safely.	✓	–

Familiarize yourself with the separate document entitled Operating Precautions and Quick Start Manual before using the product.

## Communications standards

The Non-Contact CAN Sensor supports the following communications standards:

Model	Communications standards	
SP7001	<b>CAN</b>	<b>CAN FD</b>
SP7002	<b>CAN</b>	–

## Target audience

This Instruction Manual has been written for users of the product and individuals who will instruct others on how to use the product.

It assumes that the reader has basic knowledge about electricity (at the level one would obtain from completing an electrical program at a technical high school).





## Use of the product

Before using the product, review proper handling of the product, bus systems, and related systems. Only individuals who understand both safe product use and the potential impacts arising from using the product should use the product. Use of the product by others may cause bodily injury or damage to the product or other devices.

# About the Notations Used in This Manual

## Safety notations



This manual classifies seriousness of risks and hazard levels as described below.

 <b>WARNING</b>	Indicates the possibility of serious injury or death.
 <b>CAUTION</b>	Indicates the likelihood of minor injury or equipment damage or failure.
<b>IMPORTANT</b>	Indicates information or content that is particularly important from the standpoint of operating or maintaining the product.
	Indicates useful advice concerning product performance and operation.
	Indicates an action that must not be performed.
	Indicates an action that must be performed.

## Symbols on equipment

	Indicates the need for caution or the presence of a hazard. For more information about locations where this symbol appears on product components, see “Operating Precautions” (p.7), warning messages listed at the beginning of operating instructions, and the document entitled “Operating Precautions” that comes with the product.
---	---

## Symbols related to standards

	Indicates compliance with the Waste Electrical & Electronic Equipment (WEEE) Directive in EU member countries.
	Indicates compliance with EU directives.

## Other symbols

*	Instructs the reader to see below for more information.
(p. )	Indicates the page number to reference.
<b>Bold</b>	Operation keys are printed in bold.

# Verifying Package Contents

Before using the product, inspect it for any damage that may have occurred during shipment. Exercise particular care with regard to accessories, panel switches, and terminals. Contact your authorized Hioki distributor or reseller if you find any damage or if the product fails to operate to its specifications.



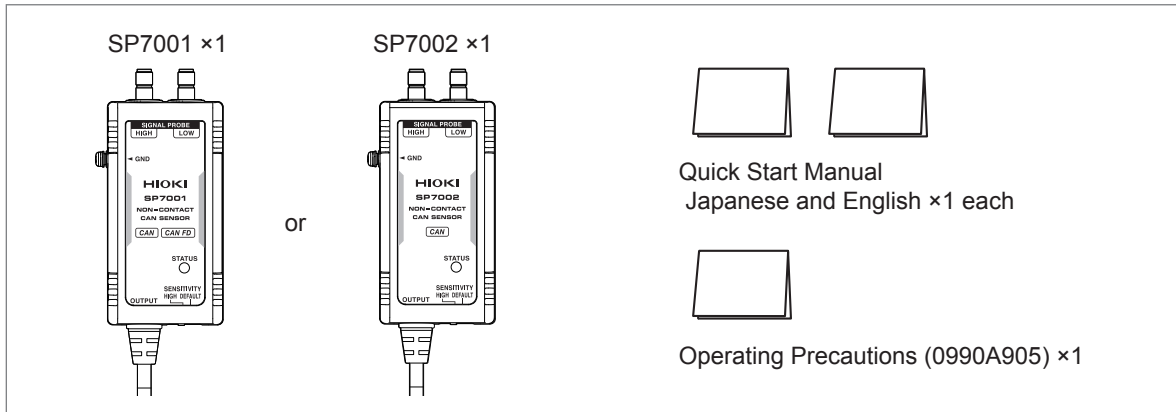

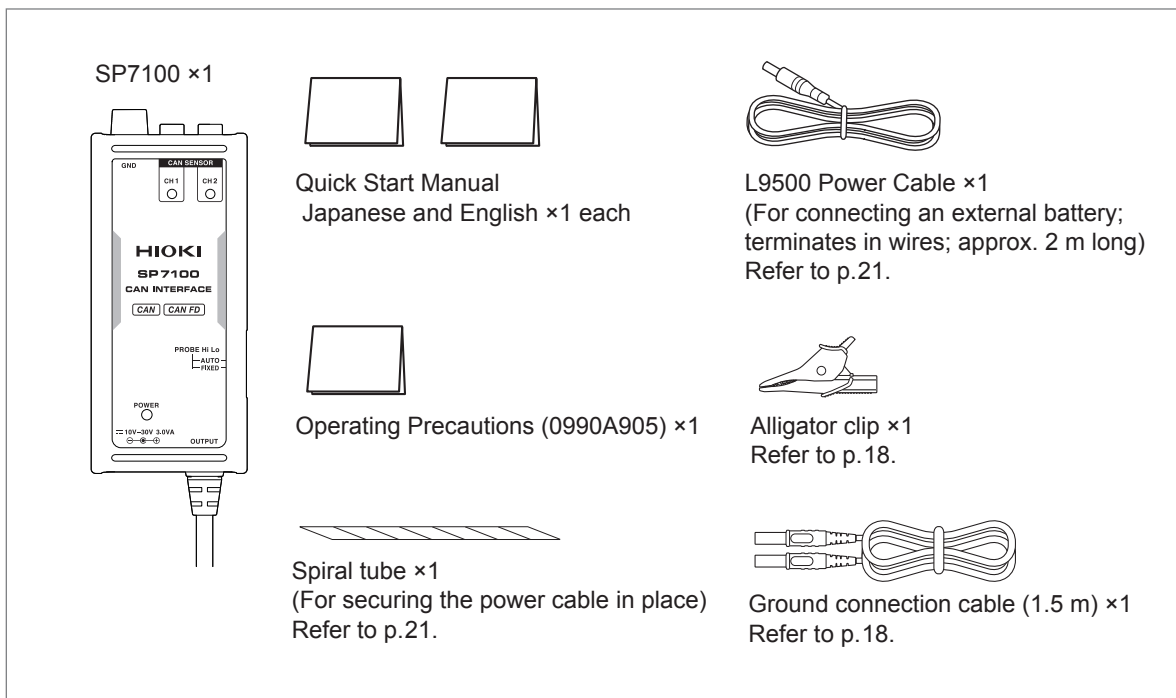

## SP7001/SP7002 Non-Contact CAN Sensor

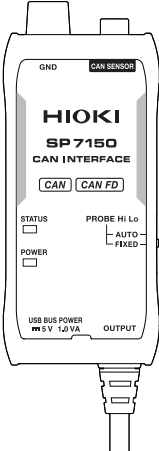

## SP7100 CAN Interface

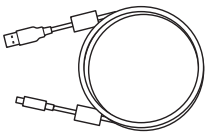

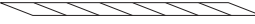
### SP7150 CAN Interface

<p>SP7150 ×1</p> 		
	<p>Quick Start Manual Japanese and English ×1 each</p>	<p>L9510 USB Cable ×1 (Type-A Type-C; for power supply; 1 m long) Refer to p.21.</p>
		
	<p>Operating Precautions (0990A905) ×1</p>	<p>Alligator clip ×1 Refer to p.18.</p>
		
	<p>Spiral tube ×1 (For securing the power cable in place) Refer to p.21.</p>	<p>Ground connection cable (1.5 m) ×1 Refer to p.18.</p>

### SP9200 Signal Probe

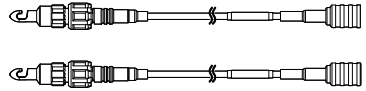
<p>Signal Probe ×2</p>	
------------------------	--

### SP9250 Signal Probe

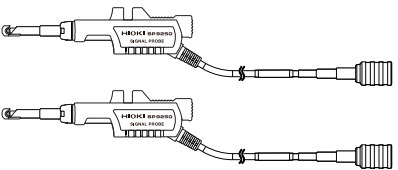
<p>Signal Probe ×2</p>	
------------------------	--





## Options

The following options are available for the product. To purchase an option, please contact your Hioki's distributor or reseller.

Options are subject to change. Please check Hioki's website for the latest information.

<p><input type="checkbox"/> SP7001 Non-Contact CAN Sensor Refer to p.17.</p>	
<p><input type="checkbox"/> SP7002 Non-Contact CAN Sensor Refer to p.17.</p>	
<p><input type="checkbox"/> SP7100 CAN Interface Refer to p.20.</p>	
<p><input type="checkbox"/> SP7150 CAN Interface Refer to p.20.</p>	
<p><input type="checkbox"/> SP9200 Signal Probe Refer to p.16.</p>	
<p><input type="checkbox"/> SP9250 Signal Probe Refer to p.16.</p>	

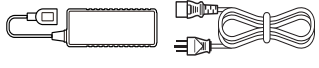
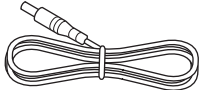
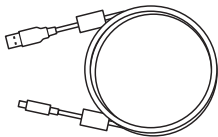
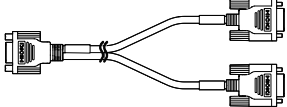
## Verifying Package Contents

<input type="checkbox"/> Z1008 AC Adapter (for SP7100 only) Refer to p.21.	 A line drawing of a rectangular AC adapter with a power cord on the left and a cable with a connector on the right.
<input type="checkbox"/> Z1013 AC Adapter (for SP7150 only) Refer to p.21.	 A line drawing of a rectangular AC adapter with a power cord on the left and a cable with a connector on the right.
<input type="checkbox"/> L9500 Power Cable (for SP7100 only) (For connecting an external battery; terminates in wires; approx. 2 m long) Refer to p.21.	 A line drawing of a power cable with a connector on one end and two wires on the other.
<input type="checkbox"/> L9510 USB Cable (for SP7150 only) (Type-A Type-C; for power supply; 1 m long) Refer to p.21.	 A line drawing of a USB cable with a Type-A connector on one end and a Type-C connector on the other.
<input type="checkbox"/> SP9900 Split Cable (for SP7100 only) Refer to p.20.	 A line drawing of a split cable with one connector on one end and two connectors on the other.
<input type="checkbox"/> C1013 Carrying Case	 A photograph of a black carrying case with a handle and a latch, containing various cables and accessories.

Options can be purchased via authorized Hioki distributor or reseller.

## Operating Precautions

Be sure to observe the following precautionary information to ensure that the product can be used safely and in a manner that allows it to perform as described in its specifications. Use of the product should conform not only to its specifications, but also to the specifications of all accessories, options, and other equipment in use.

### Handling of the product

#### **WARNING**

Do not use the product in locations such as those listed below. Doing so may result in product damage or cause an accident.



- Locations where the product would be subject to direct sunlight or high temperatures
- Locations where corrosive or explosive gases are present
- Locations where there is powerful electromagnetic radiation or that are close to electrically charged objects
- Close to inductive heating equipment (high-frequency inductive heating equipment, IH cooktops, etc.)
- Locations with an excessive amount of mechanical vibration
- Locations where the product would be exposed to water, oil, chemicals, solvents, or other liquids
- Locations with excessive humidity or condensation
- Locations with excessive dust

#### **CAUTION**



- Do not drop the product or subject it to mechanical shock. Doing so may damage the product and adversely affecting its detection performance.
- Do not handle the product's connectors with your bare hands or manipulate them with tools. Subjecting connectors to excessive force may damage them.
- Do not connect the product to cables (CAN bus lines) other than those described in the specifications. Doing so may damage the cable under test.

- The product complies with EN 61326 Class A. Use in residential settings such as neighborhoods may cause radio or television interference. If you encounter such interference, take appropriate steps to prevent it.
- When transporting the product, take care to avoid subjecting it to vibration or mechanical shock.

## Cables

### CAUTION



- To avoid damaging their insulation, do not step on or pinch the product's cables.
- Do not place foreign objects in the guard hook (p. 13).  
Doing so may cause issues with signal detection or opening/closing operation of the product.



- Cables harden in freezing temperatures. Exercise care as bending or pulling on cables under such conditions can damage insulation and cause wiring breaks.
- Attach the signal probe to the cable under test after checking the cable for deteriorated or damaged insulation.
- The product detects CAN signals such as those used to communicate with ECUs in a contactless manner from outside the cable insulation. Any electrical short between the signal probe and cable wires could interfere with CAN communications.
- To prevent damage to the product's special vibration-resistant connectors, always disengage the lock and grip the connector itself (not the cable) when disconnecting them.  
Refer to "2.2 Connecting the Signal Probes" (p. 16).

## Z1008/Z1013 AC Adapter

### WARNING



- The Z1008/Z1013 AC Adapter has a rated supply voltage of 100 V to 240 V and a rated frequency of 50 Hz or 60 Hz. To prevent damage to the product or an electric accident, never use the adapter with any other voltage.
- To prevent electric shock and ensure safety, connect the included power cord to a grounded two-prong outlet.

# 1 Overview

## 1.1 Product Overview and Features

The SP7001/SP7002 Non-Contact CAN Sensor can detect CAN communications signals, which are used in control communications in automobiles and in a variety of devices, from outside cables' insulation.

Captured CAN signals can be connected to analyzers, loggers, and other measuring instruments with a CAN interface.

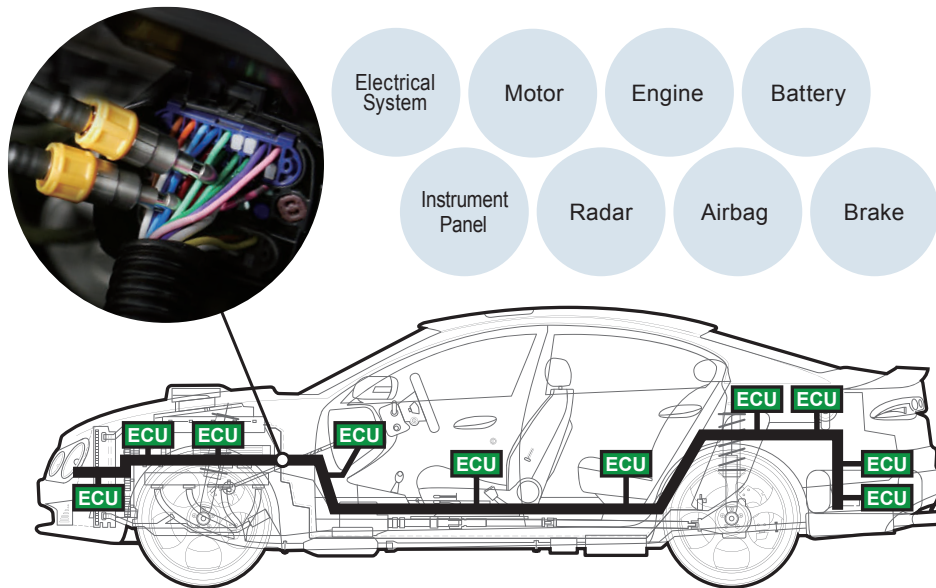

### ● Contactless sensing that doesn't affect the system under test

The Non-Contact CAN Sensor uses proprietary technology to detect CAN communications signals from outside cables' insulation. As a result, there is no need to attach connectors or to connect or fabricate wire harnesses (cable harnesses) in order to acquire signals.

Since the Non-Contact CAN Sensor is electrically isolated from the CAN bus whose signals are being detected, use of the product has no effect on the electrical characteristics of the system under test. Products can be tested in their finished or mass-produced state.

### ● Reliable detection

Detection defects have been minimized to avoid errors caused by the Non-contact CAN Sensor and detected by devices such as analyzers, facilitating accurate\* automobile development and evaluating testing. Additionally, infrequent events can be reliably detected.

### ● CAN and CAN FD support

The Non-Contact CAN Sensor supports high-speed CAN communications at speeds ranging from 125 kbit/s to 1 Mbit/s. Additionally, the product can detect CAN FD communications at up to 3 Mbit/s.

### ● Support for a variety of CAN input devices

The Non-Contact CAN Sensor uses standard D-sub 9-pin terminals for its output connectors. As a result, you can connect analyzers, loggers, instruments, and other devices with a CAN interface.

\*: The Non-Contact Sensor is capable of extremely stable CAN frame acquisition. However, the product is not guaranteed to achieve an error rate of 0% under all conditions. Errors may be caused by factors including the condition of the vehicle being tested and the quality of the power supply being used. Please verify that the product functions properly with the vehicle to be tested prior to use.

## 1.2 Part Names and Functions

### SP7001/SP7002 Non-Contact CAN Sensor

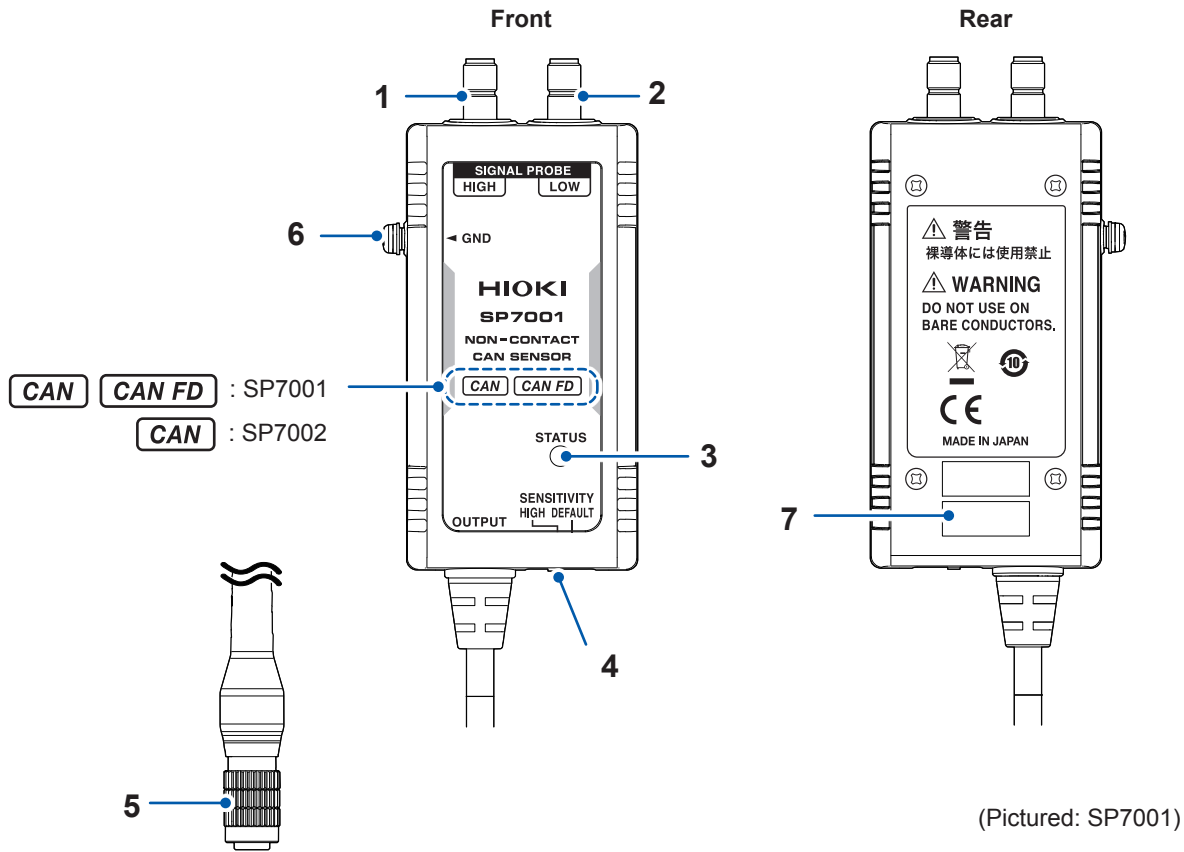

No.	Name	Function	See
1	<b>HIGH Signal Probe connector</b>	Connect a Signal Probe. Connect the other end of Signal Probe to the CAN bus's CAN_H line.	p. 16 p. 22
2	<b>LOW Signal Probe connector</b>	Connect a Signal Probe. Connect the other end of Signal Probe to the CAN bus's CAN_L line.	p. 16 p. 22
3	<b>STATUS LED</b>	Indicates the status of the Non-contact CAN Sensor.	p. 14
4	<b>SENSITIVITY selector</b>	Sets the Non-Contact CAN Sensor's sensitivity to either <b>DEFAULT</b> (normal mode) or <b>HIGH</b> (high-sensitivity mode). Ordinarily, the product should be used with the <b>DEFAULT</b> setting.	p. 27
5	<b>Output connector</b>	Connect to the CAN Interface's Non-Contact CAN Sensor connector.	p. 17
6	<b>Ground terminal</b>	If connecting the CAN interface's ground terminal to the ground cannot reduce the noise, connect this terminal to the CAN signal source's ground or to the automobile's body (ground or body ground connected to the vehicle battery's negative terminal). To prevent a short-circuit, the connector is AC-coupled to the CAN interface ground.	p. 18
7	<b>Serial number</b>	The 9-digit serial number indicates the year of manufacture (first two digits) and the month of manufacture (second two digits). Do not remove this sticker as the number is important.	—

## SP7100 CAN Interface

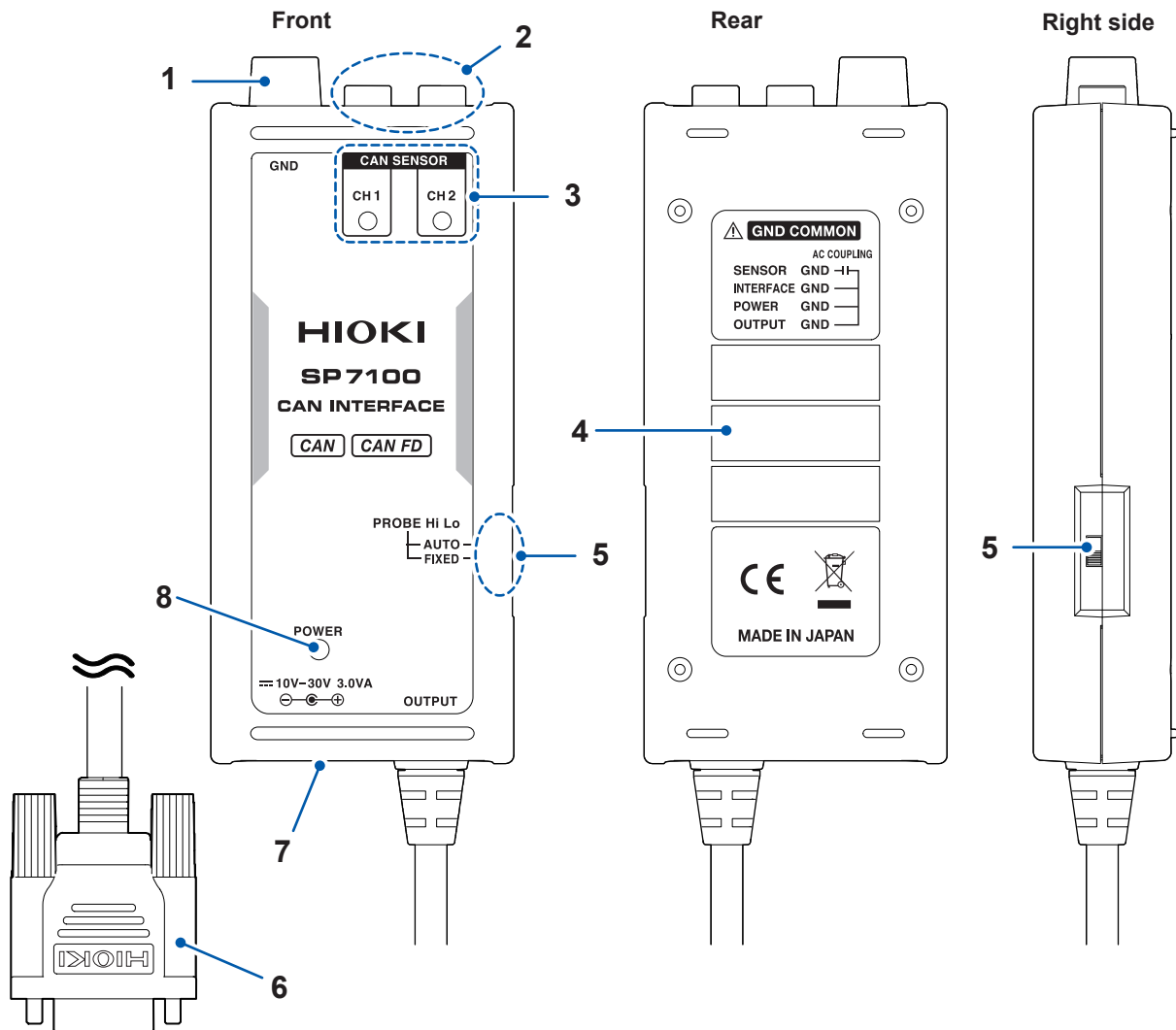

No.	Name	Function	See
1	Ground terminal	Connect to the CAN signal source ground or to the automobile's body (ground or body ground connected to the vehicle battery's negative terminal).	p.18
2	Non-Contact CAN Sensor connector	Connect the SP7001/SP7002 Non-Contact CAN Sensor's output connector.	p.17
3	CAN SENSOR LED CH1, CH2	Indicates the status of the Non-Contact CAN Sensors by mirroring the state of the <b>STATUS</b> LEDs on the Non-Contact CAN Sensors connected to CH1 and CH2.	p.14
4	Serial number	The 9-digit serial number indicates the year of manufacture (first two digits) and the month of manufacture (second two digits). Do not remove this sticker as the number is important.	–
5	Probe setting selector	Sets the Non-Contact CAN Sensor's probe setting function to either <b>AUTO</b> or <b>FIXED</b> . Be sure to understand the functionality of <b>AUTO</b> mode before using the sensor in that mode.	p.28
6	CAN signal output connector	This D-sub 9-pin female connector outputs the CAN signals from CH1 and CH2.	p.20
7	Power jack	Connect the L9500 Power Cable or Z1008 AC Adapter.	p.21
8	POWER LED	Lights up when the product is on.	p.14

## SP7150 CAN Interface

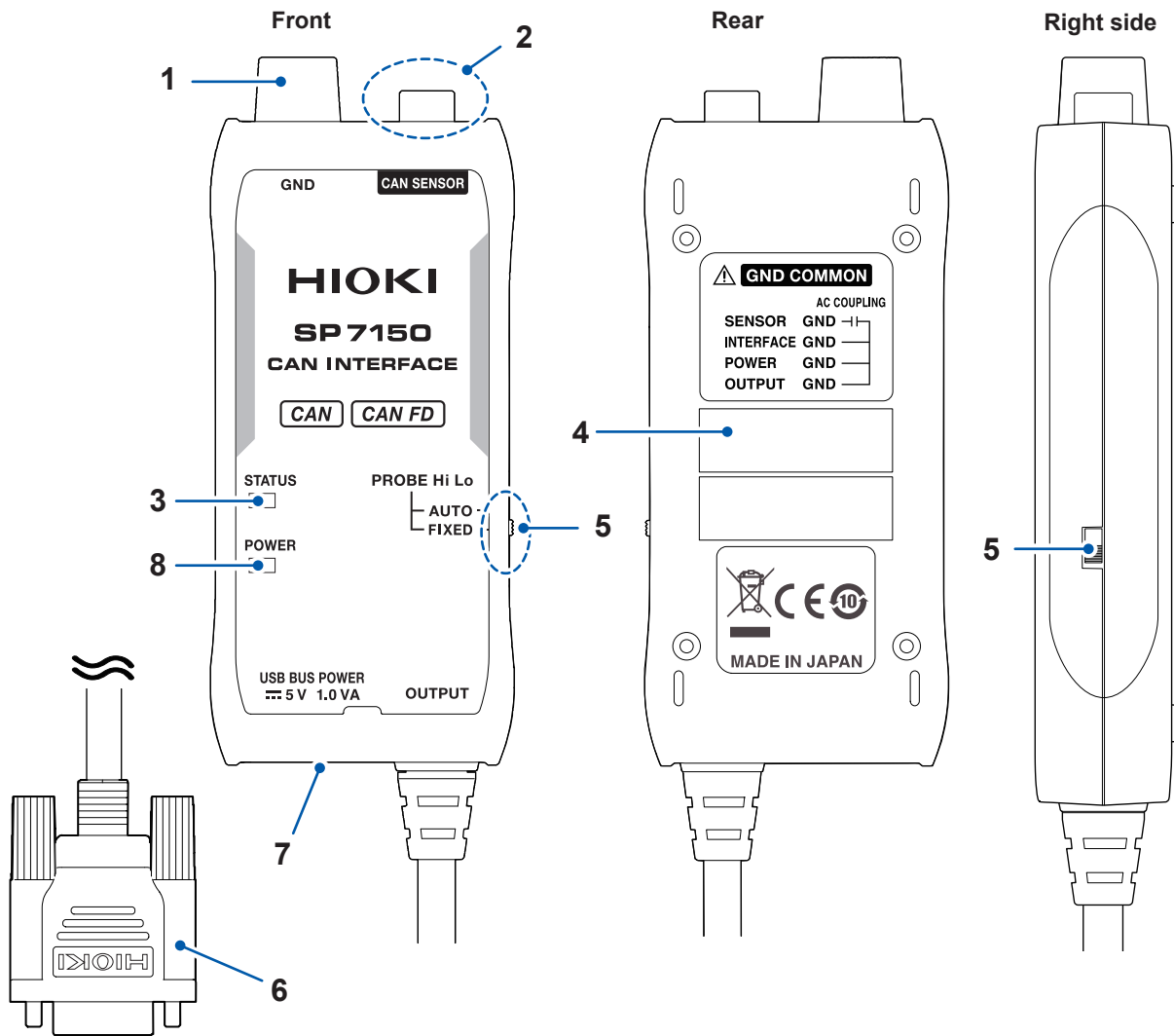

No.	Name	Function	See
1	<b>Ground terminal</b>	Connect to the CAN signal source ground or to the automobile's body (ground or body ground connected to the vehicle battery's negative terminal).	p.18
2	<b>Non-Contact CAN Sensor connector</b>	Connect the SP7001/SP7002 Non-Contact CAN Sensor's output connector.	p.17
3	<b>STATUS LED</b>	Indicates the status of the Non-Contact CAN Sensor.	p.14
4	<b>Serial number</b>	The 9-digit serial number indicates the year of manufacture (first two digits) and the month of manufacture (second two digits). Do not remove this sticker as the number is important.	–
5	<b>Probe setting selector</b>	Sets the Non-Contact CAN Sensor's probe setting function to either <b>AUTO</b> or <b>FIXED</b> . Be sure to understand the functionality of <b>AUTO</b> mode before using the sensor in that mode.	p.28
6	<b>CAN signal output connector</b>	This D-sub 9-pin female connector outputs the CAN signal.	p.20
7	<b>Power jack</b>	Connect the L9510 USB Cable.	p.21
8	<b>POWER LED</b>	Lights up when the product is on.	p.14



## SP9200 Signal Probe

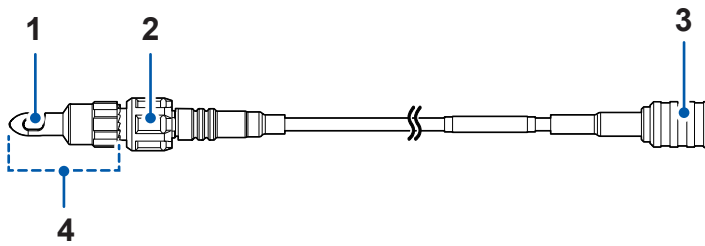

No.	Name	Function	See
1	<b>Detection electrode</b>	Detects CAN signals from outside the cable's insulation.	p.22
2	<b>Grip</b>	Rotate the grip to open and close the guard hook.	p.22
3	<b>Connector with lock</b>	Connect to the Non-Contact CAN Sensor. Be sure to verify that the lock is engaged when connecting to the sensor.	p.16
4	<b>Guard hook</b>	Place the cable under test into the slit in the guard hook and clamp it in place with the detection electrode.	p.22



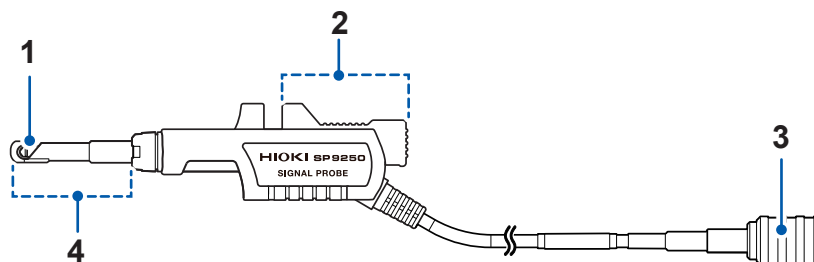

## SP9250 Signal Probe











No.	Name	Function	See
1	<b>Detection electrode</b>	Detects CAN signals from outside the cable's insulation.	p.22
2	<b>Open/close lever</b>	Push to open the guard hook.	p.22
3	<b>Connector with lock</b>	Connect to the Non-Contact CAN Sensor. Be sure to verify that the lock is engaged when connecting to the sensor.	p.16
4	<b>Guard hook</b>	Place the cable under test into the slit in the guard hook and clamp it in place with the detection electrode.	p.22

## 1.3 LED Lighting/Flashing Specifications

### SP7001/SP7002 Non-Contact CAN Sensor

Product status	STATUS LED
Self-test error (failure)	 Steady red
Signal not detected	 Steady green
Signal detected	 Flashing green
Probe high/low reverse connection warning	 Flashing red

### SP7100/SP7150 CAN Interface

Product status	POWER LED	SP7100	SP7150
		CH1, CH2 LED	STATUS LED
Self-test error (failure)	 Flashing green	 Steady red	
CAN sensor not connected	 Steady green	 Unlit	
CAN sensor connected	 Steady green	Reflects CAN Sensor's STATUS LED.	
Output bus error detection	 Steady green	  Quickly alternating red/green	

# 2

## Preparing Before Use

### 2.1 Preparations

#### IMPORTANT

Only remove the Signal Probe from the Non-Contact CAN Sensor when it needs to be replaced due to wear. Leave the Signal Probe connected to prevent deterioration of the connector's contacts and to keep out dirt.

- For the SP7100

If pins for two channels have been allocated to the D-sub 9-pin connector you plan to use, there is no need to use the SP9900 Split Cable. Check the pin assignments for the connector you plan to use.

#### Connection example:

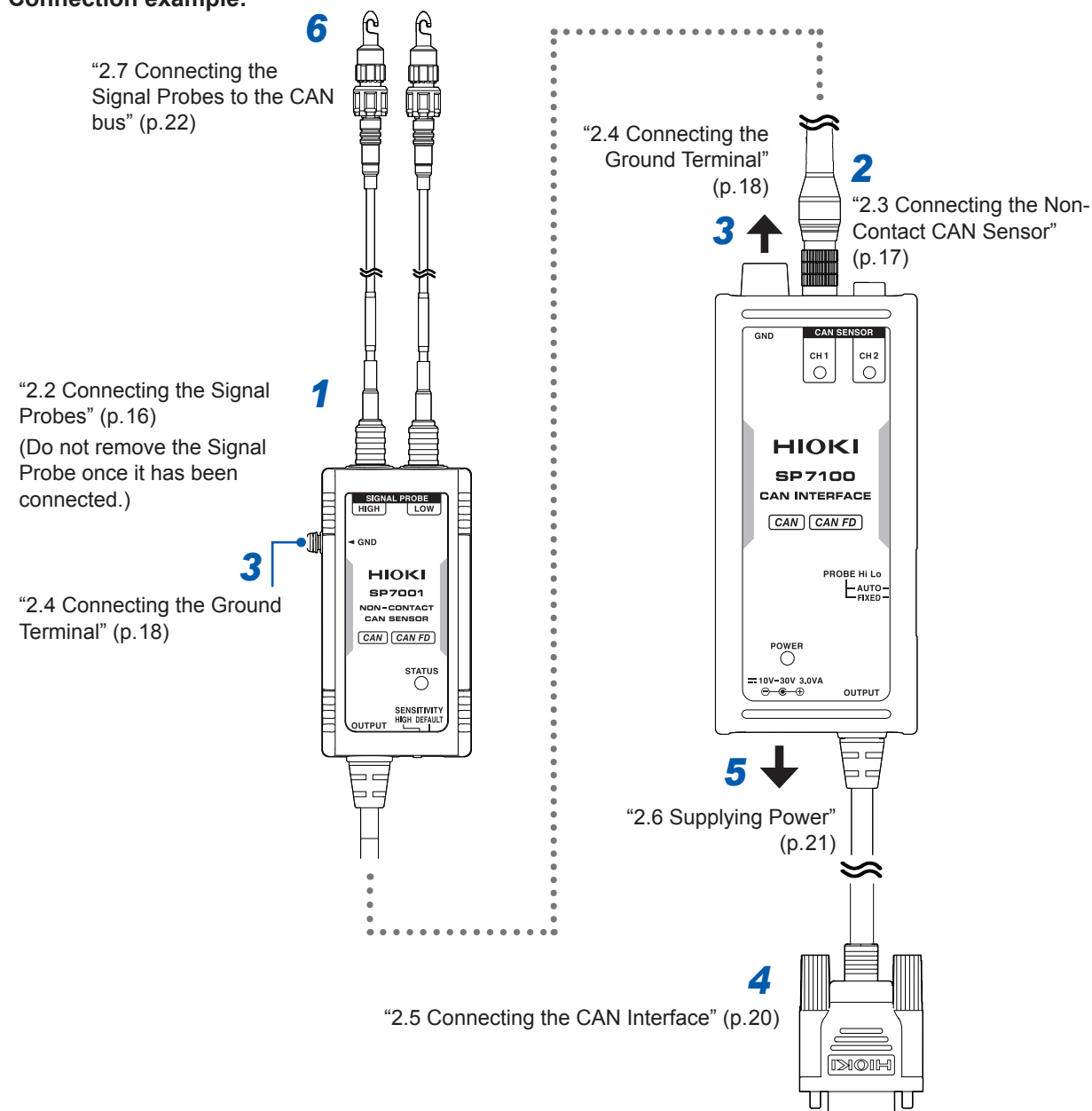

Connect the SP7100 CAN Interface's CAN signal output connector to the CAN interface-equipped analyzer, logger, instrument, or other device with which you wish to use it.

## 2.2 Connecting the Signal Probes

### Connect to the Non-Contact CAN Sensor.

Connect the SP9200/SP9250 to the SP7001/SP7002 Non-Contact CAN Sensor's signal probe connector.

#### IMPORTANT

- Leave the Signal Probe connected to prevent deterioration of the Signal Probe and Non-Contact CAN Sensor's connector's contacts and to keep out dirt.
- The Signal Probe's connector incorporates a locking mechanism. Always use the probe with the connector in the locked state to ensure signals can be properly detected and to prevent damage to the connector.
- Do not connect both the SP9200 and SP9250 to the same Non-Contact CAN Sensor. Doing so may increase susceptibility to the effects of noise.

Example: SP9200 Signal Probe

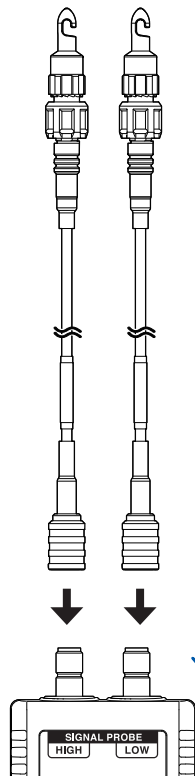

OK

Insert until you hear a clicking sound to lock the connector.

SP7001/SP7002  
Non-Contact CAN Sensor

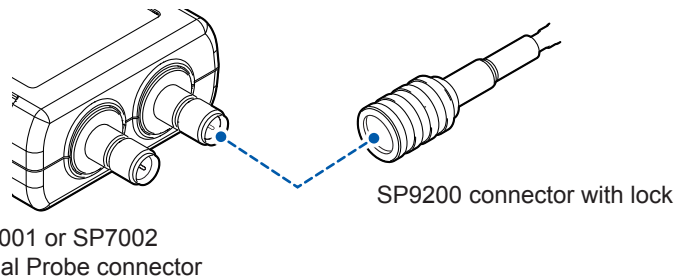

SP7001 or SP7002  
Signal Probe connector

SP9250

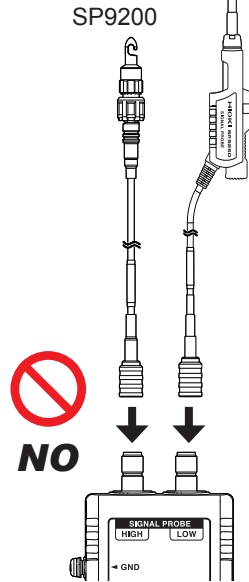

NO

SP7001/SP7002  
Non-Contact CAN Sensor

## 2.3 Connecting the Non-Contact CAN Sensor

Connect the SP7001/SP7002 Non-Contact CAN Sensor's output connector to the SP7100/SP7150 CAN Interface's Non-Contact CAN Sensor connector.

### ⚠ CAUTION



Handle each connector of the product. Do not use tools. Subjecting the connectors to excessive force could damage them.

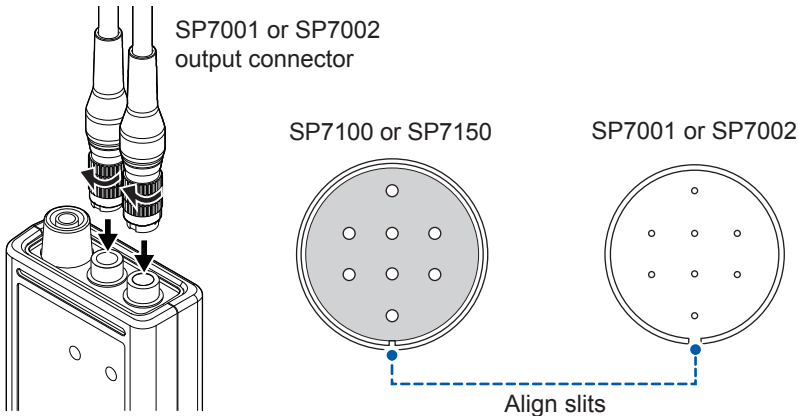

Example: SP7100 CAN Interface

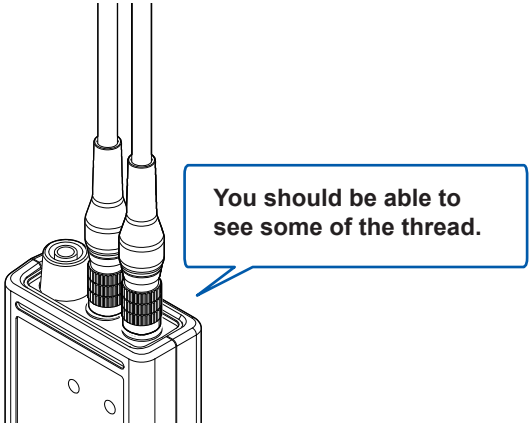

## 2.4 Connecting the Ground Terminal

### SP7100/SP7150 CAN Interface ground terminal

Connect the CAN Interface to the vehicle's body ground or other suitable grounding point. Connect the ground connection cable connected to the CAN Interface to the CAN signal source ground or to the vehicle's body (ground connected to the vehicle battery's negative terminal or body ground).

The effects of noise that is superposed on the vehicle's power supply can be reduced by connecting the ground connection cable.

- 1** Insert the ground terminal cable's plug into the CAN Interface's ground terminal.
- 2** Connect the alligator clip to the vehicle's ground.

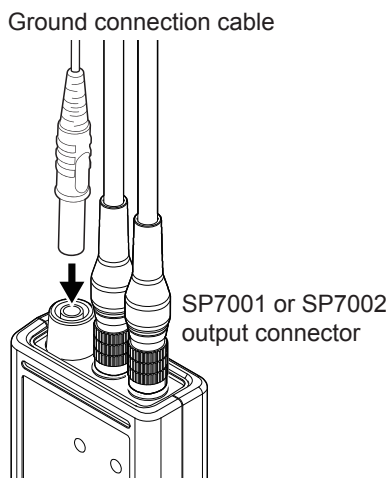

Example: SP7100 CAN Interface

### SP7001/SP7002 Non-Contact CAN Sensor ground terminal

If connecting the CAN interface's ground terminal to the ground cannot reduce the noise, connect to the Non-Contact CAN Sensor's ground terminal to the CAN signal source's ground or to the body of a vehicle in the vicinity of the CAN signal source (ground connected to the vehicle battery's negative terminal or body ground).

To further reduce the effects of noise, connect a ground connection cable that is 1 m or less in length to the ground terminal. You are responsible for providing this cable.

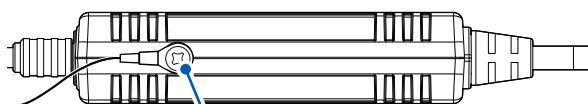

Double SEMS M3×6 dedicated screw

#### Tips

In order to reduce the effects of noise, it is not sufficient simply to connect the ground connection cable to a metal part. The metal part used must be continuous with the vehicle's ground (i.e., it must be a part or body ground point that is continuous with the vehicle battery's negative terminal). If you are unsure where to connect the ground connection cable, first check for continuity between the metal part you are considering and the vehicle's ground (a part or body ground point that is continuous with the vehicle battery's negative terminal) and then connect the ground connection cable.

## Example equivalent circuit diagram for ground common

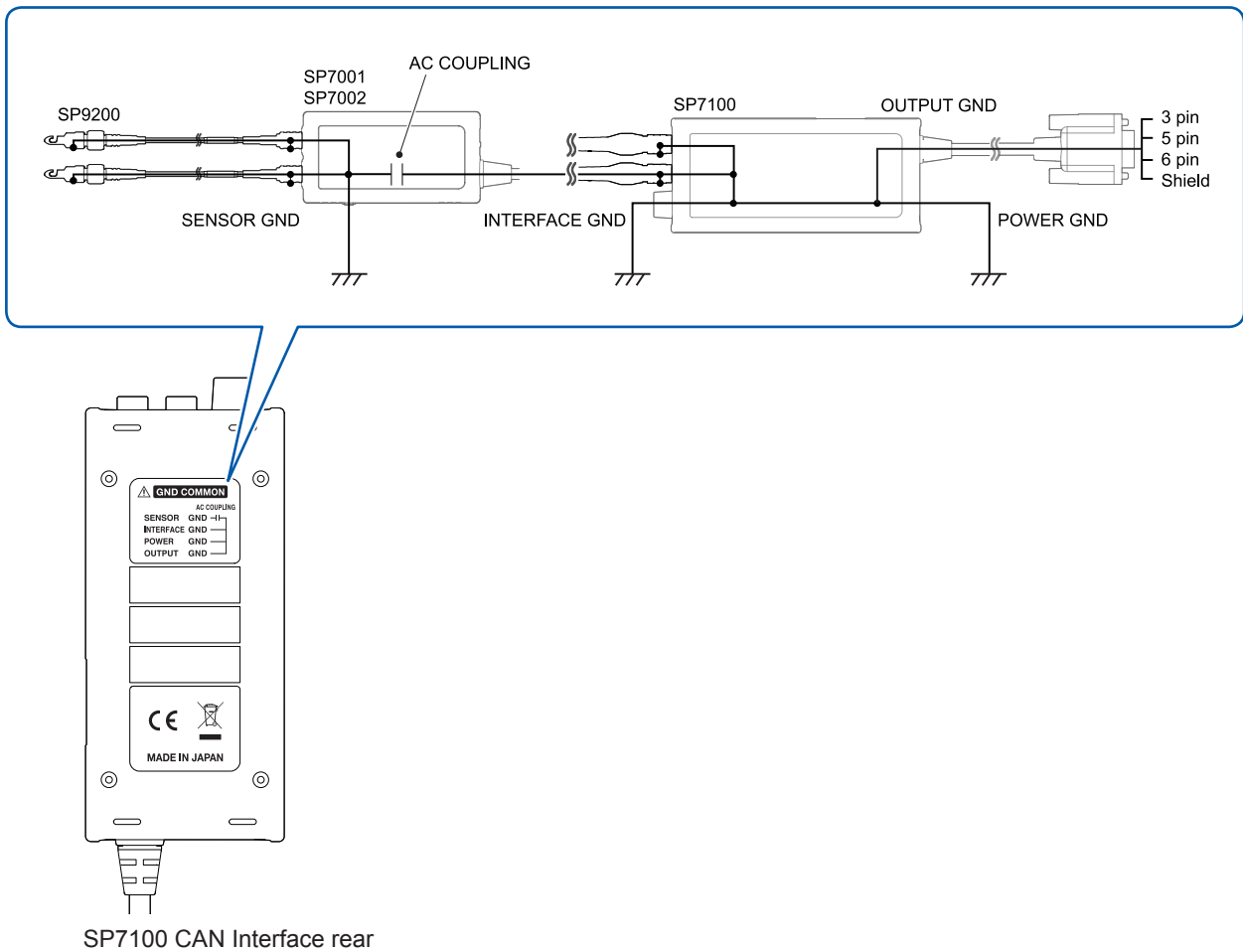

## AC coupling

The Non-Contact CAN Sensor and the CAN Interface are AC-coupled.

This design serves to prevent a short-circuit in the event the Non-Contact CAN Sensor's sensor ground or a Signal Probe's guard hook comes into contact with a DC power supply (such as a battery).

Note that there is no AC coupling between the Signal Probe and the sensor ground, as illustrated in the equivalent circuit diagram, and exercise caution to avoid creating a short-circuit.

Short-circuit protection provided by AC coupling functions only for DC voltages.

## 2.5 Connecting the CAN Interface

Connect the SP7100 or SP7150 CAN Interface's CAN signal output connector to the CAN interface-equipped device with which you wish to use it.

The SP7100's output connector carries both CH1 and CH2 data.

Connect the SP7100 or SP7150 after checking the pin assignment in use for the D-sub 9-pin by the SP7100/SP7150 and the device you plan to use.

The SP7100/SP7150 provides a D-sub 9-pin (female) CAN signal output connector.

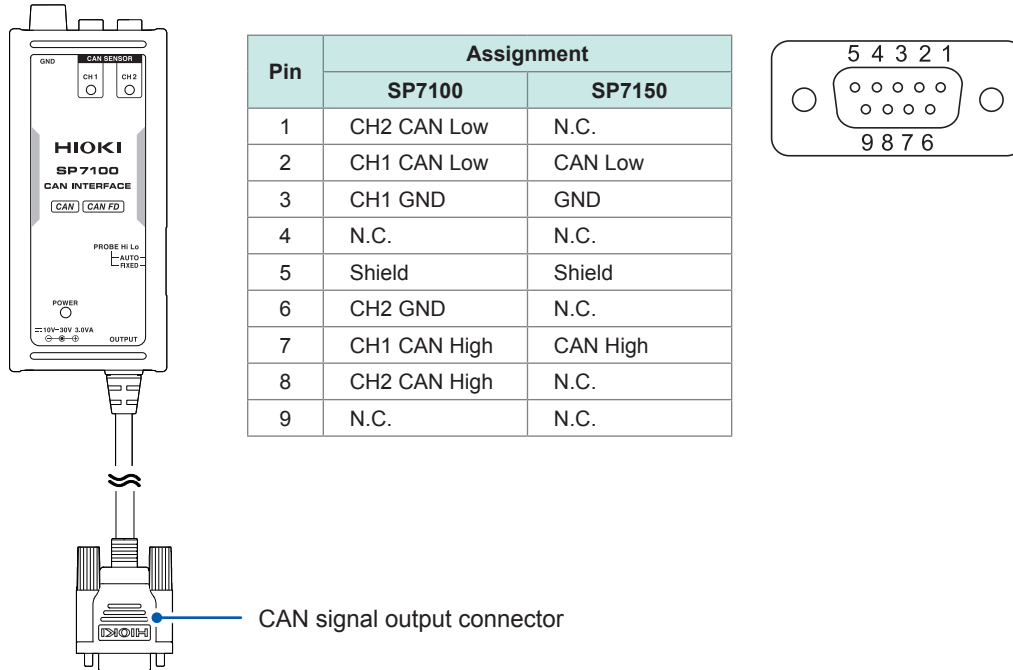

### SP9900 Split Cable (dedicated option for SP7100)

If the input interface provided by the device you plan to use does not support 2-channel input, use the SP9900 Split Cable.

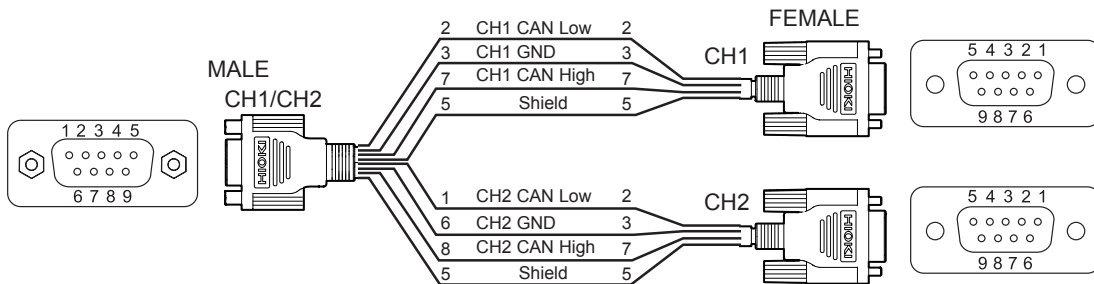

IN		OUT			
MALE		FEMALE CH1		FEMALE CH2	
Pin	Assignment	Pin	Assignment	Pin	Assignment
1	CH2 CAN Low	1	N.C.	1	N.C.
2	CH1 CAN Low	2	CH1 CAN Low	2	CH2 CAN Low
3	CH1 GND	3	CH1 GND	3	CH2 GND
4	N.C.	4	N.C.	4	N.C.
5	Shield	5	Shield	5	Shield
6	CH2 GND	6	N.C.	6	N.C.
7	CH1 CAN High	7	CH1 CAN High	7	CH2 CAN High
8	CH2 CAN High	8	N.C.	8	N.C.
9	N.C.	9	N.C.	9	N.C.



## 2.6 Supplying Power

You can supply power to the SP7100 CAN Interface with either the L9500 Power Cable or the Z1008 AC Adapter. And you can supply power to the SP7150 CAN Interface with either the L9510 USB Cable or the Z1013 AC Adapter. Choose the power source that is best suited to your operating environment. The CAN Interface does not have a power switch..

Power cable and AC adapter compatibility chart

CAN interface	Power cable	AC adapter
SP7100	L9500	Z1008
SP7150	L9510	Z1013

### IMPORTANT

Use the spiral tube (which is included with the product as an accessory) to secure the power cable in place so that it cannot be easily pulled out of the connector on the product (see figure below).

When wrapping the spiral tube around the output and power cables, leave some play in the power cable so that there is no tension on it. If there is tension on the power cable, moving the CAN signal output cable could cause the power plug or USB cable to become disconnected.

- When using the SP7150 CAN Interface:

The product requires a current of at least 200 mA to operate. If supplying power from a USB terminal with USB bus power functionality, verify that the device operates properly prior to use.

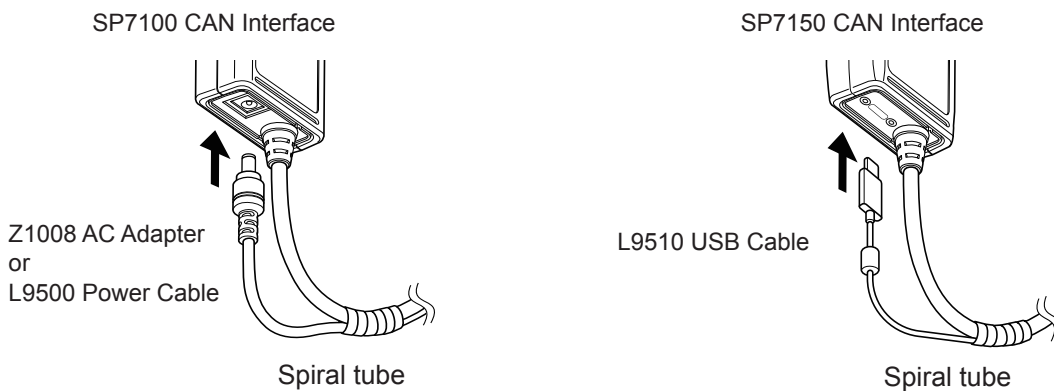

### L9500 Power Cable (dedicated option for SP7100)

To supply power to the CAN Interface, connect the L9500 Power Cable to a DC power supply. The L9500 Power Cable terminates in wires on one end. Wire the cable to your equipment as appropriate for your testing environment.

The SP7100 CAN Interface's power supply specifications are as follows: supply voltage of 10 V to 30 V DC and maximum rated power of 3.0 VA. The product can be connected to a DC power supply such as a vehicle's 12 V or 24 V system.

Wire the cable so that the center of the plug is positive (+).

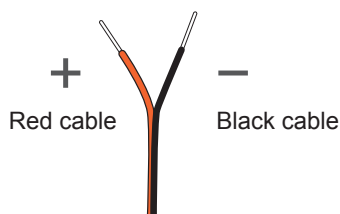

## 2.7 Connecting the Signal Probes to the CAN bus

Connect the tips of the SP9200 or SP9250 Signal Probes to the CAN bus. Connect the Signal Probe connected to the terminal labeled **HIGH** to the CAN\_H line and the other Signal Probe to the CAN\_L line.

### ⚠ CAUTION



Do not connect the probes to bare conductors with exposed metal or cables with damaged insulation. Do not allow the tips of the probes to come into contact with any energized part. Doing so may damage the equipment you are using (the vehicle) or cause it to malfunction.

### IMPORTANT

Any dirt on the cable under test could affect signal detection. Remove any dirt before affixing (connecting) the Signal Probe.

### When using the SP9200

#### Connecting probes

- 1 Insert the cable under test into the guard hook.



- 2 Rotate the grip to press the cable under test against the detection electrode.

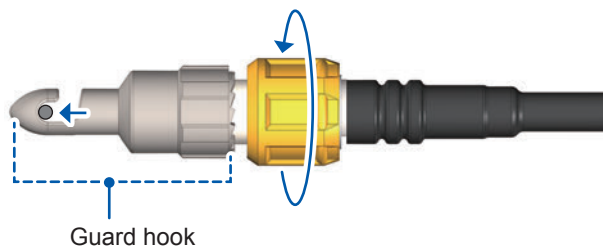

- 3 Tighten the grip until it no longer rotates.

The probe contains a built-in spring that supports the cable under test.

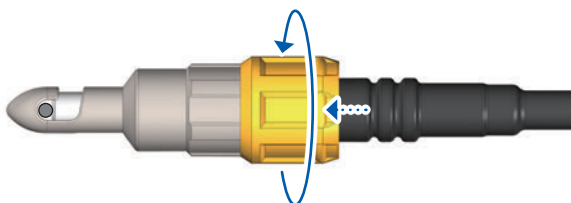

- Position the probe so that the cable under test is in contact with the back of the detection electrode.
- Proper detection will be impossible if the cable under test is positioned too shallowly or angled in the guard hook.

### Example of a poorly positioned cable

If the grip has not been tightened sufficiently, the detection electrode will move when the Signal Probe's sleeve is pulled. The Signal Probes are susceptible to the effects of nearby conductors (cables). Take care to keep the Signal Probes away from wires and other conductors since the magnitude of the effect is greater the closer the conductor is to the guard hook opening.

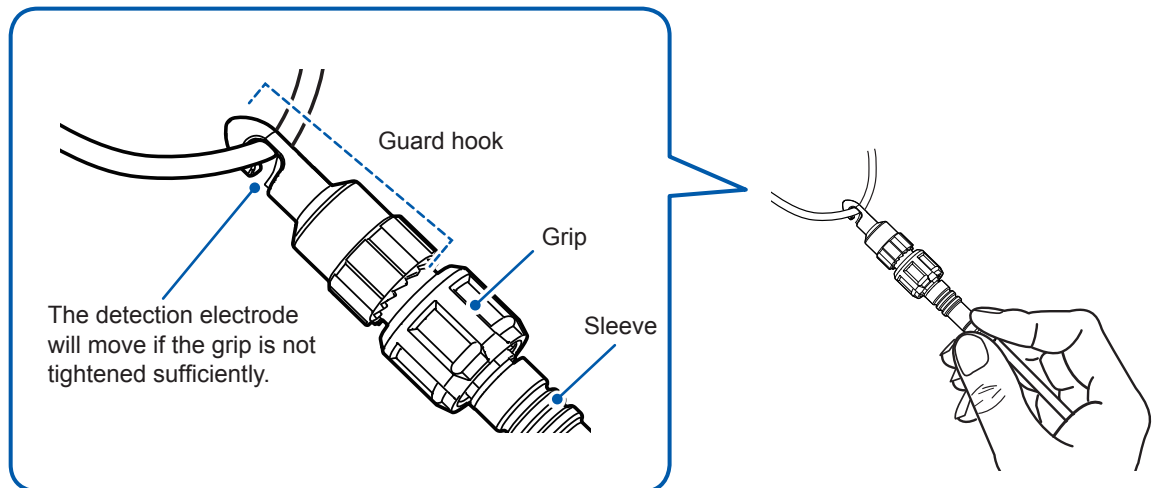

### Removing probes

To loosen a probe, rotate the grip while pulling it towards you.

The probe is designed so that while it is locked in place, the grip will be locked so that it cannot be rotated (to prevent inadvertent loosening).

#### 1 Rotate the grip while pulling it towards you.

The guard hook will open.

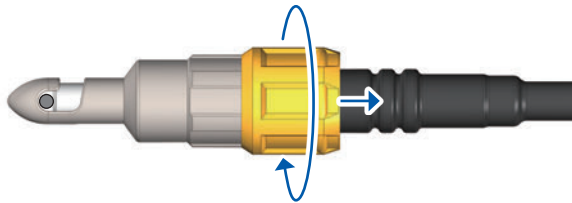

#### 2 Remove the cable under test.

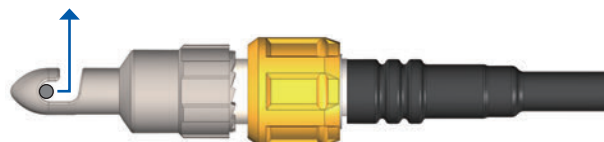

## When using the SP9250

### Connecting probes

- 1 Press the open/close lever.  
The guard hook will open.

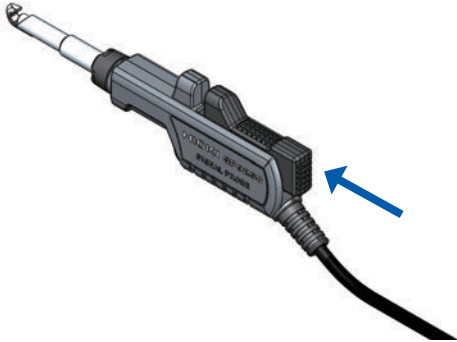

- 2 Clamp the hook around the cable whose signals you wish to detect and release the open/close lever.  
The probe will be secured to the cable under test.

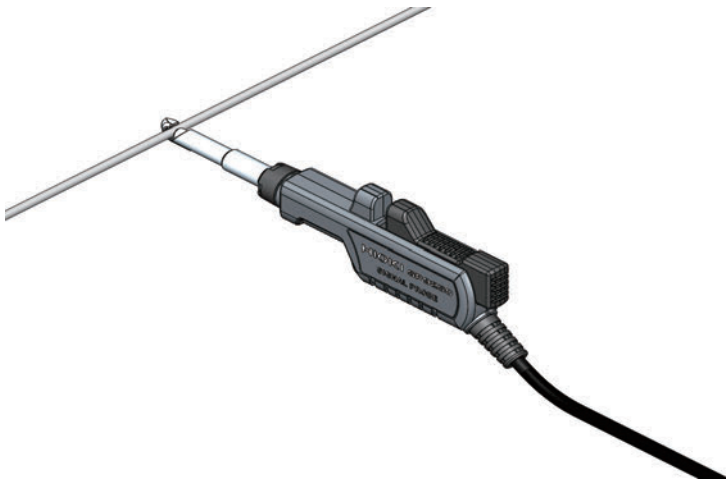

- Position the probe so that the cable under test is in contact with the back of the detection electrode.
- Proper detection will be impossible if the cable under test is positioned too shallowly or angled in the guard hook.

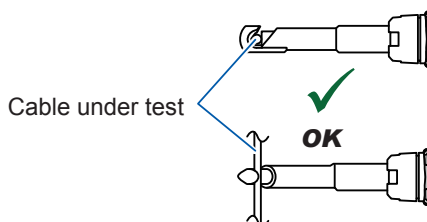

## 2.8 Inspecting the Product Before Use

Before using the product, inspect it for any damage that may have occurred during storage or shipment. If you find any damage, contact your authorized Hioki distributor or reseller.

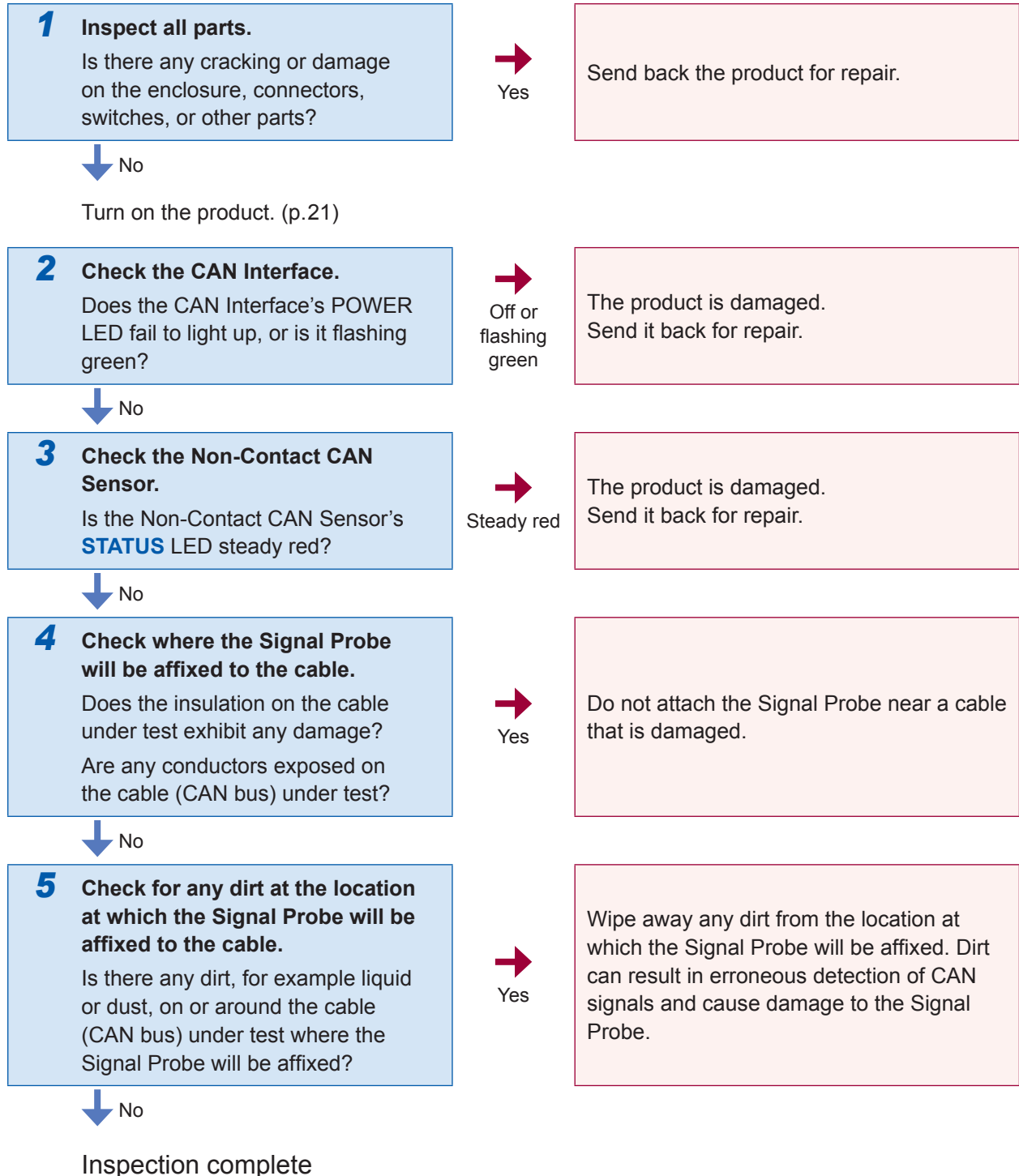



## 3 Functionality

### 3.1 Switching the Non-Contact CAN Sensor's Signal Detection Sensitivity

This section describes how to switch the Non-Contact CAN Sensor's signal detection sensitivity (**SENSITIVITY**). Use the **DEFAULT** setting for most applications. Select **HIGH** as necessary depending on the CAN signal level and cable effects.

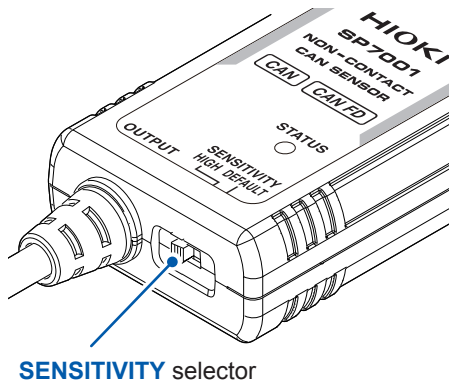

Setting	Description
<b>DEFAULT</b>	The DEFAULT setting represents the normal mode. It is recommended to use DEFAULT mode since it delivers the optimal level of vibration and noise resistance.
<b>HIGH</b>	The HIGH setting represents high-sensitivity mode. Use this mode when you encounter detection errors due to the low signal levels detected by the Signal Probes. The product is more susceptible to vibrations and various types of noise when used in this mode.

#### Situations where it may be necessary to use high-sensitivity mode

- When the differential voltage of the CAN communications signals on the CAN bus is low
- When the CAN bus cable has thick insulation
- When the CAN bus cable has rigid insulation

## 3.2 Probe Setting Function (Automatic Polarity Selection)

The probe setting function automatically selects the Signal Probe's polarity.

It is a convenient function that automatically switches the sensor input when the SP9200 or SP9250 signal probes have been connected in reverse to the Non-Contact CAN Sensor input label (HIGH/LOW).

### IMPORTANT

When performing rigorous evaluations, for example in bus testing that includes verification of wiring consistency, connect the high and low Signal Probes to the CAN bus's high and low lines and use fixed input polarity (**FIXED**) mode.

In automatic input polarity mode (**AUTO**), correct detection is not guaranteed under all conditions.

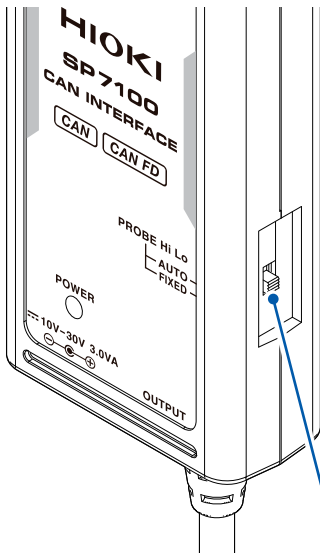

Probe setting selector

Setting	Description
<b>FIXED</b>	The <b>FIXED</b> setting represents fixed input polarity mode. If the Non-Contact CAN Sensor detects that the Signal Probes are connected to the CAN bus in reverse, it will indicate this state with the <b>STATUS</b> LED, which will flash red.
<b>AUTO</b>	The <b>AUTO</b> setting represents automatic input polarity mode. If the Non-Contact CAN Sensor detects that the Signal Probes are connected to the CAN bus in reverse, it will switch the high and low detected signals via its internal circuitry. This function will operate in approximately 2 seconds as long as the CAN bus load factor is approximately 5% or greater.



### 3.3 Output Bus Error Detection Function

This function determines that an output error has occurred when the SP7100 or SP7150 CAN Interface is unable to output a proper CAN signal to the bus connected to the CAN signal output connector.

The CAN interface output does not have CAN signal arbitration functionality. CAN communications signals detected by the Non-Contact CAN Sensor are output without modification.

The output bus error detection function operates when the Non-Contact CAN Sensor is connected properly to the CAN\_H and CAN\_L lines (as per the labels on the Non-Contact CAN Sensor inputs).

#### IMPORTANT

If the cable under test is not carrying proper CAN communications, error frames or other communications will be returned to the output bus by the device connected to the outputs. If that happens, the CAN Interface will determine that the output bus has encountered an error due to an inability to output the CAN signals.

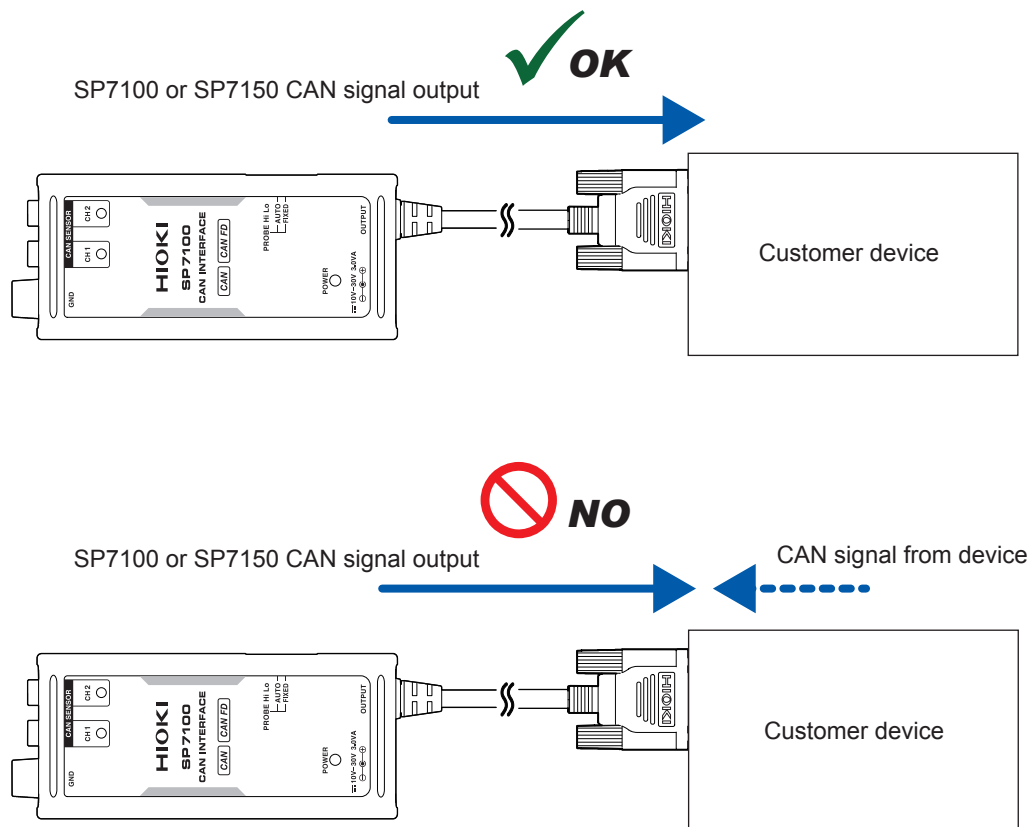



# 4

# Specifications

## 4.1 SP7001/SP7002 Non-Contact CAN Sensor

### 1. General specifications

<b>Operating environment</b>	Indoors, Pollution Degree 2, altitude up to 2000 m (6562 ft.)
<b>Operating temperature and humidity</b>	Temperature: -40°C to 85°C (-40°F to 185°F) Humidity: -40°C to 60°C (-40°F to 140°F), 80% RH or less (no condensation) 60°C to 85°C (140°F to 185°F), 60% RH or less (no condensation)
<b>Storage temperature and humidity</b>	-40°C to 85°C (-40°F to 185°F), 80% RH or less (no condensation)
<b>Dustproofness and waterproofness</b>	IP40 (EN 60529) When 2 Signal Probes connected
<b>Standards</b>	Safety: EN 61010 EMC: EN 61326, Class A
<b>Vibration resistance</b>	JIS D 1601:1995 5.3(1) Class 1: Passenger vehicles; conditions: Class A equivalent 4h along X-axis and 2h along Y- and Z-axes at a vibration acceleration of 45 m/s <sup>2</sup> (4.6 G)
<b>Power supply</b>	Supplied from SP7100 or SP7150
<b>External dimensions</b>	Approx. 44W × 85H × 20D mm (1.73"W × 3.35"H × 0.79"D) (excluding protruding parts)
<b>Weight</b>	Approx. 180 g (6.3 oz.) (including cables)
<b>Cable length</b>	Approx. 2.5 m
<b>Product warranty period</b>	3 years
<b>Accessories</b>	Refer to p.3.
<b>Options</b>	SP7100 CAN Interface SP7150 CAN Interface SP9200 Signal Probe SP9250 Signal Probe C1013 Carrying Case

The product's enclosure provides IP40 protection (as per EN 60529).

- IP40: Indicates the extent of the protection provided by the enclosure against approach to hazardous parts and ingress of foreign solid material and water.
- 4: The enclosure keeps a wire with a diameter of 1.0 mm from approaching hazardous parts. Components inside the enclosure are protected against foreign solid material that is at least 1.0 mm in size.
  - 0: Components inside the enclosure are protected against the adverse effects of water.

## 2. Input, output, and detection specifications

### (1) Basic specifications

<b>Detection method</b>	Capacitive-coupled signal detection (no direct wiring to cables under test)
<b>Signal Probe connector</b>	Special anti-vibration connectors Durability: 300 connect/disconnect cycles
<b>Ground terminal</b>	Hexagonal terminal with dedicated double SEMS M3×6 screws
<b>Ground terminal protected voltage</b>	30 V DC or less (no AC voltage protection)
<b>Output connector</b>	HR25-7TP-8P (72) (8-pin, plug, Hirose Electric Co., Ltd.)

### (2) Detection specifications

<b>Detection conditions</b>	Used in combination with SP9200 or SP9250 Within operating temperature and humidity range and below temperature at which cables under test become soft With ground connection cable connected to the signal source ground or equivalent No fluctuations in the transient potential between the ground terminal and the signal source (detection target) Detection of ISO 11898-2 compliant CAN bus signals
<b>Compatible cables</b>	AVS/AVSS-compliant cables
<b>Compatible cable diameter</b>	φ1.2 mm to 2.0 mm
<b>Compatible communications speeds</b>	CAN: 125 kbit/s to 1 Mbit/s (SP7001, SP7002) CAN FD: 125 kbit/s to 3 Mbit/s (SP7001)
<b>Total delay time (from detection of CAN signal to output)</b>	Combined with SP7100 or SP7150 CAN Interface 130 ns (typical)
<b>Differential detection level</b>	Recessive: 1.5 V (typical) or greater Dominant: 0.5 V (typical) or less
<b>Effects of nearby conductors</b>	No effects of an insulated cable to which a rectangular wave (3 MHz, 5 V p-p) is applied (reference)

**3. Function specifications**

<b>Signal detection function</b>	Operates when the CAN bus load factor is 5% or greater.											
<b>Probe HIGH/LOW reverse connection detection function</b>	Operates when the CAN bus load factor is 5% or greater. Detects when the Signal Probe connections to the CAN bus's CAN_H and CAN_L lines are reversed.											
<b>Probe setting function</b>	<p>Applies the CAN Interface settings when used in combination with the CAN Interface.</p> <ul style="list-style-type: none"> <li>• <b>FIXED</b> Outputs the detected signals without additional processing when it detects that the Signal Probe connections to the CAN bus's CAN_H and CAN_L lines are reversed.</li> <li>• <b>AUTO</b> Operates when the CAN bus load factor is 5% or greater. If the Non-Contact CAN Sensor detects that the Signal Probe connections to the CAN bus's CAN_H and CAN_L lines are reversed, switches the high and low connections via its internal circuitry.</li> </ul>											
<b>SENSITIVITY selection function</b>	<p>Set the Non-Contact CAN Sensor's sensitivity mode with the <b>SENSITIVITY</b> selector.</p> <ul style="list-style-type: none"> <li>• <b>DEFAULT</b>      Normal mode</li> <li>• <b>HIGH</b>            High-sensitivity mode</li> </ul>											
<b>LED lighting/flashing specifications</b>	<table border="1"> <thead> <tr> <th></th> <th><b>STATUS LED</b></th> </tr> </thead> <tbody> <tr> <td>Self-test error</td> <td>Steady red</td> </tr> <tr> <td>Signal not detected</td> <td>Steady green</td> </tr> <tr> <td>Signal detected</td> <td>Flashing green</td> </tr> <tr> <td>Probe high/low reverse connection warning</td> <td>Flashing red</td> </tr> </tbody> </table>			<b>STATUS LED</b>	Self-test error	Steady red	Signal not detected	Steady green	Signal detected	Flashing green	Probe high/low reverse connection warning	Flashing red
	<b>STATUS LED</b>											
Self-test error	Steady red											
Signal not detected	Steady green											
Signal detected	Flashing green											
Probe high/low reverse connection warning	Flashing red											

## 4.2 SP7100 CAN Interface

### 1. General specifications

<b>Operating environment</b>	Indoors, Pollution Degree 2, altitude up to 2000 m (6562 ft.)
<b>Operating temperature and humidity</b>	Temperature: -40°C to 85°C (-40°F to 185°F) Humidity: -40°C to 60°C (-40°F to 140°F), 80% RH or less (no condensation) 60°C to 85°C (140°F to 185°F), 60% RH or less (no condensation)
<b>Storage temperature and humidity</b>	-40°C to 85°C (-40°F to 185°F), 80% RH or less (no condensation)
<b>Dustproofness and waterproofness</b>	IP40 (EN 60529) When Non-Contact CAN Sensor connected to both CH1 and CH2
<b>Standards</b>	Safety: EN 61010 EMC: EN 61326, Class A
<b>Vibration resistance</b>	JIS D 1601:1995 5.3(1) Class 1: Passenger vehicles; conditions: Class A equivalent 4 h along X-axis and 2 h along Y- and Z-axes at a vibration acceleration of 45 m/s <sup>2</sup> (4.6 G)
<b>Power supply</b>	<ul style="list-style-type: none"> <li>• Z1008 AC Adapter Rated supply voltage: 100 V to 240 V AC (accommodates to fluctuations within a range of ±10% of the rated supply voltage) Rated power supply frequency: 50 Hz/60 Hz Anticipated transient overvoltage: 2500 V</li> <li>• External power supply Rated supply voltage: 10 V to 30 V DC</li> </ul>
<b>Maximum rated power</b>	When using the Z1008 AC Adapter: 8 VA (including AC adapter), 3 VA (product only) When using external power supply: 3 VA
<b>Dimensions</b>	Approx. 55W × 120H × 25D mm (2.17"W × 4.72"H × 0.98"D) (excluding protruding parts)
<b>Weight</b>	Approx. 130 g (4.6 oz.) (including cables)
<b>Cable length</b>	D-sub connector cable: Approx. 0.3 m
<b>Product warranty period</b>	3 years
<b>Accessories</b>	Refer to p.3.
<b>Options</b>	SP7001 Non-Contact CAN Sensor SP7002 Non-Contact CAN Sensor L9500 Power Cable (for connecting an external battery; terminates in wires; approx. 2 m long) SP9900 Split Cable Z1008 AC Adapter C1013 Carrying Case

## 2. Input and output specifications

### (1) Basic specifications

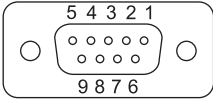
<b>CAN sensor connector</b>	HR25-7TR-8S (73) (8-pin, socket, Hirose Electric Co., Ltd.) Number of interfaces: 2 channels (common device and channel ground)																															
<b>CAN signal output connector</b>	D-sub 9-pin (female) Set screws: Inch screw thread #4-40 UNC																															
	Pin assignments																															
																																
	<table border="1"> <thead> <tr> <th>Pin</th> <th>Assignment</th> <th>Functionality</th> </tr> </thead> <tbody> <tr> <td>1</td> <td>CH2 CAN_L</td> <td>CAN 2 CAN_Low communications line</td> </tr> <tr> <td>2</td> <td>CH1 CAN_L</td> <td>CAN 1 CAN_Low communications line</td> </tr> <tr> <td>3</td> <td>CH1 GND</td> <td>GND</td> </tr> <tr> <td>4</td> <td>N.C.</td> <td>Unused</td> </tr> <tr> <td>5</td> <td>Shield</td> <td>Shield (CH1/CH2 common)</td> </tr> <tr> <td>6</td> <td>CH2 GND</td> <td>GND</td> </tr> <tr> <td>7</td> <td>CH1 CAN_H</td> <td>CAN 1 CAN_High communications line</td> </tr> <tr> <td>8</td> <td>CH2 CAN_H</td> <td>CAN 2 CAN_High communications line</td> </tr> <tr> <td>9</td> <td>N.C.</td> <td>Unused</td> </tr> </tbody> </table>	Pin	Assignment	Functionality	1	CH2 CAN_L	CAN 2 CAN_Low communications line	2	CH1 CAN_L	CAN 1 CAN_Low communications line	3	CH1 GND	GND	4	N.C.	Unused	5	Shield	Shield (CH1/CH2 common)	6	CH2 GND	GND	7	CH1 CAN_H	CAN 1 CAN_High communications line	8	CH2 CAN_H	CAN 2 CAN_High communications line	9	N.C.	Unused	
Pin	Assignment	Functionality																														
1	CH2 CAN_L	CAN 2 CAN_Low communications line																														
2	CH1 CAN_L	CAN 1 CAN_Low communications line																														
3	CH1 GND	GND																														
4	N.C.	Unused																														
5	Shield	Shield (CH1/CH2 common)																														
6	CH2 GND	GND																														
7	CH1 CAN_H	CAN 1 CAN_High communications line																														
8	CH2 CAN_H	CAN 2 CAN_High communications line																														
9	N.C.	Unused																														
<b>Ground terminal</b>	Banana input terminal																															

### (2) Input and output specifications

<b>Specifications conditions</b>	<ul style="list-style-type: none"> <li>• Within operating temperature and humidity range</li> <li>• With ground connection cable connected to the signal source ground or equivalent</li> <li>• No fluctuations in the transient potential between the ground terminal and the signal source (detection target)</li> <li>• Output load (internal): <math>R_L = 60 \Omega</math> (typical)</li> </ul>
<b>Compatible communications speeds</b>	CAN: 125 kbit/s to 1 Mbit/s CAN FD: 125 kbit/s to 3 Mbit/s Defined only when CAN signal output connector is connected directly to target device or when connected via the SP9900 Split Cable.
<b>CAN transceiver</b>	TCAN1051GV (SP7100 does not have receiver function and communications arbitration function.)
<b>Total delay time (from detection of CAN signal to output)</b>	In combination with SP7001/SP7002 Non-Contact CAN Sensor 130 ns (typical)
<b>CAN terminal resistance</b>	60 $\Omega$ (typical) built in

### 3. Function specifications

**Probe setting selector (Setting applies to both CH1 and CH2)** Serves as a switch for setting the Non-Contact CAN Sensor's probe setting function when used in combination with the Non-Contact CAN Sensor.

- **FIXED**  
Outputs the detected signals without additional processing even if the Non-Contact CAN Sensor detects that the Signal Probe connections to the CAN bus's CAN\_H and CAN\_L lines are reversed.
- **AUTO**  
If the Non-Contact CAN Sensor detects that the Signal Probe connections to the CAN bus's CAN\_H and CAN\_L lines are reversed, switches the high and low connections via its internal circuitry.

**Output bus error detection function (Configured separately for CH1 and CH2)**

- This function determines that an output error has occurred when signals other than output from the CAN Interface are present on the bus output from the device connected to the CAN signal output connector.
- The output bus error detection function will not operate if the Non-Contact CAN Sensor's probe CAN\_H/CAN\_L reverse connection detection function determines that the Signal Probes have been connected to the CAN bus's CAN\_H and CAN\_L lines in reverse.
- If an output bus error is detected, the LED is displayed according to LED lightning/ flashing specifications.

**LED lightning/flashing specifications**

	LED		
	POWER	CH1	CH2
Self-test error	Flashing	Steady red	Steady red
CAN sensor not connected	Steady (on)	Off	Off
CAN sensor connected	Steady (on)	Reflects CAN sensor STATUS (according to STATUS)	
Output bus error detection function	Steady (on)	Flashes, alternately quickly between the red and green LEDs for the channel on which the output bus error was detected.	



## 4.3 SP7150 CAN Interface

### 1. General specifications

<b>Operating environment</b>	Indoors, Pollution Degree 2, altitude up to 2000 m (6562 ft.)
<b>Operating temperature and humidity</b>	Temperature: -40°C to 85°C (-40°F to 185°F) Humidity: -40°C to 60°C (-40°F to 140°F), 80% RH or less (no condensation) 60°C to 85°C (140°F to 185°F), 60% RH or less (no condensation)
<b>Storage temperature and humidity</b>	-40°C to 85°C (-40°F to 185°F), 80% RH or less (no condensation)
<b>Dustproofness and waterproofness</b>	IP40 (EN 60529) When Non-Contact CAN Sensor connected
<b>Standards</b>	Safety: EN 61010 EMC: EN 61326, Class A
<b>Vibration resistance</b>	JIS D 1601:1995 5.3(1) Class 1: Passenger vehicles; conditions: Class A equivalent 4 h along X-axis and 2 h along Y- and Z-axes at a vibration acceleration of 45 m/s <sup>2</sup> (4.6 G)
<b>Power supply</b>	<ul style="list-style-type: none"> <li>• USB bus power USB-C terminal 5 V ±0.25 V DC</li> <li>• Z1013 AC Adapter (5 V DC, 2.6 A) Rated supply voltage: 100 V to 240 V AC Rated power supply frequency: 50 Hz/60 Hz Anticipated transient overvoltage: 2500 V</li> </ul>
<b>Maximum rated power</b>	When using USB bus power: 1 VA When using the Z1013 AC Adapter: 6 VA (including AC adapter)
<b>Dimensions</b>	Approx. 47W × 100H × 20D mm (1.85"W × 3.94"H × 0.79"D) (excluding protruding parts)
<b>Weight</b>	Approx. 100 g (3.5 oz.) (including cables)
<b>Cable length</b>	D-sub connector cable: Approx. 0.3 m
<b>Product warranty period</b>	3 years
<b>Accessories</b>	Refer to p.4.
<b>Options</b>	SP7001 Non-Contact CAN Sensor SP7002 Non-Contact CAN Sensor L9510 USB Cable Z1013 AC Adapter C1013 Carrying Case

## 2. Input and output specifications

### (1) Basic specifications

<b>CAN sensor connector</b>	HR25-7TR-8S (73) (8-pin, socket, Hirose Electric Co., Ltd.) Number of interfaces: 1 channel (common device and channel ground)																															
<b>CAN signal output connector</b>	D-sub 9-pin (female) Set screws: Inch screw thread #4-40 UNC																															
	Pin assignments																															
	<table border="1"> <thead> <tr> <th>Pin</th> <th>Assignment</th> <th>Functionality</th> </tr> </thead> <tbody> <tr> <td>1</td> <td>N.C.</td> <td>Unused</td> </tr> <tr> <td>2</td> <td>CAN_L</td> <td>CAN_Low communications line</td> </tr> <tr> <td>3</td> <td>GND</td> <td>GND</td> </tr> <tr> <td>4</td> <td>N.C.</td> <td>Unused</td> </tr> <tr> <td>5</td> <td>Shield</td> <td>Shield</td> </tr> <tr> <td>6</td> <td>N.C.</td> <td>Unused</td> </tr> <tr> <td>7</td> <td>CAN_H</td> <td>CAN_High communications line</td> </tr> <tr> <td>8</td> <td>N.C.</td> <td>Unused</td> </tr> <tr> <td>9</td> <td>N.C.</td> <td>Unused</td> </tr> </tbody> </table>		Pin	Assignment	Functionality	1	N.C.	Unused	2	CAN_L	CAN_Low communications line	3	GND	GND	4	N.C.	Unused	5	Shield	Shield	6	N.C.	Unused	7	CAN_H	CAN_High communications line	8	N.C.	Unused	9	N.C.	Unused
Pin	Assignment	Functionality																														
1	N.C.	Unused																														
2	CAN_L	CAN_Low communications line																														
3	GND	GND																														
4	N.C.	Unused																														
5	Shield	Shield																														
6	N.C.	Unused																														
7	CAN_H	CAN_High communications line																														
8	N.C.	Unused																														
9	N.C.	Unused																														
<b>Ground terminal</b>	Banana input terminal																															

### (2) Input and output specifications

<b>Specifications conditions</b>	<ul style="list-style-type: none"> <li>• Within operating temperature and humidity range</li> <li>• With ground connection cable connected to the signal source ground or equivalent</li> <li>• No fluctuations in the transient potential between the ground terminal and the signal source (detection target)</li> <li>• Output load (internal): <math>R_L = 60 \Omega</math> (typical)</li> </ul>
<b>Compatible communications speeds</b>	CAN: 125 kbit/s to 1 Mbit/s CAN FD: 125 kbit/s to 3 Mbit/s Connect CAN signal output connector directly to target device
<b>CAN transceiver</b>	TCAN1051GV (SP7150 does not have receiver function and communications arbitration function.)
<b>Total delay time (from detection of CAN signal to output)</b>	In combination with SP7001/SP7002 Non-Contact CAN Sensor 130 ns (typical)
<b>CAN terminal resistance</b>	60 $\Omega$ (typical) built in

### 3. Function specifications

<b>Probe setting selector</b>	Serves as a switch for setting the Non-Contact CAN Sensor's probe setting function when used in combination with the Non-Contact CAN Sensor.																		
	<ul style="list-style-type: none"> <li>• <b>FIXED</b> Outputs the detected signals without additional processing even if the Non-Contact CAN Sensor detects that the Signal Probe connections to the CAN bus's CAN_H and CAN_L lines are reversed.</li> <li>• <b>AUTO</b> If the Non-Contact CAN Sensor detects that the Signal Probe connections to the CAN bus's CAN_H and CAN_L lines are reversed, switches the high and low connections via its internal circuitry.</li> </ul>																		
<b>Output bus error detection function</b>	<ul style="list-style-type: none"> <li>• This function determines that an output error has occurred when signals other than output from the CAN Interface are present on the bus output from the device connected to the CAN signal output connector.</li> <li>• The output bus error detection function will not operate if the Non-Contact CAN Sensor's probe CAN_H/CAN_L reverse connection detection function determines that the Signal Probes have been connected to the CAN bus's CAN_H and CAN_L lines in reverse.</li> <li>• If an output bus error is detected, the LED is displayed according to LED lightning/flashing specifications.</li> </ul>																		
<b>LED lightning/flashing specifications</b>	<table border="1" style="width: 100%; border-collapse: collapse;"> <thead> <tr> <th rowspan="2"></th> <th colspan="2" style="text-align: center;">LED</th> </tr> <tr> <th style="text-align: center;">POWER</th> <th style="text-align: center;">STATUS</th> </tr> </thead> <tbody> <tr> <td>Self-test error</td> <td style="text-align: center;">Flashing</td> <td style="text-align: center;">Steady red</td> </tr> <tr> <td>CAN sensor not connected</td> <td style="text-align: center;">Steady (on)</td> <td style="text-align: center;">Off</td> </tr> <tr> <td>CAN sensor connected</td> <td style="text-align: center;">Steady (on)</td> <td style="text-align: center;">Reflects CAN sensor STATUS (according to STATUS)</td> </tr> <tr> <td>Output bus error detection function</td> <td style="text-align: center;">Steady (on)</td> <td style="text-align: center;">Flashes, alternately quickly between the red and green LEDs for the channel on which the output bus error was detected.</td> </tr> </tbody> </table>			LED		POWER	STATUS	Self-test error	Flashing	Steady red	CAN sensor not connected	Steady (on)	Off	CAN sensor connected	Steady (on)	Reflects CAN sensor STATUS (according to STATUS)	Output bus error detection function	Steady (on)	Flashes, alternately quickly between the red and green LEDs for the channel on which the output bus error was detected.
	LED																		
	POWER	STATUS																	
Self-test error	Flashing	Steady red																	
CAN sensor not connected	Steady (on)	Off																	
CAN sensor connected	Steady (on)	Reflects CAN sensor STATUS (according to STATUS)																	
Output bus error detection function	Steady (on)	Flashes, alternately quickly between the red and green LEDs for the channel on which the output bus error was detected.																	

## 4.4 SP9200 Signal Probe

### 1. General specifications

<b>Operating environment</b>	Indoors, Pollution Degree 2, altitude up to 2000 m (6562 ft.)
<b>Operating temperature and humidity range</b>	Temperature: -40°C to 85°C (-40°F to 185°F) Humidity: -40°C to 60°C (-40°F to 140°F), 80% RH or less (no condensation) 60°C to 85°C (140°F to 185°F), 60% RH or less (no condensation)
<b>Storage temperature and humidity range</b>	-40°C to 85°C (-40°F to 185°F), 80% RH or less (no condensation)
<b>Standards</b>	Safety: EN 61010
<b>Vibration resistance</b>	JIS D 1601:1995 5.3(1) Class 1: Passenger vehicles; conditions: Class A equivalent 4h along X-axis and 2h along Y- and Z-axes at a vibration acceleration of 45 m/s <sup>2</sup> (4.6 G)
<b>Number of probes</b>	2
<b>Dimensions</b>	Probe: Approx. $\phi$ 11.6 × 33.7H mm ( $\phi$ 0.46" × 1.33"H) (excluding protruding parts and cable) Guard hook: Approx. $\phi$ 5 × 11.8H mm ( $\phi$ 0.20" × 0.46"H)
<b>Weight</b>	Approx. 26 g (0.9 oz.) (weight of 1 Signal Probe, including cable)
<b>Cable length</b>	Approx. 0.5 m
<b>Options</b>	SP7001 Non-Contact CAN Sensor SP7002 Non-Contact CAN Sensor C1013 Carrying Case

### 2. Input, output, and detection specifications

#### (1) Basic specifications

<b>Detection method</b>	Capacitive-coupled signal detection (no direct wiring to cables under test)
<b>Output connector</b>	Special anti-vibration connectors Durability: 100 insert/remove cycles
<b>Detection conditions</b>	Within operating temperature and humidity range and below temperature at which cables under test become soft
<b>Compatible cables</b>	AVS/AVSS-compliant cables
<b>Compatible cable diameter</b>	$\phi$ 1.2 mm to 2.0 mm

## 4.5 SP9250 Signal Probe

### 1. General specifications

<b>Operating environment</b>	Indoors, Pollution Degree 2, altitude up to 2000 m (6562 ft.)
<b>Operating temperature and humidity range</b>	Temperature: -40°C to 85°C (-40°F to 185°F) Humidity: -40°C to 60°C (-40°F to 140°F), 80% RH or less (no condensation) 60°C to 85°C (140°F to 185°F), 60% RH or less (no condensation)
<b>Storage temperature and humidity range</b>	-40°C to 85°C (-40°F to 185°F), 80% RH or less (no condensation)
<b>Standards</b>	Safety: EN 61010
<b>Vibration resistance</b>	JIS D 1601:1995 5.3(1) Class 1: Passenger vehicles; conditions: Class A equivalent 4h along X-axis and 2h along Y- and Z-axes at a vibration acceleration of 45 m/s <sup>2</sup> (4.6 G)
<b>Number of probes</b>	2
<b>Dimensions</b>	Probe: Approx. 10.5W × 24.5H × 101D mm (0.41"W × 0.96"H × 3.98"D) (excluding protruding parts and cable) Guard hook: Approx. $\phi$ 5.5 × 30.8H mm ( $\phi$ 0.22" × 1.21"H)
<b>Weight</b>	Approx. 44.6 g (1.6 oz.) (weight of 1 Signal Probe, including cable)
<b>Cable length</b>	Approx. 0.8 m
<b>Options</b>	SP7001 Non-Contact CAN Sensor SP7002 Non-Contact CAN Sensor C1013 Carrying Case

### 2. Input, output, and detection specifications

#### (1) Basic specifications

<b>Detection method</b>	Capacitive-coupled signal detection (no direct wiring to cables under test)
<b>Output connector</b>	Special anti-vibration connectors Durability: 100 insert/remove cycles
<b>Detection conditions</b>	Within operating temperature and humidity range and below temperature at which cables under test become soft
<b>Compatible cables</b>	AVS/AVSS-compliant cables
<b>Compatible cable diameter</b>	$\phi$ 1.2 mm to 2.0 mm
<b>Durability</b>	10,000 times

## 4.6 SP9900 Split Cable (dedicated option for SP7100)

### 1. General specifications

<b>Operating environment</b>	Indoors, Pollution Degree 2, altitude up to 2000 m (6562 ft.)
<b>Operating temperature and humidity</b>	-40°C to 85°C (-40°F to 185°F), 80% RH or less (no condensation)
<b>Storage temperature and humidity</b>	-40°C to 85°C (-40°F to 185°F), 80% RH or less (no condensation)
<b>Dimensions</b>	Overall length: Approx. 390 mm (15.35")
<b>Weight</b>	Approx. 95 g (3.4 oz.) (including cables)
<b>Cable length</b>	Approx. 0.3 m

### 2. Input and output specifications

#### (1) Basic specifications

<b>Input connector</b>	D-sub 9-pin (male) Set screws: Inch screw thread #4-40 UNC
<b>Output connector</b>	D-sub 9-pin (female) Set screws: Inch screw thread #4-40 UNC

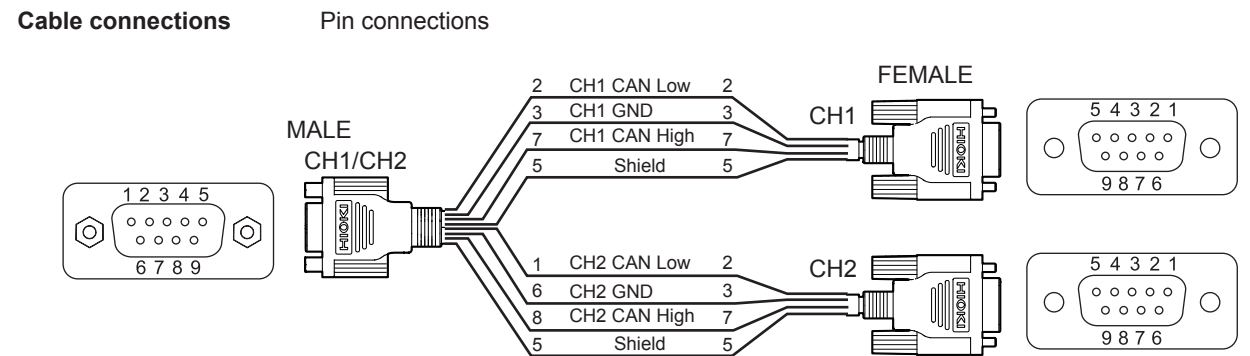

Pin assignments

IN		OUT			
MALE		FEMALE CH1		FEMALE CH2	
Pin	Assignment	Pin	Assignment	Pin	Assignment
1	CH2 CAN Low	1	N.C.	1	N.C.
2	CH1 CAN Low	2	CH1 CAN Low	2	CH2 CAN Low
3	CH1 GND	3	CH1 GND	3	CH2 GND
4	N.C.	4	N.C.	4	N.C.
5	Shield	5	Shield	5	Shield
6	CH2 GND	6	N.C.	6	N.C.
7	CH1 CAN High	7	CH1 CAN High	7	CH2 CAN High
8	CH2 CAN High	8	N.C.	8	N.C.
9	N.C.	9	N.C.	9	N.C.

# 5

## Maintenance and Service

### WARNING



Do not attempt to modify, disassemble, or repair the product. Doing so may result in fire, electric shock, or bodily injury.

### Stowing the product in the C1013 Carrying Case

### WARNING



Do not leave the C1013 Carrying Case in locations where it would be subject to direct sunlight or high temperatures, for example inside a vehicle. High temperatures may deform the shape of the inside of the case.

Stow the product in the C1013 Carrying Case with connectors connected.



## Precautions when shipping the product

### **IMPORTANT**

When shipping the product, do not disconnect the SP9200/SP9250 Signal Probe from the SP7001/SP7002 Non-Contact CAN Sensor. Doing so may soil or degrade the connectors' contacts, adversely impacting signal detection.

When sending the product to be repaired, attach a description of the issue.

## Cleaning

### **IMPORTANT**

Remove any dirt from the Signal Probes' detection electrodes and guard hooks by wiping them lightly with a clean, dry industrial-use cotton swab. The presence of any dirt or other foreign material on the Signal Probes' guard hooks or detection electrodes may adversely affect signal detection. Fibers and other material that get into the Signal Probes' moving parts could cause them to malfunction.

If the product becomes dirty, moisten a soft cloth with water or neutral detergent and gently wipe it clean.



## 5.1 Troubleshooting

If damage is suspected, contact your authorized Hioki distributor or reseller after reviewing the contents below.

### CAN signal detection is unstable.

Check/consider	Solutions	See
<ul style="list-style-type: none"> <li>Have the Signal Probes been connected properly to the cable (CAN bus) under test?</li> </ul>	<ul style="list-style-type: none"> <li>Verify that the cable (CAN bus) under test has been properly inserted between the detection electrode and guard hook.</li> <li>If the Signal Probe has not been connected (tightened) properly, the product may not be able to detect signals stably.</li> <li>Review the method for connecting the Signal Probes.</li> </ul>	<p>p.22 p.24</p>
<ul style="list-style-type: none"> <li>Is there any dirt on the Signal Probe's detection electrode or guard hook, or on the location on the cable (CAN bus) under test where the Signal Probe will be affixed?</li> </ul>	<ul style="list-style-type: none"> <li>Remove any dirt from the Signal Probe's detection electrode and guard hook.</li> </ul>	p.44
	<ul style="list-style-type: none"> <li>Wipe away any dirt from the location on the cable (CAN bus) under test where the Signal Probe will be affixed.</li> </ul>	–
<ul style="list-style-type: none"> <li>Has the ground connection cable been properly connected?</li> </ul>	<ul style="list-style-type: none"> <li>Connect the ground connection cable to the CAN signal source ground or to the vehicle's body (ground connected to the vehicle battery's negative terminal or body ground).</li> </ul>	p.18
	<ul style="list-style-type: none"> <li>You will not be able to detect CAN signals properly if the ground connection cable is connected to a metal object that is insulated from the vehicle's ground (ground connected to the vehicle battery's negative terminal or body ground). If you are unsure where to connect the ground connection cable, first check for continuity between the metal part you are considering and the vehicle's body ground and then connect the ground connection cable.</li> </ul>	p.18
<ul style="list-style-type: none"> <li>Does the SP7100 CAN Interface's <b>CH1</b> or <b>CH2</b> LED flash red/green alternately at high speed?</li> </ul>	<ul style="list-style-type: none"> <li>Check the settings for the device to which the CAN Interface's output is connected to see if that device may be outputting a signal.</li> <li>If the LED flashes red/green alternately at high speed, it indicates that the device to which the CAN Interface's output is connected may be outputting a signal.</li> </ul>	p.29
<ul style="list-style-type: none"> <li>Does the SP7150 CAN Interface's <b>STATUS</b> LED flash red/green alternately at high speed?</li> </ul>		

**You are unable to detect CAN signals stably when using the product in an environment where it is exposed to vibrations, for example in road testing.**

.....

Check/consider	Solutions	See
<ul style="list-style-type: none"> <li>• Are the Signal Probes connected properly to the Non-Contact CAN Sensor?</li> </ul>	<ul style="list-style-type: none"> <li>• The Signal Probe's connector incorporates a locking mechanism. Verify that the lock is fully engaged.</li> </ul>	<p>p.16</p>
<ul style="list-style-type: none"> <li>• Have the Signal Probes been affixed properly to the cable (CAN bus) under test?</li> </ul>	<ul style="list-style-type: none"> <li>• Fix the Signal Probes and cable (CAN bus) under test in place so that they do not vibrate.</li> </ul>	<p>p.22 p.24</p>
<ul style="list-style-type: none"> <li>• Are the Signal Probes or the cable (CAN bus) under test unstable?</li> </ul>		



