



STARTER 5000

Bench pH Meter
Instruction Manual

STARTER 5000

Medidor de pH de banco
Manual de instrucciones

STARTER 5000

PH-mètre de laboratoire
Manuel d'instructions

TABLE OF CONTENTS

1	INTRODUCTION	1
1.1	Definition of Signal Warnings and Symbols	1
1.2	Safety Precautions.....	2
2	INSTALLATION	3
2.1	Package contents.....	3
2.2	Installing the stand-alone electrode holder.....	4
2.3	Installing the power adapter	4
2.4	Connect the pH electrodes	5
3	DISPLAY AND ICONS	5
3.1	Turn on the meter.....	5
3.2	Turn off the meter.....	6
3.3	Icons.....	6
3.4	Menu directory	9
4	CALIBRATION, MEASUREMENT AND PRINT	10
4.1	Calibration	10
4.1.1	Buffer group	10
4.1.2	Performing calibration	11
4.2	Sample measurement.....	12
4.2.1	pH measurement	12
4.2.2	mV and Rel.mV measurement.....	12
4.3	Temperature measurement.....	12
4.4	Printing.....	13
5	SETUP	14
5.1	System Setting	14
5.1.1	System setting ► Save Mode	14
5.1.2	System Setting ► Output	14
5.1.3	System Setting ► Restore Factory Setup	14
5.1.4	System Setting ► Service Password	14
5.2	Measurement Setting.....	15
5.2.1	Measurement Setting ► Endpoint Mode.....	15
5.2.2	Measurement Setting ► GLP Measurement Mode.....	15
5.2.3	Measurement Setting ► Continuous Measure.....	15
5.3	Calibration Setting	16
5.3.1	Calibration Setting ► Buffer Group	16
5.3.2	Calibration Setting ► Calibration Reminder	16
5.4	Data Log.....	16
6	MAINTENANCE	17
6.1	Error message.....	17
6.2	Meter maintenance	17

6.3	Electrode maintenance.....	17
6.4	Information	17
7	TECHNICAL DATA	18
7.1	Specifications.....	18
8	COMPLIANCE	19
9	BUFFER GROUPS	20

1 INTRODUCTION

Thank you for choosing this OHAUS product.

Please read the manual completely before using the STARTER 5000 bench pH meter to avoid incorrect operation.

STARTER 5000 is a 0.001pH bench meter with a color touch-screen LCD. It's a new generation of intuitive and easy-to-use bench meters for reliable measurements.

A few of the many existing features are:

- Bi-lingual graphical user interface
- Auto, manual time endpoint which can assist users to freeze the stable reading value to meet different customer requirements
- 8 buffer groups (US, EU, NIST and JG) with 1 self-defined buffer
- IP54 water and dust protection

1.1 Definition of Signal Warnings and Symbols

Safety notes are marked with signal words and warning symbols. These show safety issues and warnings. Ignoring the safety notes may lead to personal injury, damage to the instrument, malfunctions and false results.

Signal Words

WARNING	For a hazardous situation with medium risk, possibly resulting in injuries or death if not avoided.
CAUTION	For a hazardous situation with low risk, resulting in damage to the device or the property or in loss of data, or injuries if not avoided.
Attention	For important information about the product
Note	For useful information about the product

Warning Symbols



General Hazard



Electrical Shock Hazard



Explosion Hazard



Corrosive Hazard



Alternating Current



Direct Current

1.2 Safety Precautions



CAUTION Read all safety warnings before installing, making connections, or servicing this equipment. Failure to comply with these warnings could result in personal injury and/or property damage. Retain all instructions for future reference.

- Verify that the AC adapter's input voltage range and the plug type are compatible with the local AC power supply.
- Make sure that the power cord does not pose a potential obstacle or tripping hazard.
- Use the equipment only in dry locations.
- Dry off any liquid spills immediately. The instrument is not watertight.
- Use only approved accessories and peripherals.
- Operate the equipment only under ambient conditions specified in these instructions.
- Disconnect the equipment from the power supply when cleaning.
- Do not operate the equipment in hazardous or unstable environments.
- Service should only be performed by authorized personnel.
- If the equipment is used in a manner not specified by the manufacturer, the protection provided by the equipment may be impaired.



WARNING Do not use this instrument in an environment subject to explosion hazards. The housing of the instrument is not gas tight (explosion hazard due to spark formation, corrosion caused by the ingress of gases).



CAUTION When using chemicals and solvents, comply with the instructions of the producer and the general lab safety rules.

2 INSTALLATION

Carefully unpack the box.

2.1 Package contents

The model ST5000-B (basic package) has the following items:

ST5000-B	Units
ST5000 meter	1
ST5000 In use cover	1
Stand-alone electrode holder	1 set
4GB USB flash drive	1
Buffer powder set (4.01; 7.00; 10.00)	1 set
Power supply	1 set

In addition to ST5000-B content, the ST5000-F package also includes the following:

ST350 3-in-1 glass refillable pH electrode	1
--	---

Each pH buffer powder should be dissolved in 250ml pure water or deionized water in a volumetric flask. You also can order the bottled buffer solution from Ohaus.

More electrodes, solutions, accessories and spare parts, please contact Ohaus for more details.

Model	Description	P/N
ST350	3-in-1 glass refillable pH Electrode	30129354
ST310	3-in-1 plastic refillable pH Electrode	83033965
ST210	2-in-1 plastic refillable pH Electrode	83033966
ST320	3-in-1 plastic gel pH Electrode(no need to fill)	83033967
ST260	2-in 1 glass double salt bridge pH Electrode	30129357
ST230	2-in-1 glass muddy sample pH Electrode	83033968
STSURF	2-in-1 flat surface pH Electrode	30129470
STMICRO5	2-in-1 glass micro sample pH Electrode	30087566
STMICRO8	2-in-1 glass micro sample pH Electrode	30087569
STTEMP30	Temperature Electrode	83033970
STORP1	Gel plastic ORP electrode	30038555
STORP2	Refillable glass ORP electrode	30038553

Buffer powder set (4.01; 7.00; 10.0)	83033971
Buffer pH1.68 250ml	30100424
Buffer pH4.01 250ml	30100425
Buffer pH7.00 250ml	30100427
Buffer pH10.01 250ml	30100429
Buffer pH12.45 250ml	30100440
pH electrode Reference Electrolyte	30059255
pH electrode protection solution	30059256
Electrode holder stand alone	30058733
ST5000 In use cover	30129897
SP Cable Adapter RS232 F-M SF40A (for ST5000)	30059316

2.2 Installing the stand-alone electrode holder

Install the electrode arm on the base:

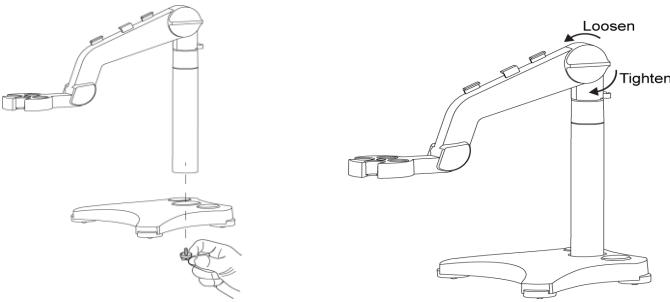

After adjusting the tension knob to some extent, the upper arm can be move up and down. When the pH electrode is placed on the arm and calibration or measurement is being performed, the storage bottle of pH electrode can be placed into the base hole for easy storage:

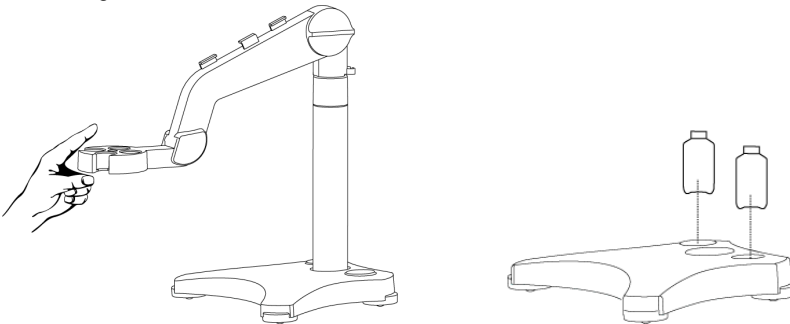

2.3 Installing the power adapter

Insert the adapter plug into the power adapter slot.

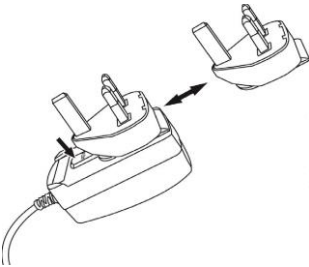

CAUTION Only use an adapter plug that is compatible with the mains power receptacle. Make sure that the adapter plug is fully seated in the power adapter slot before plugging it into the mains power receptacle.

2.4 Connect the pH electrodes

There are 2 sockets for the electrode. “pH” socket (BNC); “TEMP.” Socket (Cinch). For ST350 3-in-1 electrode, connect both the BNC and Cinch socket. For 2-in-1 pH electrodes (e.g. ST230), only connect the BNC.

3 DISPLAY AND ICONS



3.1 Turn on the meter

STARTER 5000 is a color touch screen 0.001pH bench meter. It does not have any buttons. After connecting with power, the meter will turn on, if meter in screen protection, you can tap the screen to turn on the screen.
 Note: If customer did not operate the meter for more than 6 hours, the meter will completely shut off automatically. You cannot turn on the meter by tapping the screen any more. You need to reconnect power to turn on the meter.





Select the language and then press  to enter the **main interface**.

Main Interface

Endpoint: Auto	Buffers: 1.683,	 Cal	
Sensor ID: Sensor 01	4.012, 7.005, 10.017,		
Sensor Cond: 😊	12.451 (25°C)		
System Setting	Measurement Setting	Calibration Setting	Data















3.2 Turn off the meter

To turn off the meter, please tap the turn-off button  in the top-left of **main interface** to enter the **turn-off interface**. Then tap  to turn-off the meter or tap  to go back to main interface again.

Turn-off interface



3.3 Icons



	User ID
	Sample ID
	Information icon
	Date
	Time
	pH measurement mode. Shift between mV and Rel.mV mode  or 
	Signal icon, when it is blinking that means the meter is receiving signal (in measurement or calibration).
	Endpoint icons, auto-endpoint, manual-endpoint and time-endpoint.
	When in manual-endpoint, if the signal is stable, the meter will show the stable signal icon.
	Tap the stop icon  to reach manual endpoint.
	Signal stable icon
	Temperature icon.

Information, measure and calibrate tap area









The information area is also the shortcut to enter the setting interface:

















- "Endpoint:"** Tap this area to enter the interface to set the endpoint mode. Available modes are Auto, Manual and Time endpoint. The current endpoint mode is displayed.
- "Sensor ID:"** Tap this area to enter the interface to select, set or change the sensor ID. The current sensor ID is displayed.
- "Sensor Cond:"** Tap this area to enter the sensor calibration data interface. The current sensor performance icon (judged by calibration data) is displayed.

There are 3 sensor condition icons:

 <p>Slope: more than 95% and offset: ± (0-15) mV Electrode condition is good</p>	 <p>Slope: 90-95% or offset: ± (15-35) mV Electrode condition is acceptable</p>	 <p>Slope: less than 90% or offset: ± (35-60) mV Electrode condition is not good or needs cleaning</p>
--	--	---

	<p>Calibration reminder icon. Set the time you want the meter to alert you to do calibration from last calibration. When the time is reached, this icon will be displayed and blink to remind that it is time to perform a calibration.</p>
<p>"Buffers:"</p>	<p>This area displays the current buffer group, tap this area to enter the interface to select the buffer group.</p>

	<p>Start icon. Tap this icon and the meter will begin measurement, the signal icon  will blink. The start icon area will show the stop icon .</p>
	<p>Calibration icon. Tap this icon to start calibration.</p>
	<p>Save icon. After saving the current measurement result (endpoint reached), this icon color will change from black to light gray , indicating that the reading has already been saved and cannot be saved twice.</p>
	<p>Output icon. Output data to external device such as a printer. If "Shut off connection" is chosen in System Setting ▶ Output, the save icon  will be displayed .Otherwise the output icon will be displayed in the same position.</p>

	Return to main interface
	Return to previous menu
	Enter, confirm or apply current setup, finish setting
	Edit
	Page up
	Page down
	Delete
	Increase (light)
	Decrease (light)
	Graph display (for the measurement or calibration data)
	Save
	Output to external device (USB flash drive, printer)
	Full keyboard
	Next calibration point
	Current Calibration point again
	End of calibration

3.4 Menu directory

The menus of first and secondary directory for STARTER 5000:

System Setting	Date
	Time
	Save Mode
	Output
	Screen Brightness
	Baud Rate
	Screen Protection
	Restore Factory Setup
	Instrument Information
	Service Password
Measurement Setting	Resolution
	MTC Temp. Input
	pH/mV/Rel.mV Mode
	Continuous Measure
	Endpoint Mode
	ID setting
	GLP Measurement Mode
Calibration Setting	Buffer Group
	Calibration Reminder
Data	Measurement Data
	Calibration Data

4 CALIBRATION, MEASUREMENT AND PRINT

The meter display will turn off automatically according to the time set in the menu **System Setting** ► **Screen Protection** ► **LCD Auto-off**. To turn on the screen again, tap the screen. (See 3.1)

A complete pH measurement process should follow the procedure:

- a) Rinse the pH electrode and connect to meter
- b) Prepare the buffer and calibrate the pH electrode
- c) Prepare the sample
- d) Conduct pH measurement of the sample
- e) Record measurement data
- f) Rinse the pH electrode and store

Prepare the pH electrode: the pH electrode should be rinsed with pure water before and after usage. Check if the electrode is physically damaged. (Be careful with the glass bulb)

The pH electrode should be stored in the storage bottle. After the pH electrode has been put into the sample or buffer solution, stir several seconds then wait **30 to 60 seconds** for the signal to be stable, and then press the button to operate (Calibration or measurement).



WARNING Do not operate the equipment in hazardous environments. The equipment is not explosion protected.



CAUTION When using chemicals and solvents, comply with the instructions of the chemical producer and the general lab safety rules.

4.1 Calibration

4.1.1 Buffer group

STARTER 5000 can perform 1-5 point calibrations for predefined buffer groups. For self-defined buffer group, it can do 1-9 point calibration.

Before calibration, make sure the current buffer group is the group wanted.

When using a new pH electrode, a calibration should be performed before any measurement. If a pH electrode is not used for a few days, a calibration should be performed before next usage.

Calibration is to display the right **pH** value when the meter receive the **mV** value signal from the pH electrode.

Slope: the linear coefficient between mV and pH according to theoretical value (e.g. - 59.16mV/pH @ 25°C means 100% slope);

Offset: the mV value when the pH value is 7.00. (Theoretical value is 0 mV)

STARTER 5000 will give an electrode condition icon to show the performance of the pH electrode according to the calibration data. Normally, if we get sad face icon after a proper calibration, you may need to replace the pH electrode with a new one.



STARTER 5000 automatically corrects for the temperature dependence of the buffer pH values. E.g. for US standard buffer group "**1.68, 4.01, 7.00, 10.01**" reference the following table:

5°C	1.67	4.01	7.09	10.25
10°C	1.67	4.00	7.06	10.18
15°C	1.67	4.00	7.04	10.12
20°C	1.68	4.00	7.02	10.06
25°C	1.68	4.01	7.00	10.01
30°C	1.68	4.01	6.99	9.97
35°C	1.69	4.02	6.98	9.93
40°C	1.69	4.03	6.97	9.89
45°C	1.70	4.05	6.97	9.86
50°C	1.71	4.06	6.96	9.83

For example, with calibration buffer 10.01 at 15°C, the calibration result should be 10.12 pH.

4. 1. 2 Performing calibration

After rinsing the pH electrode, put the electrode into the first buffer, stir for 10s then press  to start the calibration. When in calibration, the signal icon blinks. When the endpoint has been

reached,  appears while  disappears and current point calibration is finished, There are now 3 options:



Quit the calibration and go back to main interface



Finish current point calibration, go to calibration result interface



Do the next point calibration

Note: During calibrating process, the ST5000 is always in **Auto Endpoint Mode**.

Note: The use of 3-in-1 pH electrode which include the temperature sensor or a separate temperature electrode is recommended. When using the **MTC** mode, enter the correct temperature value and keep all buffer and sample solutions at the set temperature.

4.2 Sample measurement

4.2.1 pH measurement



Be sure the electrode has been calibrated before measurement. After rinsing,

- Place the pH electrode in the sample.
- Press  to start the pH measurement, when the endpoint has been reached, the current measurement is finished.

Note: If the signal is not stable all the time, it is recommended to use manual endpoint mode to avoid bad repeatability.

4.2.2 mV and Rel.mV measurement



Press  to shift to  or  mode; follow the same procedure as for pH measurement to perform mV or Rel.mV measurement.

If the meter is connected to an ORP electrode, the mV result is the value of Oxidation-Reduction Potential value; also called Redox value.

4.3 Temperature measurement

For better accuracy, we recommend to use either a built-in or a separate temperature electrode.

- ❖ If a temperature electrode is used, **ATC** and the sample temperature are displayed.
- ❖ If the meter does not detect a temperature electrode, it automatically switches to the manual temperature compensation mode and **MTC** appears. MTC temperature should be set.

Note: STARTER 5000 accepts **NTC 30 k Ω** temperature sensor. For ATC (Auto Temperature Compensation) or MTC (Manual Temperature Compensation), the Temperature Compensation only corrects for the change in the output of the electrode, not for the change in the actual solution. That means the meter corrects the signal (mV) from the pH electrodes to get a more accurate pH value according to the real temperature.

4.4 Printing

STARTER 5000 can print the measurement or calibration data through RS232. After the printer (e.g. OHAUS SF-40A) is connected to the meter properly, make the following settings(See 5.1):

please order the connect cable for ST5000 (P/N 30059316) to connect SF40A and ST5000.

System Setting ▶ Output , select **Printer**
System Setting ▶ Baud Rate, select **9600**.

The format for the print-out measurement is:

Date	Time	User	SampleID
6-13-2015	14:20:22	User01	Sample02
SensorID	Endpoint mode	MTC/ATC	
Sensor02	Manual	ATC	
Temperature	Result		
25.3°C	6.999pH		

The format for the print-out calibration data is:

Calibration Data

SensorID	Serial Number		
Sensor02	14060012		
Cal. Date	Cal. Time	ATC/MTC	
01-01-2015	14:20:33	ATC	
Buffers	mV	Offset	Slope
4.00pH	176.94mV		
7.00pH	0.05mV	0.05mV	98.22%

When performing continuous measurement, the format for the print-out calibration data is:

Timing Measure Record

SensorID	Serial Number		
Sensor03	14060012		
Date	Time	Temperature	Measurement
01-01-2015	14:20:25	23.5°C	6.998pH
Date	Time	Temperature	Measurement
01-01-2015	14:20:30	23.5°C	6.999pH
Date	Time	Temperature	Measurement
01-01-2015	14:20:35	23.5°C	7.000pH



5 SETUP

5.1 System Setting



System setting is used to set meter parameters, the meter information could also be found in it. Please see section 3.4 for reference.

5.1.1 System setting ► Save Mode

Save mode has 2 options, one is Auto Save Endpoint Reading, another is Manual Save Endpoint Reading. Auto Save Endpoint Reading means that when the measurement reaches the endpoint (auto, manual or time endpoint), the meter will save the endpoint reading automatically.

The Save icon  will change from black to light grey ; An endpoint reading can be saved only once.

5.1.2 System Setting ► Output

When selecting shut off connection, the main interface will display the save icon , or display the Output Icon .

5.1.3 System Setting ► Restore Factory Setup

Restoring the factory setup includes the following:

1. Shut off GLP mode
2. Shut off Auto Save mode
3. Shut off continuous measure
4. Shut off (output) connection
5. Shut off calibration Reminder
6. The resolution is: 0.001pH, 0.01mV
7. Measurement mode: pH
8. Self buffer group will be deleted
9. Baud rate: 9600
10. Brightness of screen: 70%
11. Shut off Screen Protection
12. MTC: 25°C
13. Endpoint: Auto
14. Time endpoint: 10 Second
15. Delete all the calibration data

5.1.4 System Setting ► Service Password

Not used.

5.2 Measurement Setting

5.2.1 Measurement Setting ► Endpoint Mode

Auto Endpoint

In this mode, the meter will reach the endpoint and lock the reading according to the following stability criteria automatically:

0.1pH resolution: the signal of the sensor input may not change by more than 0.3mV in 6 seconds.

0.01pH resolution: the signal of the sensor input may not change by more than 0.1mV in 6 seconds.

0.001pH resolution: the signal of the sensor input may not change by more than 0.03mV in 6 seconds.

Time Endpoint

In this mode, the user needs to input the endpoint time, e.g. 15 seconds. This means after starting the measurement for 15s, the meter will reach the endpoint.

Manual Endpoint

In this mode, the user needs to decide when the signal reading is stable, then press the stop icon



to reach manual endpoint.

5.2.2 Measurement Setting ► GLP Measurement Mode

GLP mode requires each measurement to have the User ID and Sample ID. If there is no sample ID or user ID, the meter will show the interface to let user input the required data.

5.2.3 Measurement Setting ► Continuous Measure

During continuous measure, the user needs to input the time interval to get each reading result. Below is the **Graph** of continuous measure.

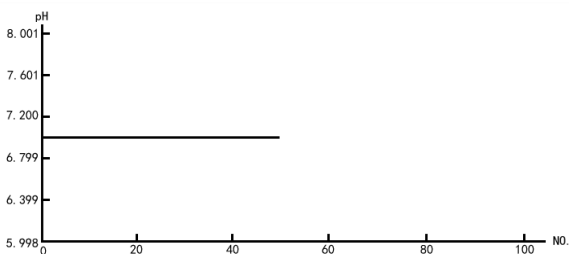

The Y axis is pH value. The x axis is the Number of measurement result.

5.3 Calibration Setting

5.3.1 Calibration Setting ► Buffer Group

Before calibration, please make sure the current buffer group is correct for your buffer solutions. User can select from the 8 predefined buffer groups.

User can also set self-defined buffer groups. The adjacent 2 calibration point difference should be larger than 0.99pH.

5.3.2 Calibration Setting ► Calibration Reminder

Enter this setting to set the time, from the last calibration, after how many hours the meter should remind to perform calibration again. The meter will show the calibration reminder icon  and blink, to remind user to perform calibration.

5.4 Data Log

Tap Data to get into the Data log interface, including measurement data and calibration data.

You can delete all the measurement data here. The only way to delete calibration data is to restore factory setup.

The data can be output to a USB Flash Drive (≤4GB).

6 MAINTENANCE

6.1 Error message

When the input value/measurement result is out of range or calibration data is not good enough, the meter will display error information.

If the error cannot be solved by the error message displayed, please contact Ohaus sales representative for further assistance.

6.2 Meter maintenance

The STARTER 5000 series instruments do not require any maintenance other than occasional wiping with a damp cloth.

Attention: Follow these safety precautions when cleaning the instrument

- Disconnect the instrument from the power supply
- Do not open the instrument
- Do not allow liquids to enter the instrument

Attention: The housing is made of acrylonitrile butadiene styrene (ABS). This material is attacked by some organic solvents, such as toluene, xylene and methyl ethyl ketone (MEK). Any spillage should be immediately wiped off.

6.3 Electrode maintenance

Make sure the electrode is filled with electrolyte solution. Always store the electrode according to the electrode instruction manual and do not allow it to dry out.

If the electrode response becomes sluggish or the slope is not good enough, try the following:

- Soak the electrode in 0.1M HCl for more than 8 hours.
- For fat or oil contaminant, degrease the membrane with cotton wool soaked in either acetone or a soap solution.

After electrode treatment, a new calibration should be performed. If the electrode slope is still not good, the electrode might need to be replaced.

6.4 Information

Tap the Information icon  to enter the information interface. Here the user can input related information by tapping the area with "i" in the bottom left such as sensor purchase date, etc.

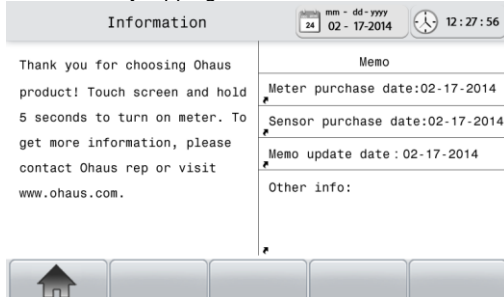

7 TECHNICAL DATA

7.1 Specifications

The technical data is valid under the following ambient conditions:

- Indoor use only
- Altitude: Up to 2000 m
- Specified Temperature range: 5°C to 40°C
- Humidity: maximum relative humidity 80 % for temperatures up to 30°C decreasing linearly to 50% relative humidity at 40°C
- Mains supply voltage fluctuations: up to $\pm 10\%$ of the nominal voltage
- Installation category II
- Pollution degree: 2
- Operability is assured at ambient temperatures between 5°C to 40°C

Model	STARTER 5000
Measuring range	-2.000...20.000 pH -2000.00...2000.00 mV -30°C ...130°C
Resolution	0.1/0.01/0.001 pH 1/0.1/0.01 mV 0.1°C
Error limits	± 0.002 pH $\pm 0.03\%$ FS mV $\pm 0.1^\circ\text{C}$
Calibration	1-9 points 8 predefined buffer group+1 self-defined buffer group
Memory	1000 measurements 10*10 calibration data
Power supply	100-240V~0.3A input, 9V \square 1.12A output AC Adapter
Size/weight	Approximately 210 x 170 x 80 mm / 0.65 kg
Ship dimension/weight	Approximately 372 x 310 x 185 mm / 2.30 kg
Display	Touch screen liquid crystal with backlight
Input	BNC, impedance > 3 x 10e+12 Ω Cinch, NTC 30 k Ω
Temperature-compensation	ATC & MTC
Housing	ABS

8 COMPLIANCE



This product conforms to the EMC Directive 2004/108/EC and the Low Voltage Directive 2006/95/EC. The Declaration of Conformity is available online at europe.ohaus.com/europe/en/home/support/compliance.aspx.



In conformance with the European Directive 2002/96/EC on Waste Electrical and Electronic Equipment (WEEE) this device may not be disposed of in domestic waste. This also applies to countries outside the EU, per their specific requirements. The Batteries Directive 2006/66/EC introduces new requirements from September 2008 on removability of batteries from waste equipment in EU member States. To comply with this Directive, this device has been designed for safe removal of the batteries at end-of-life by a waste treatment facility. Please dispose of this product in accordance with local regulations at the collecting point specified for electrical and electronic equipment. If you have any questions, please contact the responsible authority or the distributor from which you purchased this device. Should this device be passed on to other parties (for private or professional use), the content of this regulation must also be related. Disposal instructions in Europe are available online at europe.ohaus.com/europe/en/home/support/weee.aspx. Thank you for your contribution to environmental protection.

FCC Note: This equipment has been tested and found to comply with the limits for a Class A digital device, pursuant to part 15 of the FCC Rules. These limits are designed to provide reasonable protection against harmful interference when the equipment is operated in a commercial environment. This equipment generates, uses, and can radiate radio frequency energy and, if not installed and used in accordance with the instruction manual, may cause harmful interference to radio communications. Operation of this equipment in a residential area is likely to cause harmful interference in which case the user will be required to correct the interference at his own expense.

Industry Canada Note

This Class A digital apparatus complies with Canadian ICES-001

ISO 9001 Registration

In 1994, OHAUS Corporation, USA, was awarded a certificate of registration to ISO 9001 by Bureau Veritas Quality International (BVQI), confirming that the OHAUS quality management system is compliant with the ISO 9001 standards requirements. On June 21, 2012, OHAUS Corporation, USA, was re-registered to the ISO 9001:2008 standard.

9 BUFFER GROUPS

STARTER 5000 automatically correct for the temperature dependence of the buffer group pH value given in the following tables. Please choose the buffer group you want before calibration.

JJG119 (Ref. 25°C, 0.01pH)

Temp °C	1.68	4.00	6.86	9.18	12.46
5	1.67	4.00	6.95	9.39	13.21
10	1.67	4.00	6.92	9.33	13.01
15	1.67	4.00	6.90	9.28	12.82
20	1.68	4.00	6.88	9.23	12.64
25	1.68	4.00	6.86	9.18	12.46
30	1.68	4.01	6.85	9.14	12.29
35	1.69	4.02	6.84	9.11	12.13
40	1.69	4.03	6.84	9.07	11.98
45	1.70	4.04	6.83	9.04	11.83
50	1.71	4.06	6.83	9.02	11.70

US standard (Ref. 25°C)

Temp °C	1.68	4.01	7.00	10.01
5	1.67	4.01	7.09	10.25
10	1.67	4.00	7.06	10.18
15	1.67	4.00	7.04	10.12
20	1.68	4.00	7.02	10.06
25	1.68	4.01	7.00	10.01
30	1.68	4.01	6.99	9.97
35	1.69	4.02	6.98	9.93
40	1.69	4.03	6.97	9.89
45	1.70	4.05	6.97	9.86
50	1.71	4.06	6.96	9.83

Europe standard (Ref. 25°C)

Temp °C	2.00	4.01	7.00	9.21	11.00
5	2.02	4.01	7.09	9.45	11.72
10	2.01	4.00	7.06	9.38	11.54
15	2.00	4.00	7.04	9.32	11.36
20	2.00	4.00	7.02	9.26	11.18
25	2.00	4.01	7.00	9.21	11.00
30	1.99	4.01	6.99	9.16	10.82
35	1.99	4.02	6.98	9.11	10.64
40	1.98	4.03	6.97	9.06	10.46
45	1.98	4.04	6.97	9.03	10.28
50	1.98	4.06	6.97	8.99	10.10

MERCK (Ref. 20°C)

Temp °C	2.00	4.00	7.00	9.00	12.00
5	2.01	4.04	7.07	9.16	12.41
10	2.01	4.02	7.05	9.11	12.26
15	2.00	4.01	7.02	9.05	12.10
20	2.00	4.00	7.00	9.00	12.00
25	2.00	4.01	6.98	8.95	11.88
30	2.00	4.01	6.98	8.91	11.72
35	2.00	4.01	6.96	8.88	11.67
40	2.00	4.01	6.95	8.85	11.54
45	2.00	4.01	6.95	8.82	11.44
50	2.00	4.00	6.95	8.79	11.33

DIN (19267) (Ref. 25°C)

Temp °C	1.09	4.65	6.79	9.23	12.75
5	1.08	4.67	6.87	9.43	13.63
10	1.09	4.66	6.84	9.37	13.37
15	1.09	4.66	6.82	9.32	13.16
20	1.09	4.65	6.80	9.27	12.96
25	1.09	4.65	6.79	9.23	12.75
30	1.10	4.65	6.78	9.18	12.61
35	1.10	4.65	6.77	9.13	12.45
40	1.10	4.66	6.76	9.09	12.29
45	1.10	4.67	6.76	9.04	12.09
50	1.11	4.68	6.76	9.00	11.98

JIS Z 8802 (Ref. 25°C)

Temp °C	1.679	4.008	6.865	9.180
5	1.668	3.999	6.951	9.395
10	1.670	3.998	6.923	9.332
15	1.672	3.999	6.900	9.276
20	1.675	4.002	6.881	9.225
25	1.679	4.008	6.865	9.180
30	1.683	4.015	6.853	9.139
35	1.688	4.024	6.844	9.102
40	1.694	4.035	6.838	9.068
45	1.700	4.047	6.834	9.038
50	1.707	4.060	6.833	9.011

DIN(19266) / NIST (Ref. 25°C)

Temp °C	1.680	4.008	6.865	9.183	12.454
5	1.668	4.004	6.950	9.392	13.207
10	1.670	4.001	6.922	9.331	13.003
15	1.672	4.001	6.900	9.277	12.810
20	1.676	4.003	6.880	9.228	12.627
25	1.680	4.008	6.865	9.183	12.454
30	1.685	4.015	6.853	9.144	12.289
35	1.691	4.026	6.845	9.110	12.133
40	1.697	4.036	6.837	9.076	11.984
45	1.704	4.049	6.834	9.046	11.841
50	1.712	4.064	6.833	9.018	11.705

JJG119 (Ref. 25°C, 0.001pH)

Temp °C	1.680	4.003	6.864	9.182	12.460
5	1.669	3.999	6.949	9.391	13.210
10	1.671	3.996	6.921	9.330	13.011
15	1.673	3.996	6.898	9.276	12.820
20	1.676	3.998	6.879	9.226	12.637
25	1.680	4.003	6.864	9.182	12.460
30	1.684	4.010	6.852	9.142	12.292
35	1.688	4.019	6.844	9.105	12.130
40	1.694	4.029	6.838	9.072	11.975
45	1.700	4.042	6.834	9.042	11.828
50	1.706	4.055	6.833	9.015	11.697

LIMITED WARRANTY

Ohaus products are warranted against defects in materials and workmanship from the date of delivery through the duration of the warranty period. During the warranty period Ohaus will repair, or, at its option, replace any component(s) that proves to be defective at no charge, provided that the product is returned, freight prepaid, to Ohaus.

This warranty does not apply if the product has been damaged by accident or misuse, exposed to radioactive or corrosive materials, has foreign material penetrating to the inside of the product, or as a result of service or modification by other than Ohaus. In lieu of a properly returned warranty registration card, the warranty period shall begin on the date of shipment to the authorized dealer. No other express or implied warranty is given by Ohaus Corporation. Ohaus Corporation shall not be liable for any consequential damages.

As warranty legislation differs from state to state and country to country, please contact Ohaus or your local Ohaus dealer for further details.