

SYSTEM TOOLS

**Test Equipment
Depot**
1-800-517-8431

99 Washington Street
Melrose, MA 02176
Phone 781-665-1400
Toll Free 1-800-517-8431

Visit us at www.TestEquipmentDepot.com





YELLOW JACKET®

Deluxe 45° Flaring Tool

A full range 1/8" to 3/4" O.D. flaring tool for soft copper



DELUXE 45° FLARING TOOL



- Designed with the new R-410A system requirements in mind
- Self-centering yoke grips without marring or constricting tube
- Automatic tube height gauge for correct tubing height
- Multi-faceted burnishing cone produces a burnished flare seat for a positive seal
- Easy-to-use with four basic steps
- Made in the USA

Note: To improve grip on copper, all moving parts including the wing nut threads, wing nut mating threads and feed screw threads must be oiled regularly. Failure to do so may result in tubing slippage, undersize flares and damage to the tool.



1. With cone up, open the two dies of the clamping yoke



2. Select sizes on underside of dies to match tubing O.D.

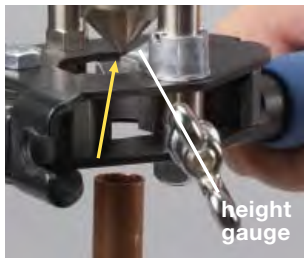

3. Insert tubing until it touches the height gauge

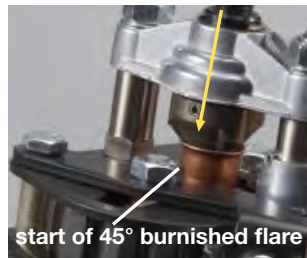

4. Turn the feed screw to flare the tubing

UPC#	Description
60278	Deluxe flaring tool for 1/8" to 3/4" O.D.
60214	Replacement wing nut
60268	Replacement grip
60269	Wing nut and bolt
60273	Burnishing cone and pin
60274	Yoke assembly

R-410A Flare Diameters

- Installation instructions for systems using R-410A vary between manufacturers with respect to 45° flares. Some require the larger flares produced by the Deluxe 45° Flaring Tool (60278) while others prefer the rolled flare produced by the eccentric cone flaring tool
- Instead of the standard 1/4" (7/16-20 thread, 1/4" O.D.) fitting for air conditioning systems, some manufacturers are moving to 5/16" (1/2-20 thread, 5/16" O.D.) to differentiate fittings and avoid misconnections. These fittings can often be found on mini split systems

Maximum Diameter of Flare Cone (Average)

Flare size	SAE spec produced by most flaring tools	Some R-410A mfg. specs produced by 60278
1/8"	0.181"	*
3/16"	0.248"	*
1/4"	0.327"	0.358"
5/16"	0.406"	*
3/8"	0.488"	0.520"
1/2"	0.622"	0.654"
5/8"	0.748"	0.776"
3/4"	0.917"	0.945"

* These tube sizes are not used by some R-410A equipment manufacturers. The Deluxe Flaring Tool 60278 adopts the SAE standard for these sizes.

ECCENTRIC CONE FLARING TOOL

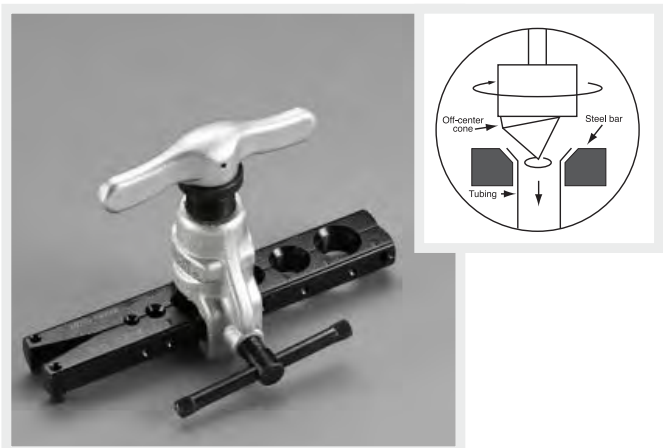

Off-center hardened steel cone with 45° flare produces a rolling action for uniform flare walls without galling in 3/16" to 3/4" O.D. tubing.

- Large feed screw handle for smooth turning with little effort
- Black oxide-finished steel flaring bars are heat-treated for durability and secure grip on tubing
- Recommended for soft materials such as copper and aluminum
- Built-in clutch release to prevent over-torquing

UPC#	Description
60295	Flaring tool with eccentric cone for 3/16" to 3/4" O.D.

45° FLARING TOOLS 3/16" to 1-1/8"



60210



60230



60290

- 60210 heavy-duty is designed for tight spaces
- 60230 heavy-duty flares on tubing up to 3/4"
- 60290 large is designed to flare on tubing up to 1-1/8"
- Hardened steel flaring bar to resist tube slippage
- Forged steel yoke that slips over bar and locks with a turn
- Precision threaded feed screw and long handle
- Chrome finish

UPC#	Description
60210	Heavy-duty flaring tool for 3/16", 1/4", 5/16", 3/8", 7/16", 1/2", 5/8" O.D.
60212	Flaring bar only for 60210
60230	Heavy-duty flaring tool for 1/2", 5/8", 3/4" O.D.
60232	Flaring bar only for 60230
60213	Yoke for 60210 up to 5/8" flare
60214	Wing nut
60233	Yoke for 60230 up to 3/4" flare
60290	Large flaring tool for 3/4", 7/8", 1", 1-1/8" O.D.
60293	Flaring yoke for 60290
60292	Flaring bar for 60290

The only replaceable parts are those listed above.

FLARE/BURNISH TOOL



Multi-faceted cone rolls a precise flare and simultaneously burnishes it on brass, copper and aluminum.

UPC#	Description
60270	Flare/burnish tool for 3/16" to 5/8" O.D.
60271	Flare yoke only for 60270
60272	Flaring bar for 60270

The only replaceable parts are those listed above.

UNIVERSAL 45° FLARE/BURNISH TOOL



Universal designed bar will hold all inch and metric size tubing up to 5/8" (16 mm).

- Flare bar is compact and easy to use in tight spaces
- Multi-faceted cone rolls out precise 45° flare and burnishes simultaneously
- Flare is formed above flare bar

UPC#	Description
60275	Universal flaring tool for 3/16" to 5/8" O.D.
60276	Flaring bar only for 60275
60277	Flaring yoke only for 60275

The only replaceable parts are those listed above.

LIGHTWEIGHT SWAGE/FLARE KIT



60430 shown
60431 includes 6 additional metric pins

The aluminum body and bar makes this half the weight of traditional steel designs.

- Six quick-change positions for flaring soft copper and aluminum tube
- The chrome finish of the swaging pin allows for an easy flare operation
- Strong aluminum bars - each hole flare tested more than 1000 times.
- Swage pin sizes are molded into the case for easy organization
- Quick connect on yoke saves time during pin/cone changing
- Built-in slide gauge to easily meet desired flare sizes without the guesswork.
- One yoke for both flaring and swaging
- Blow-molded carrying case included

UPC#	Kit Swaging/Flaring Sizes
60430	Inches: 6 positions for 1/4, 5/16, 3/8, 1/2, 5/8 and 3/4" O.D. tube
60431	Inches: 6 positions for 1/4, 5/16, 3/8, 1/2, 5/8 and 3/4" O.D. tube Metric: 6 positions for 6, 8, 10, 12, 16 and 18 MM O.D. tube; hex wrench included

UPC#	Replacement Parts
60428	Replacement case for 60430/60431
60432	Lightweight 60430/60431 bar, inch
60433	Lightweight 60431 bar, metric
60434	Replacement yoke for 60430/60431
60435	6 mm swage pin for 60431
60436	8 mm swage pin for 60431
60471	10 mm swage pin for 60431
60437	12 mm swage pin for 60431
60438	16 mm swage pin for 60431
60451	18 mm swage pin for 60431
60452	Flaring cone for 60430/60431
60472	1/4" swage pin for 60430
60473	5/16" swage pin for 60430
60474	3/8" swage pin for 60430
60477	1/2" swage pin for 60430
60478	5/8" swage pin for 60430
60479	3/4" swage pin for 60430

SWAGING AND 45° FLARING TOOL 1/2" to 1-1/8" O.D.



- 60453 mid-size swages and flares for 1/2", 5/8" and 3/4" O.D. tubing



- 60455 large-size swages and flares for 3/4", 7/8" and 1-1/8" O.D. tubing

UPC#	Description
60453	Swage/flare kit complete for 1/2" to 3/4" O.D.
60446	1/2" Swage adapter
60447	5/8" Swage adapter
60448	3/4" Swage adapter
60449	Flare cone 1/2" to 3/4"
60443	Complete yoke for 60440/60453
60232	Flare bar 1/2" to 3/4" O.D.
60455	Large swage/flare kit complete 3/4" to 1-1/8" O.D.
60457	7/8" Swage adapter
60458	1-1/8" Swage adapter
60459	Flare cone 3/4" to 1-1/8"
60456	Complete yoke for 60455
60292	Flare bar 3/4" to 1-1/8" O.D.
60441	Handle screw assembly
60442	"C" clip and nut

SWAGING AND 45° FLARING TOOL 3/16" to 3/4" O.D.



This combination tool both flares and swages soft or annealed copper and similar materials.

- Six hardened and plated alloy steel adapters are interchangeable to convert sizes and functions
- Slip-on self-centering steel yoke has a feed screw with extra long handle

- Deeply knurled adapters
- Flaring bars are hardened and chrome plated for durability
- Kit comes complete with six swage adapters, flaring cone, two flaring bars, yoke and a deluxe case



UPC#	Description
60440	Swage/flare kit complete for 3/16" to 3/4" O.D.
60450	Case only
60451	Case insert only
60444	3/16" and 3/8" Adapter
60439	1/4" Adapter
60445	5/16" Adapter
60446	1/2" Swage adapter
60447	5/8" Swage adapter
60448	3/4" Swage adapter
60449	Flare cone for 3/8" to 3/4" - 45° adapter
60442	"C" clip and nut
60441	Handle/feed screw
60443	Complete yoke 60440/60453
60212	Flare bar for 3/16" to 5/8" O.D.
60232	Flare bar for 1/2" to 3/4" O.D.

FLARING/CUTTING KITS



A wide variety of heavy-duty tool kits for flaring 3/16" to 3/4" O. D.

60260



60240

UPC#	Description
60240	Full range 45° flaring kit for 3/16" to 3/4" O.D. with yoke, two bars, case, instructions
60230	45° Flaring tool only for 1/2" to 3/4" O.D.
60250	45° Flaring/cutting kit for 3/16" to 5/8" O.D. with 60210 flaring tool, 60101 cutter, case, instructions
60260	Full range 45° flaring/cutting kit for 3/16" to 3/4" O.D. same as 60240 with 60101 cutter, case, instructions

ELECTRIC/MANUAL LIGHTWEIGHT FLARING TOOL



UPC#	Kit Swaging/Flaring Sizes
60241	Inches: 6 positions for 1/4, 5/16, 3/8, 1/2, 5/8 and 3/4" O.D. tube
60242	Metric: 6 positions for 6, 8, 10, 12, 16 and 18 MM O.D. tube
UPC#	Replacement Parts
60433	Lightweight 60431 bar, metric
60434	Replacement yoke for 60430/60431
60243	Replacement side handle for 60241/60242
60244	Replacement top handle for 60241/60242

For super fast flaring, remove the top handle and replace with an electric drill bit.

- For use with electric/power drill (with torque adjusted function only).
- Handle included for manual flaring.
- Side handle locks movement of the yoke assembly during flaring.
- The hardened, polished eccentric cone of with 45° flare produces a rolling action for uniform flare walls without galling in 1/4" to 3/4" O.D. tubing.
- Built-in clutch release to prevent over-torquing.

RECOVERY MACHINES
VACUUM PUMP SYSTEMS
VACUUM AND CHARGING HOSES
HOSE ADAPTERS, VALVES AND PARTS
CHARGING SYSTEMS
GAUGES
WIRELESS AND ELECTRONIC INSTRUMENTS
HEATING INSTRUMENTS
LEAK MONITORS AND DETECTORS
SYSTEM TOOLS

TUBING EXPANDER/SWAGER For 5/16" to 1-5/8" O.D.



60407



With long handles for comfortable leverage, easily expand 5/16" to 1-1/8" O.D. soft copper and aluminum tubing in seconds. Select from nine expander heads to attach to the front of the handles.

- Precise swaging on the job
- Re-round deformed tubes and fittings
- Salvage shorts and scrap to make couplings
- Handles, tapered expanding pin, and other moving surfaces heat treated for durability
- Use on 0.063" wall soft copper and aluminum to 1-5/8" O.D. (anneal hard copper prior to use)
- Use on 0.047" wall soft steel to 7/8" O.D.
- Kit includes six expander heads; three optional sizes sold separately

Sets in case

UPC#	Description
60407	Expander kit with handles; heads for 3/8", 1/2", 5/8", 3/4", 7/8", 1-1/8" tubing O.D.; deburring tool, carrying case, instructions
60412	Expander handles
60405	Nut and bolt
60410	Expander handle hinge bolt (9 mm)
60411	Blue case
60427	Steel roller
60429	Drive pin

Expander heads

UPC#	Description	Maximum wall thickness	Swage depth	Segment stretch
60413*	5/16" Expander head	0.039"	0.24"	—
60414	3/8" Expander head	0.039"	0.35"	0.06"
60415	1/2" Expander head	0.047"	0.43"	0.06"
60416	5/8" Expander head	0.047"	0.57"	0.06"
60417	3/4" Expander head	0.047"	0.59"	0.06"
60418	7/8" Expander head	0.047"	0.71"	0.06"
60420	1-1/8" Expander head	0.063"	0.77"	0.90"
60422*	1-3/8" Expander head	0.063"	0.77"	0.90"
60424*	1-5/8" Expander head	0.063"	0.77"	0.90"

* Optional sizes sold separately.

PUNCH-TYPE SWAGING TOOL



60475

- Expands one end of copper tubing for connecting same size tubes
- Heat-treated and plated alloy steel
- Made in the USA

Swaging sets

UPC#	Description
60475	Set - 4 piece in pouch for 1/4", 3/8", 1/2" and 5/8"
60476	Set - 5 piece in pouch for 1/4", 5/16", 3/8", 1/2" and 5/8"
60461	Set with clamping bar and 6 punches 3/16" to 5/8"
60462	Clamping bar only



60460

Single tools

UPC#	Description
60460	Multi-swage punch, 6 sizes 3/16" to 5/8"
60463	3/16" O.D. punch
60464	1/4" O.D. punch
60465	5/16" O.D. punch
60466	3/8" O.D. punch
60467	1/2" O.D. punch
60468	5/8" O.D. punch
60469	3/4" O.D. punch
60470	7/8" O.D. punch

HYDRAULIC TUBE EXPANDER KIT

- Hydraulic power
- Eliminates fittings



60493

- Lightweight and portable
- Easy one-hand operation

UPC#	Description
60493	Deluxe hydraulic expander kit: heads for 3/8", 1/2", 5/8", 3/4", 7/8", 1-1/8", 1-3/8" and 1-5/8" tubing O.D.; small cutter, tube reamer, carrying case and instructions
60497	Hydraulic expander kit: heads for 3/8", 1/2", 5/8", 3/4", 7/8", 1-1/8"; carrying case and instructions
60495	Replacement expander pin 3/8" to 1-5/8"
60498	Replacement case
60499	Replacement grease tube
60413-24	Replacement expander heads (see above)

RECOVERY MACHINES
VACUUM PUMP SYSTEMS
VACUUM AND CHARGING HOSES
HOSE ADAPTERS, VALVES AND PARTS
CHARGING SYSTEMS
GAUGES
WIRELESS AND ELECTRONIC INSTRUMENTS
HEATING INSTRUMENTS
LEAK MONITORS AND DETECTORS
SYSTEM TOOLS

RATCHET HAND TUBE BENDER



Easy one hand bending of 1/4" to 7/8" soft copper and soft aluminum. Hard copper must be annealed before bending.

- Quick change bending mandrels and shoes
- Trouble free ratchet mechanism
- Index marks to locate bends
- Complete tube bender kit includes all items required to bend 1/4", 5/16", 3/8", 1/2", 5/8", 3/4" and 7/8" tubing



UPC#	Bending radius	Description
60331	—	Complete kit
60325	—	60331 kit and 60342 bending mandrel kit
60326	1"	1/4" O.D. bending mandrel
60327	7/8"	5/16" O.D. bending mandrel
60332	1-3/16"	3/8" O.D. bending mandrel
60333	1-3/8"	1/2" O.D. bending mandrel
60334	1-15/16"	5/8" O.D. bending mandrel
60335	2-13/16"	3/4" O.D. bending mandrel
60336	3-3/8"	7/8" O.D. bending mandrel
60329	—	Crossbar assembly complete - 3/4" to 7/8"
60330	—	Crossbar assembly complete - 1/4" to 5/8"
60338	—	Plastic carrying case
60339	—	Ratchet body
60342	—	Reverse bending mandrel
UPC#	Replacement parts for 60331	
60101	Small cutter for 1/8" to 1-1/8" O.D.	
60161	Tube reamer for 1/16" to 1-3/8" O.D.	
60328	Lever screw (20)*	
60339	Ratchet body (10)*	
60340	Ratchet bar (9)* and catch bolt (14)*	
60344	Catch pin (13)* and spring (15)*	
60345	Catch lever (16)*	
60346	Flat spring (17)*	
60347	Feed lever (19)*	
60348	Wing nut screw (8, 11)*	
60349	Tension spring (18)*	

* Designates the call-out number for the parts diagram on the 60331 instruction chart.

FULL RANGE HEAVY DUTY TUBE BENDERS For 1/4" to 7/8" radius



Make fast bends on almost every size of soft copper, brass, aluminum, steel and soft stainless steel tubing to 180°.

60390 is a compact three-in-one bender for 1/4", 5/16" and 3/8" O.D. tubing. Calibrated markings for bends up to 180° help you duplicate angles.

Conforms to Fed. Spec. GGG-B-191-a Type III, Class 2.

UPC#	Bending radius	Description
60390	15/16"	1/4", 5/16", 3/8" 3-in-1 Tube bender
60373	9/16"	1/4" Tube bender
60374	11/16"	5/16" Tube bender
60375	15/16"	3/8" Tube bender
60377	1-1/2"	1/2" Tube bender
60378	2-1/4"	5/8" Tube bender
60379	3"	3/4" Tube bender
60380	3-1/4"	7/8" Tube bender

SPRING TUBE BENDER For 1/4" to 7/8"



Spring benders slip over soft copper and aluminum tubing during bending to help prevent tube collapse.

- Silver-plated finish
- Conforms to Fed. Spec. GGG-B-191-a Type IV

UPC#	Description
60354	1/4" O.D. bending spring
60355	5/16" O.D. bending spring
60356	3/8" O.D. bending spring
60357	7/16" O.D. bending spring
60358	1/2" O.D. bending spring
60359	5/8" O.D. bending spring
60360	3/4" O.D. bending spring
60361	7/8" O.D. bending spring
60351	Set-6 sizes-1/4", 5/16", 3/8", 7/16", 1/2" and 5/8" O.D.
60352	Set-4 sizes-1/4", 3/8", 1/2" and 5/8" O.D.
60353	Set-4 sizes-1/2", 5/8", 3/4" and 7/8" O.D.

MINI-SPLIT TOOL KIT



The YELLOW JACKET Mini-Split Tool Kit addresses many of the special requirements found in mini-split installation manuals.

- R-410A service tools
- Takes the guesswork out of finding the right tool for the job
- Meet manufacturers' specifications on mini-split installations and repairs
- 60991 for domestic and 60992 for international service technicians

Each kit includes:

- Heat Pump Manifold
Designed to handle all mini-split refrigerants and pressures (including heating modes) (R-410A only on 60992)
- 60" PLUS II Hoses
Rated for 400 psi (276 bar) minimum burst and 800 psi (55 bar) maximum working pressure.
 - 60991 - (RYB) 1/4" with 1/4" flare fittings
 - 60992 - 1/4" with 1/4" flare flare fittings (Y), 1/4" x 5/16" (R&B) and; (Red) 1/4" Female flare on manifold connection and 1/4" female flare on angled service end.
- Eccentric Cone Flare Tool
Creates high quality flares for 3/16" to 3/4" O.D. tubing
- Hex Key Set
Mini-Split Hex Keys - 5/32", 3/16", 5mm and 6mm
- Vacuum/Charge Valve with Side Port
 - 60991: 5/16"x1/4"x1/4" (18986)
 - 60992: 5/16"x5/16"x5/16" (18985)
- 45° R-410A Coupler 5/16" Female Quick Coupler x 1/4" Male Flare (60992 only)
- Tube Cutter and Deburring Tool
- Adjustable Torque Wrench
 - 60652 Eight head Kit includes: 60991: 16, 17, 21, 22, 24, 26, 27 and 29 mm flare nuts
 - 60650 Six head kit includes: 60992: 17, 22, 24, 26, 27 and 29 mm flare nuts
- 16" Tool Bag
Durable nylon bag with strap and over 25 pockets

UPC#	Description
60991	Mini-Split tool kit with tool bag (R-22/407C/410A Heat pump manifold)
60992	Mini-Split tool kit with tool bag (R-410A Heat pump manifold)
60990	16" Tool bag

PRECISION TORQUE WRENCH



Designed to accommodate the full range of ductless mini-split flare nut sizes and torque requirements.

Easier-to-use and more adjustable than other flare nut torque wrenches on the market.

Precision torque wrench for exact tightening to 10-80 N-M or 7.4-59 ft. lb.

- Adjustable in Newton-meters and foot-pound.
- Six interchangeable open end adapters.

60650 (6 Heads): Sizes: 17, 22, 24, 26, 27 & 29 mm

60652 (8 Heads): Sizes: 16, 17, 21, 22, 24, 26, 27 & 29 mm

- The N-M and foot-pound (FT-LB) scales are marked on the barrel of the wrench for easy and permanent reference.
- The micrometer-type sleeve is easy to read and allows accurate pre-set torque values to be set. When the set torque is reached, the wrench produces an audible click and a slight, safe release of tension to prevent over tightening.
- This product has been designed to be tough, durable and easy to use. It comes supplied in a blow-molded storage and carry case.
- Accurate within 4% when measured per BSEN 26789 & ISO 6789 & ASME B107.14M & DIN3122 regardless of the open end adapter head used.



The N-M and foot-pound (FT-LB) scales are marked on the barrel of the wrench for easy and permanent reference.

UPC#	Description
60650	Torque wrench kit - 6 heads
60652	Torque wrench kit - 8 heads

SERVICE WRENCHES



60613

Standard reversible ratchet wrench with square openings: 1/4" and 3/16" at one end; 3/8" and 5/16" at other end.



60618

Heavy-duty features a heavier handle and larger gear. Stronger gear teeth are combined with strong reversing mechanism for long service life.

Square opening 3/16" and 1/4" at one end; 3/8" and 5/16" at other end.



60616

Knuckle saver design for convenience in tight areas. Square opening 1/4" and 3/16" one end; 3/8" and 5/16" at other.



60615

Reversible wrench for **larger service valves**. 3/8" square one end; 1/2" square at other.



60612

7" heavy-duty reversible ratchet wrench with hex openings 1/2" and 9/16" at one end; square 3/16" and 1/4" at other end.

Service wrenches

UPC#	Description
60613	Straight service wrench
60618	Heavy-duty service wrench
60616	Off-set service wrench
60615	Refrigeration wrench for large valves
60612	7" Heavy-duty wrench
60003	60613 (50 pak)
60006	60616 (50 pak)
60008	60618 (42 pak)

CAUTION: Do not use cheater bars.

SERVICE WRENCH AND ADAPTER

Combination service wrench and hex adapter for accessing liquid and suction based valves on residential and commercial units up to 7.5 tons. Heat-treated hex works for 3/16" and 5/16" hex valves. Black oxide plated. New adapter for some York and Coleman units.

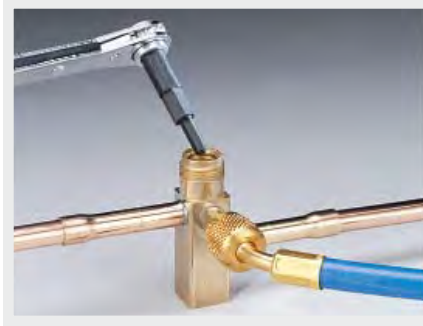

UPC#	Description
60609	Hex key adapter
60610	60613 service wrench and 60609 adapter
60638	Shorter 3/16" and 5/16" hex key adapter

KNUCKLE-SAVER™ HEX WRENCH SETS

Three-piece or five-piece

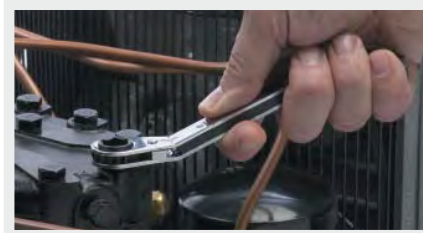

The offset design saves knuckles in tight places.

- Accurately sized and broached ends for correct fit
- Heat-treated critical wear parts for long life
- Finger control reversing
- Chrome plated for durability
- Made in the USA 

UPC#	Description	Hex sizes
60630	Set - 5 wrenches	1/4" to 7/8"
60631	Set - 3 wrenches	1/4" to 9/16"
60633	Ratchet wrench	1/4" x 5/16"
60634	Ratchet wrench	3/8" x 7/16"
60635	Ratchet wrench	1/2" x 9/16"
60636	Ratchet wrench	5/8" x 11/16"
60637	Ratchet wrench	3/4" x 7/8"

SPORLAN VALVE WRENCH



Spanner end tightens packing nut around super heat adjustment stem. 1/8" square end adjusts Sporlan solenoid valves with manual lift stems as on Series B6 and E6 through MA 50. Also 3/16" square at same end for expansion valves. 

UPC#	Description
60617	Sporlan valve wrench



RECOVERY MACHINES
VACUUM PUMP SYSTEMS
VACUUM AND CHARGING HOSES
HOSE ADAPTERS, VALVES AND PARTS
CHARGING SYSTEMS
GAUGES
WIRELESS AND ELECTRONIC INSTRUMENTS
HEATING INSTRUMENTS
LEAK MONITORS AND DETECTORS
SYSTEM TOOLS

RECOVERY MACHINES
 VACUUM PUMP SYSTEMS
 VACUUM AND CHARGING HOSES
 HOSE ADAPTERS, VALVES AND PARTS
 CHARGING SYSTEMS
 GAUGES
 WIRELESS AND ELECTRONIC INSTRUMENTS
 HEATING INSTRUMENTS
 LEAK MONITORS AND DETECTORS
 SYSTEM TOOLS

TUBE DEBURRING TOOL

For fast deburring, rotate blade.



UPC#	Description
60163	Deburring tool with spare blades
60164	Replacement blade for 60163
60165	Economy deburr for 60139 tube cutter
60166	Economy deburr for 60146 tube cutter

TUBE REAMER/BURR REMOVER

Steel blades remove inner and outer burrs.



UPC#	Description
60161	Tube reamer - 1/16" up to 1-3/8" O.D.

PREMIUM TUBE CUTTERS



Retracted



Extended



Spare blade stored in handle

Enclosed precision feed mechanism for easy, smooth cutting.

- Wide rollers with flare cut-off groove for convenience. Ground surface for easy rolling
- Wheel retracts into cutter body to save 1" in cutting radius
- Textured finish is easy to grip and hold
- Alloy steel wheels have a sharper cutting wheel edge for less burr on copper, aluminum and mild steel tubing
- Wheels are pinned to rotate in either direction without the screw backing out
- Corrosion-resistant finish on lightweight aluminum frame



- Fold away steel reamer with turned cutting edge for deburring
- Flare cut-off groove for quickly removing damaged flare
- Small and large sizes available
- Conforms to Fed. Spec. GGG-C-771-d, 1-31, 64. Type II, Class 1.

CONSTRICTOR/CUTTER

Cutter modified with blunt wheel to roll down the tube O.D.

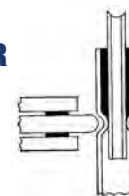

UPC#	Description
60101	Small cutter* for 1/8" to 1-1/8" O.D.
60102	Large cutter* for 1/4" to 1-5/8" O.D.
60103	Constrictor/cutter for 1/4" to 1-1/8" O.D.

Spare parts listed on page 88.

HEAVY DUTY MINI-CUTTERS



Mini-cutters are compact yet easy to grip and feature large rollers and flare cut-off groove.

Mini-cutter 60121 for heavy-duty cutting from 1/4" to 7/8" O.D.

Small Mini 60160 cuts 1/8" to 5/8" with a turning radius of only 1-3/16".

Big Mini 60142 cuts from 1/4" to 1-1/8" O.D.

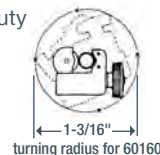

1-3/16" turning radius for 60160

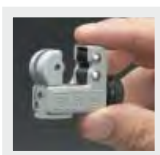

UPC#	Description
60160	Small Mini for 1/8" to 5/8" O.D.
60121	Mini-cutter for 1/4" to 7/8" O.D.
60142	Big Mini for 1/4" to 1-1/8" O.D.

Spare parts listed on page 88.

LARGE TUBE CUTTERS

To 5-1/8" O.D. (130 mm)

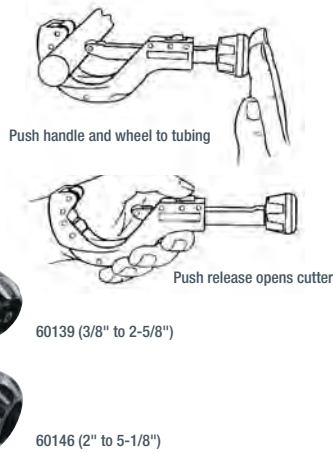

- "I beam" design uses aluminum alloy for both strength and light weight
- Wide body has long rollers to hold tubing and includes a flare cut-off groove
- Contoured handle for easy gripping also holds spare cutter wheel
- Separate deburr tool slides into cutter body

UPC#	Description
60139	Tube cutter for 3/8" to 2-5/8" O.D.
60146	Large tube cutter for 2" to 5-1/8" O.D.
60165	Replacement deburr tool for 60139
60166	Replacement deburr tool for 60146
60136	Individual/Retainer screw
60172	Handle screw for 60139
60173	Handle and screw for 60139
60174	Spring for 60139

PIPE CUTTER For black iron



Cuts black iron pipe more cleanly and quickly than other types of cutters. Cast iron body holds heat-treated steel cutter wheel.

- Fine pitch threads assure easy cuts on black pipe
- Large rollers for clean right angle cuts

UPC#	Description
60131	6 lb. pipe cutter for 1/8" to 2" pipe
60132	Pipe cutter wheel for 60131

HEAVY DUTY PIPE WRENCH



Designed for strength and durability with maleable iron construction. Instant grip and release jaws are heat treated and non-replaceable.

UPC#	Description
60641	8 in. pipe wrench
60642	10 in. pipe wrench
60644	14 in. pipe wrench
60645	18 in. pipe wrench
60646	24 in. pipe wrench

PVC AND POLYETHYLENE PIPE CUTTER



- Easy ratchet action and unique hooked tube-gripping jaws give an easy and clean cut
- Steel alloy blade is replaceable, repairable and heat-treated for long life

UPC#	Description
60190	PVC pipe cutter up through 3/4"
60191	PVC pipe cutter up through 1-1/4"
60152	PVC pipe cutter up through 2-1/8"
60193	Replacement blade for 60190
60194	Replacement blade for 60191
60155	Replacement blade for 60152

CAPILLARY CUTTER



Cleanly cut capillary tubing without flattening or constricting tubing.

UPC#	Description
60195	Capillary cutter



TIPS FOR CUTTING

Cutters are designed for different applications and materials, and must be used properly for optimum performance.

- Tubing cutters are designed for softer thinner-wall materials such as copper, aluminum and brass. The wheel is designed very specifically with a sharp edge for quick cutting
- Black iron pipe cutters are larger in size and use fine pitch threads and large rollers for clean right-angle cuts

To ensure lasting tool performance, use the correct cutters for copper and pipe cutters for black iron pipe.

Tube cutter parts – organized by cutter							
UPC#	Qty	Pkg*	UPC#	Qty	Pkg*	Description	Cutter
60098	1	B	60099	10	B	Cutter wheels for stainless	60101, 60102, 60103
60079	1	B	60097	5	B	Pin and clip for wheel	60101, 60102, 60103
—	—	—	60094	5	B	Clip only for pins above	60101, 60102, 60103, 60122
60093	1	B	—	—	—	Package one each wheel, pin, clip	60101, 60102, 60103
60100	1	B	60107	10	B	Cutter wheels for copper	60101, 60102, 60103, 60160
60106	1	B	60117	10	B	Constrictor wheels	60101, 60102, 60103
60077	1	B	60095	5	B	Reamer screw and washer	60101, 60102, 60103
60078	1	B	60096	5	B	Reamer	60101, 60102, 60103
60108	1	B	60129	5	B	Screw for knob	60101, 60102, 60103
60074	1	B	60075	5	B	Screw for cutter wheel	60121
60072	1	B	60073	10	B	Cutter wheels	60121
60080*	1	B	60125*	5	B	Screw for cutter wheel	60121, 60123
60120*	1	B	60116*	20	B	Cutter wheels	60121, 60142
60144	1	B	60143	5	B	Cutter blade pin and clip	60142
60124	1	B	60115	10	B	Cutter wheels	60139
60136	1	—	60140	5	—	Screw/retainer	60139
60172	1	B	—	—	—	Screw for handle	60139
60174	1	B	—	—	—	Spring for shaft	60139
60165	1	—	—	—	—	Replacement deburr tool	60139
60147	1	B	60148	5	B	Cutter wheels	60146
60141	1	B	60149	5	B	Screws for cutter wheels	60146
60166	1	—	—	—	—	Replacement deburr tool	60146
60110	1	B	60088	10	B	Cutter wheel	60122 and 60160
60081	1	B	60085	10	B	Screw	60122 and 60160
60110	1	B	60088	10	B	Spare cutting wheel	60122 and 60160
60081	1	B	60085	10	B	Spare screw	60160
60111	1	B	60089	10	B	Cutter wheel for Imperial	75015 174-F, 274-F, 312-FB, 374-FC, TC 1000, TC 1020, TC 2050
60112	1	B	60090	10	B	Cutter wheel for stainless Imperial	75046 174-F, 274-F, 312-FB, 374-FC, TC 1000, TC 1020, TC 2050
60082	1	B	60086	10	B	Screw for Imperial	74762 174-F, 274-F, 312-FB, 374-FC, TC 1000, TC 1020, TC 2050
60113	1	B	60091	10	B	Cutter wheel for Imperial	74761 206-FA
60083	1	B	60087	10	B	Screw and nut for Imperial	77511 206-FA

* For old model with Ritchie imprint.

SERVICE COUNTER KIT



Kit quantities only. Order individual parts and paks for restocking from chart.

Service counter cutter parts kit 60130			
UPC#	Qty	Description	Cutter
60130		Counter selection - tube cutter maintenance kit as below	
60179	1	Kit box only with label - empty	
60100	3	Cutter wheels for copper	60101
60079	3	Pin and clip for wheel	
60077	3	Reamer screw and spacer	
60078	3	Reamer	60102
60106	3	Constrictor wheel	60103
60098	3	Cutter wheel for stainless	60121 (old)*, 60142
60108	3	Screw for knob	
60120	6	Cutter wheels	60121 (new)*
60072	3	Cutter wheels	60121 (new)*
60080	3	Cutter wheel screw and retainer	60121 (old)*
60074	3	Cutter wheel screw and retainer	60121 (new)*
60144	3	Cutter pin and clip for wheel	60142
60124	3	Cutter wheels	60139
60136	3	Cutter wheel screw and retainer	60139
60110	3	Spare cutting wheel	60160
60081	3	Spare screw	60160

* 60121 (old) model with Ritchie imprint.

* 60121 (new) model with YELLOW JACKET imprint.

RETAINING RING PLIERS – COMBINATION INTERNAL/EXTERNAL

Compact pliers for use on SealRight™ coupler with interchangeable tips.



- Six point broached jaw for accurate tip alignment. Adjustable for hex tips
- High handle-to-jaw ratio for increased mechanical advantage
- Easy-to-use – just set lever to “internal” or “external”
- Adjustable stop for efficient internal ring installation and prevention of external ring damage
- Spring return for easy control
- Includes pouch with five pairs of alloy steel replaceable tips and hex wrench

Works on internal and external retaining rings where bearings are used, where a shaft must be held in a bore, under the dashboard and more.

UPC#	Description
60593	Small pliers for 1/4" - 1" (8 mm - 26 mm) internal rings; 1/8" - 1" (3 mm - 26 mm) external rings
60596	Replacement tip set for 60593: straight 0.023" (0.6 mm), 0.036" (0.9 mm), 0.047" (1.2 mm); 90° 0.036" (0.9 mm), 0.047" (1.2 mm)

HEX KEYS

All hex keys from 1/20" to 5/16" are premium 8650 heat-treated steel alloy for rugged use.

- Chamfered square cut ends for easy socket insertion
- Corrosion-resistant finish
- Patented organizer case with identifying slots that lock keys in place when not in use
- Ball end keys ease tightening of fasteners where sockets are up to 30° off axis. Provides fast full socket engagement where regular hex keys cannot do the job

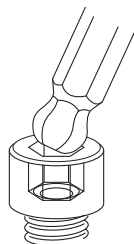

UPC# Standard end	Description		UPC# Ball end
	Size	Length	
60670	12 piece set with case		60685
60669	Metric – 12 piece set with case		–
All individual keys below are 10 paks			
60671	1/20"	2.8 inches	60686
60672	1/16"	3.0 inches	60687
60673	5/64"	3.2 inches	60688
60674	3/32"	3.4 inches	60689
60675	7/64"	3.6 inches	60690
60676	1/8"	3.7 inches	60691
60677	9/64"	3.9 inches	60692
60678	5/32"	4.1 inches	60693
60679	3/16"	4.5 inches	60694
60680	7/32"	4.9 inches	60695
60681	1/4"	5.1 inches	60696
60682	5/16"	6.0 inches	60697
60683	–	Case	60698

12" HEX KEY WRENCHES

- Heat-treated for long life
- Chamfered ends for easy insertion into sockets
- Black finish

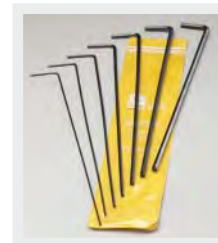

UPC# 25 per pkg.	Size	UPC# Individual
60750	Set 7 pcs. Hex key wrenches, includes all sizes below	
60757	5/64"	60857
60758	3/32"	60858
60760	1/8"	60860
60762	5/32"	60862
60763	3/16"	60863
60764	7/32"	60864
60765	1/4"	60865

FOLD-UP HEX KEY SETS



Locate the correct key size easily. For rugged use, each key is premium 8650 heat-treated steel alloy.

- Chamfered square cut ends for easy socket insertion
- Corrosion-resistant finish
- Smooth one-piece handle with sizes clearly marked
- Keys snap to work position for leverage and fold into handle for compact storage
- Replacement keys available

UPC#	Description
60700	Hex key set – 8 sizes - 1/20", 1/16", 5/64", 3/32", 7/64", 1/8", 9/64", 5/32"
60710	Hex key set – 9 sizes - 5/64", 3/32", 7/64", 1/8", 9/64", 5/32", 3/16", 7/32", 1/4"

FAN BLADE PULLER



All steel design includes a 15/16" hex head and 5/8" shaft milled back 1-1/2" and undersized for 1/2" shaft opening. A self centering alignment tool is included.

Four fingers attach to the fan blade. For durability they are made of hardened 4140 chrome moly steel.

- Remove squirrel cage type blower wheels
- Pull off fan blades
- Remove pulleys or sheaves
- Fits 1-3/4" hub maximum (will work on a 10" pulley if the diameter is less than 1-3/4")

Comes with 8 screws, 4 for hex key and 4 for wrench.

UPC#	Description
60590	Fan blade puller complete
60591	Replacement "fingers" (4)
60592	Bolt for 60590

PINCH-OFF TOOLS

60665 will pinch off and reread 1/4", 5/16", 3/8" and 1/2" copper.

60661 pinches off copper and other lines quickly. Trigger release.

60666 is a ViseGrip® pinch-off tool.



UPC#	Description
60665	Bar-style pinch-off and reread tool
60661	Plier type pinch-off tool
60666	ViseGrip® pinch-off tool

REFRIGERANT RECOVERY PLIERS



The fastest and easiest way to evacuate refrigerant before disposal of a unit.

- Snaps onto refrigerant line and punctures large hole for immediate and maximum full flow to recovery unit
- One adjustable tool fits all sizes from 3/16" to 7/8" O. D. hard tubing
- Replaceable hardened steel needle

UPC#	Description
60667	Refrigerant recovery pliers
60668	Replacement needle and gasket
19022	Replacement gasket only (5 pak)

HAND-HELD REFRACTOMETER

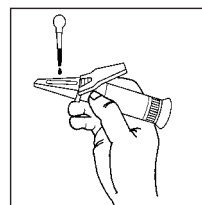

Place sample liquid on prism and close cover.

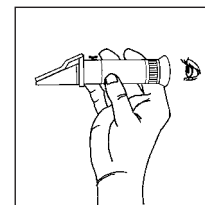

Look through the eyepiece and focus for scale reading.

For retrofitting a mineral oil system with POE, the refractometer can accurately predict remaining mineral oil in the system down to one percent. Acceptable levels of remaining oil depend on compressor/system manufacturer requirements.

Refractive range 1.435 to 1.520 at room temperature.

UPC#	Description
69000	Hand-held refractometer with case

MAX-FLOW™ COMBINATION OIL PUMP

Pump oil into the compressor *on the down stroke* while the system is under pressure, making pumping easier with a positive stroke.

- Remove oil for recovery and conversion
- Add oil to existing systems
- Pumps 2.6 oz. or 78 ml per stroke
- Pumps against 200 psi pressure
- Comfort-grip rubber handle
- Universal stopper automatically adjusts to all standard openings in 1, 2-1/2 and 5 gallon oil containers
- Suction transfer hose and fittings included. Connects to bottom of unit to pump oil from equipment quickly and efficiently
- Use with alkyl-benzene, ester-based, polyol ester, mineral and synthetic oils
- Made in the USA 



UPC#	Description
77940	Max-Flow combination oil pump with tubing
77941	Automatic stopper for oil container openings for new 77940 pump
77942	"O" ring kit for 77940
77920	Adapter fitting straight – 1/8" NPT Male x 1/4" flare
77921	Adapter fitting 90° angle – 1/8" NPT Male x 1/4" flare
77922	24" suction hose – 1/4" fitting one end only

Note: Not for use with ammonia laden oil.

MAX-FLOW™ DELUXE OIL PUMP

The Max-Flow deluxe oil pump is a high capacity unit for quick charging.

- Remove oil for recovery and conversion
- Add oil to existing systems
- Pumps 3.8 oz. (112.38 ml) per stroke
- Fits all size oil containers
- Foot stand base provides support and leverage while pumping against the high pressures of a running compressor
- Operating unit in reverse with adapter hose accessory removes oil from equipment quickly and efficiently
- Use with alkyl-benzene, ester-based, polyol ester, mineral and synthetic oils
- Will pump against 250 psi pressure
- Made in the USA 

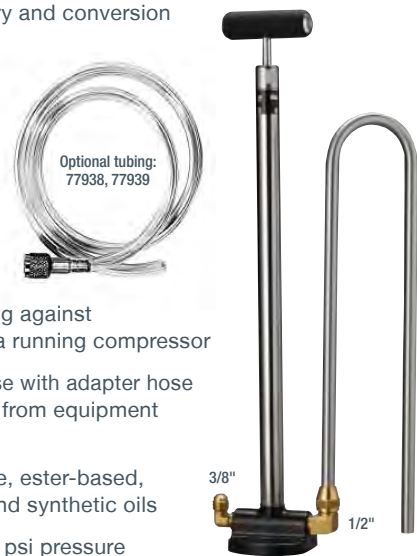

UPC#	Description
77930	Max-Flow deluxe oil pump
77925	Plastic seat
77931	"O" ring kit for 77930
77932	Piston rod assembly
77935	Ball spring – 2 each
77936	Replacement suction copper tube with 1/2" flare nut at one end
77933	Replacement fittings – 3/8" NPT Male x 1/2" flare – 90°
77937	Replacement fittings – 3/8" NPT Male x 3/8" flare – 90°
77938	Optional 1/2" flexible suction hose, 24" long – fitting one end only
77939	Optional 3/8" flexible drain hose, 24" long – fitting one end only
59653	1/2" copper gasket soft (10 pak)

REFILLABLE OIL INJECTORS

Add liquid to systems and sample refrigerant quickly and easily.

- Body and cap are rugged aluminum with "O" ring seal
- Male fitting at one end with Schrader. A ball valve for control on other end with a short length of hose
- Valve depressor in Female end
- 600 psi maximum working pressure
- Made in the USA 

UPC#	Description
69560	1/2 oz. Oil injector 1/4" Male flare x 1/4" Female Q.C.
69561	2 oz. Oil injector 1/4" Male flare x 1/4" Female Q.C.
69562	4 oz. Oil injector 1/4" Male flare x 1/4" Female Q.C.
69563	"O" ring 1/2 oz. injector (5 pak)
69564	"O" ring 2 and 4 oz. injector (5 pak)
69565	1/2 oz. R-134a auto injector with hose and service coupler
69566	2 oz. R-134a auto injector with hose and service coupler
69567	4 oz. R-134a auto injector with hose and service coupler
69722	Replacement hose for 69560, 69561 and 69562
69724	Replacement hose for 69565, 69566 and 69567



ERGONOMIC FINFIX™ COMBS

For 14 different fin sizes

Color-coded nylon fin combs are designed to easily straighten and clean fins on standard and high efficiency condensers and evaporators. Shape conforms to the hand and thumb for a more comfortable grip.



Available individually bagged or as a set of six assorted. One set of six covers 12 different fin sizes. 61157 is for high efficiency units.

Individual UPC#	Description	Fins per inch	Color	Bag of 25 UPC#
61151	FinFix 1	8 and 10	Orange	61161
61152	FinFix 2	9 and 15	Yellow	61162
61153	FinFix 3	11 and 13	Blue	61163
61154	FinFix 4	12 and 14	Green	61164
61155	FinFix 5	16 and 17	Lime	61165
61156	FinFix 6	18 and 20	Red	61166
61157	FinFix 7	21/22 and 23/24	Purple	61167
61158	Set of 6	8 to 20	Assorted	—

FIN STRAIGHTENERS

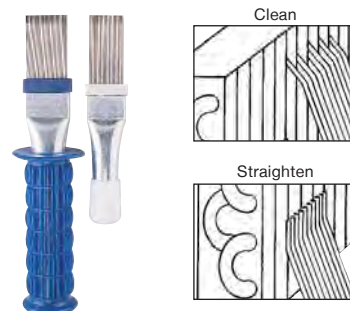

Fin straighteners straighten even severely damaged condenser and evaporator fins quickly and easily. Also clean away lint, rust, dirt and other debris.

Straightening wire tension is adjustable to accommodate various fin types. Wires are held by a sturdy metal body.

61170 includes a long comfort-grip handle, making straightener easier to use. Head is 20 percent wider than the 61150 to straighten more fins in one pass.

UPC#	Description
61150	Fin straightener
61170	Fin straightener with large handle

MECHANIX™ WORK GLOVES

Gloves feature a padded, two-way stretch lined spandex top for fit and flexibility.



- Smooth surface thumb and index finger improve grip
- Soft, flexible, durable and breathable synthetic leather palm
- Synthetic leather and lycra finger gussets
- Elastic cuff with adjustable hook and loop TPR closure

UPC#	Description
10057	Medium Mechanix™ work gloves
10058	Large Mechanix™ work gloves
10059	Extra large Mechanix™ work gloves

SAFETY GOGGLES



Helps protect your eyes against metal particles, sparks, refrigerant gases, etc. when working on HVAC/R systems.

Safety goggles are recommended any time you work on a system.

UPC#	Description
11002	Safety goggles
11003	Ventilated safety goggles

6-IN-1 FIN STRAIGHTENER

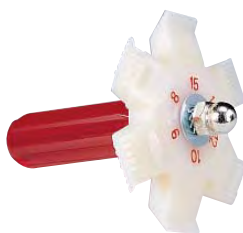

Fin straightener sizes are marked on the head - 8, 9, 10, 12, 14 and 15 fins per inch. Compact 4" length.

UPC#	Description
61171	6-in-1 Fin straightener
61172	Head only
61173	Handle only

STAINLESS TELESCOPING INSPECTION MIRRORS

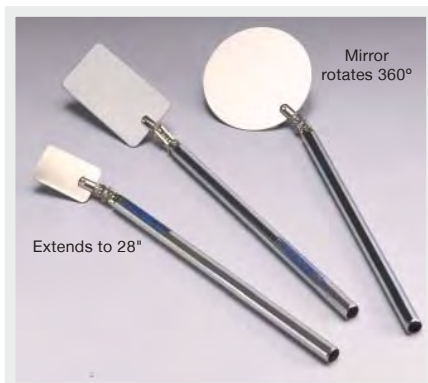

- Check leaks in hard to see places
- Stainless steel mirror on ball joint rotates 360°
- Handle extends to 28"

UPC#	Description
78100	Round 3-3/4" diameter
78101	Rectangular 3-3/4" x 2"
78102	Rectangular 2" x 1-1/4"

TELESCOPING GLASS MIRRORS

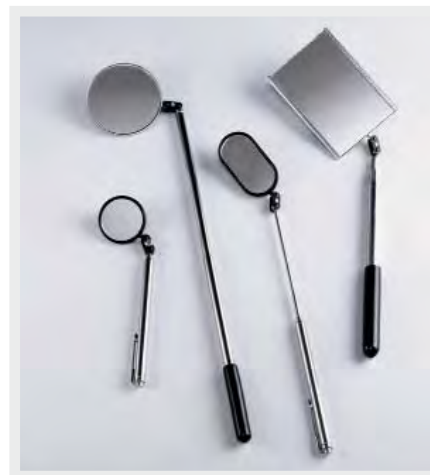

UPC#	Description	Extension
78094	2-1/4" round	9-1/4" to 14-1/4"
78097	2-1/4" round magnified (2X)	9-1/4" to 14-1/4"

With pocket clip and insulated head		
78098	1-1/4" round	7" to 19"
78099	1-1/4" round magnified (2X)	7" to 19"
78103	2" x 3-1/2" rectangular	11" to 15-1/2"
78104	1" x 2" oval	7" to 19"

Replacement mirrors only	
78105	2-1/4" round glass
78106	2" x 3-1/2" rectangular glass
78107	1" x 2" oval glass

RECOVERY MACHINES
VACUUM PUMP SYSTEMS
VACUUM AND CHARGING HOSES
HOSE ADAPTERS, VALVES AND PARTS
CHARGING SYSTEMS
GAUGES
WIRELESS AND ELECTRONIC INSTRUMENTS
HEATING INSTRUMENTS
LEAK MONITORS AND DETECTORS
SYSTEM TOOLS