

# T3DAQ1-16

## Data Acquisition System

### User Manual



## General Safety Summary

Read the following precautions carefully to avoid any personal injuries, or damage to the instrument or products connected to it. Use the instrument only as specified.

**Use only the power cord supplied for the instrument.**

**Ground the instrument.**

The instrument is grounded through the ground conductor of the power cord. To avoid electric shock, always connect to grounded outlets. Make sure the instrument is grounded correctly before connecting its input or output terminals.

**Connect the signal wire correctly.**

To avoid damage, observe input polarity and maximum voltage/current ratings at all times.

**Observe all terminal ratings and signs on the instrument to avoid fire or electric shock.**

Before connecting to the instrument, read the manual to understand the input/output ratings.

**Do not operate with suspected failures.**

If you suspect that the instrument is damaged, contact the Teledyne LeCroy service department immediately.

**Do not operate in wet/damp conditions.**

**Do not operate in an explosive atmosphere.**

**Keep the surface of the instrument clean and dry.**

**Avoid touching exposed circuits or wires.**

Do not touch exposed contacts or components when the power is on.

**Do not operate without covers.**

Do not operate the instrument with covers or panels removed.

**Use only the fuse specified for the instrument.**

**Use proper overvoltage protection.**

**Use anti-static protection.**

Operate in an anti-static protected area. Ground measurement cable conductors before connecting to the instrument to discharge any static electricity before connecting the cables to the instrument.

**Observe ventilation requirements.**

Ensure good ventilation. Check the vent and fan regularly to prevent overheating.

## Safety Terms and Symbols

The following terms may appear on the instrument:

**DANGER:** Direct injury or hazard may occur.

**WARNING:** Potential injury or hazard may occur.

**CAUTION:** Potential damage to instrument/property may occur.

**CAT I<sup>1</sup>:** IEC Measurement Category I, applicable for making measurements on 'other' circuits that are not directly connected to mains. See p. v.







**CAT II:** IEC Measurement Category II, applicable for making measurements on circuits connected directly to utilization points (socket outlets and similar points) of the low voltage mains installation. See p. v.

1) CAT I as defined in IEC/EN 61010-031:2008.

Note that Measurement Category I was removed in IEC/EN 61010-031:2015 and replaced by 'O', indicating "other circuits that are not directly connected to mains."

## Safety Symbols

The following symbols may appear on the instrument:

						
<b>CAUTION</b> Risk of injury or damage. Refer to manual.	<b>WARNING</b> Risk of electric shock or burn	Earth Ground Terminal	Protective Conductor Terminal	Frame or Chassis Terminal	ON/Standby Power	Alternating Current

## Operating Environment

**Temperature:** 0 °C to 40 °C

**Humidity:** 5% to 90% relative humidity (non-condensing) up to +30°C. Upper limit derates to 50% relative humidity (non-condensing) at +40°C.

**Altitude:**  $\leq$  2000 m

**Use indoors only.**

**Pollution Degree 2.** Use in an operating environment where normally only dry, non-conductive pollution occurs. Temporary conductivity caused by condensation should be expected.

### AC Power

#### Input Voltage & Frequency:

100-120 V at 50/60 Hz

200-240 V at 50/60 Hz

Manual AC selection with a slide switch.

**Power Consumption:** 20 W maximum

**Mains Supply Connector:** CAT II per IEC/EN 61010-1:2010, instrument intended to be supplied from the building wiring at utilization points (socket outlets and similar).

### Fuse Type

**Current Input Terminal:** 250 VAC F 10 A, 3 AG

**AC Mains:** 250 VAC F 300 mA, 5x20 mm

## Input Terminal Protection Limitation

Protection limitation is defined for the input terminal.

### 1. Main Input (HI and LO) Terminals

**HI** and **LO** terminals are used for Voltage, Resistance, Capacitance, Continuity, Frequency, Diode and Temperature measurement. Two protection limitations are defined:

- **HI-LO protection limitation:** 1000 VDC or 750 VAC. This is the maximum measurable voltage. The limitation can be expressed as 1000 Vpk.
- **LO ground protection limitation:** **LO** terminal can “float” 500 Vpk relative to the ground safely. The maximum protection limitation of **HI** terminal relative to the ground is 1000 Vpk. Therefore, the sum of the “float” voltage and the measured voltage can't exceed 1000 Vpk.

### 2. Sampling (HISense and LOSense) Terminals

**HISense** and **LOSense** terminals are used for 4-wire Resistance measurement. Two protection limitations are defined:

- **HISense-LOSense** protection limitation: 2000 Vpk.
- **LOSense-LOSense** protection limitation: 2 Vpk.

### 3. Current Input (I) Terminal

The **I** terminal is used for current measurement. The maximum current which can go through the **I** terminal is limited to 10 A by the fuse on the back panel.

**NOTE:** Voltage on the current input terminal corresponds to voltage on the **LO** terminal. To keep good protection, only use a fuse of the specified type and value to replace this fuse

## IEC Measurement Category II Overvoltage Protection

To avoid the danger of electric shock, the Data Acquisition Unit provides overvoltage protection for line-voltage mains connections that meet both of the following conditions:

1. The HI and LO input terminals are connected to the mains under Measurement Category II conditions described in the warning below.
2. The maximum line voltage of the mains does not exceed: 600 VAC for the instrument.

### **WARNING:**

IEC Measurement Category II includes electrical devices connected to mains at an outlet on a branch circuit, such as most small appliances, test equipment, and other devices that plug into a branch outlet or socket.

The DAQ is capable of making measurements with the HI and LO inputs connected to mains in such devices ( $\leq 600$  VAC) or to the branch outlet itself.

However, the HI and LO terminals of the DAQ can't be connected to mains in permanently installed electrical devices such as the main circuit-breaker panels, sub-panel disconnected boxes and permanently wired motors. Such devices and circuits are prone to exceed the protection limits of the DAQ.

## Limits for Measurements on Other Circuits Not Directly Connected to Mains

**Max. rated input voltage:**  $1000V_{rms}$

**Transient overvoltage:**  $4000V_{pk}$

### **WARNING:**

Voltages above 600 VAC can only be measured in circuits that are isolated from mains. However, there may be transient over voltage in circuits that are isolated from mains. The DAQ is able to withstand occasional transient overvoltage up to 4000 Vpk. Please don't use this instrument to measure circuits where transient overvoltage may exceed this level.

## Daily Maintenance and Cleaning

### Maintenance

Protect the liquid crystal display from direct sunlight when storing or using the instrument.

NOTE: To avoid damage to the instrument or test leads, please don't place them in mist, liquid or solvent.

### Cleaning

Regularly clean the instrument and test leads.

- Wipe the external dust off the instrument and test leads using a soft rag. Be careful not to scratch the display screen when cleaning. Do not allow any liquid to enter the instrument.
- Use a damp soft rag to clean the instrument after removing the power plug. Use 75% isopropyl alcohol or water solvent to get a more thorough cleaning.

NOTE: To prevent the surface of the instrument or test leads from damage, please don't use any corrosive or chemical cleaning reagents. Please make sure the instrument is fully dry before re-connecting the power to avoid short circuits or personal injury.

## Introduction to T3DAQ1-16

Teledyne Test Tools **T3DAQ1-16** is a 16 channel Data Acquisition System incorporating the latest 4.3 inch (10.92 cm) dual-display technology which can be configured to show Data Histograms, Data fluctuation Trends, Bar Graph, Statistics or the traditional Number mode, all in an easy to use interface. The T3DAQ features 12 multi-purpose + 4 current channels and supports various measurement functions. It provides a convenient and versatile solution for test applications that require multiple measurement points or signals and is an ideal tool for R& D burn-in and production testing.

A great feature of the Teledyne Test Tools T3DAQ is its ability to make highly accurate True RMS AC Voltage and Current measurements, meaning no loss of accuracy even when measuring complex voltage and current waveforms.

The T3DAQ provides various measurement modes to satisfy a wide range of application requirements. 12 Multi-purpose channels can be configured individually for various scan requirements. The Channel configuration function allows user to configure different parameters such as measurement type, range, scan mode, number of scan cycles, and duration of scan. Similarly, the scan control menu provides flexibility to schedule, start, and stop the scan. Scanning data can be viewed live during a scan and can also be saved for future use. An internal 1 GB flash memory is available for data logging and to save configuration files. The T3DAQ also features a USB Host interface to use a USB flash drive to collect data without being connected to a PC.

The T3DAQ is equipped with LAN and USBTMC interfaces for remote control of the device. The device can be controlled remotely using EasyDMM software. The graphical interface of the software makes it easy to configure measurements, setup and execute scans or troubleshoot the design. Live measurement data can be viewed in numeric digits or graphically by trend chart, bar graph and histogram. The data can be manually or automatically exported as CSV files for further analysis.

### Main features:

- 4.3" TFT-LCD Display
- Dual display, Chinese and English Menu
- Built-in front panel accessible help system
- File management (support for U-disc and local storage)
- Real 6-5 digit (2,200,000 count) readings resolution
- True-RMS AC Voltage and AC Current measuring
- 1 GB flash memory for mass storage configuration files and data files
- Built-in cold terminal compensation for thermocouple
- Standard interface: USB Device, USB Host, LAN
- USB & LAN remote interfaces support common SCPI command set



# Contents

General Safety Summary . . . . .	i
Daily Maintenance and Cleaning . . . . .	vi
Introduction to T3DAQ1-16 . . . . .	vii
<b>1 Quick Start</b>	<b>1</b>
General Inspection . . . . .	1
Dimensions . . . . .	2
Handle Adjustment . . . . .	3
Front Panel . . . . .	4
Rear Panel . . . . .	7
Starting the DAQ . . . . .	9
Operating Instructions . . . . .	10
User Interface . . . . .	16
Measurement Connections . . . . .	17
Connecting to USB and LAN Ports . . . . .	20
Using the Built-in Help System . . . . .	21
<b>2 Function and Operation</b>	<b>22</b>
Measurement Configuration . . . . .	22
Basic Measurement Functions . . . . .	31
Dual-display Function . . . . .	53
Utility Function . . . . .	55
Acquire . . . . .	69
Help System . . . . .	73
Math Function . . . . .	75
Display Mode . . . . .	82
Trigger . . . . .	88
Hold Measurement Function . . . . .	89
<b>3 Measurement Tutorial</b>	<b>90</b>
Display Mode . . . . .	90
Crest Factor Errors (non-sinusoidal inputs) . . . . .	91
Loading Errors (AC Voltage) . . . . .	92

<b>4 General Troubleshooting</b>	<b>93</b>
<b>5 Appendix</b>	<b>95</b>
Certifications . . . . .	97

© 2021 Teledyne LeCroy, Inc. All rights reserved.

Teledyne Test Tools is a brand and trademark of Teledyne LeCroy, Inc. Other product or brand names are trademarks or requested trademarks of their respective holders. Specifications, prices, availability and delivery subject to change without notice.

# Chapter 1

## Quick Start

### General Inspection

Please check the instrument according to the following steps.

**1. Inspect the shipping container.**

Keep the shipping container and packaging material until the contents of the shipment have been completely checked and the instrument has passed both electrical and mechanical tests. It is always good practice to save the shipping container and packaging for use when returning the power supply to Teledyne LeCroy for service or calibration.

The consigner or carrier will be responsible for damage to the instrument resulting from shipping. Teledyne LeCroy will not provide free maintenance or replacement in this instance.

**2. Inspect the instrument.**

If the instrument is found to be damaged, defective or fails in electrical or mechanical tests, please contact the Teledyne LeCroy service department immediately.

**3. Check the accessories.**

Please check that you have received the accessories on the packing list:

- 1 DAQ
- 1 Test Lead Set
- 1 USB Cable

If the accessories are incomplete or damaged, please contact Teledyne LeCroy immediately.

## Dimensions

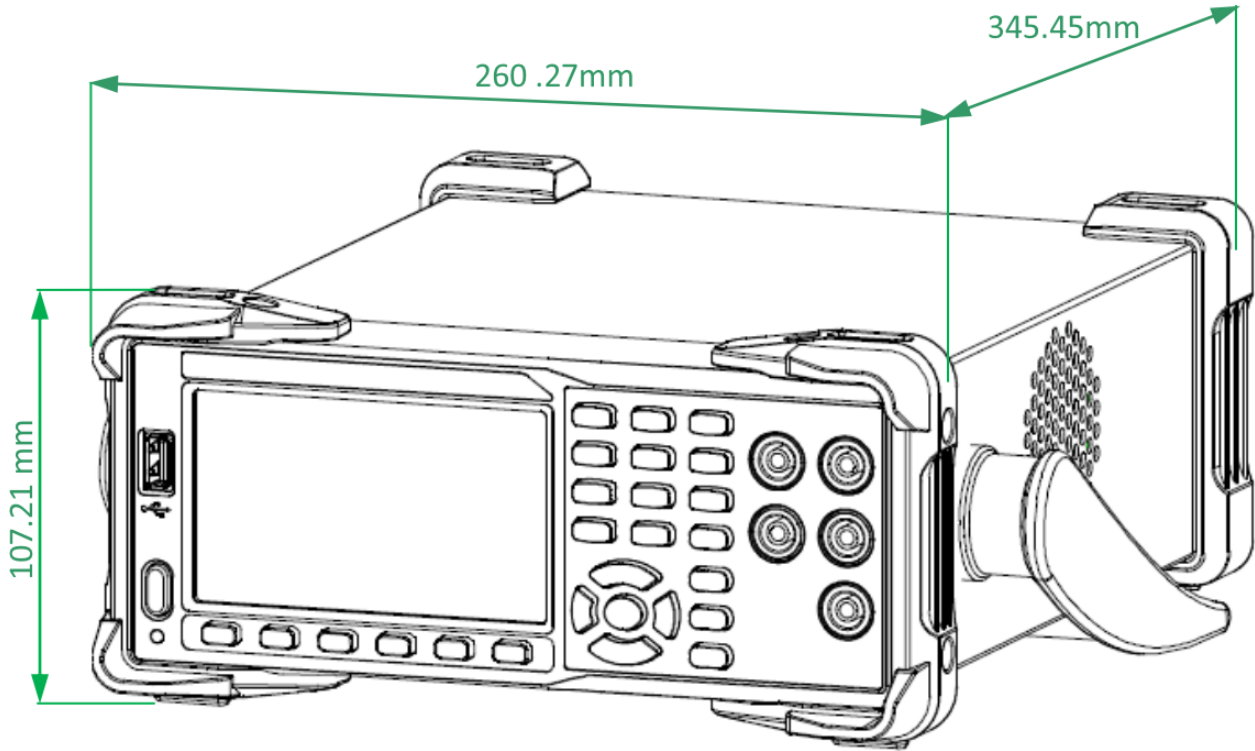

Appearance and Size

## Handle Adjustment

To adjust the handle position of the DAQ, grip the handle by the two sides and pull outward. Then, rotate the handle to the appropriate position.

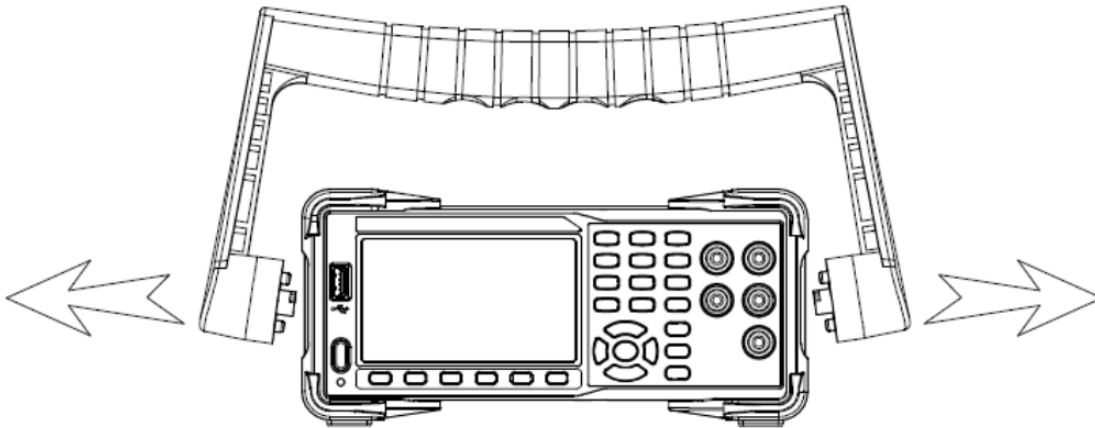

Handle Adjustment

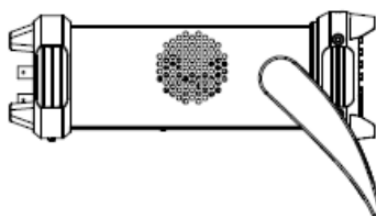
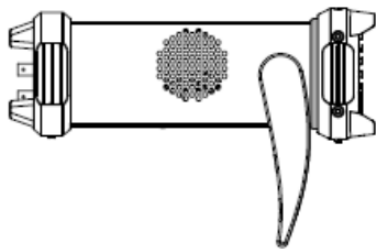
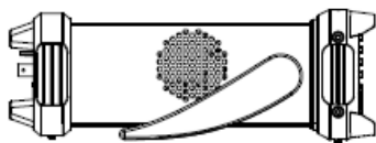

Horizontal Position

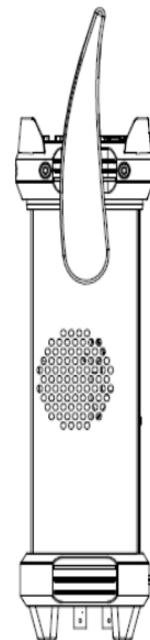

Carrying Position

## Front Panel



### A USB Host

Users can store the current state or measurement data into a USB storage device. Users can also read the state files or updated firmware from a USB storage device.

### B Power Key

Turn the instrument on or off.







### C LCD Display

The instrument provides a 4.3 inch high resolution color TFT-LCD display screen with 480\*272 pixels that displays the function menus, measurement parameter settings, system status, and prompt messages.

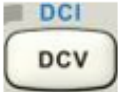
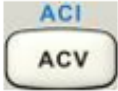
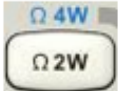

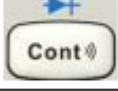
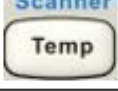
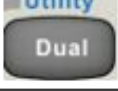
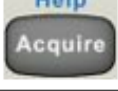

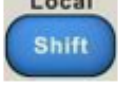

### D Menu Operation Keys

Press any softkey to activate the corresponding menu.

## E Measurement and Assistant Function Keys

	DC Voltage/Current Measurement
	AC Voltage/Current Measurement
	2-Wire/4-Wire Resistance Measurement
	Frequency/Capacitance Measurement
	Continuity/Diode Test
	Temperature Measurement/Enable Multiple Scan Card Function
	Enable Dual-display Function/Set Up the Utility
	Acquire Function/Help System
	Math Function/Display Function
	Auto Trigger/Stop
	Single Trigger/Hold Measurement Function
	Return to local control of the instrument (when in Remote mode). Some of the front panel keys have text above them. This indicates that the key has a function that you can access by pressing and releasing [Shift] before pressing the key.

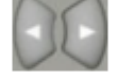
## F Range and Direction Keys

	Increase the measurement range
	Decrease the measurement range
	Select auto or manual range
 	Set up measurement parameter Move the cursor Page up or down
	Set up measurement parameter Move the cursor
	Apply the current setting

## G Signal Input Terminals

The measured signal (device) will be connected into the DAQ through these terminals. Different measurement objects have different connection methods. For details, please refer to “**Measurement Connections**”.



## Rear Panel

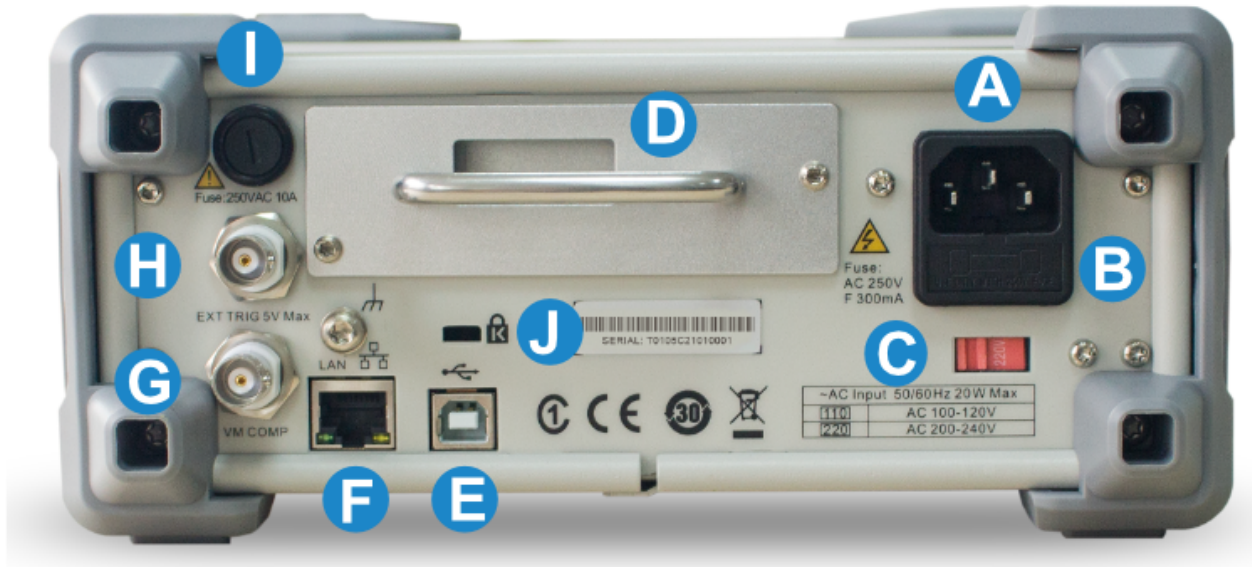

### A Power Socket



The DAQ accepts two types of AC supplies. Please use the power cord provided in the accessories to connect the DAQ to the AC power through this socket. Note: The correct voltage scale must be first selected (through the Voltage Selector) before power connection.

### B Power Fuse

The DAQ is already installed with a power fuse before leaving factory. To change the fuse please:

- Turn off the DAQ and remove the power cord.
- Press down the block tongue using a straight screwdriver (in the direction of the dotted arrow in the figure below) and pull out of the fuse seat.
- Select a proper voltage scale.
- Replace a specified fuse.
- Reinstall the fuse seat into the slot.

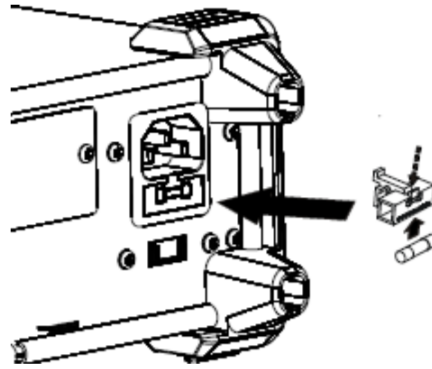

Change the fuse

### C AC Voltage Selector



Select the correct voltage scale (110 V or 220 V) for the AC supply used.

### D 16-channel Data Acquisition Module

#### E USB Device

Connect the PC through this interface. SCPI commands or PC software can be used to control the DAQ remotely.

#### F LAN

Through this interface, the DAQ can be connected to the network for remote control.

#### G VMC Output

The DAQ outputs a low-true pulse from the [VM Comp] connector after every measurement.

#### H Ext Trigger

Trigger the DAQ by connecting a trigger pulse through the [Ext Trig] connector. Note the external trigger source must be selected.

#### I Current Input Fuse

The DAQ is already installed with a current Input fuse to provide 10 A maximum input protection before leaving factory. To replace a new one, please:

- (a) Turn off the DAQ and remove the power cord.
- (b) Turn the fuse seat counterclockwise as shown in the figure using a straight screw driver and then pull out the fuse seat
- (c) Place a new 10 A specified fuse.
- (d) Reinstall the fuse seat into the slot.

#### J Instrument Kensington Lock Point

A Kensington lock (not supplied) can be used to lock the DAQ to a fixed place if necessary.

## Starting the DAQ



Before connecting the instrument to a power source please adjust the AC voltage selector on the rear panel of your DAQ according to your local power supply voltage. Then connect the power cord as shown in the following figure.

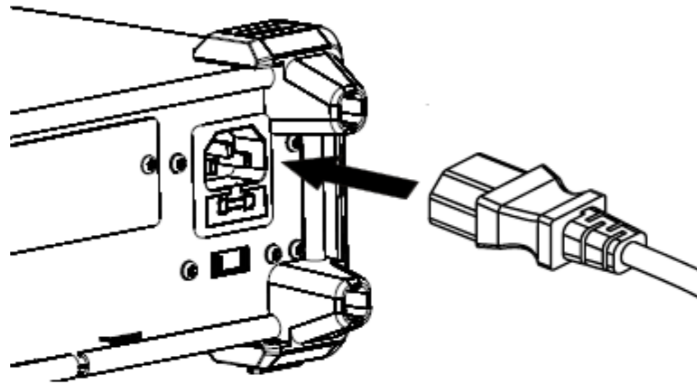

Connect Power Cord

Press the Power key on the front panel to turn on the DAQ. If the DAQ does not start normally, then try the following:

1. Make sure the power cord is in good connection and connected to the DAQ and the wall socket.
2. Ensure that the wall socket has power and is turned on.
3. Try to restart the DAQ, if it fails, check the power fuse and replace with a new one if necessary.
4. If the problem still remains, please contact the Teledyne LeCroy service department for help.

## Operating Instructions

**NOTE:** The Scanner Card is not designed to be "Hot Swappable". Please make sure the instrument is turned off before installation or removal of the Scanner Card. Hot swapping the card could cause damage to the instrument and is not covered under warranty.

### 1. Power Off

Turn the Power Off and take out the power cord

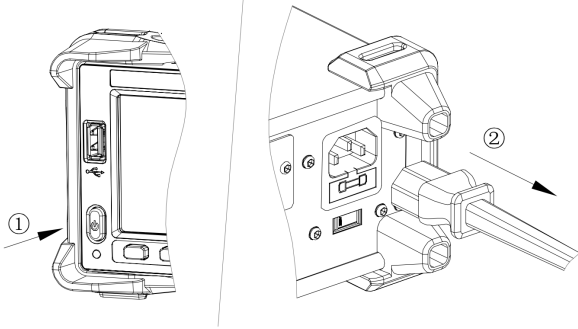

### 2. Open the DAQ rear panel slot

Take off the two screws on the slot corners to remove the optional slot cover. Keep the screws for later reuse

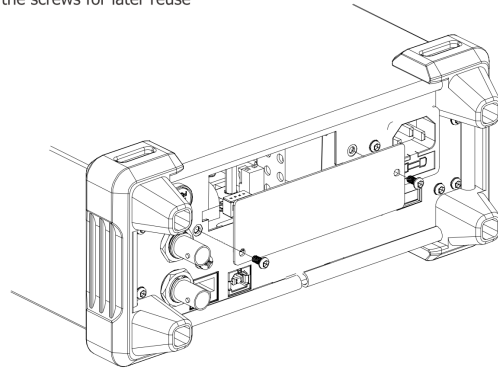

### 3. Connection

Turn the clamp and insert the wire.

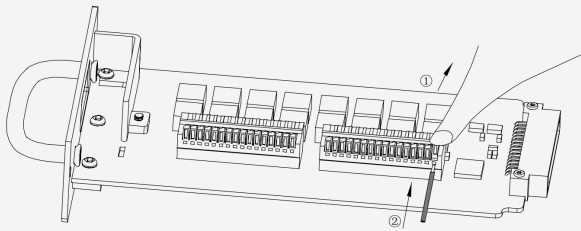

### 4. Tighten cable

Route wiring through strain relief and Cable tie rap Wrap

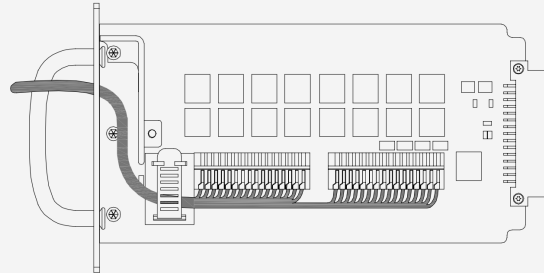

### 5. Insert the Scanner Card

Insert the Scanner Card bottom-side-up. Close the cover by tightening the screws.

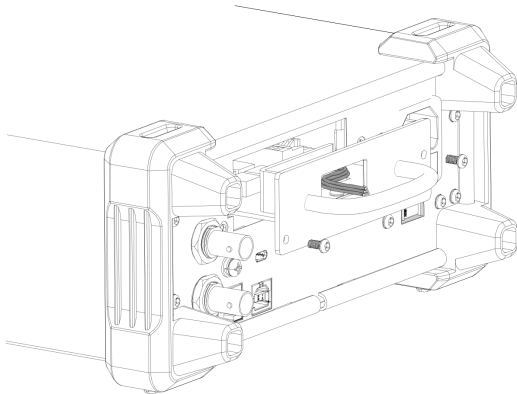

### 6. Power On

Connect the power cord and turn On the power

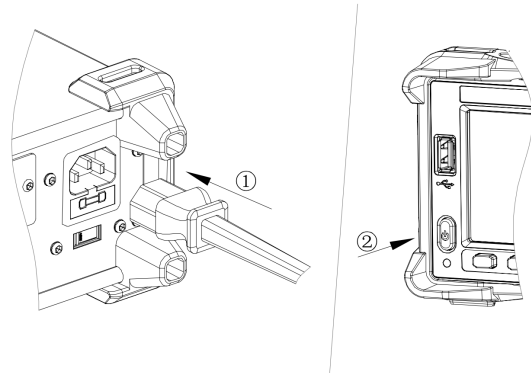

### Scanner Card Connections

An example of 2-wired connection application is shown below.

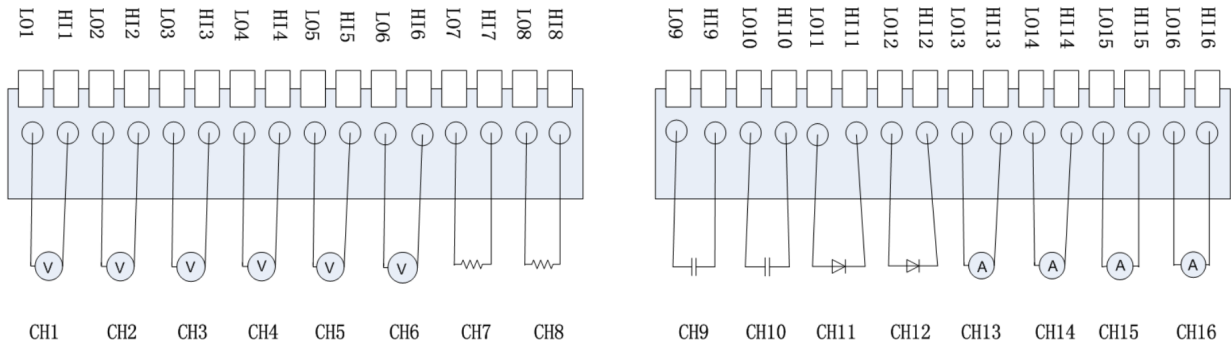

First 12 channels can be used to measure DCV/DCI ACV/ACI/CAP/FREQ/DIODE/CONT/TEMP and the last 4 channels are dedicated to current measurement.

4-Wire Resistance measurement example is shown below.

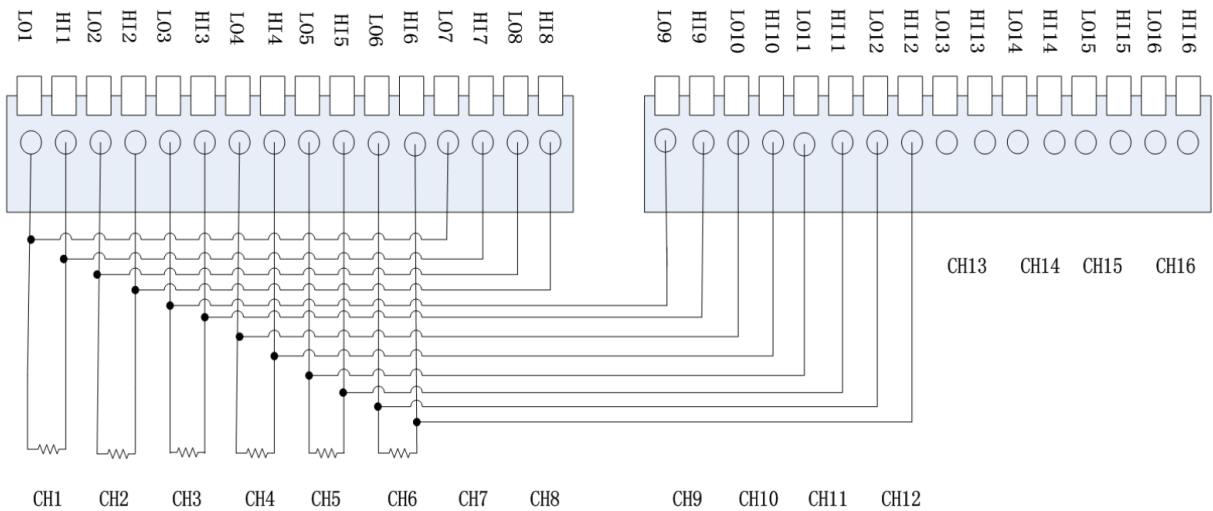

CH1 to CH6 can be used for measurements and CH7 to CH12 can be used as sense channels. To minimize voltage errors, the remote sense connections (CH7,CH8 etc..) should be made as close to the device-under-test (DUT) as possible.

## Front Panel Operations

Scanner mode functions can be accessed by pressing "Shift" and "Temp" buttons.

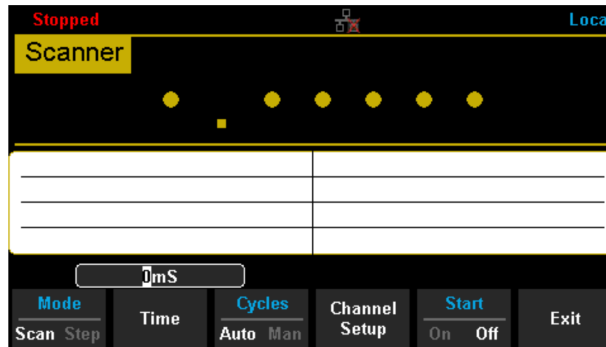

The following table gives a short description about different functions available.

Function Menu	Settings	Description
Mode	Scan/Step	Set the operation mode
Time	0ms-999.999s	Sets the duration between each scan loop (Scan mode) or between each scanned channel (Step mode)
Cycles	Auto/Man	Sets the number of scan operations
Channel Setup		Sets the scanned channel range, measurement function, and measurement parameters
Start	On/Off	Start or stop scan operation
Exit		Exit the scanner function

### 1. Operation mode setup

- Scan: Measures all specified channel ranges (Channel MIN-MAX) for each trigger event. Time settings are applied between each scan for the whole channel range.
- Step: Measures a single channel in the specified range (Channel MIN-MAX) at each trigger event. Time settings are applied for each channel.

### 2. Time setup

Use the direction keys to set the duration between each scan loop (Scan mode) or between each scanned channel (Step mode)

### 3. Cycles

- Auto: The instrument will scan specified channel circularly after the scan operation start and you should stop the operation manually.

•Manual: Sets the number of scan operations by direction keys. The range of the setting is from 1 to 999. After starting the scan operation the instrument will not stop scanning until reaches cycle number.

#### 4. Channel setup

Press the [Channel Setup] to enter the setup interface.

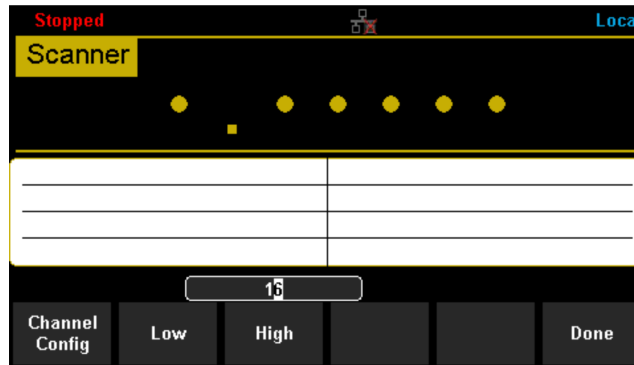

The table below gives a brief description of Function menu.

Function Menu	Description
Channel Config	Open/close the channel and set the measurement function, measurement parameters of specified channel.
Low	Set the low value of scanned channel range.
High	Set the high value of scanned channel range.

Press the [Channel Setup] to enter the channel configuration interface and set the channel switch, function, range and speed.

Scanner Channel Configure :				
Channel	Switch	Function	Range	Speed
1	Open	DCV	Auto	Slow
2	Open	DCV	Auto	Slow
3	Open	DCV	Auto	Slow
4	Open	DCV	Auto	Slow
5	Open	DCV	Auto	Slow
6	Open	DCV	Auto	Slow
7	Open	DCV	Auto	Slow
				Done

The range setting is applicable for the following functions: DC/AC Voltage (DCV/ACV), 2/4 Wire Resistance (2W/4W), Capacitance (CAP), Frequency (FRQ).

Ranges available for various functions is given below.

Function Menu	Description
DCV/ACV/ FRQ	Auto, 200mV, 2V, 20V, 200V
DCI/ACI	2A (fixed)
2W/4W	Auto, 200Ω, 2kΩ, 20kΩ, 200kΩ, 2MΩ, 10MΩ, 100MΩ

The scanner function provides two measurement speeds: Fast (50 reading/s) and Slow (5 reading/s). (Fast: 1PLC, Slow: 10 PLC)

The speed setting is applicable for the following functions: DC/AC Voltage (DCV/ACV), 2/4 Wire Resistance (2W/4W)

**Operating instructions:**

- Move the cursor to choose the wanted parameter by direction keys and the background color of cursor's position turns to gray.
- Select the current item by pressing "OK" key and the background color of the selected item turns to green.
- Set the parameter by up and down direction keys.
- Press "OK" key again to store the setting of the selected item of which the background turns back to gray. Move the cursor and repeat the prior steps to set the next parameter.
- Press [Done] to save the current settings and return to the higher level menu.

**5. Channel range setting**

Select [High] or [Low] and then input numerical value by direction keys. Note: The upper limit value should be always bigger than the lower limit value.

**6. Start scan operation**

Set the [Start] to on to start the scan operation

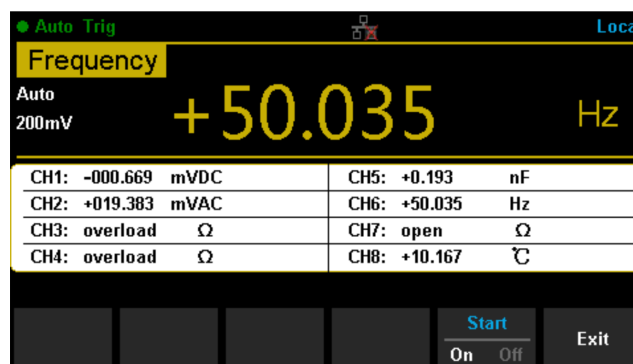

The upper part of the interface displays the function, range, and result of the current channel. The table below records the measurement result of each channel.

**7. Enter trend chart and statistics mode (optional operation)**

Press "Shift" and "Math" to open trend chart and statistics function.



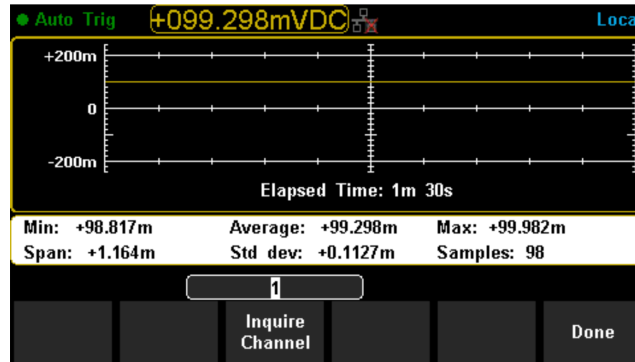

Set the [Inquire Channel] by direction keys and the interface displays the minimum, average, maximum, span, standard deviation, samples and trend chart of measurement results of the setting channel during the scan operation. Press [Done] to return to higher level menu.

### 8. Stop scan operation

Set the [Start] to off to stop the scan operation. If the [Cycles] is set to manual, then the instrument will stop scan when it reaches the cycle number

### 9. Store measurement data (optional operation)

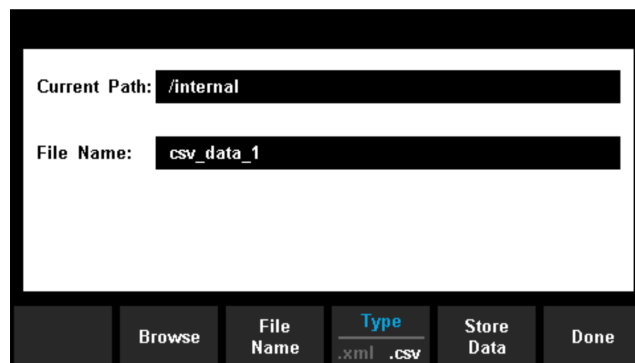

Press "Shift" and "Dual", then Select [Store/Recall] → [Store Settings] to enter the storage function interface.

## User Interface

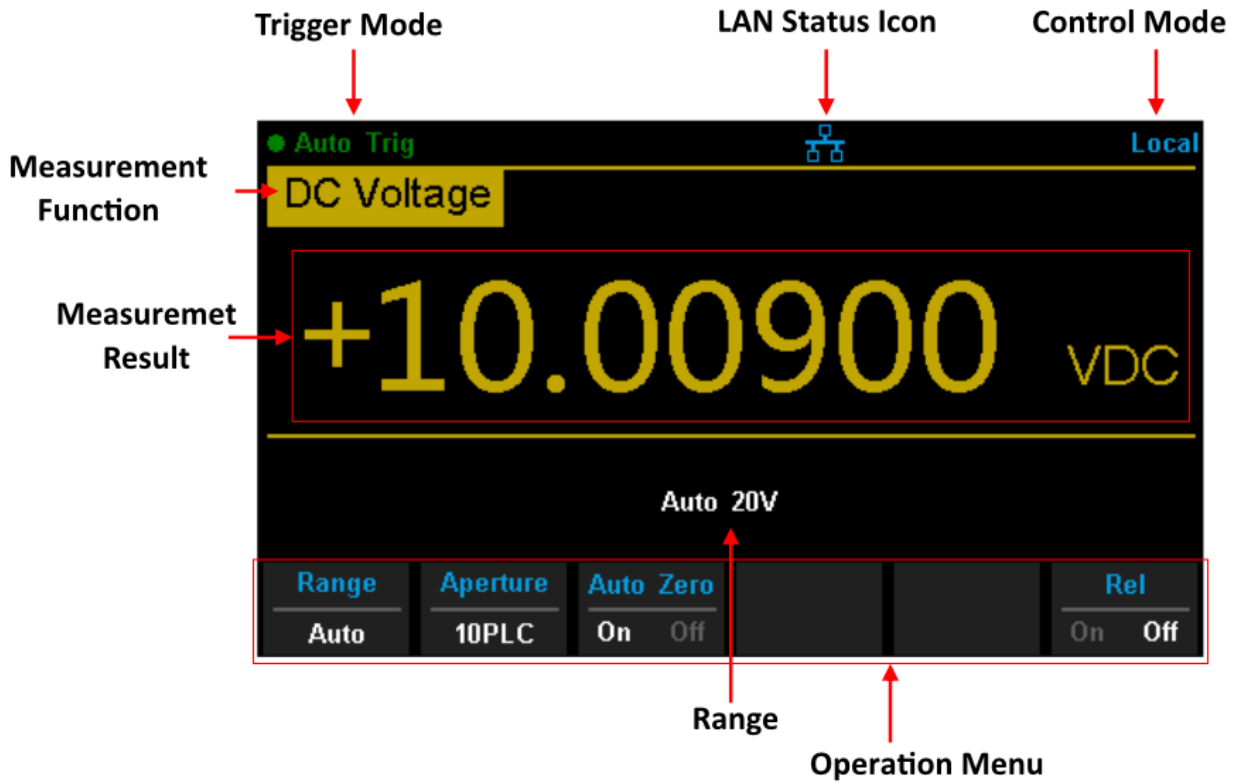

## Measurement Connections

The DAQ is designed with many measurement functions. After selecting the desired measurement function, please connect the signal (device) under test to the DAQ according to the method below. Do not switch the measurement function when measuring as it may cause damage to the DAQ. For example, when the test leads are connected to the related current terminals, AC voltage measurement should not be used.

### DCI Measurement

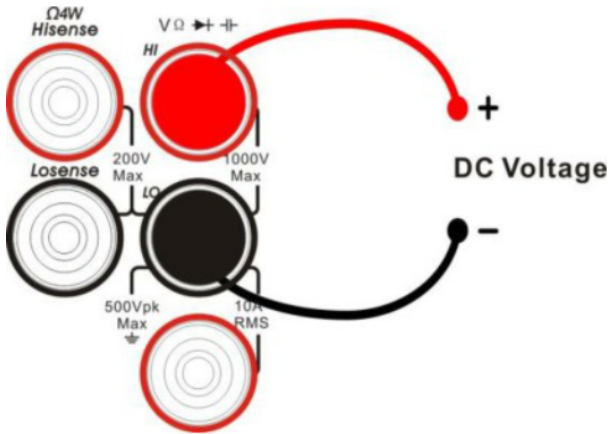

### ACI Measurement

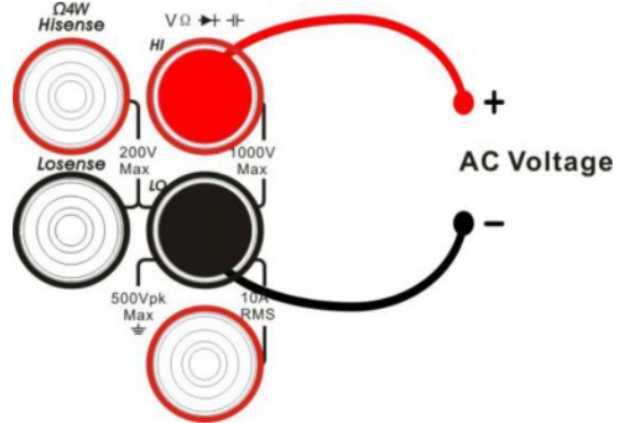

### DCI Measurement

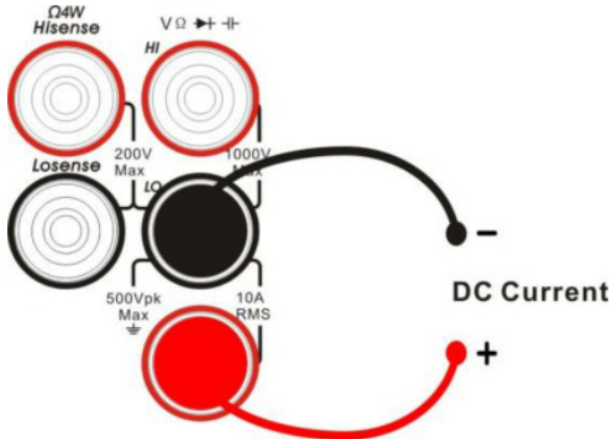

### ACI Measurement

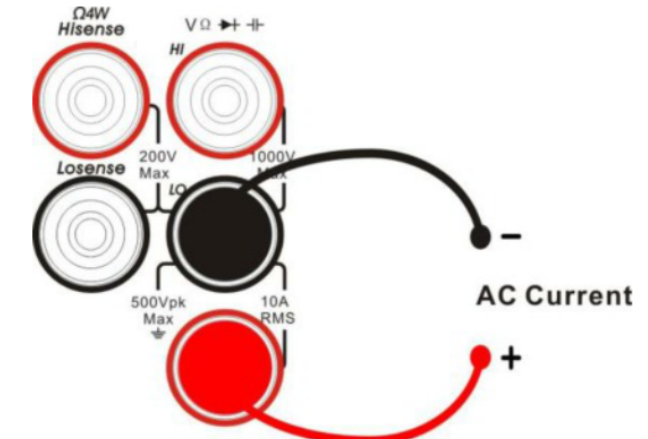

### Resistance Measurement (2-wire)

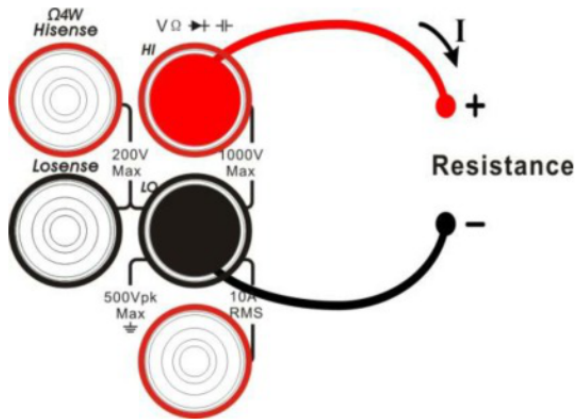

### Resistance Measurement (4-wire)

Connect the test leads and tested circuit as in the diagram below. The HI terminal and HI Sense should be connected to one end of the DUT. The LO terminal and LO Sense should be connected to the other end of the DUT.

### Capacitance Measurement

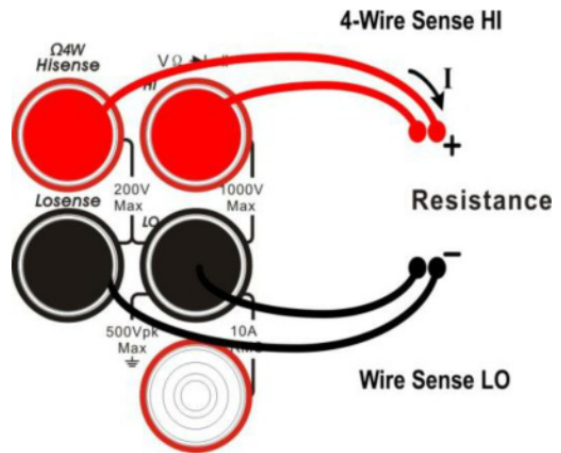
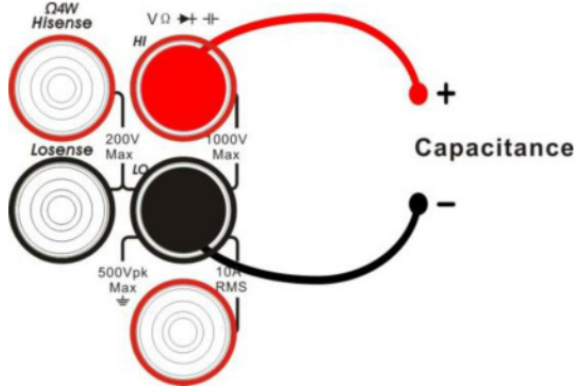

### Continuity Measurement

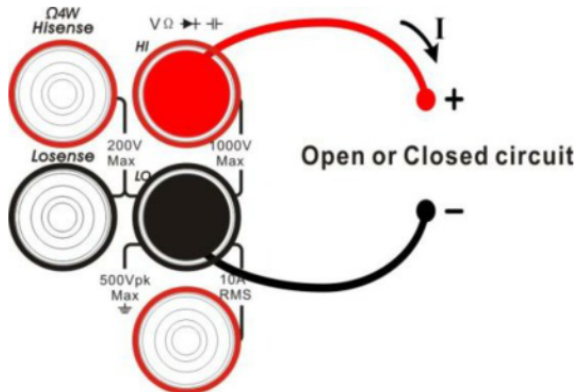

### Frequency/Period Measurement

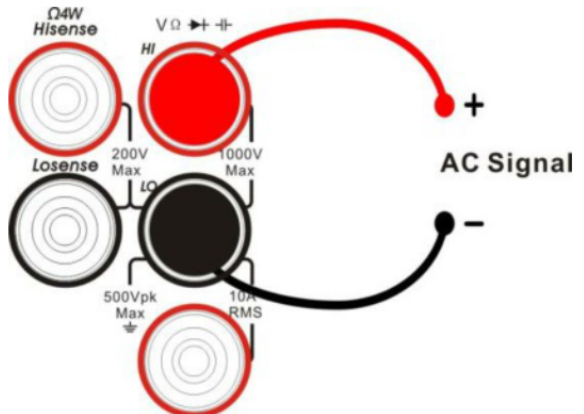

### Temperature Measurement (For RTD and thermocouple sensors)

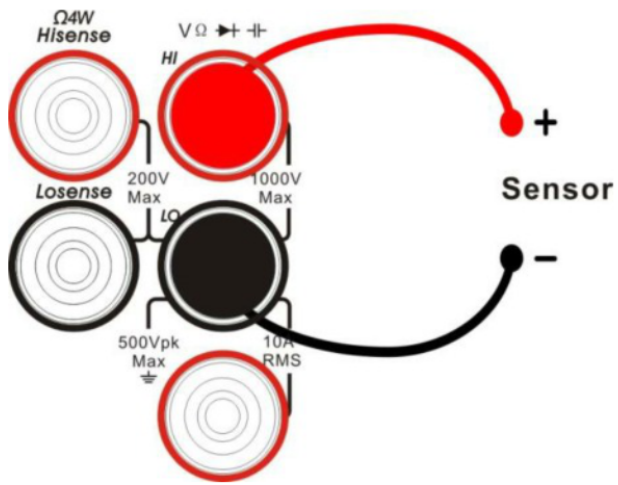

### Diode Measurement

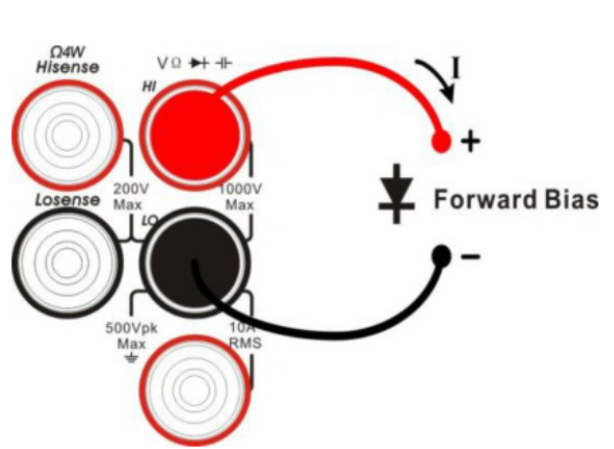

## Connecting to USB and LAN Ports

The DAQ has LAN and USB I/O ports. Connect to the ports as in the diagrams below:

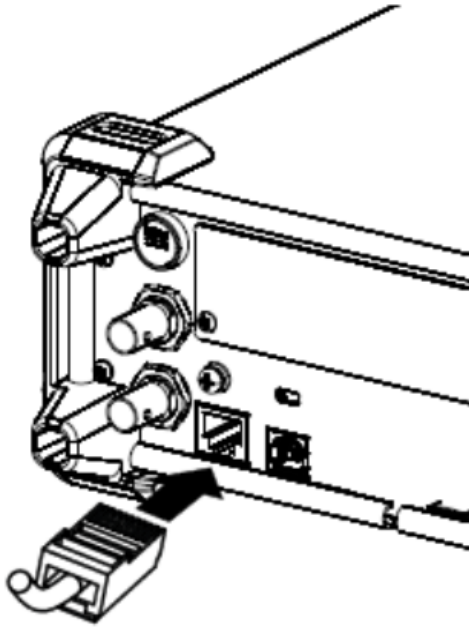

**Connect to LAN**

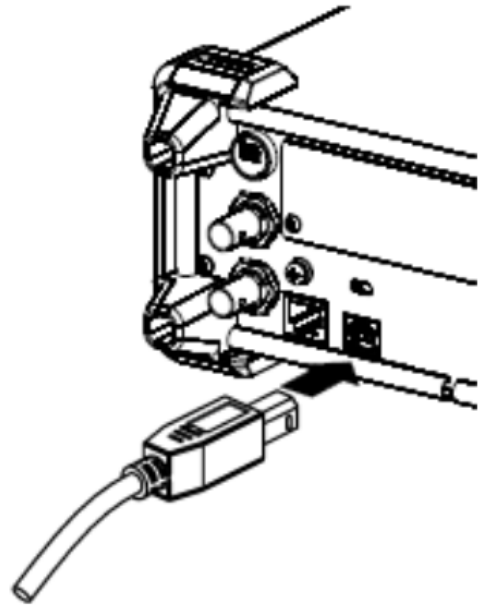

**Connect to USB Device Port**

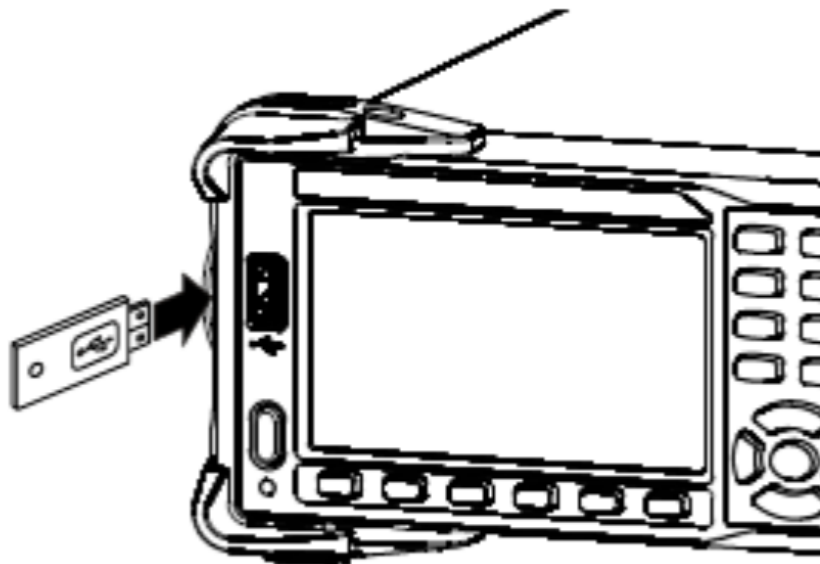

**Connect to USB Host Port**

## Using the Built-in Help System

To access the built-in help system, press **[Shift] + [Acquire]**, then use the direction keys to choose the help item you want. Finally, press **[ OK ]** to obtain help. The help listings are as follows:

1. Basic Measurements
2. Measuring Temperature
3. Measuring Capacitance
4. Math Function
5. Dual-display Function
6. Saving and Recalling Information
7. Optional Multiple Scan Card
8. The convention and Tips for Softkey

## Chapter 2

# Function and Operation

### Measurement Configuration

Most measurement parameters are user-defined. Changing a measurement parameter will change the measurement precision and speed, as well as the input impedance. An appropriate measurement parameter based on the actual application will ensure faster measurement or higher measurement precision.

The default measurement configurations of the DAQ can ensure the accuracy of the measurement results in most cases. Users can directly use these defaults for any measurement or modify the parameters of the measurement function as required.

The parameters for different measurement functions differ, see the table below

Functions	Parameters
DCV	Range, Integration Time, DC impedance, Auto zero
DCV	Range, AC filter
ACV	Range, Integration Time, Auto zero
DCI	Range, Integration Time, DC impedance, Auto zero
ACI	Range, AC filter
OHM (2WR, 4WR)	Range, Integration Time, Auto zero
CAP	Range
CONT	Short-circuit resistance
DIODE	Breakover voltage
FREQ/PERIOD	Gate time
TEMP	N/A



## Range

T3DAQ provides auto and manual range selecting modes. In auto mode, the DAQ selects a proper range automatically according to the input signal. In manual mode, you can use the front panel key or menu key to set the range. The auto mode can bring a lot of convenience for users while the manual mode provides higher reading precision.

**Method 1:** use the front panel key to set the range.

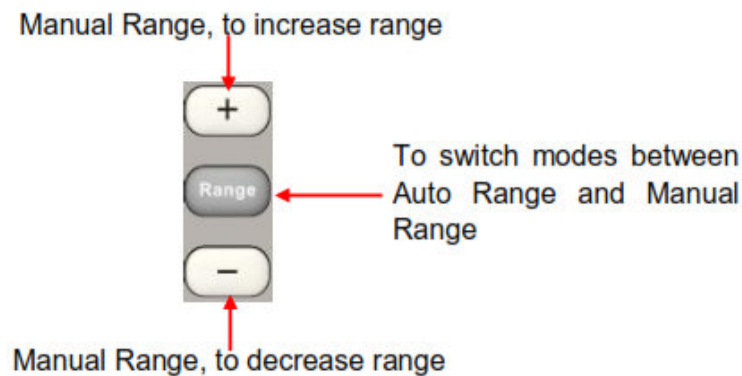

**Method 2:** Use the menu key to select the range.

Enter the specific measurement function and select [Range] in the menu to show the range setting options, as shown in the figure below, then press the menu operation key to activate the corresponding configuration.



### Note:

1. “**overload**” will be displayed when the input signal exceeds the currently set range.
2. By default, the range is set to Auto at power-on or after a reset.
3. Auto mode is recommended if you are not sure about the measurement range in order to protect the instrument and obtain accurate data.
4. The range of CONT measurement is fixed at 2k $\Omega$ .

## Integration Time and Resolution

Integration time is the period during which the DAQ's analog-to-digital (A/D) converter samples the input signal for a measurement. The longer the integration time, the slower the measurement speed will be and the higher the resolution will be. The shorter the integration time, the faster the measurement will be and the lower the resolution will be. The integration time applies to DCV, DCI, 2WR and 4WR measurements.

T3DAQ1-16 expresses the integration time by the number of power line cycles, the unit is PLC. The DAQ automatically detects the input power line frequency at power-on. If the frequency is 50Hz, the integration time can be set to 0.005PLC, 0.05PLC, 0.5PLC, 1PLC, 10PLC, 100PLC and the default is 10PLC. If the frequency is 60Hz, the Integration time can be set to 0.006PLC, 0.06PLC, 0.6PLC, 1PLC, 10PLC, 100PLC and the default is 10PLC.

T3DAQ1-16 can make measurements with reading resolutions of 4½, 5½ and 6½ digits. It automatically selects a reading resolution according to the measurement settings.

1. In DCV, DCI and OHM measurements, press [Aperture] to set the integration time, as shown in the diagram below (take DCV measurement for instance). The integration time affects the resolution.

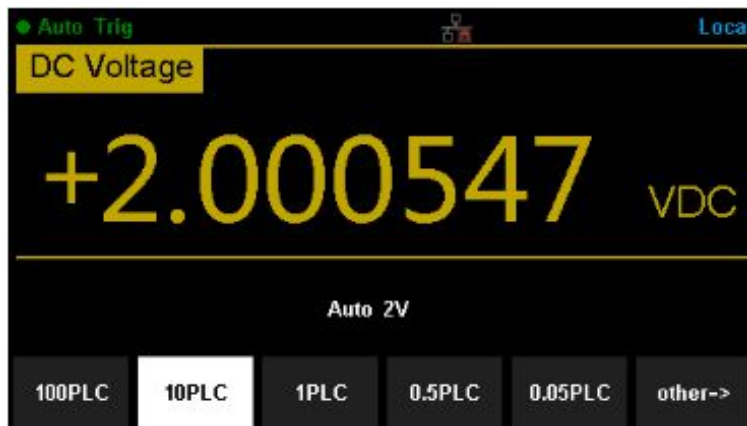

The table below shows the relationship between reading resolution and integration time.

Resolution	Integration time
4½	0.005PLC/0.006PLC 0.05PLC/0.06PLC
5½	0.5PLC/0.6PLC
6½	1PLC 10PLC 100PLC

2. In ACV, ACI ,FREQ/PERIOD measurements, the resolution is fixed at 6½ digits.
3. In CAP measurements, the resolution is fixed at 4½.
4. The instrument always displays 2 digits after the decimal point in CONT measurement.
5. In DIODE measurements, the resolution is fixed at 5½.
6. In TEMP measurements, the resolution is fixed at 5½.

## DC Impedance

DC impedance applies to DCV measurements. The default is “10M $\Omega$ ”. In the range of 200mV, 2V or 20V, you can choose “>10G $\Omega$ ” to reduce the loading error on the measured object, caused by the multimeter load.

In the range of 200 mV, 2 V or 20 V under DCV measurement, press [Input Z] in the menu to perform the setting, as shown in the diagram below.



- **10M $\Omega$** : set the input impedance in all ranges to 10M $\Omega$ .
- **10G $\Omega$** : set the input impedances in ranges of 200mV, 2V and 20V to 10G $\Omega$ , while in ranges 200V and 1000V, the impedance is still 10M $\Omega$ .

## Auto Zero

Auto zero (Auto Zero) applies to DCV, DCI, 2WR and 4WR measurements. Enter the specific measurement function and press [Auto Zero] in the menu to perform the setting, as shown in diagram below (take DCV measurement for instance).



- **ON:** the DAQ internally disconnects the input signal and measured circuit after each measurement and takes a zero reading. It then subtracts the zero reading from the preceding reading (displaying the difference between the measurement value and zero value during the measurement), in order to reduce the impact of offset voltage from input circuit on measurement result.
- **OFF:** disable the auto zero function.

## AC Filter

AC filter applies to ACV and ACI measurements. It can optimize the low frequency accuracy and minimize the AC settling time. T3DAQ1-16 provides three types of AC filters (>3Hz, >20Hz, >200Hz).

The AC filter to be used is determined by the input signal frequency. You should generally select the highest frequency filter whose frequency is less than that of the signal you are measuring, because the higher frequency filters result in faster measurements. For example, when measuring a signal between 20Hz and 200Hz, use the 20Hz filter. If measurement speed is not an issue, choosing a lower frequency filter may result in quieter measurements, depending on the signal that you are measuring.

Press [Filter] in the menu of ACV or ACI measurement to show the setting options, as shown in diagram below (take ACV measurement for instance).

Then press the menu operation key to activate the corresponding configuration.

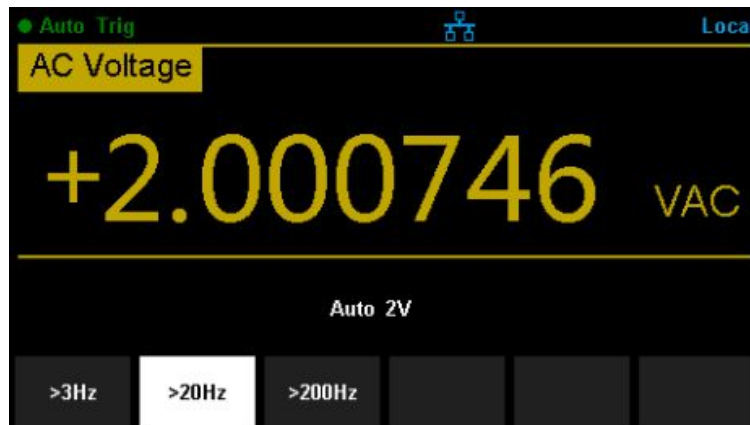

## Short-circuit Resistance

This function only applies to a continuity test. When the measured circuit has a resistance lower than the short-circuit resistance, the circuit is considered as connected and the beeper sounds (if sound is on). The default short-circuit resistance is  $50\Omega$  and the setting is stored in non-volatile memory.

When continuity test is enabled, set the [Threshold] (equal to short-circuit resistance) using the direction keys. The range is from  $1\Omega$  to  $2000\Omega$ .



## Gate Time

Gate time (also called Aperture Time) applies to the FREQ / PERIOD function. It decides the resolution of a low-frequency measurement. The longer the gate time, the higher the resolution of the low-frequency measurement and the slower the measurement, and vice versa.

In FREQ / PERIOD measurement, press [Gate Time] to show the setting options, as shown in diagram below (take FREQ measurement for instance).

The gate time can be set to 1ms, 10ms, 100ms or 1s and the default is 100 ms. You can select a desired gate time by pressing the corresponding softkey.





## Basic Measurement Functions

### To Measure DC Voltage

**Range:** 200mV, 2V, 20V, 200V, 1000V

**Max Resolution:** 100nV (in the range of 200mV)

**Input Protection:** 1000 V protection is available on all ranges and a 10% over-range for all ranges except 1000 V range. If the reading exceeds the range, “**overload**” will be displayed.

### Operating Steps:

#### 1. Enable the DCV measurement

Press **[DCV]** on the front panel to enter the DC Voltage measurement interface, as shown in Diagram below.

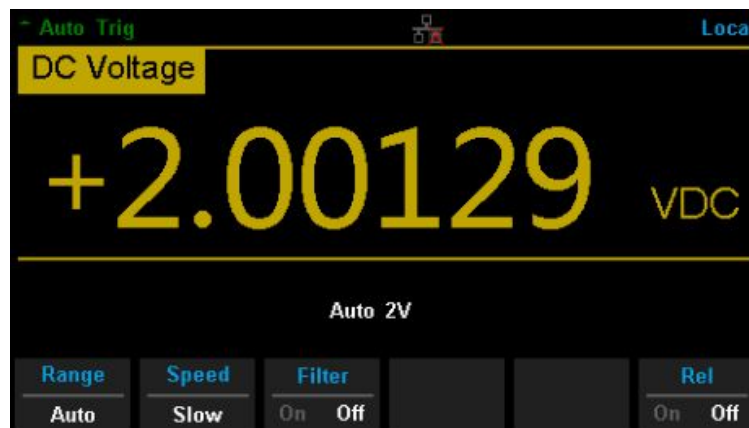

DC Voltage Measurement Interface

#### 2. Make the connection

Connect the test leads with the measured signal by referring to “**Measurement Connections**”.

#### 3. Set the range

Press **[Range]** to select a range for the measurement. You can also use the **[+]**, **[-]**, and **[Range]** keys on the front panel to select the range. Auto (autorange) automatically selects the range for the measurement based on the input. Autoranging is convenient, but it results in slower measurements than using a manual range. Autoranging goes up a range of 110% of the present range, and changes down a range when the measurement is below 10% of the present range.

**4. Set the Integration**

Press [Aperture] and choose the number of power-line cycles (PLCs) to use for the measurement. Selecting 100PLC provides the best noise rejection and resolution, but the slowest measurements.

**5. Autozero setting**

Press [Auto Zero] to enable or disable this function. Autozero provides the most accurate measurements, but requires additional time to perform the zero measurement. With autozero enabled (On), the DAQ internally measures the offset following each measurement. It then subtracts that measurement from the preceding reading. This prevents offset voltages present on the DAQ's input circuitry from affecting the measurement accuracy.

**6. Specify the DC input impedance (Only for Manual 200mV, 2V and 20V ranges)**

Press [Input Z] to set the DC resistance as "10M" (default value) or 10G". Users can execute the DC voltage measurement directly without modifying this parameter if they wish.

**7. Set the relative value (Optional operation)**

Press [Rel] to start or stop the Relative math function. When it is started, the reading displayed is a value which comes from the result of actual measurement value minus the relative value that has been set. The default relative value is the measurement value when the function is started. (For details, please refer to "**Math Functions**" in Chapter 2).

**8. Read the measurement value**

The DAQ measures the input signal according to the current measurement settings and displays the measurement result on the screen.

**9. Perform math operations (advanced)**

You can perform math operations (Statistics, Limit, dBm, dB and REL) on every DCV measurement reading. For details, please refer to "Math Operations".

**10. Display the graph (advanced)**

You can analyze the measurement data by using the "Bar Meter", "Trend Chart" or "Histogram display". For details, please refer to "**Display Mode**".

## To Measure DC Current

**Range:** 200 $\mu$ A, 2mA, 20mA, 200mA, 2A, 10A

**Max Resolution:** 0.1nA (in the range of 200 $\mu$ A)

**Input Protection:** a 10A protection fuse is available in all ranges and a 10% over-range for all ranges except 10A range. If the reading exceeds the range, “**overload**” will be displayed.

### Operating Steps:

#### 1. Enable the DCI measurement

Press [Shift] and [DCV] on the front panel to enter the DC Current measurement interface, as shown in the diagram below.

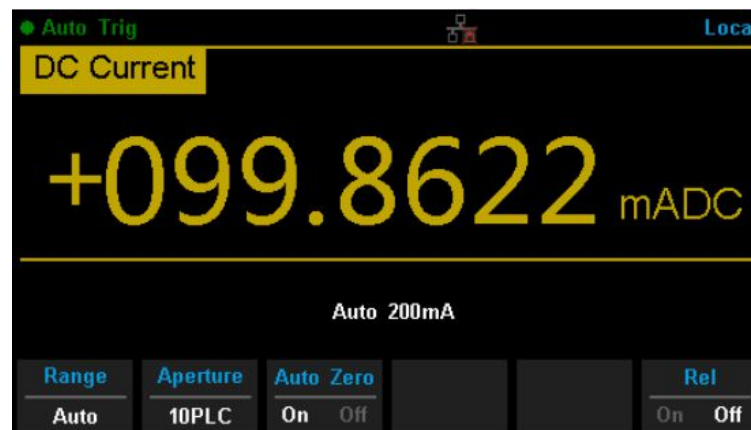

#### 2. Make the connection

Connect the test leads with the measured signal by referring to “**Measurement Connections**”.

#### 3. Set the range

Press [Range] to select a range for the measurement. You can also use the [+], [-], and [Range] keys on the front panel to select the range. Auto (autorange) automatically selects the range for the measurement based on the input. Autoranging is convenient, but it results in slower measurements than using a manual range. Autoranging goes up to 110% of a range and changes up a range at 110% of the present range, and changes down a range when below 10% of the present range.

#### 4. Set the Integration Time

Press [Aperture] and choose the number of power-line cycles (PLCs) to use for the measurement. Selecting 100PLC provides the best noise rejection and resolution, but the slowest measurements.

**5. Autozero setting**

Press [Auto Zero] to enable or disable this function. Autozero provides the most accurate measurements but requires additional time to perform the zero measurement. With autozero enabled (On), the DAQ internally measures the offset following each measurement. It then subtracts that measurement from the preceding reading. This prevents offset voltages present on the DAQ's input circuitry from affecting the measurement accuracy.

**6. Set the relative value (Optional operation)**

Press [Rel] to start or stop the Relative math function. When it is started, the reading displayed is a value which comes from the result of actual measurement value minus the relative value that has been set. The default relative value is the measurement value when the function is started. (For details, please refer to "**Math Functions**" in Chapter 2.)

**7. Read the measurement value**

The DAQ measures the input signal according to the current measurement settings and displays the measurement result on the screen.

**8. Perform math operations (advanced)**

You can perform math operations (Statistics, Limit and REL) on every DCI measurement reading. For details, please refer to "**Math Functions**".

**9. Display the graph (advanced)**

You can analyze the measurement data by using the "Bar Meter", "Trend Chart" or "Histogram display". For details, please refer to "**Display Mode**".

## To Measure AC Voltage

**Range:** 200mV, 2V, 20V, 200V, 750V

**Max Resolution:** 100nV (in the range of 200mV)

**Input Protection:** 750V protection is available in all ranges and a 10% overrange for all ranges except 750V range. If the reading exceeds the range, “**overload**” will be displayed.

### Operating Steps:

#### 1. Enable the ACV measurement

Press [ACV] on the front panel to enter the AC Voltage measurement interface, as shown in the diagram below.

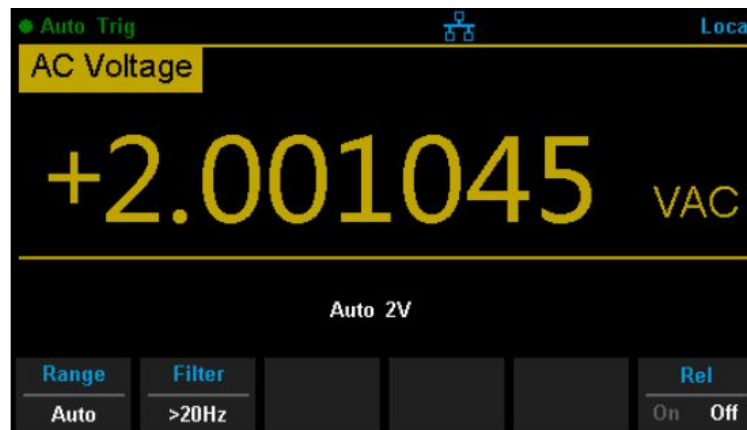

#### 2. Make the connection

Connect the test leads with the measured signal by referring to “**Measurement Connections**”.

#### 3. Set the range

Press [Range] to select a range for the measurement. You can also use the [+], [-], and [Range] keys on the front panel to select the range. Auto (autorange) automatically selects the range for the measurement based on the input. Autoranging is convenient, but it results in slower measurements than using a manual range. Autoranging goes up a range at 110% of the present range, and down a range when below 10% of the present range.

#### 4. Set the filter

Press [Filter] and choose the filter for the measurement. The instrument provides three different AC filters, “>3Hz”, “>20Hz” and “>200Hz”. You should generally select the highest frequency filter whose frequency is less than that of the signal you are measuring.

**5. Set the relative value (Optional operation)**

Press [Rel] to start or stop the Relative math function. When it is started, the reading displayed is a value which comes from the result of actual measurement value minus the relative value that has been set. The default relative value is the measurement value when the function is started. (For details, please refer to “Math Functions” in Chapter 2.)

**6. Read the measurement value**

The DAQ measures the input signal according to the current measurement settings and displays the measurement result on the screen.

**7. Perform the math operation (advanced)**

You can perform math operations (Statistics, Limit, dBm, dB and REL) on every ACV measurement reading. For details, please refer to “**Math Operations**”.

**8. Display the graph (advanced)**

You can analyze the measurement data by using the “Bar Meter”, “Trend Chart” or “Histogram display”. For details, please refer to “**Display Mode**”.

## To Measure AC Current

**Range:** 200 $\mu$ A, 2 mA, 20 mA, 200 mA, 2A, 10A

**Max Resolution:** 0.1nA (in the range of 200 $\mu$ A)

**Input Protection:** 10A protection is available in all ranges and a 10% over-range for all ranges except the 10A range. If the reading exceeds the range, “**overload**” will be displayed.

### Operating Steps:

#### 1. Enable the ACI measurement

Press [Shift] and [ACV] on the front panel to enter the AC current measurement interface, as shown in the diagram below.



#### 2. Make the connection

Connect the test leads with the measured signal by referring to “**Measurement Connections**”.

#### 3. Set the range

Press [Range] to select a range for the measurement. You can also use the [+], [-], and [Range] keys on the front panel to select the range. Auto (autorange) automatically selects the range for the measurement based on the input. Autoranging is convenient, but it results in slower measurements than using a manual range. Autoranging goes up a range at 110% of the present range, and down a range when below 10% of the present range.

#### 4. Set the filter

Press [Filter] and choose the filter for the measurement. The instrument provides three different AC filters, “>3Hz”, “>20Hz” and “>200Hz”. You should generally select the highest frequency filter whose frequency is less than that of the signal you are measuring.

**5. Set the relative value (Optional operation)**

Press [Rel] to start or stop the Relative math function. When it is started, the reading displayed is a value which comes from the result of actual measurement value minus the relative value that has been set. The default relative value is the measurement value when the function is started. (For details, please refer to “**Math Functions**” in Chapter 2.)

**6. Read the measurement value**

The DAQ measures the input signal according to the current measurement settings and displays the measurement result on the screen.

**7. Perform the math operation (advanced)**

You can perform the math operations (Statistics, Limit and REL) on every ACI measurement reading. For details, please refer to “**Math Functions**” in Chapter 2.

**8. Display the graph (advanced)**

You can analyze the measurement data by using the “Bar Meter”, “Trend Chart” or “Histogram display”. For details, please refer to “**Display Mode**”.



## To Measure Resistance

**Range:** 200 $\Omega$ , 2k $\Omega$ , 20k $\Omega$ , 200k $\Omega$ , 1M $\Omega$ , 10M $\Omega$ , 100M $\Omega$

**Max Resolution:** 100 $\mu\Omega$  (in the 200 $\Omega$  range)

**Input Protection:** 1000 V protection is available in all ranges and a 10% over-range for all ranges. If the reading exceeds the range, “**overload**” will be displayed.

T3DAQ1-16 provides 2-wire and 4-wire resistance measurements. When the measured resistance is lower than 100k $\Omega$ , the 4-wire resistance measurement is recommended to reduce the measurement error caused by the test lead resistance and contact resistance between the probe and the testing point. These two resistances should not be ignored when compared to the measured resistance.

### Operating Steps:

#### 1. Enable 2-wire/4-wire resistance measurement

Press [ $\Omega$ 2W] on the front panel to enter the 2-wire resistance measurement interface, as shown in the below diagram.

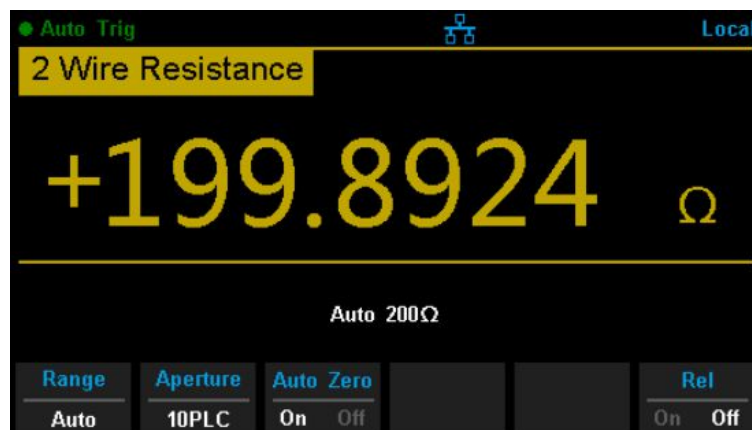

Press [Shift] and [ $\Omega$ 2W] on the front panel to enter the 4-wire resistance measurement interface, as shown in the diagram below.

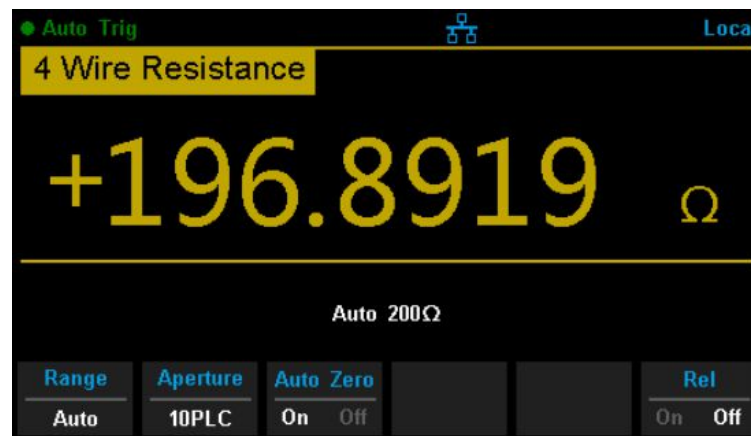

## 2. Make the connection

Connect the test leads with the measured signal by referring to “**Measurement Connections**”.

## 3. Set the range

Press [Range] to select a range for the measurement. You can also use the [+], [-], [Range] and keys on the front panel to select the range. Auto (autorange) automatically selects the range for the measurement based on the input. Autoranging is convenient, but it results in slower measurements than using a manual range. Autoranging goes up a range at 110% of the present range, and down a range when below 10% of the present range.

## 4. Set the Integration

Press [Aperture] and choose the number of power-line cycles (PLCs) to use for the measurement. Selecting 100PLC provides the best noise rejection and resolution, but the slowest measurements.

## 5. Autozero setting

Press [Auto Zero] to enable or disable this function. Autozero provides the most accurate measurements, but requires additional time to perform the zero measurement. With autozero enabled (On), the DAQ internally measures the offset following each measurement. It then subtracts that measurement from the preceding reading. This prevents offset voltages present on the DAQ’s input circuitry from affecting the measurement accuracy.

## 6. Set the relative value (Optional operation)

Press [Rel] to start or stop the Relative math function. When it is started, the reading displayed is a value which comes from the result of actual measurement value minus the relative value that has been set. The default relative value is the measurement value when the function is started. (For details, please refer to “**Math Functions**” in Chapter 2.)

**7. Read the measurement value**

The DAQ measures the input signal according to the current measurement settings and displays the measurement result on the screen.

**8. Perform the math operation (advanced)**

You can perform the math operations (Statistics, Limit and REL) on every resistance measurement reading. For details, please refer to “**Math Operations**” in Chapter 2.

**9. Display the graph (advanced)**

You can analyze the measurement data by using the “Bar Meter”, “Trend Chart” or “Histogram display”. For details, please refer to “**Display Mode**”.

## To Measure Capacitance

**Range:** 2nF, 20nF, 200nF, 2 $\mu$ F, 20 $\mu$ F, 200 $\mu$ F, 2mF, 20mF, 100mF

**Max Resolution:** 1pF (in the range of 2nF)

**Input Protection:** 1000V protection is available in all ranges. If the reading exceeds the range, “**overload**” will be displayed.

### Operating Steps:

#### 1. Enable the Capacitance measurement

Press [←|→] on the front panel to enter the Capacitance measurement interface, as shown in the diagram below.

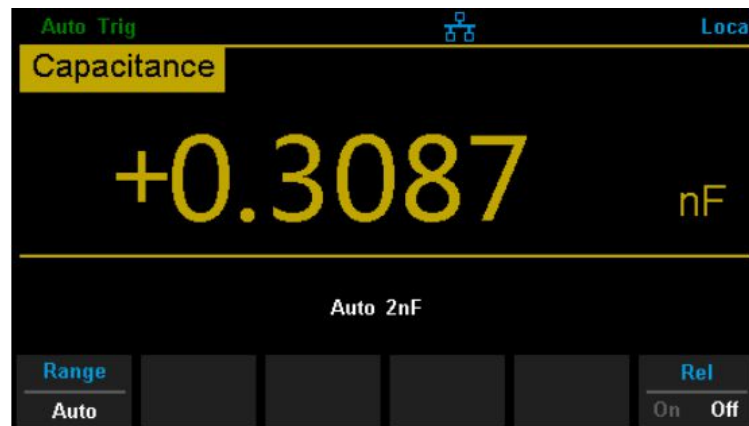

#### 2. Make the connection

Connect the test leads with the measured signal by referring to “**Measurement Connections**”.

#### 3. Set the range

Press [Range] to select a range for the measurement. You can also use the [+], [-], [Range] and keys on the front panel to select the range. Auto (autorange) automatically selects the range for the measurement based on the input. Autoranging is convenient, but it results in slower measurements than using a manual range. Autoranging goes up a range at 110% of the present range, and down a range when below 10% of the present range.

#### 4. Set the relative value (Optional operation)

Press [Rel] to start or stop the Relative math function. When it is started, the reading displayed is a value which comes from the result of actual measurement value minus the relative value that has been set. The default relative value is the measurement value when the function is started. (For details, please refer to “**Math Functions**” in Chapter 2.)

**5. Read the measurement value**

The DAQ measures the input signal according to the current measurement settings and displays the measurement result on the screen.

**6. Perform the math operation (advanced)**

You can perform the math operations (Statistics, Limit and REL) on every capacitance measurement reading. For details, please refer to “**Math Functions**”.

**7. Display the graph (advanced)**

You can analyze the measurement data by using the “Bar Meter”, “Trend Chart” or “Histogram display”. For details, please refer to “**Display Mode**”.

Remember to disconnect power to the DUT and short the legs or connections of the electrolytic capacitors before measuring the electrolytic capacitors.

## To Measure Frequency or Period

**Frequency (Period) Range:** From 3Hz to 1MHz (from 0.33s to 1 $\mu$ s).  
**Input Signal Range:** 200mV, 2V, 20V, 200V, 750V.  
**Input Protection:** 750V protection is available in all ranges.

### Operating Steps:

#### 1. Enable the Freq/Period measurement

Press [Shift] and [←|→] on the front panel, then select [Freq] to enter the frequency measurement interface, as shown in the diagram below.

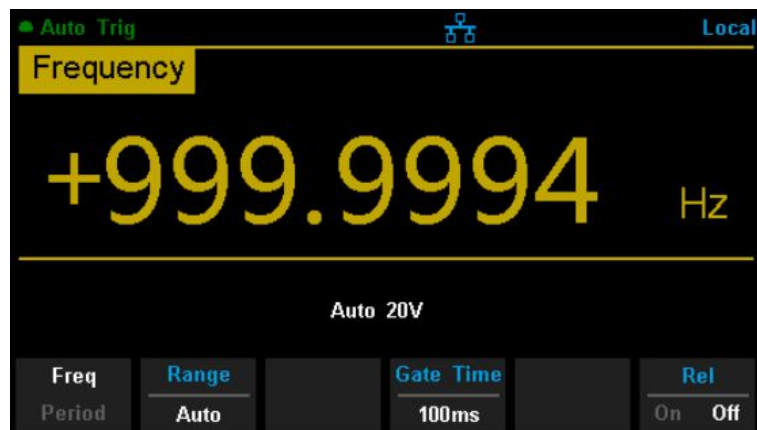

Select [Period] to enter the period measurement interface, as shown in the diagram below.

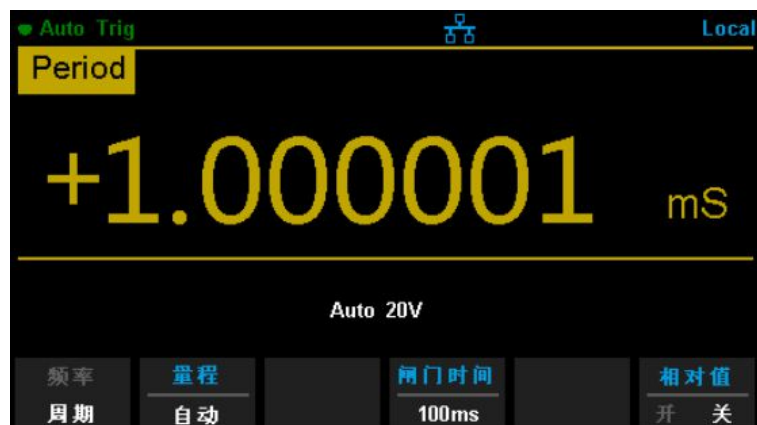

#### 2. Make the connection

Connect the test leads with the measured signal by referring to “**Measurement Connections**”.

**3. Set the range**

Press [Range] to select a range for the measurement. You can also use the [+], [-], [Range] and keys on the front panel to select the range. Auto (autorange) automatically selects the range for the measurement based on the input. Autoranging is convenient, but it results in slower measurements than using a manual range. Autoranging goes up a range at 110% of the present range, and down a range when below 10% of the present range.

**4. Set the gate time**

Press [Gate Time] and choose the measurement aperture of 1ms, 10ms, 100ms (default), or 1s.

**5. Set the relative value (Optional operation)**

Press [Rel] to start or stop the Relative math function. When it is started, the reading displayed is a value which comes from the result of actual measurement value minus the relative value that has been set. The default relative value is the measurement value when the function is started. (For details, please refer to “**Math Functions**” in Chapter 2.)

**6. Read the measurement value**

The DAQ measures the input signal according to the current measurement settings and displays the measurement result on the screen.

**7. Perform the math operation (advanced)**

You can perform math operations (Statistics, Limit and REL) on every measurement reading. For details, please refer to “**Math Functions**”.

**8. Display the graph (advanced)**

You can analyze the measurement data by using the “Bar Meter”, “Trend Chart” or “Histogram display”. For details, please refer to “Display Mode”.

## To Test Continuity

**Test Current Source:** 1mA  
**Max Resolution:** 0.01 $\Omega$   
**Input Protection:** 1000V Input Protection  
**Open-circuit Voltage:** <8V  
**Beep Threshold (short-circuit resistance):** from 0 $\Omega$  to 2000 $\Omega$

This function measures the resistance of the circuit with about 1mA current source. When the measured resistance is lower than the short-circuit resistance (Threshold), the beeper sounds (if the Beeper is on). Otherwise, “open” is displayed on the screen.

### Operating Steps:

#### 1. Enable the Cont measurement

Press [Cont] on the front panel to enter the Continuity test interface, as shown in the diagram below.



#### 2. Make the connection

Connect the test leads with the measured signal by referring to “**Measurement Connections**”.

#### 3. Set the short-circuit resistance (Threshold)

Enter a desired value using the direction keys. The range is from 0 $\Omega$  to 2000 $\Omega$  and the default is 50 $\Omega$ .

#### 4. Read the measurement value

The DAQ measures the input signal according to the current measurement settings and displays the measurement result on the screen.



**5. Perform the math operation (advanced)**

You can perform math the operation (Statistics, Limit) on every measurement reading. For details, please refer to **“Math Functions”**.

**6. Display the graph (advanced)**

You can analyze the measurement data by using the “Bar Meter”, “Trend Chart” or “Histogram display”. For details, please refer to **“Display Mode”**.

Before testing continuity remember to disconnect the DUT power and discharge all of the DUT capacitors, to avoid damage to the DAQ.

## To Test Diode

**Test Current Source:** 1mA  
**Voltage Measurement Range:** 0V 4V  
**Max Resolution:** 10 $\mu$ V  
**Input Protection:** 1000V Input Protection  
**Open-circuit Voltage:** <8V

This function measures the forward voltage drop on the diode. When the voltage is lower than the Threshold, the beeper sounds (if the beeper is on).

### Operating Steps:

#### 1. Enable the Diode measurement

Press [Shift] and [Cont] on the front panel to enter the Diode test interface, as shown in the diagram below.

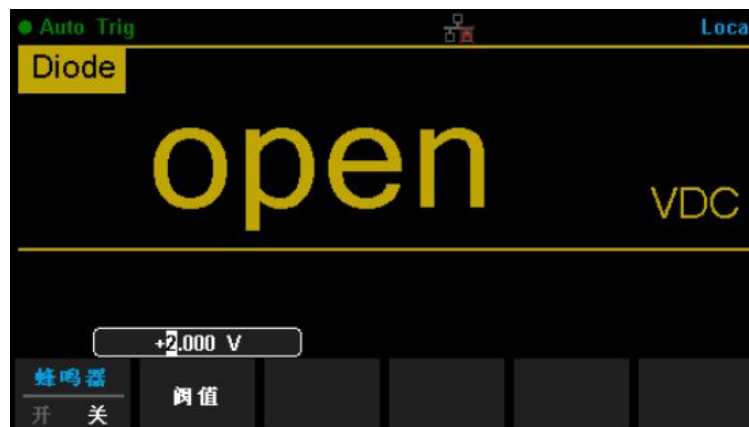

#### 2. Make the connection

Connect the test leads with the measured signal by referring to “**Measurement Connections**”.

#### 3. Set the Threshold

Enter a desired value using the direction keys. The range is from 0V to 4V and the default is 2V.

#### 4. Read the measurement value

The DAQ measures the input signal according to the current measurement settings and displays the measurement result on the screen. If the reading exceeds the threshold, “open” will be displayed.

**5. Evaluate the results of a measurement**

Reverse the probes and measure the forward voltage drop on the diode again. Evaluate the diode according to the following rules:

- If the DAQ displays “open” when in the reverse bias model, it indicates that the diode is normal.
- If the DAQ shows voltage about 0V and the instrument beeps persistently when in forward and reverse bias model, it indicates that the diode is short
- If the DAQ shows “open” when in the forward and reverse model, it indicates that the diode is open.

**6. Perform the math operation (advanced)**

You can perform the math operation (Statistics, Limit) on every measurement reading. For details, please refer to “**Math Functions**”.

**7. Display the graph (advanced)**

You can analyze the measurement data by using the “Bar Meter”, “Trend Chart” or “Histogram display”. For details, please refer to “**Display Mode**”.

Before testing continuity remember to disconnect the DUT power and discharge all of the DUT capacitors, to avoid damage to the DAQ.

## To Measure Temperature

T3DAQ1-16 can directly measure the temperature using TC (Thermocouple) and THERM (Thermistor) sensors.

### Operating Steps:

**1. Enable the Diode measurement**

Press on the front panel to enter the Temperature measurement interface, as shown in the diagram below.

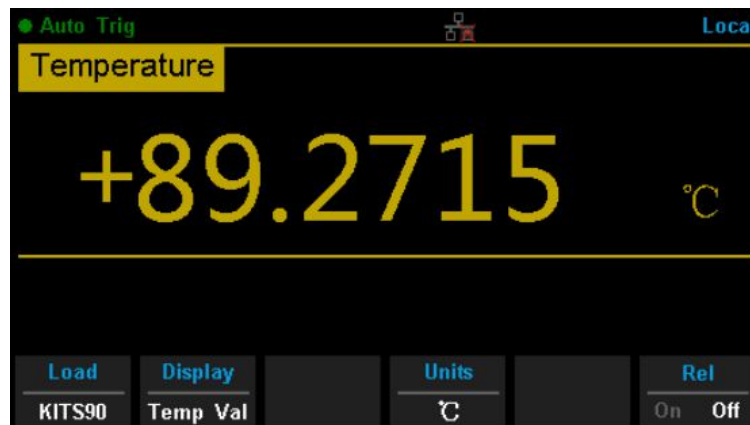

**2. Make the connection**

Connect the test leads with the measured signal by referring to “Measurement Connections”.

**3. Set the type of sensor**

Press [Load] and use the direction keys to choose a desired temperature sensor. Press [Define] to view the configurations. Then press [Read] to apply the current temperature sensor configurations.

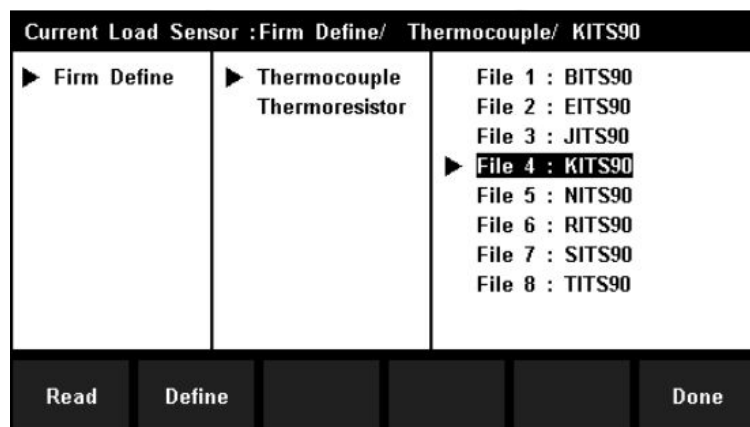

#### 4. Set the display mode

Press [Display] to choose the display mode. The DAQ supports three display modes: Temperature Value, Measured Value and All (Temperature Value and Measured Value will be shown on the display together).

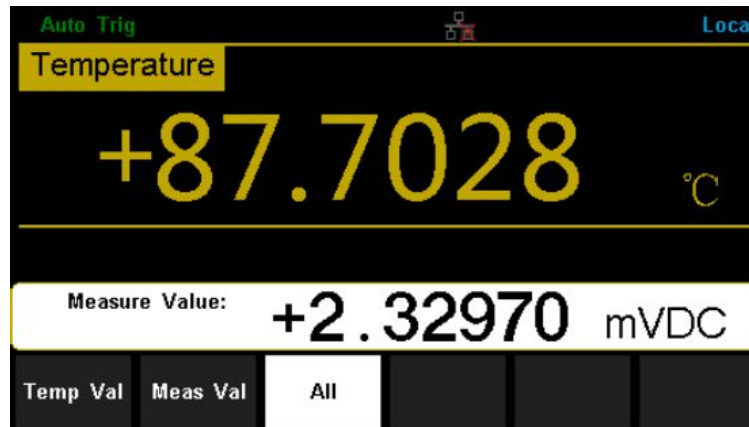

#### 5. Set the unit of temperature

Press [Units] to choose the unit of temperature. The DAQ supports three units: °C, °F, °K.

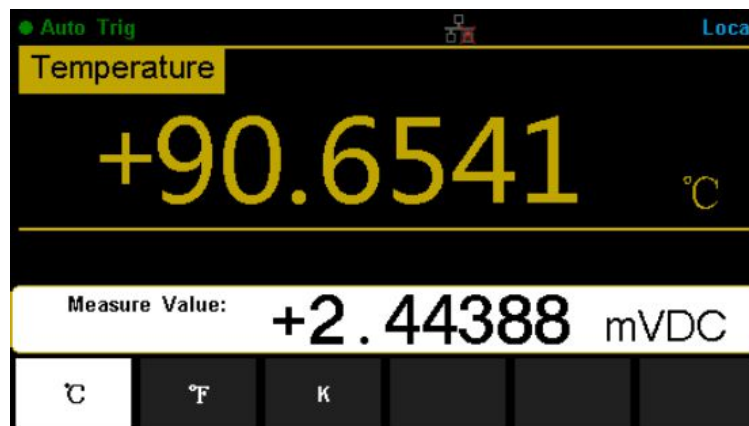

#### 6. Set the relative value (Optional operation)

Press [Rel] to start or stop the Relative math function. When it is started, the reading displayed is a value which comes from the result of actual measurement value minus the relative value that has been set. The default relative value is the measurement value when the function is started. (For details, please refer to “**Math Functions**” in Chapter 2.)

#### 7. Read the measurement value

The DAQ measures the input signal according to the current measurement settings and displays the measurement result on the screen.

**8. Perform the math operation (advanced)**

You can perform the math operation (Statistics, Limit and REL) on every measurement reading. For details, please refer to “**Math Functions**”.

**9. Display the graph (advanced)**

You can analyze the measurement data by using the “Bar Meter”, “Trend Chart” or “Histogram display”. For details, please refer to “**Display Mode**”.

## Dual-display Function

Dual-display function is used to improve the test and measurement functions. Press [Dual] to open the Dual-display function and the upper right corner will show “Dual”. Now press a function key if this function can be used as the second display, it will be displayed in the second Display area. The Main Display will display the function that is selected before the Dual-display function is turned on. All the available combinations are listed in the table below (shade is available).

		Main Display Function								
		DCV	DCI	ACV	ACI	FREQ	PERIOD	2-Wire R	4-Wire R	Cap
Vice Display Function	DCV									
	DCI									
	ACV									
	ACI									
	FREQ									
	PERIOD									
	2-Wire R									
	4-Wire R									
	Cap									

For example, press [DCV]→ [Dual]→ [ACV] to enter the following interface.

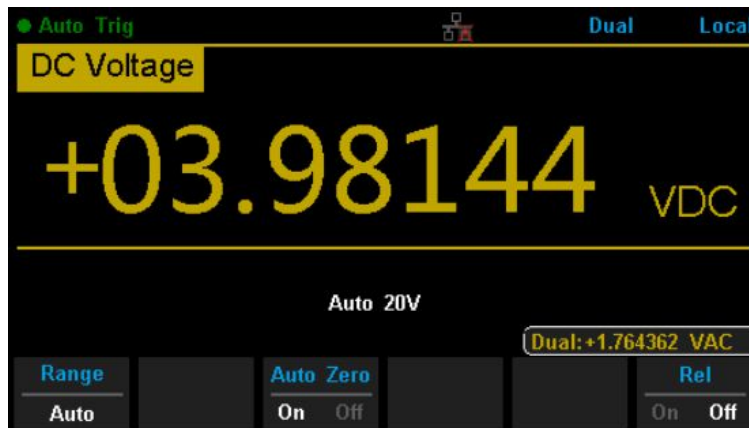

### Instruction:

- If the same measurement function is used in both Main and second Display.
  - The readings in both displays will update at the same time.
  - If math function (dBm, dB) is used in Main Display, when opening the second Display, the math operation will be stopped automatically. The second Display will show the same measurement result as Main Display.
  - If math function (Statistics, Limits, Relative) is used in Main Display, when starting the second Display, the result will still be shown in the Main Display, and the second Display will show the same measurement result as the Main Display.
- If different measurement functions are used in both Main and the second Display.

- The readings in both displays will update alternately.
  - If math function (dBm, dB) is used in Main Display, when opening the second Display, the math operation will be stopped automatically. The second Display will show the second selected function normally.
  - If math function (Statistics, Limits, Relative) is used in Main Display, when opening the second Display, the result will still be shown in the Main Display and the second Display will show the second selected function normally.
3. If Temperature function is used in Main Display, set the display mode ( [Temp]→[Display]→[All]). Then the result will be shown in the Main Display and the current measurement value is shown in the second Display.
  4. Auto Range is adopted by the second Display. If the same measurement function is used in both displays, so does the range.
  5. Measured data in the second Display cannot be saved into "History".



## Utility Function

The Utility function enables users to set up system parameters and interface parameters of the DAQ.

Press [Shift] and [Dual] to enter the operating menu of Utility function, as the following diagram shows.

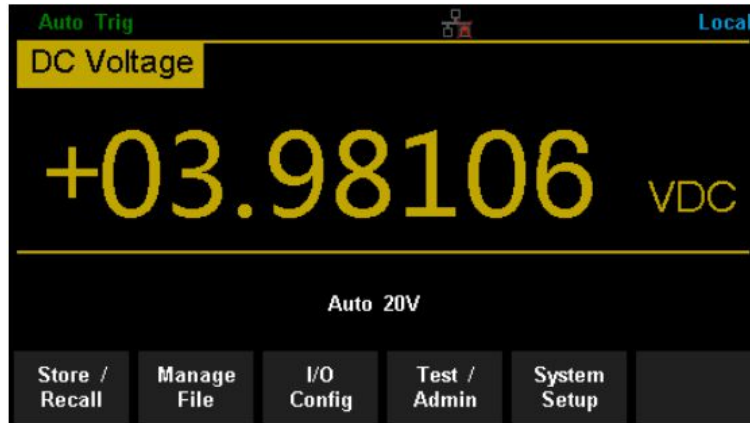

Function Menu	Description
Store/Recall	Store or recall state files.
Manage File	Create a new file, copy, rename or delete a file.
I/O Config	Configure LAN.
Test/Admin	Provide board test function.
System Setup	Configure instrument's user settings.

## Store and Recall

The Store/Recall function enables users to store and recall the instrument state and data files in the local storage as well as in the USB storage. After entering the function menu of Utility, press [Store/Recall] to enter the interface as shown in the diagram below.

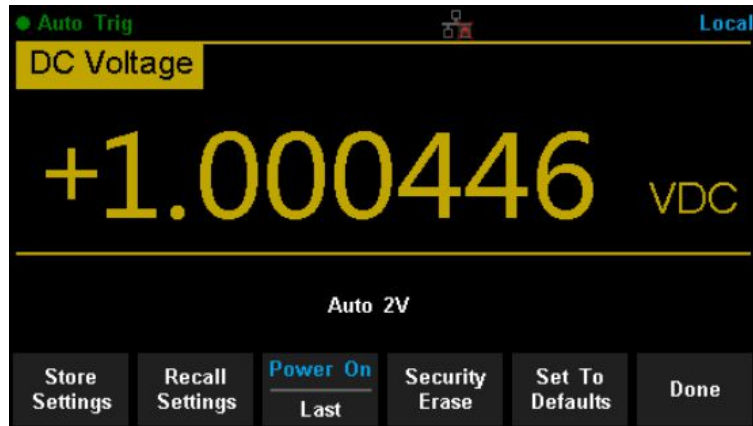

Function Menu	Description
Store Settings	Store state or data files.
Recall settings	Recall state files.
Power On	Select the state that is loaded at power-up.
Security Erase	Delete all the files stored in local storage and restore the instrument to factory default state.
Set to Defaults	Restore the instrument to factory default state.
Done	Return to the higher level menu.

## Store Settings

Store settings allows you to save the system configuration (as **.xml**) or measurement data (as **.csv**) into the internal memory or an external USB storage device. After entering into the function menu of Store/Recall, press [Store Settings] to enter the following interface.

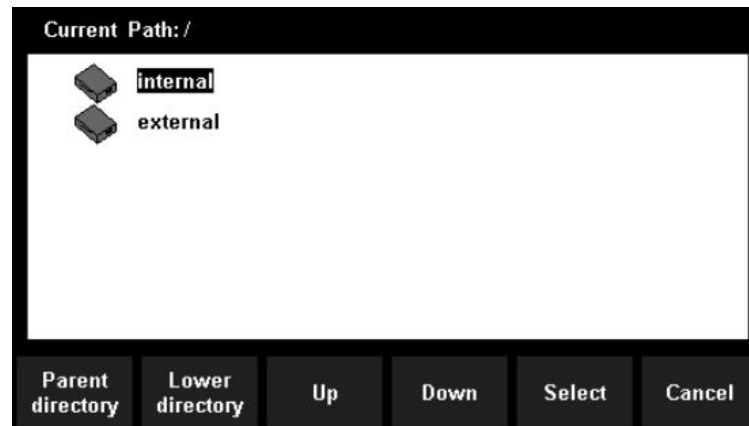

Table below shows the different functions available.

Function Menu	Settings	Description
Browse		Choose the location that file will be saved.
File Name		Input the file name.
Type	.xml/.csv	Choose the type of file that will be saved.
Store Data		Store the specified file.
Done		Return to the higher level menu.

**Operating Steps:****1. Set the storage directory**

Press [Browse] to enter the following interface, then use the direction keys or menu operation keys to choose the storage directory. Press [Select] to set the current directory as storage location and Return to the higher level menu.

**2. Set the file name**

Press [File Name] to enter the following interface and input the name of the stored file.

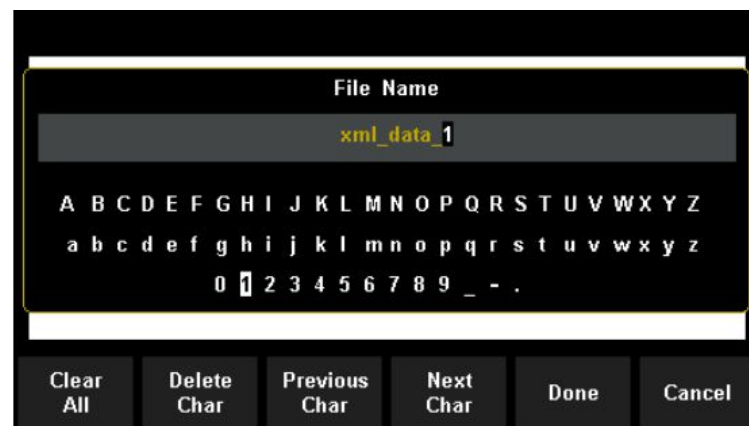

The method of inputting a file name:

- Press direction keys to select a desired character in the input area.
- Press "OK" key on the front panel to input selected char in the input area.
- Press [Clear All] to clear all input chars.
- Press [Delete Char] to delete the letter on which the cursor is currently placed.
- Press [Previous Char] to move the cursor in the file name area to the previous char.
- Press [Next Char] to move the cursor in the file name area to the next char.
- Press [Done] to save the current file and return to the higher level menu.

- Press [Cancel] to cancel the current operation and return to the higher level menu.

**3. Set the type of stored file**

Press [Type] to set the type of stored file.

- .xml: save the current system configuration as an “.xml” file.
- .csv: save the current measurement result as a “.csv” file.

**4. Save the file**

Press [Store Data] to store the specified file.

**5. Exit**

Press [Done] to return to the higher level menu.

## Recall Settings

Recall settings allows you to read the system configuration from the internal memory or an external USB storage device. After entering the function menu of Store/Recall, press [Recall Settings] to enter the following interface.

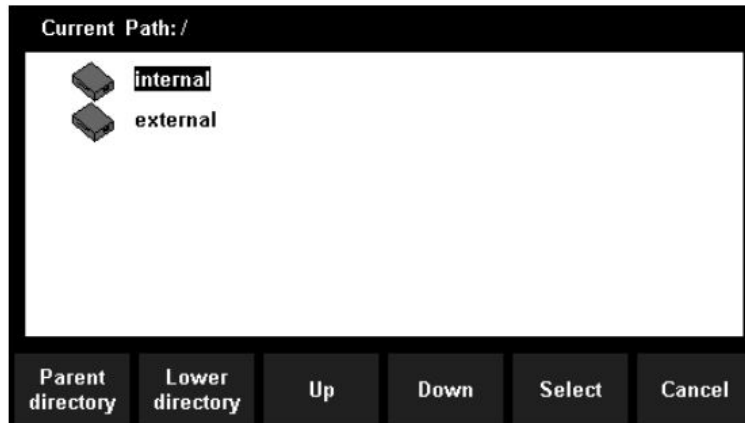

Use direction keys or menu operation keys to choose the state file with the suffix “.xml”.

- Press [Select] to read the file and restore the instrument to a specified state.
- Press [Cancel] to return to higher level menu.

## Power On

Select a system configuration to be used at power-on from “Default” and “Last” (configuration at last power-off). The setting will be available at the next power-on.

## Security Erase

Press [Security Erase], the instrument will display a prompt message “Are you sure you want to delete all stored files?”. Press [Yes] to confirm. The instrument will delete all the files stored in local storage and restore the instrument to the factory default state.

## Set to Defaults

Press [Set to Defaults] and the instrument will be restored to factory default state.

## Manage File

The **Manage Files** function allows you to create, copy, delete, and rename files and folders in the instrument's internal flash memory or on a USB drive attached to the front panel. It also allows you to capture the current screen to a bitmap (\*.bmp) file. After entering the function menu of Utility, press [Manage File] to enter the interface as shown in the diagram below.

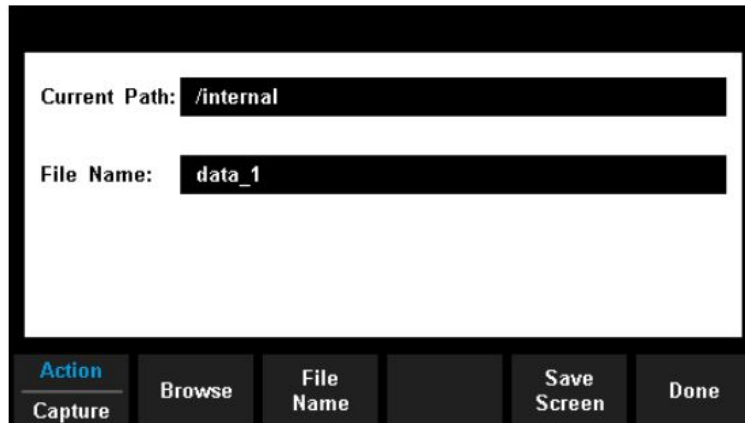

Press [Action] and select [Folder], [Capture Display], [Copy], [Rename] or [Delete] to do the corresponding operation.

- Folder – To create a folder, Browse to the internal or external location for the folder, press File Name, enter a folder name and press Done. Press Create Folder > Done.
- Capture Display – To save a screen capture, Browse to the internal or external location for the screen capture. Press File Name, enter a name and press Done. Press Save Screen > Done.
- Copy – To copy a file or folder, press Copy. Browse to the folder or file to be copied and press Select. Press Copy Path and select an internal or external path for copying. Press Perform Copy > Done.
- Rename – To rename a file or folder, press Rename. Browse to the folder or file to be renamed and press Select. Press New Name, enter a new name and press Done. Press Perform Rename > Done.
- Delete – To delete a file or folder, press Delete and Browse to the folder or file to delete. Press Select > Perform Delete > Done.

## I/O Configuration

Press [I/O Config] to enter the following interface and set up the parameters.

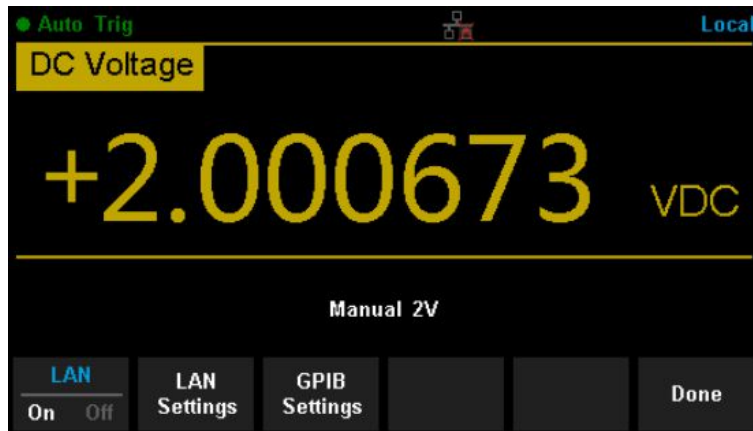

## LAN Settings

The DAQ enables users to operate the instrument remotely by LAN interface and store or recall internet settings. You can look over current LAN settings and set up an IP address and subnet mask. After entering into the function menu of Utility, press [I/O Config]. Select [On ]→[LAN Settings]→[Modify Settings] to enter the following interface.

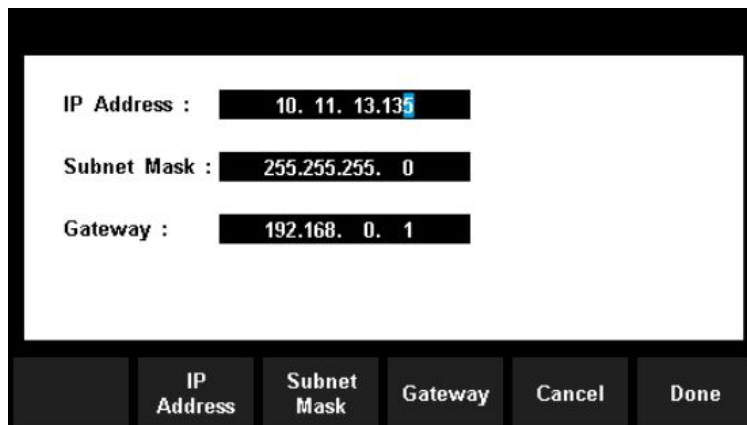

Function Menu	Description
IP Address	Set up IP address.
Subnet Mask	Set up subnet mask.
Gateway	Set up gateway.
Cancel	Cancel current operation and return to the higher level menu.
Done	Save all changes and return to the higher level menu.



## Board Test

T3DAQ1-16 provides self-test functions, including Key Test, LCDTest, Beeper Test and Chip Test.

### Operating Steps:

1. Press [Shift] and [Dual], then choose [Test/Admin]→[Board Test] to enter the following interface.

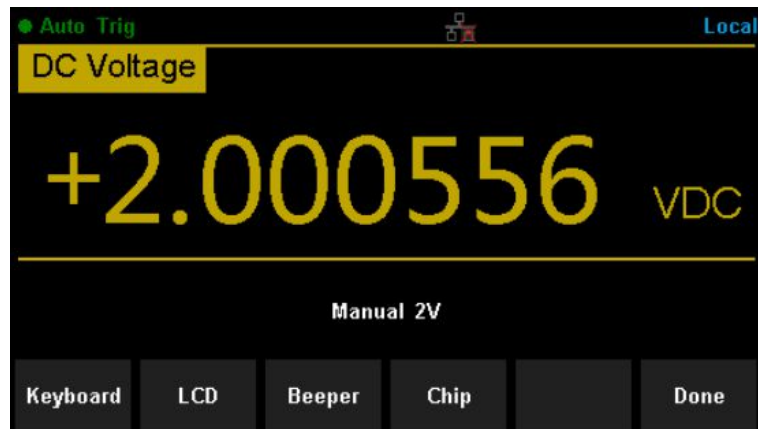

Function Menu	Description
Keyboard	Test the instrument's keys.
LCD	Test the instrument's LCD screen.
Beeper	Test the instrument's beeper.
Chip	Test the instrument's chips.
Done	Return to the higher level menu.

## 2. Test the keys (select Keyboard).

Select [Key] to enter the key test interface, as displayed in the diagram below. The on-screen rectangle shapes represent the keys on the front panel. Test all keys and knobs and you should also verify that all the back lit buttons illuminate correctly.

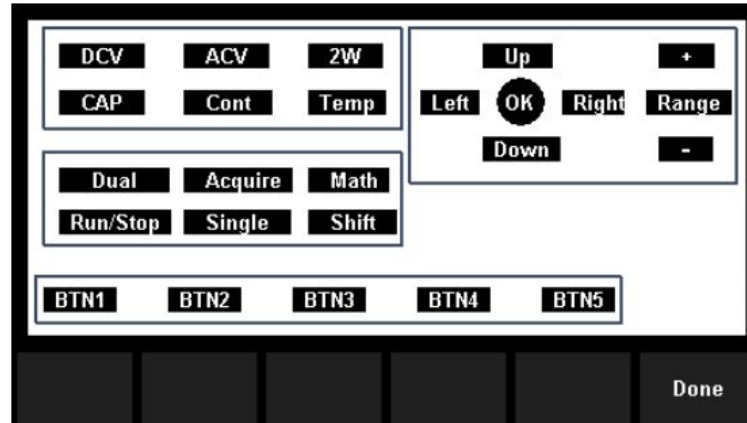

Before testing the keys the key shapes on the screen will be displayed in a blue color. The on screen keys and knobs will change to a green color when tested. Press [Done] to exit the test.

## 3. Test the LCD screen.

Select [LCD] to enter the screen test interface, the screen shows the message: "Press 'Change' to change. Press 'Done' to exit". Press [Change] to start the test and observe if the screen has changed color or other display errors as shown in the diagram below.



### NOTE:

- Press [Change] to change the color of the screen. There are three colors: red, blue and green.
- Press [Done] to exit the test.

**4. Test the beeper.**

Press [Beeper] to test the beeper. Under regular circumstances, press [Beeper] one time and the instrument will beep one time.

**5. Test the chips.**

Press [Chip]→[Start] to enter chip test interface, as shown in the diagram below.

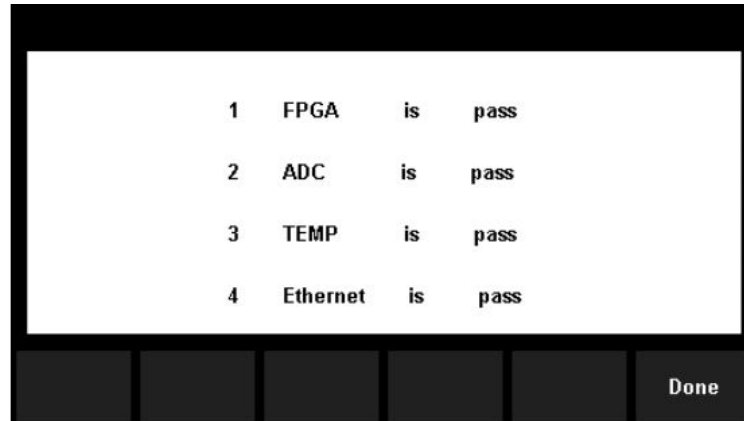

**NOTE:**

- If the test is passed, the corresponding result shows “pass”.
- If the test is failed, the corresponding result shows “fail”.

6. Press [Done] to exit the board test.

## Firmware Update

The software of the DAQ can be updated directly via a USB flash drive, updating the current software version to the desired software version.

### Operating Steps:

1. Copy the update file to the USB flash drive.
2. Insert the USB flash drive to the USB host interface on the front panel of the DAQ.
3. Press [Shift]→ [Dual]→ [System Setup]→ [Firmware Update], then press [Browse] and select the update file. Next, press [Update]→ [Yes] to start updating the system software.
4. On completion of the update, the screen will show the message: “Firmware Update Done!” Then you can remove the USB flash drive away.
5. Restart the DAQ and check the version information. Press [Shift]→ [Dual]→ [System Setup]→ [System Info] to check if the software and hardware version has updated. If not, and the update has failed, you will need to update once more following the above operating steps.
6. After checking, press [Done] to exit the system information interface.

**NOTE:**

Do not disconnect the power or turn off the instrument while the instrument is updating.

## System Setup

Press [Shift] and [Dual], then select [System Setup] to enter the following interface.

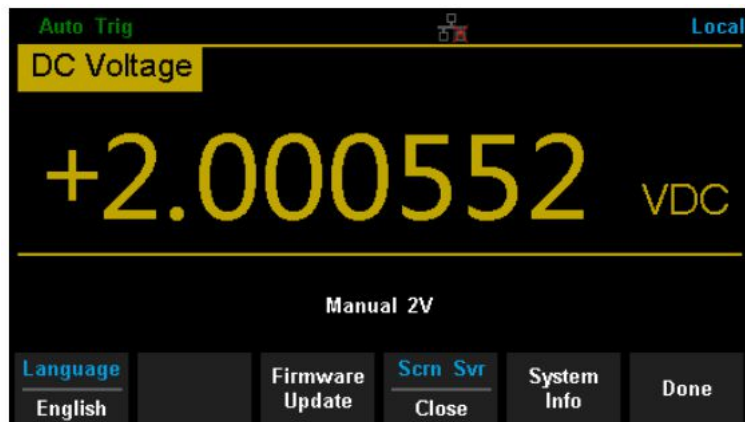

Function Menu	Description
Language	Select the display interface language.
Firmware Update	Update software version.
Screen	Setup the screen protection function.
System Info	View system information.
Done	Return to the higher level menu.

### 1. Select language.

The DAQ supports two languages, English and Chinese. Press [Language] to select the Language of the menu.

### 2. Set up the screen protection timer.

Press [Screen] to set screen protection as 1 Min, 5 Mins, 15 Mins, 30 Mins, 1 Hour, 2 Hours or 5 Hours according to different demands. Activate the screen saver program and screen saver will be on if no action is taken within the time that you have selected. Press any button to resume.

### 3. View system information.

Press [System Info] to view system information, including start-up times, software version, hardware version, production ID and serial number, as shown in the following diagram.

**System Information :**

<b>Start-up Times :</b>	<b>41</b>
<b>SW Version ID :</b>	<b>3.01.01.10T1</b>
<b>HW Version ID :</b>	<b>02-02-00-05-00</b>
<b>Production ID :</b>	<b>T3DAQ1-16</b>
<b>Serial Number :</b>	<b>T0105C19150198</b>

Done

## Acquire

Sampling is a process of acquiring and digitizing a signal. The optional Trigger methods of the DAQ include Auto Trigger, Single Trigger and External Trigger. Press [Acquire] to enter the interface shown as the following diagram:

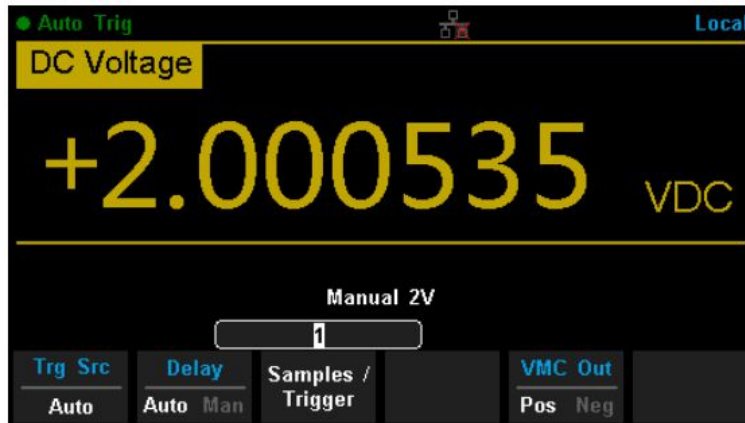

Function Menu	Description
Trg Src	Set the source of trigger.
Slope	Set the slope polarity of external trigger.
Delay	Set the delay.
Samples/Trigger	Set the number of samples per trigger.
VMC Out	Set the polarity output pulse signal when the sampling signal is finished.

## Auto Trigger

Auto Trigger parameters that need to be set up include delay, samples/trigger and VMC out.

### Operating Steps:

1. Press [Acquire], then select [Trg Src]→[Auto] or press [Run/Stop] on the front panel directly to enable Auto Trigger.
2. **Set the delay.**  
Delay is the waiting time after the trigger signal is sent out and before the acquiring starts. Press [Delay] to select Auto or Manual mode. When choosing Manual mode, the Left and Right keys are used to select the numerical digit to adjust. The Up and Down keys are used to change the selected digit value.
3. **Set the number of samples per trigger.**  
Press [Samples/Trigger] to set the sample count. Left and Right keys are used to switch the number of a numerical value, Up and Down keys are used to change the selected value.

#### Sample Count

- Sample Count indicates the number of samples taken when the DAQ receives a Single Trigger event (samples per trigger).
- The range of sampling points should be between 1 and 599999999.
- The default value of the Sample Count is 1.

4. **Set the VMC Out.**  
The DAQ outputs a pulse signal through the VM COMP interface on the rear panel after the sampling signal is finished. Press [VMC Out] to choose Positive or Negative polarity.



## Single Trigger

Single Trigger parameters that need to be set up include delay, samples/trigger and VMC out.

### Operating Steps:

1. Press [Acquire], then select [Trg Src]→ [Single] or press [Single] on the front panel directly to enable Single Trigger.
2. **Set the delay.**  
Press [Delay] to select Auto or Manual mode.
3. **Set the number of samples or trigger.**  
Press [Samples/Trigger] to set sample count.
4. **Set the VMC Out.**  
The DAQ outputs a pulse signal through the VM COMP interface on the rear panel after the sampling signal is finished.  
Press [VMC Out] to choose Positive or Negative polarity.

## External Trigger

The external trigger signal will be input via EXT TRIG interface on the rear panel. External trigger parameters that need to be set up include delay, samples/trigger, slope and VMC out.

### Operating Steps:

1. Press [Acquire], then select [Trg Src]→ [Ext] to enable the External Trigger.
2. **Set the polarity of slope.**  
Press [Slope] to choose Positive or Negative polarity.
3. **Set the delay.**  
Press [Delay] to choose Auto or Manual mode.
4. **Set the number of samples or trigger.**  
Press [Samples/Trigger] to set sample count.
5. **Set the VMC Out.**  
In External Trigger mode, the DAQ could output a pulse signal through the VM COMP interface on the rear panel after the sampling signal is finished.

## Help System

T3DAQ1-16 provides a powerful built-in help system. You can recall help information at any time while using the instrument. You also can get a functionality help for every button on the front panel or menu soft key by using the built-in help system. You may also get help about familiar operations with the help list.

Press [Shift] and [Acquire] to enter the help list, as the following diagram shows.

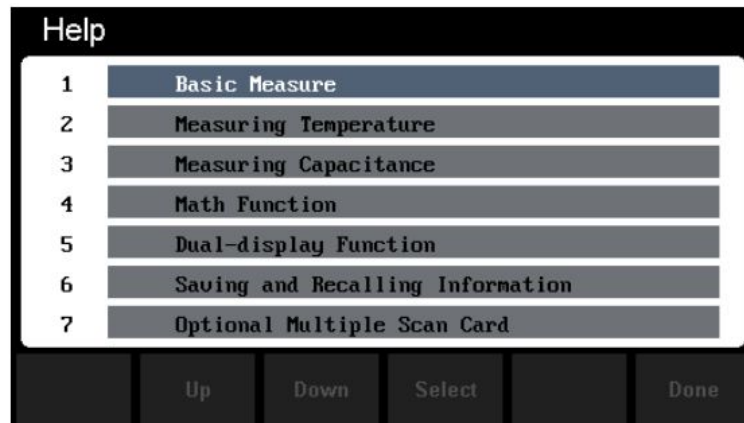

Function Menu	Description
Up	Move up the cursor and select the help menu.
Down	Move down the cursor and select the help menu.
Select	Select the help information you want to read.
Done	Return to the higher menu.

1. **Basic Measure.**  
Get basic measurement types and methods to connect the leads for different measurements.
2. **Measuring Temperature.**  
Get the method to measure temperature.
3. **Measuring Capacitance.**  
Get the method to measure capacitance.
4. **Math Function.**  
Introduction of how to use the math function while making measurements.
5. **Dual-display Function.**  
Learn the method to use the dual-display function while you are measuring.
6. **Saving and Recalling Information.**  
Introduction of how to store and recall the data/parameter/sensor files.
7. **The convention and Tips of Soft Key usage.**  
Get help and tips about using the soft keys.

## 8. Technical Support.

How to obtain technical support.

### **Explanation:**

- In the help menu interface, you can move the cursor and select the corresponding menu by the up and down direction keys and press “OK” to read the help information.
- While reading the help information, you can also look up and down the information by selecting the up and down direction keys.

## Math Functions

The DAQ provides five math functions: Statistics, Limits, dBm, dB and Relative. Choose different math functions to meet different measurement needs. Math functions can only be used in DC Voltage, AC Voltage, DC Current, AC Current, Resistance, Frequency, Period and Temperature measurement. Among these functions, dBm and dB are only used in DC Voltage and AC Voltage measurement.

Press [Math] to show the operating menu of math functions on the screen, as shown in the following diagram.

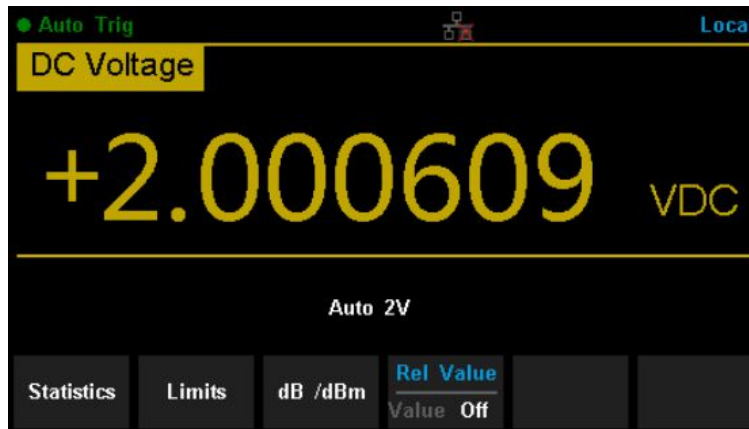

Function Menu	Settings	Description
Statistics		Reading statistic functions, including max, min, average, span, std dev and samples.
Limits		The Limits function performs Pass/Fail testing according to the specified upper and lower limits.
dBm		The dBm is based on a calculation of power delivered to a reference resistance, 0dBm = 1mW
db		The dB measurement is the difference between the input signal and a stored relative value.
Rel Value	Value/Off	Turn on the relative value function and set up the value. Or turn off the function.

**Explanation:**

- Math functions are only applicable to the main display.
- If a measurement function is changed, all math functions will be stopped except Statistics.

## Statistics

There are many kinds of reading statistic functions, including: Max, Min, Average and Standard deviation.

Press [Math]→ [Statistics]→ [Show] to enter the interface shown in the following diagram.

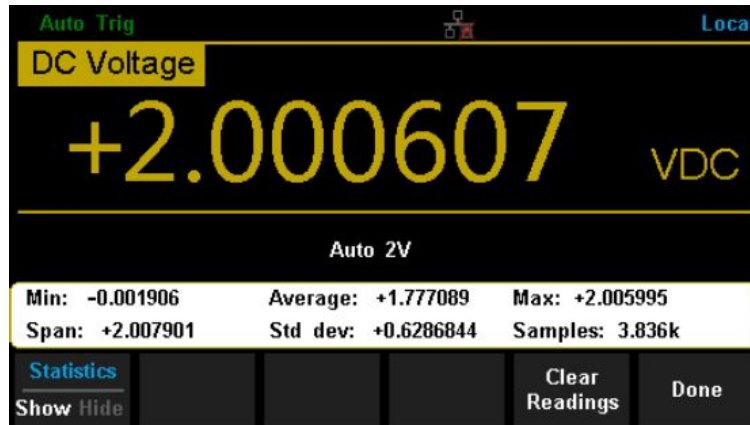

Function Menu	Settings	Description
Min		Show the minimum statistics value of current measurement.
Average		Show the average statistics value of current measurement.
Max		Show the maximum statistics value of current measurement.
Span		Show the span of current measurement.
Std dev		Show the std dev statistics value of current measurement.
Samples		Show the number of samples of current measurement.
Statistics	Show/Hide	Show or hide the statistics function interface.
Clear Readings		Clear all current readings and restart statistics.
Done		Return to the higher level menu.

### Statistics Function:

- In statistic function, the first reading is usually set to the maximum or minimum value. When acquiring more readings the current displayed value is always the maximum/minimum reading among all the measured values.
- The maximum, minimum, average and reading quantities are stored in volatile memory.

## Limits

Limits function is available to indicate signals beyond ranges according to the upper and lower parameters. The following are some measurement functions which are able to do a limit operation: DC Voltage, AC Voltage, DC Current, AC Current, Resistance, Frequency, Period, Capacitance and Temperature.

Press [Math]→ [Limits]→ [On] to enter the interface shown in the following diagram.

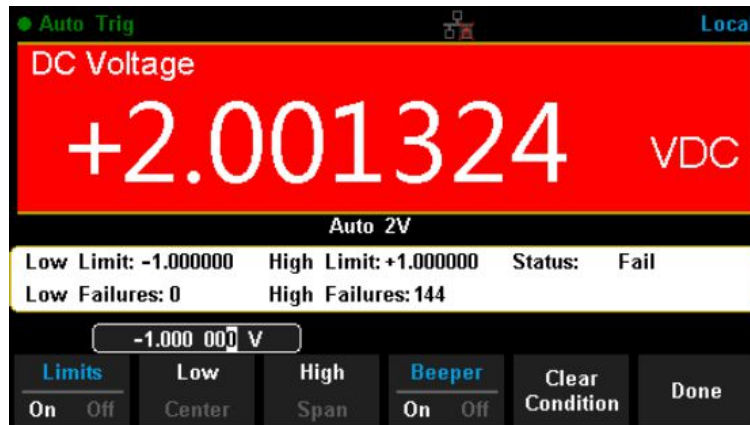

The table shows the description of Limits Measurement function menu.

Function Menu	Settings	Description
Limits	On/Off	Turn on or turn off the Limits function.
Low		Set the desired lower limit.
Center		Set the desired center value.
High		Set the desired upper limit.
Status		Show the status of limit test.
Low Failures		Show the times that reading is lower than the limit.
High Failures		Show the times that reading is higher than the limit.
Span		Set the desired span.
Beeper	On/Off	When the beeper is on, if the reading is lower or higher than limits, the instrument will beep once.
Clear Condition		Clear all current readings and restart to test.
Done		Save all changes and return to the higher level menu.

### 1. How to Set Limits

Select [High], [Low], [Center] or [Span] and then switch to the needed digit using the Left or Right Direction keys and input the numerical value by selecting the Up and Down Direction keys.

### 2. Unit

The unit of Limits is decided by the current measurement function.

### 3. Notes

- When the reading is lower than the set lower limit, the color of the main display will switch from blue to red.
- When the reading is higher than the set higher limit, the color of the main display will switch from blue to red.
- When the reading is lower or higher than the set limits, the Beeper will beep once. (The beeper is turned on.)

#### **The range of Limits function:**

- The Limits range is -120% to +120% of the current measurement range.
- The upper limit value should be always bigger than the lower limit value.
- The upper and lower values are stored in volatile memory. They will be set to default values when the power is initially turned on.



## dBm

The dBm function is logarithmic and based on a calculation of power delivered to a reference resistance, relative to 1 milliwatts. This function only applies to an AC voltage and DC voltage measurements.

Press [Math]→ [dB/dBm]→ [On] and select [Function dBm] to enter the interface shown in the following diagram.



Function Menu	Settings	Description
dB/dBm	On/Off	Turn on or turn off dB or dBm function.
Function		Open the dBm function and the lower right corner of the main display will show "dBm".
Ref R		Set the parameter via direction keys: 50Ω - 8000Ω
Done		Save all changes and return to the higher level menu.

The computation method for dBm:

When the dBm function is turned on, the measured value of voltage is transformed into dBm according to the below formula.

$$dBm = 10 * \log_{10}[(Reading^2 / R_{REF}) / 0.001W]$$

## dB

Each dB measurement is different between the input signal and a stored relative value, with both values converted to dBm. The dB function applies to AC voltage and DC voltage measurements only.

Press [Math]→ [dB/dBm On] and select [Function dB] to enter the interface shown in the following diagram.



Function Menu	Settings	Description
dB/dBm	On/Off	Turn on or turn off dB or dBm function.
Function dB		Open dB function and the lower right corner of the main display show "dB".
Ref R		Set the parameter via direction keys: 50Ω - 8000Ω
dB Ref Value		Set the referred value of dB.
Measure Ref Value		Set the referred value of measurement.
Done		Save all changes and return to the higher level menu.

The computation method of the dB:

$$dB = 10 * \log_{10}[(Reading^2/R_{REF})/0.001W] - (dB \text{ setting value})$$

$R_{REF}$  expressed measuring the resistance value in the actual electric circuit. Range of the dB setting value: -200 dBm to +200 dBm. The default is 0 dBm.

### dB value:

- Input a value in dB setting interface using the direction buttons, and then store it as dB setting value.
- Settings of dB value are stored in volatile memory.

## Relative Value

Relative value is used for relative measurements. Actual measurement reading is the difference between measurement value and preset value.

The DAQ Relative Value is available for the following measurement parameters: DC Voltage, AC Voltage, DC Current, AC Current, Resistance, Frequency, Period, Capacitance and Temperature.

Press [Math]→ [Rel Value] to enter the interface shown in the following diagram.

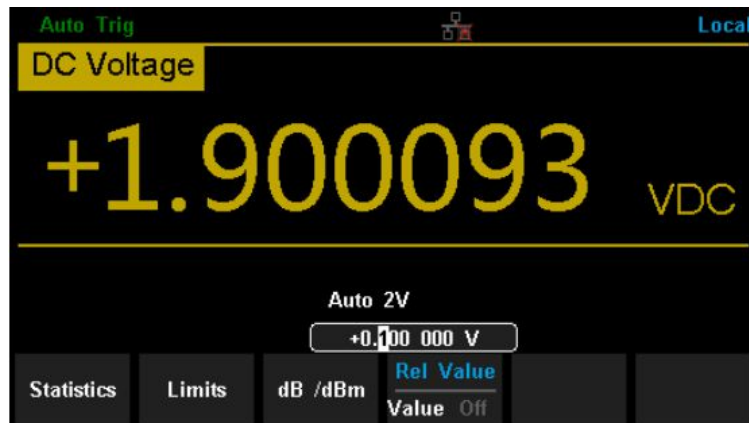

Function Menu	Description
Value	Select the current measurement value as the preset value.
Off	Turn off the relative operation function.

When Rel Value function is turned on, the result of relative measurement will display on the screen.

**Main display = Measurement value – Preset value**

## Display Mode

The DAQ supports four types of views for measured data: “Number”, “Bar Meter”, “Trend Chart” and “Histogram”.

### Number

Press [Shift] and [Math] to open the menu of display mode and press [Display] to enter the following interface. “Number” is always the selected mode when the DAQ is turned on.

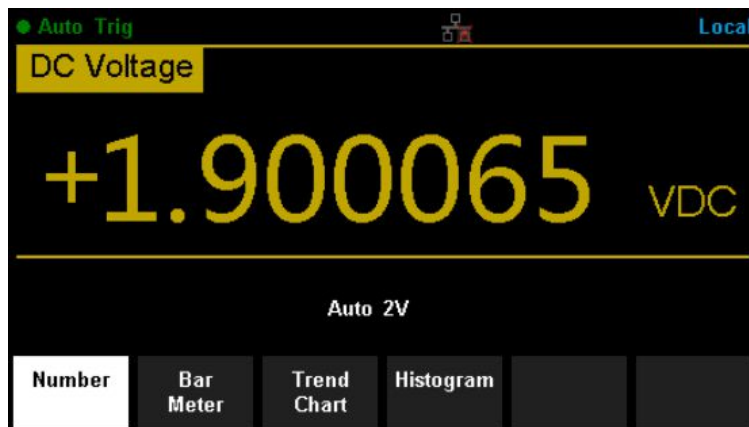

## Bar Meter

### Operating Steps:

1. Press [Bar Meter] to enter Bar Meter display mode.

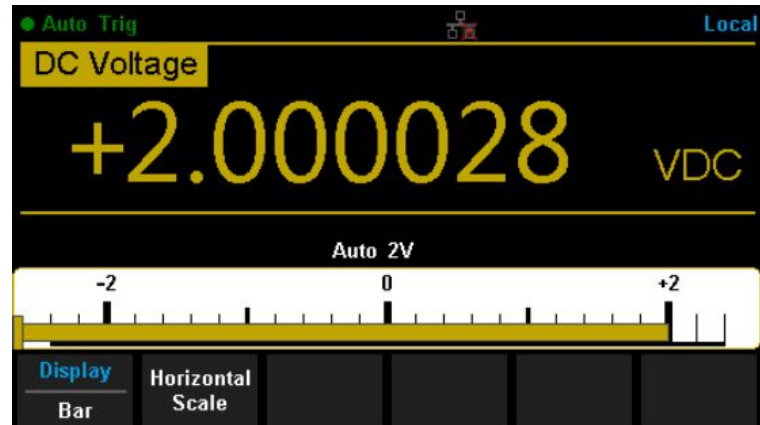

2. Press [Horizontal Scale] to set the vertical scale as Default Manual mode.

Table below shows the functions menu and the description.

Function Menu	Description
Low	Set the low value of horizontal scale.
High	Set the high value of horizontal scale.
Center	Set the center value of horizontal scale.
Span	Set the span of horizontal scale.
Done	Save all changes and return to the higher level menu.

## Trend Chart

### Operating Steps:

1. Press [Trend Chart] to enter the Trend Chart display mode.

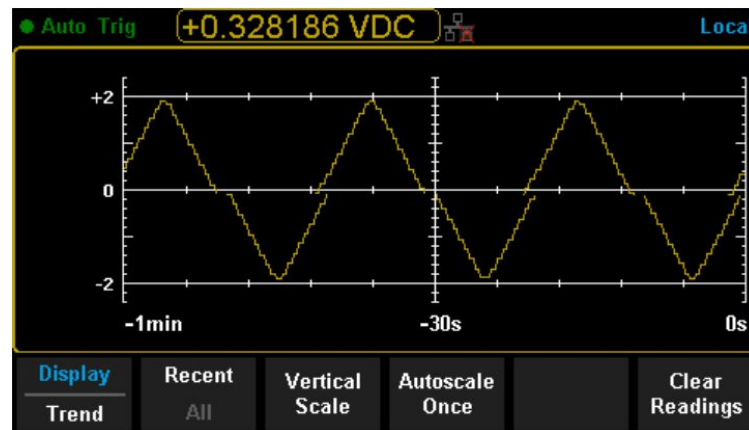
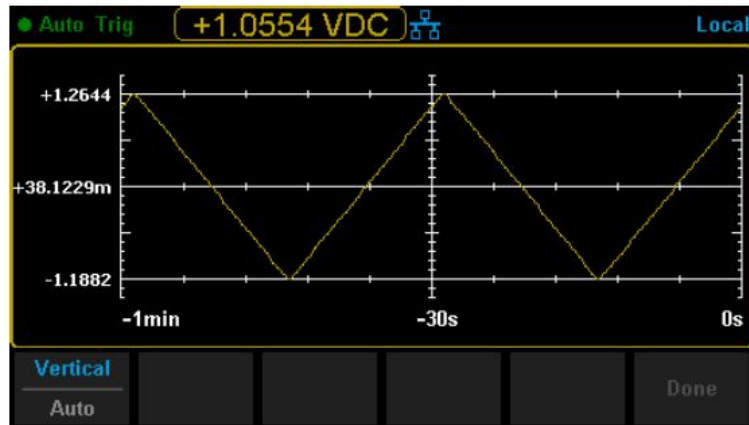

Table below describes the Trend Chart Display Mode.

Function Menu	Description
Display Trend	The current select display mode is Trend Chart.
Recent All	Show recent or all readings.
Horizontal Scale	Choose the mode of Horizontal Scale.
Autoscale Once	Automatically set the horizontal scale once.
Clear Readings	Clear all current readings and restart statistics.

2. Press [Horizontal Scale] to choose the way to set the horizontal scale as Default, Auto or Manual mode.  
Press [Auto] and the DAQ will set the vertical scale automatically.



Press [Manual] and you can set the vertical scale manually, as displayed in the diagram below.

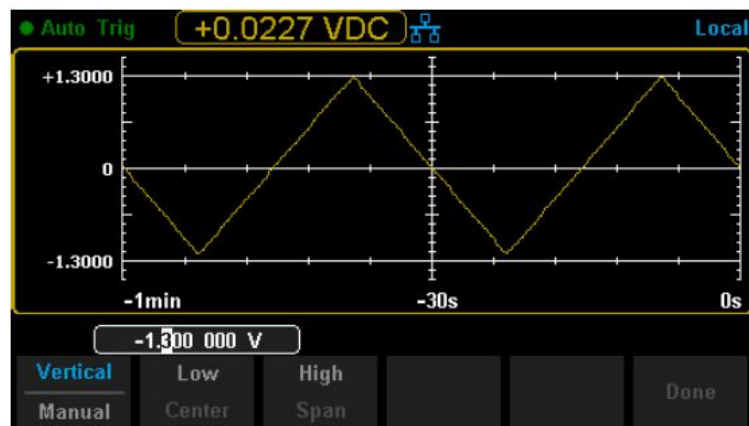

## Histogram

### Operating Steps:

1. Press [Histogram] to enter the Histogram display mode.

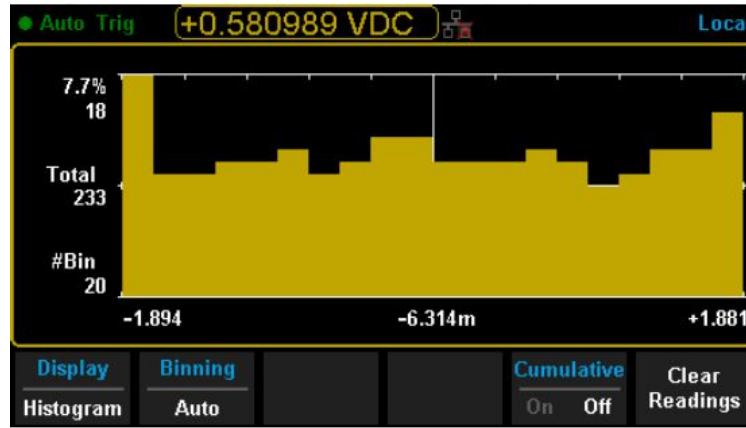
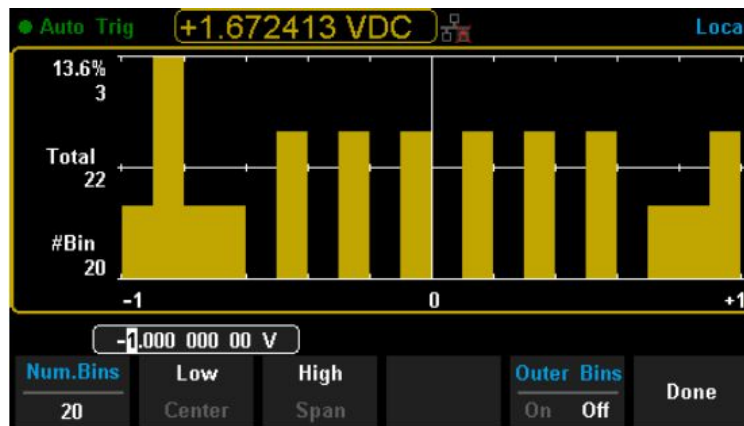

Table below describes the Histogram Display Mode.

Function Menu	Settings	Description
Display Histogram		Currently selected display mode is Histogram.
Binning		Set Binning as Auto or Manual mode.
Bin Set		Set the Bin parameters.
Cumulative	On/Off	Turn on or off the Cumulative function.
Clear Readings		Clear all current readings and restart statistics.

2. Press [Binning] to set Binning as the Auto or Manual mode. When in Manual mode, press [Bin Settings] to enter the following interface.





<b>Function Menu</b>	<b>Settings</b>	<b>Description</b>
Num.Bins		Set the number of Bins, 10, 20, 40, 100, 200 or 400 selected.
Low		Set the low value of the horizontal scale.
High		Set the high value of the horizontal scale.
Center		Set the center value of the horizontal scale.
Span		Set the span of the horizontal scale.
Outer Bins	On/Off	Set the bins beyond the set range or not.
Done		Save all changes and return to the higher level menu.

## Trigger

The DAQ supports the Trigger function. Press [Run/Stop] or [Single] on the front panel to trigger the DAQ by Auto or Single mode. Auto trigger is considered as a default when the power is initially turned on.

### Auto Trigger

Press [Run/Stop] on the front panel one time and the Auto Trigger will be started to capture continuous readings automatically. The screen will show “**Auto Trigger**”. Press [Run/Stop] again and the trigger is stopped.

### Single Trigger

Press [Single] on the front panel, the Single Trigger will be started one time and generate a single reading. The screen will show “**Single Trig**”.

### Explanation

In the Remote Mode, the screen will show “**Imme Trig**”. Press [Shift] to switch back to the local mode and the DAQ will choose Auto Trigger automatically.

## Hold Measurement Function

Hold Measurement function provides users with a stable reading on the screen of the front panel. When the test leads are disconnected, the reading is still held on the screen, which enables users to view the measured history data.

Press [Shift] and [Single] to open Hold measurement function interface, the black field just above the screen will show “**Probe Hold**”, as shown in the following diagram.



Function Menu	Settings	Description
Probe Hold	On/Off	Turn on or off the Probe Hold function.
Beeper	On/Off	Turn on or off the Beeper.
Clear List		Clear all current readings and restart the statistics.



## Chapter 3

# Measurement Tutorial

### True RMS AC Measurement

The AC measurement of the DAQ has a true RMS response. The power dissipated in a resistor within a time is proportional to the square of the measured true RMS voltage, independent of waveform shape. The instrument can accurately measure true RMS voltage or current, as long as the waveform shape contains negligible energy above the effective bandwidth.

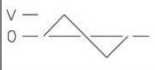
The AC voltage and AC current functions measure the “AC coupled” true RMS value, which is to measure the RMS value of the AC component (DC component is rejected) of the input signal. For sine waves, triangle waves, and square waves, the AC and AC+DC values are equal since these waveforms do not contain a DC offset. See the table below.

Waveform	Crest Factor (C.F.)	AC RMS	AC+DC RMS
	$\sqrt{2}$	$\frac{V}{\sqrt{2}}$	$\frac{V}{\sqrt{2}}$
	$\sqrt{3}$	$\frac{V}{\sqrt{3}}$	$\frac{V}{\sqrt{3}}$
	$\sqrt{\frac{T}{t}}$	$\frac{V}{\text{C.F.}} \times \sqrt{1 - \left(\frac{1}{\text{C.F.}}\right)^2}$	$\frac{V}{\text{C.F.}}$

An AC coupled true RMS measurement is desirable in situations where you are measuring small AC signals in the presence of DC offsets. For instance, measuring an AC ripple present on DC power supplies. There are situations, however, where you might want to know the AC+DC true RMS value. You can determine this value by combining results from DC and AC measurements as the following shows. You should perform the DC measurement using 6.5 digit mode for best AC rejection.

$$RMS_{(AC+DC)} = \sqrt{AC^2 + DC^2}$$

## Crest Factor Errors (non-sinusoidal inputs)

A common misconception is that "since an AC Multimeter is a true RMS, its sine wave accuracy specifications apply to all waveforms." The shape of the input signal can dramatically affect measurement accuracy. A common way to describe signal wave shapes is "crest factor". Crest factor is the ratio of the peak value to RMS value of a waveform.

The greater the crest factor, the greater the energy contained in high frequency harmonics. All Multimeters have errors that are crest factor dependent. (The crest factor errors do not apply for input signals below 100Hz.)

You can estimate the measurement error due to signal crest factor as shown below:

**Total Error = Error (Sine wave) + Error (Crest factor) + Error (Bandwidth)**

Error (Sine wave): error for sine wave

Error (Crest factor): crest factor additional error.

Error (Bandwidth): estimated bandwidth error as shown below:

$$\text{Bandwidth error} = \frac{C.F.*F}{4\pi*BW} * 100\% (\% \text{reading})$$

**C.F.:** signal crest factor

**F:** fundamental frequency of pulse

**BW:** effective bandwidth of the Multimeter

### Example:

Calculate the approximate measurement error for a pulse train input with a crest factor of 2 and a fundamental frequency of 20 kHz. For this example, assume 1-year accuracy specifications of the Multimeter:  $\pm(0.05\% \times \text{reading} + 0.03\% \times \text{range})$ .

$$\begin{aligned} \text{Total Error} &= (0.05\% \times \text{reading} + 0.03\% \times \text{range}) + (0.05\% \times \text{range}) + (0.8\% \times \text{reading}) \\ &= 0.85\% \times \text{reading} + 0.08\% \times \text{range} \end{aligned}$$

## Loading Errors (AC Voltage)

In the AC Voltage function, the input of T3DAQ1-16 appears as a  $1M\Omega$  resistance in parallel with  $100pF$  of capacitance. The test lead that you use to connect signals to the Multimeter will also add additional capacitance and loading. The approximate input resistances of the Multimeter at different frequencies are listed in the following table.

Table below shows the approximate input resistances at different frequencies.

Input Frequency	Input Resistance
100Hz	$1M\Omega$
1kHz	$850k\Omega$
10kHz	$160k\Omega$
100kHz	$16k\Omega$

For low frequencies:

$$\text{Error (\%)} = \left[ \frac{-R_s}{R_s + 1M\Omega} \right] * 100\%$$

For high frequencies:

$$\text{Error (\%)} = \left[ \frac{1}{\sqrt{1 + (2\pi * F * R_s * C_m)}} - 1 \right] * 100\%$$

$F$ : input frequency

$R_s$ : source resistance

$C_m$ : input capacitance ( $100pF$ ) plus test lead capacitance

## Chapter 4

# General Troubleshooting

The commonly encountered failures and their solutions are listed below. When you encounter those problems, please resolve them using the following steps. If the problem remains, please contact the Teledyne LeCroy service center and provide your device Information including serial number.

### **The screen has no display after pressing the power key.**

1. Check whether the power cord is fully connected.
2. Check whether the power fuse has blown or has failed. If the fuse needs to be changed, please use the specified fuse.
3. Restart the instrument after finishing the above checks.
4. If the instrument still doesn't start up properly, please contact the Teledyne LeCroy service center.

### **The reading doesn't change when a current signal is input.**

1. Check whether the test lead is correctly inserted into the HI and LO terminals of current measurement.
2. Check whether the current fuse at the back panel has blown.
3. Check whether the DCI or ACI measurement function is enabled.
4. Check whether the DCI measurement function is used to measure AC current.

### **The reading is abnormal when a voltage signal is input.**

1. Check whether the test lead is correctly inserted into the HI and LO terminals for voltage measurements.
2. Check whether the DCV or ACV measurement function is enabled.
3. Check whether the DCV measurement function is used to measure AC voltage.

**The USB storage device cannot be identified.**

1. Check whether the USB storage device is in good condition.
2. Make sure the USB storage device you used is a flash storage device. This instrument does not support hardware storage types.
3. Check the capacity of your USB storage device. It is recommended that the capacity of the USB storage device is no larger than 8G bytes and FAT formatted.
4. Restart the instrument, then insert the USB storage device.
5. If the problem persists, please contact the Teledyne LeCroy service center.



# Chapter 5

# Appendix

## Appendix A: Accessories

Standard Accessories:

- Power cords.
- Test lead set.
- USB Cable.

NOTE:

- We suggest that the length of the USB data wire and LAN cable connected to the instrument should be less than 3m to avoid affecting the product performance.
- All the accessories are available by contacting your local Teledyne LeCroy office.

## Appendix B: Warranty summary

**Teledyne Test Tools** warrants that the products will be free from defects in materials and workmanship for a period of three years from the date of shipment from an authorized **Teledyne Test Tools** distributor. If a product proves defective within the respective period, **Teledyne Test Tools** will provide repair or replacement as described in the complete warranty statement.

To arrange for service or obtain a copy of the complete warranty statement, please contact your nearest **Teledyne Test Tools** sales and service office. Except as provided in this summary or the applicable warranty statement, **Teledyne Test Tools** makes no warranty of any kind, expressed or implied, including without limitation the implied warranties of merchantability and fitness for a particular purpose. In no event shall **Teledyne Test Tools** be liable for indirect, special or consequential damages.

## Certifications

Teledyne LeCroy certifies compliance to the following standards as of the time of publication. Please see the EC Declaration of Conformity document shipped with your product for current certifications.

### EMC Compliance

#### EC DECLARATION OF CONFORMITY - EMC

The instrument meets intent of EC Directive 2014/30/EU for Electromagnetic Compatibility. Compliance was demonstrated to the following specifications listed in the Official Journal of the European Communities:

EN 61326-1:2013, EN 61326-2-1:2013 EMC requirements for electrical equipment for measurement, control, and laboratory use. <sup>1</sup>

#### Electromagnetic Emissions:

EN 55011:2016+A1:2017, Radiated and Conducted Emissions Group 1, Class A<sup>2,3</sup>

EN 61000-3-2:2014 Harmonic Current Emissions, Class A

EN 61000-3-3:2013 Voltage Fluctuations and Flickers, Pst = 1

#### Electromagnetic Immunity:

EN 61000-4-2:2009 Electrostatic Discharge, 4 kV contact, 8 kV air, 4 kV vertical/horizontal coupling planes <sup>4</sup>

EN 61000-4-3:2006+ A2:2010 RF Radiated Electromagnetic Field,  
3 V/m, 80-1000 MHz; 3 V/m, 1400 MHz - 2 GHz; 1 V/m, 2 GHz - 2.7 GHz

EN 61000-4-4:2012 Electrical Fast Transient/Burst, 1 kV on power supply lines, 0.5 kV on I/O signal data and control lines <sup>4</sup>

EN 61000-4-5:2014+A1:2017 Power Line Surge, 1 kV AC Mains, L-N, L-PE, N-PE <sup>4</sup>

EN 61000-4-6:2014 RF Conducted Electromagnetic Field, 3 Vrms, 0.15 MHz - 80 MHz

EN 61000-4-11:2004+A1:2017 Mains Dips and Interruptions, 0%/1 cycle, 70%/25 cycles, 0%/250 cycles <sup>4,5</sup>

<sup>1</sup> To ensure compliance with all applicable EMC standards, use high-quality shielded interface cables.

<sup>2</sup> Emissions which exceed the levels required by this standard may occur when the instrument is connected to a test object.

<sup>3</sup> This product is intended for use in nonresidential areas only. Use in residential areas may cause electromagnetic interference.

<sup>4</sup> Meets Performance Criteria "B" limits of the respective standard: during the disturbance, product undergoes a temporary degradation or loss of function or performance which is self-recoverable.

<sup>5</sup> Performance Criteria "C" applied for 70%/25 cycle voltage dips and for 0%/250 cycle voltage interruption test levels per EN61000-4-11.

#### AUSTRALIA & NEW ZEALAND DECLARATION OF CONFORMITY – EMC

The instrument complies with the EMC provision of the Radio Communications Act per the following standards, in accordance with requirements imposed by Australian Communication and Media Authority (ACMA):

AS/NZS CISPR 11:2015 Radiated and Conducted Emissions, Group 1, Class A.

\* Visit [teledynelecroy.com/support/contact](http://teledynelecroy.com/support/contact) for the latest contact information.

## Safety Compliance

### EC DECLARATION OF CONFORMITY - LOW VOLTAGE

The instrument meets intent of EC Directive 2014/35/EU for Product Safety. Compliance was demonstrated to the following specifications as listed in the Official Journal of the European Communities:

EN 61010-1:2010 Safety requirements for electrical equipment for measurement, control, and laboratory use –

Part 1: General requirements

EN 61010-2:030:2010 Safety requirements for electrical equipment for measurement, control, and laboratory use –

Part 2-030: Particular requirements for testing and measuring circuits

The design of the instrument has been verified to conform to the following limits put forth by these standards:

- Mains Supply Connector: Overvoltage Category II, instrument intended to be supplied from the building wiring at utilization points (socket outlets and similar).
- Measuring Circuit Terminals: No rated measurement category. Terminals not intended to be connected directly to the mains supply.
- Unit: Pollution Degree 2, operating environment where normally only dry, non-conductive pollution occurs. Temporary conductivity caused by condensation should be expected.

## Environmental Compliance

### END-OF-LIFE HANDLING

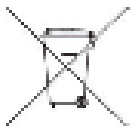

The instrument is marked with this symbol to indicate that it complies with the applicable European Union requirements of Directives 2012/19/EU and 2006/66/EC on Waste Electrical and Electronic Equipment (WEEE) and Batteries.

The instrument is subject to disposal and recycling regulations that vary by country and region. Many countries prohibit the disposal of waste electronic equipment in standard waste receptacles. For more information about proper disposal and recycling of your Teledyne LeCroy product, please visit [teledynelecroy.com/recycle](http://teledynelecroy.com/recycle).

### RESTRICTION OF HAZARDOUS SUBSTANCES (RoHS)

#### EC DECLARATION OF CONFORMITY – RoHS

Unless otherwise specified, all the materials and processes are compliant with RoHS Directive 2011/65/EU in its entirety, inclusive of any further amendments or modifications of said Directive.

#### CHINA RoHS 2

Unless otherwise specified, all the materials and processes are compliant with the latest requirements of China RoHS 2. The hazardous substances contained in the instrument are disclosed in accordance with the standards SJ/T 11364-2014 (Marking for the restricted use of hazardous substances in electronic and electrical products) and GB/T 26572-2011 (Requirements on concentration limits for certain restricted substances in electrical and electronic products). The instrument is marked with an appropriate Environmental Friendly Use Period (EFUP) symbol. The packaging materials include the appropriate recycling labels. The below substance disclosure tables (in Chinese and English languages) provide the required compliance information.

部件名称	有毒有害物质和元素					
	铅 (Pb)	汞 (Hg)	镉 (Cd)	六价铬 (Cr6+)	多溴联苯 (PBB)	多溴二苯醚 (PBDE)
PCBA <sub>s</sub>	×	□	□	□	□	□
机械硬件	□	□	□	□	□	□
金属片	□	□	□	□	□	□
塑料部件	□	□	□	□	□	□
电缆组件	×	□	□	□	□	□
显示器	□	□	□	□	□	□
电源	□	□	□	□	□	□
风扇	□	□	□	□	□	□
电池	□	□	□	□	□	□
电源线	□	□	□	□	□	□
外部电源(如有)	×	□	□	□	□	□
探头(如有)	×	□	□	□	□	□
熔丝(如有)	□	□	□	□	□	□
产品外壳(如有)	□	□	□	□	□	□
适配器/模块(如有)	□	□	□	□	□	□
鼠标(如有)	□	□	□	□	□	□
□: 表明该有毒有害物质在该部件所有均质材料中的含量均在SJ/T11364-2014标准规定的限量要求之下。						
×: 表示该有毒有害物质至少在该部件的某一均质材料中的含量超出SJ/T11364-2014标准规定的限量要求。						

EFUP (对环境友好的使用时间): 30年。

使用条件: 参阅用户手册“环境条件”部分的规定。

探头EFUP: 10年。

Part Name	Toxic or Hazardous Substances and Elements					
	Lead (Pb)	Mercury (Hg)	Cadmium (Cd)	Hexavalent Chromium (Cr6+)	Polybrominated Biphenyls (PBB)	Polybrominated Diphenyl Ethers (PBDE)
PCBAs	X	0	0	0	0	0
Mechanical Hardware	0	0	0	0	0	0
Sheet Metal	0	0	0	0	0	0
Plastic Parts	0	0	0	0	0	0
Cable Assemblies	X	0	0	0	0	0
Display	0	0	0	0	0	0
Power Supply	0	0	0	0	0	0
Fans	0	0	0	0	0	0
Batteries	0	0	0	0	0	0
Power Cord	0	0	0	0	0	0
Ext Power Supply (if present)	X	0	0	0	0	0
Probes (if present)	X	0	0	0	0	0
Fuse (if present)	0	0	0	0	0	0
Product Case (if present)	0	0	0	0	0	0
Adapters/Modules (if present)	0	0	0	0	0	0
Mouse (if present)	0	0	0	0	0	0
0: Indicates that this toxic or hazardous substance contained in all of the homogeneous materials for this part is below the limit requirement specified in SJ/T11364-2014.						
X: Indicates that this toxic or hazardous substance contained in at least one of the homogenous materials used for this part is above the limit requirement specified in SJ/T11364-2014.						

EFUP (Environmental Friendly Use Period): 30 years.

Use Conditions: Refer to the environmental conditions stated in the User Manual.

EFUP for Probes: 10 years.

# ABOUT TELEDYNE TEST TOOLS



## Company Profile

Teledyne LeCroy is a leading provider of oscilloscopes, protocol analyzers and related test and measurement solutions that enable companies across a wide range of industries to design and test electronic devices of all types. Since our founding in 1964, we have focused on creating products that improve productivity by helping engineers resolve design issues faster and more effectively. Oscilloscopes are tools used by designers and engineers to measure and analyze complex electronic signals in order to develop high-performance systems and to validate electronic designs in order to improve time to market.

The Teledyne Test Tools brand extends the Teledyne LeCroy product portfolio with a comprehensive range of test equipment solutions. This new range of products delivers a broad range of quality test solutions that enable engineers to rapidly validate product and design and reduce time-to-market. Designers, engineers and educators rely on Teledyne Test Tools solutions to meet their most challenging needs for testing, education and electronics validation.

## Location and Facilities

Headquartered in Chestnut Ridge, New York, Teledyne Test Tools and Teledyne LeCroy has sales, service and development subsidiaries in the US and throughout Europe and Asia. Teledyne Test Tools and Teledyne LeCroy products are employed across a wide variety of industries, including semiconductor, computer, consumer electronics, education, military/aerospace, automotive/industrial, and telecommunications.

Distributed by: