



TE sensors

Solid current sensors

used with DIRIS Digiware, DIRIS A-40 and DIRIS B

Current sensors

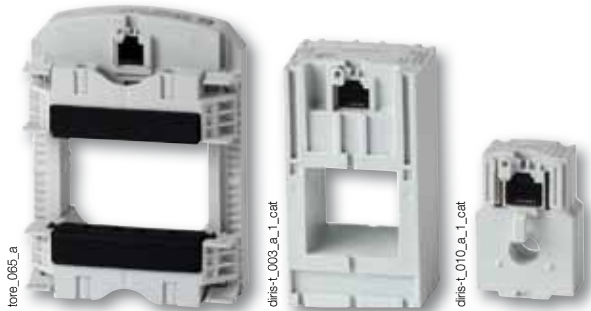

TE solid sensors

The solution for

- > Industry
- > Building
- > Infrastructure
- > Data center



Strong points

- > Plug & Play
- > Accuracy as per standard IEC 61557-12
- > Installation

Conformity to standards

- > UL 61010 guide PICQ file E257746



- > IEC 61557-12



- > ISO 14025



Function

TE smart **current sensors** measure the load currents of an electrical system and send the data to meters and measurement hubs via an RJ12 plug-and-play output. Thanks to a wide measurement range, TE current sensors cover the full current range of 5 to 2000 A, with 7 references. TE solid current sensors can be connected to DIRIS Digiware, DIRIS A-40, or DIRIS B Power Monitoring Devices via a rapid RJ12 connection.

Numerous accessories are available to aid the installation of sensors in any type of cabinet.

Advantages

Plug & Play

- A rapid RJ12 connection makes wiring easy and reliable and prevents wiring errors. This also allows automatic detection of the sensor type and size/transformation ratio.
- The sensors can be installed in both directions.

Installation

- The TE solid sensor range is specially designed for new installations, and has the same pitch as the most common protective devices.

Accuracy as per standard IEC 61557-12

- Class 0.5 for the global measuring chain (measurement hub + TE current sensors) from 2 to 120% of the nominal current I_n .



99 Washington Street
Melrose, MA 02176
Phone 781-665-1400
Toll Free 1-800-517-8431



Visit us at www.TestEquipmentDepot.com

Mounting

Linear assembly with the protective devices
TE-25 / TE-35 / TE-45 / TE-55 / TE-90

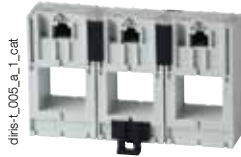

diris-t_005_a_1_cat

DIN rail mounted



diris-t_003_a_1_cat

TE-90 clamps



diris-t_048_a

Staggered assembly
TE-18 / TE-35 / TE-45 / TE-55



diris-t_005_a_1_cat

Back-plate mounting

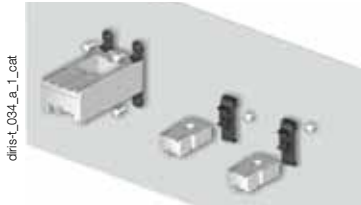

diris-t_004_a_1_cat

Cable mounting



diris-t_005_a_1_cat

Bar mounting



diris-t_006_a_1_cat

diris-t_049_a

Connections

TE / TR / TF current sensors



diris-b_003_a_cat





TE sensors

Solid current sensors

used with DIRIS Digiware, DIRIS A-40 and DIRIS B

Mounting accessories

Mounting accessories delivered with TE sensors:

Switch mounting		TE-18	TE-25	TE-35 TE-45 TE-55	TE-90
	DIN rail and back-plate	1 pc			2 pcs
	DIN rail		2 pcs	2 pcs	
	Back-plate		4 pcs	4 pcs	6 pcs
	Busbar			2 pcs	

Compatible accessories

Adapter for CT with 5A secondary



- With this adapter you can use a current transformer with a 5 A output on the DIRIS Digiware and DIRIS B-30.
- For use with standard 5 A sensors for measuring applications of > 2000 A. The dimensions are the same as the TE-18.

Coupling link

- Associated with the TE range, this accessory is for inter-connecting the sensors when linear or staggered mounted.



Sealable cover

- Using a sealable cover guarantees the immunity of the sensor connection on TE/TR/TF current sensors.



Dimensions (in/mm)

TE - Solid current sensors

TE-18

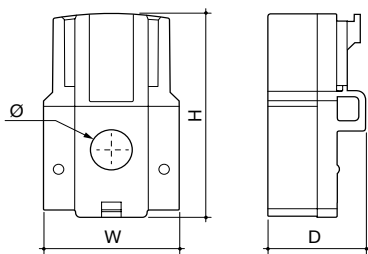

TE-25 / TE-35 / TE-45 / TE-55

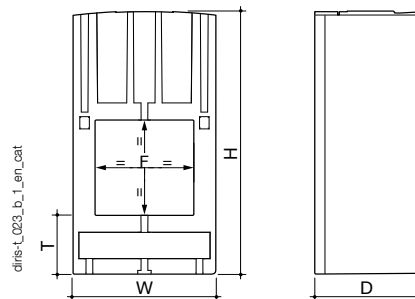

TE-90

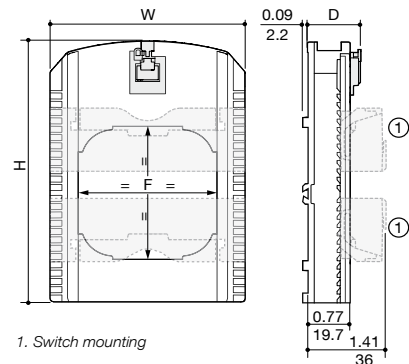

Model	Nominal current range (A)	Actual coverage range (A)	Pitch (in/mm)	H x W x D (in/mm)	F (in/mm)	T (in/mm)
TE-18	5 ... 20/25 ... 63	0.1 ... 24/0.5 ... 75	0.7/18	1.77 x 1.10 x 0.79/45 x 28 x 20	Ø 0.33/8.6	-
TE-25	40 ... 160	0.8 ... 192	0.98/25	2.56 x 0.98 x 1.28/65 x 25 x 32.5	0.53 x 0.53/13.5 x 13.5	0.69/17.5
TE-35	63 ... 250	1.26 ... 300	1.37/35	2.79 x 1.37 x 1.28/71 x 35 x 32.5	0.82 x 0.82 / 21 x 21	0.69/17.5
TE-45	160 ... 630	3.2 ... 756	1.77/45	3.38 x 1.77 x 1.28/86 x 45 x 32.5	1.22 x 1.22 / 31 x 31	0.77/19.5
TE-55	400 ... 1000	8 ... 1200	2.16/55	3.93 x 2.16 x 1.28/100 x 55 x 32.5	1.61 x 1.61 / 41 x 41	0.85/21.5
TE-90	600 ... 2000	12 ... 2400	3.54/90	4.96 x 3.54 x 0.97/126 x 90 x 24.6	2.52 x 2.52 / 64 x 64	-

Specifications

TE - Solid current sensors							
Model	TE-18	TE-18	TE-25	TE-35	TE-45	TE-55	TE-90
Nominal current range I_n (A)	5 ... 20	25 ... 63	40 ... 160	63 ... 250	160 ... 630	400 ... 1000	600 ... 2000
Actual coverage range (A)	0.1 ... 24	0.5 ... 75	0.8 ... 192	1.26 ... 300	3.2 ... 756	8 ... 1200	12 ... 2400
Max. current (A)	24	75.6	192	300	756	1200	2400
Weight (oz/g)	0.84/24	0.84/24	2.4/69	3.1/89	4.9/140	6.6/187	5.75/163
Max. voltage (phase/neutral)	300 V					600 V	
Rated withstand voltage	3 kV						
Frequency	50/60 Hz						
Intermittent overload	10 x I_n over 1 sec						
Measurement category	CAT III						
Protection degree	IP30 / IK06						
Operating temperature	-10 ... +70 °C / +14 °F ... +158 °F						
Storage temperature	-25 ... +85 °C / -13 °F ... +185 °F						
Relative humidity	95 % non-condensing						
Altitude	< 6560 feet / 2000 m						
Connection	SOCOMECC cable or equivalent RJ12 straight, twisted pair, unshielded 300 V cat. III UL 61010 cable. -40 °C ... +85 °C / -40 °F ... +185 °F						

References

Model	Nominal current range (A)	Actual coverage range (A)	Pitch (mm)	Reference
TE-18	5 ... 20	0.1 ... 24	0.7/18	4829 0500
TE-18	25 ... 63	0.5 ... 75	0.7/18	4829 0501
TE-25	40 ... 160	0.8 ... 192	0.98/25	4829 0502
TE-35	63 ... 250	1.26 ... 300	1.37/35	4829 0503
TE-45	160 ... 630	3.2 ... 756	1.77/45	4829 0504
TE-55	400 ... 1000	8 ... 1200	2.16/55	4829 0505
TE-90	600 ... 2000	12 ... 2400	3.54/90	4829 0506

Accessories	Reference
Coupling link (20 linear assembly parts and 10 for staggered assembly)	4829 0598
CT/5A adapter (measurements of >2000 A) (max primary current 10000 A/5/A)	4829 0599
Sealable caps (20 pieces)	4829 0600

RJ12 connection cables	Cable length (ft/m)								
	0.32/0.1	0.64/0.2	0.96/0.3	1.64/0.5	3.3/1	6.5/2	16.4/5	32.8/10	164/50 + 100 connectors
Number of cables	Reference	Reference	Reference	Reference	Reference	Reference	Reference	Reference	Reference
1	-	-	-	-	-	-	4829 0602	4829 0603	4829 0601
3	4829 0580	4829 0581	4829 0582	4829 0595	4829 0583	4829 0584	-	-	-
4	-	-	-	4829 0596	4829 0588	4829 0589	-	-	-
6	4829 0590	4829 0591	4829 0592	4829 0597	4829 0593	4829 0594	-	-	-



1-800-517-8431

99 Washington Street
Melrose, MA 02176
Phone 781-665-1400
Toll Free 1-800-517-8431



Visit us at www.TestEquipmentDepot.com