

AMPROBE®

**Test Equipment
Depot**
1-800-517-8431

99 Washington Street
Melrose, MA 02176
Phone 781-665-1400
Toll Free 1-800-517-8431



Visit us at www.TestEquipmentDepot.com

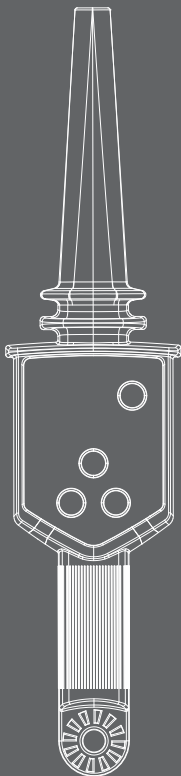

TIC 300 PRO

**High Energy Tic Tracer –
Non Contact
AC Voltage Detector**

User Manual



AMPROBE®

TIC 300 PRO

**High Energy Tic Tracer –
Non Contact
AC Voltage Detector**

User Manual

English

10/2019, Rev006
©2019 Amprobe.
All rights reserved. Printed in China

Limited Warranty and Limitation of Liability

Your Amprobe product will be free from defects in material and workmanship for 1 year from the date of purchase. This warranty does not cover fuses, disposable batteries or damage from accident, neglect, misuse, alteration, contamination, or abnormal conditions of operation or handling. Resellers are not authorized to extend any other warranty on Amprobe's behalf. To obtain service during the warranty period, return the product with proof of purchase to an authorized Amprobe Test Tools Service Center or to an Amprobe dealer or distributor. See Repair Section for details. THIS WARRANTY IS YOUR ONLY REMEDY. ALL OTHER WARRANTIES - WHETHER EXPRESS, IMPLIED OR STAUTORY - INCLUDING IMPLIED WARRANTIES OF FITNESS FOR A PARTICULAR PURPOSE OR MERCHANTABILITY, ARE HEREBY DISCLAIMED. MANUFACTURER SHALL NOT BE LIABLE FOR ANY SPECIAL, INDIRECT, INCIDENTAL OR CONSEQUENTIAL DAMAGES OR LOSSES, ARISING FROM ANY CAUSE OR THEORY. Since some states or countries do not allow the exclusion or limitation of an implied warranty or of incidental or consequential damages, this limitation of liability may not apply to you.

Repair

All test tools returned for warranty or non-warranty repair or for calibration should be accompanied by the following: your name, company's name, address, telephone number, and proof of purchase. Additionally, please include a brief description of the problem or the service requested and include the test leads with the meter. Non-warranty repair or replacement charges should be remitted in the form of a check, a money order, credit card with expiration date, or a purchase order made payable to Amprobe® Test Tools.

In-Warranty Repairs and Replacement – All Countries

Please read the warranty statement and check your battery before requesting repair. During the warranty period any defective test tool can be returned to your Amprobe® Test Tools distributor for an exchange for the same or like product. Please check the "Where to Buy" section on www.amprobe.com for a list of distributors near you. Additionally, in the United States and Canada In-Warranty repair and replacement units can also be sent to a Amprobe® Test Tools Service Center (see address below).

Non-Warranty Repairs and Replacement – US and Canada

Non-warranty repairs in the United States and Canada should be sent to a Amprobe® Test Tools Service Center. Call Amprobe® Test Tools or inquire at your point of purchase for current repair and replacement rates.

TIC 300 PRO

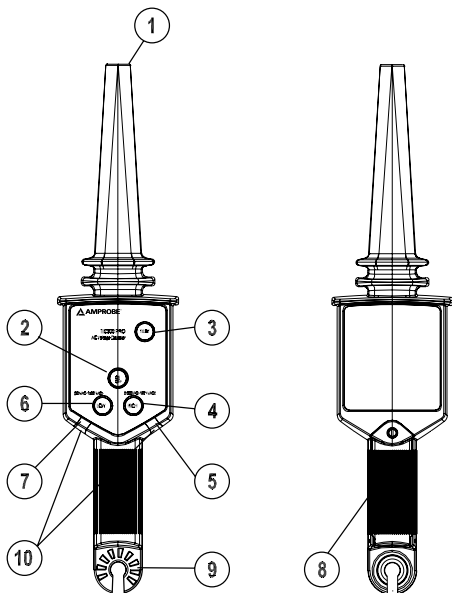

1) Voltage sensor

2) ON/OFF Button

3) Circuit TEST button

4) HIGH range switch

5) HIGH range LED

6) LOW range switch

7) LOW range LED

8) Battery compartment







9) HOT STICK attachment point

10) Detection Blue LED indicators

CONTENTS

SYMBOLS	2
UNPACKING AND INSPECTION	3
INTRODUCTION	4
Features	4
OPERATION	5
ON/OFF Button	5
TEST Button	5
Voltage Detection	6
LOW Range.....	6
HIGH Range	6
Locate breaks in insulated wire & heating elements.....	7
Check Outlets and Switches	8
MAINTENANCE AND REPAIR	9
Cleaning.....	9
Battery Replacement	9
SPECIFICATIONS	10
Sensitivity: LOW Voltage	11
Sensitivity: HIGH Voltage.....	11

SYMBOLS

	Refer to the manual
	Caution Dangerous Voltage
	Double insulated
	In compliance with the United States Department Of Labor Mine Safety and Health Administration
	Conforms to relevant Australian standards.
	Conforms to relevant South Korean EMC standards.
	Do not dispose of this product as unsorted municipal waste.

For Use By Trained Personnel Only

Anyone using this instrument should be knowledgeable and trained about the risks involved with measuring medium and high voltage, especially in an industrial setting, and the importance of taking safety precautions and of testing the instrument before and after using it to ensure that it is in good working condition.

⚠ WARNING and PRECAUTIONS

- Use extreme caution when testing live electrical circuits due to risk of injury from electrical shock.
- Do not exceed the maximum overload limits (see specifications) or the limits marked on the instrument itself. Never test voltage more than 122 kV AC RMS.
- When using the HIGH range, the TIC 410A HOT STICK or equivalent extension pole **MUST** be used.
- Comply with local and national safety requirements.
- Use proper protective equipment as required by local and national authorities.

- Observe the proper safety precautions when working with voltages above 33 VAC RMS to avoid electrical shock hazard.
- Before and after hazardous voltage measurements, test the TIC 300 PRO by pressing the TEST button and/or on a known source such as line voltage to determine proper operation.
- Never ground yourself when taking measurements. Do not touch exposed circuit elements.
- Do not operate the instrument in an explosive atmosphere.
- Do not expose this product to rain or moisture. This increases the risk of fire or electric shock.
- Do not rely on the TIC 300 PRO for testing shielded wire.
- Do not let the unit make contact with a live line with voltage higher than 20 kV.
- Three phase feeder cables with conductors close to each other may self-cancel the electric field and will not be detected by the TIC 300 PRO tracer. Verify that the phase conductors are separated by at least 15 in (38.1 cm) before testing for AC voltage.

UNPACKING AND INSPECTION

Your shipping carton should include:

- 1 TIC 300 PRO
- 1 9 V Alkaline Battery
- 1 User Manual
- 1 Carrying Case

If any of the items are damaged or missing, return the complete package to the place of purchase for an exchange.

INTRODUCTION

The TIC 300 PRO safely checks for the presence of AC voltage without making any disconnection in cables, wall sockets, fuses, circuit breakers, junction boxes, etc. No current flow is needed for correct operation.

Rugged and reliable for utility, industrial and mine safety applications, the TIC 300 PRO warns against dangerous voltages in low and medium voltage applications up to 122 KV without contacting the energized conductor.

Features

- Utility tool for checking transmission lines, power distribution equipment, down power lines, fuses, and load break connectors
- Lower voltage setting for checking voltage presence in breaker panels, breakers, power outlets and wiring
- Verifies presence of voltage from 30 VAC to 122,000 VAC (122 kV)
- Non-contact AC voltage detection
- Visual and audible voltage indication
- Self-test for verifying that the tester is working properly
- Ergonomic design with a convenient handle
- Drop proof up to 6 ft (1.83 m)

Use with the Hot Stick 410A when voltage exceeds 1500 V

OPERATION

ON/OFF Button

When the TIC 300 PRO is activated, the blue LEDs and beeper will pulse at a slow rate about twice a second. The red LED of the range (HIGH) will turn ON.

TEST Button

The TEST button should be used prior to testing actual power circuits. The TEST function will cause the blue LEDs and beeper of the range selected (LOW or HIGH) to pulse at a fast rate.

OSHA listed clearance distances for working with voltage. National or local requirements may be different.

Line voltage (kV)	Phase to ground		Phase to phase	
	(ft-in)	(m)	(ft-in)	(m)
0.03 to 1.0	Note1	Note1	Note1	Note1
1.1 to 15.0	2-1	0.64	2-2	0.66
15.1 to 36.0	2-4	0.72	2-7	0.77
36.1 to 46.0	2-7	0.77	2-10	0.77
46.1 to 72.5	3-0	0.90	3-6	1.05
72.6 to 121	3-2	0.95	4-3	1.29

Note1 – No contact necessary

⚠ Caution: If a three phase circuit is being checked and one phase is open, the voltage from another phase maybe detected and will give a faulty indication. Always make sure that the phase cables are separated by at least 20 in (50.8 cm).

Voltage Detection

LOW Range

1. Push the ON/OFF push button to turn the unit ON.
2. The high voltage detection circuit is activated. A beep will sound and the blue LEDs will flash twice per second.
3. Push the LOW range push button. The unit is ready for low voltage detection.
4. Place the probe tip of the TIC 300 PRO near, but not touching, a low (<1000 V) voltage line (Fig. 1).
5. If voltage is present, the blue LEDs will blink and the beeper will sound at an increased rate. Continuous visual (blue LEDs) and audible indicators will increase when the probe tip makes contact with or is very close to the voltage line.

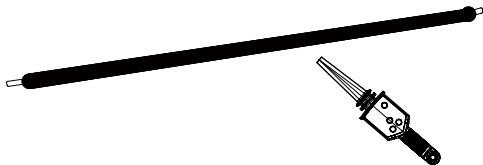

Fig. 1 Voltage detection in a line

HIGH Range (HOT STICK must be used)

(See Fig. 2)

1. Push the ON/OFF push button to turn the unit ON.
2. The high voltage detection circuit is activated. A beep will sound and the blue LEDs will flash twice per second.
3. Approach the probe tip near, but not touching, a high voltage (>1500 V and <122 kV) conductor.

4. If voltage is present, the blue LEDs will blink and the beeper will sound at an increased rate. Continuous visual (blue LEDs) and audible indicators will increase when the probe tip makes contact with or is very close to the high voltage line.

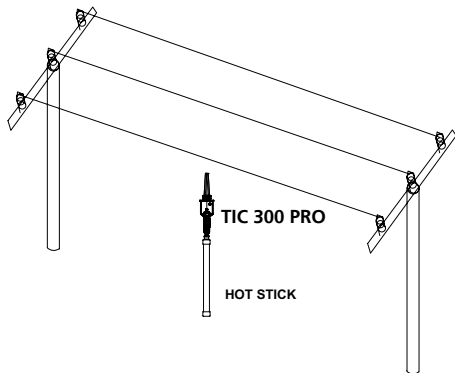

Fig. 2 Voltage detection in transmission lines

Locate breaks in insulated wire and heating elements (See Fig. 3)

1. Push the ON/OFF push button to turn the unit on.
2. Push the LOW range push button.
3. Make sure the wire or the heating element is energized.
4. Place the tip of the probe near the wire and start tracing along it. When the fast or continuous beeping stops, the point of the break or "open" is indicated.

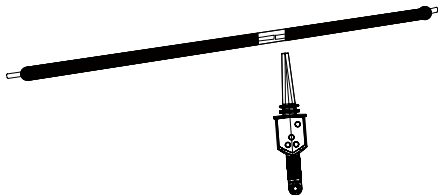

Fig. 3 Finding a break/open

Check Outlets and Switches (See Figs. 4 & 5)

1. Push the ON/OFF push button to turn the unit on.
2. Push the LOW range push button.
3. Place the probe tip of the TIC 300 PRO against the hot prong of an outlet or switch contact.
4. Increased beeping indicates higher voltage presence.

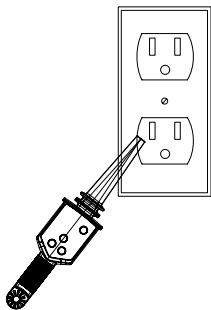

Fig. 4

Detecting voltage in an outlet (Note: disconnect all power cords from the outlet before testing)

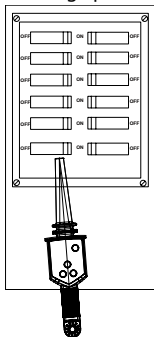

Fig. 5

Finding a breaker

MAINTENANCE AND REPAIR

If there appears to be a malfunction during the operation of the voltage detector, the following steps should be performed in order to isolate the cause of the problem:

1. Check the battery.
2. Review the operating instructions for possible mistakes in operating procedure.

Except for the replacement of the battery, repair of the voltage detector should be performed only by a Factory Authorized Service Center or by other qualified instrument service personnel.

Cleaning

The front panel and case can be cleaned with a mild solution of detergent and water. Apply sparingly with a soft cloth and allow to dry completely before using. Do not use aromatic hydrocarbons or chlorinated solvents for cleaning.

Battery Replacement

Use a Phillips blade screwdriver to remove the battery hatch screw. Lift the hatch. Remove the battery and replace it with a 9 V alkaline battery. Make sure the seal is in place. Close the battery hatch and replace the screw.

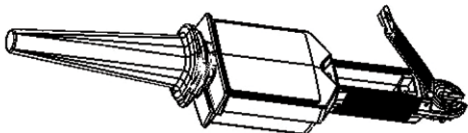

SPECIFICATIONS

Operating voltage

LOW Range: 30 to 1500 VAC; **HIGH Range:** 1500 VAC to 122 kVAC

Operating Temperature: 0°C to +52°C (32°F to +125°F);
RH < 90%

Storage Temperature: 0°C to +52°C (32°F to +125°F)
battery removed

Environment: < 2000 m (1.24 mi), outdoor operation

Power: 9 V alkaline battery

Power Consumption:

- **OFF:** 60 μ A
- **Low Detection mode:** 39 mA
- **High Detection mode:** 39 mA

Duty Cycle: Continuous

Frequency Response: 50/60 Hz

Response Time: Instantaneous

Dimensions: 345(L) x 75(W) x 47(H) mm (13.5 x 3.0 x 1.8 in)

Weight: 243 g (0.5 lb)

Optional Accessory: TIC 410A Hot Stick

Electromagnetic Compatibility (EMC): EN 61326-1

Korea (KCC): Class A Equipment (Industrial Broadcasting & Communication Equipment) ^[1]

^[1] This product meets requirements for industrial (Class A) electromagnetic wave equipment and the seller or user should take notice of it. This equipment is intended for use in business environments and is not to be used in homes.

Sensitivity: LOW Voltage

Hold the TIC 300 PRO when making the detection range measurement for LOW voltage range.

Voltage (Phase to neutral with 890K Ohm load)	Detection Range (From the TIP of probe to the target line)
	Average
30 V	3.8 cm (1.5 in)
75 V	16.5 cm (6.5 in)
100 V	21.6 cm (8.5 in)
120 V	25.4 cm (10 in)
220 V	33 cm (1 ft 1 in)
500 V	48.3 cm (1 ft 7 in)
1000 V	86.4 cm (2 ft 10 in)

Sensitivity: HIGH Voltage

The TIC 410A Hot Stick must be used when making detection range measurement for HIGH voltage range.

Voltage (Open Phase with no load)	Detection Range (From the TIP of probe to the target line)
	Average
1.5 kV	12.7 mm (0.5 in)
2.0 kV	25.4 mm (1 in)
4.0 kV	5.1 cm (2 in)
10.0 kV	20.3 cm (8 in)
15.0 kV	35.6 cm (1 ft 2 in)
20.0 kV	50.8 cm (1 ft 8 in)
25.0 kV	66 cm (2 ft 2 in)