



**TMD-53 / TMD-53W**  
**Thermocouple**  
**thermometer K/J**  
**/ Wireless**

**Users Manual**



# **TMD-53**

**Thermocouple  
thermometer K/J**

# **TMD-53W**

**Thermocouple  
thermometer K/J  
with wireless**

## **Users Manual**

June 2010, Rev.1  
©2010 Amprobe Test Tools.  
All rights reserved. Printed in Taiwan

### **Limited Warranty and Limitation of Liability**

Your Amprobe product will be free from defects in material and workmanship for 1 year from the date of purchase. This warranty does not cover fuses, disposable batteries or damage from accident, neglect, misuse, alteration, contamination, or abnormal conditions of operation or handling. Resellers are not authorized to extend any other warranty on Amprobe's behalf. To obtain service during the warranty period, return the product with proof of purchase to an authorized Amprobe Test Tools Service Center or to an Amprobe dealer or distributor. See Repair Section for details. THIS WARRANTY IS YOUR ONLY REMEDY. ALL OTHER WARRANTIES - WHETHER EXPRESS, IMPLIED OR STATUTORY - INCLUDING IMPLIED WARRANTIES OF FITNESS FOR A PARTICULAR PURPOSE OR MERCHANTABILITY, ARE HEREBY DISCLAIMED. MANUFACTURER SHALL NOT BE LIABLE FOR ANY SPECIAL, INDIRECT, INCIDENTAL OR CONSEQUENTIAL DAMAGES OR LOSSES, ARISING FROM ANY CAUSE OR THEORY. Since some states or countries do not allow the exclusion or limitation of an implied warranty or of incidental or consequential damages, this limitation of liability may not apply to you.

### **Repair**

All test tools returned for warranty or non-warranty repair or for calibration should be accompanied by the following: your name, company's name, address, telephone number, and proof of purchase. Additionally, please include a brief description of the problem or the service requested and include the test leads with the meter. Non-warranty repair or replacement charges should be remitted in the form of a check, a money order, credit card with expiration date, or a purchase order made payable to Amprobe® Test Tools.

### **In-Warranty Repairs and Replacement – All Countries**

Please read the warranty statement and check your battery before requesting repair. During the warranty period any defective test tool can be returned to your Amprobe® Test Tools distributor for an exchange for the same or like product.

### **Non-Warranty Repairs and Replacement – US and Canada**

Non-warranty repairs in the United States and Canada should be sent to a Amprobe® Test Tools Service Center. Call Amprobe® Test Tools or inquire at your point of purchase for current repair and replacement rates.

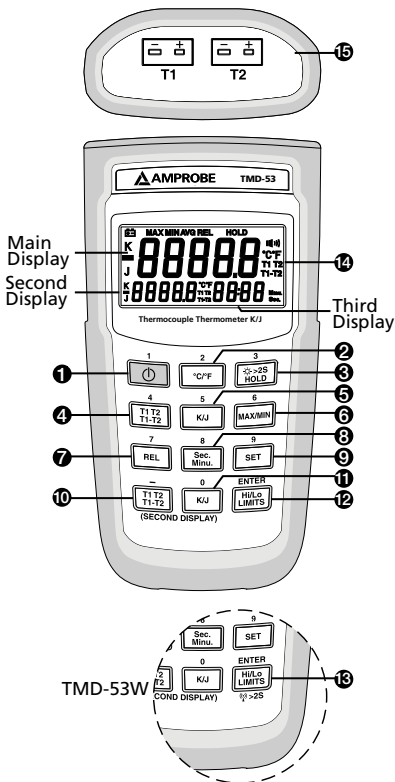

- 
- |                                    |                                     |
|------------------------------------|-------------------------------------|
| 1) "⏻" Power                       | 9) "SET"                            |
| 2) °C /°F                          | 10) "T1 T2 T1-T2"<br>Second display |
| 3) "HOLD" Data Hold ,<br>backlight | 11) "K/J" Second display            |
| 4) "T1 T2/T1-T2"<br>Main display   | 12) "Hi/Lo LIMITS"<br>Main display  |
| 5) "K/J" Main display              | 13) Wireless<br>(TMD-53W only)      |
| 6) "MAX/MIN"<br>Main display       | 14) Display                         |
| 7) "REL" Main display              | 15) T1/T2 Input                     |
| 8) "Sec. Minu."<br>Third display   |                                     |

---

## SCREEN DISPLAY

---

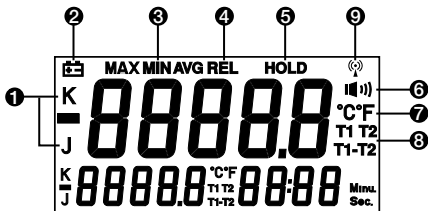





- |                                  |   |
|----------------------------------|---|
| 1) Temperature Type              | 7) Temperature measurement units            |
| 2) Low battery                   | 8) T1/T2 thermocouple or T1-T2 differential |
| 3) MAX/MIN/AVG record mode       | 9) Wireless function enabled (TMD-53W only) |
| 4) Relative mode                 |   |
| 5) HOLD enabled                  |   |
| 6) Hi/Lo Limits comparative mode |   |

---

## CONTENTS

<b>SYMBOLS</b> .....	2
<b>UNPACKING AND INSPECTION</b> .....	4
<b>INTRODUCTION</b> .....	4
Features .....	4
<b>OPERATION INSTRUCTIONS</b> .....	5
"⏻" Power Button .....	5
"°C/°F" Selecting the Temperature Scale .....	5
" <sup>*&gt;2S</sup> <sub>HOLD</sub> " Mode .....	5
"T1 T2/T1-T2" Main Display Input Selection .....	5
"K/J" Main display Input Thermocouple Type Select ....	6
"MAX/MIN" With Time Record Mode .....	6
"REL" Relative Mode .....	6
"Sec. Minu." Selecting the Time scale .....	7
"SET" Mode .....	7
"T1 T2 T1-T2" Second Display Input Selection .....	8
"K/J" Second display Input thermocouple type select ..	8
"Hi/Lo LIMITS" Mode .....	8
Wireless Mode (TMD-53W only) .....	8
<b>SPECIFICATION</b> .....	9
<b>MAINTENANCE</b> .....	11

## SYMBOLS

	Caution! Refer to the explanation in this Manual
	Complies with European Directives
	Tested Comply With FCC Standards
	Do not dispose of this clamp meter as unsorted municipal waste.

### **⚠ WARNING and PRECAUTIONS**

- *To avoid electrical shock, do not use this instrument when working voltages at the measurement surface over 24V AC or DC.*
- *To avoid damage or burns, do not make temperature measurement in microwave ovens.*
- *Repeated sharp flexing can break the thermocouple leads. To prolong lead life, avoid sharp bends in the leads, especially near the connector.*

### **Federal Communications Commission**

This device TMD-53W complies with Part 15 of the FCC Rules. Operation is subject to the following two conditions: (1) this device may not cause harmful interference, and (2) this device must accept any interference received, including interference that may cause undesired operation.

### **Note**

This equipment TMD-53W has been tested and found to comply with the limits for a Class B digital device, pursuant to Part 15 of the FCC Rules. These limits are designed to provide reasonable protection. This equipment generates, uses and can radiated radio frequency energy and, if not installed and used in accordance with the instructions, may cause harmful interference to radio communications. However, there



is no guarantee that interference will not occur in a particular installation if this equipment does cause harmful interference to radio or television reception, which can be determined by turning the equipment off and on, the user is encouraged to try to correct the interference by one or more of the following measures:

- Reorient or relocate the receiving antenna.
- Increase the separation between the equipment and receiver.
- Connect the equipment into an outlet on a circuit different from that to which the receiver is connected.
- Consult the dealer or an experienced radio/TV technician for help.

Shielded interface cables must be used in order to comply with emission limits.

Changes or modifications not expressly approved by the party responsible for compliance could void the user's authority to operate the equipment.

### **Wireless Note**

Wireless receiver must keep a distance at least 40cm from the meter and meter to meter distance must be at least 30cm.

## UNPACKING AND INSPECTION

---

Your shipping carton should include:

- 1 Meter
- 4 AAA batteries
- 1 Software CD ROM (THWD-10W)
- 1 USB Wireless Antenna (THWD-10W)
- 2 K type thermocouple
- 1 Manual
- 1 Plain white box

If any of the items are damaged or missing, return the complete package to the place of purchase for an exchange.

## INTRODUCTION

---

This instrument is a 5 digit, compact-sized portable digital thermometer designed to use external K-type and J-type thermocouples as temperature sensor. Temperature indication follows Reference Temperature/Voltage Tables (N.I.S.T. Monograph 175 Revised to ITS-90) for K-type and J-type thermocouples. Two K-type thermocouple are supplied with the thermometer.

### Features

- Wireless two ways transmission. (TMD-53W only)
- K/J-type thermocouple selection dual input.
- °C/°F user-selective.
- MAX/MIN with elapsed time, AVG, REL, HOLD function.
- TIME setting, REL setting.
- Warning beeper with Hi/Lo setting.
- Resolution 0.1°C to 0.2°F.

## OPERATING INSTRUCTIONS

---

### "" Power Button

The "" key turns the thermometer on or off. In the SET mode cannot be powered off. Exit SET mode to power off.

### APO function mode



Press "" power key for more than 4 seconds to disable the auto-power function.

The display will show "APO OFF".

### "°C/°F" Selecting the Temperature Scale

Readings are displayed in either degrees Celsius(°C) or degrees Fahrenheit(°F). When the thermometer is turned on, it is set to the temperature scale that was in use when the thermometer was last turned off. To change the temperature scale, press the "°C/°F" key.

### " >2S HOLD" Mode (only Main display)

Press this key to enter the Data Hold mode, the "HOLD" annunciator is displayed. When HOLD mode is selected, the thermometer holds the present readings and stops all further measurements. Press the " >2S  
HOLD" key again to cancel HOLD mode and resume measurements. In the MAX/MIN recording mode, press " >2S  
HOLD" key to stop the recording. Press " >2S  
HOLD" key again to resume recording. (Previously recorded readings are not erased).

### Backlight function mode

Press the " >2S  
HOLD" key for more than two seconds to turn on the backlight. Press the key again for more than two seconds to turn off the backlight. The backlight will switch-off automatically after 30 seconds.

### "T1 T2/T1-T2" Main Display Input Selection

The input selection indicates which input is selected for main display; T1 thermocouple, T2 thermocouple or

the difference between the two thermocouples (T1-T2), when the thermometer is turned on, it is set to T1.

### **"K/J" Main display Input Thermocouple Type Select**

The "K/J" key selects the T1 thermocouple type, when the main display is showing T1. When the thermometer is turned on, it is set to the type selected when the thermometer was last turned off.

### **"MAX/MIN" With Time Record Mode (only Main display)**

Press "MAX/MIN" key to enter the MAX MIN Recording mode, (displays the Maximum reading with time, Minimum reading with time and Average reading stored in record mode). In this mode the automatic power-off feature is disabled and "⏻" key, "°C/°F" key, "REL" key, "SET" key, "Hi/Lo LIMITS" key and main display "T1 T2 T1-T2" key, "K/J" key are disabled. The beeper emits a tone when a new minimum or maximum value is recorded.

Press "MAX/MIN" key to cycle through the MAX, MIN and AVG readings. If an overload is recorded, the averaging function is stopped. In this mode, press the "HOLD" key to stop the recording of readings, all values are held, press again to restart recording.

To prevent accidental loss of MAX, MIN and AVG data, this mode can only be cancelled by pressing and holding the "MAX/MIN" key for 2 seconds. All recorded readings are erased.

### **"REL" Relative Mode (only Main display)**

Press the "REL" key to enter the relative mode, zero the display, and store the displayed Reading as a reference value. REL is shown on the display. Press "REL" key again to exit the relative mode. The relative reference

value can also be entered by the user. (See **"SET mode"** later in this manual). When the desired relative value has been entered, press **"REL"** key to enter the relative mode and then press **"SET"** key use the entered relative value as a reference value. Press **"REL"** key again to exit the relative mode. In the relative mode, the value (can not  $>\pm 3000.0$  counts) shown on the LCD is always the difference between the stored reference and the present reading.

### **"Sec. Minu." Selecting the Time scale**

Press this key to display the elapsed time on the third display in either hours and minutes or minutes and seconds. When the thermometer is turned on, it is set to seconds. To change the time scale, press **"Sec. Minus."** key. Maximum elapsed time reading is 100 hours. If 100 hours is exceeded, the elapsed time resets to zero.

### **"SET" Mode (Relative value set, Time set and Hi/Lo Limits value set)**

1. Press the **"SET"** key to enter relative values SET mode (Press **"ENTER"** key to skip setting relative value). **"= = = =."** is displayed on the main display. The relative value is entered via overlay numbers, press overlay **"ENTER"** key to store the relative value, and advance to elapsed time set mode.
2. Elapsed time set mode, (Press **"ENTER"** key to skip Elapsed time set mode) **"=. = = : = ="** is displayed in second and third display. Time (hours, minutes, seconds) value is entered via overlay numbers, press overlay **"ENTER"** key to store time value. Elapsed time starts from set time value.
3. Hi Limit value set mode, **"| | | |)"** is displayed (Press **"ENTER"** key to skip Hi Limit value set mode), **"= = = =."** is displayed in main display, Hi Limit value is entered via overlay numbers, then press

**"ENTER"** key to store the Hi Limit value.  
"**= = = =.**" is displayed in main display, Lo Limit value is entered via overlay numbers, then press overlay **"ENTER"** key to store the Lo Limit value and exit SET mode.

4. When the thermometer is turned on it uses the relative value and Hi/Lo Limits values that were entered when thermometer was last in use.

### **"T1 T2 T1-T2" Second Display Input Selection**

The input selection indicates which input is selected for second display; T1 thermocouple, T2 thermocouple or the difference between the two thermocouples (T1-T2). When the thermometer is turned on, it is set to T2 input. To select a different type of thermocouple use the **"K/J"** key.

### **"K/J" Second display Input thermocouple type select**

The **"K/J"** key for T2 input selects K-type or J-type thermocouple as input, when the second display has T2 shown. When the thermometer is turned on, it is set to the type selected when the thermometer was last turned off.

### **"Hi/Lo LIMITS" Mode (only Main display)**

Press **"Hi/Lo LIMITS"** key to enter the Hi/Lo Limits comparative mode, "**||||**")" is displayed. When the input temperature value exceeds the Hi or Lo Limits value, the beeper emits a continuous or pulsed tone. Press **"Hi/Lo LIMITS"** key again to exit the Hi/Lo Limits mode.

### **Wireless Mode (TMD-53W)**

Press the "**(☺)**" key for more than two seconds to start wireless function. Press the "**(☺)**" key again for another two seconds to stop wireless function. The wireless mode will shut down if there is no wireless signal for two minutes.

To SET CH/ID to 00,00, press the “Hi/Lo LIMITS” key and “” power key for more than 6 seconds with the meter powered down. The meter will set channel and ID to 00,00 status. The second display will show 00, which means that the channel and ID has been set to 00.

To check the channel and ID of the meter

When the meter is off, press “°C/°F” key and “” for 5 seconds, LCD’s main display will show channel number, the second display will show ID number.

## SPECIFICATION

### Electrical

<b>Temperature Scale</b>	Celsius or Fahrenheit user-selectable
<b>Measurement Range</b>	J-Type -200°C to 1050°C, (-328°F to 1922°F) K-Type -200°C to 1370°C, (-328°F to 2498°F)
<b>Resolution</b>	0.1°C or 0.2°F
<b>Accuracy</b>	Accuracy is specified for operating temperatures over the range of 18°C to 28°C (64°F to 82°F), for 1 year, not including thermocouple error. ±(0.05%rdg+0.3°C) on -50°C to 1370°C ±(0.05%rdg+0.7°C) on -50°C to -200°C ±(0.05%rdg+0.6°F) on -58°F to 2498°F ±(0.05%rdg+1.4°F) on -58°F to -328°F
<b>Temperature Coefficient</b>	0.1 times the applicable accuracy specification per °C from 0°C to 18°C and 28°C to 50°C (32°F to 64°F and 82°F to 122°F).

<b>Input Protection</b>	24V dc or 24V ac rms maximum input Voltage on any combination of input pins.
<b>Input Connector</b>	Accepts standard miniature thermocouple connectors (flat blades spaced 7.9mm, center to center).
<b>Maximum Differential Common Mode Voltage (Maximum Voltage between T1 and T2 during measurement): 1 Volt.</b>	

## Environmental

<b>Ambient Operating Ranges</b>	0°C to 50°C (32°F to 122°F) <80% R.H.
<b>Storage Temperature</b>	-20°C to 60°C (-4°F to 140°F) <70% R.H.

## General

<b>Display</b>	5 digit liquid crystal display (LCD).
<b>Overload</b>	"----.-" or "OL" is display..
<b>Reading Rate</b>	1 time per second.
<b>Auto power off</b>	30 minutes, press power key to resume operation.
<b>Battery</b>	4 X 1.5V AAA
<b>Battery Life</b>	190 hours typical with carbon zinc battery.
<b>Dimensions</b>	160mm(H) x 83mm(W) x 38mm(D); 6.3 in (H) x 3.3 in (W) x 1.5 in (D).
<b>Weight</b>	Approx. 270g (0.6lb) including batteries.



<b>Supplied Wire</b>	4 feet type "K" thermocouple bead wire (Teflon tape insulated). Maximum insulation temperature 260°C (500°F). Wire accuracy $\pm 2.2^{\circ}\text{C}$ or $\pm 0.75\%$ of reading (whichever is greater) from 0°C to 800°C (32°F to 1472°F).
----------------------	---

### **Wireless Features**

Frequency range 910~920MHz (TMD-53W)

Low current consumption less than 1mA.

The transmitting distance can reach 25M without magnetic interference.

### - **EMC**: Conforms to EN61326-1.

This product complies with requirements of the following European Community Directives: 89/ 336/ EEC (Electromagnetic Compatibility) and 73/ 23/ EEC (Low Voltage) as amended by 93/ 68/ EEC (CE Marking). However, electrical noise or intense electromagnetic fields in the vicinity of the equipment may disturb the measurement circuit. Measuring instruments will also respond to unwanted signals that may be present within the measurement circuit. Users should exercise care and take appropriate precautions to avoid misleading results when making measurements in the presence of electronic interference.

## **MAINTENANCE AND REPAIR**

---

### **WARNING**

*To avoid possible electrical shock, disconnect the thermocouple connectors from the thermometer before removing the cover.*

## Installing and Replacing Battery

- A. Screw
- B. Battery Cover
- C. Battery

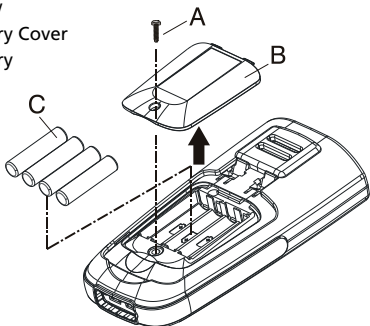

1. Power is supplied by 4pcs 1.5V (SIZE AAA) UM-4 R03.
2. The "⊕ ⊖" appears on the LCD display when replacement is needed. To replace battery remove screw from back of meter and lift off the battery cover.
3. Remove the batteries from the battery compartment and replace them with new ones.
4. When not use for long time, remove the battery.
5. Do not store the unit in place with temperature and humidity beyond the recommended storage temperature.

## Cleaning

Periodically wipe the case with a damp cloth and detergent, do not use abrasives or solvents.